

knitking

magazine

MARCH/APRIL '76





DK 270



DK 281

A man with dark hair is smiling and looking to his right. He is wearing a light-colored, zip-up sweater with vertical stripes in a darker shade. Underneath, a dark patterned scarf is visible. The sweater has a ribbed collar and cuffs. The entire image is framed by a decorative border with a repeating floral pattern in yellow and white. The background is a solid dark brown color.

HP 284

DK 267

DK 268



DK 271





DK279

RS296



DK 276

DK 275



DK 273

A woman with dark, wavy hair is seated in a bright yellow chair. She is wearing a light-colored, long-sleeved sweater with a ribbed texture and a cardigan with a colorful geometric pattern in red, green, and white. She is holding a lit cigarette in her right hand. The background is a dark, solid color. The entire image is framed by a decorative border with a repeating floral pattern in yellow and white.

DK 278

DK 280

MARCH/APRIL, 1976 VOL. 12, NO.3

knitking

magazine

editorial

TABLE OF CONTENTS

PAGE NO.

DK 267	Woman's Jacket	14
DK 268	Woman's Hat & Bag	15
DK 269	Woman's Coat	15
DK 270	Woman's Jacket	17
DK 271	Woman's Jacket	18
DK 272	Woman's Skirt	19
DK 273	Woman's Pants	20
DK 274	Woman's Skirt	20
DK 275	Woman's Blouse	21
DK 276	Woman's Dress	22
DK 277	Woman's Pullover	23
DK 278	Woman's Jacket	24
DK 279	Woman's Wrap around Blouse	25
DK 280	Woman's Skirt	26
DK 281	Woman's Two-piece Dress	26
DK 282	Woman's Jacket	28
DK 283	Woman's Skirt	29
HP 284	Man's Jacket	29
HP 285	Man's Pullover	30
HP 286	Man's Pullover	32
KK 287	Girl's Dress	32
KK 288	Child'd Pullover	34
KK 289	Child's Jacket & Pants	35
KK 290	Baby Coveralls	36
KK 291	Baby Pullover	37
KK 292	Child's Pullover	37
KK 293	Child's Cardigan	38
KK 294	Girl's Coat	39
KK 295	Girl's Cap & Muff	40
RS 296	Hassock.	44

The verdict is in!! Our JANUARY/FEBRUARY KNITKING MAGAZINE was the most popular ever.... There have been more garments made from it than from any issue since the introduction of KNITKING MAGAZINE almost 12 years ago... In those days, all illustrations were in black and white and readers chose their own colors for the garments... Now that we publish in FULL COLOR, the majority of readers order the colors of yarn used in the original garments... consequently, we rapidly sell out of those colors.

You could ask the question, "Why don't you stock up on the colors used for the garments?" and we would answer "We do", but we would have needed a warehouse full of the red and white used for DK 256 in the last issue and we would have needed another warehouse full of the colors used for DK 236 and DK 254... We discount all KNITKING YARNS especially for KNITKING MAGAZINE subscribers and it is difficult to forecast six months ahead (that is how long it sometimes takes to have yarn made abroad and delivered to California) what garments will prove most popular... The reduced prices apply only to each individual magazine and we can only continue them until you receive another issue. For example, the special prices in the JANUARY/FEBRUARY edition are cancelled with this issue. Some of the yarns are no longer available and are being replaced with yarns from the new Catalogue range. In the yarn business, it seems that there is a continual turnover of fashionable colors and types of yarn and frequently... We are at the mercy of our suppliers.

We tell you all of the foregoing to encourage you to list alternate colors in your orders. The listing of alternate colors will insure that you receive yarn to make the garments of your choice and that we do not have to write and say 'sorry, we are out of the color you ordered, will you accept an alternate?'

We must say that it gives us great pleasure to see our designs worn by visitors to our LOS ANGELES CENTER... We also receive many snapshots from readers wearing garments made from our instructions... We know the pride and happiness that comes with wearing a good looking garment made with ones own hands and we are proud to play a part in the achievement of such happiness and satisfaction.





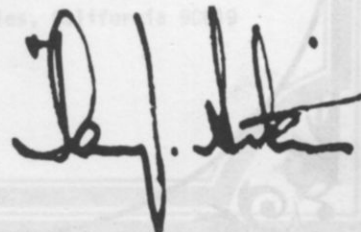









The MAY/JUNE edition of KNITKING MAGAZINE is already being worked on and we know you will love the splendid assortment of garments we have made up for our readers.



Publisher: KNITKING CORPORATION, 1128 Crenshaw Blvd., Los Angeles, Calif. 90019. Telephone: (213) 938-2079. Published bi-monthly. Subscriptions: USA — \$10.00 annually, single copies \$3.00; Canada — \$12.00; other parts of the world — \$15.00. The entire contents of KNITKING MAGAZINE are copyright and must not be reproduced in any shape or form without the express permission, in writing of the publisher. © COPYRIGHT 1976 by KNITKING CORPORATION.





Pattern Symbols

Knitting — Chart Symbols

- () Size Symbols
(2nd Size)
- < > 3rd Size
- B** Beginners Pattern
- T** Tension
- G** Gauge
- 1** Color Number
-  Cast on
- n** Stitch
- R** Row
- H** Hem
-  Bind off
-  Stockinette stitch — worn on the Knit side.
-  Stockinette stitch — worn on the Purl side.
-  Knit 1, Purl 1 Ribbing
-  Ribbing Pattern — worn on the Knit side.
-  Ribbing Pattern — worn on the Purl side.
-  Closed Dart
-  Open Dart
-  Put on a stitch holder
-  Reverse 1 section
-  On every other needle
-  Number of Rows between Shapings. Make increase (or decrease) FIRST, then knit 4 rows. For example: 3 x 1  means decrease (or increase) 1 st., knit 4 rows; decrease 1 st., knit 4 rows; decrease 1 st., knit 4 rows; decrease 1 st., knit 4 rows. All decreasing (or increasing) without row numbers as shown must be shaped on every 2nd row.

-  Increase
-  Increase 2 sts. With a transfer tool, move the sts. over the left (or right) leaving 2 empty needles at the point of increase. At the increase point, move 1 st. to the left, (or right) so that there is an empty needles on each side of a stitch. On each side of the center stitch, pick up a stitch from the row below and hang it onto the empty needle.

-  3 stitches on 1 needle. The 1st and 3rd stitch in a group of 3 has been hung on the 2nd or center needle.

-  Short Row increase or decrease; for instance on a flared skirt knitted sideways.

-  Pattern Stitch

-  Pattern Stitch — worn on the Knit side.

-  Pattern Stitch — worn on the Purl side.





-  Norwegian Design using the Pattern Reader. Only 1 row must be registered on the Pattern Reader, so when knitting two or more colors in 1 row, knit the first color with the LEVER of Pattern Reader UP (working), then push the LEVER DOWN (non-working) for the additional colors.

REPEAT the above for each complete row.

















-  Repeat

- I = Front
II = Back
III = Sleeve
IV = Skirt Front
V = Skirt Back
VI = Collar
VII = Pocket
VIII = Band
IX = Belt
X = Cuff
XI = Pants Front
XII = Pants Back

Finishing — Chart Symbols

-  Match numbers on section for assembling.
-  Ease
-  Fold Line
-  Turn to the wrong side and hem.

Stitch Symbols

-  Knit Stitch
-  Purl Stitch
-  Needles in holding position
-  Needles back into working position.
-  Empty needle (leave in working position)
-  Needle not used (in the out of work position).
-  Two stitches on 1 needle, either transferred from the right side or the left side, then put into holding position.
-  Needle holding 2 stitches. Stitch has been transferred from the RIGHT.
-  Needle holding 2 stitches. Stitch has been transferred from the LEFT.
-  Center of garment section
-  Pattern Reader
-  JAC 40
-  Adjustable Needle Selector
-  Pattern Wheel
-  Weaver
-  Needle Shifter



knitking accessory price list

	PRICE	SHIPPING		PRICE	SHIPPING
WHIZ KING PATTERN READER - complete with Converta Tape & 2 sheets of graph transparent plastic	\$79.50	\$2.75	Reversing Bar (197 Needle KNITKING Machine only)	39.95	2.00
3-Color Yarn Feeder	29.50	1.65	Converta Tape (for charting Patterns to size)	10.95	.65
Pattern Stitch Cards for AM 3 KNITKING Machine only #17 to #48	10.50	1.40	Fluorescent Magnifying Lamp with 5 inch lens and adjustable 45 inch extension arm (specify table clamp or wall fitting)	69.50	3.50
Weaving Accessory for AM 3 KNITKING only	8.95	.85	Lumaglo Lamp	24.95	1.75
Adjustable Needle Selector (33 needle)	4.95	.60	JAC 40 (KNITKING Machine only) . . .	37.50	1.75
Cam Wheels for AM 3 KNITKING Machine only each	1.75	.15	JAC 40 Punch Cards. Please give alternate numbers each	1.50	.15
Knitting Table (suitable for all machines)	39.50	F.O.B.	JAC 40 Punching Accessory with 5 blank cards	24.95	1.25
Treble Transfer Tool (pair)	3.50	.55	Blank Cards each	1.00	.15
Multiple Transfer Tool (33 needle) . .	4.50	.65	Strap for JAC 40	2.00	.30
Double Transfer Tool (pair)	2.50	.55	KNITKING Instruction Book (specify machine)	4.00	.55
Transfer Tools (1 each - 4 needle and 6 needle)	3.25	.55	KNITKING AM 3 Book - complete with Home Study Course	12.95	.65
Combined Latch Needle & Transfer Tool	1.50	.30	Inches/Centimeters Tape Measure49	.20
Combined Work Hook & Transfer Tool	1.50	.30	1 Year Subscription to KNITKING MAGAZINE (6 issues)	10.00	(no tax)
Knitting Machine Needles for KNITKING Machines only55	.15	Canada	12.00	
Ribbing Attachment Needles for KNITKING Ribbers only65	.15	Back Issues of KNITKING MAGAZINE Single Copy (thru Vol.10) . . . each	1.50	Postpaid
Ribber Transfer Needles45	.15	From Vol 11 No. 1 each	3.00	Postpaid
Strippers for KNITKING Ribber (pair) .	.95	.25	KNITKING MAGAZINE Plastic bound Volumes (6 issues) Bound Volumes 9 or 10 each	7.95	1.25
KNITKING Sinker & Spring (specify Machine No.)25	.15	Bound Volume 11 each	11.95	1.50
Shipping for 2050	Canada & Mexico	3.00	
Yarn Winder with 'Waxamajig' and Skein Holder	27.50	2.00	All other countries	3.65	
Wax Spools each	.30	.25	Carrying Bags		
or 4 for	1.00	.50	AM 3 Knitter	45.95	2.00
			P 3 Ribber	24.00	1.25

Sorry, no C.O.D.'s or Billings. Please send money with your order. California Residents, add Sales Tax. Effective January 1, 1976
Price Lists prior to this date are obsolete.

KNITKING, INC.
1128 Crenshaw Blvd., Los Angeles, California 90019



DK 267



WOMAN'S JACKET

SIZE: 8/10 (12/14) [16/18]
 YARN: Alanda Tweed
 GRAMS: 700 750 800
 TENSION: 9 or 10
 GAUGE: 11 sts. 18 rows = 5 cm (2")

Stockinette stitch with Fisherman's Rib for the Collar, Cuffs and Pockets.

FINISHING: See General Instructions.

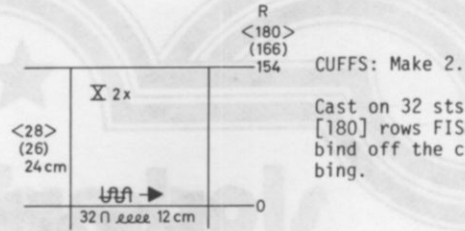

Cast on 32 sts. and work 154 (166) [180] rows FISHERMAN'S RIB, then bind off the crochet method for Ribbing.

BACK: II

Cast on 101 (109) [119] sts. and work Stockinette stitch. Knit to Row 166.
 SHAPE ARMHOLE: ON EACH SIDE, bind off 3 sts. 1x, 2 sts. 2x, 1 st. 4x. (3 sts. 1x, 2 sts. 3x, 1 st. 4x). [3 sts. 1x, 2 sts. 3x, 1 st. 7x]. Knit to Row 234 (238) [242]. Bind off the center 19 sts., put the needles on the left into holding position and complete the right half first.
 *SHAPE SHOULDER AND NECK AT THE SAME TIME:
 FOR SHOULDER, bind off 4 sts. 5x. (5 sts. 2x, 4 sts. 1x). [5 sts. 4x, 4 sts. 1x].
 FOR NECK, on all sizes, bind off 5 sts. 2x.
 Move the Cam Box to the left side, turn the Row Counter back to 234 (238) [242] and complete the left half. Follow the instructions from *.

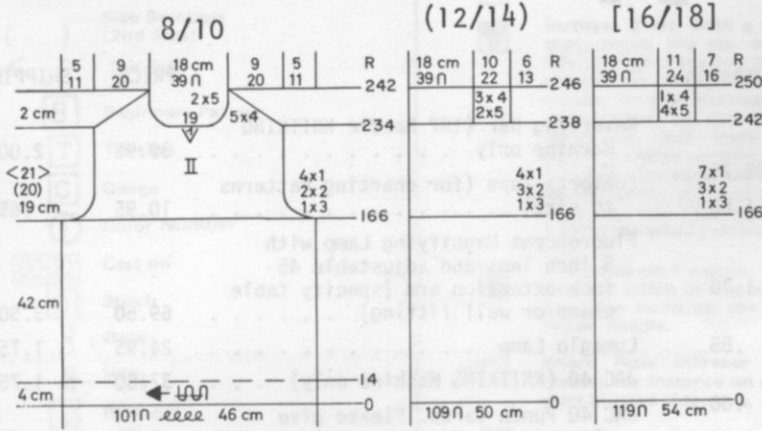

FRONT: I Make 1, reverse 1.

DO NOT MAKE BUTTONHOLES IN THIS SECTION.
 Cast on 50 (54) [59] sts. and work Stockinette stitch. Knit to Row 14, then with a separate yarn, cast on 18 sts. on the LEFT (right for 2nd section) side. Knit to Row 130.
 Begin the NECK SHAPING and SHAPE ARMHOLE same as the back after Row 166. ON NECK SIDE, decrease 1 st. every 2nd row 19x (17x) [15x], every 4th row 18x (20x) [22x] and AT THE SAME TIME, after Row 234 (238) [242], SHAPE SHOULDER same as the back.
 Work the 2nd section with reverse shaping, casting on from RIGHT to LEFT. Cam Box will be on the LEFT side at Row 0 and make BUTTONHOLES over needles 3 to 7 and 12 to 16 counting from the RIGHT edge after Rows 24, 56, 88, 120.

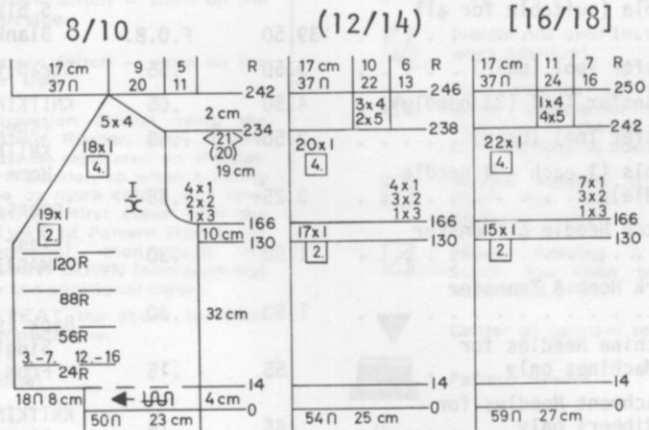

COLLAR: VI Make 1, reverse 1.

Cast on 114 (117) [119] sts. and work FISHERMAN'S RIB. After Row 4, on the RIGHT (left for 2nd section), bind off 2 sts. every 4th row 19x, every 2nd row 19x. After Row 116, bind off the remaining sts. the crochet method for Ribbing.

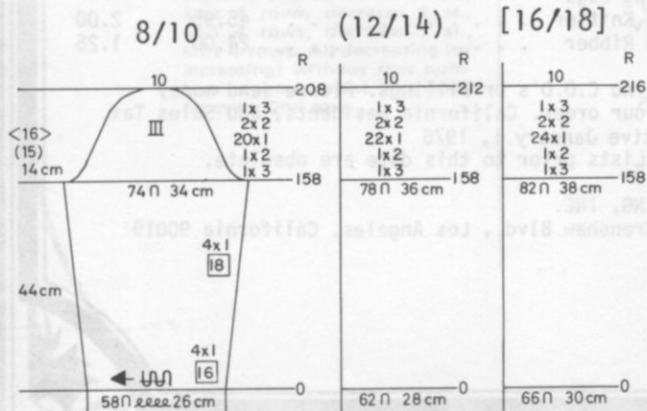

SLEEVE: III

Cast on 58 (62) [66] sts. and work Stockinette stitch.
 ON EACH SIDE, increase 1 st. every 16th row 4x, every 18th row 4x. Knit to Row 158.
 SHAPE CAP: ON EACH SIDE, bind off 3 sts. 1x, 2 sts. 1x, 1 st. 20x (22x) [24x], 2 sts. 2x, 3 sts. 1x. After Row 208 (212) [216], bind off the remaining 10 sts.

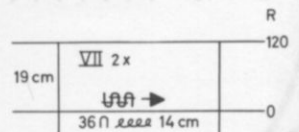

POCKET: VII Make 2.

Cast on 36 sts. and work 120 rows FISHERMAN'S RIB. Bind off the crochet method for Ribbing.

DK 268

WOMAN'S HAT & BAG

SIZE: Hat: to fit a 22" to 26" head measurement.
 YARN: Alanda Tweed
 GRAMS: 450
 TENSION: 9 or 10
 GAUGE: 15 sts. 30 rows = 5 cm (2")

Hat: Stockinette stitch with band in Fisherman's Rib. Bag: A Holding Position Design on the Purl side. Follow the Line Drawing. KNITKING machine owners, use Wheel No. W4 and push in the right Retractor Button and leave it there.

FINISHING: Hat: Sew sections of crown together then sew on band. Bag: Cut lining for bag before sewing. Sew bag and lining separately then sew the lining to bag. Attach to handle.

HAT BAND:

Cast on 145 sts. and work 78 rows FISHERMAN'S RIB on the KNIT side (KNITKING machine owners, put the Gate Cam Release Lever of the Ribber to the needle heels. Bind off the crochet method for Ribbing.

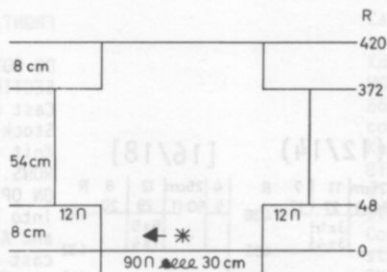
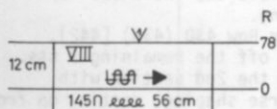

BAG:

Cast on 90 sts. and work in Holding Position Design. Knit to Row 48 then ON EACH SIDE, cast on 12 sts. (use a separate yarn for left side) Knit to Row 372. ON EACH SIDE, bind off 12 sts. Knit to Row 420. Bind off.

HAT CROWN: Make 4.

Cast on 31 sts. and work Stockinette stitch. Knit to Row 16. ON EACH SIDE, decrease 1 st. every 10th row 9x, every 8th row 5x. After Row 144, bind off the remaining 3 sts.

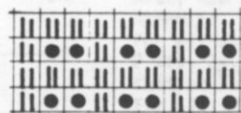
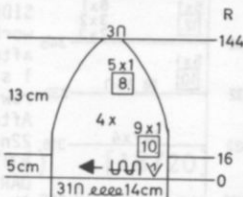

4
3
2
1

DK 269

WOMAN'S COAT

SIZES: 8/10 (12/14) [16/18]
 YARN: Alanda Tweed
 GRAMS: 2250 2300 2350
 TENSION: 8 to 10
 GAUGE: 12 sts. 18 rows = 5 cm (2")

Stockinette stitch worn on the Purl side.

FINISHING: See General Instructions. For the Hood, with knit side together, fold in half, pin, then sew 1 edge to the inside and 1 to the outside of neckline (see picture).

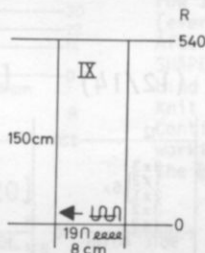

BELT: IX

Cast on 19 sts. and work Stockinette stitch to Row 540, then bind off.

BACK: II

Cast on 168 (178) [188] sts. and work Stockinette stitch. Knit to Row 14, then work SHORT ROWS.

ON OPPOSITE SIDE OF CAM BOX, put into holding position 40 sts. before knitting the next 2 rows. ON OPPOSITE SIDE OF CAM BOX, bring back into working position, 10 sts. 4x ON EACH SIDE, and AFTER ROW 22, ON EACH SIDE, decrease 1 st. every 10th row 14x, every 8th row 13x. After Row 266, ON EACH SIDE, increase 1 st. every 22nd row 3x. Knit to Row 332.

SHAPE ARMHOLE: ON EACH SIDE, bind off

3 sts. 1x, 2 sts. 3x, 1 st. 6x. (3 sts. 2x, 2 sts. 3x, 1 st. 5x). [3 sts. 2x, 2 sts. 3x, 1 st. 8x]. Knit to Row 412 (416) [418].

Bind off the center 22 sts., put the needles on the left into holding position and complete the right half first.

*SHAPE SHOULDER AND NECK AT THE SAME TIME.

FOR SHOULDER, bind off

4 sts. 6x. (4 sts. 3x, 5 sts. 3x). [4 sts. 1x, 5 sts. 5x].

FOR NECK, on all sizes, bind off 5 sts. 2x.

Move the Cam Box to the left side, turn the Row Counter back to 412 (416) [418] and complete the left half. Follow the instructions from *.

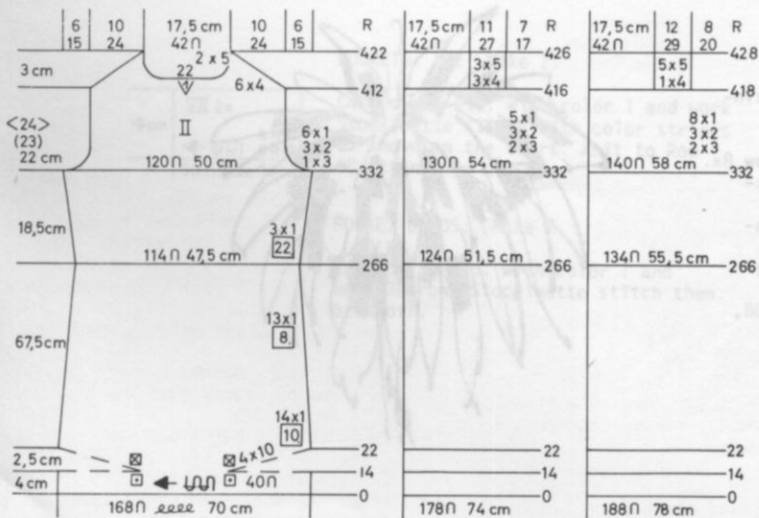

Continued



DK 269

FRONT: I Make 1, reverse 1.

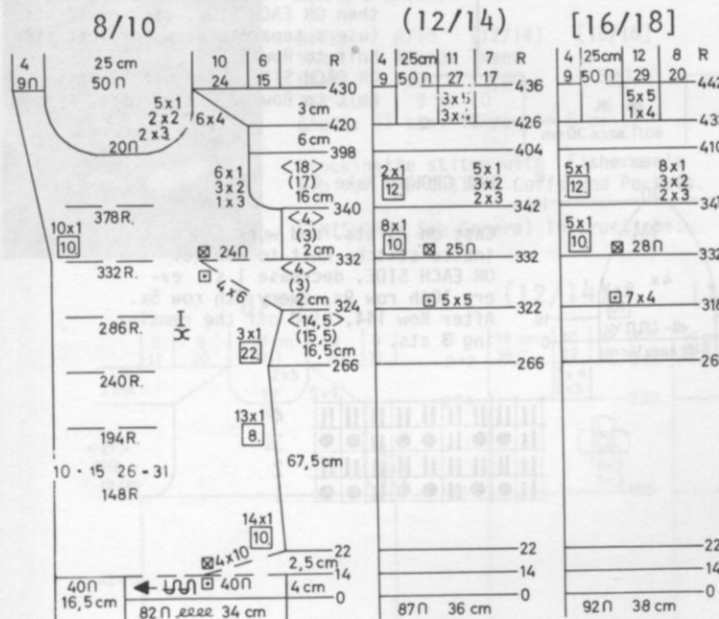

DO NOT MAKE BUTTONHOLES IN THIS SECTION.

Cast on 82 (87) [92] sts. and work Stockinette stitch.

Knit to Row 13, then WORK SHORT ROWS.

ON OPPOSITE SIDE OF CAM BOX, put into holding position 40 sts. 1x and AT THE SAME TIME, after Row 14, cast on 40 sts. on the LEFT (right for 2nd section) side. ON OPPOSITE SIDE OF CAM BOX, bring back into working position, 10 sts. 4x, and after Row 22, ON SIDE EDGE, decrease 1 st. every 10th row 14x, every 8th row 13x.

After Row 266, increase 1 st. every 22nd row 3x, and after Row 323 (321) [317], work SHORT ROWS for the BUST DART.

ON OPPOSITE SIDE OF CAM BOX, put into holding position 6 sts. 4x (5 sts. 5x) [4 sts. 7x].

Bring all the needles back into working position before knitting the next row.

After Row 332, ON OPPOSITE SIDE OF CAM BOX INCREASE for FACING AND AT THE SAME TIME SHAPE

ARMHOLE same as the back after Row 340 (342) [346].

FOR FACING, increase 1 st. every 10th row 10x (8x) [5x], every 12th row 0x (2x) [5x]

AND AT THE SAME TIME after Row 398 (404) [410], SHAPE NECK. Leave 39 (42) [44] needles on the RIGHT (left for 2nd section) in working position and put the remainder on the left (right) into holding position.

*ON NECK SIDE, on every 2nd row, bind off for all sizes, 3 sts. 2x, 2 sts. 2x, 1 st. 5x, * AND SHAPE SHOULDER same as the Back after Row 420 (426) [432].

Bring all the needles into working position, bind off 20 sts. for NECK, turn the Row Counter back to 398 (404) [410] and complete the left side (right for 2nd section). Follow the instructions from * to ** and don't forget to complete the increases for facing.

After Row 430 (436) [442], bind off the remaining 9 sts. Work the 2nd section with reverse shaping, casting on from RIGHT to LEFT. Cam Box will be on the LEFT side at Row 0, and MAKE BUTTONHOLES over needles 10 to 15 and 26 to 31 counting from the RIGHT edge after the rows shown on the Chart.

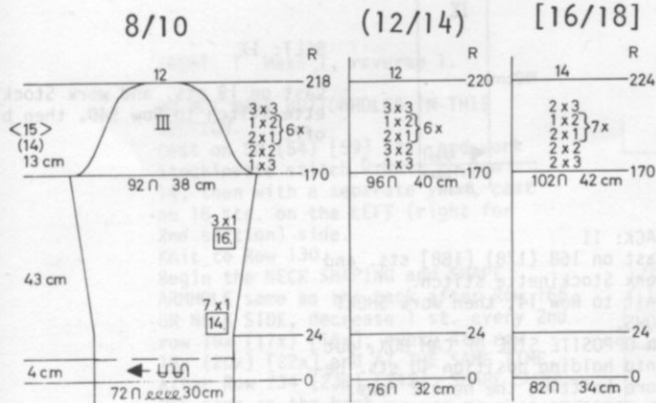

SLEEVE: III

Cast on 72 (76) [82] sts. and work Stockinette stitch. Knit to Row 24.

ON EACH SIDE, increase 1 st. every 14th row 7x, every 16th row 3x.

Knit to Row 170.

SHAPE CAP: ON EACH SIDE, bind off 3 sts. 1x, 2 sts. 2x, *1 st. 2x, 2 sts. 1x, and REPEAT from * 5x more, 3 sts. 3x.

(3 sts. 1x, 2 sts. 3x, *1 st. 2x, 2 sts. 1x, and REPEAT from * 5x more, 3 sts. 3x).

[3 sts. 3x, 2 sts. 2x, *1 st. 2x, 2 sts. 1x, and REPEAT from * 6x more, 3 sts. 2x].

After Row 218 (220) [224], bind off the remaining 12 (12) [14] sts.

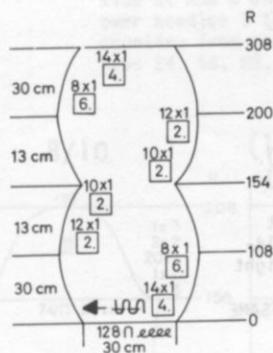

HOOD

Cast on 128 sts. and work Stockinette stitch. ON EACH SIDE, increase 1 st. every 4th row 14x, every 6th row 8x. After Row 108, ON EACH SIDE, decrease 1 st. every 2nd row 22x. After Row 154, ON EACH SIDE, increase 1 st. every 2nd row 22x. After Row 200, ON EACH SIDE, decrease 1 st. every 6th row 8x, every 4th row 14x. After Row 308, bind off the remaining sts.

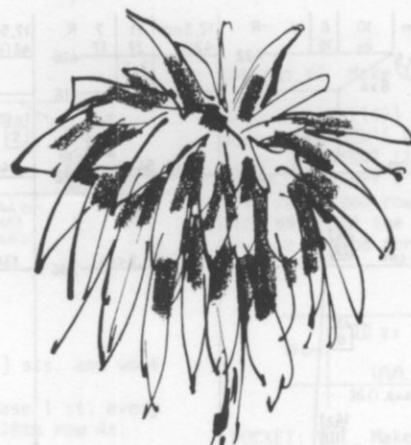

DK 270

WOMAN'S JACKET

SIZES: 10/12 (14/16) [18/20]
 YARN: Binia
 GRAMS:
 color 1 450 500 550
 color 2 200 250 300
 TENSION: 6 to 8
 GAUGE: 14 sts. 18 rows = 5 cm (2")

Stockinette stitch with repeated color stripes and knit sideways on the machine. The purl side is the right side.

FINISHING: See General Instructions.



FRONT & BACK: II

Cast on 185 sts. with color 1 and work Stockinette stitch. Knit to Row 14, then make **BUTTON-HOLES** over needles 28 to 32, 66 to 70, 104 to 108, 146 to 150 counting from the **LEFT** edge. Knit to Row 22. Bind off 28 sts. on the **RIGHT** and with a separate yarn, cast on 12 sts. on the **LEFT** for hem. Continue with **REPEATED** color stripes as shown on the Chart. **ON NECK SIDE**, cast on 2 sts. 8x, 3 sts. 4x and **AT THE SAME TIME**, after Row 30, make **BUTTONHOLES** over the same needles as you did before (beginning with needle 40 because of the 12 cast on sts. for hem). After Row 46 **SHAPE SHOULDER**: decrease 1 st. every 4th row 5x, every 6th row 3x. (every 4th row 3x, every 6th row 5x). [every 6th row 8x]. After Row 86 (90) [94] **SHAPE ARMHOLE**: For all sizes, bind off 45 sts. 1x, 2 sts. 3x. 1 st. 8x. Knit to Row 112 (116) [120]. For all sizes, increase 1 st. 8x, 2 sts. 3x, 45 sts. 1x. After Row 134 (138) [142] **SHAPE SHOULDER**: Increase 1 st. every 6th row 3x, every 4th row 5x. (every 6th row 5x, every 4th row 3x). [every 6th row 8x]. After Row 174 (182) [190], **SHAPE NECK**: For all sizes, bind off 4 sts. 1x, 1 st. 4x. Knit to Row 199 (207) [215]. Continue with the 2nd half by working backwards and **OMIT** the Buttonholes.

10/12

(14/16)

[18/20]

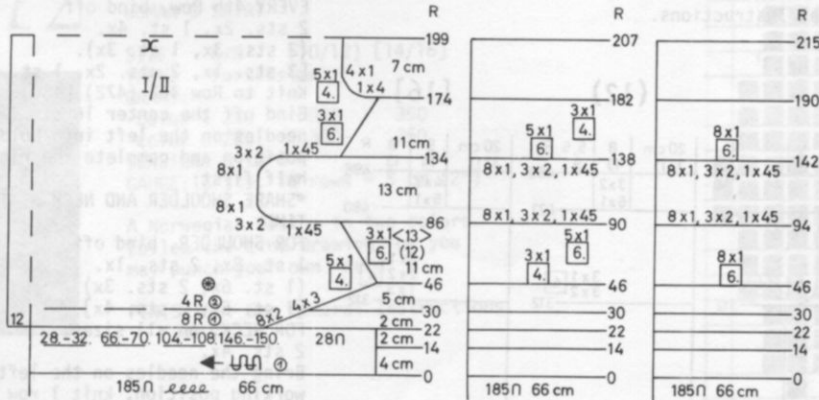

10/12

(14/16)

[18/20]

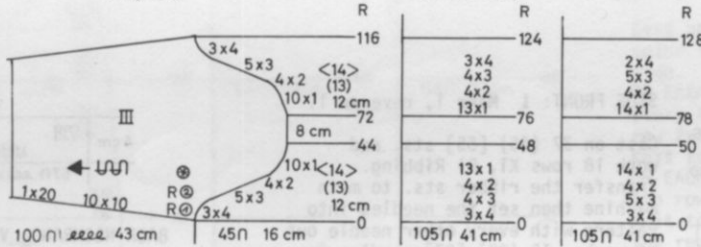

SLEEVE: III

Cast on 100 (105) [105] sts. with color 1 and work Stockinette stitch with **REPEATED** color stripes as shown on the Chart. **SHAPE CAP ON CAM BOX SIDE** and work **SHORT ROWS** opposite side of Cam Box. Put all but 10 sts. on the right side into holding position, knit 2 rows. Now shape **BOTH** sides **AT THE SAME TIME**. **ON OPPOSITE SIDE OF CAM BOX**, bring back into working position 10 sts. 9x **AND AT THE SAME TIME** for **CAP**, cast on 4 sts. 3x, 3 sts. 5x, 2 sts. 4x, 1 st. 10x. (4 sts. 3x, 3 sts. 4x, 2 sts. 4x, 1 st. 13x). [4 sts. 3x, 3 sts. 5x, 2 sts. 4x, 1 st. 14x]. Knit to Row 72 (76) [78]. **REVERSE** the procedure for the **CAP SHAPING**, following the Chart, binding off instead of casting on and **AT THE SAME TIME**, after Row 98 (106) [110], work **SHORT ROWS**: **ON OPPOSITE SIDE** of Cam Box, put into holding position 10 sts. 9x. After Row 116 (124) [128], bring all the needles back into working position and bind off loosely.

SLEEVE CUFFS: Make 2.

Cast on 63 sts. with color 1 and work 30 rows Stockinette stitch then bind off.

POCKETS: VII Make 2.

Cast on 50 sts. with color 1 and work Stockinette stitch with color stripes as shown on the Chart. Knit to Row 68, then bind off.

POCKET BANDS: Make 2.

Cast on 50 sts. with color 1 and work 30 rows Stockinette stitch then bind off.

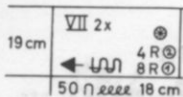

DK 271

WOMAN'S JACKET

SIZE: 8 (12) [16]
 YARN: Allegro
 GRAMS: 550 600 650
 TENSION: 9 or 10
 GAUGE:
 Pat: 8 sts, 42 rows = 5 cm (2")



A Holding Position Design over every other needle. The out of work needles ARE counted in the Stitch and Row Gauge. The purl side is the right side. Follow the Line Drawing. KNIT-KING machine owners use Wheel No. 4 and push in the RIGHT Retractor Button before knitting the 5th row, release it after knitting the 6th row. Front sections are K1, P1 Ribbing.

FINISHING: See General Instructions.

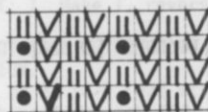

12
7-11
6
1-5



BACK: II

Cast on 137 (153) [173] sts. and work 18 rows K1, P1 Ribbing. Transfer the Ribber sts. to main machine then set into Pattern with every other needle OUT OF WORK.

68 (76) [86] needles in work. Continue in the Holding Position Design. Knit to Row 312. SHAPE ARMHOLE: ON EACH SIDE, on EVERY 4th Row, bind off 2 sts. 2x, 1 st. 4x. (2 sts. 3x, 1 st. 3x). [3 sts. 1x, 2 sts. 2x, 1 st. 6x]. Knit to Row 462 (472) [480]. Bind off the center 16 sts., put the needles on the left into holding position and complete the right half first.

*SHAPE SHOULDER AND NECK AT THE SAME TIME.

FOR SHOULDER, bind off

1 st. 8x, 2 sts. 1x.

(1 st. 6x, 2 sts. 3x).

[1 st. 5x, 2 sts. 4x].

FOR NECK, on all sizes, bind off

2 sts. 4x.

Bring the needles on the left into working position, knit 1 row in Pattern to the left side, turn the Row Counter back to 462 (472) [480] and complete the left half. Follow the instructions from *.

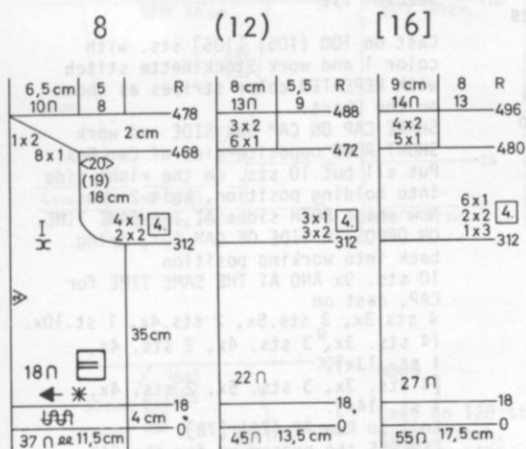
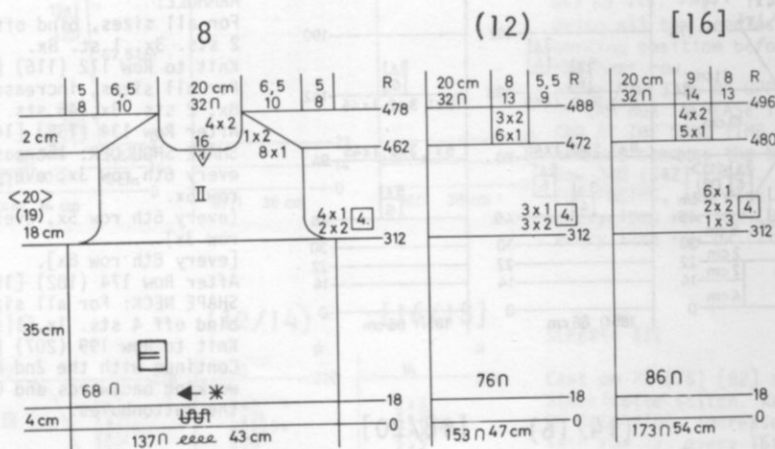

SIDE FRONT: I Make 1, reverse 1.

Cast on 37 (45) [55] sts. and work 18 rows K1, P1 Ribbing. Transfer the ribber sts. to main machine then set the needles into Pattern with every other needle out of work. 18 (22) [27] needles in work.

Continue with the Holding Position Design.

Knit to Row 312.

SHAPE ARMHOLE same as the back.

Knit to Row 468 (472) [480] then

SHAPE SHOULDER same as the back.

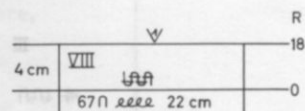

BACK NECKBAND: VIII

Cast on 67 sts. and work 18 rows K1, P1 Ribbing then bind off the crochet method for Ribbing.

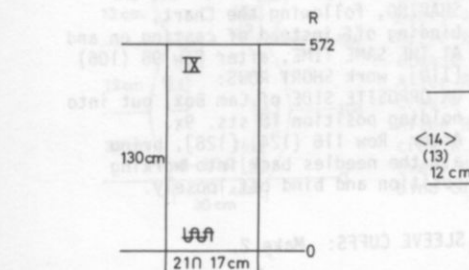

BELT: IX

Cast on 21 sts. and work 572 rows K1, P1 Ribbing then bind off the crochet method for Ribbing.

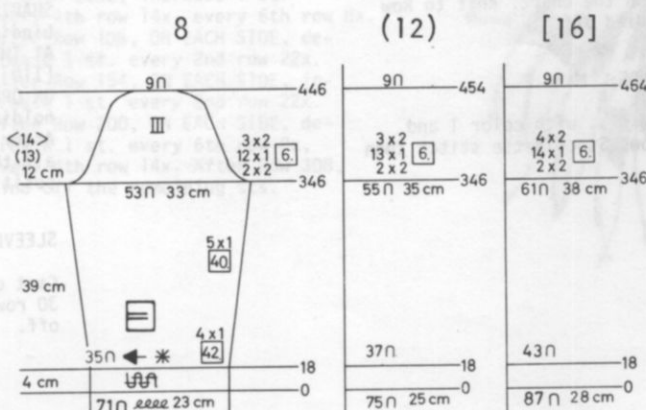

SLEEVE: III

Cast on 71 (75) [87] sts. and work 18 rows K1, P1 Ribbing.

Transfer the Ribber sts. to main machine then set the needles into Pattern with every other needle out of work. 35 (37) [43] needles in work.

Continue with the Holding Position Design.

ON EACH SIDE, increase 1 st. every 42nd row 4x, every 40th row 5x.

Knit to Row 346.

SHAPE CAP: ON EVERY 6th row, bind off 2 sts. 2x, 1 st. 12x (13x) [14x],

2 sts. 3x (3x) [4x].

After Row 446 (454) [464], bind off the remaining 9 sts.

FRONT: VIII Make 1, reverse 1 and omit the Buttonholes.

Cast on 178 (180) [184] sts. and work K1, P1 Ribbing. After Row 18, on the RIGHT (left for 2nd section) bind off 2 sts. 17x (15x) [11x] then 3 sts. 9x (11x) [15x], and AFTER ROW 56, MAKE BUTTONHOLES over needles 14 to 18, 44 to 48, 74 to 78, 104 to 108, counting from the LEFT edge. After Row 70, bind off the crochet method for Ribbing.

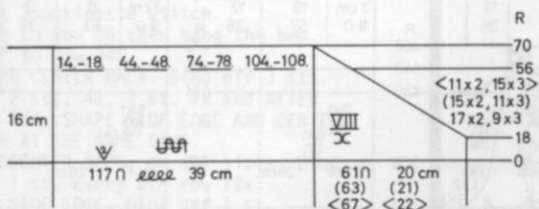

DK 272

WOMAN'S SKIRT

SIZE: 6/8 (10/12) [14/16]
 YARN: Fortissima
 GRAMS: color 1 250 300 350
 color 2 250 300 350
 TENSION: 6 to 8
 GAUGE: 15 sts. 18 rows = 5 cm (2")

A Norwegian Design in two colors. Follow the Line Drawing, or you may punch your own card.

FINISHING: See General Instructions.

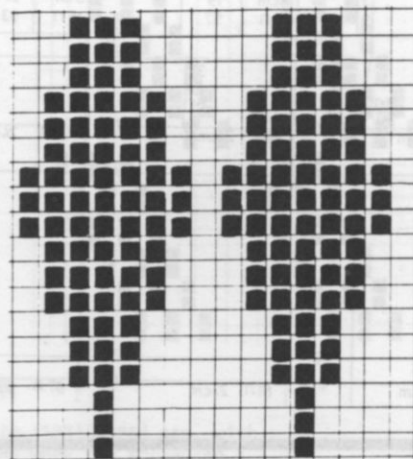

6/8

(10/12) [14/16]

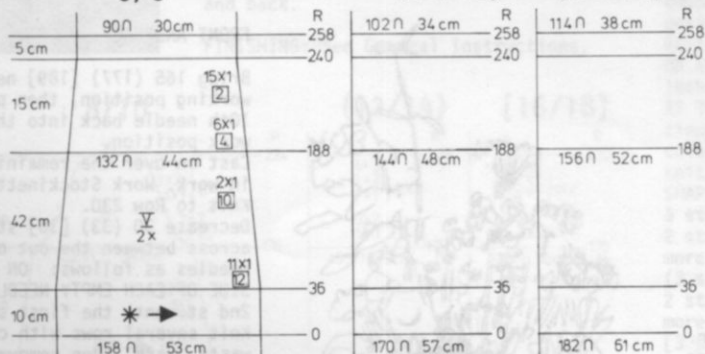

FRONT & BACK: V

Cast on 158 (170) [182] sts. with color 1 and work the Norwegian Design. Knit to Row 36. ON EACH SIDE, decrease 1 st. every 12th row 11x, every 10th row 2x. Knit to Row 188. ON EACH SIDE, decrease 1 st. every 4th row 6x, every 2nd row 15x. Knit to Row 258 then bind off the remaining 90 (102) [114] sts.



DK 273



WOMAN'S PANTS

SIZE: 6/8 (10/12) [14/16]
 YARN: Venetia
 Amount: 1 lb. 8 oz. cone.
 TENSION: 5 to 7
 GAUGE: 15 sts. 21 rows = 5 cm (2")

Stockinette stitch.

FINISHING: See General Instructions.

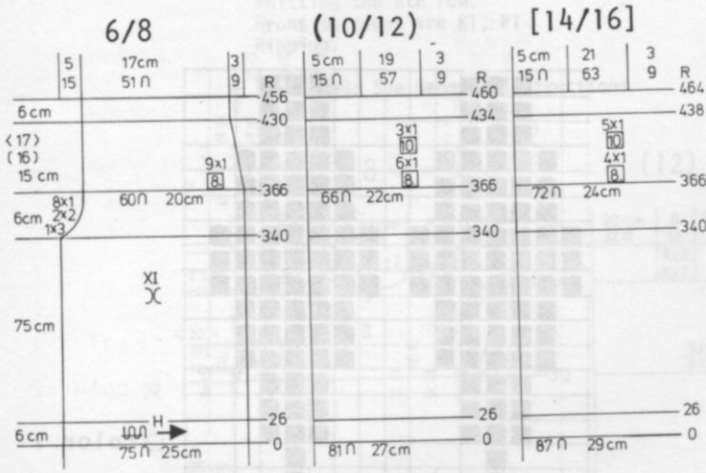
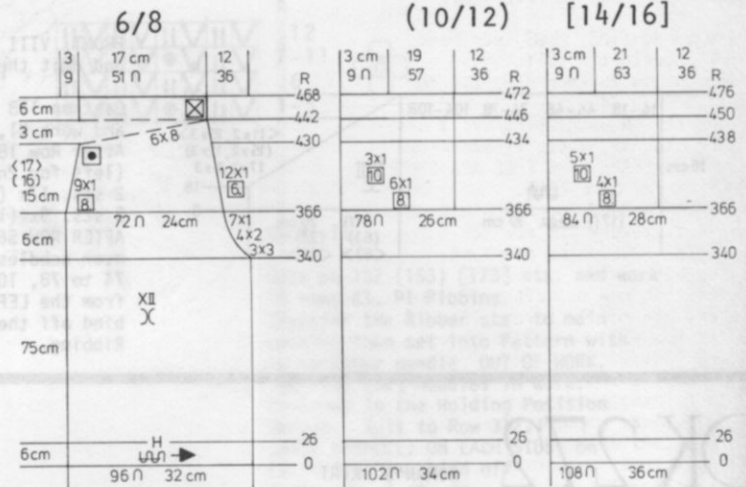

FRONT: XI Make 1, reverse 1.

Cast on 75 (81) [87] sts. and work Stockinette stitch.
 Knit to Row 26, then hang the hem.
 Knit to Row 339. SHAPE CENTER FRONT:
 FOR ALL SIZES, bind off 3 sts. 1x,
 2 sts. 2x, 1 st. 8x.
 After Row 366, SHAPE SIDE EDGE: bind
 off 1 st.
 every 8th row 9x.
 (every 8th row 6x, every 10th row 3x).
 [every 8th row 4x, every 10th row 5x].
 Knit to Row 456 (460) [464] then
 bind off the remaining 51 (57) [63]
 sts.

DK 274

WOMAN'S SKIRT

SIZE: 7/8 (10/12) [14/16]
 YARN: Allegro
 GRAMS: 450 500 < 550
 TENSION: 4 to 6
 GAUGE: 15 sts. 23 rows = 5 cm (2")

Stockinette stitch with every 10th
 needle out of work. BE SURE TO
 READ THE WRITTEN INSTRUCTIONS for
 decreasing across the knitted sec-
 tions. Worn on the purl side.

FINISHING: Weave the sides together.
 With a crochet hook and garment yarn,
 work a slip stitch crochet over
 each empty needle space. Begin at
 the lower edge and go under 2 threads,
 pull the yarn through and be sure to
 keep the crochet sts. loose and even.
 Work 2 rows single crochet at waist-
 line, then sew an elastic band to
 the inside at waist.



FRONT AND BACK: V

Bring 165 (177) [189] needles into
 working position, then push every
 10th needle back into the out of
 work position.
 Cast on over the remaining needles
 in work. Work Stockinette stitch.
 Knit to Row 230.
 Decrease 30 (33) [36] sts. evenly
 across between the out of work
 needles as follows: ON EACH
 SIDE OF EACH EMPTY NEEDLE, hang the
 2nd st. onto the first stitch.
 Knit several rows with contrast
 waste yarn, then remove the work
 from the machine by moving the
 Cam Box across without yarn.
 Bring 135 (144) [153] needles in-
 to working position, then *hang
 the sts. held on contrast waste
 yarn onto the machine, being
 sure to pick up the doubled sts.
 and push the needles directly op-
 posite the empty stitches to the
 out of work position. Remove the
 waste yarn*.
 Knit to Row 372.
 Decrease 30 (33) [36] sts. evenly
 across in the same way as you did
 before. Knit several rows with
 contrast waste yarn and remove
 the work from the machine as
 before.
 Bring 105 (111) [117] needles in-
 to working position and REPEAT
 from * to *.
 Knit to Row 418. Bring the
 empty needles into working
 position, knit 1 row with a
 loose tension (2 or 3 tensions
 higher) then bind off the
 crochet method, dropping the yarn
 over the previous empty needles.
 Be sure the bind off is loose.

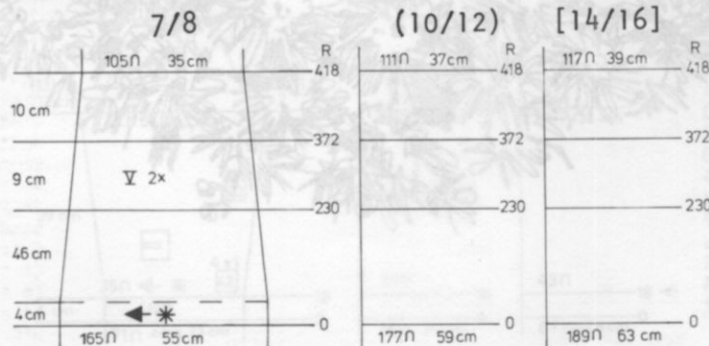
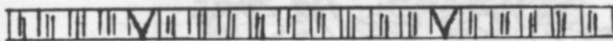

BACK: XII Make 1, reverse 1.

Cast on 96 (102) [108] sts. and work Stockinette stitch.
 Knit to Row 26 then hang the hem.
 Knit to Row 340.
SHAPE CENTER BACK. Bind off 3 sts. 3x, 2 sts. 4x, 1 st. 7x and **AFTER ROW 366, SHAPE SIDE EDGE AND CENTER BACK AT THE SAME TIME.**
FOR CENTER BACK, on all sizes, bind off 1 st. every 6th row 12x;
FOR SIDE EDGE, bind off 1 st. every 8th row 9x.
 (every 8th row 6x, every 10th row 3x).
 [every 8th row 4x, every 10th row 5x].
 After Row 430 (434) [438], work **SHORT ROWS.**
ON OPPOSITE SIDE OF CAM BOX, put into holding position 8 sts. 6x. Bring all the needles back into working position before knitting the next row, then knit to Row 468 (472) [476] and bind off the remaining 51 (57) [63] sts.

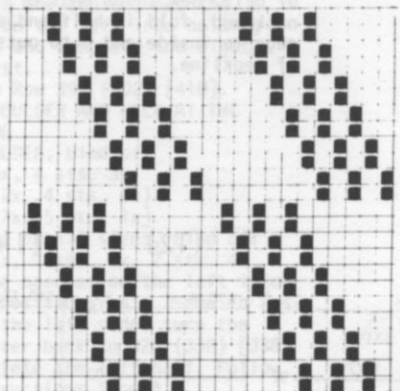
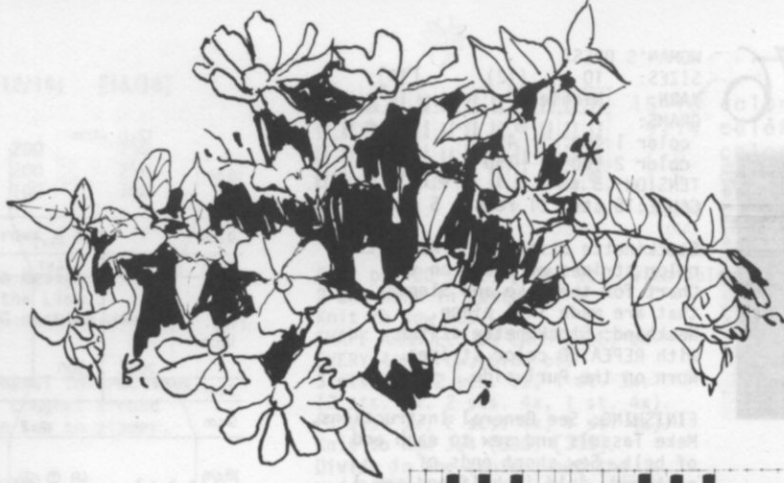

DK 275

WOMAN'S BLOUSE

SIZES: 8/10 (12/14) [16/18]
YARN: Allegro
GRAMS:
 color 1 450 500 550
 color 2 100 100 100
TENSION: 5 to 7
GAUGE: 15 sts. 20 rows = 5 cm (2")



Stockinette stitch with a Norwegian Design on the Sleeves. K1, P1 Ribbing on lower edge and for yoke on front and back.

FINISHING: See General Instructions.

SLEEVE: III

Cast on 120 (123) [126] sts. with color 1 and work the Norwegian Design.
 Knit to Row 36.
ON EACH SIDE, decrease 1 st. every 16th row 7x, every 14th row 2x and **AT THE SAME TIME,** after Row 84, continue with Stockinette stitch and color 1.
 Knit to Row 176.
SHAPE CAP: ON EACH SIDE, bind off 3 sts. 2x, 2 sts. 2x, *1 st. 1x, 2 sts. 1x, and REPEAT from * 7x more, 3 sts. 4x.
 (3 sts. 1x, 2 sts. 3x, *1 st. 1x, 2 sts. 1x, and REPEAT from * 8x more, 3 sts. 4x).
 [3 sts. 1x, 2 sts. 3x, *1 st. 1x, 2 sts. 1x, and REPEAT from * 10x more, 3 sts. 2x].
 After Row 224 (228) [232], bind off the remaining 10 (9) [12] sts.

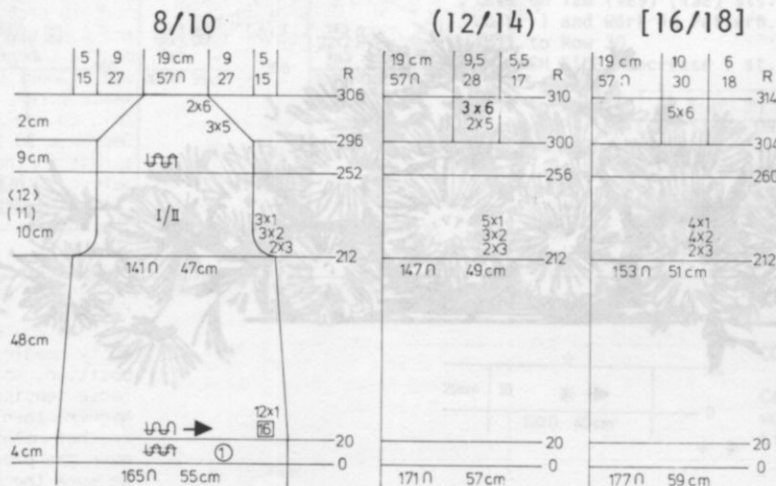
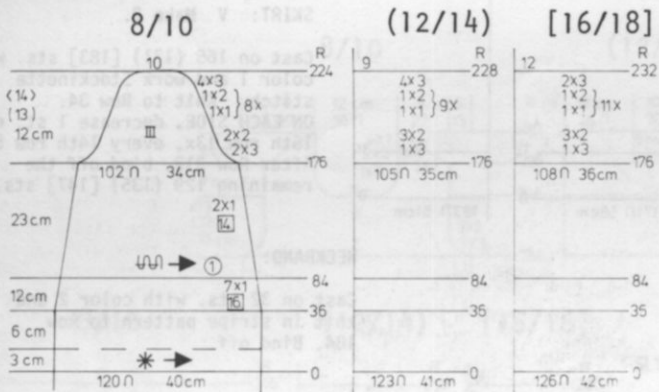

FRONT & BACK: I/II

Cast on 165 (171) [177] sts. and work 20 rows K1, P1 Ribbing. Change to Stockinette stitch and **ON EACH SIDE,** decrease 1 st. every 16th row 12x.
 Knit to Row 212.
SHAPE ARMHOLE: ON EACH SIDE, bind off 3 sts. 2x, 2 sts. 3x (3x) [4x], 1 st. 3x (5x) [4x].
 Knit to Row 252 (256) [260]. Change to K1, P1 Ribbing. Knit to Row 296 (300) [304].
SHAPE SHOULDER: ON EACH SIDE, bind off 5 sts. 3x, 6 sts. 2x. (5 sts. 2x, 6 sts. 3x). [6 sts. 5x].
 After Row 306 (310) [314], bind off the remaining 57 sts.

DK 276



WOMAN'S DRESS
 SIZES: 10 (12) [14]
 YARN: Nicole
 GRAMS:
 color 1 400 450 500
 color 2 100 150 200
 TENSION: 5 to 7
 GAUGE: 15 sts. 21 rows = 5 cm (2")

Stockinette stitch with REPEATED color stripes as shown on the Chart for the Yoke and Sleeves that are made in 1 piece.
 Neckband: Stockinette stitch with REPEATED color stripes.
 Worn on the Purl side.

FINISHING: See General Instructions. Make Tassels and sew to each end of belt. Sew short ends of neckband, fold in half and sew 1 edge to inside and 1 to outside of neckline.

YOKE & SLEEVES:

Cast on 124 sts. with color 2 and work Stockinette stitch with REPEATED color stripes as shown on the Chart.
 Knit to Row 76.
 ON EACH SIDE, decrease 2 sts. 19x. After Row 114, divide in the center, put the needles on the left into holding position and complete the right half first.
 *ON SIDE EDGE, decrease 1 st. 4x. Knit to Row 198.
 ON SIDE EDGE, increase 1 st. 4x**. After Row 206, put these stitches into holding position. Attach yarn in center, bring the needles on the left into working position, knit 1 row to the left side, (watch stripe), turn the Row Counter back to 114 and REPEAT the instructions from * to **.
 After Row 206, bring all the needles back into working position.
 ON EACH SIDE, increase 2 sts. 19x. Knit to Row 320, then bind off.

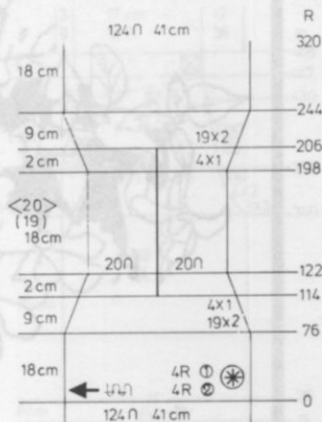

10

(12)

[14]

BODICE FRONT & BACK: I/II

Cast on 129 (135) [147] sts. with color 1 and work Stockinette stitch.
 Knit to Row 92.
 ON EACH SIDE, decrease 2 sts. 19x, 1 st. 4x.
 After Row 138, bind off the remaining 45 (47) [51] sts.

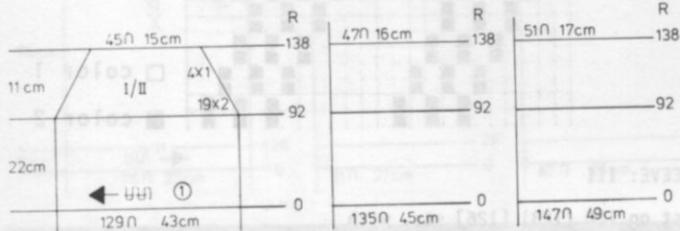

10

(12)

[14]

SKIRT: V Make 2.

Cast on 165 (171) [183] sts. with color 1 and work Stockinette stitch. Knit to Row 34.
 ON EACH SIDE, decrease 1 st. every 16th row 13x, every 14th row 5x.
 After Row 312, bind off the remaining 129 (135) [147] sts.

BELT: IX

Cast on 12 sts. with color 1 and work 720 rows Stockinette stitch then bind off.

NECKBAND:

Cast on 32 sts. with color 2 and knit in stripe pattern to Row 184. Bind off.

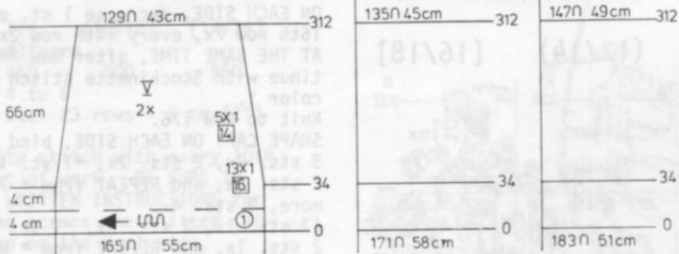
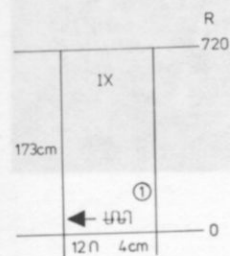

DK 277

WOMAN'S PULLOVER

SIZES: 8/10 (12/14) [16/18]
 YARN: Amore
 GRAMS:
 color 1 150 200 250
 color 2 150 200 250
 color 3 100 100 150
 TENSION: 5 to 7
 GAUGE: 15 sts. 36 rows = 5 cm (2")



A Holding Position Design using 3 colors. Follow the Line Drawing. KNITTING machine owners use Wheel No. 2.

FINISHING: See General Instructions. Work 1 row single crochet around neck opening, then sew in zipper.

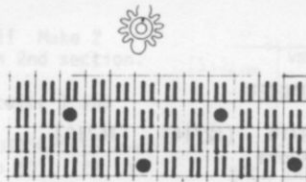

15-16 color 3
 9-14 color 1
 7-8 color 3
 1-6 color 2

BACK: II

Cast on 120 (132) [144] sts. with color 2 and work in Pattern.

Knit to Row 266.
 SHAPE ARMHOLE: ON EACH SIDE, on EVERY 4th row, bind off 3 sts. 2x, 2 sts. 3x, 1 st. 3x. (3 sts. 2x, 2 sts. 4x, 1 st. 4x). [3 sts. 3x, 2 sts. 4x, 1 st. 4x]. Knit to Row 324 (330) [338]. Divide in the center, put the needles on the left into holding position and complete the right half first.

*Knit to Row 396 (402) [410]. SHAPE SHOULDER AND NECK AT THE SAME TIME.

FOR SHOULDER, bind off

3 sts. 5x, 4 sts. 3x. (3 sts. 2x, 4 sts. 6x). [4 sts. 7x, 5 sts. 1x].

FOR NECK, on all sizes, bind off 8 sts. 1x, 3 sts. 2x, 2 sts. 4x. Bring the needles on the left into working position, knit 1 row in Pattern to the left side, turn the Row Counter back to 324 (330) [338] and complete the left half. Follow the instructions from *.

FRONT: I

Work the front the same as the back to Row 266.

SHAPE ARMHOLE same as the back then knit to Row 346 (352) [360]. Bind off the center 14 sts., put the needles on the left into holding position and complete the right half first.

*ON NECK SIDE, for all sizes, bind off 3 sts. 1x, 2 sts. 2x, 1 st. 4x and SHAPE SHOULDER same as the back after Row 396 (402) [410].

Bring the needles on the left into working position, knit 1 row in Pattern to the left side, turn the Row Counter back to 346 (352) [360] and complete the left half. Follow the instructions from *.

8/10

(12/14)

[16/18]

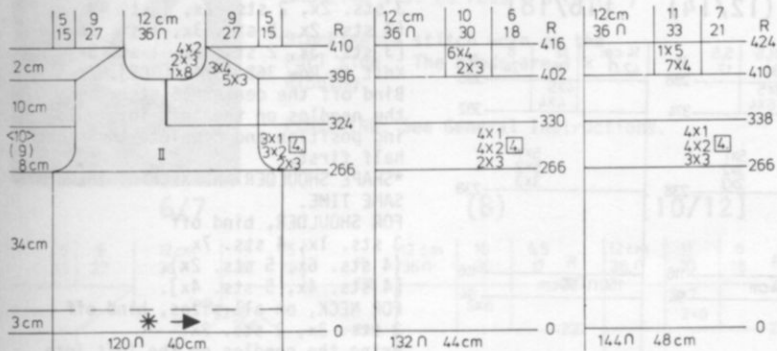

8/10

(12/14)

[16/18]

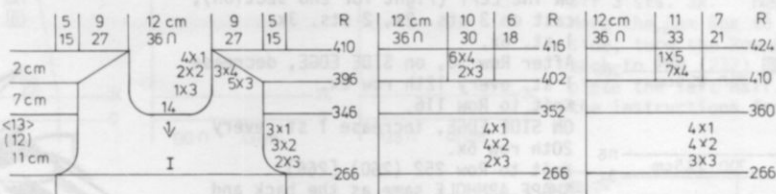

8/10

(12/14)

[16/18]



SLEEVE: III

Cast on 126 (129) [132] sts. with color 1 and work in Pattern. Knit to Row 30.

ON EACH SIDE, decrease 1 st. every 10th row 12x. Knit to Row 166.

SHAPE CAP: ON EACH SIDE, ON EVERY 4th ROW, bind off

3 sts. 2x, 2 sts. 14x, 3 sts. 4x. (3 sts. 2x, 2 sts. 18x, 3 sts. 2x). [3 sts. 1x, 2 sts. 22x, 3 sts. 1x]. After Row 246 (252) [260], bind off the remaining 10 (9) [8] sts.

COLLAR: VI

Cast on 120 sts. with color 2 and work 144 rows in Pattern, then bind off.

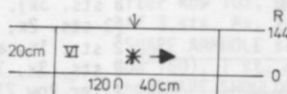

DK 278

DK 278

WOMAN'S JACKET



SIZES: 8/10 (12/14) [16/18]

YARN: Amore

GRAMS:

color 1	250	300	350
color 2	100	150	150
color 3	100	150	150

TENSION: 5 to 7

GAUGE: 15 sts. 36 rows = 5 cm (2")

A Holding Position Design using 3 colors. Follow the Line Drawing. KNITTING machine owners use Wheel No. 2. Bands are Ribbed.

FINISHING: See General Instructions.



BACK: II

Cast on 132 (144) [162] sts. with color 2 and work in Pattern. Knit to Row 36.
 ON EACH SIDE, decrease 1 st. every 12th row 6x.
 Knit to Row 116.
 ON EACH SIDE, increase 1 st. every 20th row 6x.
 Knit to Row 238.
 SHAPE ARMHOLE: ON EACH SIDE, bind off
 3 sts. 2x, 2 sts. 2x, 1 st. 4x.
 (3 sts. 2x, 2 sts. 3x, 1 st. 5x).
 [3 sts. 3x, 2 sts. 5x, 1 st. 5x].
 Knit to Row 368 (374) [382].
 Bind off the center 16 sts., put the needles on the left into holding position and complete the right half first.
 *SHAPE SHOULDER AND NECK AT THE SAME TIME.
 FOR SHOULDER, bind off
 3 sts. 1x, 4 sts. 7x.
 (4 sts. 6x, 5 sts. 2x).
 [4 sts. 4x, 5 sts. 4x].
 FOR NECK, on all sizes, bind off 3 sts. 3x, 2 sts. 2x.
 Bring the needles on the left into working position, knit 1 row in Pattern to the left side, turn the Row Counter back to 368 (374) [382] and complete the left half. Follow the instructions from *.

8/10

(12/14)

[16/18]

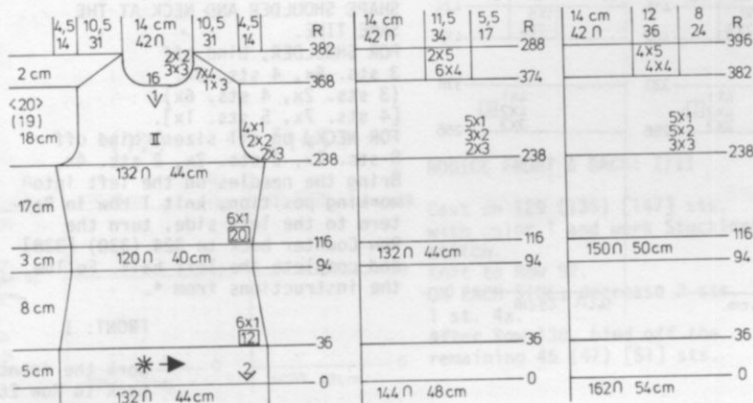

8/10

(12/14)

[16/18]

FRONT: Make 1, reverse 1.

Cast on 43 (49) [58] sts. with color 2 and work in Pattern.
 ON THE LEFT (right for 2nd section), cast on 3 sts. 2x, 2 sts. 3x, 1 st. 6x.
 After Row 36, on SIDE EDGE, decrease 1 st. every 12th row 6x.
 Knit to Row 116.
 ON SIDE EDGE, increase 1 st. every 20th row 6x.
 Knit to Row 252 (260) [266].
 SHAPE ARMHOLE same as the back and AT THE SAME TIME, ON NECK SIDE, decrease 1 st. every 8th row 8x, every 10th row 8x and SHAPE SHOULDER same as the back after Row 382 (396) [410].

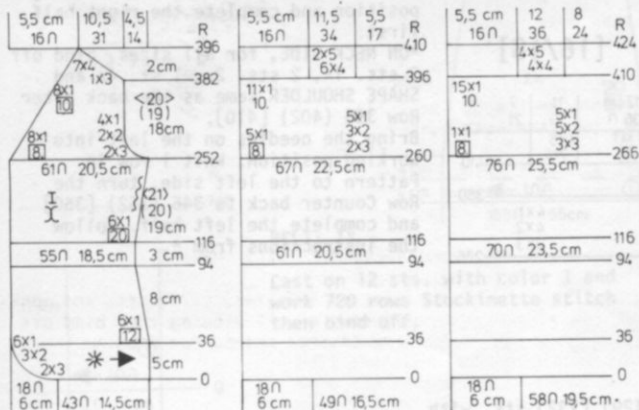

SLEEVE: III

Cast on 60 (66) [72] sts. with color 1 and work 30 rows K1, P1 Ribbing. Change to Stockinette stitch.
 ON EACH SIDE, increase 1 st. every 10th row 6x, every 8th row 12x.
 Knit to Row 186.
 SHAPE CAP: ON EACH SIDE, bind off 3 sts. 1x, 2 sts. 4x, *1 st. 2x, 2 sts. 1x, and REPEAT from * 4x more, 3 sts. 4x.
 (3 sts. 2x, 2 sts. 3x, *1 st. 2x, 2 sts. 1x, and REPEAT from * 5x, more, 3 sts. 3x).
 [3 sts. 2x, 2 sts. 3x, *1 st. 2x, 2 sts. 1x, and REPEAT from * 6x more, 2 sts. 3x, 3 sts. 2x].
 After Row 234 (238) [242], bind off the remaining 10 (12) [12] sts.

8/10

(12/14)

[16/18]

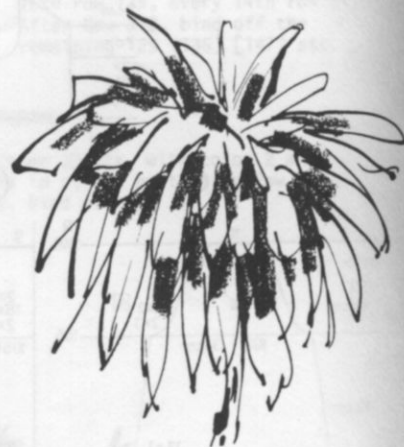
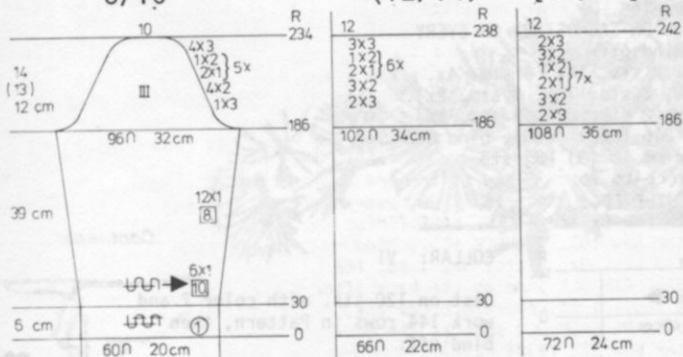

FRONT & NECK BANDS: VIII Make 2 but omit Buttonholes in 2nd section.

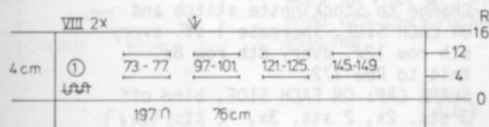
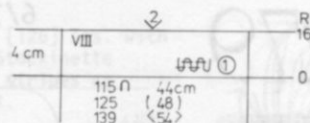

Cast on 197 sts. with color 1 and work K1, P1 Ribbing.
Knit to Row 4. MAKE BUTTONHOLES over needles 73 to 77, 97 to 101, 121 to 125, 145 to 149, counting from the left edge. After Row 12, make BUTTONHOLES over the same needles as before. After Row 16, bind off the crochet method for Ribbing.

BACK BAND for Lower Edge.

Cast on 115 (125) [139] sts. with color 1 and work 16 rows K1, P1 Ribbing then bind off the crochet method for Ribbing.

DK 279

WOMAN'S WRAP AROUND BLOUSE

SIZES: 6/7 (8) [10/12]
YARN: Fortissima
GRAMS: 400 450 500
TENSION: 6 to 8
GAUGE: 15 sts. 20 rows = 5 cm (2")

Stockinette stitch worn on the Purl side. The bands are 1 x 1 Ribbing.

FINISHING: See General Instructions.

BACK: II

Cast on 120 (130) [138] sts. and work Stockinette stitch.
Knit to Row 24.
ON EACH SIDE, decrease 1 st. every 10th row 2x, every 8th row 4x.
Knit to Row 68.
Transfer every other stitch to the Ribbing and work K1, P1 Ribbing to Row 88.
Change to Stockinette stitch.
ON EACH SIDE, increase 1 st. every 12th row 6x.
Knit to Row 160.
SHAPE ARMHOLE: ON EACH SIDE, bind off
3 sts. 2x (2x) [3x], 2 sts. 3x (3x) [2x], 1 st. 3x (5x) [5x].
Knit to Row 228 (232) [236].
Bind off the center 18 sts., put the needles on the left into holding position and complete the right half first.
*SHAPE SHOULDER AND NECK AT THE SAME TIME.
FOR SHOULDER, bind off 5 sts. 3x, 6 sts. 2x. (6 sts. 5x).
[6 sts. 2x, 7 sts. 3x].
FOR NECK, on all sizes, bind off 3 sts. 3x.
Move the Cam Box to the left side, turn the Row Counter back to 228 (232) [236] and complete the left half. Follow the instructions from *.



6/7

(8)

[10/12]

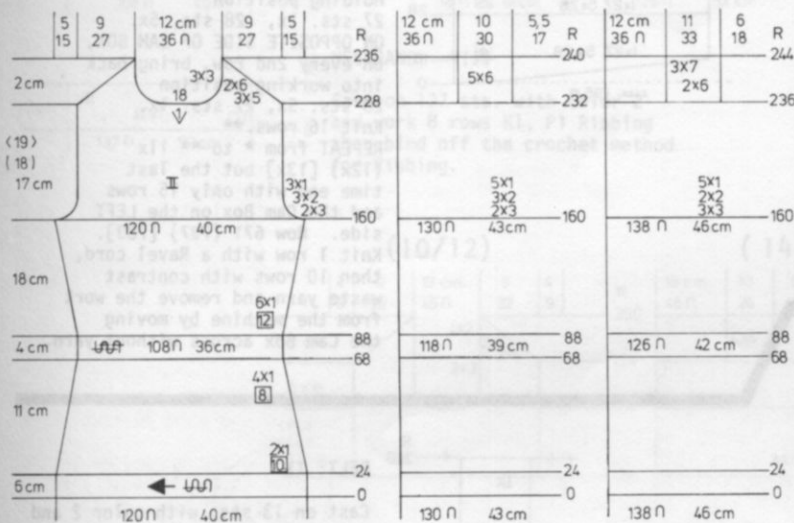

6/7

(8)

[10/12]

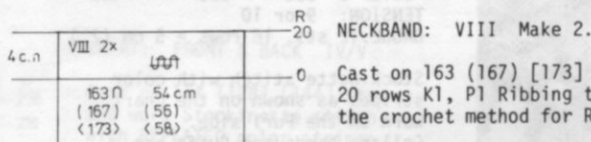
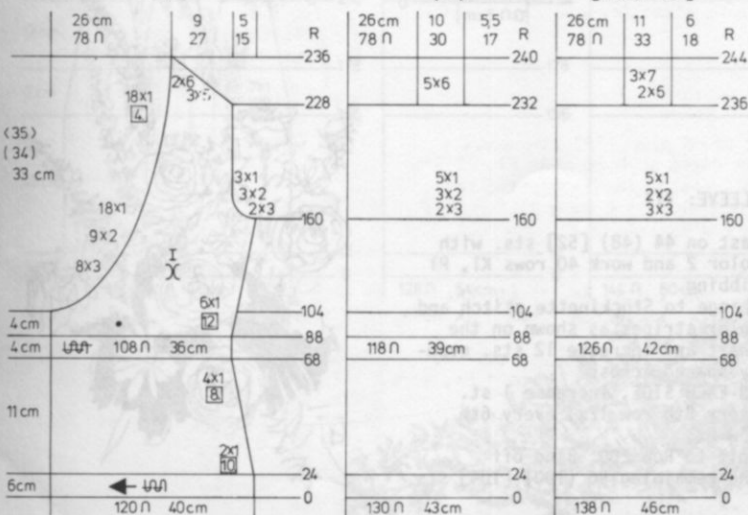

NECKBAND: VIII Make 2.

Cast on 163 (167) [173] sts. and work 20 rows K1, P1 Ribbing then bind off the crochet method for Ribbing.

FRONT: I Make 1, reverse 1.

Cast on 120 (130) [138] sts. and work Stockinette stitch.
Knit to Row 24.
ON SIDE EDGE, decrease 1 st. every 10th row 2x, every 8th row 4x.
Knit to Row 68.
Transfer every other stitch to the Ribber and work K1, P1 Ribbing to Row 88.
Change to Stockinette stitch and ON SIDE EDGE, increase 1 st. every 12th row 6x and AT THE SAME TIME, after Row 103, ON NECK SIDE, bind off 3 sts. 8x, 2 sts. 9x, 1 st. 18x (SHAPE ARMHOLE same as the back after Row 160), 1 st. every 4th row 18x, and SHAPE SHOULDER same as the back after Row 228 (232) [236].

Continued



DK 279

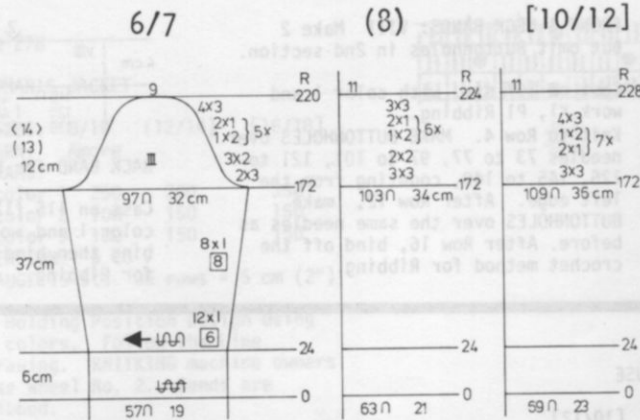

SLEEVE: III

Cast on 57 (63) [69] sts. and work 24 rows K1, P1 Ribbing. Change to Stockinette stitch and ON EACH SIDE, increase 1 st. every 6th row 12x, every 8th row 8x. Knit to Row 172. SHAPE CAP: ON EACH SIDE, bind off 3 sts. 2x, 2 sts. 3x, *2 sts. 1x, 1 st. 2x and REPEAT from * 4x more, 3 sts. 4x. (3 sts. 3x, 2 sts. 2x, *2 sts. 1x, 1 st. 2x and REPEAT from * 5x more, 3 sts. 3x). [3 sts. 3x, *1 st. 2x, 2 sts. 1x, and REPEAT from * 6x more, 3 sts. 4x]. After Row 220 (224) [228], bind off the remaining 9 (11) [11] sts.

DK 280

WOMAN'S SKIRT

SIZES: 8/10 (12/14) [16/18]
 YARN: Amore
 GRAMS: 350 400 450
 TENSION: 5 to 7
 GAUGE: 15 sts. 26 rows = 5 cm (2")



Stockinette stitch. The skirt is knitted sideways on the machine using Short Rows.

FINISHING: Weave the open sts. together then remove the waste yarn. OR - you can lightly press the open sts. and remove the waste yarn 1 stitch at a time as you weave the open sts. together, just be sure that the sts. line up properly and are even. Turn under and hem a casing at waist and insert elastic. Make hem at lower edge to the length you prefer.

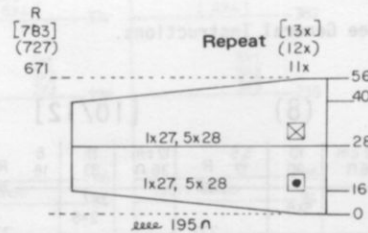

With contrast waste yarn, cast on 195 sts. Knit 9 rows ending with Cam Box on the LEFT side. Knit 1 row to the right with a ravel cord. Turn the Row Counter to 0 and change to garment yarn. *Knit 16 rows, then work SHORT ROWS. ON OPPOSITE SIDE OF CAM BOX, on every 2nd row, put into holding position 27 sts. 1x, 28 sts. 5x. ON OPPOSITE SIDE OF CAM BOX, on every 2nd row, bring back into working position 28 sts. 5x, 27 sts. 1x. Knit 16 rows.** REPEAT from * to ** 11x (12x) [13x] but the last time end with only 15 rows and the Cam Box on the LEFT side. Row 671 (727) [783]. Knit 1 row with a Ravel cord, then 10 rows with contrast waste yarn and remove the work from the machine by moving the Cam Box across without yarn.

DK 281

WOMAN'S TWO PIECE DRESS

SIZES: 10/12 (14) [16/18]
 YARN: Alanda Tweed
 GRAMS: color 1 450 500 550 color 2 300 350 400 color 3 300 350 400
 TENSION: 9 or 10
 GAUGE: 12 sts. 16 rows = 5 cm (2")



Stockinette stitch with color stripes as shown on the Chart. Worn on the Purl side. Collar, bands and Cuffs are K1, P1 Ribbing.

FINISHING: See General Instructions.

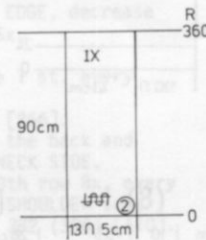

BELT: IX

Cast on 13 sts. with color 2 and work 360 rows K1, P1 Ribbing then bind off the crochet method for Ribbing.

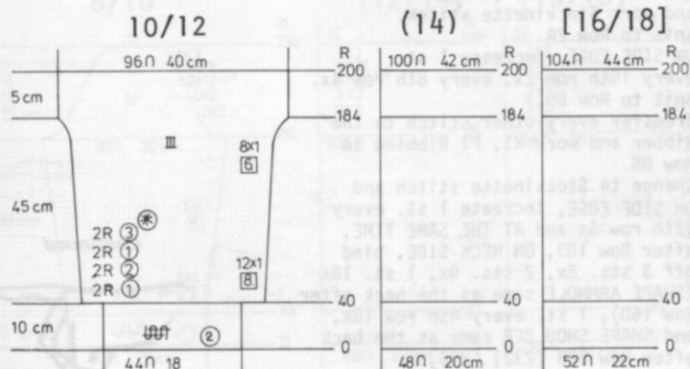

SLEEVE: III

Cast on 44 (48) [52] sts. with color 2 and work 40 rows K1, P1 Ribbing. Change to Stockinette stitch and color stripes as shown on the Chart and increase 12 sts. evenly spaced across. ON EACH SIDE, increase 1 st. every 8th row 12x, every 6th row 8x. Knit to Row 200. Bind off the remaining 96 (100) [104] sts.



COLLAR: VI

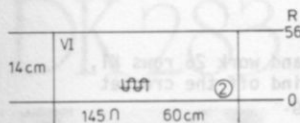

Cast on 145 sts. with color 2 and work 56 rows K1, P1 Ribbing then bind off the crochet method for Ribbing.

BACK: II

Cast on 108 (118) [126] sts. with color 1 and work Stockinette stitch with color stripes as shown on the Chart. Knit to Row 12. ON EACH SIDE, decrease 1 st. every 8th row 6x. Knit to Row 66. ON EACH SIDE, increase 1 st. every 10th row 2x, every 12th row 4x. Knit to Row 134. SHAPE ARMHOLE: ON EACH SIDE, bind off 9 (12) [14] sts. Knit to Row 194 (198) [202]. Bind off the center 22 sts., put the needles on the left into holding position and complete the right half first. *SHAPE SHOULDER AND NECK AT THE SAME TIME. FOR SHOULDER, bind off 5 sts. 2x, 6 sts. 2x. (6 sts. 4x). [6 sts. 2x, 7 sts. 2x]. FOR NECK, on all sizes, bind off 6 sts. 2x. Bring the needles on the left into working position, knit 1 row to the left side, turn the Row Counter back to 194 (198) [202] and complete the left half. Follow the instructions from *.



(10/12)

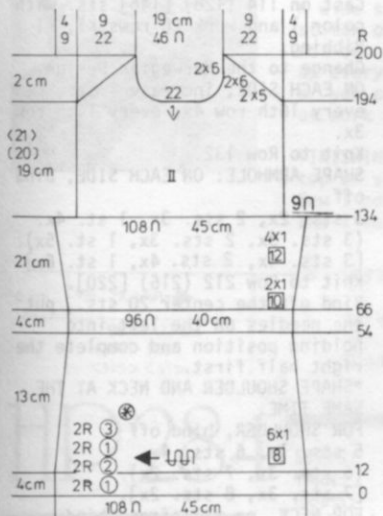

(14)

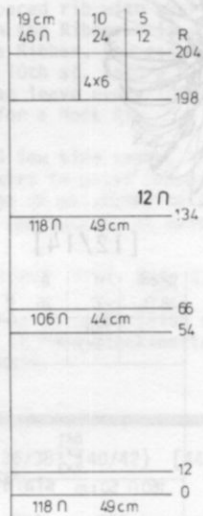

[16/18]

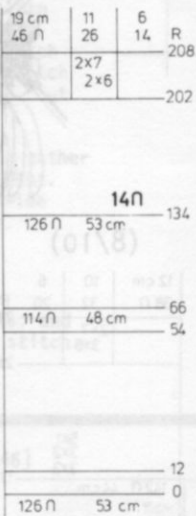

NECKBAND: VIII

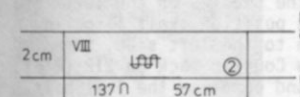

Cast on 137 sts. with color 2 and work 8 rows K1, P1 Ribbing then bind off the crochet method for Ribbing.

FRONT: I

Work the front the same as the back to Row 134. SHAPE ARMHOLE same as the back then knit to Row 174 (178) [182]. Bind off the center 18 sts., put the needles on the left into holding position and complete the right half first. *ON NECK SIDE, for all sizes, bind off 3 sts. 2x, 2 sts. 4x. Knit to Row 194 (198) [202]. SHAPE SHOULDER same as the back. Bring the needles on the left into working position, knit 1 row to the left side, turn the Row Counter back to 174 (178) [182] and complete the left half. Follow the instructions from *.

(10/12)

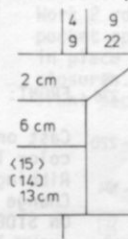

(14)

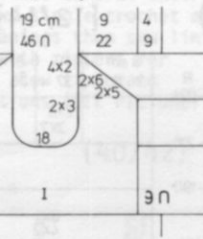

[16/18]

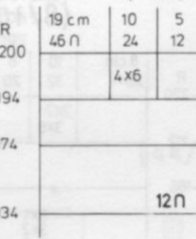

10/12

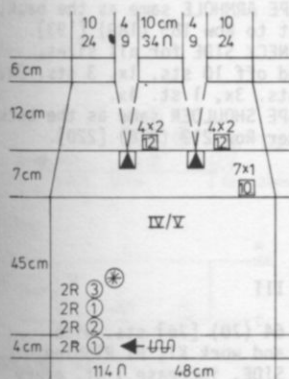

(14)

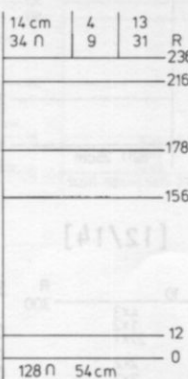

[16/18]

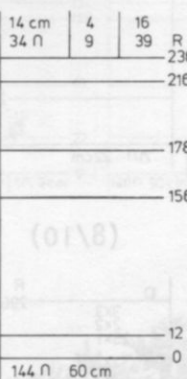

SKIRT: FRONT & BACK IV/V

Cast on 114 (128) [144] sts. and work Stockinette stitch with REPEATED color stripes as shown on the Chart. Knit to Row 156. ON EACH SIDE, decrease 1 st. every 10th row 7x, AND AT THE SAME TIME, after Row 178, decrease 2 sts. for EACH DART every 12th row 4x. For the first DART, make the decreases ON EACH SIDE of the center 42 sts. and the following dart decreases directly above. Knit to Row 236, then bind off the remaining sts.



DK282



WOMAN'S JACKET

SIZES: 6/7 (8/10) [12/14]
YARN: Fortissima
GRAMS:
 color 1 400 450 500
 color 2 200 250 300
TENSION: 4 to 6
GAUGE: 16 sts. 22 rows = 5 cm (2")

A Norwegian Design using 2 colors (SEE KNITTING NEWS). The Collar, lower bands and sleeves are Ribbed. Follow the Line Drawing for the Norwegian Design or you can punch your own card.

FINISHING: See General Instructions. Sew a jacket type zipper down the front opening.

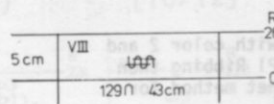

NECKBAND: VIII

Cast on 129 sts. and work 26 rows K1, P1 Ribbing then bind off the crochet method for Ribbing.



BACK: II

Cast on 114 (128) [146] sts. with color 1 and work 26 rows K1, P1 Ribbing.

Change to the Norwegian Design. ON EACH SIDE, increase 1 st. every 16th row 4x, every 14th row 3x.

Knit to Row 132. SHAPE ARMHOLE: ON EACH SIDE, bind off

3 sts. 2x, 2 sts. 3x, 1 st. 4x. (3 sts. 3x, 2 sts. 3x, 1 st. 5x). [3 sts. 4x, 2 sts. 4x, 1 st. 6x]. Knit to Row 212 (216) [220]. Bind off the center 20 sts., put the needles on the left into holding position and complete the right half first.

*SHAPE SHOULDER AND NECK AT THE SAME TIME. FOR SHOULDER, bind off 5 sts. 1x, 6 sts. 4x. (6 sts. 3x, 7 sts. 2x). [7 sts. 3x, 8 sts. 2x]. FOR NECK, on all sizes, bind off 3 sts. 3x. Bring the needles on the left into working position, knit 1 row in Pattern to the left side, turn the Row Counter back to 212 (216) [220] and complete the left half. Follow the instructions from *.

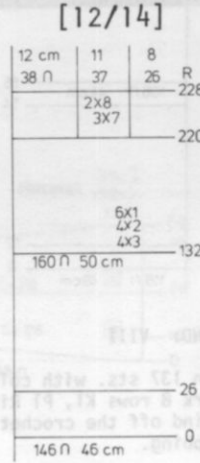
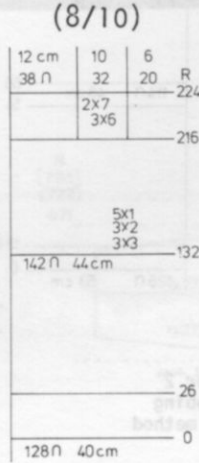
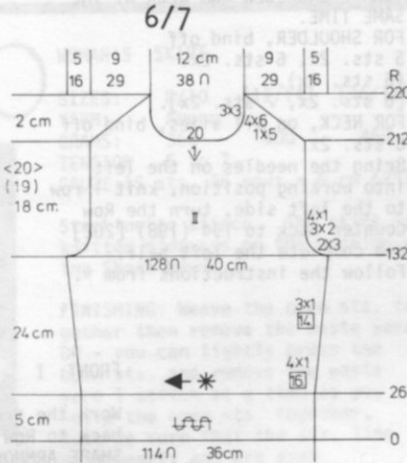

DK280

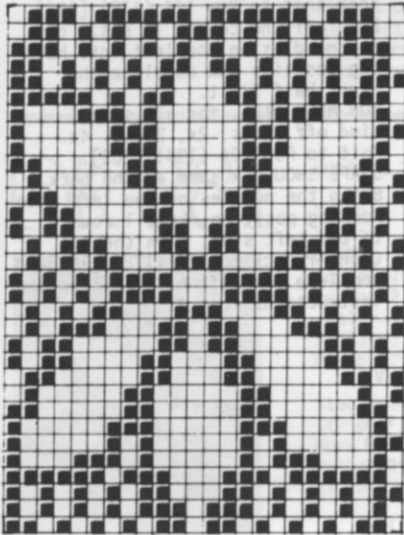

□ color 1 ■ color 2

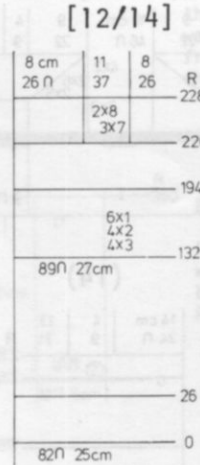
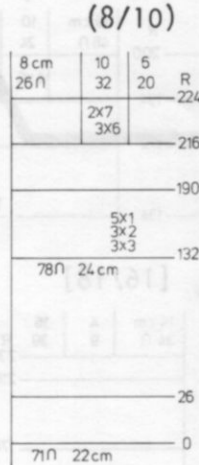
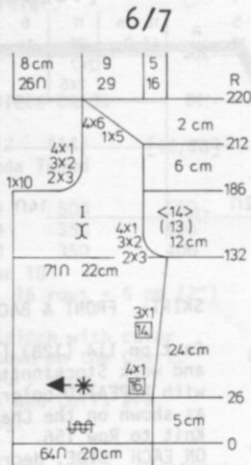

FRONT: I Make 1, reverse 1.

Cast on 64 (71) [82] sts. with color 1 and work 26 rows K1, P1 Ribbing.

Change to the Norwegian Design. ON SIDE EDGE, increase 1 st. every 16th row 4x, every 14th row 3x.

Knit to Row 132. SHAPE ARMHOLE same as the back, knit to Row 185 (189) [193]. ON NECK SIDE for all sizes, bind off 10 sts. 1x, 3 sts. 2x, 2 sts. 3x, 1 st. 4x. SHAPE SHOULDER same as the back after Row 212 (216) [220].

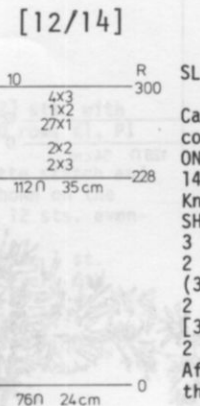
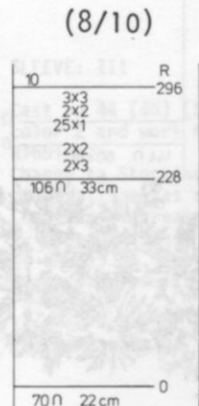
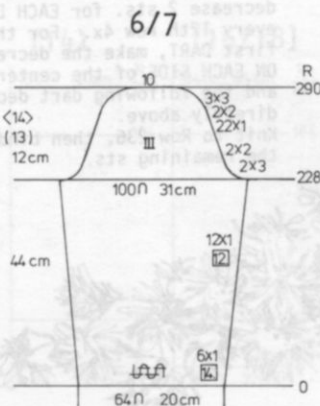

SLEEVE: III

Cast on 64 (70) [76] sts. with color 1 and work K1, P1 Ribbing. ON EACH SIDE, increase 1 st. every 14th row 6x, every 12th row 12x. Knit to Row 228.

SHAPE CAP: ON EACH SIDE, bind off 3 sts. 2x, 2 sts. 2x, 1 st. 22x, 2 sts. 2x, 3 sts. 3x. (3 sts. 2x, 2 sts. 2x, 1 st. 25x, 2 sts. 2x, 3 sts. 3x). [3 sts. 2x, 2 sts. 2x, 1 st. 27x, 2 sts. 1x, 3 sts. 4x]. After Row 290 (296) [300], bind off the remaining 10 sts.

DK 283

WOMAN'S SKIRT

SIZES: 8/10 (12/14) [16/18].
 YARN: Amore
 GRAMS: 400 450 500
 TENSION 4 to 6.
 GAUGE: 15 sts. 26 rows = 5 cm (2")

A wide spaced rib with every 10th stitch on the Ribber. If you do not own a Ribber, you either latch up every 10th st. into a Rib stitch or you can leave every 10th st. out of work for a Mock Rib.

FINISHING: Sew side seams, then gather top of skirt to waist measurement. Sew 1 edge of waistband to inside and 1 to the outside at waist.

WAISTBAND: VIII Make 2.

Cast on 90 (101) [115] sts. and work 32 rows Stockinette stitch. Bind off.

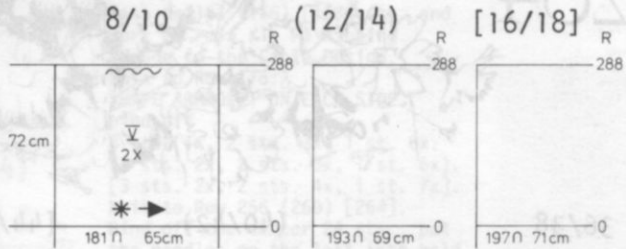
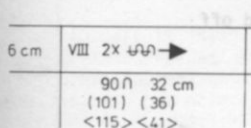

FRONT & BACK: IV/V

Cast on 181 (193) [197] sts. with every 10th st. on the Ribber. Knit to Row 374. Transfer the Rib sts. to main machine and bind off loosely.

HP 284

SIZES: 36/38 (40/42) [44/46]
 YARN: Bina
 GRAMS:
 color 1 700 750 800
 color 2 100 100 100
 TENSION: 9 or 10
 GAUGE: 14 sts. 18 rows = 5 cm (2")

Stockinette stitch with REPEATED color stripes as shown on the Chart. Knitted sideways on the machine and the Purl side is the right side.

FINISHING: See General Instructions. Work 2 rows single crochet across pocket openings then sew linings in place with zippers for closures. Sew zipper to front sections (SEE PICTURE).



POCKET LINING: VII Make 2

Cast on 50 sts. with color 1 and work 54 rows Stockinette stitch then bind off.

BACK: II

Cast on 140 sts. with color 2 and work Stockinette stitch with REPEATED color stripes as shown on the Chart.

SHAPE ARMHOLE: For all sizes, on every 2nd row, cast on 3 sts. 2x, 2 sts. 3x, (3x) [4x], 1 st. 3x (5x) [6x], then cast on 47 sts. 1x.

After Row 18, SHAPE SHOULDER: ON EVERY 8th (10th) [12th] row, increase 1 st. 5x.

After Row 62 (68) [76], SHAPE NECK: For all sizes, bind off 1 st. 3x.

Knit to Row 118 (128) [132], then cast on 1 st. 3x.

After Row 124 (134) [138], SHAPE SHOULDER: ON EVERY 8th (10th) [12th] row, decrease 1 st. 5x.

After Row 168 (180) [188], SHAPE ARMHOLE: For all sizes, bind off 47 sts. 1x, then 1 st. 3x (5x) [6x], 2 sts. 3x (3x) [4x], 3 sts. 2x.

After Row 186 (202) [214], bind off the remaining 140 sts.

36/38

(40/42)

[44/46]

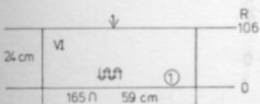
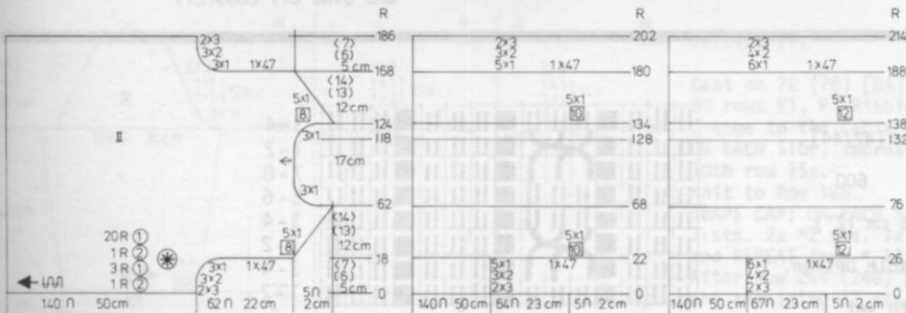

COLLAR: VI

Cast on 165 sts. with color 1 and work 106 rows K1, P1 Ribbing then bind off the crochet method for Ribbing.



Continued



HP 284



FRONT: I Make 1, reverse 1

Cast on 129 sts. with color 2 and work Stockinette stitch with REPEATED color stripes as shown on the Chart.
 SHAPE NECK, and AT THE SAME TIME, after Row 13, cast on 11 sts. for hem.
 FOR NECK, on every 2nd row, cast on 8 sts. 1x, 4 sts. 3x (3x) [4x], 3 sts. 5x (7x) [8x], 2 sts. 9x [7x] [5x].
 After Row 36, SHAPE SHOULDER: On every 8th (10th) [12th] row bind off 1 st. 5x and AT THE SAME TIME, after Row 66, bind off 39 sts. for pocket beginning with the 23rd st. counting from the LEFT (right for 2nd section).
 After Row 80 (82) [86], SHAPE ARM-HOLE: Bind off 47 sts. 1x, 1 st. 3x (5x) [6x], 2 sts. 3x (3x) [4x], 3 sts. 2x (2x) [2x].
 After Row 98 (104) [112], bind off the remaining 140 sts.

36/38

(40/42)

[44/46]

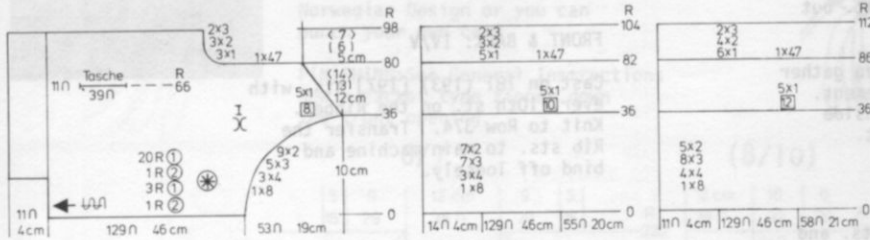

SLEEVE: III

Cast on 143 sts. with color 2 and work Stockinette stitch with REPEATED color stripes as shown on the Chart.
 Leave 10 needles on the right in working position and put the remainder into holding position.
 Work SHORT ROWS and AT THE SAME TIME, SHAPE CAP OF SLEEVE.
 ON OPPOSITE SIDE OF CAM BOX, bring back into working position, 10 sts. 8x, 53 sts. 1x, and AT THE SAME TIME, FOR CAP, on every 4th row, cast on 4 sts. 1x, 3 sts. 3x (4x), [5x], 2 sts. 7x, 1 st. 9x.
 Knit to Row 134 (138) [142].
 SHAPE CAP and AT THE SAME TIME, work SHORT ROWS.
 FOR CAP: on every 4th row, bind off 1 st. 9x, 2 sts. 7x, 3 sts. 3x (4x) [5x], 4 sts. 1x, and after Row 222, (230) [238], ON OPPOSITE SIDE OF CAM BOX, put into holding position 53 sts. 1x, 10 sts. 8x. After Row 242 (250) [258], bring all the needles back into working position and bind off LOOSELY.

36/38

(40/42)

[44/46]

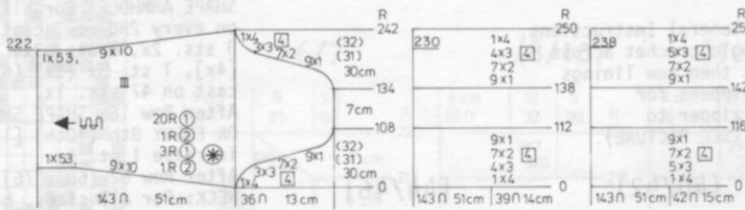

HP 285

MAN'S PULLOVER

SIZES: 34/36 (38/40) [42/44]
 YARN: Fortissima
 GRAMS: 500 550 600
 TENSION: 6 to 8
 GAUGE: 15 sts. 20 rows = 5 cm (2")

Stockinette stitch and Cable Design.
 Bands are 1 x 1 Ribbing.
 Follow the Line Drawing to set up the needles for the Cable Design.

FINISHING: See General Instructions.

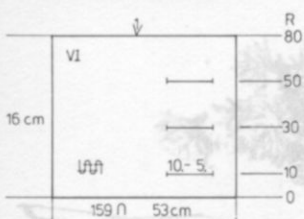
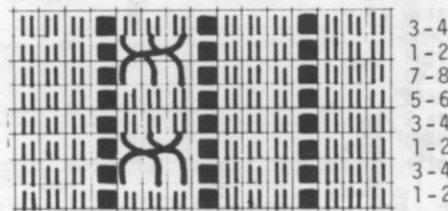

COLLAR: VI

Cast on 159 sts. and work K1, P1 Ribbing.
 MAKE BUTTONHOLES over needles 5 to 10 counting from the RIGHT after the rows shown on the the Chart. After Row 80, bind off the crochet method for Ribbing.

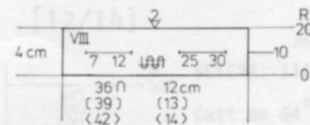

FRONT BAND: VIII

Cast on 36 (39) [42] sts. and work K1, P1 Ribbing.
 After Row 10, MAKE BUTTONHOLES over needles 7 to 12 and 25 to 30, counting from the LEFT edge. After Row 20, bind off the crochet method for Ribbing.
 Make another band the same but omit Buttonholes.

Cast on 144 (156) [168] sts. and work 20 rows K1, P1 Ribbing. Change to the Cable Design. Knit to Row 176. SHAPE ARMHOLE: ON EACH SIDE, bind off

3 sts. 1x, 2 sts. 3x, 1 st. 6x. (3 sts. 2x, 2 sts. 3x, 1 st. 6x). [3 sts. 2x, 2 sts. 4x, 1 st. 7x]. Knit to Row 256 (260) [264].

Bind off the center 24 sts., put the needles on the left into holding position and complete the right half first.

*SHAPE SHOULDER AND NECK AT THE SAME TIME.

FOR SHOULDER, bind off

6 sts. 5x.

(6 sts. 2x, 7 sts. 3x).

[6 sts. 4x, 7 sts. 1x].

FOR NECK, on all sizes, bind off

5 sts. 3x.

Bring the needles on the left into working position, knit 1 row to the left side, turn the Row Counter back to 256 (260) [264] and complete the left half. Follow the instructions from *.

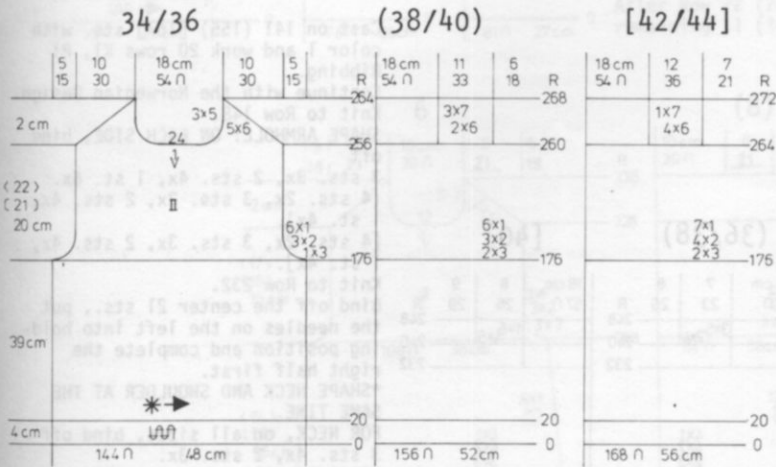

FRONT: I

Work the front the same as the back to Row 176.

Bind off the center 12 sts., put the needles on the left into holding position and complete the right half first.

*SHAPE ARMHOLE same as the back then knit to Row 224 (228) [232]. ON NECK SIDE, for all sizes, bind off 3 sts. 3x, 2 sts. 3x, 1 st. 6x and SHAPE SHOULDER same as the back after Row 256 (260) [264].

Bring the needles on the left into working position and complete the left half. Follow the instructions from *.

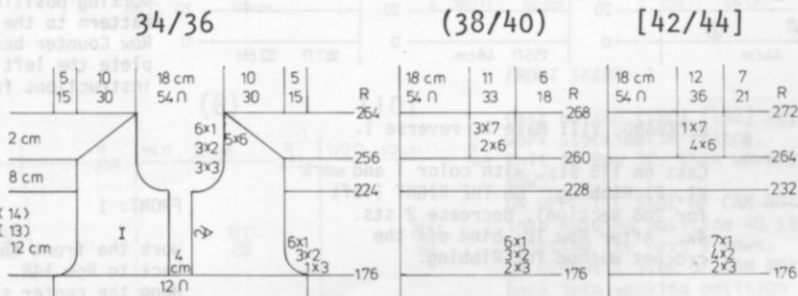

34/36 (38/40) [42/44]

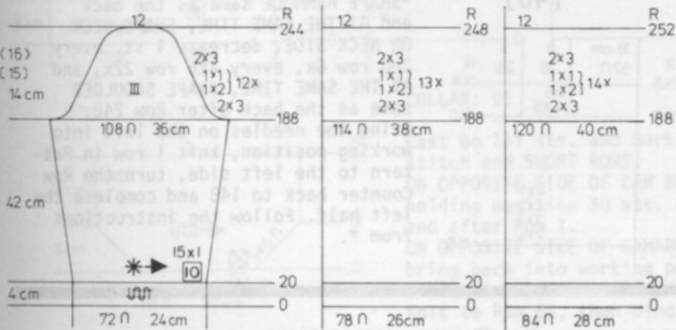

SLEEVE: III

Cast on 72 (78) [84] sts. and work 20 rows K1, P1 Ribbing.

Change to the Cable Design.

ON EACH SIDE, increase 1 st. every

10th row 15x.

Knit to Row 188.

SHAPE CAP: ON EACH SIDE, BIND OFF

3 sts. 2x *2 sts. 1x, 1 st. 1x,

and REPEAT from * 11x (12x) [13x] more.

After Row 244 (248) [252], bind off

the remaining 12 sts.



HP 286

MAN'S PULLOVER

SIZES: 32/34 (36/38) [40]

YARN: Crocus

GRAMS:

color 1 200 250 300
color 2 200 200 250

TENSION: 5 to 7

GAUGE: 16 sts. 20 rows = 5 cm (2")

A Norwegian Design in two colors. Follow the Line Drawing or you can punch your own card. Bands are K1, P1 Ribbing.

FINISHING: See General Instructions.

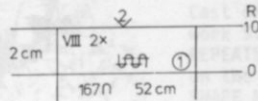

ARMBANDS: VIII Make 2.

Cast on 167 sts. with color 1 and work 10 rows K1, P1 Ribbing, then bind off the crochet method for Ribbing.

BACK: II

Cast on 141 (155) [167] sts. with color 1 and work 20 rows K1, P1 Ribbing.

Continue with the Norwegian Design. Knit to Row 148.

SHAPE ARMHOLE: ON EACH SIDE, bind off

3 sts. 3x, 2 sts. 4x, 1 st. 6x. (4 sts. 2x, 3 sts. 2x, 2 sts. 4x, 1 st. 4x).

[4 sts. 2x, 3 sts. 3x, 2 sts. 4x, 1 st. 4x].

Knit to Row 232.

Bind off the center 21 sts., put the needles on the left into holding position and complete the right half first.

*SHAPE NECK AND SHOULDER AT THE SAME TIME.

FOR NECK, on all sizes, bind off 3 sts. 4x, 2 sts. 3x.

FOR SHOULDER, after Row 240, bind off

3 sts. 1x, 4 sts. 4x.

(4 sts. 2x, 5 sts. 3x).

[5 sts. 4x, 6 sts. 1x].

Bring the needles on the left into working position, knit 1 row in Pattern to the left side, turn the

Row Counter back to 232 and complete the left half. Follow the instructions from *

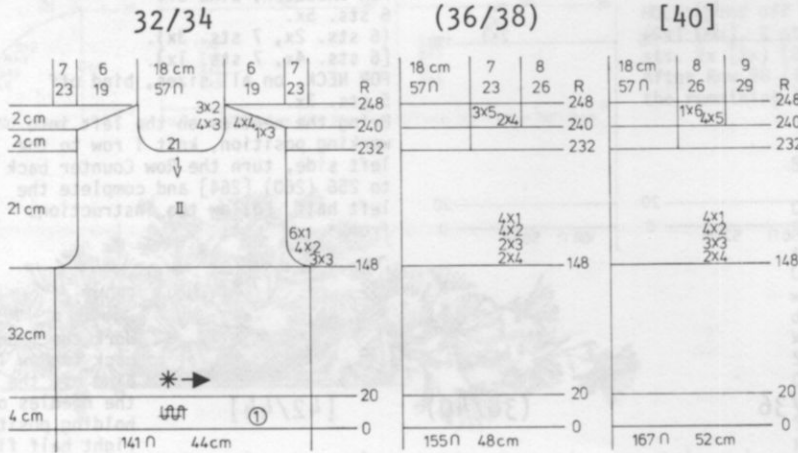

NECKBAND: VIII Make 1, reverse 1.

Cast on 115 sts. with color 1 and work K1, P1 Ribbing. ON THE RIGHT (left for 2nd section), decrease 2 sts. 4x. After Row 10, bind off the crochet method for Ribbing.

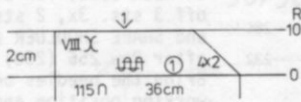

FRONT: I

Work the front the same as the back to Row 148.

Hang the center st. onto its neighboring needle, put the needles on the left into holding position and complete the right half first.

*SHAPE ARMHOLE same as the back and AT THE SAME TIME, SHAPE NECK.

ON NECK SIDE, decrease 1 st. every 2nd row 6x, every 4th row 22x, and

AT THE SAME TIME, SHAPE SHOULDER same as the back after Row 240.

Bring the needles on the left into working position, knit 1 row in Pattern to the left side, turn the Row Counter back to 148 and complete the left half. Follow the instructions from *.

32/34

(36/38)

[40]

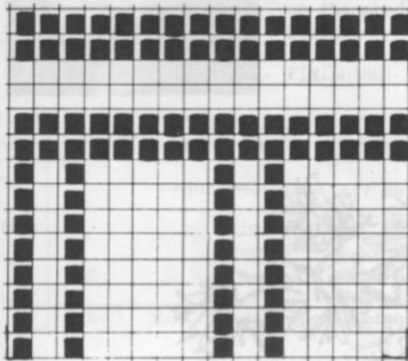
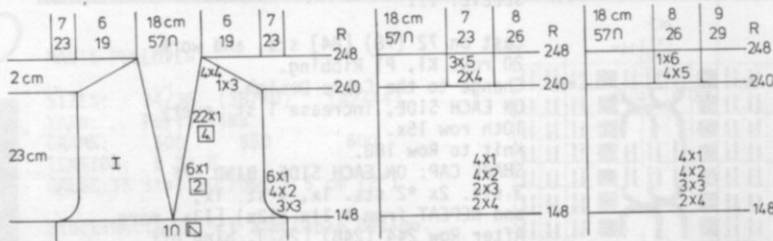

■ color 1 □ color 2

KK 287

GIRL'S DRESS

SIZES: 6 (8) [10]

YARN: Allegro

GRAMS: 400 450 500

TENSION: 5 to 7

GAUGE: 15 sts. 20 rows = 5 cm (2")

Stockinette stitch.

FINISHING: See General Instructions. Make tuck in front bodice, fold over front facing, then sew to skirt section. Make 4 carriers at waistline, then make cord for belt.

CORD: Cast on 3 or 4 sts. Set your machine for knitting a cord.

Make cord long enough to go around waistline and tie in bow.



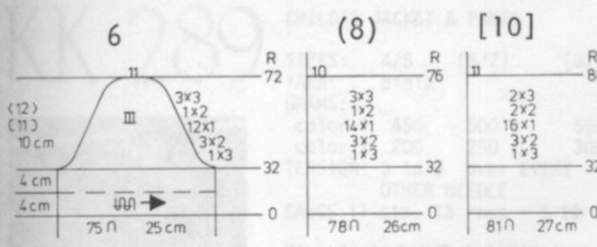

SLEEVE: III

Cast on 75 (78) [81] sts. and work Stockinette stitch.
 Knit to Row 32.
SHAPE CAP: ON EACH SIDE, bind off
 3 sts. 1x, 2 sts. 3x, 1 st. 12x
 (14x) [16x], 2 sts. 1x (1x) [2x],
 3 sts. 3x (3x) [2x].
 After Row 72 (76) [80], bind off the remaining 11 (10) [11] sts.

BACK: II

Cast on 168 (180) [192] sts. and work Stockinette stitch.
 Knit to Row 32, then work **SHORT ROWS**.
ON OPPOSITE SIDE OF CAM BOX, put into holding position, 40 sts. before knitting the next 2 rows.
ON OPPOSITE SIDE OF CAM BOX, bring back into working position, 8 sts. 5x ON EACH SIDE.
 After Row 44, **ON EACH SIDE, decrease 1 st. every 8th row 22x (22x) [20x], every 6th row 8x (12x) [16x].**
 Knit to Row 268 (284) [300].
SHAPE ARMHOLE: ON EACH SIDE, bind off
 3 sts. 3x, 2 sts. 4x, 1 st. 4x).
 [3 sts. 4x, 2 sts. 4x, 1 st. 4x].
 Knit to Row 328 (348) [368].
 Bind off the center 12 sts., put the needles on the left into holding position and complete the right half first.
***SHAPE SHOULDER AND NECK AT THE SAME TIME.**
FOR SHOULDER, bind off (all sizes) 4 sts. 4x, 5 sts. 1x.
FOR NECK, on all sizes, bind off 3 sts. 3x.
 Move the Cam Box to the left side, turn the Row Counter back to 328 (348) [368] and complete the left half. Follow the instructions from *.

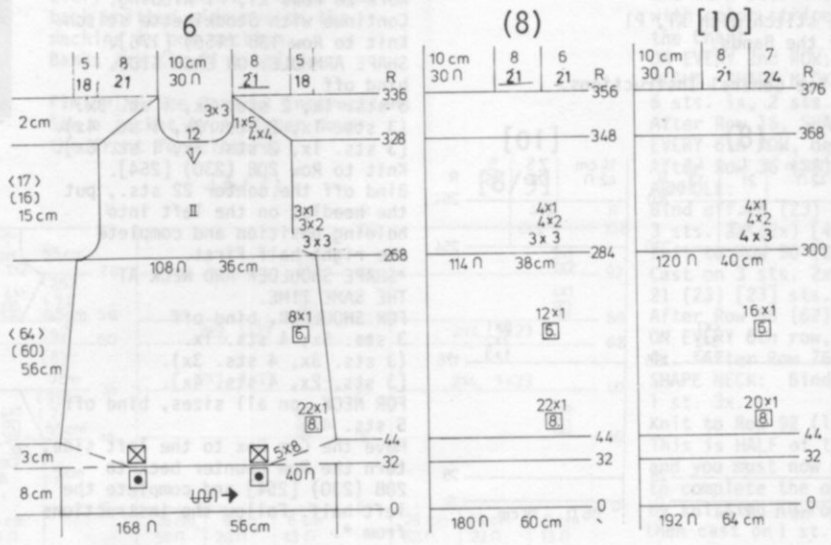

FRONT SKIRT: I

Cast on 168 (180) [192] sts. and work Stockinette stitch.
 Knit to Row 32, then work **SHORT ROWS**:
ON OPPOSITE SIDE OF CAM BOX, put into holding position 40 sts. before knitting the next 2 rows.
ON OPPOSITE SIDE OF CAM BOX, bring back into working position 8 sts. 5x ON EACH SIDE.
 After Row 44, **ON EACH SIDE, decrease 1 st. every 8th row 16x (15x) [14x], every 6th row 14x (18x) [22x].**
 After Row 256 (272) [288], bind off the remaining 108 (114) [120] sts.

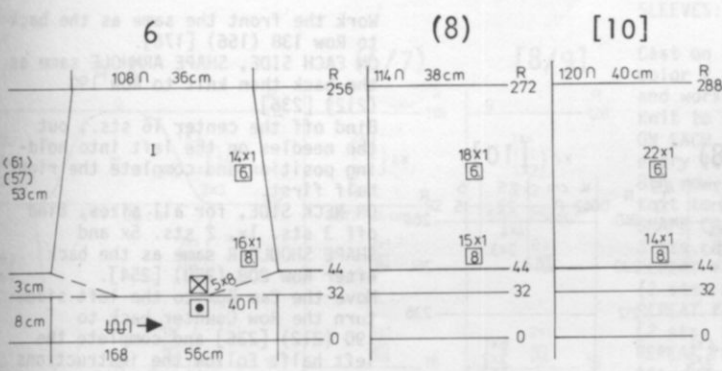

COLLAR: VI

Cast on 111 sts. and work Stockinette stitch and **SHORT ROWS**.
ON OPPOSITE SIDE OF CAM BOX, put into holding position 30 sts. at Row 0 and after Row 1.
ON OPPOSITE SIDE OF CAM BOX, bring back into working position, 6 sts. 5x ON EACH SIDE.
 Knit to Row 68, then bind off.

BODICE FRONT: I Make 1, reverse 1.

Cast on 54 (57) [60] sts. and work Stockinette stitch.
 Knit to Row 12, then with a separate yarn, cast on 30 sts. on the **LEFT** (right for 2nd section) side.
 Knit to Row 24.
SHAPE ARMHOLE: ON ARM SIDE, make the bind offs the same as the back.
 Knit to Row 64 (68) [72].
ON THE LEFT (right for 2nd section) side, put 35 needles into holding position. and complete the right half first.
***ON NECK SIDE; for all sizes, bind off (or you can put into holding position) 3 sts. 1x, 2 sts. 2x, 1 st. 3x.**
 After Row 84 (88) [92], **SHAPE SHOULDER same as the back **.**
 Bring the needles on the left into working position, bind off 16 neck sts - OR if you put the 10 neck sts. in holding, plus the **NEXT 16 sts.** Knit 1 row to the left side, turn the Row Counter back to 64 (68) [72] and complete the left half. Follow the instructions from * to **.

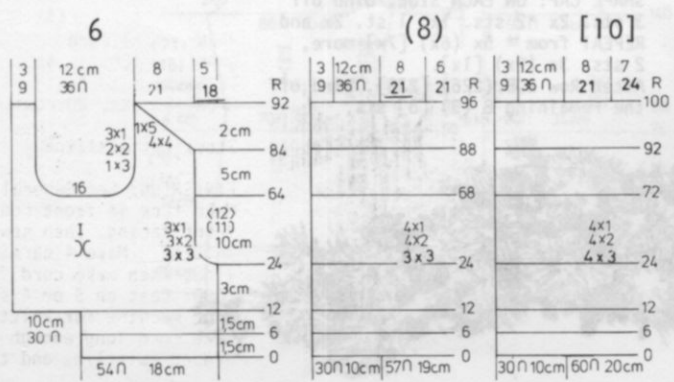
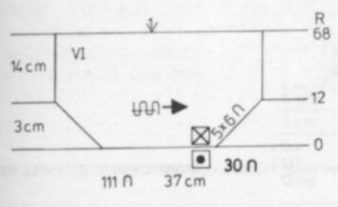

KK 288



CHILD'S PULLOVER

SIZES: 6 (8) [10]
YARN: Vienna
GRAMS: 250 300 350
TENSION: 4 to 6
GAUGE: 15 sts. 23 rows = 5 cm (2")

Stockinette stitch with K1, P1
 Ribbing for the Bands.

FINISHING: See General Instructions.

BACK: II

Cast on 104 (110) [116] sts. and work 28 rows K1, P1 Ribbing. Continue with Stockinette stitch. Knit to Row 138 (156) [176]. **SHAPE ARMHOLE: ON EACH SIDE,** bind off

3 sts. 1x, 2 sts. 3x, 1 st. 3x. (3 sts. 1x, 2 sts. 3x, 1 st. 4x). [3 sts. 1x, 2 sts. 3x, 1 st. 6x]. Knit to Row 208 (230) [254]. Bind off the center 22 sts., put the needles on the left into holding position and complete the right half first.

***SHAPE SHOULDER AND NECK AT THE SAME TIME.**

FOR SHOULDER, bind off

3 sts. 5x, 4 sts. 1x. (3 sts. 3x, 4 sts. 3x). [3 sts. 2x, 4 sts. 4x].

FOR NECK, on all sizes, bind off 5 sts. 4x.

Move the Cam Box to the left side, turn the Row Counter back to 208 (230) [254] and complete the left half. Follow the instructions from *.

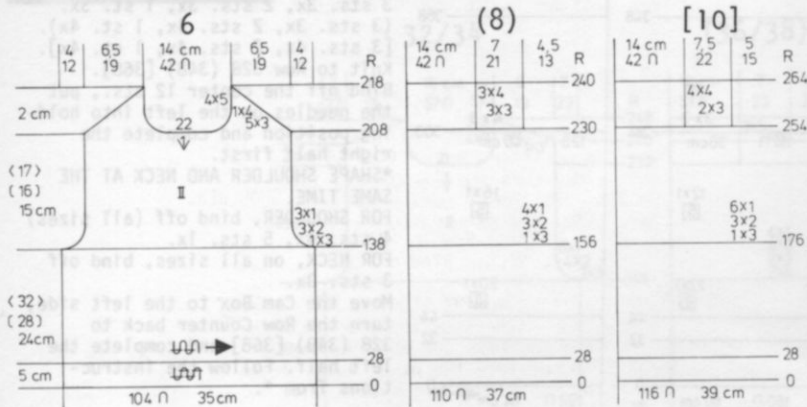

COLLAR: VI

Cast on 117 sts. and work 68 rows K1, P1 Ribbing then bind off the crochet method for Ribbing.

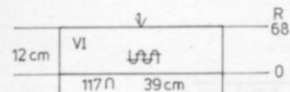

FRONT: I

Work the front the same as the back to Row 138 (156) [176].

ON EACH SIDE, SHAPE ARMHOLE same as the back then knit to Row 190 (212) [236].

Bind off the center 16 sts., put the needles on the left into holding position and complete the right half first.

ON NECK SIDE, for all sizes, bind off 3 sts. 1x, 2 sts. 5x and **SHAPE SHOULDER** same as the back after Row 208 (230) [254].

Move the Cam Box to the left side, turn the Row Counter back to 190 (212) [236] and complete the left half. Follow the instructions from *.

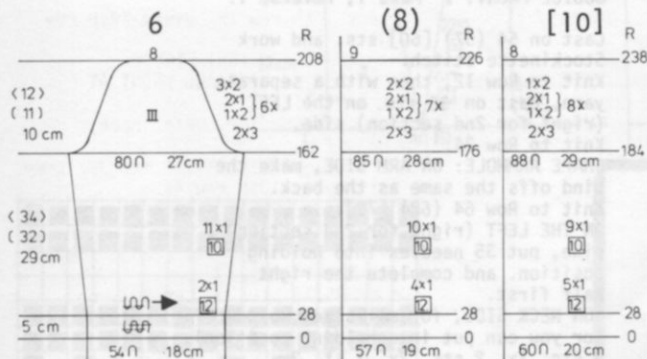
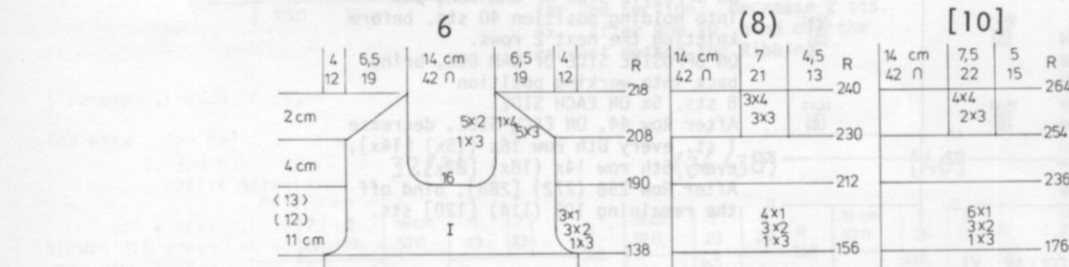

SLEEVE: III

Cast on 54 (57) [60] sts. and work 28 rows K1, P1 Ribbing. Continue with Stockinette stitch. **ON EACH SIDE, increase 1 st. every 12th row 2x (4x) [5x], every 10th row 11x (10x) [9x].**

Knit to Row 162 (176) [184]. **SHAPE CAP: ON EACH SIDE, bind off** 3 sts. 2x *2 sts. 1x, 1 st. 2x and **REPEAT** from * 5x (6x) [7x] more, 2 sts. 3x (2x) [1x].

After Row 208 (226) [238], bind off the remaining 8 (9) [8] sts.



KK 289

CHILD'S JACKET & PANTS

SIZES: 4/5 (6/7) [8/9]

YARN: Binia

GRAMS:

color 1 450 500 550
color 2 200 250 300

TENSION: 3 to 5 over EVERY

OTHER NEEDLE

GAUGE: 11 sts. 15 rows = 5 cm (2")

Stockinette stitch knitted over every other needle. Front and back knitted sideways on the machine in one section. Bands are K1, P1 Ribbing.

FINISHING: See General Instructions
Sew a jacket type zipper down the front for closure.



BACK & FRONT: I/II

Cast on 71 (78) [84] sts. with color 2 over EVERY OTHER NEEDLE and work Stockinette stitch with color stripes as shown on the Chart.

ON EVERY 2nd ROW, on the RIGHT, SHAPE NECK: cast on 6 sts. 1x, 2 sts. 2x, 1 st. 3x. After Row 16, SHAPE SHOULDER. ON EVERY 6th ROW, decrease 1 st. 4x. After Row 36 (38) [40], SHAPE ARMHOLE:
Bind off 21 (23) [23] sts. 1x, 3 sts. 2x (2x) [4 sts. 2x].
Knit to Row 50 (56) [62].
Cast on 3 sts. 2x (2x) [4 sts. 2x], 21 (23) [23] sts. 1x.
After Row 56 (62) [68] SHAPE SHOULDER.
ON EVERY 6th row, cast on 1 st. 4x. After Row 76 (84) [92] SHAPE NECK: Bind off 2 sts. 1x, 1 st. 3x.
Knit to Row 92 (100) [108].
This is HALF of the front & back and you must now work BACKWARDS to complete the other half. Begin by knitting 10 rows straight, then cast on 1 st. 3x, 2 sts. 1x, etc.

4/5

(6/7)

[8/9]

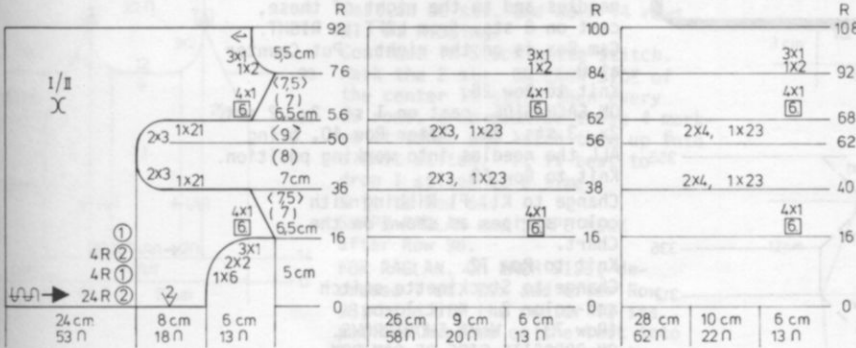

SLEEVES: III

Cast on 35 (37) [39] sts. with color 2 over EVERY OTHER NEEDLE and work Stockinette stitch. Knit to Row 16, then hang the hem. ON EACH SIDE, increase 1 st. every 10th row 1x (6x) [2x], every 8th row 7x (2x) [6x]. Knit to Row 82 (92) [100].
SHAPE CAP: ON EACH SIDE, bind off 3 sts. 2x *1 st. 1x, 2 sts. 1x, and REPEAT from * 3x more, 3 sts. 1x. (2 sts. 2x, *1 st. 1x, 2 sts. 1x, and REPEAT from * 3x, more, 3 sts. 2x). [2 sts. 2x, *2 sts. 1x, 1 st. 1x and REPEAT from * 4x more, 4 sts. 1x]. After Row 104 (116) [126], bind off the remaining 9 sts.

PANTS:

FRONT & BACK: XI Make 1, reverse 1.
Cast on 82 (86) [90] sts. with color 1 over EVERY OTHER NEEDLE. Work Stockinette stitch. Knit to Row 30. ON EACH SIDE, decrease 1 st. every 8th row 3x, every 6th row 3x. (every 10th row 2x, every 8th row 4x). [every 16th row 1x, every 14th row 4x].
Knit to Row 78 (86) [100]. SHAPE CENTER BACK AND FRONT AT THE SAME TIME. ON ALL SIZES, for Center back, bind off 3 sts. 1x, 2 sts. 3x, 1 st. 5x, then 1 st. every 10th row 4x. FOR CENTER FRONT, bind off 2 sts. 2x, 1 st. 4x. Knit to Row 172 (194) [228], then work SHORT ROWS. ON OPPOSITE SIDE OF CAM BOX, on every 2nd row, put into holding position 15 sts. 3x. Bring all the needles back into working position before knitting the next row. Knit to Row 194 (216) [250], then bind off. Work the 2nd section with reverse shaping, casting on from RIGHT to LEFT. Cam Box will be on the LEFT side at Row 0.

4/5

(6/7)

[8/9]

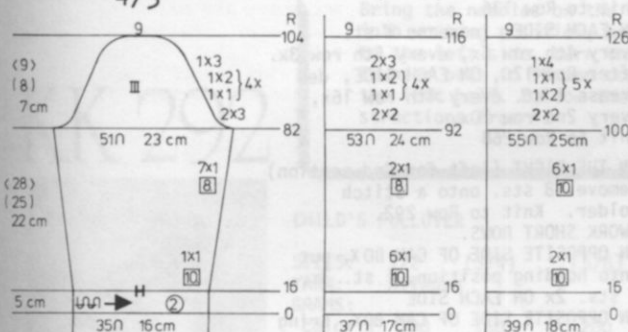

4/5

(6/7)

[8/9]

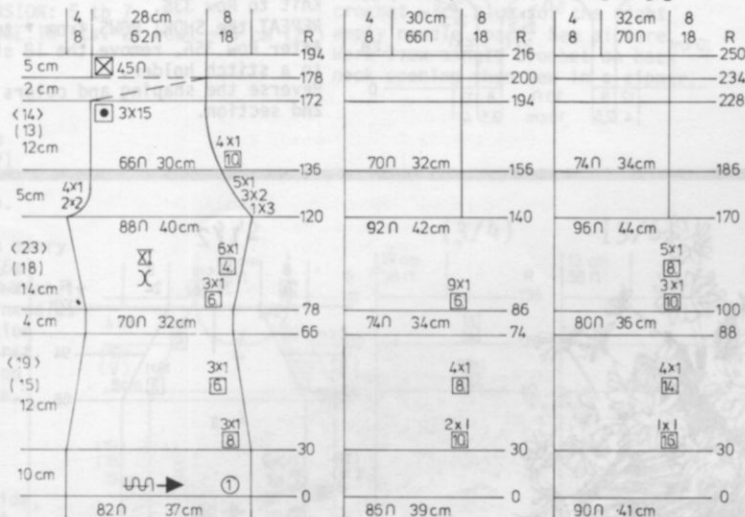

Continued



KK 289

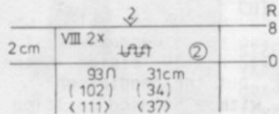

FRONT BANDS: VIII Make 2. Use TENSION 10 and work K1, P1 Ribbing with every 2nd needle on main machine and every needle on the Ribber.

Cast on 93 (102) [111] sts. with color 2 and work 8 rows K1, P1 Ribbing, then bind off the crochet method for Ribbing.

NECKBAND: VIII
Use Tension 10 and work K1, P1 Ribbing with every 2nd needle on the main machine and every needle on the Ribber.

Cast on 73 sts. with color 2 and work 8 rows K1, P1 Ribbing then bind off the crochet method for Ribbing.

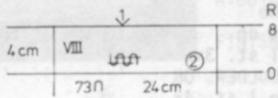

FRONT & BACK: XI Make 1, reverse 1 and REVERSE the COLORS (See picture).

Directly to the LEFT of the center 30 needles, cast on 8 sts. with color 1 from RIGHT TO LEFT. Put Counter at 0. Cam Box is on the LEFT side.

Work in Stockinette stitch. Knit to Row 28.

ON EACH SIDE, cast on 1 st. 2x, 2 sts. 2x, 3 sts. 2x. Knit 1 row to the RIGHT. Cast on 6 sts., break yarn. Put these 6 sts. plus all the sts. to the left of these into holding position. Directly to the right of the holding needles, leave 12 empty needles and to the right of these, cast on 8 sts. from LEFT to RIGHT. Cam Box is on the right. Put Counter at 0.

Knit to Row 28.

ON EACH SIDE, cast on 1 st. 2x, 2 sts. 2x, 3 sts. 2x. After Row 40, bring ALL the needles into working position. Knit to Row 60.

Change to K1, P1 Ribbing with color stripes as shown on the Chart.

Knit to Row 72.

Change to Stockinette stitch and color 2. Knit 1 row (Row 73). Work SHORT ROWS.

ON OPPOSITE SIDE OF CAM BOX, bring 45 sts. into holding position, then on every 2nd row, ON OPPOSITE SIDE OF CAM BOX, bring back into working position, 15 sts. 3x.

Knit to Row 136.

ON EACH SIDE, increase 1 st. every 4th row 6x, every 6th row 3x. After Row 176, ON EACH SIDE, decrease 1 st. every 4th row 16x, every 2nd row 10x.

Knit to Row 268

ON THE RIGHT (left for 2nd section) remove 18 sts. onto a stitch holder. Knit to Row 292.

*WORK SHORT ROWS.

ON OPPOSITE SIDE OF CAM BOX, put into holding position, 1 st. 3x, 2 sts. 2x ON EACH SIDE

ON OPPOSITE SIDE OF CAM BOX, bring back into working position, 2 sts. 2x, 1 st. 3x ON EACH SIDE**. Knit to Row 336.

REPEAT the SHORT ROWS from * to **. After Row 356, remove the 18 sts. onto a stitch holder. Reverse the shaping and colors for 2nd section.

KK 290



BABY COVERALLS

SIZE: Infant
YARN: Allegro
GRAMS:
color 1 100
color 2 100
color 3 few yards.
TENSION: 4 to 6
GAUGE: 15 sts. 20 rows = 5 cm (2")

Stockinette stitch, reversing the colors for each section. Waistband, K1, P1 Ribbing with color stripes as shown on the Chart.

FINISHING: See General Instructions. Weave the 18 sts. held on stitch holders then sew leg and front and back seams. Work 1 row single crochet around all edges. Make 2 loops on front shoulder straps and sew buttons to back straps.

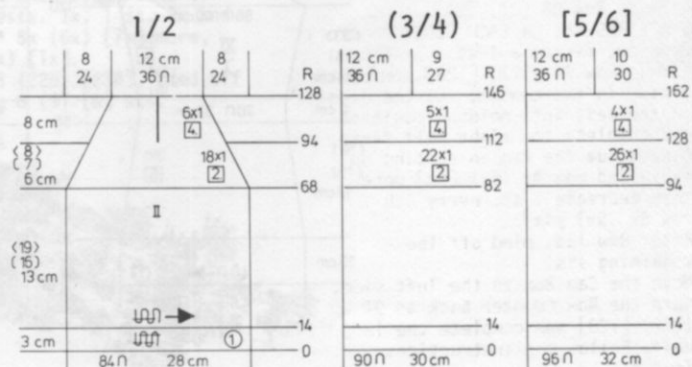
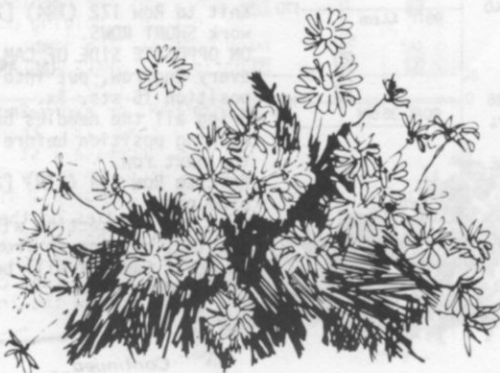
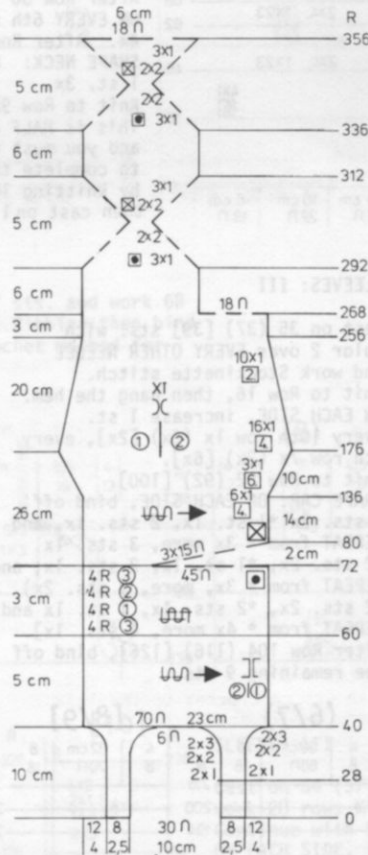

KK 291



BABY PULLOVER

SIZE: 6 to 9 months
 YARN: Allegro
 GRAMS: 150
 TENSION: 5 to 7
 GAUGE: 15 sts. 21 rows = 5 cm (2")

Stockinette stitch with K1, P1 Ribbing for the Bands. The front section has 2 sts. on each side in stockinette stitch on the Purl side. Flowers are embroidered on the front section.

FINISHING: See General Instructions. Embroider flowers on the front section (See picture).

6 to 9 months

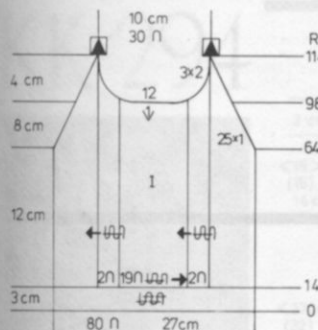

FRONT: I

Cast on 80 sts. and work 14 rows K1, P1 Ribbing. Continue in Stockinette stitch. Mark the 2 sts. ON EACH SIDE of the center 19 sts., then every 20 rows, drop each of these 4 marked stitches and latch them up into a knit stitch. It is best to drop 1 stitch at a time. Knit to Row 64.

SHAPE RAGLAN and SHAPE NECK after Row 98.

FOR RAGLAN, ON EACH SIDE, decrease 1 st. 25x and after Row 98, bind off the center 12 sts., put the needles on the left into holding position and complete the right half first.

*Continue the RAGLAN SHAPING and ON NECK SIDE, bind off 2 sts. 3x. After Row 114, hang the remaining sts. together and bind off. Bring the needles on the left into working position, knit 1 row to the left side, turn the Row Counter back to 98 and complete the left half. Follow the instructions from *.

6 to 9 months

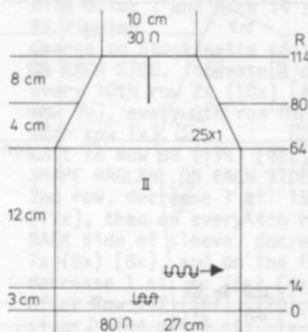

BACK: II

Cast on 80 sts. and work 14 rows K1, P1 Ribbing. Continue in Stockinette stitch. Knit to Row 64.

SHAPE RAGLAN: ON EACH SIDE, on every 2nd row, decrease 1 st. 9x, and after Row 80, divide in the center, put the needles on the left into holding position and complete the right half first.

*Continue the RAGLAN SHAPING on arm side 16x more.

After Row 114, bind off the remaining sts. Move the Cam Box to the left side, turn the Row Counter back to 80 and complete the left half. Follow the instructions from *.

NECKBAND: VIII

Cast on 87 sts. and work 12 rows Stockinette stitch then bind off.

SLEEVE: III

Cast on 44 sts. and work 14 rows K1, P1 Ribbing.

Continue in Stockinette stitch. ON EACH SIDE, increase 1 st. every 10th row 5x.

Knit to Row 64.

SHAPE RAGLAN: ON EACH SIDE, on every 2nd row, decrease 1 st. 19x, every 4th row, 1 st. 3x. After Row 114, bind off the remaining 10 sts.

KK 292



CHILD'S PULLOVER

SIZES: 1/2 (3/4) [5/6]
 YARN: Allegro
 GRAMS:
 color 1 100 150 200
 color 2 50 50 50
 color 3 50 50 50
 TENSION: 5 to 7
 GAUGE: 15 sts. 21 rows = 5 cm (2")

Stockinette stitch with color stripes on the front section. Bands are K1, P1 Ribbing.

FINISHING: See General Instructions.

On the front section, with red, slip stitch crochet up the left empty needle space, and slip st. crochet with blue for the right empty needle space. See picture. Work 1 row single crochet on back neck opening then sew in a zipper.

BACK: II

Cast on 84 (90) [96] sts. with color 1 and work 14 rows K1, P1 Ribbing.

Continue in Stockinette stitch. Knit to Row 68 (82) [94].

SHAPE RAGLAN: ON EACH SIDE, on every 2nd row, decrease 1 st. 14x (16x) [18x] Row 94 (112) [128], immediately divide in the center, put the needles on the left into holding position and complete the right half first.

* Continue the Raglan shaping on every 2nd row 4x (6x) [8x] more, then decrease 1 st. every 4th row 6x (5x) [4x].

After Row 128, bind off the remaining sts.

Move the Cam Box to the left side, turn the Row Counter back to 94 (112) [128] and complete the left half. Follow the instructions from *.

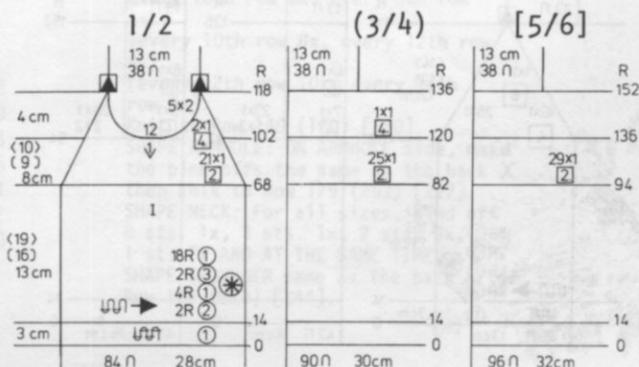

FRONT: I

Cast on 84 (90) [96] sts. with color 1 and work 14 rows K1, P1 Ribbing. Change to Stockinette stitch with REPEATED Color stripes as shown on the Chart and Transfer the specified sts. as shown on the Line Drawing to the next needle and push the empty needles to the out of work position and leave them there. Be sure you center the needle set up (the triangle above the line drawing shows the center).

Knit to Row 68 (82) [94].

SHAPE RAGLAN: ON EACH SIDE, on every 2nd row, decrease 1 st. 18x (20x) [22x] (Do not knit after the last decrease), but

SHAPE NECK: Bind off the center 12 sts., put the needles on the left into holding position and complete the right half first. *Continue to SHAPE RAGLAN AND NECK AT THE SAME TIME.

FOR RAGLAN, on every 2nd row, decrease 1 st. 3x (5x) [7x], then on every 4th row, decrease 1 st. 2x (1x) [0x] and FOR NECK, on every 2nd row, bind off 2 sts. 5x for all sizes.

Bring the needles on the left into working position, knit 1 row to the left side, turn the Row Counter back to 102 (120) [136] and complete the left half. Follow the instructions from *.

Continued



KK 292

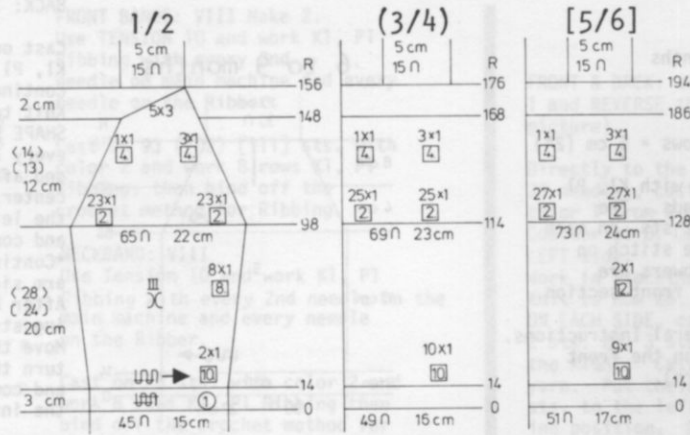

SLEEVE: III

Cast on 45 (49) [51] sts. with color 1 and work 14 rows K1, P1 Ribbing. Change to Stockinette stitch and ON EACH SIDE, increase 1 st. every 10th row 2x (10x) [9x], every 8th row 8x (0x) [every 12th row 2x]. Knit to Row 98 (114) [128]. SHAPE RAGLAN: ON EACH SIDE, decrease 1 st. every 2nd row 23x (25x) [27x] then on the BACK side of sleeve, decrease 1 st. every 4th row 3x (3x) [3x] and on the FRONT SIDE, decrease 1 st. every 4th row 1x (1x) [1x], and AT ROW 147 (167) [185] on the FRONT SIDE, bind off 3 sts. 5x.

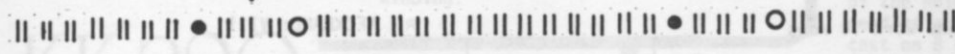

● color 1
○ color 2

NECKBAND: VIII

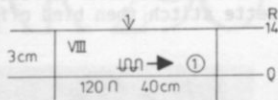

Cast on 120 sts. with color 1 and work 14 rows Stockinette stitch, then bind off.

KK 293

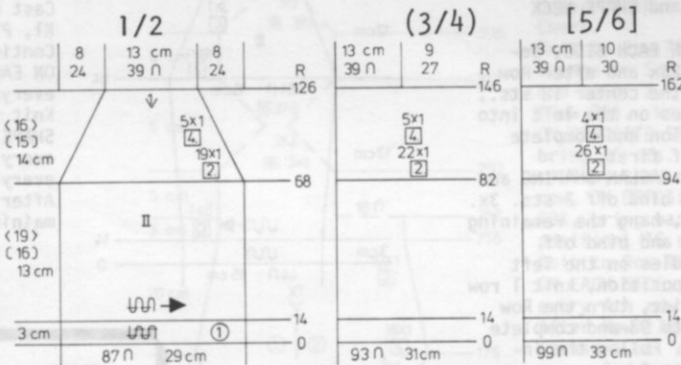

BACK: II

Cast on 87 (93) [99] sts. with color 1 and work 14 rows K1, P1 Ribbing. Change to Stockinette stitch. Knit to Row 68 (82) [94]. SHAPE RAGLAN: ON EACH SIDE, decrease 1 st. every 2nd row 19x (22x) [26x], every 4th row 5x (5x) [4x]. Knit to Row 126 (146) [162] then bind off the remaining 39 sts.

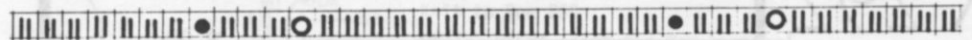

● color 1
○ color 2

CHILD'S CARDIGAN

SIZES: 1/2 (3/4) [5/6]
YARN: Allegro
GRAMS:
color 1 100 150 200
color 2 50 50 50
color 3 50 50 50
TENSION: 5 to 7
GAUGE: 15 sts. 21 rows = 5 cm (2")

Stockinette stitch with color stripes and out of work needles on the front section only. A plaid is formed by slip stitch crochet up the empty needle spaces. See picture. Bands are Ribbed-

FINISHING: See General Instructions. On the front section, single crochet up the 17th (empty needle spacing) and the 21st sts., the first with blue and the 2nd with red.

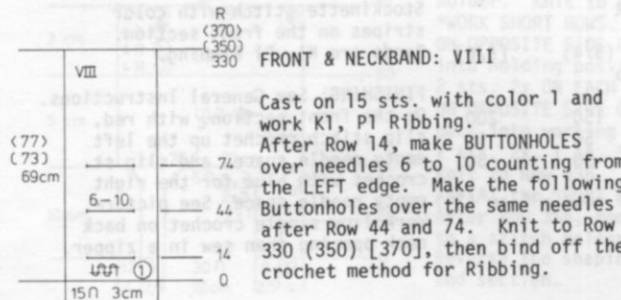

FRONT & NECKBAND: VIII
Cast on 15 sts. with color 1 and work K1, P1 Ribbing. After Row 14, make BUTTONHOLES over needles 6 to 10 counting from the LEFT edge. Make the following Buttonholes over the same needles after Row 44 and 74. Knit to Row 330 (350) [370], then bind off the crochet method for Ribbing.

FRONT: I Make 1, reverse 1.

Cast on 39 (42) [45] sts. with color 1 and work 14 rows K1, P1 Ribbing.

Change to Stockinette stitch with color stripes as shown on the Chart and counting from the LEFT (right for 2nd section) transfer the 17th and 21st stitches to the neighboring needle and push the empty needles to the out of work position and leave them there. Knit to Row 68 (82) [94]. SHAPE RAGLAN AND NECK AT THE SAME TIME.

FOR RAGLAN, on every 2nd row, decrease 1 st. 26x (2 sts. 1x, 1 st. 27x). [2 sts. 2x, 1 st. 28x]. FOR NECK, on every 4th row, decrease 1 st. 10x (7x) [5x], every 6th row 1x (4x) [6x]. After Row 118 (136) [152] hang the remaining sts. together and bind off.

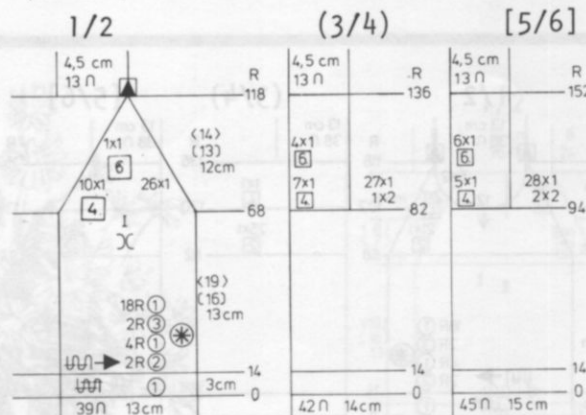

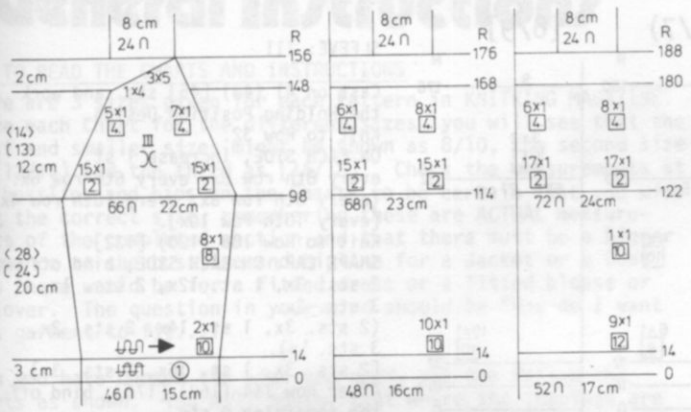

SLEEVE: III Make 1, reverse 1.

Cast on 46 (48) [52] sts. with color 1 and work 14 rows K1, P1 Ribbing. Change to Stockinette stitch. ON EACH SIDE, increase 1 st. every 10th row 2x (10x) [every 12th row 9x], every 8th row 8x (0x) [every 10th row 1x]. Knit to Row 98 (114) [122]. SHAPE RAGLAN: ON EACH SIDE, on every 2nd row, decrease 1 st. 15x (15x) [17x], then on every 4th row, on the BACK side of sleeve, decrease 1 st. 7x (8x) [8x], and on the FRONT SIDE, decrease 1 st. 5x (6x) [6x]. After Row 147 (167) [179], for all sizes, bind off 4 sts. 1x, 5 sts. 3x.

KK 294



GIRL'S COAT

SIZES: 4/5 (6/7) [8/9]
 YARN: Euro Sport
 GRAMS: 450 500 550
 TENSION: 8 to 10
 GAUGE: 12 sts. 20 rows = 5 cm (2") in Pattern.

A Holding Position Design that follows the Line Drawing. KNITTING machine owners use Wheel No. 2. Worn on the Pur1 side.

FINISHING: See General Instructions.

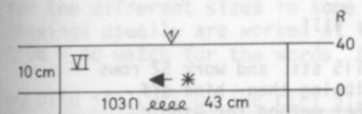

COLLAR: VI

Cast on 103 sts. and work 40 rows Holding Position Design, then bind off.

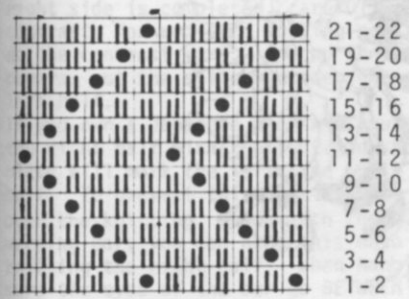

FRONT: I Make 1, reverse 1.

Cast on 60 (65) [70] sts. and work the Holding Position Design. Knit to Row 32. ON SIDE EDGE, decrease 1 st. every 10th row 6x, every 8th row 6x. (every 10th row 8x, every 12th row 4x). [every 12th row 10x, every 14th row 2x]. Knit to Row 140 (160) [180]. SHAPE ARMHOLE: ON ARMHOLE side, make the bind offs the same as the back then knit to Row 179 (203) [227]. SHAPE NECK: For all sizes, bind off 8 sts. 1x, 3 sts. 1x, 2 sts. 3x, 1 st. 7x AND AT THE SAME TIME, SHAPE SHOULDER same as the back after Row 196 (220) [244].

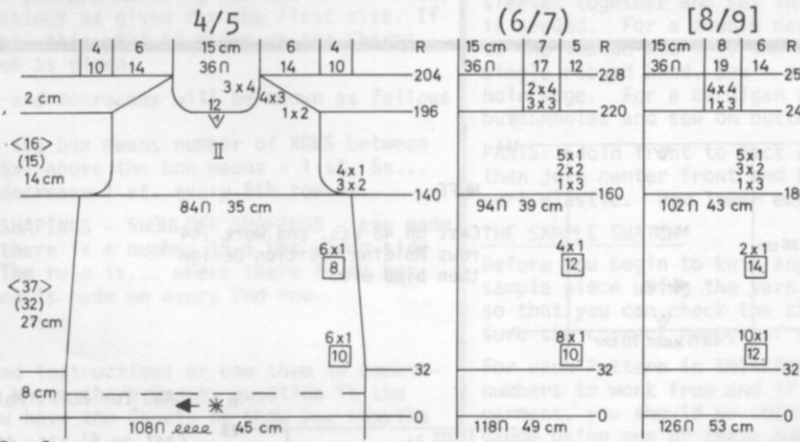

BACK: II

Cast on 108 (118) [126] sts. and work the Holding Position Design. Knit to Row 32. ON EACH SIDE, decrease 1 st. every 10th row 6x, every 8th row 6x. (every 10th row 8x, every 12th row 4x). [every 12th row 10x, every 14th row 2x]. Knit to Row 140 (160) [180]. SHAPE ARMHOLE: ON EACH SIDE, bind off 2 sts. 3x, 1 st. 4x. (3 sts. 1x, 2 sts. 2x, 1 st. 5x). [3 sts. 1x, 2 sts. 3x, 1 st. 5x]. Knit to Row 196 (220) [244]. Bind off the center 12 sts., put the needles on the left into holding position and complete the right half first. *SHAPE SHOULDER AND NECK AT THE SAME TIME. FOR SHOULDER, bind off 2 sts. 1x, 3 sts. 4x. (3 sts. 3x, 4 sts. 2x). [3 sts. 1x, 4 sts. 4x]. FOR NECK, on all sizes, bind off 4 sts. 3x. Bring the needles on the left into working position, knit 1 row in Pattern to the left side, turn the Row Counter back to 196 (220) [244] and complete the left half. Follow the instructions from *.

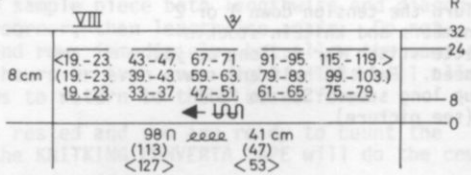

BUTTONHOLE BAND: VIII

Cast on 98 (113) [127] sts. and work 32 rows Stockinette stitch MAKING BUTTONHOLES after Rows 8 and 24 over the needles as shown on the Chart for your size. Bind off. Knit a second band but omit the Buttonholes.



Continued

KK 294

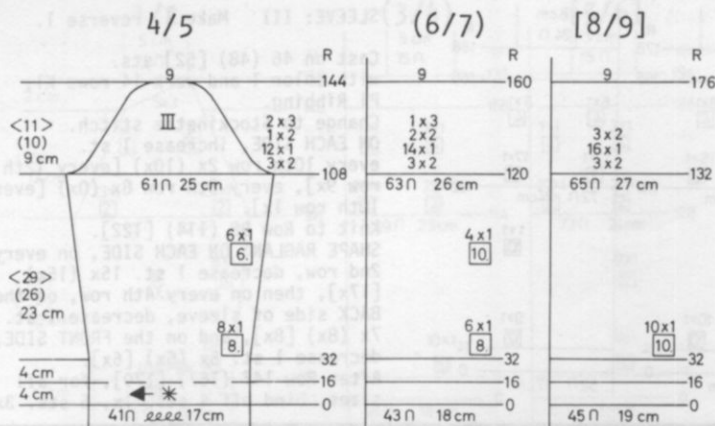

SLEEVE: III

Cast on 41 (43) [45] sts. and work the Holding Position Design. Knit to Row 32.
 ON EACH SIDE, increase 1 st. every 8th row 8x, every 6th row 6x. (every 8th row 6x, every 10th row 4x). [every 10th row 10x].
 Knit to Row 108 (120) [132].
 SHAPE CAP: ON EACH SIDE, bind off 2 sts. 3x, 1 st. 12x, 2 sts. 1x, 3 sts. 2x. (2 sts. 3x, 1 st. 14x, 2 sts. 2x, 3 sts. 1x).
 [2 sts. 3x, 1 st. 16x, 2 sts. 3x].
 After Row 144 (160) [176], bind off the remaining 9 sts.

KK 295



GIRL'S CAP & MUFF

SIZES: To go with KK 294
 YARN: Euro Sport
 GRAMS: 250
 TENSION: 8 to 10
 GAUGE: 12 sts. 15 rows = 5 cm (2") in Pattern.

A Holding Position Design worn on the Purl side. Follow the Line Drawing. KNITTING machine owners use Wheel No. 2. Bands are K1, P1 Ribbing. Strap for Muff: Stockinette stitch.

FINISHING: See General Instructions. Make Pom Pom for Hat. After sewing the Ribbing to the Muff, turn it to the inside. For the Strap, cast on 13 sts. Turn the tension down 1 or 2 numbers and knit in stockinette stitch for as long as you need. Fold in half and sew up long seam. Sew to Muff (see picture).

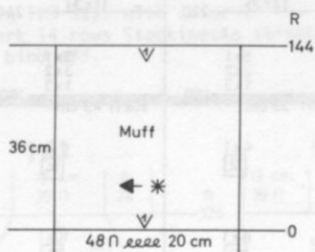

MUFF:

Cast on 48 sts. and work 144 rows Holding Position Design then bind off.

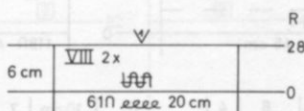

BAND for MUFF: Make 2.

Cast on 61 sts. and work 28 rows K1, P1 Ribbing then bind off the crochet method for Ribbing.



HAT:

Cast on 39 sts. and work 152 rows Holding Position Design then bind off.

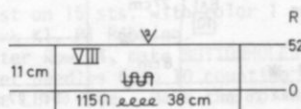

HAT BAND: VIII

Cast on 115 sts. and work 52 rows K1, P1 Ribbing then bind off the crochet method for Ribbing.

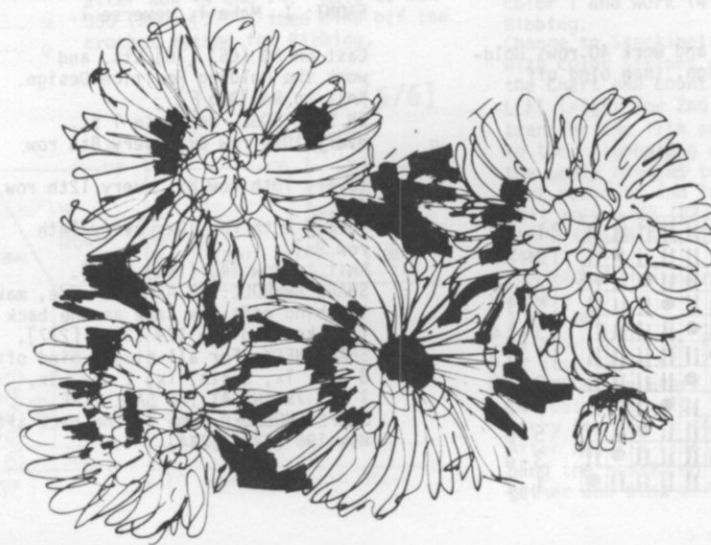
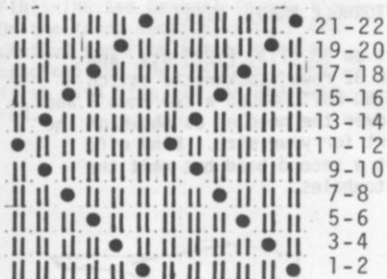

General Instructions

HOW TO READ THE CHARTS AND INSTRUCTIONS

There are 3 sizes given for each Pattern in KNITTING MAGAZINE. Above each Chart for the different sizes, you will see that the first and smaller sizes might be shown as 8/10, the second size as (12/14) and the third as [16/18]. Check the measurements at the bustline and hips on the Charts to be certain that you will knit the correct size, remembering these are ACTUAL measurements of the completed section and that there must be a bigger allowance at the bustline and hipline for a Jacket or a Coat than there would be for a fitted dress or a fitted blouse or pullover. The question in your mind should be "How do I want this garment to fit...?"

When you have chosen the size you need, you can follow the Charts as shown. You will notice that where the shapings are the same FOR ALL SIZES, only 1 set of shapings will be shown on the first Chart and if you are knitting the 2nd or 3rd size, you simply follow the shapings as given for the first size. If the shapings are different, this will be shown on the Charts and you should follow them as given.

On the Charts, increases and decreases will be shown as follows

$\begin{matrix} 5x1 \\ \boxed{6} \end{matrix}$ The number in the box means number of ROWS between the shapings, while the 5x1 above the box means - 1 st. 5x... so you will increase or decrease 1 st. every 6th row 5x.

ARMHOLE SHAPINGS - NECK SHAPINGS - SHOULDER SHAPINGS - are made on every 2nd row UNLESS there is a number in a box along side or below the shapings. The rule is... where there is no box with a number, the shaping is made on every 2nd row.

THE PRINTED INSTRUCTIONS

You can follow the printed instructions or use them in combination with the Charts. Where there is any question in the printed instructions, you have the Charts to show you how the section will look.

The 3 sizes, with the different amounts of cast on stitches and the different shapings will look like this...

Cast on 124 (136) [148] sts. You will
Cast on 124 sts. for the first size.
Cast on 136 sts. for the 2nd size.
Cast on 148 sts. for the 3rd size.

The important thing to remember is that you MUST READ AHEAD so that you KNOW what to do for the size you are knitting. Sometimes where the number of stitches are the same but the number of times different, you will find shapings like this...
3 sts. 1x (2x) [3x], 2 sts. 1x (2x) [3x], 1 st. 3x (4x) [5x].
As you see, you MUST read ahead in order to follow the instructions as given for YOUR SIZE. The rows will be different for the different sizes in some cases... Shoulder and Neck shapings usually are worked at the SAME TIME for the back section - so watch for the words AT THE SAME TIME.

HOLDING STITCHES ON THE LEFT SIDE WHILE SHAPING THE RIGHT SIDE

When knitting a section of garment in stockinette stitch, it is easy to hold the stitches on the left side while knitting the right half, but when knitting a Pattern Stitch such as a Norwegian Design, a Holding Position Design, Weaving, etc., you should use the following method. For the NECK SHAPING, we tell you to bind off the center sts., put the needles on the left into holding position and complete the right half first... so with a strand of contrast yarn, knit ALL of the left side stitches manually by hand, pulling each stitch back against the needle bed to the OUT OF WORK position. When the right side is completed, carefully pull the stitches held on contrast, forward into working position and as you do so, undo the contrast yarn, line up the needles (KNITTING machine owners, put the stitches under the sinkers) and complete the left half.

If you own a Japanese machine, you may find that when knitting the right half with the left side held in this way, the sinker plate will mark the left side while you are knitting the right half. To prevent this marking, you can tape a piece of paper over the knitting, underneath the sinkers, or if you own a Reversing Bar, you can hang this onto the Sinkers while you are knitting the right half. When hanging the Reversing Bar, be sure the eyes of the bar go BETWEEN the Sinker Posts on the upper part of the bar so that the tips of the bar only - show above the needle bed.

FULL FASHION DECREASING OR INCREASING

For Stockinette stitch, always use the Full Fashion method for increasing or decreasing.

TO DECREASE: Hang the 3rd stitch onto the 2nd stitch then move the stitches in to fill the empty needle.

TO INCREASE: Move the 2 end stitches 1 needle outward, then pick up the 3rd stitch from the row below and hang it onto the empty needle.

NORWEGIAN DESIGNS:

In the instructions, each row of the Norwegian Design is counted as 1 row but several movements of the Cam Box (or Slide) are needed to complete 1 row.

NORWEGIAN DESIGN WHEN USING THE PATTERN READER

When you use the Pattern Reader and knit a Norwegian Design using several colors, it is necessary to move the Trip Control Lever so that only 1 row registers.

FINISHING: Block all sections. For PULLOVERS, JACKETS, and DRESSES: Join front to back at sides and shoulders. Sew sleeves together and set in. Hem lower edge and sleeve edges if needed. For a double neckband or armhole band, sew 1 edge to the inside and 1 to the outside of neck or armhole. For a single ribbed band, sew 1 edge to the outside of neck or armhole edge. For a cardigan or jacket with buttonholes, finish buttonholes and sew on buttons.

PANTS: Join front to back at sides. Sew inside leg seams, then join center front and back. Make hem at waistline and insert elastic. Hem lower edge of pants legs.

THE SAMPLE SWATCH

Before you begin to knit any garment, you will need to knit a sample piece using the yarn you have chosen for your garment, so that you can check the stitch and row gauge which must measure the correct number of stitches and rows in 5 cm (2 inches).

For each Pattern in KNITTING MAGAZINE, we give you 3 tension numbers to work from and if you use the specified yarn for the garment, you should be able to get the correct stitch and row gauge using one of these numbers. Here is a very easy way to make your sample swatch and count the stitches and rows without actually counting, by using our KNITTING Converta Tape.

Supposing the Tension Numbers for the Stitch and Row Gauge are given as 5 to 7. Set the Tension Dial to the first number which is 5. With contrast waste yarn, and using the quick cast on method, cast on 60 stitches and knit 10 rows. Change to garment yarn and turn the Row Counter to 0. Knit 30 rows. Counting from each end, knit the 10th stitch on each side by hand with a small piece of contrast yarn. Leave the needles in working position and knit 30 rows (Row 60), then knit 4 rows with contrast waste yarn. Turn the Row Counter to 0 and the Tension Dial to 6 and with garment yarn, knit 30 rows. Mark the 10th stitch on each side as you did before, knit 30 rows, then 4 rows with contrast waste yarn. Turn the Row Counter to 0 and with Tension 7, repeat the above once more, ending with 10 rows of contrast waste yarn. Remove the work from the machine by passing the Slide across the needles without yarn (sometimes called 'dropping').

Pull and stretch the sample piece both lengthwise and diagonally from corner to corner, then lengthwise again. Do not count the stitches and rows immediately, but allow the sample to rest for several hours or even over night. This will allow the stitches and rows to return to their basic form.

When your sample has rested and you are ready to count the stitches and rows, the KNITTING CONVERTA TAPE will do the counting for you without any counting on your part.

Use the Tape as follows:

To measure the stitches, pull out the Tape to measure BETWEEN the 40 stitches in the center that you marked by hand knitting with contrast waste yarn - Push the red marker on the Tape so that it points to 40 stitches on the Tape. Your stitch gauge to 5 cm (2 inches) will show in the red window on the tape. To find the number of rows in 5 cm (2 inches), place the tape to measure over 60 rows, push the red marker to 60 on the tape and your row gauge for 5 cm (2 inches) will show in the red window... Easy...? If you do not get the correct stitch and row gauge in the first part of your sample, then try the other two.

If you do not own a KNITTING CONVERTA TAPE, you must mark a 5 cm (2 inch) square in the center of the knitting, then count the number of stitches and rows within the square.



KnitKING News

PRACTICAL KNITTING HINTS

GENERAL INSTRUCTIONS

Please be sure to read the GENERAL INSTRUCTION PAGE in this issue of KNITKING MAGAZINE. We have added some new copy which should be a help to everyone, especially to our new knitters. It tells you now to read the instructions when working from the printed copy or when working from the Charts, or a combination of both. Another important addition is... Instructions for holding stitches when knitting in Pattern - especially while shaping the neck and shoulders of a section. This will continue to be a part of every KNITKING MAGAZINE, so you will be able to refer to it whenever you need.

DK 282 - You will notice that the Woman's Jacket DK 282 was knitted on an Empisal 323 knitting machine with Ribber. We thought it so pretty, we included it especially for our Studio machine subscribers. The Punch Pile is made using Card No. 4. For KNITKING machine owners and other Japanese machines, instructions can be followed as given, but you use the Norwegian Design in 2 colors shown on the Line Drawing and punch your own card.

MARKING SECTIONS OF GARMENT

We have had a few letters from subscribers telling us they find it difficult to put their garments together. From time to time, we mention the importance of MARKING sections of garment so that when you are ready to put them together, the marks match up, thus making it easy for you to sew them together. Here is a reminder on how to do this.

As you are knitting, tie a small piece of contrast yarn ON EACH SIDE of your knitting, every 50 rows or so. When you begin the neck shaping, take a piece of contrast yarn and tie it to the center neck stitch. Do this on both front and back sections... Mark the center stitch at the top of cap shaping of sleeve before you bind it off. Mark the center of Collar or Neckband... If the Collar or Neckband is double, mark the center of cast on and center of bind off row. If you are knitting a Jacket that has a facing where you must cast on a number of stitches after knitting the underhem, you should mark the center of these stitches... so that if the number of stitches to cast on is 24, half of this will be part of the front and half will be the facing. A good way to mark the center fold line is: Thread a tapestry needle with light weight contrast yarn and make a running basting line BETWEEN the 12th and 13th sts. counting from the front edge. Continue the line of basting every 30 or 40 rows as you are knitting. When you are ready to put your garment together, you have a perfect mark for the fold line. Pull out the contrast marking when you have completed your garment. If you mark all sections as you are knitting them, you will find that the sides match perfectly, the sleeves fit into the armholes, the neckbands and collars fall into place and what might be a chore now becomes a pleasure because it all goes together so easily.... try it.

NEW KNITKING YARN CATALOGUE...

We have been experiencing problems completing our new Catalogue and because of these problems, we asked our readers not to send money for it until we have a firm delivery date... but many of you have sent money anyway and now we have to report a further delay...

Last December we asked our suppliers to furnish samples and colors of all yarns to be available in 1976. We made our selections, designed a new Catalogue and placed substantial orders based on the information received... then at the beginning of March we were notified by Nomotta, one of our principal suppliers, and whose yarns we distribute exclusively in the U.S.A., that their range of yarns and colors would be changed completely on April first!! We had no alternative... we just had to hold up production of the new Catalogue... otherwise you would be receiving Catalogues showing obsolete yarns and colors.

We maintain Catalogues for approximately two years, so obviously we have to wait for the new range before completing our Catalogue and because we know of no facility for making yarn catalogues in the U.S.A., we have them made in Europe and have to allow for an additional four weeks shipping time.

SO PLEASE... don't pay for a new Catalogue until we tell you. The yarns used for garments in this issue are either in stock or on the high seas and we have all of the listed colors available... Again, discounts to our subscribers are substantial, so place your order early and try to choose alternate colors as we do run out of the colors used in the original garments.

VENETIA is available in the following colors...

Bittersweet Chocolate - Terra Cotta - Burgundy Wine - Vanilla - Yellow - Rose Pink - Bright Rust - Navy.

ALANDA TWEED: 493 Olive/Lime/Light Blue - 490 Camel/Rust/Brown - 495 Light Blue/Turquoise/Royal Blue - 491 Camel/Light & Dark Brick - 494 Light Blue/Camel/Brown - 489 Orange/Rust/Brown.

BASIC WHITE WITH FLECKS OF

487 Orchid/Plum - 481 Orange/Lime - 480 Turquoise/Blue - 488 Gold/Black - 485 Pink/Black - 486 Shades of Turquoise - 482 Shades of Olive Green.

ALLEGRO: 6522 White - 6520 Black - 6558 Rust - 6559 Brown - 6517 Red - 6523 Light Blue - 6524 Medium Blue - 6527 Navy - 6502 Pink - 6519 Burgundy Wine - 6556 Lilac - 6576 Aqua - 6580 Orange - 6508 Yellow - 6513 Light Green.

NICOLE: 01 White - 09 Beige/Brown - 24 Green/Yellow/Brown - 11 Yellow/Orange - 21 Apricot/Orange/Lavender - 05 Bone/Brown/Orange - 26 Orange/light & dark Orange - 23 White/Red/Blue - 27 Medium Blue/Lavender/Green

BINIA: 3018 White - 3032 Black - 3039 Coral - 3036 Medium Blue - 3020 Royal Blue - 3034 Orange - 3035 Rusty Brown - 3038 Hunter Green - 3014 Camel - 3015 Brown - 3033 Purple - 3022 Red - 3028 Turquoise - 3016 Pink - 3037 Wine.

FORTISSIMA: 01 White - 02 Black - 11 Navy - 20 Red - 07 Dark Wine - 54 Medium Blue - 13 Hunter Green - 16 Beige Heather - 42 Ginger Brown - 44 Teal Blue - 14 Willow Heather - 29 Oxford Grey - 49 Taupe Heather - 17 Mink - 22 Brown.

AMORE: 672 Rosey Pink - 603 Mustard - 628 Light Blue - 695 Light Pink - 698 Brown - 699 Light Green - 693 Yellow Gold - 612 Green - 655 Salmon - 680 Lilac - 696 Hot Pink

CROCUS: 14 Purple - 07 Red - 31 Pink - 03 Yellow - 05 - Bright Pink.

VIENNA: 5614 Black - 5619 White - 5606 Coral - 5607 Soft Green - 5610 Navy - 5611 Red - 5612 Hunter Green - 5613 Yellow - 5605 Apricot - 5617 Light Camel - 5618 Brown - 5609 Medium Blue - 5621 Rust - 5622 Moss Green - 5615 Wine

EURO SPORT: 24 Off White - 01 - White - 02 Black - 08 Royal Blue - 11 Yellow - 07 Navy - 04 Wine - 14 Brown - 19 Red - 12 Kelly Green - 06 Rust - 70 Blue/Grey heather - 40 Wine Heather - 56 Sea Blue Heather - 36 Beige Heather - 20 Grey Heather - 60 Light Rust Heather - 66 Olive Green Heather - 50 Blue Green Heather.

BIG DISCOUNTS ON KITS
for Garments in this issue.

DK 267 - Yarn: Alanda Tweed
 Sizes: 8/10 (12/14) [16/18]
 Regular Price \$1.99 \$27.86 \$29.85 \$31.84
 Sale Price 1.49 20.86 22.35 23.84
 Shipping costs 1.65 1.65 1.65

DK 268 - Yarn: Alanda Tweed
 Hat & Purse
 Regular Price \$1.99 \$17.91
 Sale Price 1.49 13.41
 Shipping costs 1.65

DK 269 - Yarn: Alanda Tweed
 Sizes: 8/10 (12/14) [16/18]
 Regular Price \$1.99 \$89.55 \$91.54 \$93.53
 Sale Price 1.49 67.05 68.54 70.03
 Shipping costs 2.65 2.65 2.65

DK 270 - Yarn: Binia
 Sizes: 10/12 (14/16) [18/20]
 Regular Price \$1.39 \$18.07 \$20.85 \$23.63
 Sale Price 1.04 13.52 15.60 17.68
 Shipping costs 1.65 1.65 1.65

DK 271 - Yarn: Allegro
 Sizes: 8 (12) [16]
 Regular Price \$1.59 \$17.49 \$19.08 \$20.67
 Sale Price 1.19 13.09 14.28 15.47
 Shipping costs 1.65 1.65 1.65

DK 272 - Yarn: Fortissima
 Sizes: 6/8 (10/12) [14/16]
 Regular Price \$1.59 \$15.90 \$19.08 \$22.26
 Sale Price 1.19 11.90 14.28 16.66
 Shipping costs 1.65 1.65 1.65

DK 273 - Yarn: Venetia
 Sizes: 6/8 (10/12) [14/16]
 Regular Price 1 lb. 8 oz. Cone for all sizes - \$23.76
 Sale Price 17.82
 Shipping costs 1.25

DK 274 - Yarn: Allegro
 Sizes: 7/8 (10/12) [14/16]
 Regular Price \$1.59 \$14.31 \$15.90 \$17.49
 Sale Price 1.19 10.71 11.90 13.09
 Shipping costs 1.65 1.65 1.65

DK 275 - Yarn: Allegro
 Sizes: 8/10 (12/14) [16/18]
 Regular Price \$1.59 \$17.49 \$19.08 \$20.67
 Sale Price 1.19 13.09 14.28 15.47
 Shipping costs 1.65 1.65 1.65

DK 276 - Yarn: Nicole
 Sizes: 10 (12) [14]
 Regular Price \$1.79 \$17.90 \$21.48 \$25.06
 Sale Price 1.34 13.40 16.08 18.76
 Shipping costs 1.65 1.65 1.65

DK 277 - Yarn: Amore
 Sizes: 8/10 (12/14) [16/18]
 Regular Price \$1.49 \$11.94 \$14.90 \$19.37
 Sale Price 1.12 8.96 11.20 14.56
 Shipping costs 1.65 1.65 1.65

DK 278 - Yarn: Amore
 Sizes: 8/10 (12/14) [16/18]
 Regular Price \$1.49 \$13.41 \$17.88 \$19.37
 Sale Price 1.12 10.08 13.44 14.56
 Shipping costs 1.65 1.65 1.65

DK 279 - Yarn: Fortissima
 Sizes: 6/7 (8) [10/12]
 Regular Price \$1.59 \$12.72 \$14.31 \$15.90
 Sale Price 1.19 9.52 10.71 11.90
 Shipping costs 1.65 1.65 1.65

DK 280 - Yarn: Amore
 Sizes: 8/10 (12/14) [16/18]
 Regular Price \$1.49 \$10.43 \$11.92 \$13.41
 Sale Price 1.12 7.84 8.96 10.08
 Shipping costs 1.65 1.65 1.65

DK 281 - Yarn: Alanda Tweed
 Sizes: 10/12 (14) [16/18]
 Regular Price \$1.99 \$41.79 \$47.76 \$53.73
 Sale Price 1.49 31.29 35.76 40.23
 Shipping costs 2.15 2.15 2.15

DK 282 - Yarn: Fortissima
 Sizes: 6/7 (8/10) [12/14]
 Regular Price \$1.59 \$19.08 \$22.26 \$25.44
 Sale Price 1.19 14.28 16.66 19.04
 Shipping costs 1.65 1.65 1.65

DK 283 - Yarn: Amore
 Sizes: 8/10 (12/14) [16/18]
 Regular Price \$1.49 \$11.92 \$13.41 \$14.90
 Sale Price 1.12 8.96 10.08 11.20
 Shipping costs 1.65 1.65 1.65

HP 284 - Yarn: Binia
 Sizes: 36/38 (40/42) [44/46]
 Regular Price \$1.39 \$22.24 \$23.63 \$25.02
 Sale Price 1.04 16.64 17.68 18.72
 Shipping costs 1.65 1.65 1.65

HP 285 - Yarn: Fortissima
 Sizes: 34/36 (38/40) [42/44]
 Regular Price \$1.59 \$15.90 \$17.74 \$19.08
 Sale Price 1.19 11.90 13.09 14.28
 Shipping costs 1.65 1.65 1.65

HP 286 - Yarn: Crocus
 Sizes: 32/34 (36/38) [40]
 Regular Price \$2.09 \$16.72 \$18.81 \$22.99
 Sale Price 1.56 12.48 14.04 17.49
 Shipping costs 1.65 1.65 1.65

KK 287 - Yarn: Allegro
 Sizes: 6 (8) [10]
 Regular Price \$1.59 \$12.72 \$14.31 \$15.90
 Sale Price 1.19 9.52 10.71 11.90
 Shipping costs 1.65 1.65 1.65

KK 288 - Yarn: Vienna
 Sizes: 6 (8) [10]
 Regular Price \$1.79 \$ 8.95 \$10.74 \$12.53
 Sale Price 1.34 6.70 8.04 9.38
 Shipping costs 1.65 1.65 1.65

KK 289 - Yarn: Binia
 Sizes: 4/5 (6/7) [8/9]
 Regular Price \$1.39 \$18.07 \$20.85 \$23.63
 Sale Price 1.04 13.52 15.75 17.68
 Shipping costs 1.65 1.65 1.65

KK 290 - Yarn: Allegro
 Sizes: Infant Coveralls
 Regular Price \$1.59 \$ 6.36
 Sale Price 1.19 4.76
 Shipping costs 1.65

KK 291 - Yarn: Allegro
 Sizes: 6 to 9 months
 Regular Price \$1.59 \$ 4.77
 Sale Price 1.19 3.57
 Shipping costs 1.65

RS 296

HASSOCK

SIZE: 20" x 20"
 YARN: Allegro
 GRAMS:
 color 1 600
 color 2 600
 TENSION: 7 to 9
 GAUGE: 12 sts. 34 rows = 5 cm (2")



A Weaving Pattern. KNITKING machine owners use Wheel No. W3. Follow the Line Drawing.

FINISHING: Using the knitted sections as a Pattern, cut an inner section out of heavy muslin or ticking. Sew the lining sections together leaving an opening for stuffing. Fill with foam chips or dacron filler making it firm. Sew knitted sections except for the top. Insert stuffed form, then pin and sew on the top.

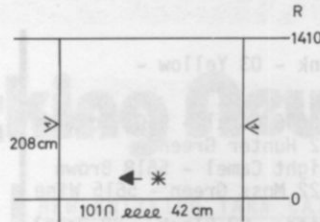

SIDES: Cast on 101 sts. and work 1410 rows in Weaving Pattern. Bind off.

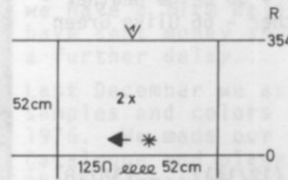

TOP and BOTTOM:

Cast on 125 sts. and work 354 rows in Weaving Pattern. Bind off.

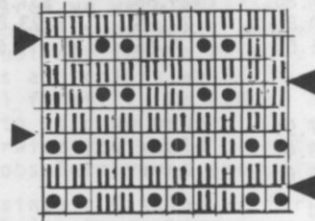

KNITKING NEWS (continued)

KK 293 - Yarn: Allegro

Sizes:	1/2	(3/4)	[5/6]
Regular Price	\$1.59	\$ 6.36	\$ 7.95
Sale Price	1.19	4.76	5.95
Shipping costs		1.65	1.65

KK 294 - Yarn: Euro Sport

Sizes:	4/5	(6/7)	[8/9]
Regular Price	\$1.29	\$11.61	\$12.90
Sale Price	.96	8.64	9.60
Shipping costs		1.65	1.65

KK 295 - Yarn: Euro Sport

Sizes:	Cap & Muff to go with KK 294		
Regular Price	\$1.29	\$ 6.45	
Sale Price	.96	4.80	
Shipping costs		1.65	

RS 296 - Yarn: Allegro

Haddock		
Regular Price	\$1.59	\$38.16
Sale Price	1.19	28.56
Shipping costs		2.10

KK 292 - Yarn Allegro

Sizes:	1/2	(3/4)	[5/6]
Regular Price	\$1.59	\$ 6.36	\$ 7.95
Sale Price	1.19	4.76	5.95
Shipping costs		1.65	1.65



NEW IMPROVED.....

~~WHIZ~~ KING PATTERN READER

- It is now even easier to draw your own PATTERN READER CHARTS...
- A KNITKING Converta Tape is a part of every PATTERN READER...
- With the Converta Tape, you can measure anyone and immediately read off (without calculations) exactly how many stitches and rows you need for any part of a garment...
- TWO transparent sheets of special plastic graph are now with every PATTERN READER, together with a liquid crayon pen for drawing your own Charts, plus easy to follow instructions on how to draw any Chart...
- Because PATTERN READER Charts are drawn by stitches and rows, you are able to make Charts on a sheet 12 x 17 inches, instead of difficult to handle, life size sheets...

PRICE: \$79.50 Complete with instructions, practice Charts and illustrations of 50 complete Patterns for the entire family. (California residents add Sales Tax)
Shipping costs \$2.75

ORDER DIRECT FROM KNITKING 1128 CRENSHAW BLVD. • LOS ANGELES, CALIFORNIA 90019

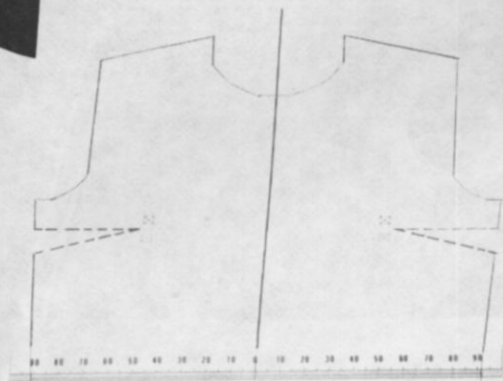

KNITKING

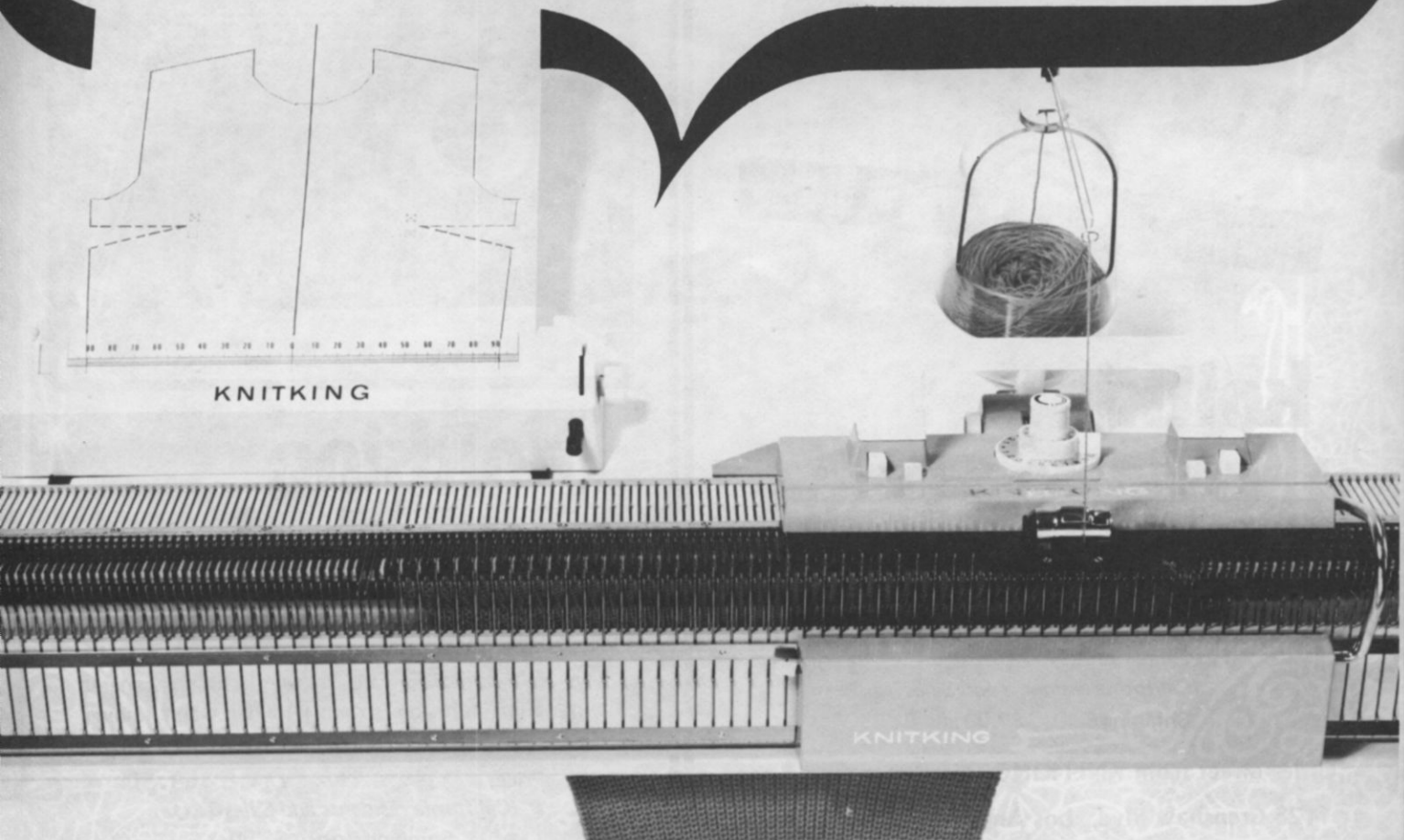

New products from KNITKING

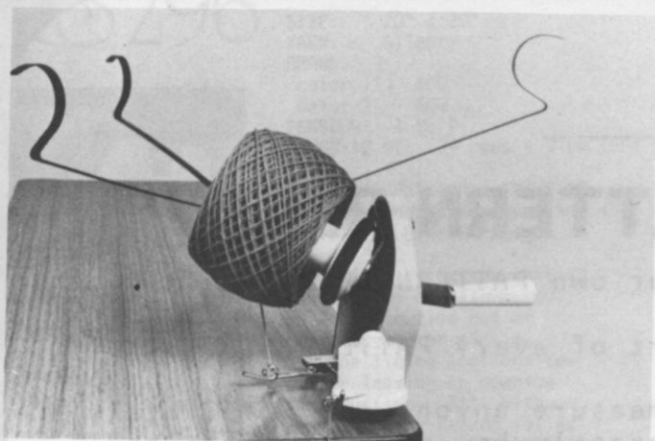

New design Yarn Winder with 'Waxamajig' and Skein Holder. As you can see from the illustration, this clever New Winder with Nylon Helical Gears winds a perfectly symmetrical ball. . . ! If you like to wax yarn (for easier knitting) you use the 'Waxamajig'. If waxing is not necessary, you bypass it . . . The Skein Holder is self adjusting. You will not find a better Hand Winder anywhere.

Complete price \$27.50
 (California residents add Sales Tax)
 Shipping Charges: \$2.00

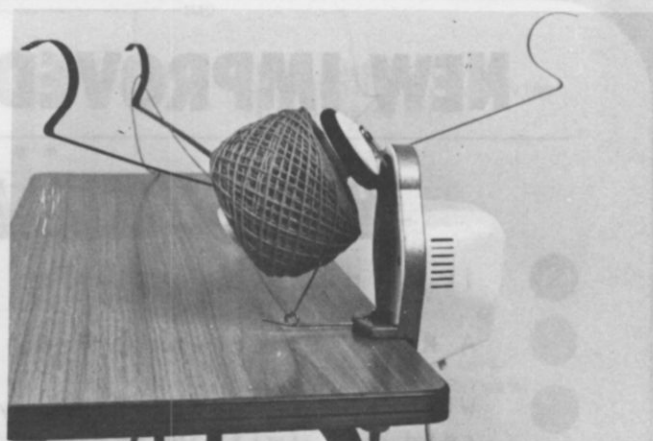

New design electric winder

Self-contained Motorized Winder (110/120 Volts) with Push Button on and off Switch . . . Special Clutch device to stop Winder if yarn bunches up or jams in the guide eye . . . Another excellent easy to use KNITKING product.

Price: Complete with Skein Holder \$44.95
 (California residents add Sales Tax).
 Shipping Charges: \$3.00



knitking carrying bags

Completely new design in heavy duty canvas with waterproof interior. For AM 3 Knitter and Yarn Container.

Price: \$46.50
 For Ribber only: \$23.00
 (California residents add Sales Tax)
 Shipping Costs: \$2.00 and \$1.25

Order direct from KNITKING —
 1128 Crenshaw Blvd., Los Angeles, California 90019

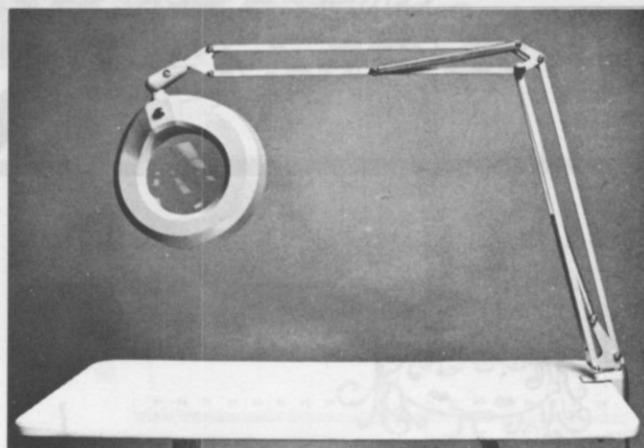

knitking magnifier lamp

A perfect gift item for any knitter. It has a large (5") magnifying lens and a cool fluorescent tube light. It stays in any position and is wonderful for general illumination for you to work under when joining seams, etc. Color: light grey.

Price: \$69.50
 (California residents add Sales Tax)
 Shipping Costs: \$3.50



DK282

DK 274



KK 289

DK 277

DK 283



A man with brown hair, smiling and looking to his left, is wearing a white cable-knit sweater with a collar. He is holding a vintage-style camera with a lens cap. The entire scene is set against a dark background and framed by a decorative border with a repeating floral pattern in light blue and white. The text 'HP 285' is printed in a serif font on a dark rectangular background in the upper right corner.

HP 285

HP 286

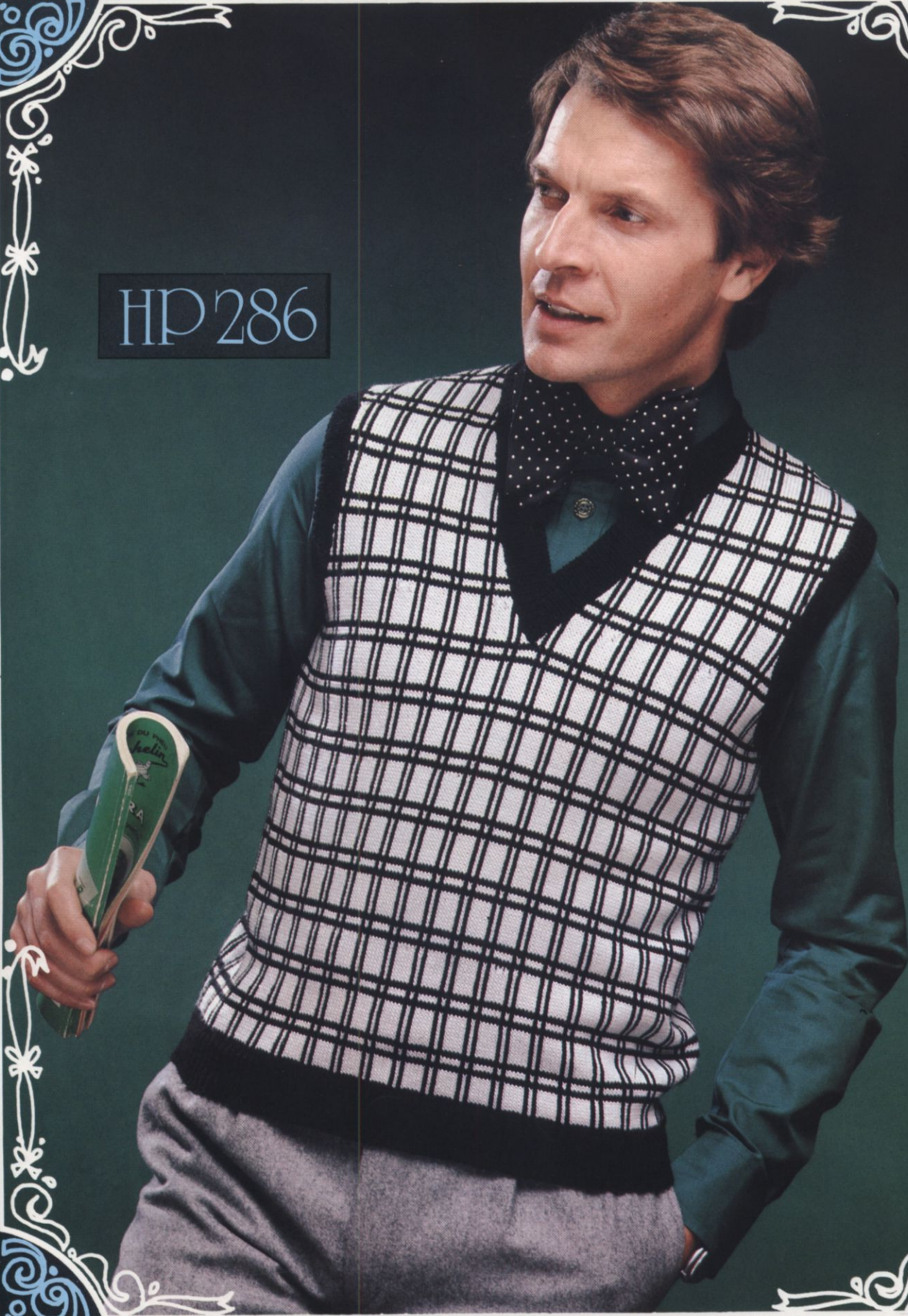



KK 287

KK 288



KK 294



KK 295

KK 290



KK 291



KK 292

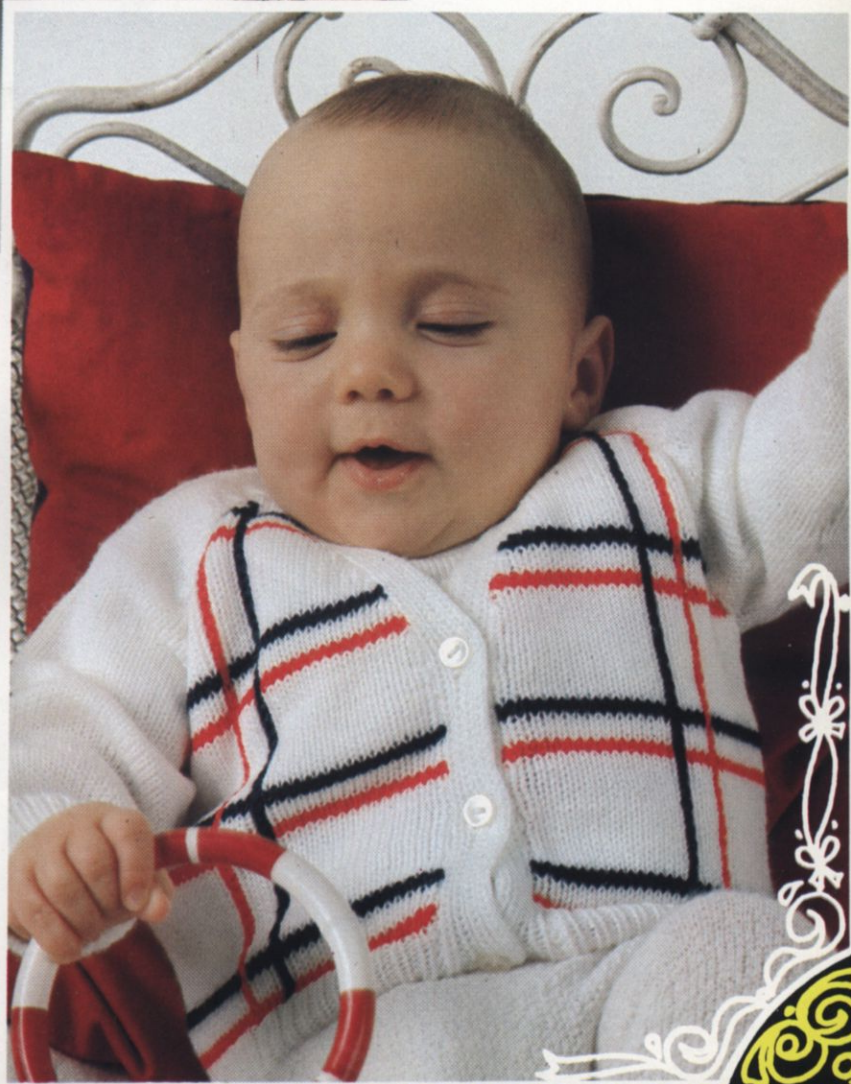

KK 293

