

knitking

magazine





dk 546

X91077

dk 552





OK 539



DK 551

DK 550



DK 556

dk 554



dk 542



dk 549

no 553



KK 538

KK 536

KK 544



knitking

magazine

VOLUME 13, No. 6

TABLE OF CONTENTS

PAGE NO.

KK 536	Child's Pullover	14
KK 537	Child's Pullover	15
KK 538	Child's Pullover & Helmet	16
DK 539	Woman's Skirt & Jacket	17
KK 540	Child's Jacket	19
DK 541	Woman's Bolero & Cap	20
DK 541	Woman's Skirt & Pullover	22
DK 542	Woman's Skirt & Jacket	23
KK 543	Boy's Suit	25
KK 544	Child's Cardigan	26
KK 545	Child's Snowsuit	27
DK 546	Woman's Pullover	29
KK 547	Child's Coverall, Jacket & Cap	30
KK 548	Baby's Suit	32
DK 549	Woman's Pullover	33
DK 550	Woman's Skirt	33
DK 551	Woman's Pullover	34
DK 552	Woman's Skirt & Pullover	35
HP 553	Man's Jacket	37
DK 554	Woman's Skirt & Jacket	38
DK 555	Woman's Pullover & Legwarmers	38
DK 556	Woman's Pullover & Pants	40
KK 557	Child's Coat & Cap	41
KK 558	Baby Coverall & Pullover	42
KK 559	Toys	43
KK 560	Couch Throw & Pillow	44

editorial

Our very first Open House and Seminar held on the KNITKING premises during October was a great success and we want to thank the several hundred customers who attended for their cooperation in assuring its success. Some classes were so popular, it was necessary to send out for extra chairs to accommodate the overflow crowds.

We ran continuing classes and lectures from 10:30 a.m. through 4:30 p.m. daily. They included knitting machine techniques embracing the use of machines, ribbers and all other accessories.... Demonstrations on how to finish and assemble garments.... Blocking.... Seaming by hand... Seaming with sewing machines and BABY LOCK, etc..

The lectures and demonstrations by Carlos Arias, the internationally famous knit wear Designer proved extremely popular and once again it was evident that knitting machine owners have a great need for knowledge regarding the charting of garments.... Classes on drawing Charts for the KNITLEADER always ran over time because of the considerable interest and desire for knowledge. The team of experts at KNITKING proved again that they are the best in the country and we were proud of the way they conducted themselves...

Once knitters see how simple the KNITLEADER is to use, how easy it is to draw full size Charts to any size or shape, how it speeds up the knitting of garments and how it assures greater shaping accuracy without the need to perform mathematical calculations, they are unlikely to ever go back to the old method of figuring and writing down row by row instructions.





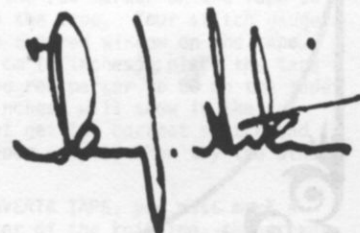









The success of our first Open House and Seminar encourages us to repeat at least on an annual basis and the knowledge and experience we gained during our first one will certainly help to insure that future Seminars will be even better... So plan to be with us next year....



Publisher: KNITKING CORPORATION, 1128 Crenshaw Blvd., Los Angeles, Calif. 90019. Telephone: (213) 938-2079. Published bi-monthly. Subscriptions: USA — \$12.00 annually, single copies \$3.00; Canada — \$14.00; other parts of the world — \$18.00. The entire contents of KNITKING MAGAZINE are copyright and must not be reproduced in any shape or form without the express permission, in writing of the publisher. © COPYRIGHT 1977 by KNITKING CORPORATION.





Pattern Symbols

Knitting — Chart Symbols

- () Size Symbols
(2nd Size)
- < > 3rd Size
- B** Beginners Pattern
- T** Tension
- G** Gauge
- ①** Color Number
-  Cast on
-  Stitch
- R** Row
- H** Hem
-  Bind off
-  Stockinette stitch — worn on the Knit side.
-  Stockinette stitch — worn on the Purl side.
-  Knit 1, Purl 1 Ribbing
-  Ribbing Pattern — worn on the Knit side.
-  Ribbing Pattern — worn on the Purl side.
-  Closed Dart
-  Open Dart
-  Put on a stitch holder
-  Reverse 1 section
-  On every other needle
- 4** Number of Rows between Shapings. Make increase (or decrease) **FIRST**, then knit 4 rows. For example: 3 x 1  means decrease (or increase) 1 st., knit 4 rows; decrease 1 st., knit 4 rows; decrease 1 st., knit 4 rows; decrease 1 st., knit 4 rows. All decreasing (or increasing) without row numbers as shown must be shaped on every 2nd row.

-  Increase
-  Increase 2 sts. With a transfer tool, move the sts. over the left (or right) leaving 2 empty needles at the point of increase. At the increase point, move 1 st. to the left, (or right) so that there is an empty needles on each side of a stitch. On each side of the center stitch, pick up a stitch from the row below and hang it onto the empty needle.

-  3 stitches on 1 needle. The 1st and 3rd stitch in a group of 3 has been hung on the 2nd or center needle.
-  Short Row increase or decrease; for instance on a flared skirt knitted sideways.

-  Pattern Stitch
-  Pattern Stitch — worn on the Knit side.
-  Pattern Stitch — worn on the Purl side.





-  Norwegian Design using the Pattern Reader. Only 1 row must be registered on the Pattern Reader, so when knitting two or more colors in 1 row, knit the first color with the LEVER of Pattern Reader UP (working), then push the LEVER DOWN (non-working) for the additional colors.

REPEAT the above for each complete row.

















-  Repeat

- I = Front
II = Back
III = Sleeve
IV = Skirt Front
V = Skirt Back
VI = Collar
VII = Pocket
VIII = Band
IX = Belt
X = Cuff
XI = Pants Front
XII = Pants Back

Finishing — Chart Symbols

-  Match numbers on section for assembling.
-  Ease
-  Fold Line
-  Turn to the wrong side and hem.

Stitch Symbols

-  Knit Stitch
-  Purl Stitch
-  Needles in holding position
-  Needles back into working position.
-  Empty needle (leave in working position)
-  Needle not used (in the out of work position).
-  Two stitches on 1 needle, either transferred from the right side or the left side, then put into holding position.
-  Needle holding 2 stitches. Stitch has been transferred from the RIGHT.
-  Needle holding 2 stitches. Stitch has been transferred from the LEFT.
-  Center of garment section
-  Pattern Reader
-  JAC 40
-  Adjustable Needle Selector
-  Pattern Wheel
-  Weaver
-  Needle Shifter

General Instructions

HOW TO READ THE CHARTS AND INSTRUCTIONS

There are 3 sizes given for each Pattern in KNITTING MAGAZINE. Above each Chart for the different sizes, you will see that the first and smaller sizes might be shown as 8/10, the second size as (12/14) and the third as [16/18]. Check the measurements at the bustline and hips on the Charts to be certain that you will knit the correct size, remembering these are ACTUAL measurements of the completed section and that there must be a bigger allowance at the bustline and hipline for a Jacket or a Coat than there would be for a fitted dress or a fitted blouse or pullover. The question in your mind should be "How do I want this garment to fit...?"

When you have chosen the size you need, you can follow the Charts as shown. You will notice that where the shapings are the same FOR ALL SIZES, only 1 set of shapings will be shown on the first Chart and if you are knitting the 2nd or 3rd size, you simply follow the shapings as given for the first size. If the shapings are different, this will be shown on the Charts and you should follow them as given.

On the Charts, increases and decreases will be shown as follows

$\begin{matrix} 5x1 \\ \boxed{6} \end{matrix}$ The number in the box means number of ROWS between the shapings, while the 5x1 above the box means - 1 st. 5x... so you will increase or decrease 1 st. every 6th row 5x.

ARMHOLE SHAPINGS - NECK SHAPINGS - SHOULDER SHAPINGS - are made on every 2nd row UNLESS there is a number in a box along side or below the shapings. The rule is... where there is no box with a number, the shaping is made on every 2nd row.

THE PRINTED INSTRUCTIONS

You can follow the printed instructions or use them in combination with the Charts. Where there is any question in the printed instructions, you have the Charts to show you how the section will look.

The 3 sizes, with the different amounts of cast on stitches and the different shapings will look like this...

Cast on 124 (136) [148] sts. You will
Cast on 124 sts. for the first size.
Cast on 136 sts. for the 2nd size.
Cast on 148 sts. for the 3rd size.

The important thing to remember is that you MUST READ AHEAD so that you KNOW what to do for the size you are knitting. Sometimes where the number of stitches are the same but the number of times different, you will find shapings like this...
3 sts. 1x (2x) [3x], 2 sts. 1x (2x) [3x], 1 st. 3x (4x) [5x].
As you see, you MUST read ahead in order to follow the instructions as given for YOUR SIZE. The rows will be different for the different sizes in some cases... Shoulder and Neck shapings usually are worked at the SAME TIME for the back section - so watch for the words AT THE SAME TIME.

HOLDING STITCHES ON THE LEFT SIDE WHILE SHAPING THE RIGHT SIDE

When knitting a section of garment in stockinette stitch, it is easy to hold the stitches on the left side while knitting the right half, but when knitting a Pattern Stitch such as a Norwegian Design, a Holding Position Design, Weaving, etc., you should use the following method. For the NECK SHAPING, we tell you to bind off the center sts., put the needles on the left into holding position and complete the right half first... so with a strand of contrast yarn, knit ALL of the left side stitches manually by hand, pulling each stitch back against the needle bed to the OUT OF WORK position. When the right side is completed, carefully pull the stitches held on contrast, forward into working position and as you do so, undo the contrast yarn, line up the needles (KNITTING machine owners, put the stitches under the sinkers) and complete the left half.

If you own a Japanese machine, you may find that when knitting the right half with the left side held in this way, the sinker plate will mark the left side while you are knitting the right half. To prevent this marking, you can tape a piece of paper over the knitting, underneath the sinkers, or if you own a Reversing Bar, you can hang this onto the Sinkers while you are knitting the right half. When hanging the Reversing Bar, be sure the eyes of the bar go BETWEEN the Sinker Posts on the upper part of the bar so that the tips of the bar only - show above the needle bed.

FULL FASHION DECREASING OR INCREASING

For Stockinette stitch, always use the Full Fashion method for increasing or decreasing.

TO DECREASE: Hang the 3rd stitch onto the 2nd stitch then move the stitches in to fill the empty needle.

TO INCREASE: Move the 2 end stitches 1 needle outward, then pick up the 3rd stitch from the row below and hang it onto the empty needle.

NORWEGIAN DESIGNS:

In the instructions, each row of the Norwegian Design is counted as 1 row but several movements of the Cam Box (or Slide) are needed to complete 1 row.

NORWEGIAN DESIGN WHEN USING THE PATTERN READER

When you use the Pattern Reader and knit a Norwegian Design using several colors, it is necessary to move the Trip Control Lever so that only 1 row registers.

FINISHING: Block all sections. For PULLOVERS, JACKETS, and DRESSES: Join front to back at sides and shoulders. Sew sleeves together and set in. Hem lower edge and sleeve edges if needed. For a double neckband or armhole band, sew 1 edge to the inside and 1 to the outside of neck or armhole. For a single ribbed band, sew 1 edge to the outside of neck or armhole edge. For a cardigan or jacket with buttonholes, finish buttonholes and sew on buttons.

PANTS: Join front to back at sides. Sew inside leg seams, then join center front and back. Make hem at waistline and insert elastic. Hem lower edge of pants legs.

THE SAMPLE SWATCH

Before you begin to knit any garment, you will need to knit a sample piece using the yarn you have chosen for your garment, so that you can check the stitch and row gauge which must measure the correct number of stitches and rows in 5 cm (2 inches).

For each Pattern in KNITTING MAGAZINE, we give you 3 tension numbers to work from and if you use the specified yarn for the garment, you should be able to get the correct stitch and row gauge using one of these numbers. Here is a very easy way to make your sample swatch and count the stitches and rows without actually counting, by using our KNITTING Converta Tape.

Supposing the Tension Numbers for the Stitch and Row Gauge are given as 5 to 7. Set the Tension Dial to the first number which is 5. With contrast waste yarn, and using the quick cast on method, cast on 60 stitches and knit 10 rows. Change to garment yarn and turn the Row Counter to 0. Knit 30 rows. Counting from each end, knit the 10th stitch on each side by hand with a small piece of contrast yarn. Leave the needles in working position and knit 30 rows (Row 60), then knit 4 rows with contrast waste yarn. Turn the Row Counter to 0 and the Tension Dial to 6 and with garment yarn, knit 30 rows. Mark the 10th stitch on each side as you did before, knit 30 rows, then 4 rows with contrast waste yarn. Turn the Row Counter to 0 and with Tension 7, repeat the above once more, ending with 10 rows of contrast waste yarn. Remove the work from the machine by passing the Slide across the needles without yarn (sometimes called 'dropping').

Pull and stretch the sample piece both lengthwise and diagonally from corner to corner, then lengthwise again. Do not count the stitches and rows immediately, but allow the sample to rest for several hours or even over night. This will allow the stitches and rows to return to their basic form.

When your sample has rested and you are ready to count the stitches and rows, the KNITTING CONVERTA TAPE will do the counting for you without any counting on your part. Use the Tape as follows:

To measure the stitches, pull out the Tape to measure BETWEEN the 40 stitches in the center that you marked by hand knitting with contrast waste yarn - Push the red marker on the Tape so that it points to 40 stitches on the Tape. Your stitch gauge to 5 cm (2 inches) will shown in the red window on the tape. To find the number of rows in 5 cm (2 inches), place the tape to measure over 60 rows, push the red marker to 60 on the tape and your row gauge for 5 cm (2 inches) will show in the red window... Easy...? If you do not get the correct stitch and row gauge in the first part of your sample, then try the other two.

If you do not own a KNITTING CONVERTA TAPE, you must mark a 5 cm (2 inch) square in the center of the knitting, then count the number of stitches and rows within the square.

KK 536

CHILD'S PULLOVER

SIZES: 7/8 (9/10) [11/12]
 YARN: Euro Sport
 GRAMS: color 1 300 350 350
 color 2 50 50 50
 TENSION: 9 or 10
 GAUGE: 11 sts. 18 rows = 5 cm (2")

Stockinette stitch with a Norwegian Border Design on lower edge and Sleeves. Bands are Ribbed.

FINISHING: See General Instructions.

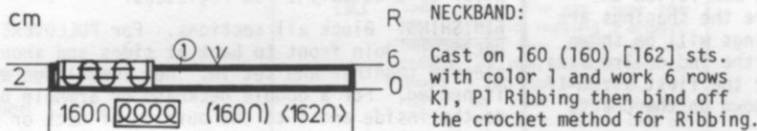
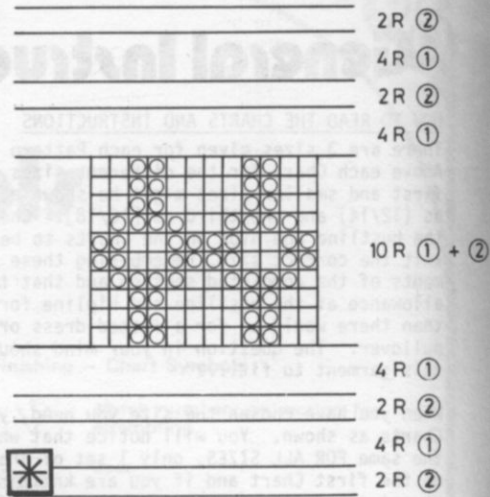

FRONT & BACK: Made in 1 section.

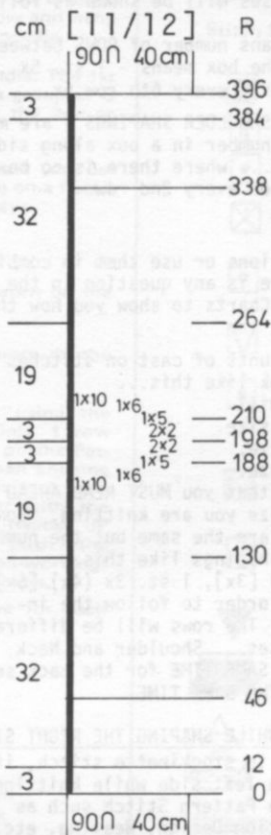
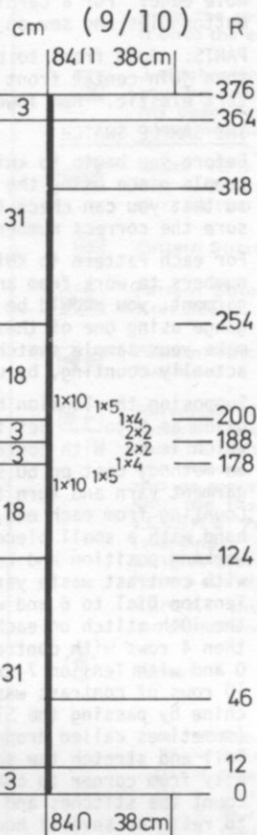
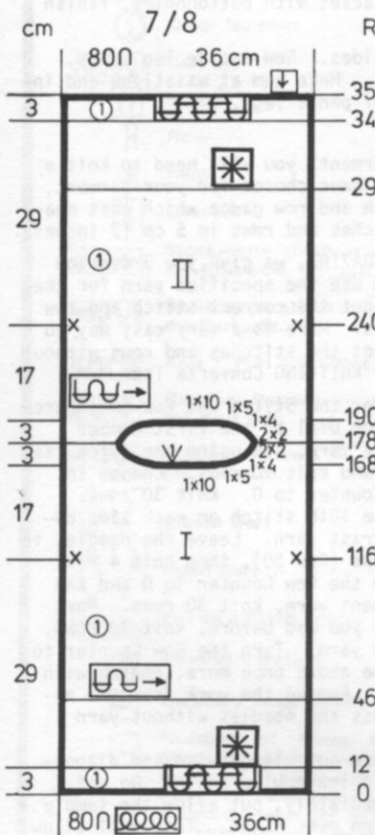

Cast on 80 (84) [90] sts. with color 1 and work 12 rows K1, P1 Ribbing. Continue in the Norwegian Design to Row 46. Continue in Stockinette stitch with color 1. Knit to Row 116 (124) [130]. Mark each side with a bit of waste yarn (for setting in sleeves) then knit to Row 168 (178) [188]. SHAPE NECK: Put half the sts. on the left into holding position and complete the right side first. *ON NECK SIDE, bind off 10 sts. 1x, 5 sts. 1x, 4 sts. 1x, 2 sts. 2x. (Same as first size). [10 sts. 1x, 6 sts. 1x, 5 sts. 1x, 2 sts. 2x]. After Row 178 (188) [198], ON NECK SIDE, cast on 2 sts. 2x, 4 sts. 1x, 5 sts. 1x, 10 sts. 1x. (Same as first size). [2 sts. 2x, 5 sts. 1x, 6 sts. 1x, 10 sts. 1x]. Put these sts. into holding position and move the Slide to the right side. Bring the needles on the left side of neck into working position, turn the Row Counter back to 168 (178) [188] and complete the neck shaping following the instructions from *. After Row 190 (200) [210], all sts. in Stockinette stitch to Row 240 (254) [264]. Mark each side for sleeve as you did before then knit to Row 298 (318) [338]. Knit the Norwegian Design to Row 344 (364) [384]. Transfer every other stitch to the Ribber and work K1, P1 Ribbing to Row 356 (376) [396]. Bind off the crochet method for Ribbing.

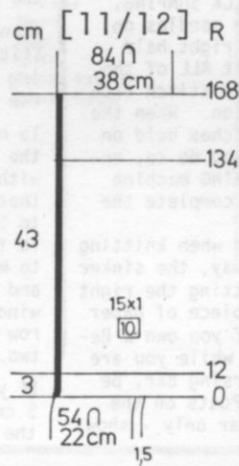
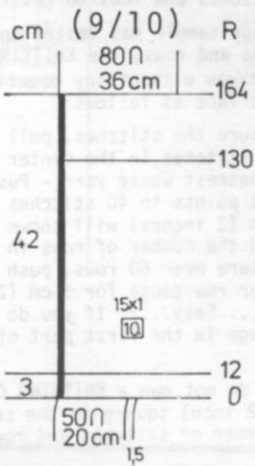
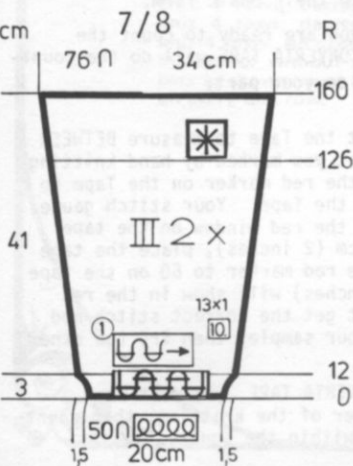

SLEEVES: III

Cast on 50 (50) [54] sts. with color 1 and work K1, P1 Ribbing to Row 12. Continue in Stockinette stitch. ON EACH SIDE, increase 1 st. every 10th row 13x (15x) [15x]. After Row 126 (130) [134], work the Norwegian Border Design to Row 160 (164) [168]. Remove the sts. onto contrast waste yarn.

KK 537

CHILD'S PULLOVER

SIZES: Years 6/7 (8/9) [10/11]

YARN: Color 1 Euro Sport
Color 2 Alanda Tweed

GRAMS:
color 1 250 300 300
color 2 200 200 200
TENSION: 9 or 10
GAUGE: 11 sts. 18 rows = 5 cm (2")



Stockinette stitch with color stripes as shown on the Chart. Side and neck bands are ribbed. Worn on the Purl side.

FINISHING: See General Instructions. Sew the side bands in place. Sew on neckband. See Picture.

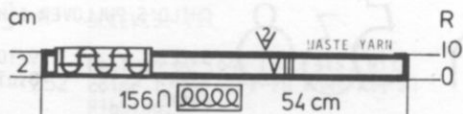

NECKBAND: VIII

Cast on 156 sts. with color 1 and work 10 rows K1, P1 Ribbing. Remove onto contrast waste yarn.

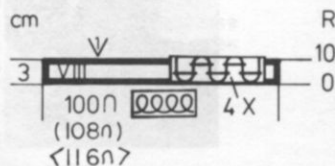

SIDE BANDS: VIII Make 4.

Cast on 100 (108) [116] sts. with color 1 and work 10 rows K1, P1 Ribbing. Bind off the crochet method for Ribbing.

FRONT & BACK - Made in 1 section.

Cast on 76 (80) [84] sts. with color 1 and work Stockinette stitch with REPEATED color stripes as shown on the Chart. After Row 128 (136) [140], mark each side with a bit of waste yarn (for setting in sleeves). After Row 132 (140) [144], bind off the center 6 sts., put the needles on the left into holding position and complete the right side first.

*Knit to Row 170 (180) [190]. SHAPE NECK: Bind off 4 sts. 1x, 3 sts. 1x, 2 sts. 2x, 1 st. 1x.

(Same as first size). [4 sts. 1x, 3 sts. 1x, 2 sts. 3x, 1 st. 1x].

Put the remaining sts. into holding position, knit 1 row to the left side, turn the Row Counter back to 132 (140) [144] and work the left side neck shaping. Follow the instructions from *.

After Row 190 (200) [210], cast on 30 (30) [34] sts. in the center for back neck. All needles in working position. Knit to Row 252 (264) [280]. Mark each side as you did before and continue to row 380 (400) [420]. Bind off.

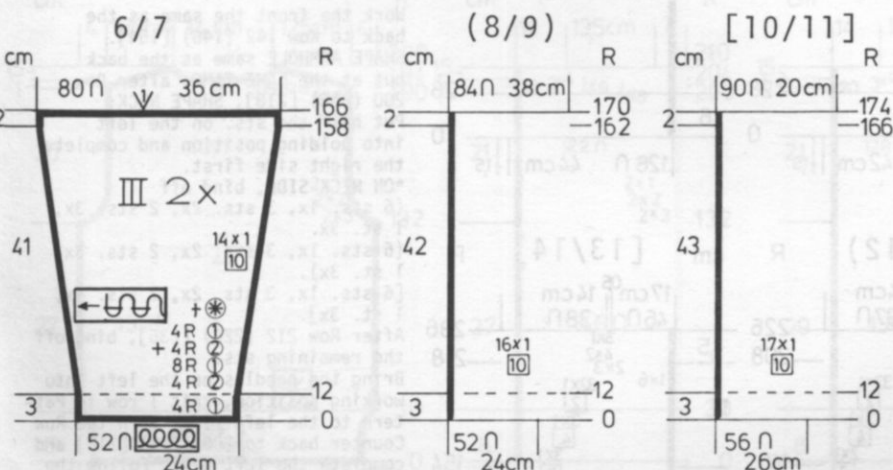
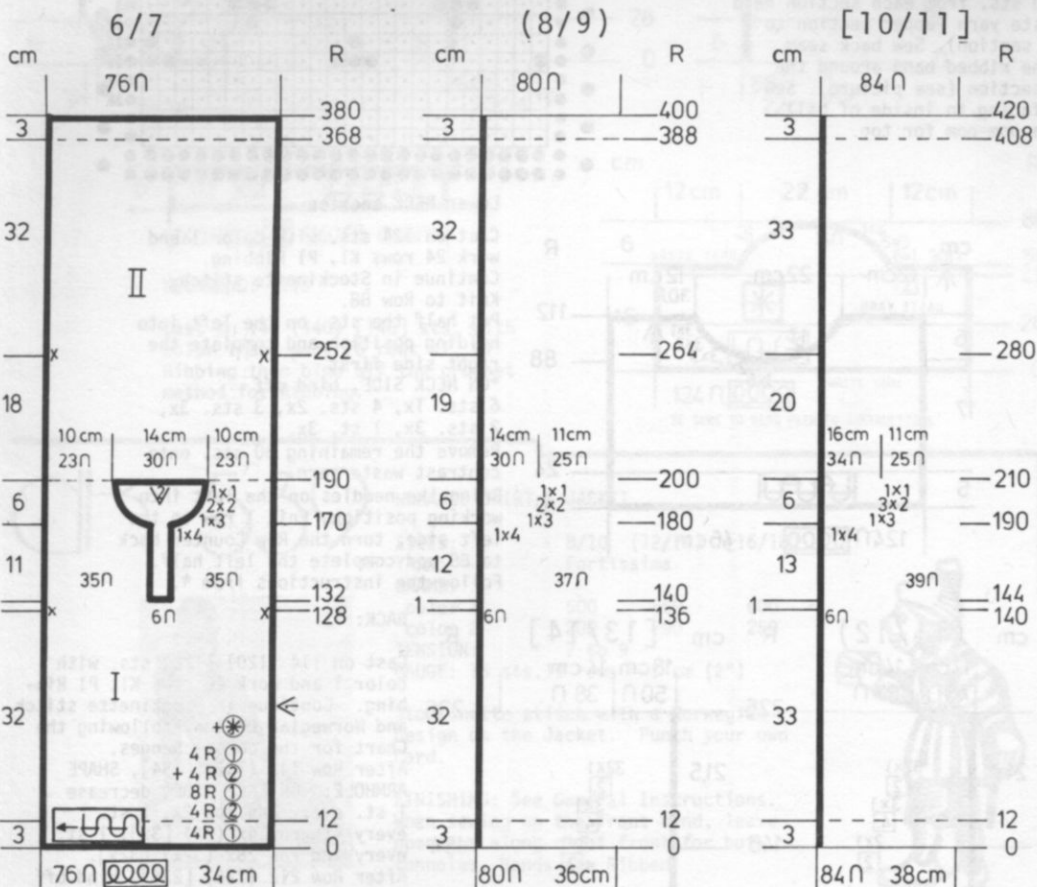

SLEEVES: III Make 2.

Cast on 52 (52) [56] sts. with color 1 and work Stockinette stitch with REPEATED color stripes as shown on the Chart. After Row 12, ON EACH SIDE, increase 1 st. every 10th row 14x (16x) [17x]. Knit to Row 166 (170) [174], then bind off.



KK 538

CHILD'S PULLOVER & HELMET

SIZES: 9/10 (11/12) [13/14]
YARN: Binia
GRAMS:
 Pullover
 color 1 300 350 350
 color 2 100 150 150
 Helmet
 color 1 100 100 100
 color 2 50 50 50
TENSION: 8 to 10
GAUGE: 13 sts. 19 rows = 5 cm (2")



Stockinette stitch with a Norwegian Design. Punch your own Card. Bands are Ribbed.

FINISHING: See General Instructions.
Helmet: Block the sections, then weave the 30 sts. from each section held on waste yarn (upper section to lower section). Sew back seam. Sew the ribbed band around the face section (see picture). Sew bill facing to inside of bill. Make a pom-pom for top.

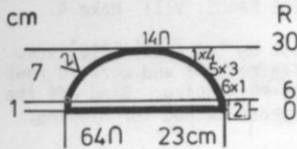

BILL FACING:

Cast on 64 sts. with color 1 and work Stockinette stitch.
ON EACH SIDE, on every 2nd row, bind off 1 st. 6x, 3 sts. 5x, 4 sts. 1x. After Row 30, bind off the remaining sts.

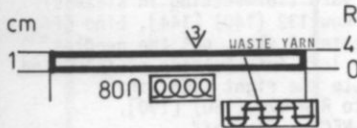

FACE BAND:

Cast on 80 sts. and work 4 rows K1, P1 Ribbing then remove onto contrast waste yarn.

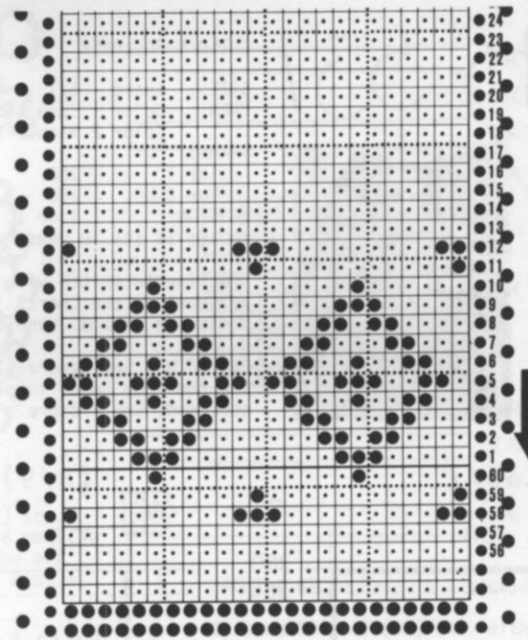

Lower NECK section.

Cast on 124 sts. with color 1 and work 24 rows K1, P1 Ribbing. Continue in Stockinette stitch. Knit to Row 88. Put half the sts. on the left into holding position and complete the right side first.
***ON NECK SIDE**, bind off 6 sts. 1x, 4 sts. 2x, 3 sts. 3x, 2 sts. 3x, 1 st. 3x. Remove the remaining 30 sts. onto contrast waste yarn. Bring the needles on the left into working position, knit 1 row to the left side, turn the Row Counter back to 88 and complete the left half. Follow the instructions from *.

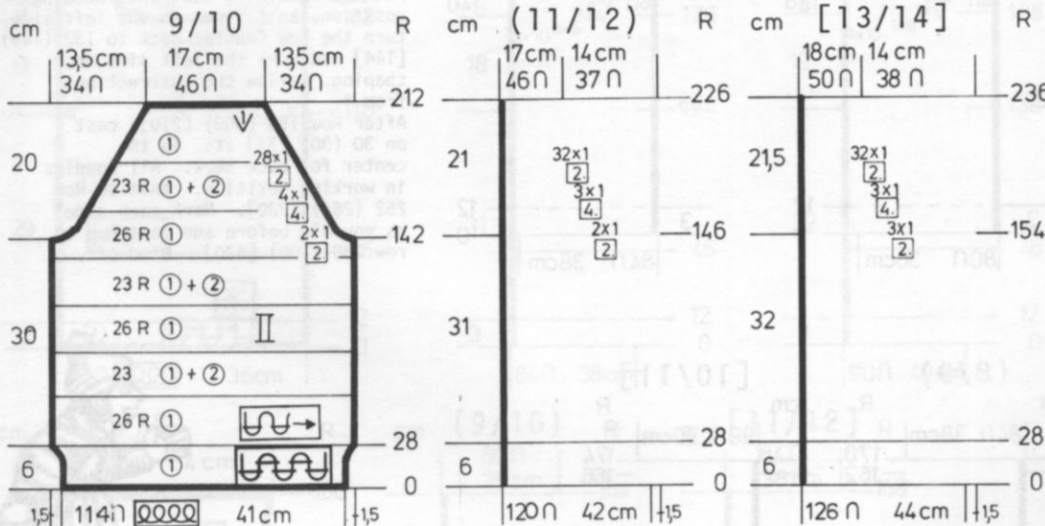
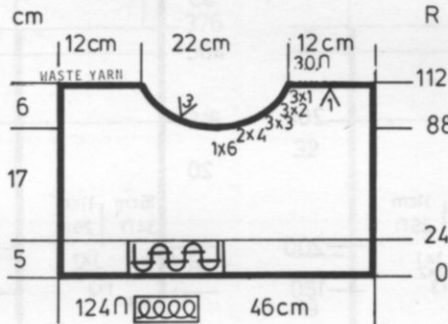

BACK: II

Cast on 114 (120) [126] sts. with color 1 and work 28 rows K1, P1 Ribbing. Continue in Stockinette stitch and Norwegian Design, following the Chart for the color changes.
After Row 142 (146) [154], SHAPE ARMHOLE: ON EACH SIDE, decrease 1 st. every 2nd row 2x, 1 st. every 4th row 4x (3x) [3x], 1 st. every 2nd row 28x (32x) [32x]. After Row 212 (226) [236], bind off the remaining sts.

FRONT: I

Work the front the same as the back to Row 142 (146) [154].
SHAPE ARMHOLE same as the back but at the SAME TIME, after Row 200 (208) [218],
SHAPE NECK: Put half the sts. on the left into holding position and complete the right side first.
***ON NECK SIDE**, bind off (6 sts. 1x, 3 sts. 2x, 2 sts. 3x, 1 st. 3x).
 (6 sts. 1x, 3 sts. 2x, 2 sts. 3x, 1 st. 3x).
 [6 sts. 1x, 3 sts. 2x, 2 sts. 4x, 1 st. 3x].
After Row 212 (226) [236], bind off the remaining sts. Bring the needles on the left into working position, knit 1 row in Pattern to the left side, turn the Row Counter back to 200 (208) [218] and complete the left half. Follow the instructions from *.

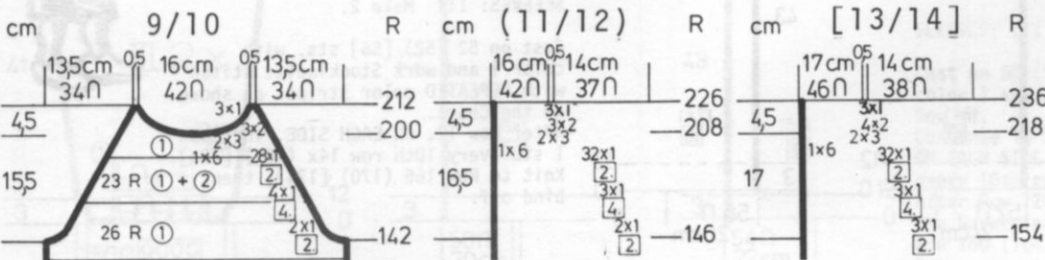

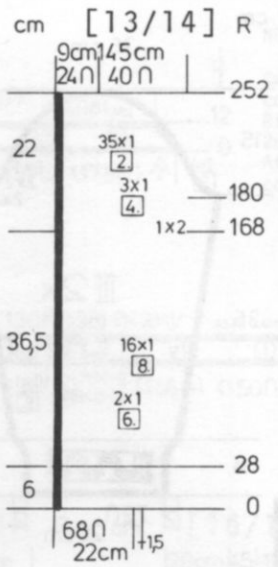
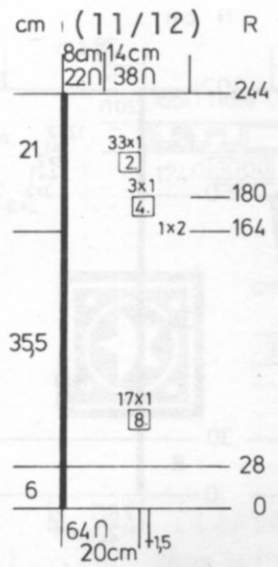
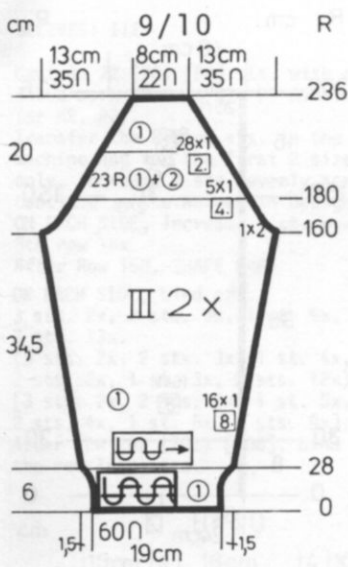

SLEEVES: III

Cast on 60 (64) [68] sts. with color 1 and work 28 rows K1, P1 Ribbing. Continue in Stockinette stitch with color 1. ON EACH SIDE, increase 1 st. every 8th row 16x (17x) [every 6th row 2x, every 8th row 16x]. After Row 160 (164) [168], SHAPE RAGLAN: ON EACH SIDE, bind off 2 sts. 1x for all sizes then decrease 1 st. every 4th row 5x (3x) [3x] then 1 st. every 2nd row 28x (33x) [35x]. After Row 236 (244) [252], bind off the remaining sts.

HELMET:

Top with Bill.

With contrast waste yarn, cast on 124 sts. Knit 8 to 10 rows then change to color 1 and put Counter at 0.

Work Stockinette stitch to Row 26 then continue in Norwegian Design to Row 49. Knit to Row 56. ON EACH SIDE, remove 30 sts. onto contrast waste yarn.

ON EACH SIDE, bind off 6 sts. 1x, 3 sts. 5x, 4 sts. 1x. After Row 80, bind off the remaining sts.

Hang the 124 cast on sts. back onto the machine, decreasing 20 sts. evenly across. Knit 2 rows, remove on waste yarn.

*Hang back onto the machine, decreasing 20 sts. across as before and knit 2 rows. Remove onto waste yarn.

REPEAT from * 3x more, but the last time, remove the sts. onto a double strand of garment yarn and pull up and tie.

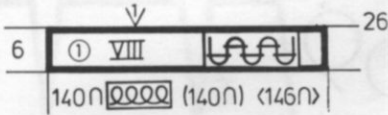

NECKBAND: VIII

Cast on 140 (140) [146] sts. with color 1 and work 26 rows K1, P1 Ribbing then bind off the crochet method for Ribbing.

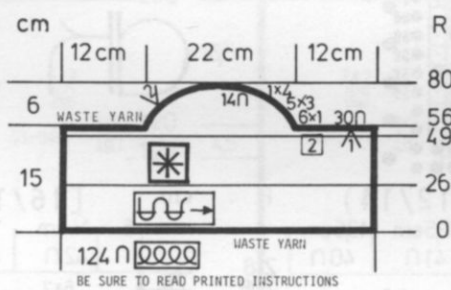

BE SURE TO READ PRINTED INSTRUCTIONS

DK 539

WOMAN'S SKIRT & JACKET

SIZES: 8/10 (12/14) [16/18]
 YARN: Fortissima
 GRAMS: color 1 500 550 600
 color 2 200 250 250
 TENSION: 7 to 9
 GAUGE: 15 sts. 19 rows = 5 cm (2")

Stockinette stitch with a Norwegian Design on the Jacket. Punch your own Card.

FINISHING: See General Instructions. When sewing on the front band, leave openings along right front for buttonholes. Bands are Ribbed.



JACKET BACK: II

Cast on 136 (146) [156] sts. with color 1 and work 30 rows K1, P1 Ribbing (or K2, P2).

Continue in the Norwegian Design. Knit to Row 132 (132) [140].

SHAPE ARMHOLE: ON EACH SIDE, bind off 3 sts. 2x, 2 sts. 2x, 1 st. 2x. (3 sts. 2x, 2 sts. 2x, 1 st. 2x). [3 sts. 2x, 2 sts. 2x, 1 st. 2x]. Knit to Row 190 (200) [206].

SHAPE SHOULDER and watch for NECK SHAPING:

ON EACH SIDE, bind off 8 sts. 4x, 6 sts. 1x. (8 sts. 4x, 9 sts. 1x). [7 sts. 6x].

FOR NECK: After Row 194 (204) [210], bind off the center 12 (16) [20] sts., put the needles on the left into holding position and complete the right side first. *ON NECK SIDE, bind off 4 sts. 3x for all sizes.

Bring the needles on the left into working position, knit 1 row in Pattern to the left side, turn the Row Counter back to 194 (204) [210] and complete the left half. Follow the instructions from * and don't forget to complete the shoulder shaping.

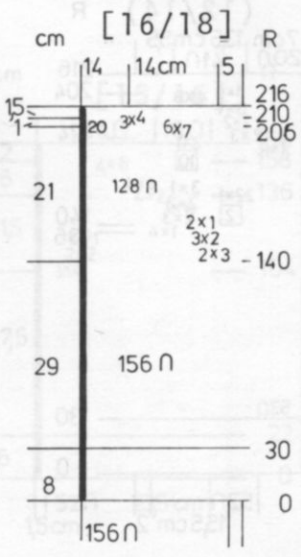
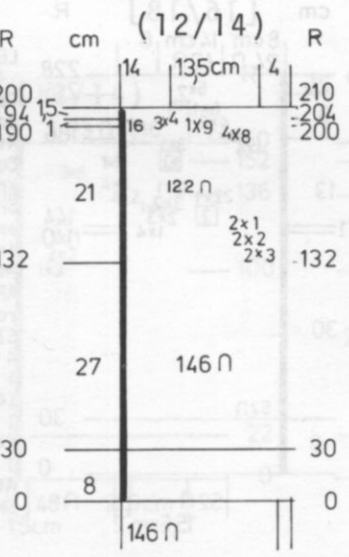
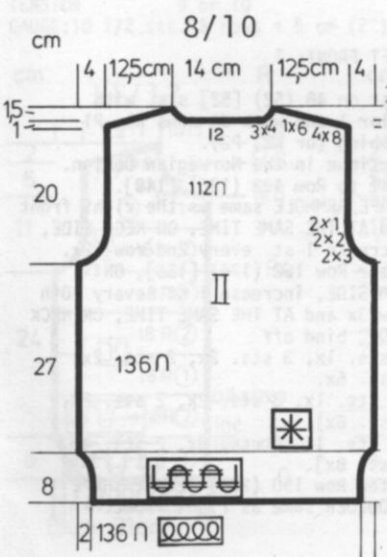

Continued

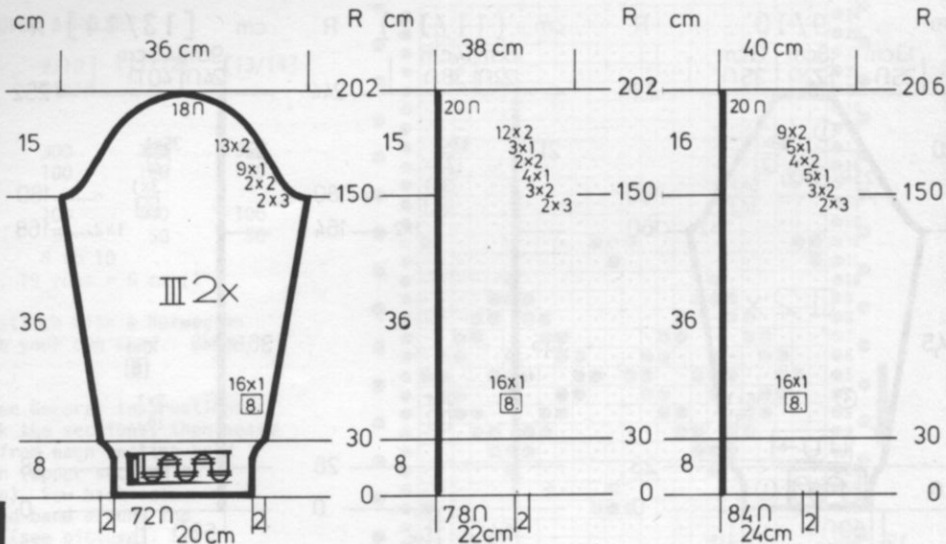
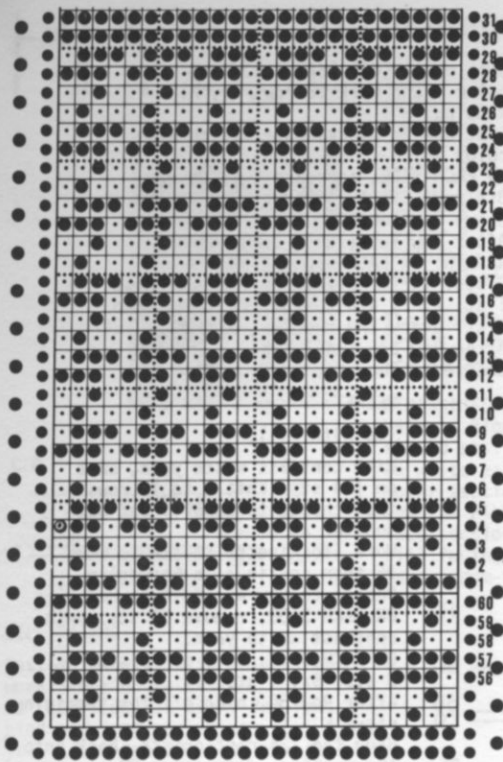

dk 539

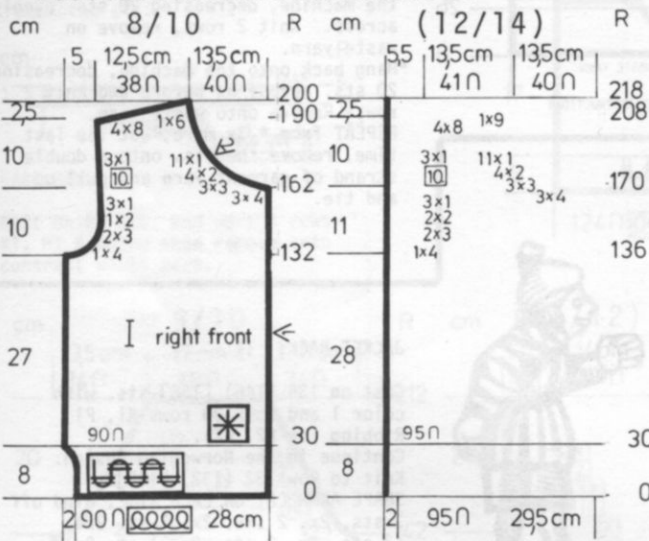

JACKET - RIGHT FRONT: I

Cast on 90 (95) [100] sts. with color 1 and work 30 rows K1, P1 Ribbing (or K2, P2). Continue in the Norwegian Design. Knit to Row 131 (135) [143]. SHAPE ARMHOLE: Bind off 4 sts. 1x, 3 sts. 2x, 2 sts. 1x, 1 st. 3x. (4 sts. 1x, 3 sts. 2x, 2 sts. 2x, 1 st. 3x). [4 sts. 1x, 3 sts. 2x, 2 sts. 3x, 1 st. 2x]. After Row 162 (170) [178], SHAPE NECK and on arm side, increase 1 st. every 10th row 3x. FOR NECK, bind off 4 sts. 3x, 3 sts. 3x, 2 sts. 4x, 1 st. 11x. (same as first size). [4 sts. 3x, 3 sts. 3x, 2 sts. 5x, 1 st. 11x]. After Row 191 (209) [217], SHAPE SHOULDER: Bind off 8 sts. 4x, 6 sts. 1x. (8 sts. 4x, 9 sts. 1x). [7 sts. 6x].

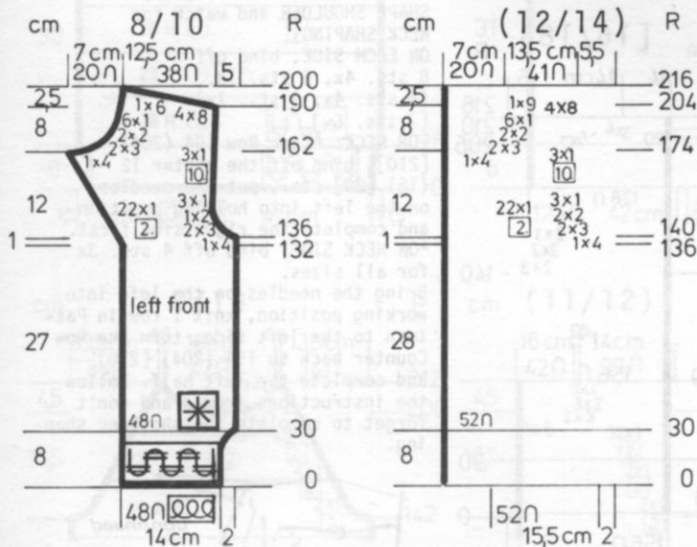

LEFT FRONT: I

Cast on 48 (52) [52] sts. with color 1 and work 30 rows K1, P1 Ribbing (or K2, P2). Continue in the Norwegian Design. Knit to Row 132 (136) [140]. SHAPE ARMHOLE same as the right front and AT THE SAME TIME, ON NECK SIDE, increase 1 st. every 2nd row 22x. After Row 162 (174) [186], ON ARM SIDE, increase 1 st. every 10th row 3x and AT THE SAME TIME, ON NECK SIDE, bind off 4 sts. 1x, 3 sts. 2x, 2 sts. 2x, 1 st. 6x. (4 sts. 1x, 3 sts. 2x, 2 sts. 2x, 1 st. 6x). [4 sts. 1x, 3 sts. 3x, 2 sts. 4x, 1 st. 6x]. After Row 190 (204) [216], SHAPE SHOULDER same as right front.

SLEEVES: III

Cast on 72 (78) [84] sts. with color 1 and work 30 rows K1, P1 Ribbing (or K2, P2). Transfer the Ribber sts. to the main machine and for the first 2 sizes only, increase 4 sts. evenly across. Continue in the Norwegian Design. ON EACH SIDE, increase 1 st. every 8th row 16x.

After Row 150, SHAPE CAP:

ON EACH SIDE, bind off 3 sts. 2x, 2 sts. 2x, 1 st. 9x, 2 sts. 13x. (3 sts. 2x, 2 sts. 3x, 1 st. 4x, 2 sts. 2x, 1 st. 3x, 2 sts. 12x). [3 sts. 2x, 2 sts. 3x, 1 st. 5x, 2 sts. 4x, 1 st. 5x, 2 sts. 9x]. After Row 202 (202) [206], bind off the remaining sts.

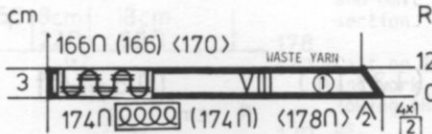

NECKBAND: VIII

Cast on 174 (174) [178] sts. with color 1 and work K1, P1 (or K2, P2) Ribbing. ON THE RIGHT, on every 2nd row, decrease 1 st. 4x. After Row 12, remove the sts. onto contrast waste yarn.

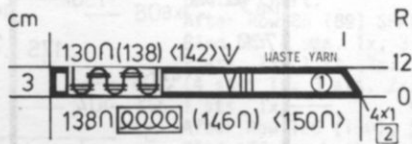

FRONT BAND: VIII

Cast on 138 (146) [150] sts. with color 1 and work K1 P1 (or K2, P2) Ribbing. ON THE RIGHT, on every 2nd row, decrease 1 st. 4x. After Row 12, remove the sts. onto contrast waste yarn.

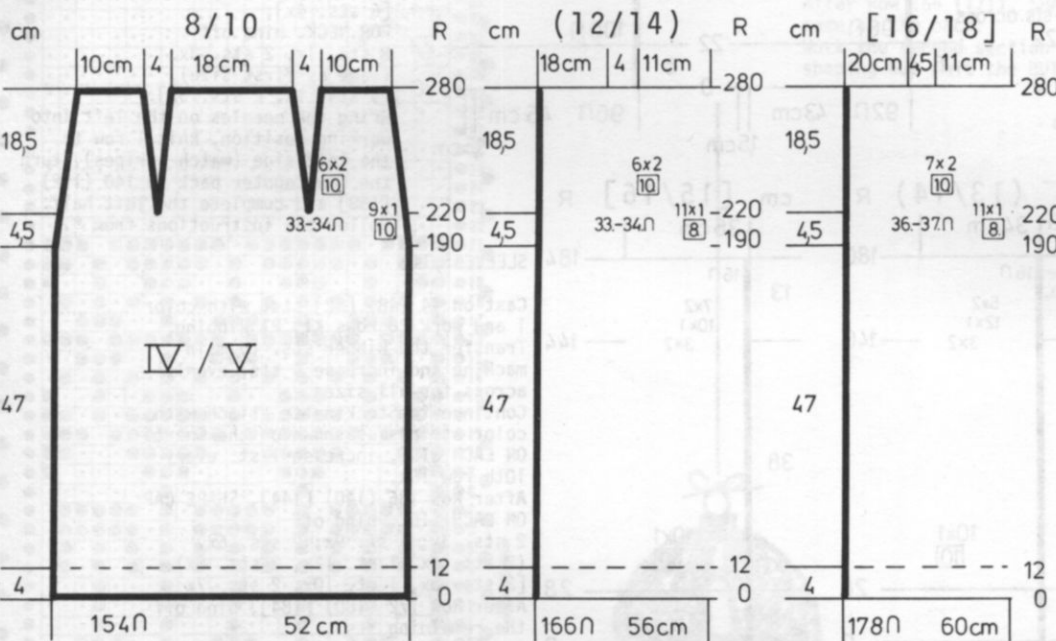

SKIRT FRONT & BACK: IV/V (2 sections)

Cast on 154 (166) [178] sts. with color 1 and work Stockinette stitch. Knit to Row 190. ON EACH SIDE, decrease 1 st. every 10th row 9x (every 8th row 11x) [every 8th row 11x] BUT AT THE SAME TIME, after Row 220, SHAPE THE DARTS. ON EACH SIDE OF THE CENTER, hang the 33rd & 34th (33rd & 34th) [36th & 37th] sts. onto the neighboring needles and move the sts. in to fill the empty needles. REPEAT THE DART decreases directly above, every 10th row 5x (5x) [6x] more. After Row 280, bind off the remaining sts.

KK 540

CHILD'S JACKET

SIZES: Years 11/12 (13/14) [15/16]
YARN: Euro Sport
GRAMS: color 1 350 400 450; color 2 200 250 300
TENSION 9 or 10
GAUGE: 10 1/2 sts. 15 rows = 5 cm (2")

Stockinette stitch with color stripes as shown on the Chart. Bands are K1, P1 Ribbing.

FINISHING: See General Instructions.

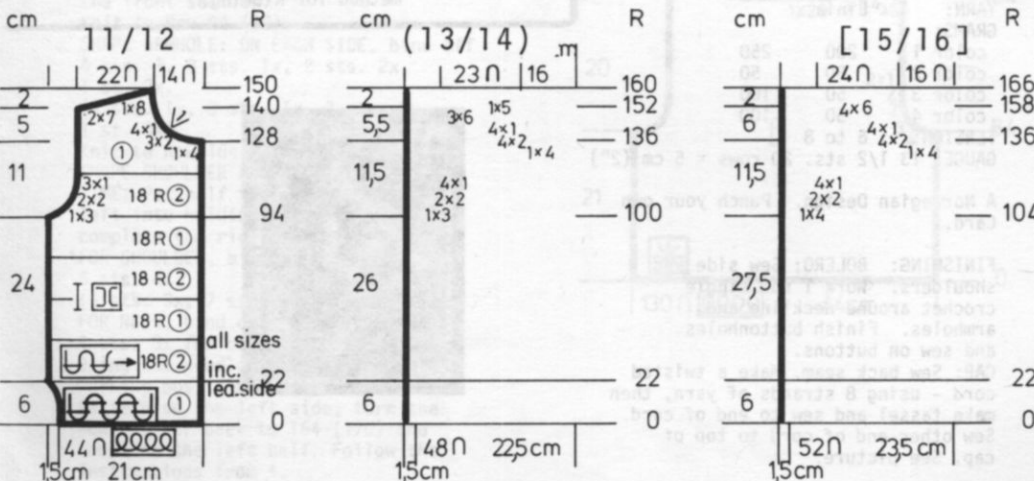

FRONT: I Make 1, reverse 1.

Cast on 44 (48) [52] sts. and work 22 rows K1, P1 Ribbing. Transfer the Ribber stitches to main machine and increase 1 st. on each side. Continue in stockinette stitch with color stripes as shown on the Chart. Knit to Row 95 (101) [105]. SHAPE ARMHOLE on the left same as you did the back and AFTER ROW 128 (136) [136], SHAPE NECK: Bind off 4 sts. 1x, 2 sts. 3x, 1 st. 4x (4 sts. 1x, 2 sts. 4x, 1 st. 4x) [4 sts. 1x, 2 sts. 4x, 1 st. 4x] SHAPE SHOULDER same as the back after Row 141 (153) [159].



KK 540

11/12

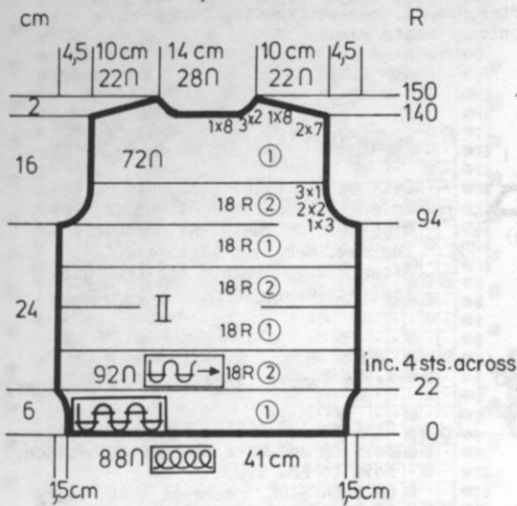

(13/14)

[15/16]

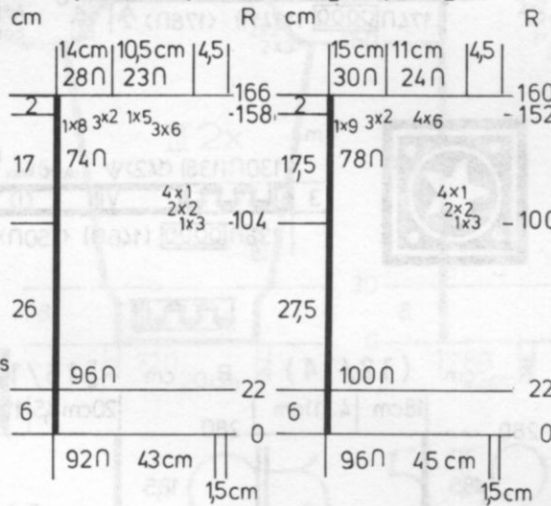

BACK: II

Cast on 88 (92) [96] sts. with color 1 and work 22 rows K1, P1 Ribbing. Transfer the Ribber sts. to main machine and increase 4 sts. evenly across then continue in Stockinette stitch with color stripes as shown on the Chart.
 Knit to Row 94 (100) [104].
 SHAPE ARMHOLE: ON EACH SIDE, bind off 3 sts. 1x, 2 sts. 2x, 1 st. 3x. (3 sts. 1x, 2 sts. 2x, 1 st. 4x). [3 sts. 1x, 2 sts. 2x, 1 st. 4x]. Knit to Row 140 (152) [158].
 SHAPE SHOULDER AND NECK AT THE SAME TIME. Put half the sts. on the left into holding position and complete the right side first.
 *FOR SHOULDER, bind off 7 sts. 2x, 8 sts. 1x; (6 sts. 3x, 5 sts. 1x); [6 sts. 4x];
 FOR NECK, bind off 8 sts. 1x, 2 sts. 3x. (same as first size). [9 sts. 1x, 2 sts. 3x].
 Bring the needles on the left into working position, knit 1 row to the left side (watch stripes), turn the Row Counter back to 140 (152) [158] and complete the left half. Follow the instructions from *.

11/12

(13/14)

[15/16]

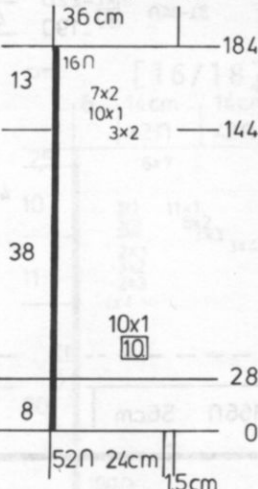
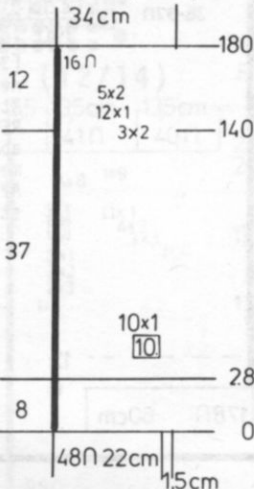
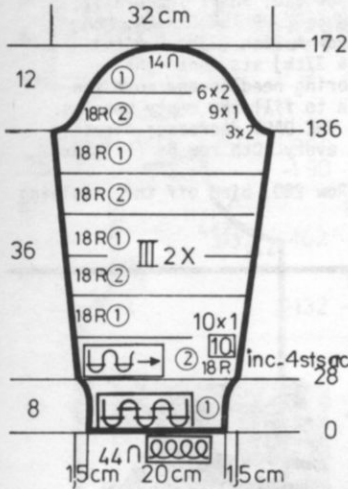

SLEEVES: III

Cast on 44 (48) [52] sts. with color 1 and work 28 rows K1, P1 Ribbing. Transfer the Ribber sts. to main machine and increase 4 sts. evenly across for all sizes.
 Continue in Stockinette stitch with color stripes as shown on the Chart. ON EACH SIDE, increase 1 st. every 10th row 10x.
 After Row 136 (140) [144], SHAPE CAP: ON EACH SIDE, bind off 2 sts. 3x, 1 st. 9x, 2 sts. 6x. (2 sts. 3x, 1 st. 12x, 2 sts. 5x). [2 sts. 3x, 1 st. 10x, 2 sts. 7x].
 After Row 172 (180) [184], bind off the remaining sts.

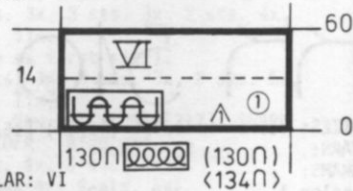

COLLAR: VI

Cast on 130 (130) [134] sts. with color 1 and work 60 rows K1, P1 Ribbing, then bind off the crochet method for Ribbing.

KK 541

WOMAN'S BOLERO & CAP

SIZES: 8/10 (12/14)

YARN: Binia

GRAMS:
 color 1 200 250
 color 2 50 50
 color 3 50 100
 color 4 50 100

TENSION: 6 to 8

GAUGE: 13 1/2 sts. 20 rows = 5 cm (2")

A Norwegian Design. Punch your own Card.

FINISHING: BOLERO: Sew side and shoulders. Work 1 row single crochet around neckline and armholes. Finish buttonholes and sew on buttons.

CAP: Sew back seam. Make a twisted cord - using 8 strands of yarn, then make tassel and sew to end of cord. Sew other end of cord to top of cap. See picture.



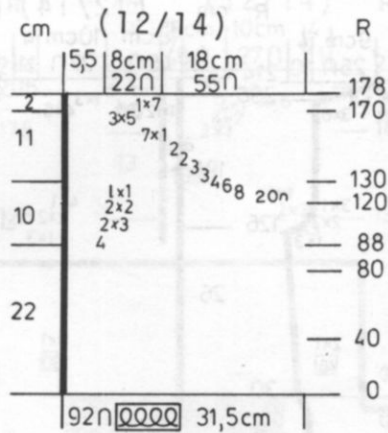
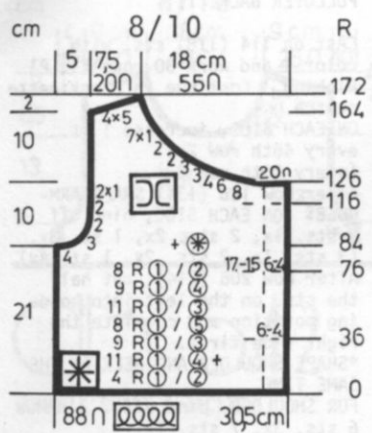

BOLERO FRONT: I Make 1, reverse 1 and omit the buttonholes in 2nd section.

Cast on 88 (92) sts. with color 1 and work the Norwegian Design following the Chart for the color changes.

Work **BUTTONHOLES** over needles 4 to 6 and 15 to 17 counting from the right edge after the rows shown on the Chart.

After Row 85 (89) **SHAPE ARMHOLE:** Bind off 4 sts. 1x, 3 sts. 1x, 2 sts. 2x, 1 st. 2x. (4 sts. 1x, 3 sts. 2x, 2 sts. 2x, 1 st. 1x).

After Row 126 (130), **SHAPE NECK:** Bind off for both sizes, 20 sts. 1x, 8 sts. 1x, 6 sts. 1x, 4 sts. 1x, 3 sts. 2x, 2 sts. 2x, 1 st. 7x.

After Row 165 (171), **SHAPE SHOULDER** same as the back.

Work the second section with reverse shaping but omit the **BUTTONHOLES**.

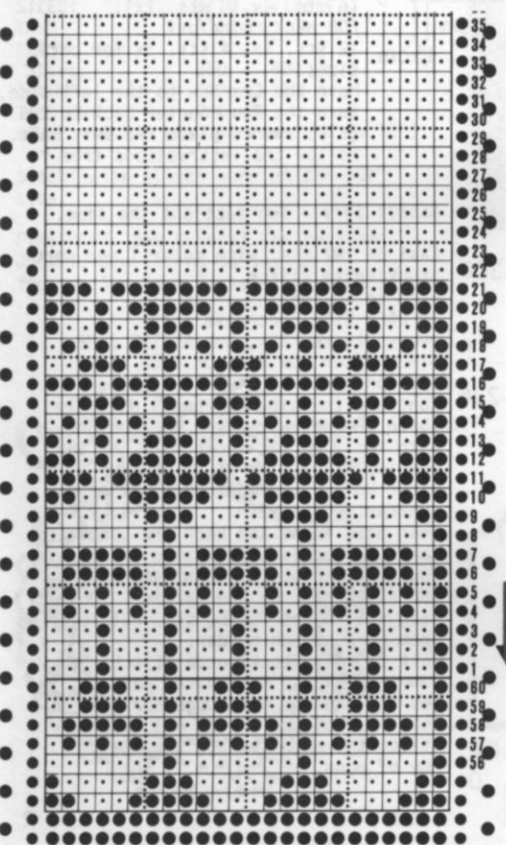

BOLERO BACK: II

Cast on 130 (136) sts. with color 1 and work the Norwegian Design, following the color changes as shown on the front section.

Knit to Row 84 (88).

SHAPE ARMHOLE: ON EACH SIDE, bind off 4 sts. 1, 3 sts. 1x, 2 sts. 2x, 1 st. 2x. (4 sts. 1x, 3 sts. 1x, 2 sts. 2x, 1 st. 3x).

Knit to Row 164 (170).

SHAPE SHOULDER AND NECK AT THE SAME TIME: Put half the sts. on the left into holding position, and complete the right side first.

***FOR SHOULDER, bind off** 5 sts. 4x; (5 sts. 3x, 7 sts. 1x); **FOR NECK, bind off** 20 sts. 1x, 4 sts. 3x for both sizes.

Bring the needles on the left into working position, knit 1 row in Pattern to the left side, turn the Row Counter back to 164 (170) and complete the left half. Follow the instructions from *.

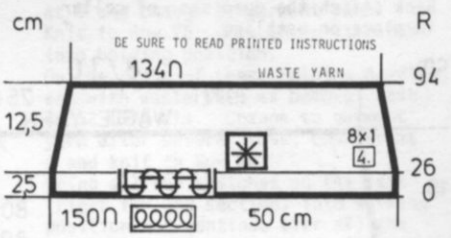
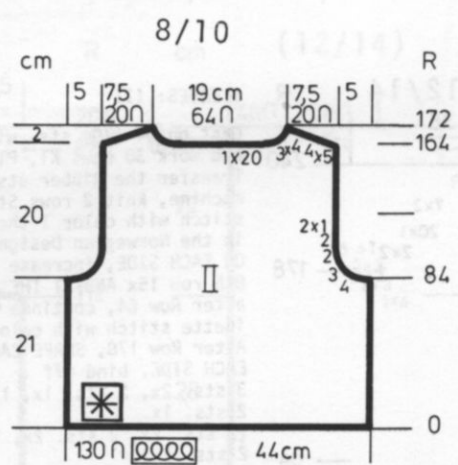

CAP:

Cast on 150 sts. and work 26 rows K1, P1 Ribbing.

Continue in the Norwegian Design. ON EACH SIDE, decrease 1 st. every 4th row 8x.

After Row 94, remove the sts. onto contrast waste yarn.

Hang the sts. back onto the machine with every 6th & 7th sts. together. Knit 2 rows Stockinette stitch.

Hang every 5th & 6th sts. together and move the sts. in to fill empty needles. Knit 1 row. Continue to decrease (4th & 5th, 3rd & 4th, etc) ON EVERY ROW until 6 sts. remain.

Remove the sts. onto end of yarn and pull together.

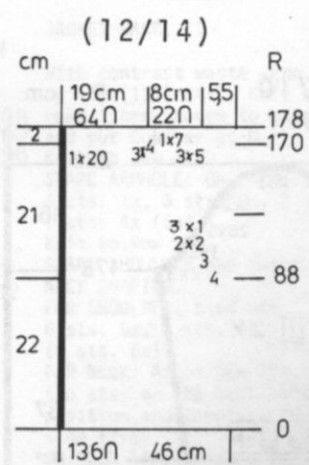

dk 541

WOMAN'S SKIRT & PULLOVER

SIZES: 8/10 (12/14)
YARN: Binia
GRAMS:
 Skirt-color 1 500 550
 Pullover
 color 1 300 350
 color 2 50 50
TENSION: 6 to 8
GAUGE: 13 1/2 sts. 20 rows = 5 cm (2")
 Small amount of Taffeta for pocket lining of skirt.

Stockinette stitch with Norwegian Design on lower section of Sleeves.
 Bands are K1, P1 Ribbing.

FINISHING: Skirt: Sew up the side seams to pocket opening. Fold pocket facings to inside. Make a pocket from taffeta and sew to facings on the inside.
PULLOVER: See General Instructions. Back stitch the open sts. of collar in place on neckline.

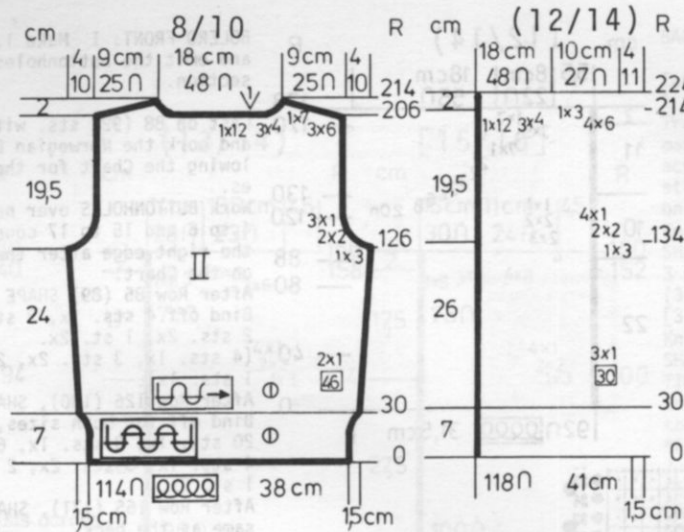

PULLOVER BACK: II

Cast on 114 (118) sts. with color 1 and work 30 rows K1, P1 Ribbing. Continue in Stockinette stitch.
 ON EACH SIDE, increase 1 st. every 46th row 2x. (every 30th row 3x).
 After Row 126 (134) SHAPE ARM-HOLE: ON EACH SIDE, bind off 3 sts. 1x, 2 sts. 2x, 1 st. 3x. (3 sts. 1x, 2 sts. 2x, 1 st. 4x).
 After Row 206 (214), put half the sts. on the left into holding position and complete the right side first.
 *SHAPE SHOULDER AND NECK AT THE SAME TIME.
 FOR SHOULDER, bind off 6 sts. 3x, 7 sts. 1x; (6 sts. 4x, 3 sts. 1x);
 FOR NECK, bind off 12 sts. 1x, 4 sts. 3x for both sides.
 Move the Cam Box to the left side, turn the Row Counter back to 206 (214) and complete the left half. Follow the instructions from *.

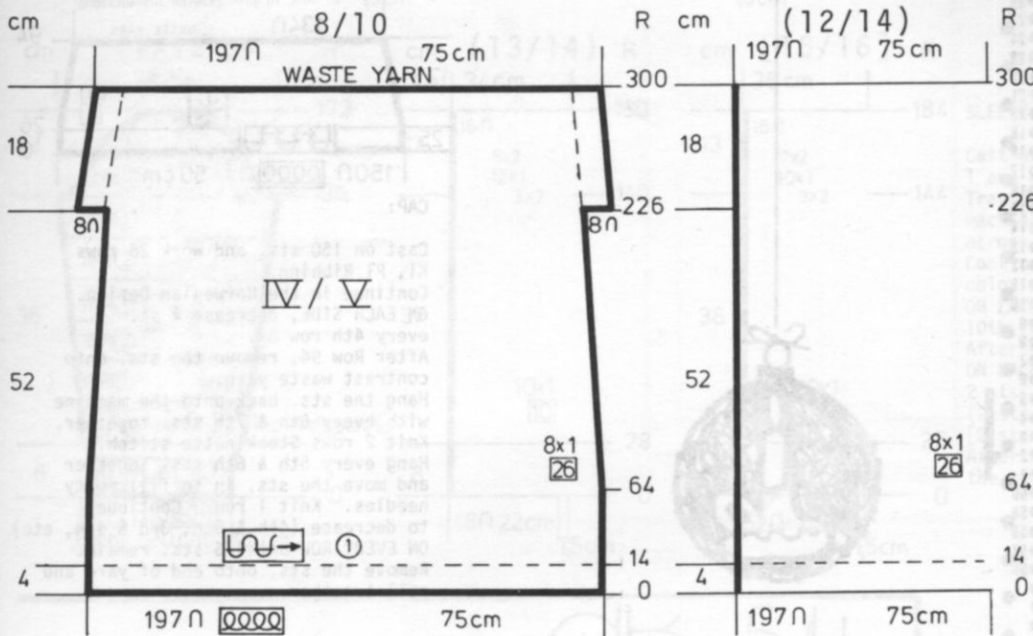

SKIRT: IV/V - Two sections the same.

Cast on 197 sts. with color 1 and work Stockinette stitch.
 Knit to Row 64.
 ON EACH SIDE, decrease 1 st. every 8th row 26x, but AT THE SAME TIME, after Row 226, ON EACH SIDE cast on 8 sts. for pocket facing. Continue the side decreases directly above the decreases you made before, with the 8 pocket facing sts. on the outside.
 After Row 300, remove the sts. onto contrast waste yarn.
 When both front and back are completed, hang the sections back onto the machine doubling the sts. so that you have 180 (190) sts. on the machine. Do not hang the pocket facing sts. but leave them on a stitch holder.
 Knit 34 rows Stockinette stitch then remove the sts. onto waste yarn. Sew the ends of band together then fold over to the inside and back stitch the open sts. to the first row of band.

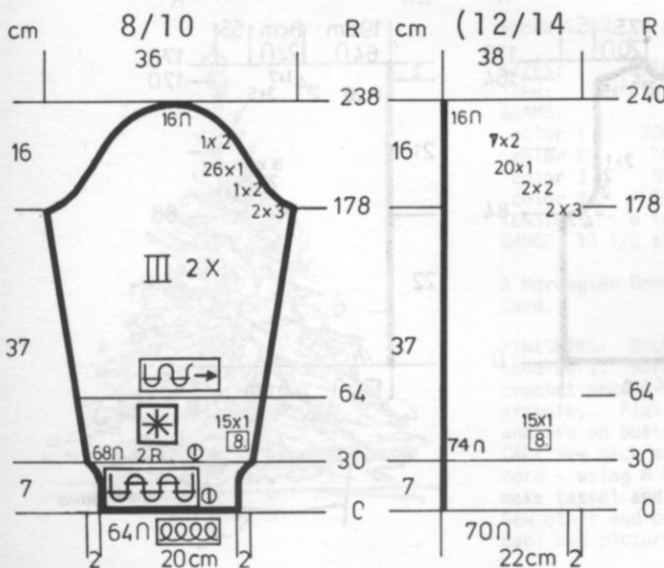

SLEEVES: III

Cast on 64 (70) sts. with color 1 and work 30 rows K1, P1 Ribbing. Transfer the Ribber sts. to main machine, knit 2 rows Stockinette stitch with color 1 then continue in the Norwegian Design.
 ON EACH SIDE, increase 1 st. every 8th row 15x AND AT THE SAME TIME after Row 64, continue in Stockinette stitch with color 1.
 After Row 178, SHAPE CAP: ON EACH SIDE, bind off 3 sts. 2x, 2 sts. 1x, 1 st. 26x, 2 sts. 1x. (3 sts. 2x, 2 sts. 2x, 1 st. 20x, 2 sts. 7x).
 After Row 238 (240) bind off the remaining sts.

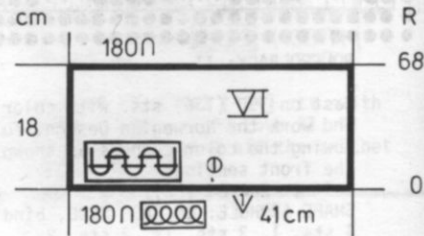

COLLAR: VI

Cast on 180 sts. with color 1 and work 68 rows K1, P1 Ribbing then bind off the crochet method for Ribbing.



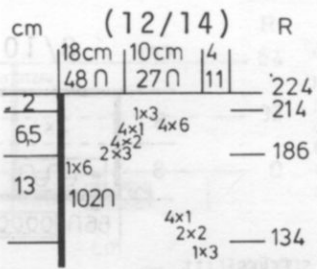
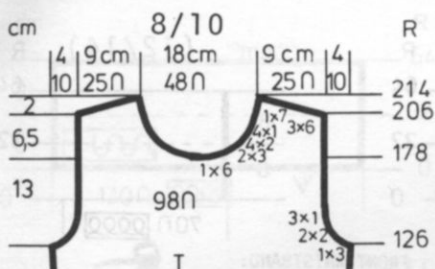

FRONT: I

Work the front the same as the back to Row 126 (134).
 SHAPE ARMHOLE SAME AS THE BACK, then knit to Row 178 (186).
 Put half the sts. on the left into holding position and complete the right side first.
 *ON NECK SIDE, bind off 6 sts. 1x, 3 sts. 2x, 2 sts. 4x, 1 st. 4x for both sizes and after Row 206 (214), SHAPE SHOULDER same as the back.
 Move the Cam Box to the left side, turn the Row Counter back to 178 (186) and complete the left half. Follow the instructions from *



dk 542

WOMAN'S SKIRT & JACKET

SIZES: 8/10 (12/14)
 YARN: Allegro
 GRAMS: Skirt: 350 400
 Jacket: 500 550
 TENSION: 7 to 9
 GAUGE: 14 1/2 sts. 20 rows = 5 cm (2")



JACKET FRONT: I Make 1, reverse 1

With contrast waste yarn, and on the LEFT SIDE OF 0, cast on 24 sts. and work Stockinette stitch. Knit several rows, then put counter at 0 and change to garment yarn. Knit to Row 76. Put these stitches into holding position. On the right of these holding needles, and with waste yarn as before, cast on 52 (57) sts. Change to garment yarn after several rows, counter at 0 and knit to Row 76. Bring all the stitches on the left (right for 2nd section) into working position and continue over all the needles. Knit to Row 113. SHAPE ARMHOLE: Bind off 4 sts. 1x, 3 sts. 2x, 2 sts. 3x, 1 st. 2x. (4 sts. 1x, 3 sts. 2x, 2 sts. 3x, 1 st. 5x). Knit to Row 172. SHAPE NECK: Bind off for both sizes (same as neck facing) 5 sts. 1x, 4 sts. 1x, 3 sts. 2x, 2 sts. 2x, 1 st. 5x, and SHAPE SHOULDER same as the back after Row 197. Work the 2nd section with reverse shaping, casting on from right to left. CAM BOX WILL BE ON THE LEFT SIDE AT ROW 0.

Stockinette stitch worn on the pur1 side.

FINISHING: See General Instructions.
 JACKET: Sew lining to inside of fronts. Sew in a jacket type zipper.

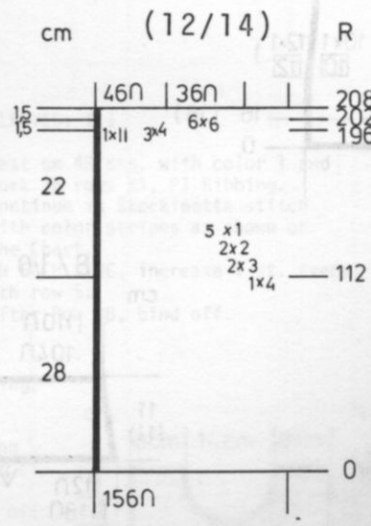
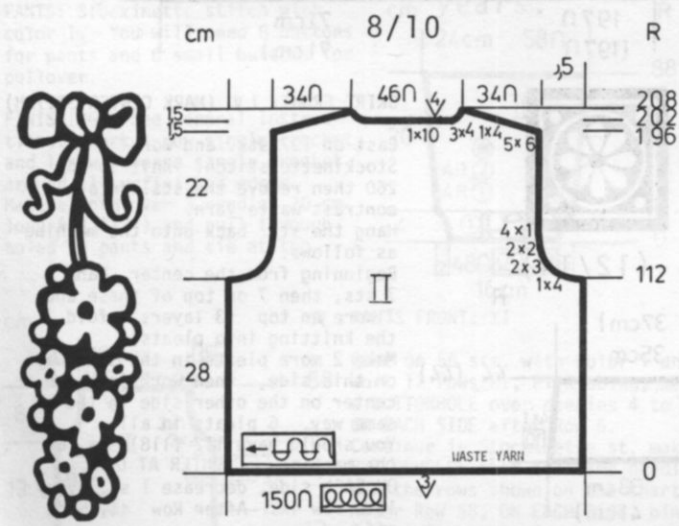
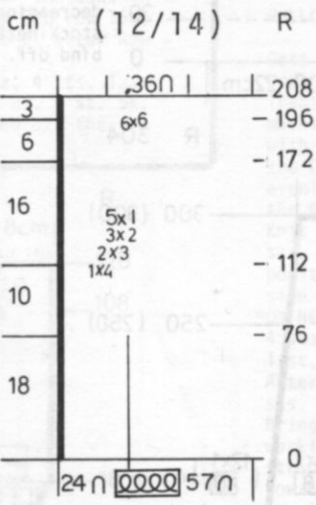
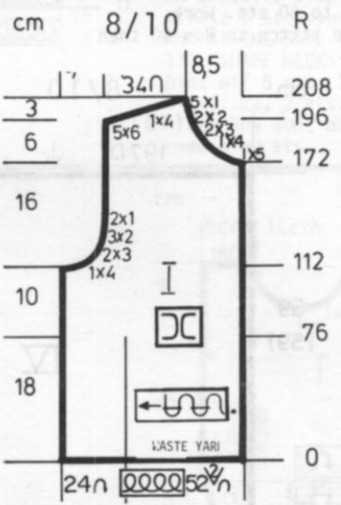

JACKET BACK: II

With contrast waste yarn, cast on 150 (156) sts. Knit several rows, then change to garment yarn and put Counter at 0. Knit to Row 112. SHAPE ARMHOLE: ON EACH SIDE, bind off 4 sts. 1x, 3 sts. 2x, 2 sts. 2x, 1 st. 4x (5x). Knit to Row 196. SHAPE SHOULDER and watch for NECK SHAPING. FOR SHOULDER, bind off 6 sts. 5x, 4 sts. 1x. (6 sts. 6x). FOR NECK: After Row 202, put half the sts. on the left into holding position and complete the right side first.
 *ON NECK SIDE, bind off 10 (11) sts. 1x, 4 sts. 3x. Move the Cam Box to the left side, turn the Row Counter back to 202 and complete the left half. Follow the instructions from * and don't forget to complete the shoulder shaping.

Continued



dk 542

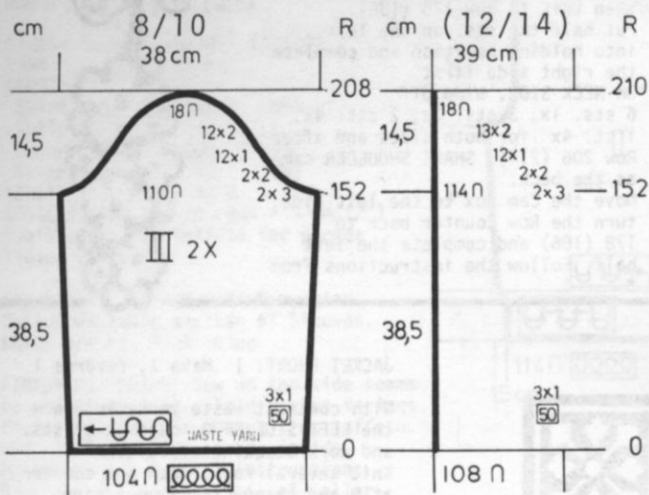

SLEEVES: III

With contrast waste yarn, cast on 104 (108) sts. Knit 8 to 10 rows, change to garment yarn and put Counter at 0. Continue in Stockinette stitch. ON EACH SIDE, increase 1 st. every 50th row 3x. After Row 152, SHAPE CAP: ON EACH SIDE, bind off 3 sts. 2x, 2 sts. 2x, 1 st. 12x, 2 sts. 12x. (3 sts. 2x, 2 sts. 2x, 1 st. 12x, 2 sts. 13x). After Row 208 (210), bind off the remaining sts.

FRONT WAISTBAND:

Hang the open sts. of one front back onto the machine, (ALL THE STS.) decreasing to 66 (70) sts. Knit to Row 64 then remove the sts. onto contrast waste yarn (or you can bind off). Repeat for other front.

FRONT POCKET FACING:

Cast on 10 sts. and work 76 rows Stockinette stitch then bind off. Sew this part to front edge of pocket slit, turn to the inside and hem.

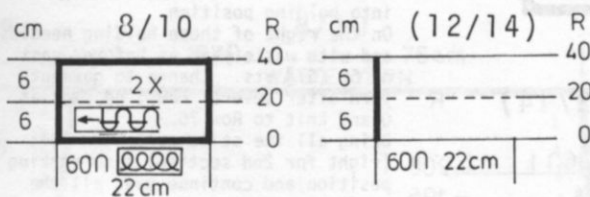

SLEEVE CUFFS: Hang the open cast on sts. back onto the machine, decreasing to 60 sts. Work stockinette stitch to Row 40 then bind off.

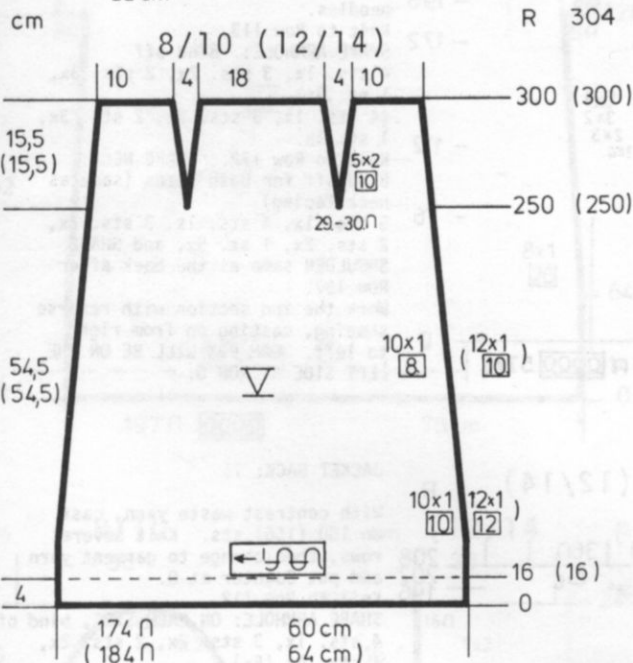

SKIRT BACK: V

Cast on 174 (184) sts. and work Stockinette stitch. Knit to Row 16. ON EACH SIDE, decrease 1 st. every 10th row 10x, every 8th row 10x. (every 12th row 12x, every 10th row 12x). After Row 250, work the DARTS. Counting from the center, ON EACH SIDE, hang the 29th & 30th sts. together. REPEAT THE DART DECREASES every 10th row 4x more over the same needles as before. After Row 300, bind off the remaining sts.

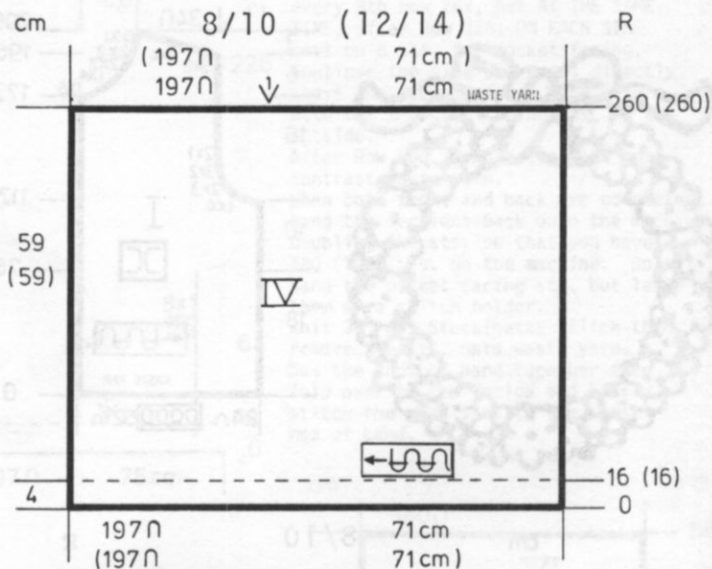

SKIRT FRONT: I V (MARK CENTER STITCH)

Cast on 197 sts. and work Stockinette stitch. Knit to Row 260 then remove the sts. onto contrast waste yarn. Hang the sts. back onto the machine as follows: Beginning from the center, hang 7 sts, then 7 on top of these and 7 more on top (3 layers - fold the knitting into pleats). Make 2 more pleats in the same way on this side, then work from the center on the other side in the same way. 6 pleats in all. You should have 112 (118) sts. on the machine. COUNTER AT 0. ON EACH side, decrease 1 st. every 10th row 4x. After Row 44, bind off.

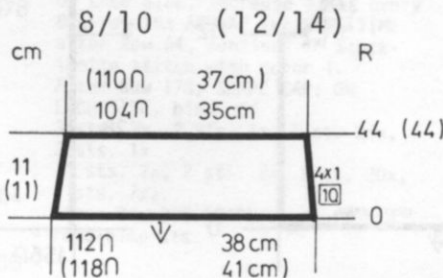

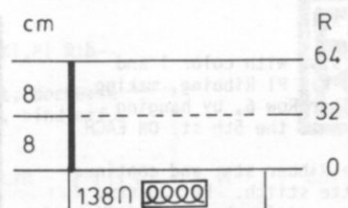
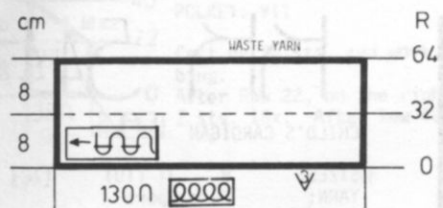

JACKET BACK WAISTBAND:
 Hang the open cast on sts. of the back section back onto the machine, decreasing to 130 (138) sts. Work 64 rows Stockinette stitch then remove old contrast waste yarn or you can bind off.

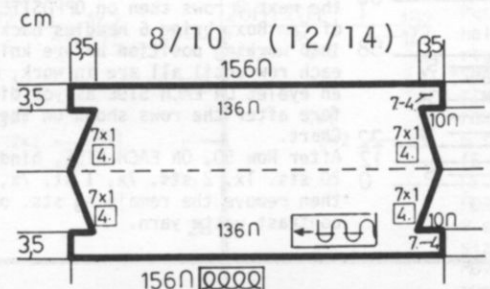
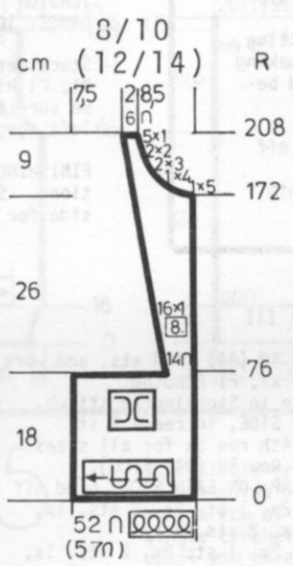

COLLAR:
 Cast on 156 sts. and work Stockinette stitch.
 After Row 7, make **BUTTONHOLE** on the right side over needles 4 to 7.
 After Row 14, ON EACH SIDE, bind off 10 sts.
 ON EACH SIDE, increase 1 st. every 4th row 7x.
 Mark Row 50 on each side for center fold.
 ON EACH SIDE, decrease 1 st. every 4th row 7x.
 After Row 86, ON EACH SIDE, cast on 10 sts.
 After Row 93, make **BUTTONHOLE** over needles 4 to 7 on the right side.
 After Row 100, bind off.

FRONT FACING: Make 1, reverse 1.
 Cast on 52 (57) sts. and work Stockinette stitch.
 Knit to Row 76.
 ON OPPOSITE SIDE OF CAM BOX, bind off 38 (43) sts. (use separate yarn to bind off).
 ON OPPOSITE SIDE OF CAM BOX, increase 1 st. every 8th row 16x, AND AT THE SAME TIME, after Row 172, SHAPE NECK:
 Bind off 5 sts. 1x, 4 sts. 1x, 3 sts. 2x, 2 sts. 2x, 1 st. 5x.
 After Row 208, bind off the remaining sts.



PULLOVER FRONT: I
 Cast on 68 sts. with color 1 and work 18 rows K1, P1 Ribbing.
 Transfer the Ribber sts. to main machine and work Stockinette st. with color stripes as shown on the Chart, DECREASING 4 sts. evenly across when you transfer the Ribber sts.
 Knit to Row 108. Put half the sts. on the left into holding position and complete the right side first.
 *ON NECK SIDE, bind off 4 sts. 1x, 3 sts. 1x, 2 sts. 2x, 1 st. 3x.
 After Row 128, remove the remaining sts. onto contrast waste yarn.
 Bring the needles on the left into working position, knit 1 row (watch stripe) to the left side, turn the Row Counter back to 108 and complete the left half. Follow the instructions from *.

KK 543

BOY'S SUIT
 SIZES: 1 to 2 years
 YARN: Allegro
 GRAMS: color 1 100, color 2 50
 TENSION: 6 to 8
 GAUGE: 12 sts. 18 rows = 5 cm (2")

PULLOVER: Stockinette stitch with color stripes of 4 rows color 1, 4 rows color 2. Bands are Ribbed.
PANTS: Stockinette stitch with color 1. You will need 8 buttons for pants and 6 small buttons for pullover.

FINISHING: See General Instructions. Work 1 row single crochet and 1 row reverse single crochet around all unfinished edges. Make a cord over 3 needles 70 cm long (27 1/2") and pull through holes in pants and tie at top.

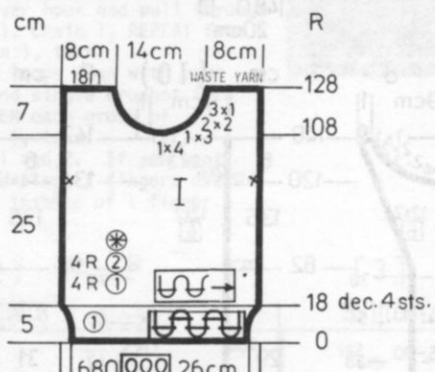

PULLOVER BACK: II
 Cast on 68 sts. with color 1 and work the same as the front to Row 122.
 Put half the sts. on the left into holding position and complete the right side first.
 *ON NECK SIDE, bind off 4 sts. 1, 3 sts. 1x, 2 sts. 2x, 1 st. 3x.
 After Row 148, bind off, or you can hang the marked row first then bind off.
 Bring the needles on the left into working position, knit 1 row to the left side (watch stripe) turn the Row Counter back to 122 and complete the left half. Follow the instructions from *.

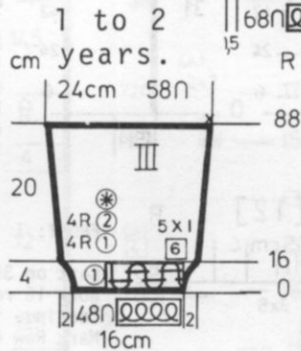

SLEEVES: III
 Cast on 48 sts. with color 1 and work 16 rows K1, P1 Ribbing.
 Continue in Stockinette stitch with color stripes as shown on the Chart.
 ON EACH SIDE, increase 1 st. every 6th row 5x.
 After Row 88, bind off.

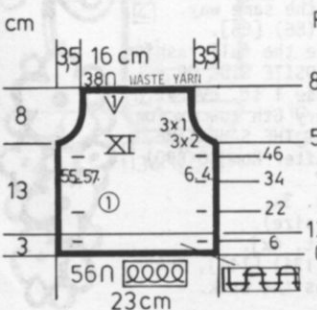

PANTS FRONT: XI
 Cast on 56 sts. with color 1 and work 12 rows K1, P1 Ribbing, making a **BUTTONHOLE** over needles 4 to 6 ON EACH SIDE after Row 6.
 Continue in Stockinette st. making **BUTTONHOLES** over the same needles after the rows shown on the Chart.
 After Row 58, ON EACH SIDE, bind off 2 sts. 3x, 1 st. 3x.
 Knit to Row 88 then remove the sts. onto waste yarn.
 Weave the open sts. of front and back together then remove the waste yarn.

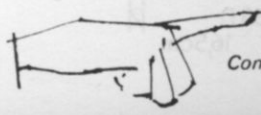
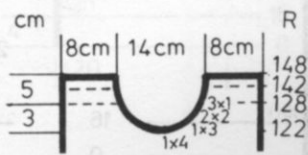

Continued

KK 543

PANTS BACK: XII

Cast on 120 sts. with color 1 and work 12 rows K1, P1 Ribbing, making an eyelet after Row 6, by hanging the 4th st. onto the 5th st. ON EACH SIDE.

R Transfer the Ribber sts. and continue in Stockinette stitch. Put 30 sts. into holding position before knitting the next 2 rows then on OPPOSITE SIDE of Cam Box, bring 6 needles back into working position before knitting each row until all are in work, making an eyelet ON EACH SIDE as you did before after the rows shown on the Chart.

After Row 50, ON EACH SIDE, bind off 20 sts. 1x, 2 sts. 7x, 1 st. 7x, then remove the remaining sts. onto contrast waste yarn.

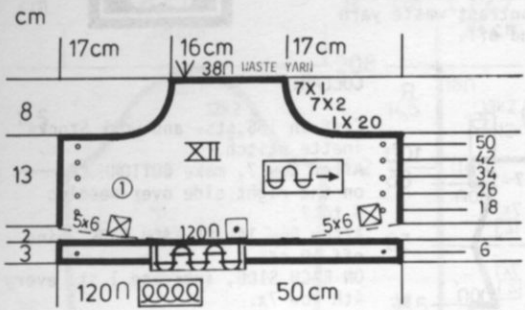

KK 544

CHILD'S CARDIGAN

SIZES: 8 (10) [12]
 YARN: Euro Sport
 GRAMS: 400 450 500
 TENSION: 9 or 10
 GAUGE: 10 sts. 14 1/2 rows = 5 cm

Stockinette stitch with all bands K1, P1 Ribbing. Pocket is ribbed. Be sure to make buttonholes on the left for a boy, right for girl.

FINISHING: See General Instructions. Sew pocket on the left side for a boy, right for a girl.

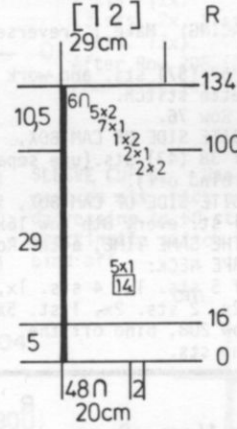
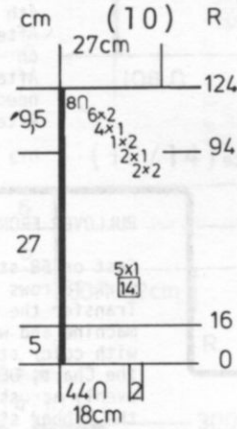
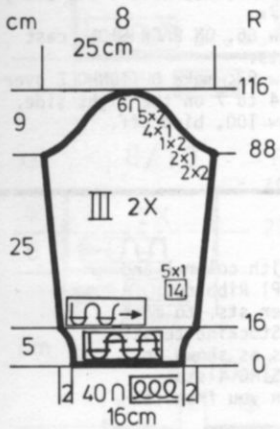

SLEEVES: III

Cast on 40 (44) [48] sts. and work 16 rows K1, P1 Ribbing. Continue in Stockinette stitch. ON EACH SIDE, increase 1 st. every 14th row 5x for all sizes. Knit to Row 88 (94) [100]. SHAPE CAP: ON EACH SIDE, bind off 2 sts. 2x, 1 st. 2x, 2 sts. 1x, 1 st. 4x, 2 sts. 5x. (2 sts. 2x, 1 st. 2x, 2 sts. 1x, 1 st. 4x, 2 sts. 6x). [2 sts. 2x, 1 st. 2x, 2 sts. 1x, 1 st. 7x, 2 sts. 5x]. After Row 116 (124) [134], bind off the remaining sts.

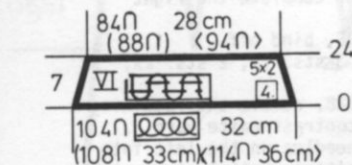

COLLAR: VI

Cast on 104 (108) [114] sts. and work 1, P1 Ribbing. ON EACH SIDE, decrease (full fashion) 2 sts. every 4th row 5x. After Row 24, bind off the crochet method for Ribbing.

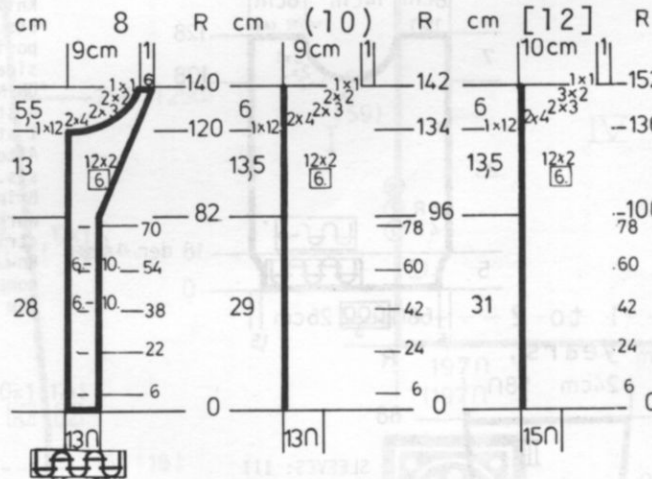

FRONT BANDS: Make 1, reverse 1 and omit BUTTONHOLES in 2nd section. Be sure to sew BUTTONHOLE BAND on the correct side - left for boy, right for girl.

Cast on 13 (13) [15] sts. and work K1, P1 Ribbing. MAKE BUTTONHOLES over needles 6 to 10 counting from the FRONT EDGE, after the Rows shown on the Chart. After Row 82 (96) [100], increase 1 st. every 6th row 12x for all sizes, and AT THE SAME TIME, after Row 121 (135) [137], SHAPE NECK: Bind off 12 sts. 1x, 4 sts. 2x, 3 sts. 2x, 2 sts. 2x, 1 st. 1x. (same as first size). [12 sts. 1x, 4 sts. 2x, 3 sts. 2x, 2 sts. 3x, 1 st. 1x]. After Row 140 (142) [152], bind off the remaining sts.

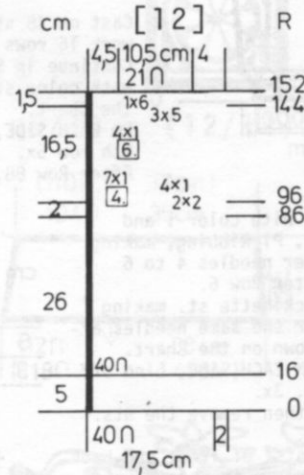
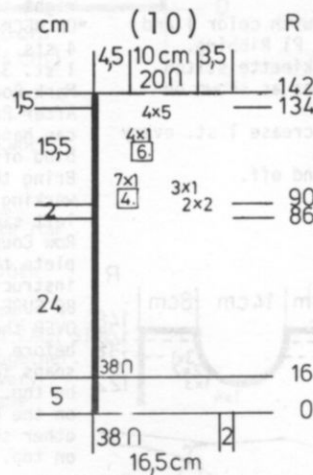
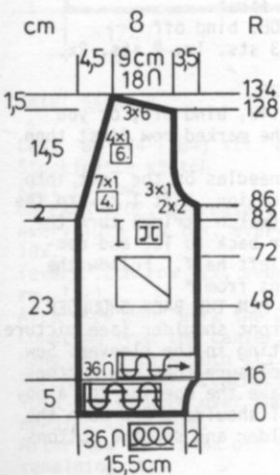

FRONT: I Make 1, reverse 1.

Cast on 36 (38) [40] sts. and work 16 rows K1, P1 Ribbing. Continue in Stockinette stitch. Mark Row 48 for pocket placement. Mark Row 72 in the same way. Knit to Row 82 (86) [86]. SHAPE FRONT: Use the full fashion method. ON OPPOSITE SIDE OF CAM BOX, decrease 1 st. every 4th row 7x, every 6th row 4x for all sizes BUT AT THE SAME TIME, SHAPE ARMHOLE after Row 86 (90) [96]. Bind off 2 sts. 2x, 1 st. 3x. (same as first size). [2 sts. 2x, 1 st. 4x]. After Row 128 (134) [144], SHAPE SHOULDER same as the back.



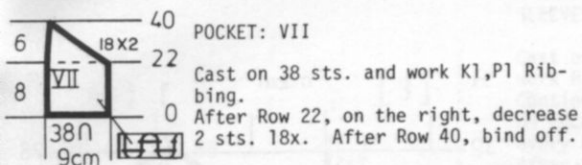

BACK: II

Cast on 76 (80) [84] sts. and work 16 rows K1, P1 Ribbing. Continue in Stockinette stitch. Knit to Row 86 (90) [96]. SHAPE ARMHOLE: ON EACH SIDE, bind off. 2 sts. 2x, 1 st. 3x. (same as first size). [2 sts. 2x, 1 st. 4x]. Knit to Row 128 (134) [144]. Put half the sts. on the left into holding position and complete the right side first.

*SHAPE SHOULDER AND NECK AT THE SAME TIME: FOR SHOULDER, bind off 6 sts. 3x; (5 sts. 4x); [5 sts. 3x, 6 sts. 1x]; FOR NECK, bind off 9 sts. 1x, 2 sts. 2x for all sizes. Move the Cam Box to the left side, turn the Row Counter back to 128 (134) [144] and complete the left half. Follow the instructions from *.

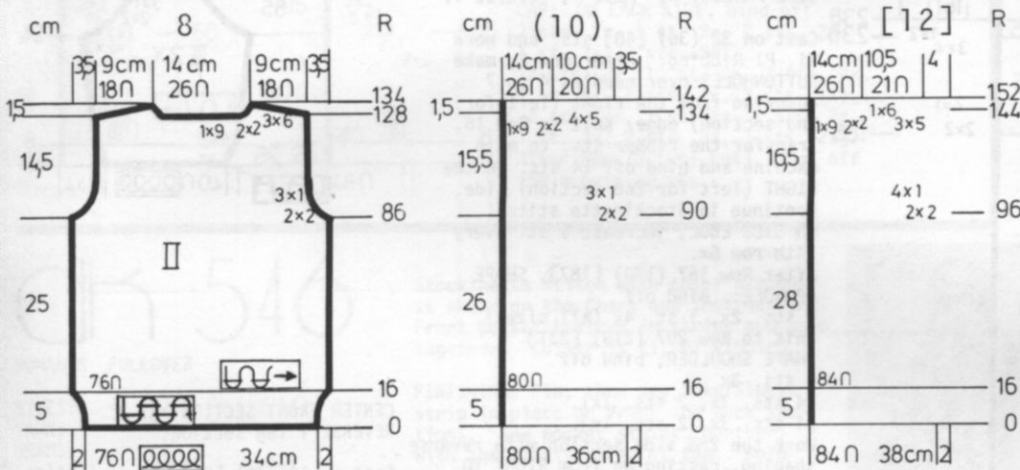

KK 545

CHILD'S SNOWSUIT

SIZES: 1 (2) [3]
 YARN: Euro Sport
 GRAMS: 500 550 600
 TENSION: 8 to 10
 GAUGE: 10 sts. 14 1/2 rows = 5 cm (2")
 2 separating zippers & 4 buttons.

Stockinette stitch with bands in K1, P1 Ribbing.

FINISHING: Snowsuit: Work 1 row sc then sew in zippers as shown in picture. Sew sides and crotch seams. Finish Buttonholes and sew on buttons.

HAT: Single crochet around front edge of hat going into every 2nd stitch. Make a row of loops. Work row of single crochet then row of loops until you have 4 rows of loops.

LOOP STITCH: ROW 1. Single crochet into first stitch. *Put hook into next stitch and place your middle finger OVER the yarn in BACK, yarn over hook and pull through (slip stitch). Chain 1, REPEAT from * to end, chain 1, turn. ROW 2: Hold loops down with your left thumb and single crochet into stitch BETWEEN each group of loops, chain 1, turn. REPEAT ROWS 1 and 2. If you want longer loops, place 2 fingers over yarn in back instead of 1 finger.



SUIT BACK: XII. Make 1, reverse 1 leg section.

Cast on 34 (38) [42] sts. and work 16 rows K1, P1 Ribbing. Continue in Stockinette stitch. ON INSIDE LEG EDGE, increase 1 st. every 10th row 4x. then increase 1 st. every 4th row 4x, every 2nd row 4x.

After Row 101 (111) [118], SHAPE CROTCH: Bind off 2 sts. 3x, 1 st. 3x, then on EVERY 4th ROW, decrease 1 st. 5x (6x) [6x].

After Row 120 (132) [142] REMOVE the sts. ONTO A STITCH HOLDER. Work the 2nd leg section with REVERSE SHAPING, casting on from RIGHT to LEFT. Cam Box will be on the LEFT SIDE at Row 0.

After Row 120 (132) [142], Hang the 2 sections together with the crotch sides in the center and decrease 1 st. on each side of the crotch.

62 (68) [72] sts. Continue working over all the sts. Knit to Row 146 (156) [162]. ON EACH SIDE, increase 1 st. every 10th row 2x.

After Row 166 (178) [186], SHAPE ARMHOLE: ON EACH SIDE, bind off 2 sts. 2x, 1 st. 4x for all sizes. Knit to Row 206 (220) [230]. SHAPE SHOULDER: ON EACH SIDE, bind off

4 sts. 2x, 5 sts. 1x. (5 sts. 3x). [5 sts. 3x, 2 sts. 1x]. After Row 212 (226) [238], bind off the remaining sts.

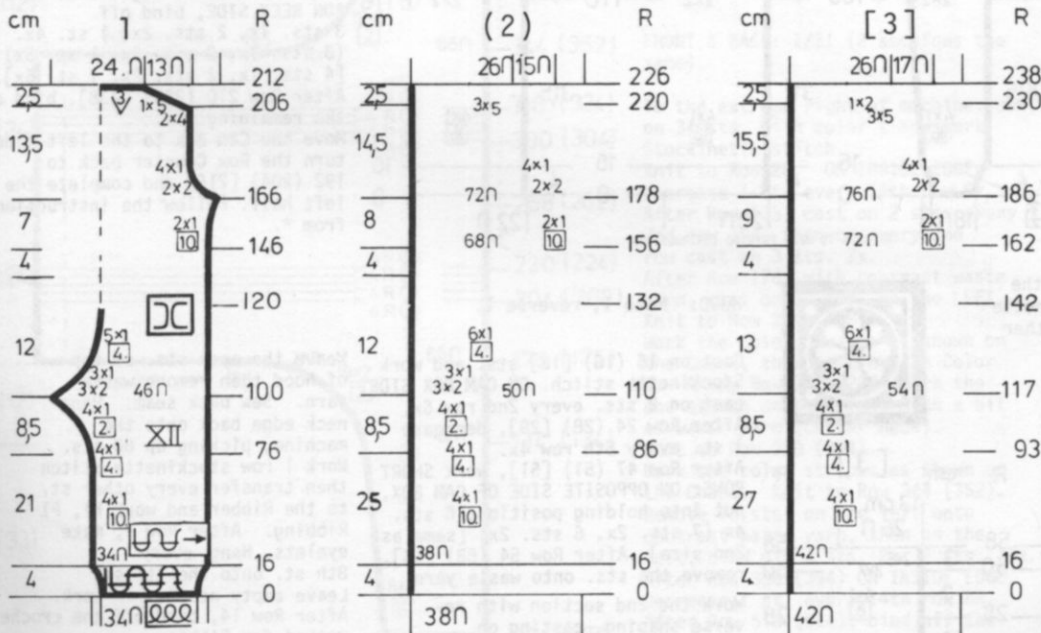

BE SURE TO READ PRINTED INSTRUCTIONS



Continued

KK 545

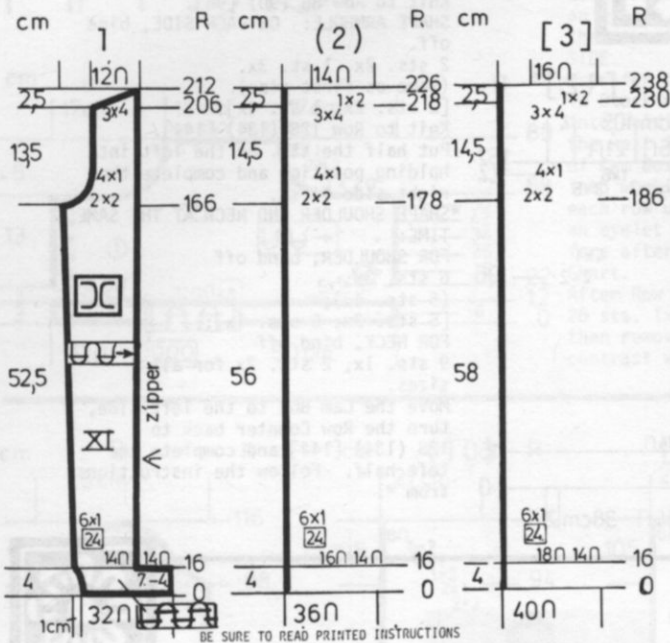

SIDE PANELS: XI Make 1, reverse 1.

Cast on 32 (36) [40] sts. and work K1, P1 Ribbing. After Row 8, make **BUTTONHOLES** over needles 4 to 7 counting from the right (left for 2nd section) edge. Knit to Row 16. Transfer the ribber sts. to main machine and bind off 14 sts. on the **RIGHT** (left for 2nd section) side. Continue in Stockinette stitch. **ON SIDE EDGE**, increase 1 st. every 24th row 6x. After Row 167 (179) [187], **SHAPE ARMHOLE**: Bind off 2 sts. 2x, 1 st. 4x (all sizes). Knit to Row 207 (219) [231]. **SHAPE SHOULDER**; bind off 4 sts. 3x (4 sts. 3x, 2 sts. 1x). [4 sts. 3x, 2 sts. 1x]. Work the 2nd side section with reverse shaping, casting on from **RIGHT TO LEFT**. Cam Box will be on the **LEFT** side at Row 0.

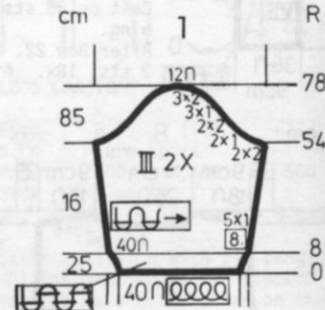

CENTER FRONT SECTION: XI REVERSE 1 leg section.

Cast on 18 (20) [22] sts. and work 16 rows K1, P1 Ribbing. Continue in Stockinette stitch. **ON INSIDE LEG EDGE**, increase 1 st. every 16th row 4x. After Row 100 (110) [116], **SHAPE CROTCH**: Bind off 2 sts. 2x, 1 st. 4x (5x) [5x]. After Row 110 (122) [128], remove the sts. onto a stitch holder as you did for the back. Work the 2nd section with reverse shaping, casting on from right to left. Cam Box will be on the **LEFT** SIDE AT ROW 0. After Row 110 (122) [128], hang the two sections together with the crotch sections in the center 28 sts. on the machine. Put counter at 110 (122) [128] and continue over all the sts. Knit to Row 192 (204) [216]. **SHAPE NECK**: Put half the sts. on the left into holding position and complete the right side first. ***ON NECK SIDE**, bind off 3 sts. 1x, 2 sts. 2x, 1 st. 4x. (3 sts. 1x, 2 sts. 2x, 1 st. 5x). [4 sts. 1x, 2 sts. 2x, 1 st. 5x]. After Row 210 (226) [238], bind off the remaining sts. Move the Cam Box to the left side, turn the Row Counter back to 192 (204) [216] and complete the left half. Follow the instructions from *.

FRONT NECKBAND:

Pick up 50 (54) sts. across the front neck. Knit 1 row stockinette st. then transfer every other stitch to the ribber and work K1, P1 Ribbing. After Row 6, **MAKE BUTTONHOLES ON EACH SIDE**, over needles 4 to 6 counting from each edge. After Row 12, bind off the crochet method for Ribbing.

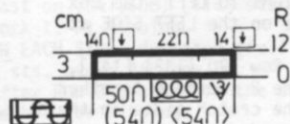

BACK NECKBAND:

Pick up 50 (54) sts. across the back neck. Knit 1 row stockinette stitch then transfer every other stitch to the ribber and work 12 rows K1, P1 Ribbing. Bind off the crochet method for Ribbing.

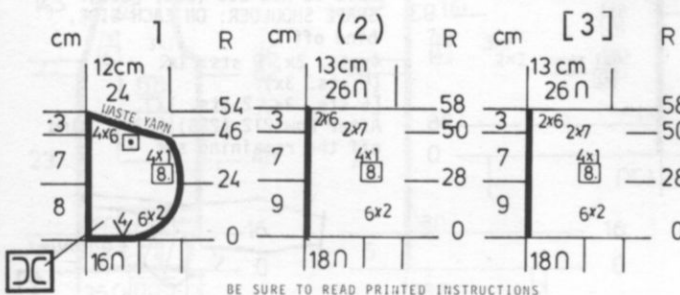

BE SURE TO READ PRINTED INSTRUCTIONS



HOOD: Make 1, reverse 1.

Cast on 16 (18) [18] sts. and work Stockinette stitch. **ON CAM BOX SIDE**, cast on 2 sts. every 2nd row 6x. After Row 24 (28) [28], decrease 1 st. every 8th row 4x. After Row 47 (51) [51], work **SHORT ROWS**: ON OPPOSITE SIDE OF CAM BOX, put into holding position, 6 sts. 4x (7 sts. 2x, 6 sts. 2x) [same as 2nd size]. After Row 54 (58) [58], remove the sts. onto waste yarn.

Work the 2nd section with reverse shaping, casting on from right to left. Cam Box will be on the **LEFT** side at Row 0.

Weave the open sts. of top of hood then remove waste yarn. Sew back seam. Hang neck edge back onto the machine, picking up 60 sts. Work 1 row stockinette stitch then transfer every other st. to the Ribber and work K1, P1 Ribbing. After Row 7, make eyelets. Hang every 8th st. onto the 7th st. Leave empty needles in work. After Row 14, bind off the crochet method for Ribbing. Make a cord 90 cm (35 1/2") and thread through eyelets on hood and tie. See picture.

SLEEVES: III

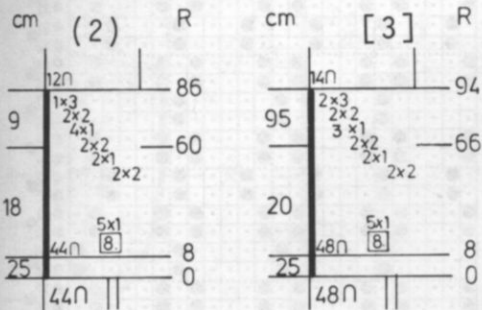

Cast on 40 (44) [48] sts. and work 8 rows K1, P1 Ribbing. Continue in Stockinette stitch. ON EACH SIDE, increase 1 st. every 8th row 5x (all sizes). After Row 54 (60) [66], SHAPE CAP: ON EACH SIDE, bind off 2 sts. 2x, 1 st. 2x, 2 sts. 2x, 1 st. 3x, 2 sts. 3x. (2 sts. 2x, 1 st. 2x, 2 sts. 2x, 1 st. 4x, 2 sts. 2x, 3 sts. 1x). [2 sts. 2x, 1 st. 2x, 2 sts. 2x, 1 st. 3x, 2 sts. 2x, 3 sts. 2x]. After Row 78 (86) [94], bind off the remaining sts.

YOKE/SLEEVE STRIP

Cast on 28 sts. with color 1 and work Stockinette stitch. Knit to Row 28, then work the REPEATED COLOR STRIPES as shown on the Chart. Divide in the center, put the needles on the left into holding position and complete the right side neck first. ON NECK SIDE, bind off 2 sts. 4x, then knit to Row 288 (292) and cast on 2 sts. 4x. After Row 296 (300, put these sts. into holding position. Turn the Row Counter back to 220 (224). Bring the needles on the left into working position. ON NECK SIDE, bind off 1 st. 6x. Knit to Row 258 (262) and mark the left edge with bit of contrast yarn (for center back neck). Knit to Row 288 (292) and cast on 1 st. 6x. After Row 295 (299) bring the needles on the right into working position and continue over all the needles in the color stripes to Row 488 (496) then continue with color 1 to row 516 (524). Bind off.

DK 546

WOMAN'S PULLOVER

SIZES: 8/10 (12/14)
 YARN: Binia
 GRAMS: color 1 400 450
 colors 2, 3, 4, 5, 6 - all sizes 50 grams each color.
 TENSION: 8 to 10
 GAUGE: 12 1/2 sts. 18 rows = 5 cm (2")

Stockinette stitch with color stripes as shown on the Chart and Instructions. Front pocket knitted in strips and sewn together. Collar is K1, P1 Ribbing.

FINISHING: Pin, then sew Yoke/Sleeve strip in place on front and back sections. Sew pocket strips together with the widest strip at top. Fold over 8 rows and hem for pocket facing. Weave pocket in place (see picture). Weave side seams and sew up sleeves. Fold under and hem lower edge and sleeves. Sew on collar, fold in half and turn to the right side.

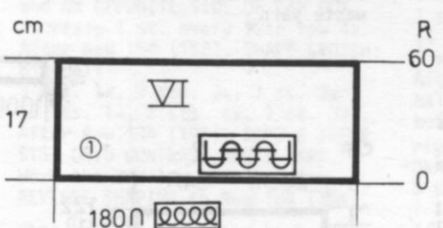
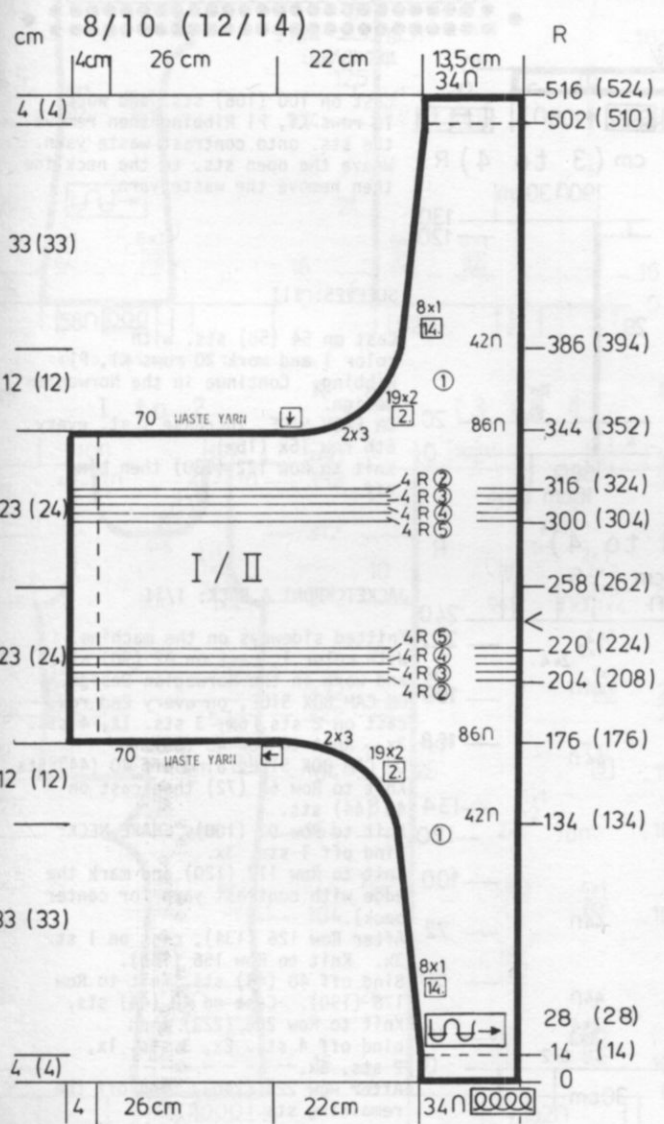

COLLAR: VI
 Cast on 180 sts. with color 1 and work 60 rows K1, P1 Ribbing then bind off the crochet method for Ribbing.

FRONT & BACK: I/II (2 sections the same).

To the extreme right of machine, cast on 34 sts. with color 1 and work Stockinette stitch. Knit to Row 28. ON INSIDE EDGE, increase 1 st. every 14th row 8x. After Row 135, cast on 2 sts. every 2nd row 19x, then on every 2nd row cast on 3 sts. 2x. After Row 176, with contrast waste yarn, cast on 70 sts. on the LEFT. Knit to Row 204 (208). Work the color stripes as shown on the Chart, then continue in Color 1. After Row 258 (262) mark the end stitch on the right with a bit of waste yarn (center neck). Knit to Row 300 (304). Work the color stripes as shown on the Chart. Knit to Row 344 (352). Remove 70 sts. on the left onto contrast waste yarn, then on the left, bind off 3 sts. 2x, 2 sts. 19x. After Row 386 (394) ON INSIDE EDGE, decrease 1 st. every 14th row 8x. After Row 516 (524), bind off the remaining 34 sts.

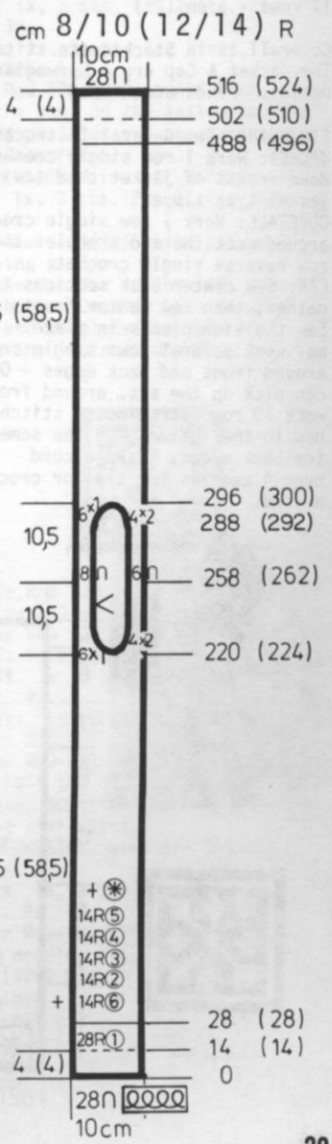

DK 546

POCKET STRIPS - Knit 4 with 14 sts. and 1 with 22 sts.

cm	R
14n WASTE YARN	80
5,5	②
5,5	⑤
5,5	④
5,5	③
5x 14n	①

BE SURE TO READ PRINTED INSTRUCTIONS

With contrast waste yarn, cast on 14 sts. Knit 8 to 10 rows then continue with garment yarn in color stripes as shown on the Chart. Work in Stockinette stitch.

After Row 80, remove the sts. onto contrast waste yarn.

Make 3 more strips in the same way but CHANGE THE COLOR SEQUENCE (see Picture).

Make 1 more strip using 22 sts. and change the color sequence.

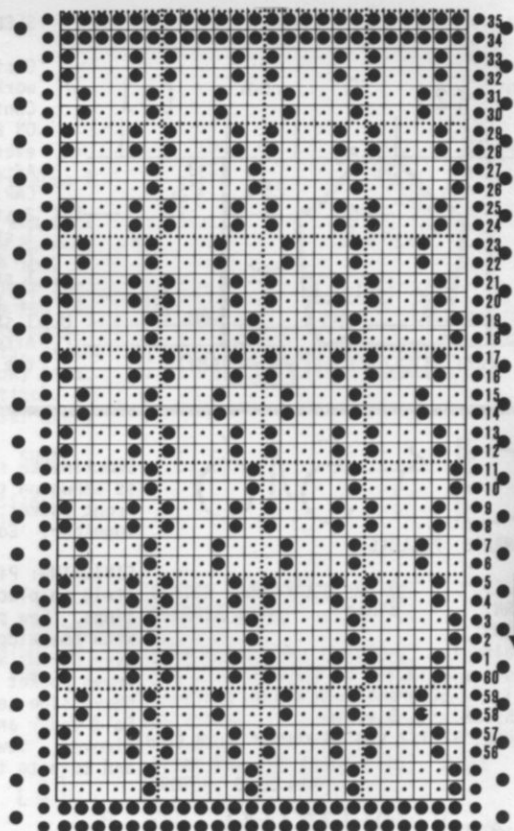

KK 547

CHILD'S COVERALL, JACKET & CAP

SIZES: 1 to 2 (3 to 4)
YARN: Fortissima

GRAMS: Coverall		
color 1	200	200
GRAMS: Jacket & Cap		
color 1	150	150
color 2	200	250

TENSION: Coverall - 6 to 8
Cap & Jacket - 7 to 9

GAUGE: Coverall 15 sts. 20 rows = 5 cm (2")

Jacket & Cap - 15 sts. 17 rows = 5 cm (2")

Coverall is in Stockinette stitch. The Jacket & Cap are a Norwegian Design. Bands are Ribbed.

FINISHING: See General Instructions.

JACKET: Work 1 row single crochet down fronts of jacket then sew in a jacket type zipper.

COVERALL: Work 1 row single crochet around neckline and armholes then 1 row reverse single crochet.

CAP: Sew center back sections together, then sew center fronts together. Sew the side pieces in place. You may work several rows single crochet around front and back edges - OR you can pick up the sts. around front and work 10 rows stockinette stitch and hem to the inside. Do the same to the back edges. Make a cord over 4 needles for ties or crochet a cord.

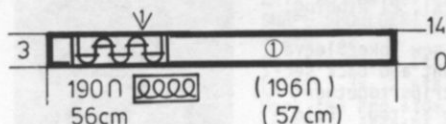

LOWER BAND:

Cast on 190 (196) sts. with color 1 and work 14 rows K1, P1 Ribbing. Remove onto contrast waste yarn. Weave the open sts. to the lower edge of jacket then remove the waste yarn.

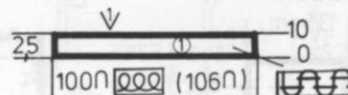

NECKBAND:

Cast on 100 (106) sts. and work 10 rows K1, P1 Ribbing then remove the sts. onto contrast waste yarn. Weave the open sts. to the neckline then remove the waste yarn.

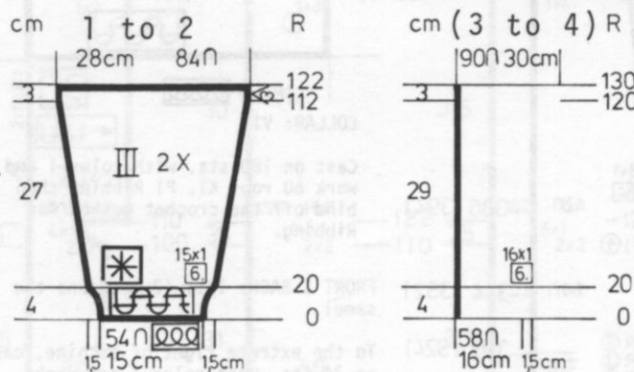

SLEEVES: IIII

Cast on 54 (58) sts. with color 1 and work 20 rows K1, P1 Ribbing. Continue in the Norwegian Design. ON EACH SIDE, increase 1 st. every 6th row 15x (16x). Knit to Row 122 (130) then bind off.

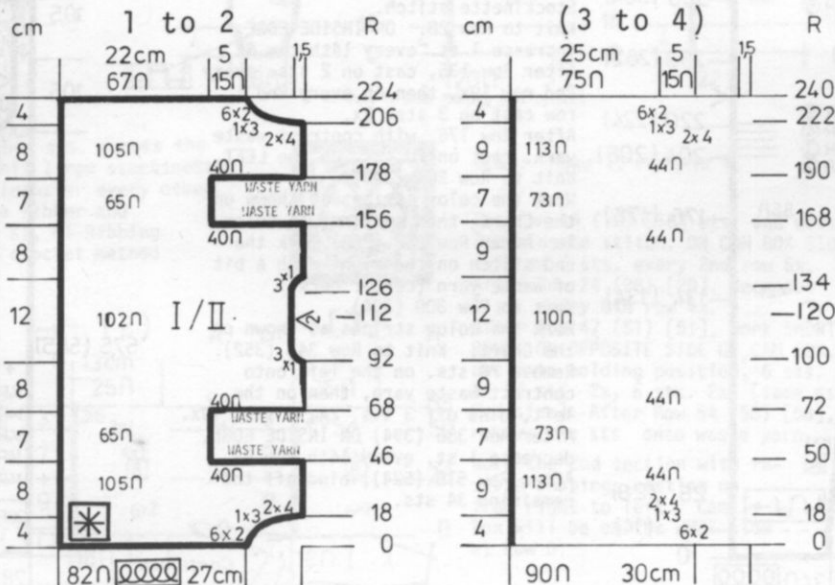

JACKET FRONT & BACK: I/II

Knitted sideways on the machine. With color 1, cast on 82 (90) sts. and work in the Norwegian Design. ON CAM BOX SIDE, on every 2nd row, cast on 2 sts. 6x, 3 sts. 1x, 4 sts. 2x. Knit to Row 46 (50). ON CAM BOX SIDE, bind off 40 (44) sts. Knit to Row 68 (72) then cast on 40 (44) sts. Knit to Row 92 (100). SHAPE NECK: Bind off 1 sts. 3x. Knit to Row 112 (120) and mark the edge with contrast yarn for center back). After Row 126 (134), cast on 1 st. 3x. Knit to Row 156 (168). Bind off 40 (44) sts. knit to Row 178 (190). Cast on 40 (44) sts. Knit to Row 206 (222) then bind off 4 sts. 2x, 3 sts. 1x, 2 sts. 6x. After Row 224 (240), bind off the remaining sts.

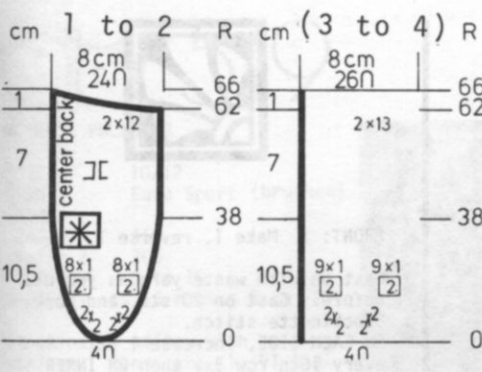

CAP BACK SECTIONS: Make 2.

Cast on 4 sts. and work the Norwegian Design. ON EACH SIDE, increase 2 sts. every 2nd row 2x, 1 st. 8x (9x). Knit to Row 63 then work **SHORT ROWS: ON OPPOSITE SIDE OF CAM BOX, put into holding position 12 (13) sts. 2x.** Bring all the needles back into working position, knit 1 row then bind off. Make the 2nd section with **REVERSE SHAPING** for the Short Rows.

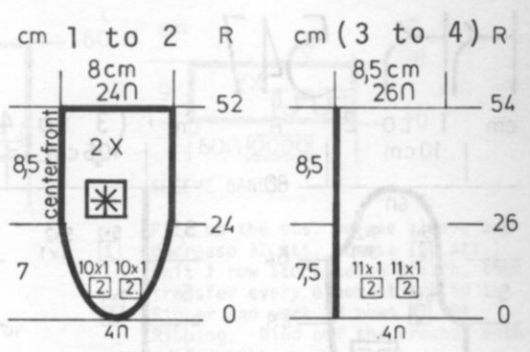

CAP FRONT SECTIONS: Make 2.

Cast on 4 sts. and work the Norwegian design. ON EACH SIDE, increase 1 st. every 2nd row 10x (11x). Knit to Row 52 (54) then bind off.

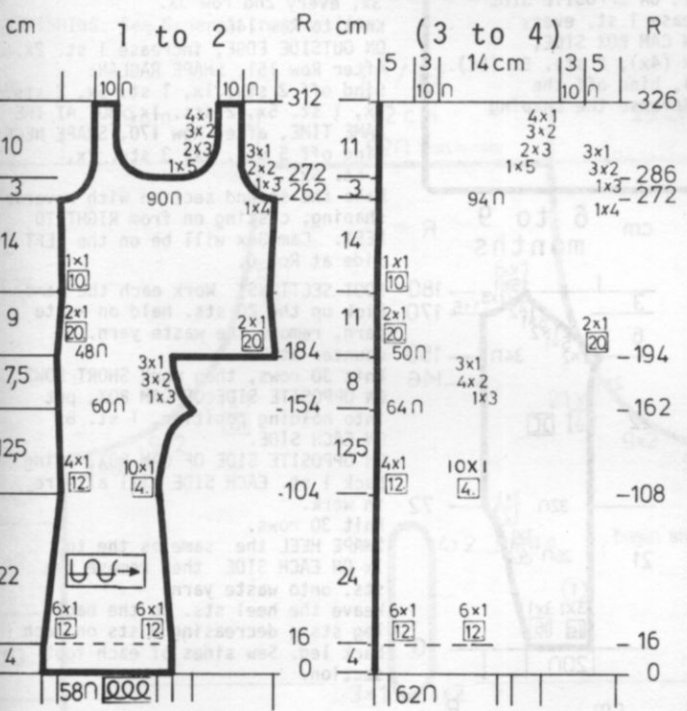

COVERALL FRONT:

Cast on 58 (62) sts. and work Stockinette stitch. Knit to Row 16. ON EACH SIDE, decrease 1 st. every 12th row 6x. After Row 104 (108) ON CAM BOX SIDE, increase 1 st. every 4th row 10x and ON OPPOSITE SIDE OF CAM BOX, increase 1 st. every 12th row 4x. After Row 154 (162), **SHAPE CROTCH: Bind off** 3 sts. 1x, 2 sts. 3x, 1 st. 3x. (3 sts. 1x, 2 sts. 4x, 1 st. 3x). After Row 184 (194), REMOVE THESE STS. ONTO CONTRAST WASTE YARN. Work the 2nd leg section with **REVERSE SHAPING** to Row 184 (194). Hang both leg sections back onto the machine, being sure the crotch sections are in the center, and decreasing 1 st. on each side of the center crotch (for seam). Put ROW COUNTER at 184 (194).

ON EACH SIDE, decrease 1 st. every 20th row 2x. Knit to Row 262 (272). **SHAPE ARMHOLES: ON EACH SIDE, bind off** 4 sts. 1x, 3 sts. 1x, 2 sts. 2x, 1 st. 3x. (4 sts. 1x, 3 sts. 1x, 2 sts. 3x, 1 st. 3x). After Row 272 (286) **SHAPE NECK: Put half the sts. on the left side into holding position and complete the right side first.** *ON NECK SIDE, bind off for both sizes, 5 sts. 1x, 3 sts. 2x, 2 sts. 3x, 1 st. 4x. After Row 312 (326) bind off the remaining sts. Move the Cam Box to the left side, turn the Row Counter back to 272 (286) and complete the left half. Follow the instructions from *.

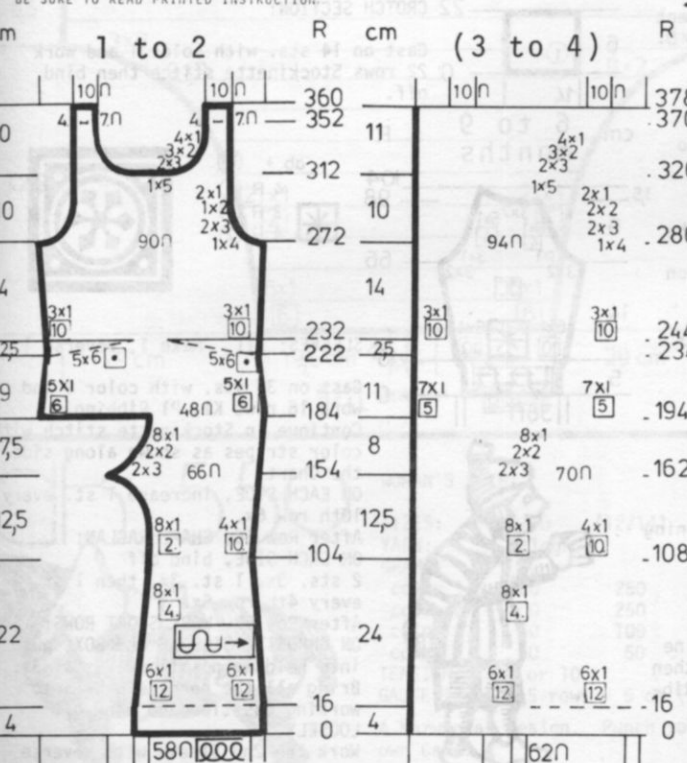

COVERALL BACK:

Cast on 58 (62) sts. and work Stockinette stitch. Knit to Row 16. ON EACH SIDE, decrease 1 st. every 12th row 6x. After Row 104 (108) ON INSIDE EDGE, increase 1 st. every 4th row 8x, every 2nd row 8x and ON CAM BOX SIDE, increase 1 st. every 10th row 4x. After Row 155 (163) **SHAPE CROTCH: Bind off** 3 sts. 2x, 2 sts. 2x, 1 st. 8x. After Row 184 (194), remove THESE STS. ONTO WASTE YARN or a STITCH HOLDER. Work the 2nd leg section with **REVERSE SHAPING** to Row 184 (194). Hang both leg sections back onto the machine with crotch in center and decrease 1 st. on each side of center crotch (for seam). Put Row counter at 184 (194). ON EACH SIDE, decrease 1 st. every 6th row 5x. (every 5th row 7x). After Row 222 (234) **WORK SHORT ROWS: ON OPPOSITE SIDE OF CAM BOX, put into holding position 6 sts. 5x ON EACH SIDE.** Bring all the needles back into working position before knitting the next 2 rows.



After Row 232 (244) ON EACH SIDE, increase 1 st. every 10th row 3x. After Row 272 (286), **SHAPE ARM-HOLE: ON EACH SIDE, bind off** 4 sts. 1x, 3 sts. 2x, 2 sts. 1x, 1 st. 2x. (4 sts. 1x, 3 sts. 2x, 2 sts. 2x, 1 st. 2x). After Row 312 (326) **SHAPE NECK: Put half the sts. on the left into holding position and complete the right side first.** *ON NECK SIDE, bind off for both sizes, 5 sts. 1x, 3 sts. 2x, 2 sts. 3x, 1 st. 4x. After Row 352 (370) **MAKE BUTTONHOLE** over needles 4 to 7. After Row 360 (378) bind off the remaining stitches. Move the Cam Box to the left side, turn the Row Counter back to 312 (326) and complete the left half. Follow the instructions from *.

BE SURE TO READ PRINTED INSTRUCTIONS

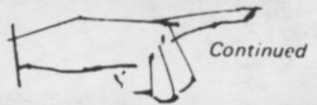

KK 547

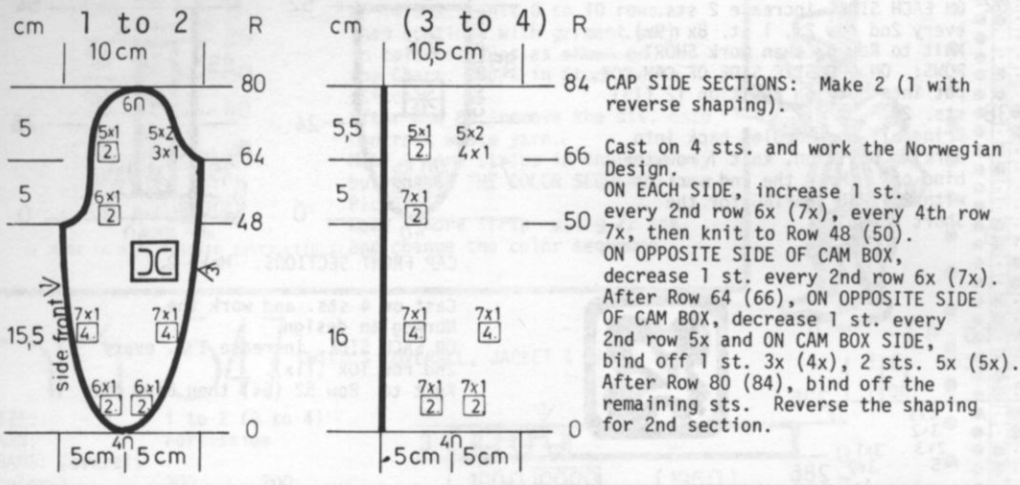

FRONT: I Make 1, reverse 1.

Cast on with waste yarn as you did before. Cast on 20 sts. and work Stockinette stitch.
ON EACH SIDE, increase 1 st. every 16th row 3x. then ON INNER EDGE, increase 1 st. every 4th row 3x, every 2nd row 3x.
Knit to Row 146.
ON OUTSIDE EDGE, increase 1 st. 2x. After Row 151, SHAPE RAGLAN: Bind off 2 sts. 1x, 1 st. 5x, 2 sts. 1x, 1 st. 5x, 2 sts. 1x, BUT AT THE SAME TIME, after Row 170, SHAPE NECK: Bind off 5 sts. 1x, 3 sts. 2x, 1 st. 5x.

Make the second section with reverse shaping, casting on from RIGHT TO LEFT. Cam Box will be on the LEFT side at Row 0.

FOOT SECTIONS: Work each the same. Pick up the 20 sts. held on waste yarn, remove the waste yarn. Counter at 0.
Knit 30 rows, then work SHORT ROWS: ON OPPOSITE SIDE OF CAM BOX, put into holding position, 1 st. 8x ON EACH SIDE.
ON OPPOSITE SIDE OF CAM BOX, bring back 1 st. EACH SIDE till all are in work.
Knit 30 rows.
SHAPE HEEL the same as the toe 7x ON EACH SIDE then remove the sts. onto waste yarn.
Weave the heel sts. to the back leg sts., decreasing 2 sts on each back leg. Sew sides of each foot section.

KK 548

BABY'S SUIT

SIZE: 6 to 9 months
YARN: Allegro
GRAMS:
color 1 150
color 2 50
color 3 50
TENSION: 6 to 8
GAUGE: 12 sts. 18 rows = 5 cm (2")



Stockinette stitch with color stripes on the sleeves. The bands are Ribbed.

FINISHING: Sew in crotch section. Weave inner leg and foot seams. Sew in sleeves then sew side and sleeve seams. Work 1 row single crochet down front edges then sew in zipper.

BACK: II

With contrast waste yarn, cast on 22 sts. and work Stockinette st. Knit 8 to 10 rows, change to garment yarn (color 1) and put counter at 0. ON EACH SIDE, increase 1 st. every 16th row 3x, then on inside edge, increase 1 st. every 4th row 5x.
After Row 72, remove the sts. onto a stitch holder.
Make another section with reverse shaping.
Hang the 2 sections together on the machine, with the crotch shaping in the center and decrease 1 st. on each center crotch (for seam). Counter at 72.
ON EACH SIDE, decrease 1 st. every 16th row 3x.
After Row 146, ON EACH SIDE, increase 1 st. 2x.
After Row 150, SHAPE RAGLAN: ON EACH SIDE, bind off 2 sts. 1x, 1 st. 5x, 2 sts. 1x, 1 st. 5x, 2 sts. 1x, 1 st. 6x, 2 sts. 1x.
After Row 190, bind off the remaining 20 sts.

NECKBAND: VIII

Pick up 90 sts. around the neckline and work 10 rows K1, P1 Ribbing then bind off the crochet method for Ribbing.

cm 6 to 9 months R

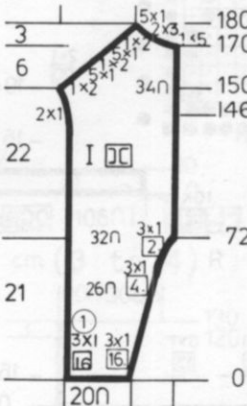



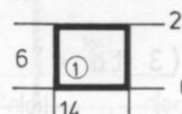

cm R

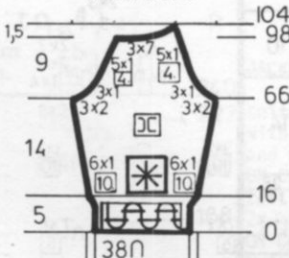

22 CROTCH SECTION:
Cast on 14 sts. with color 1 and work 22 rows Stockinette stitch then bind off.

cm 6 to 9 months R



ab + 
4 R 
2 R 
4 R 



SLEEVES: III Make 1, reverse 1.

Cast on 38 sts. with color 1 and work 16 rows K1, P1 Ribbing. Continue in Stockinette stitch with color stripes as shown along side the Chart.
ON EACH SIDE, increase 1 st. every 10th row 6x.
After Row 66, SHAPE RAGLAN: ON EACH SIDE, bind off 2 sts. 3x, 1 st. 3x, then 1 st. every 4th row 5x.
After Row 98, WORK SHORT ROWS: ON OPPOSITE SIDE OF CAM BOX, put into holding position, 7 sts. 3x. Bring all the needles back into working position and bind off LOOSELY.
Work the 2nd Sleeve with reverse shaping on the SHORT ROWS.



cm R

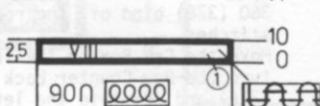

dk 549

WOMAN'S PULLOVER

SIZE: 10/12
 YARN: Euro Sport (brushed)
 GRAMS: color 1 450
 color 2 200
 TENSION: 8 to 10
 GAUGE: 11 sts. 16 rows = 5 cm (2")



Stockinette stitch with color stripes. Bands are K1, P1 Ribbing.

FINISHING: See General Instructions.

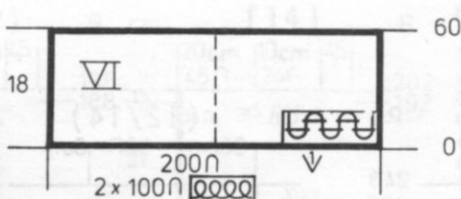

COLLAR: MAKE 2

Cast on 100 sts. and work 60 rows K1, P1 Ribbing then bind off the crochet method for Ribbing.

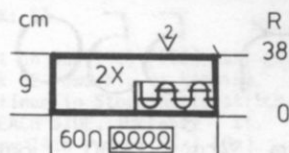

SLEEVE BANDS:

Pick up the sts. on one sleeve and decrease 32 sts. across (60 sts.) Knit 1 row Stockinette stitch, then transfer every other stitch to the Ribber and work 38 rows K1, P1 Ribbing. Bind off the crochet method for ribbing.

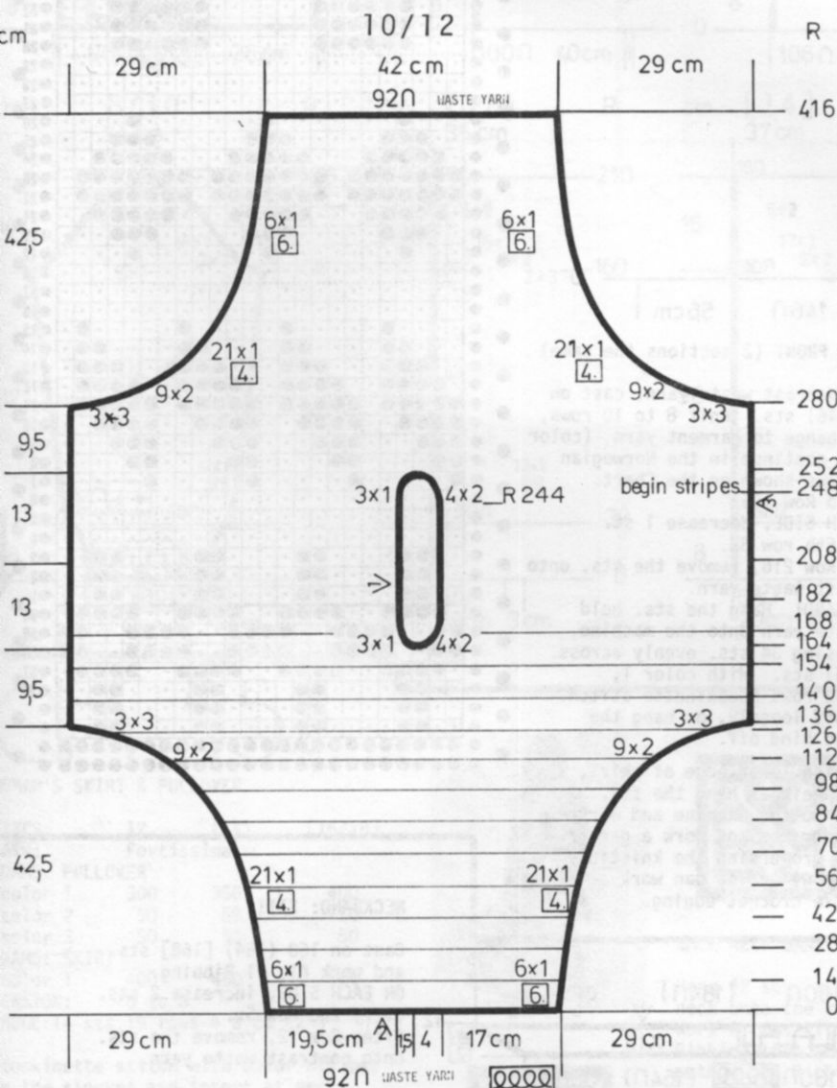

FRONT, BACK & SLEEVES MADE IN ONE SECTION.

With contrast waste yarn, cast on 92 sts. Knit 8 to 10 rows then change to color 1 and work Stockinette stitch with REPEATED STRIPES of 14 rows color 1, 14 rows color 2. Counter at 0. ON EACH SIDE, increase 1 st. every 6th row 6x, every 4th row 21x, then ON EACH SIDE, on every 2nd row, cast on 2 sts. 9x, 3 sts. 3x. After Row 164, put half the sts. on the left into holding position and complete the right side first. *ON NECK SIDE, on every 2nd row, bind off 2 sts. 4x, AND AT THE SAME TIME, after Row 168, continue with color 1. Mark each side after Row 208 (center front and back). Knit to Row 244. ON NECK SIDE, cast on 2 sts. 4x, BUT AT THE SAME TIME, after Row 248, BEGIN THE PATTERN STRIPES. After Row 252, put these sts. into holding position, bring the needles on the left into working position. Attach yarn at neck edge, knit 1 row to the left side, turn the Row Counter back to 164 and complete the left side to Row 252. Follow the instructions from *. Bring all the needles into working position and continue with the color stripes. Knit to Row 280. ON EACH SIDE, bind off 3 sts. 3x, 2 sts. 9x, then every 4th row 1 st. 21x, every 6th row 1 st. 6x. After Row 416, remove the sts. onto contrast waste yarn.

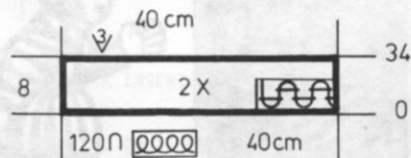

WAIST BANDS: Make 2.

Cast on 120 sts. and work 34 rows K1, P1 Ribbing then bind off the crochet method for Ribbing.

dk 550

WOMAN'S SKIRT

SIZES: 8/10 (12/14)
 YARN: Allegro
 GRAMS: color 1 200 250
 color 2 200 250
 color 3 50 100
 color 4 50 50
 TENSION: 9 or 10
 GAUGE: 13 sts. 15 rows = 5 cm (2")

A Norwegian Design. Punch your own Card.

FINISHING: See General Instructions.



Continued

dk 550

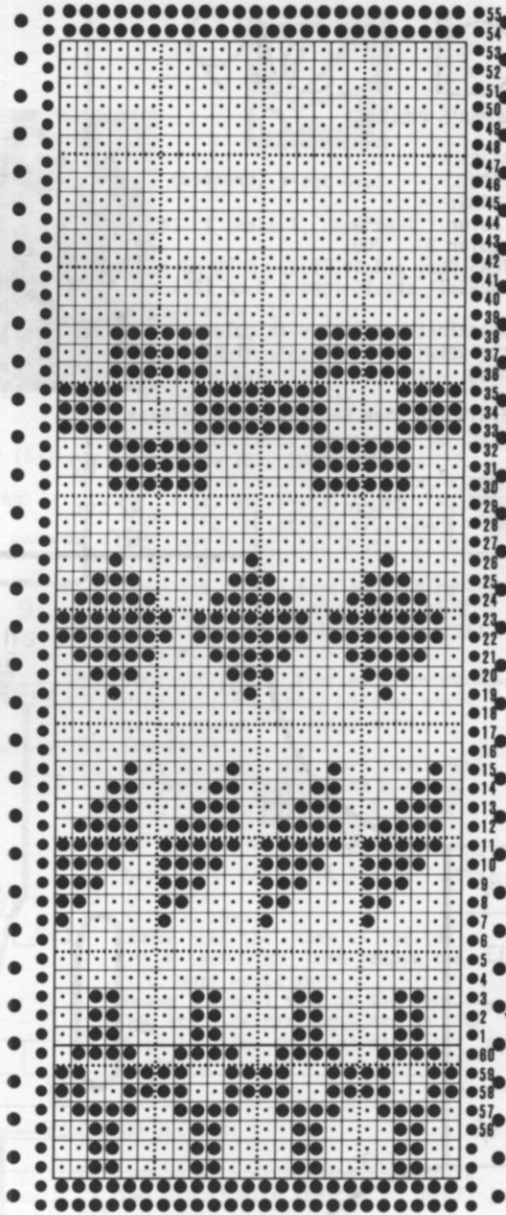
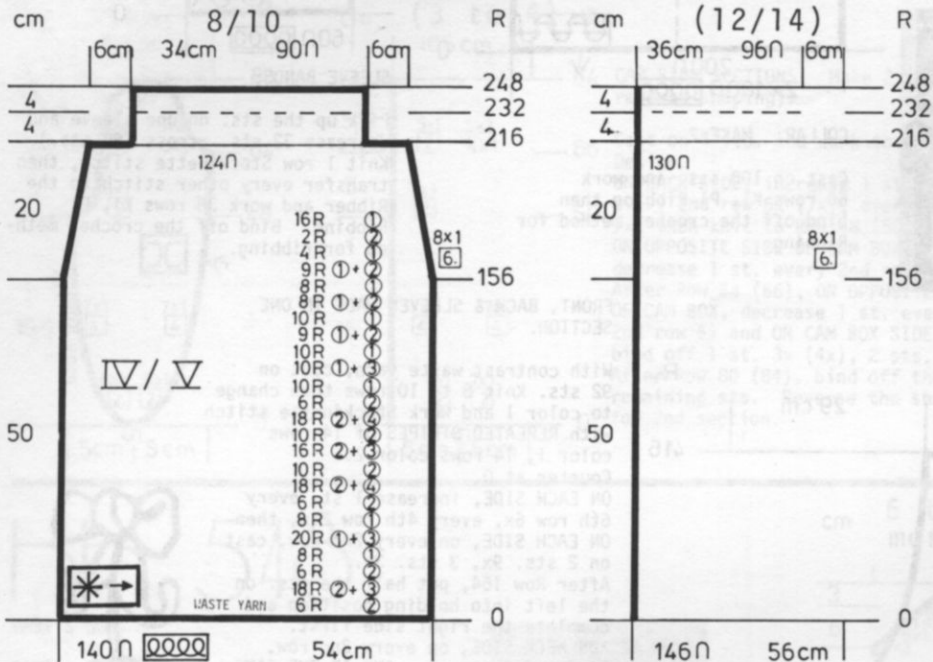

dk 551

WOMAN'S PULLOVER

SIZES: 8/10 (12) [14]
 YARN: Allegro
 GRAMS: 300 300 350
 TENSION: 8 to 10
 GAUGE: 12 sts. 17 rows = 5 cm (2")

Stockinette stitch with K1, P1
 Ribbing for the bands.

FINISHING: See General Instructions.



BACK & FRONT (2 sections the same)

With contrast waste yarn, cast on 140 (146) sts. Knit 8 to 10 rows, then change to garment yarn (color 2) and continue in the Norwegian Design as shown on the Chart. Knit to Row 156. ON EACH SIDE, decrease 1 st. every 6th row 8x. After Row 216, remove the sts. onto contrast waste yarn. WAISTBAND: Hang the sts. held on waste yarn onto the machine, decreasing 34 sts. evenly across. 90 (96) sts. With color 1, work 32 rows Stockinette stitch. Bind off loosely, or hang the hem and bind off.

To finish lower edge of skirt, you can either hang the sts. back onto the machine and work the under hem, or work a garter stitch (reversing the knitting every row) or you can work a single crochet edging.

NECKBAND: XIII

Cast on 160 (164) [168] sts. and work K1, P1 Ribbing. ON EACH SIDE, increase 2 sts. every 2nd row 5x. After Row 12, remove the sts. onto contrast waste yarn.

FRONT: I

Work the front the same as the back to Row 104 (108) [112]. Put half the sts. on the left into holding position and complete the right side first. *ON NECK SIDE, decrease 1 st. every 4th row 22x (22x) [24x] AND AT THE SAME TIME, after Row 122 (130) [134], SHAPE ARMHOLE same as the back and after Row 182 (188) [196], SHAPE SHOULDER same as the back. Move the Cam Box to the left side, turn the Row Counter back to 104 (108) [112] and complete the left half. Follow the instructions from *.

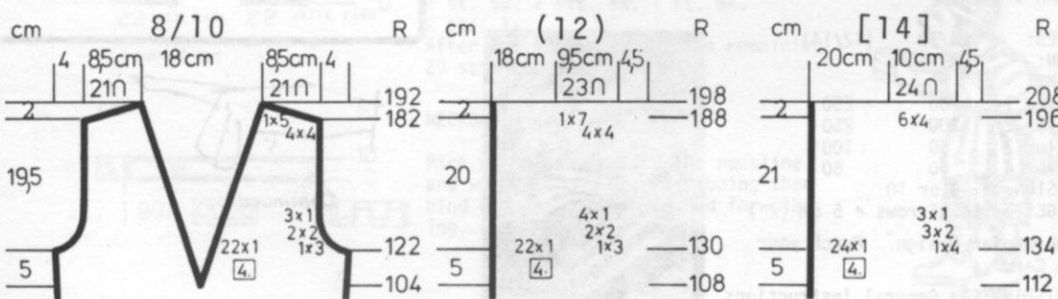
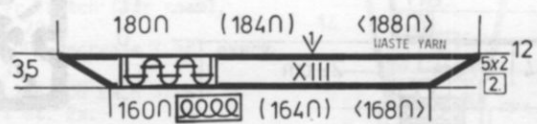

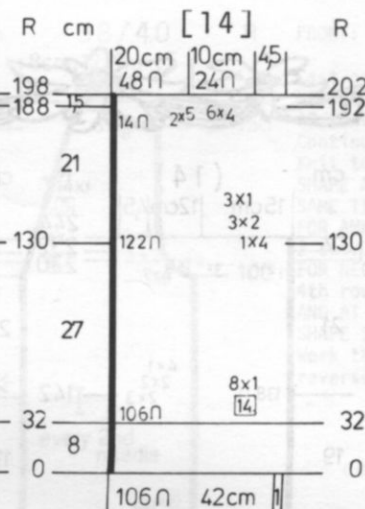
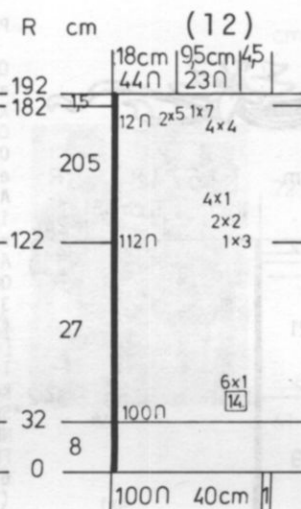
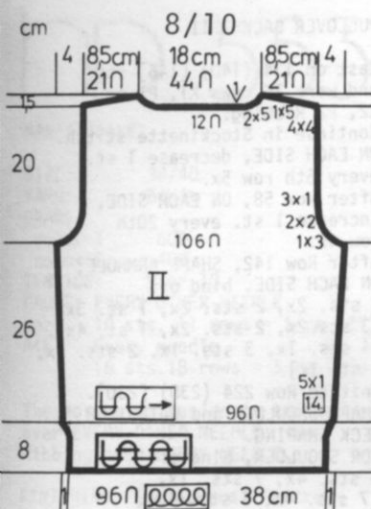

BACK: II
 Cast on 96 (100) [106] sts. and work 32 rows K1, P1 Ribbing. Continue in Stockinette stitch. ON EACH SIDE, increase 1 st. every 14th row 5x (6x) [8x]. Knit to Row 122 (130) [130]. SHAPE ARMHOLE: ON EACH SIDE, bind off 3 sts. 1x, 2 sts. 2x, 1 st. 3x. (3 sts. 1x, 2 sts. 2x, 1 st. 4x). [4 sts. 1x, 2 sts. 3x, 1 st. 3x]. Knit to Row 182 (188) [192]. SHAPE NECK AND SHOULDER AT THE SAME TIME. Put half the sts. on the left into holding position and complete the right side first. *FOR SHOULDER, bind off 4 sts. 4x, 5 sts. 1x. (4 sts. 4x, 7 sts. 1x). [4 sts. 6x]. FOR NECK: Bind off 12 (12) [14] sts. 1x, 5 sts. 2x. Move the Cam Box to the left side, turn the Row Counter back to 182 (188) [192] and complete the left half. Follow the instructions from *.

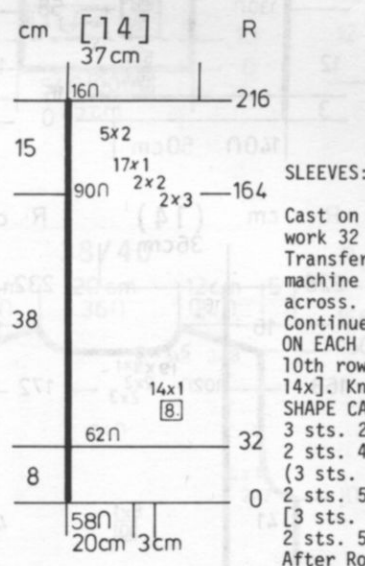
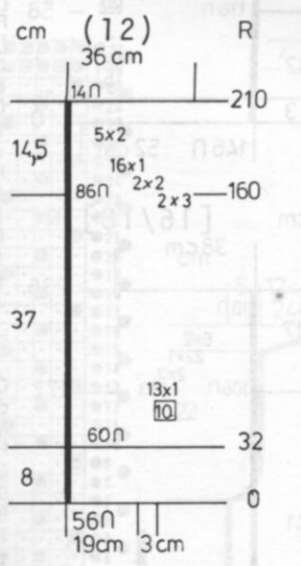
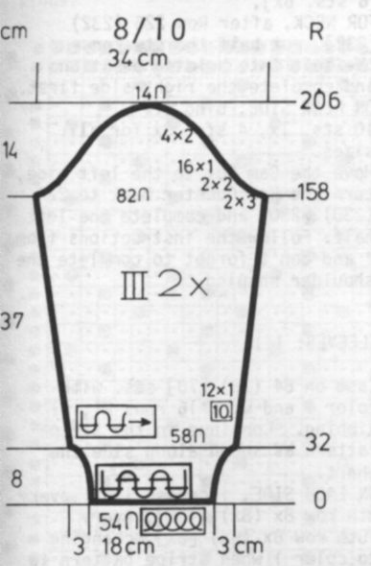

SLEEVES: III
 Cast on 54 (56) [58] sts. and work 32 rows K1, P1 Ribbing. Transfer the Ribber sts. to main machine and increase 4 sts. evenly across. Continue in Stockinette stitch. ON EACH SIDE, increase 1 st. every 10th row 12x (13x) [every 8th row 14x]. Knit to Row 158 (160) [164]. SHAPE CAP: ON EACH SIDE, bind off 3 sts. 2x, 2 sts. 2x, 1 st. 16x, 2 sts. 4x. (3 sts. 2x, 2 sts. 2x, 1 st. 16x, 2 sts. 5x). [3 sts. 2x, 2 sts. 2x, 1 st. 17x, 2 sts. 5x]. After Row 206 (210) [216], bind off the remaining sts.



AK 552

WOMAN'S SKIRT & PULLOVER

SIZES: 12 (14) [16/18]
 YARN: Fortissima
 GRAMS: PULLOVER
 color 1 300 350 400
 color 2 50 50 50
 color 3 50 50 50
 GRAMS: SKIRT
 color 1 400 450 500
 TENSION: 6 to 8
 GAUGE: 14 sts. 19 rows = 5 cm (2")

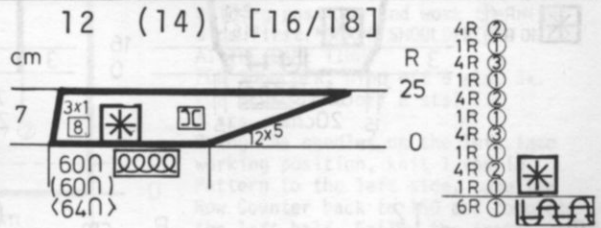

BACK NECK BAND:
 Hang 42 sts. across the back neck onto the machine and work 6 rows K1, P1 or K2, P2 Ribbing then bind off the crochet method for Ribbing.

FRONT NECK INSERT: Make 1, reverse 1.

SKIRT:
 With contrast waste yarn, cast on 196 sts. Knit 8 to 10 rows, turn Row Counter to 0 and continue with garment yarn. *Knit to Row 14 (16) [18]. Work SHORT ROWS: ON OPPOSITE SIDE OF CAM BOX, put into holding position 15 sts. 11x. ON OPPOSITE SIDE OF CAM BOX, bring back into working position, 15 sts. 11x. Knit to Row 68 (72) [76]. REPEAT FROM * 9x MORE. Remove the sts. onto contrast waste yarn.

Cast on 60 (60) [64] sts. with color 1 and work 6 rows K1, P1 Ribbing. Continue in Stockinette stitch with color stripes as shown along side the Chart and AT THE SAME TIME, ON CAM BOX SIDE, cast on 5 sts. every 2nd row 12x and on OPPOSITE SIDE OF CAM BOX, decrease 1 st. every 8th row 3x. After Row 25, bind off. Work the 2nd section with reverse shaping, casting on from Right to left. Cam Box will be on the LEFT side at Row 0.



Stockinette stitch with color stripes on the sleeves and insert at neck. Skirt is knitted sideways on the machine using short rows. Worn on purl side. FINISHING: SKIRT: Block then weave the open sts. together. Make hem at lower edge. Turn under at waist and hem then insert elastic.

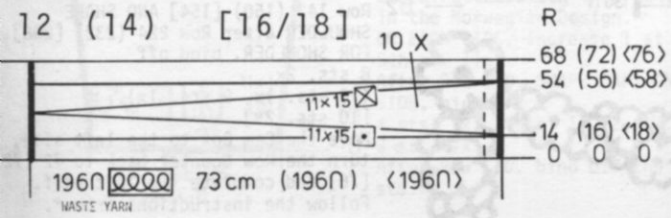

Continued

dk 552



PULLOVER BACK: II

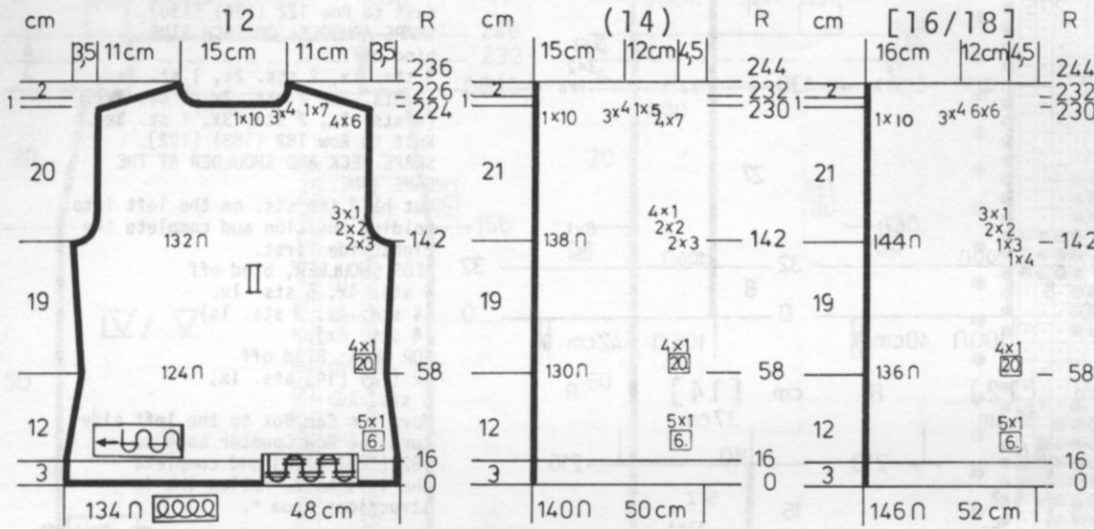

Cast on 134 (140) [146] sts. and work 16 rows K1, P1 or K2, P2 Ribbing. Continue in Stockinette stitch. ON EACH SIDE, decrease 1 st. every 6th row 5x. After Row 58, ON EACH SIDE, increase 1 st. every 20th row 4x. After Row 142, SHAPE ARMHOLE: ON EACH SIDE, bind off 3 sts. 2x, 2 sts. 2x, 1 st. 3x. (3 sts. 2x, 2 sts. 2x, 1 st. 4x). [4 sts. 1x, 3 sts. 1x, 2 sts. 2x, 1 st. 3x]. Knit to Row 224 (230) [230]. *SHAPE SHOULDER and WATCH FOR NECK SHAPING. FOR SHOULDER, bind off 6 sts. 4x, 7 sts. 1x, (7 sts. 4x, 5 sts. 1x), [6 sts. 6x], FOR NECK, after Row 226 (232) [232], put half the sts. on the left into holding position and complete the right side first. ON NECK SIDE, bind off 10 sts. 1x, 4 sts. 3x for all sizes. Move the Cam Box to the left side, turn the Row Counter back to 224 (230) [230] and complete the left half. Follow the instructions from * and don't forget to complete the shoulder shaping.

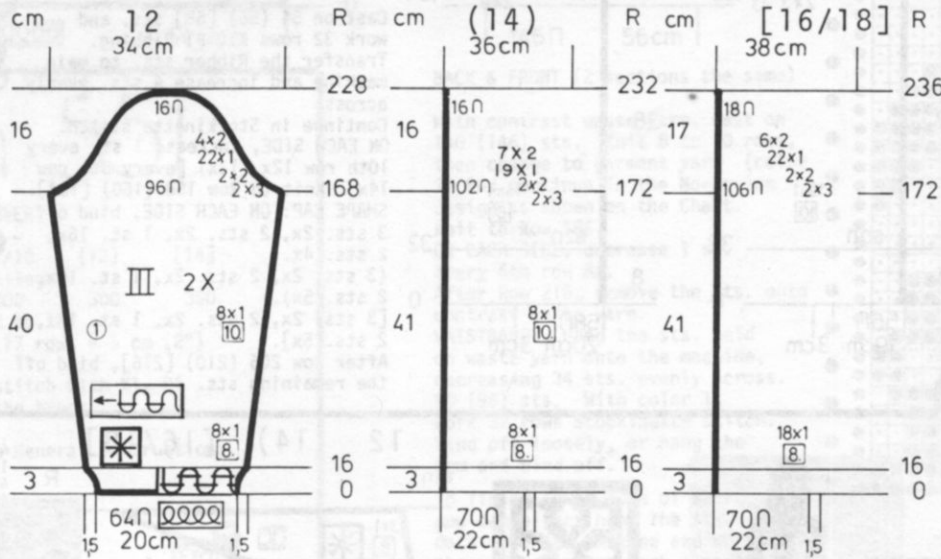

SLEEVES: III

Cast on 64 (70) [70] sts. with color 1 and work 16 rows K1, P1 Ribbing. Continue in the Stripe Pattern as shown along side the Chart. ON EACH SIDE, increase 1 st. every 8th row 8x (8x) [18x], every 10th row 8x (8x) [0x], changing to color 1 when stripe pattern is completed. After Row 168 (172) [172], SHAPE CAP: Bind off 3 sts. 2x, 2 sts. 2x, 1 st. 22x, 2 sts. 4x. (3 sts. 2x, 2 sts. 2x, 1 st. 19x, 2 sts. 7x). [3 sts. 2x, 2 sts. 2x, 1 st. 22x, 2 sts. 6x]. After Row 228 (232) [236], bind off the remaining sts.

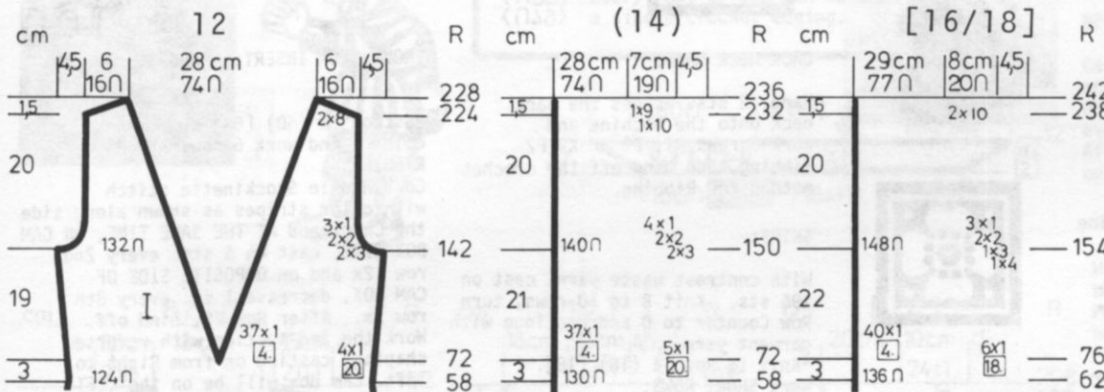

PULLOVER FRONT: I

Work the front the same as the back to Row 58 (58) [62]. ON EACH SIDE, increase 1 st. every 20th row 4x; (every 20th row 5x); [every 18th row 6x]; BUT AT THE SAME TIME, after Row 72 (72) [76], put half the sts. on the left into holding position and complete the right side first. *Continue the side increases and ON NECK SIDE, decrease 1 st. every 4th row 37x (37x) [40x], AND SHAPE ARMHOLE same as the back after Row 142 (150) [154] AND SHAPE SHOULDER after Row 224 (232) [238]. FOR SHOULDER, bind off 8 sts. 2x. (10 sts. 1x, 9 sts. 1x). [10 sts. 2x]. Move the Cam Box to the left side, turn the Row Counter back to 72 (72) [76] and complete the left half. Follow the instructions from *.

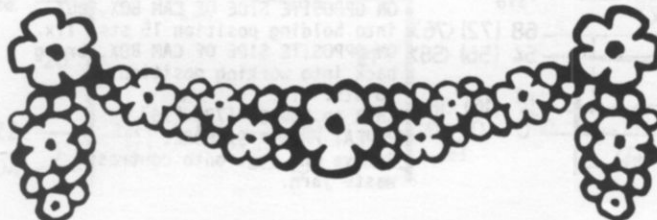

hp 553

MAN'S JACKET

SIZE: 38/40
 YARN: Binia
 GRAMS: color 1 600, color 2 400
 TENSION: 9 or 10
 GAUGE: EVERY OTHER NEEDLE
 Nor. 10 sts. 11 rows = 5 cm (2")
 Rib. Every needle
 16 sts. 18 rows = 5 cm (2")



The Norwegian Design is knitted over EVERY OTHER NEEDLE, the Ribbing over EVERY NEEDLE.

FINISHING: See General Instructions.

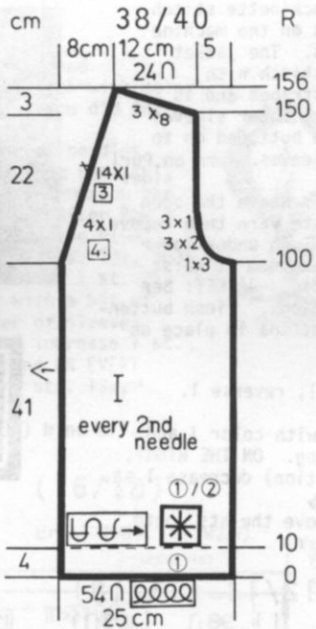
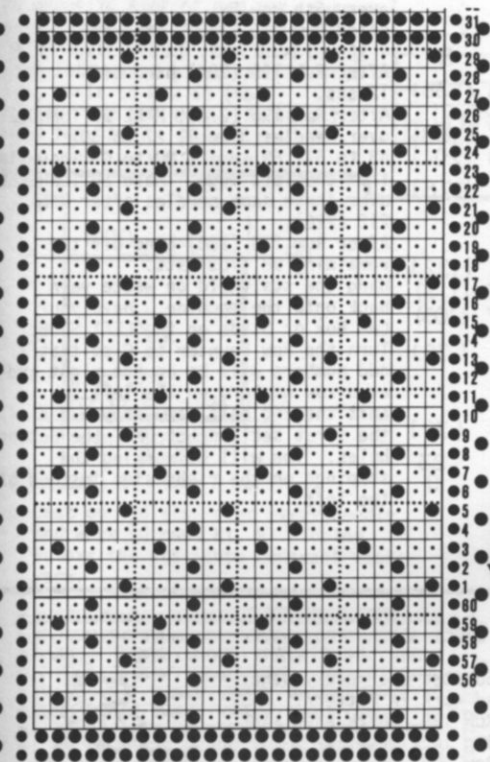

R FRONT: I Make 1, reverse 1.

Cast on 54 sts. OVER EVERY OTHER NEEDLE with color 1 and work 10 rows Stockinette stitch. Continue in the Norwegian Design. Knit to Row 100. SHAPE ARMHOLE AND NECK AT THE SAME TIME. FOR AMHOLE, bind off 3 sts. 1x, 2 sts. 3x, 1 st. 3x. FOR NECK, decrease 1 st. every 4th row 4x, every 3rd row 14x, AND AT THE SAME TIME, after Row 150, SHAPE SHOULDER same as the back. Work the 2nd front section with reverse shaping..

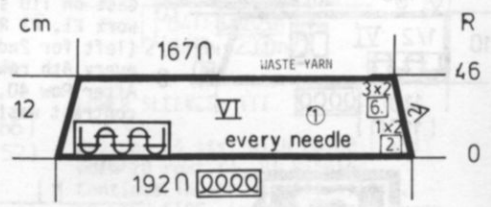

COLLAR: VI

Cast on 192 sts. OVER EVERY NEEDLE with color 1 and work K1, P1 Ribbing. ON EACH SIDE, decrease 2 sts. every 2nd row 1x, every 6th row 3x. After Row 46, remove the sts. onto contrast waste yarn.

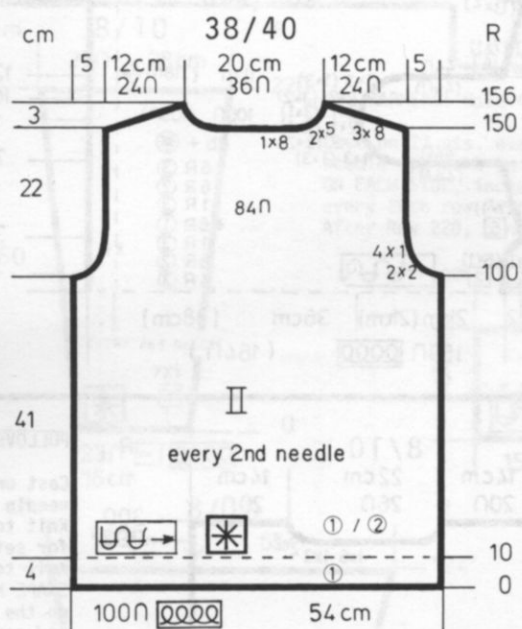

R

BACK: II

Cast on 100 sts. OVER EVERY OTHER NEEDLE and work 10 sts. Stockinette stitch with COLOR 1. Continue in the Norwegian Design. Knit to Row 100. SHAPE ARMHOLE: ON EACH SIDE, bind off 2 sts. 2x, 1 st. 4x. Knit to Row 150. Put half the Sts. on the left into holding position and work the right side first. *SHAPE SHOULDER AND NECK AT THE SAME TIME. FOR SHOULDER, bind off 8 sts. 3x. FOR NECK, bind off 8 sts. 1x, 5 sts. 2x. Bring the needles on the left into working position, knit 1 row in Pattern to the left side, turn the Row Counter back to 150 and complete the left half. Follow the instructions from *.

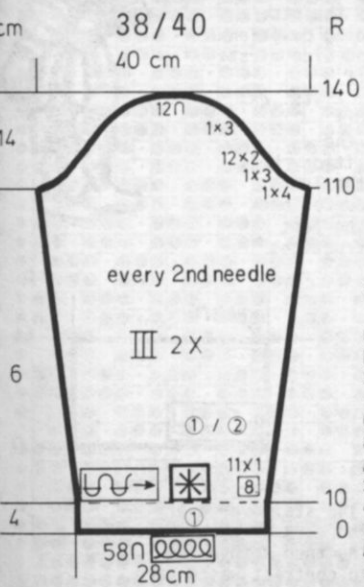

SLEEVES: III

Cast on 58 sts. OVER EVERY OTHER NEEDLE with color 1 and work 10 rows Stockinette stitch then continue in the Norwegian Design. ON EACH SIDE, increase 1 st. every 8th row 11x. After Row 110, SHAPE CAP: ON EACH SIDE, bind off 4 sts. 1x, 3 sts. 1x, 2 sts. 12x, 3 sts. 1x. After Row 140, bind off the remaining sts.

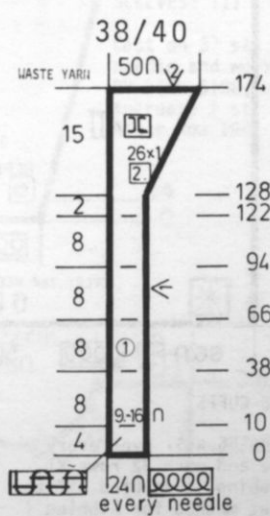

FRONT BAND: Make 1, reverse 1 and omit the buttonholes in 2nd section.

Cast on 24 sts. OVER EVERY NEEDLE with color 1 and work K1, P1 Ribbing. Make BUTTONHOLES over needles 9 to 16 counting from the left edge. Make the following BUTTONHOLES over the same needles after the rows shown on the Chart. After Row 128, ON CAM BOX SIDE, increase 1 st. every 2nd row 26x. After Row 174, remove the sts. onto contrast waste yarn.



DK 554

WOMAN'S SKIRT & JACKET

SIZES: 12/14 (16/18)
 YARN: Crocus
 GRAMS: JACKET
 color 1 200 250
 color 2 150 150
 color 3 150 150
 GRAMS: SKIRT
 color 1 450 500
 TENSION: 7 to 9
 GAUGE: 13 sts. 19 rows = 5 cm (2")

The skirt is Stockinette stitch knitted sideways on the machine using short rows. The jacket is stockinette stitch with REPEATED color stripes and is knitted sideways. Lower sleeves of jacket can be buttoned on to striped short sleeves. Worn on Purl Side.

FINISHING: SKIRT: Weave the open sts. held on waste yarn then remove the waste yarn. Turn under lower edge and hem. Make hem at waist and insert elastic. JACKET: See General Instructions. Finish buttonholes and sew buttons in place on lower sleeves.



JACKET FRONT AND BACK:

Begin at CENTER BACK. With contrast waste yarn, cast on 159 (164) sts. Knit 8 to 10 rows, change to garment yarn, Counter at 0. Work Stockinette stitch with REPEATED COLOR STRIPES AS SHOWN ON THE CHART. Knit to Row 21. Cast on 1 st. every 2nd row 5x (back neck shaping). After Row 31 (33) SHAPE SHOULDER: ON EVERY 6th Row bind off 1 st. 7x, then bind off 44 sts. ON EVERY 2nd Row, ON ARM SIDE, bind off 3 sts. 1x, 2 sts. 4x, 1 st. 2x. (3 sts. 1x, 2 sts. 3x, 1 st. 3x). Knit to Row 97 (105) and mark each side for center of armhole. Knit to Row 107 (117). Cast on 1 st. 2x, 2 sts. 4x, 3 sts. 1x. (1 st. 3x, 2 sts. 3x, 3 sts. 1x). After Row 121 (131) cast on 44 sts. After Row 123 (133) decrease 1 st. every 6th row 7x. After Row 165 (179), bind off 4 sts. 13x, 2 sts. 1x. After Row 190 (204) bind off 12 sts. After Row 196 (210), MAKE BUTTONHOLES over needles 3 to 9, 27 to 30, 48 to 51, 69 to 72, 90 to 93, counting from the left edge. Make BUTTONHOLES over these same needles after Row 212 (226). After Row 220 (238) bind off the remaining 98 (103) sts. Hang the sts. held on waste yarn back onto the machine. Have your Cam Box or Slide on the LEFT SIDE. Turn the Row Counter to 0 so that odd numbers will be on the right and even row numbers on the left. Knit the 2nd half same as you did the first section but OMIT the Buttonholes. You will be working the shapings on the right side instead of the left.

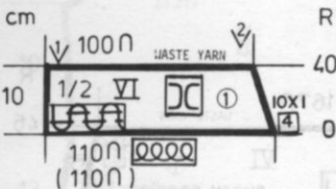

R COLLAR: VI Make 1, reverse 1.

Cast on 110 sts. with color 1 and work K1, P1 Ribbing. ON THE RIGHT, (left for 2nd section) decrease 1 st. every 4th row 10x. After Row 40, remove the sts. onto contrast waste yarn.

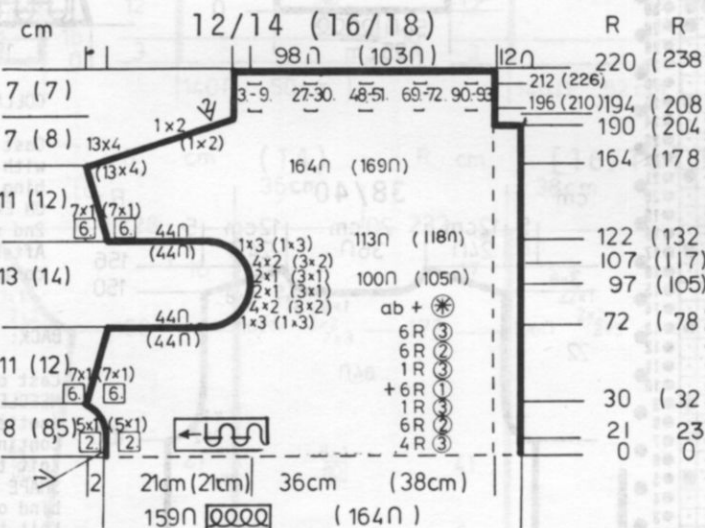

DK 555

WOMAN'S PULLOVER & LEGWARMERS

SIZE: 8/10
 YARN: Allegro
 GRAMS: PULLOVER 550
 GRAMS: LEGWARMERS 200
 TENSION: 8 to 10
 GAUGE:
 Pattern EVERY OTHER NEEDLE
 7 sts. 18 rows = 5 cm (2")
 Ribbing 18 sts. 18 rows = 5 cm

A Tuck stitch Pattern over every other needle. Punch your own card. Worn on the Purl side. Bands are K1, P1 Ribbing over every needle.

FINISHING: See General Instructions.



Other machine owners follow the Line Drawing.

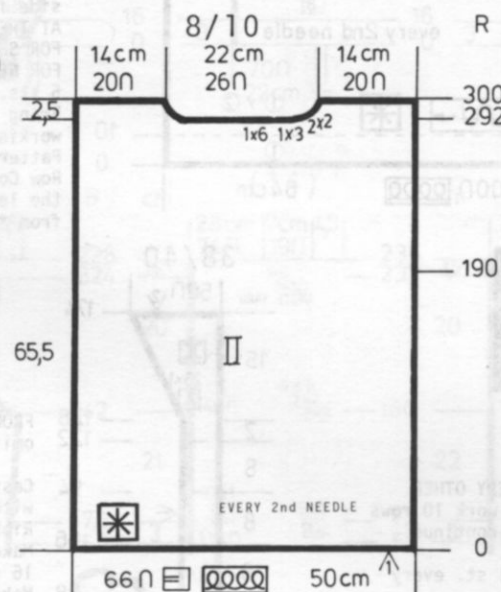

R PULLOVER BACK: II

Cast on 60 sts. over every other needle and work in Pattern. Knit to Row 190. Mark each side for setting in sleeve. Knit to Row 292. SHAPE NECK: Put half the sts. on the left into holding position and complete the right side first. *ON NECK SIDE, bind off 6 sts. 1x, 3 sts. 1x, 2 sts. 2x. After Row 300, bind off. Bring the needles on the left into working position, knit 1 row in Pattern to the left side, turn the Row Counter back to 292 and complete the left half. Follow the instructions from *.

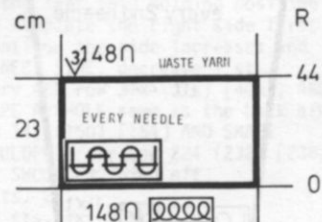

SLEEVE CUFFS:

Cast on 56 sts. over every needle and work 32 rows K1, P1 Ribbing, then bind off the crochet method for Ribbing.

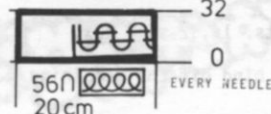

LEG CUFFS:

Cast on 148 sts. over every needle and work 44 rows K1, P1 Ribbing then remove the sts. onto contrast waste yarn.

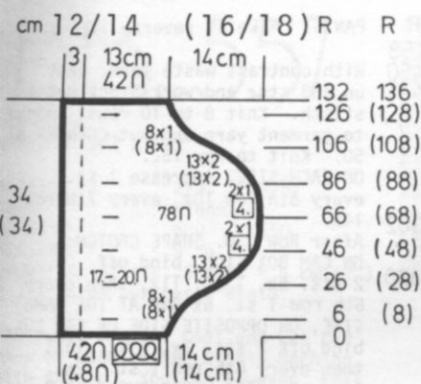

SHORT SLEEVES:

Cast on 42 (48) sts. and work Stockinette stitch with color stripes the same as you did for front and back. Make **BUTTONHOLES** over needles 17 to 20 counting from the **LEFT** edge after the rows shown on the Chart for **YOUR SIZE**. After Row 6, **ON EVERY 2ND ROW**, on the **RIGHT**, cast on 1 st. 8x, 2 sts. 13x, then every 4th row, cast on 1 st. 2x. Mark Row 66 (68) with a bit of waste yarn (center of sleeve). Knit 10 rows, then increase 1 st. every 4th row 2x and **ON EVERY 2nd Row**, cast on 2 sts. 13x, 1 st. 8x. After Row 132 (136) bind off.

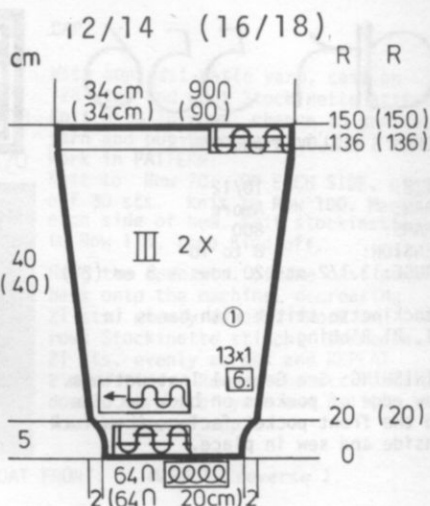

SKIRT:
With contrast waste yarn, cast on 197 sts. Knit 8 to 10 rows, change to color 1 and put counter at 0. Work Stockinette stitch. Knit to Row 13 (14). Work **SHORT ROWS**. **ON OPPOSITE SIDE OF CAM BOX**, put into holding position 17 sts. 10x. **ON OPPOSITE SIDE OF CAM BOX**, bring back into working position 17 sts. 10x. Knit to Row 64 (66). **REPEAT FROM BEGINNING** 12x in all (Row 768 (792)). Remove the sts. onto contrast waste yarn.

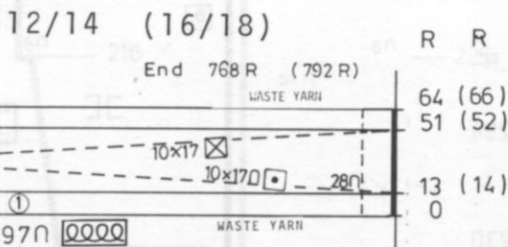

LOWER SLEEVES: III

Cast on 64 sts. with color 1 and work 20 rows K1, P1 Ribbing. Continue in Stockinette stitch. **ON EACH SIDE**, increase 1 st. every 6th row 13x. After Row 136, transfer every other stitch to the Ribber and work 14 rows K1, P1 Ribbing then bind off the crochet method for Ribbing.

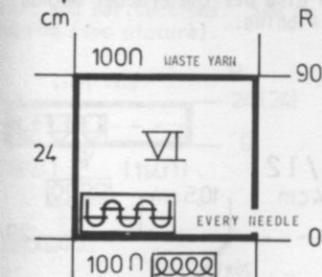

COLLAR: VI Make 2 sections.

Cast on 100 sts. over every needle and work 90 rows K1, P1 Ribbing. Remove the sts. onto contrast waste yarn.

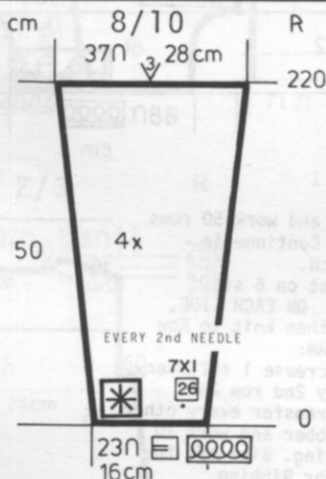

LEG WARMERS: Make 4.

Cast on 23 sts. over every other needle and work in Pattern. **ON EACH SIDE**, increase 1 st. every 26th row 7x. After Row 220, bind off.

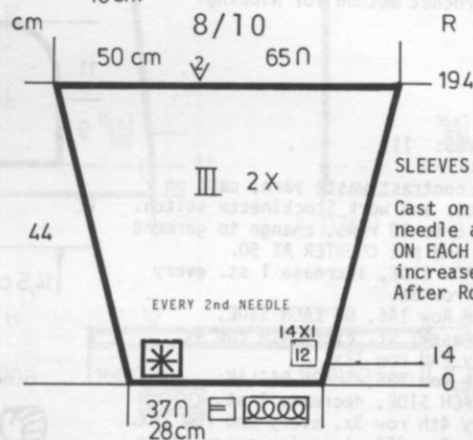

WAISTBAND: Make 2.

Cast on 154 sts. over every needle and work 64 rows K1, P1 Ribbing then remove the sts. onto contrast waste yarn.

SLEEVES: III

Cast on 37 sts. over every other needle and work in Pattern. **ON EACH SIDE**, after Row 14, increase 1 st. every 12th row 14x. After Row 194, bind off.



PULLOVER FRONT: I

Work the front the same as the back to Row 260. Put half the sts. on the left into holding position and complete the right side first. ***ON NECK SIDE**, bind off 4 sts. 1x, 2 sts. 2x, 1 st. 5x. After Row 300, bind off the remaining sts. Bring the needles on the left into working position, knit 1 row in Pattern to the left side, turn the Row Counter back to 260 and complete the left half. Follow the instructions from *.

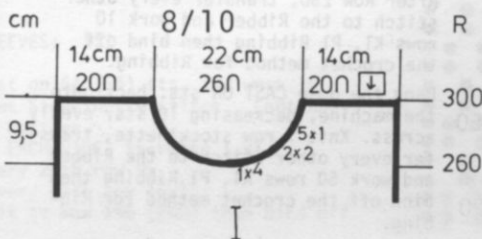
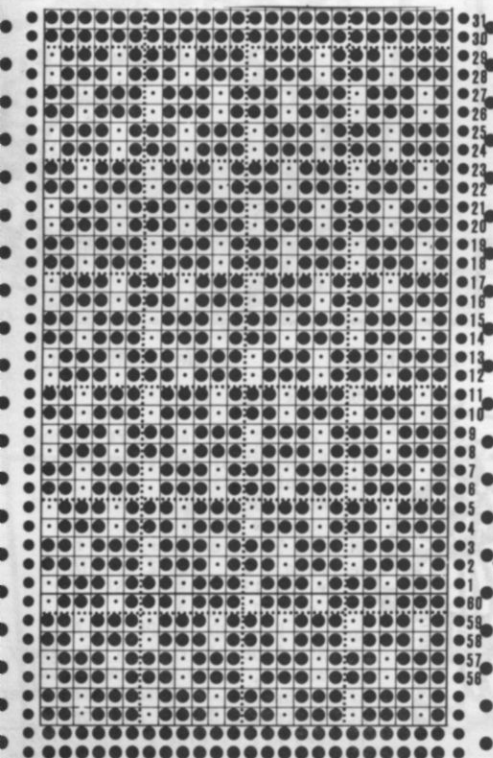

DK 556

WOMAN'S PULLOVER and PANTS

SIZE: 10/12
 YARN: Amore
 GRAMS: 800
 TENSION: 8 to 10
 GAUGE: 13 1/2 sts. 20 rows = 5 cm (2")

Stockinette stitch with bands in K1, P1 Ribbing.

FINISHING: See General Instructions. Sew edge of pockets on back section to the front pocket facing, then tuck inside and sew in place.

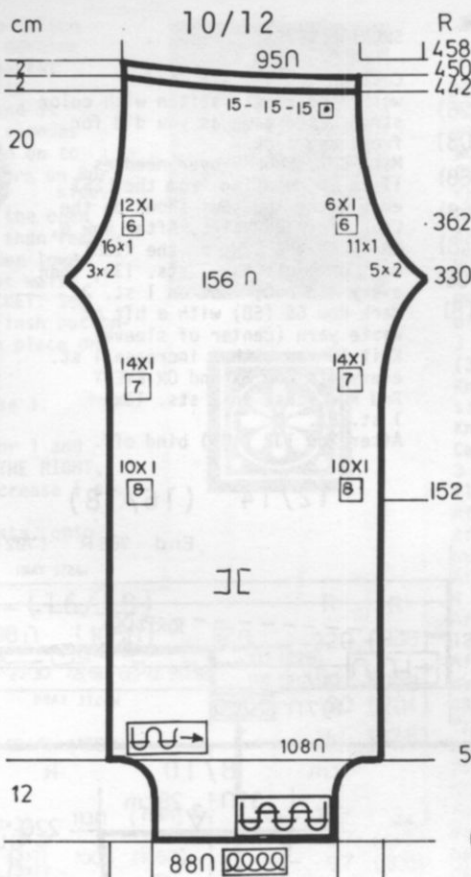

PANTS: Make 1, reverse 1.

With contrast waste yarn, cast on 108 sts. and work Stockinette stitch. Knit 8 to 10 rows, change to garment yarn and put COUNTER AT 50. Knit to Row 152.

ON EACH SIDE, increase 1 st. every 8th row 10x, every 7th row 14x.

After Row 330. SHAPE CROTCH: ON CAM BOX SIDE, bind off 2 sts. 5x, 1 st. 11x, then every 6th row 1 st. 6x AND AT THE SAME TIME, ON OPPOSITE SIDE OF CAM BOX, bind off 2 sts. 3x, 1 st. 16x, then every 6th row 1 st. 12x. After Row 443, WORK SHORT ROWS: ON OPPOSITE SIDE OF CAM BOX, put into holding position 15 sts. 3x. Bring all the needles back into working position and knit to Row 458 then bind off loosely.

Work the 2nd section with reverse shaping, casting on from RIGHT TO LEFT. Cam Box will be on the LEFT SIDE, for ROW 50. Hang the OPEN CAST ON STS. BACK onto the machine, decreasing 20 sts. evenly across. Knit 1 row Stockinette stitch, transfer every other stitch to the Ribber and work 50 rows K1, P1 Ribbing then bind off the crochet method for Ribbing.

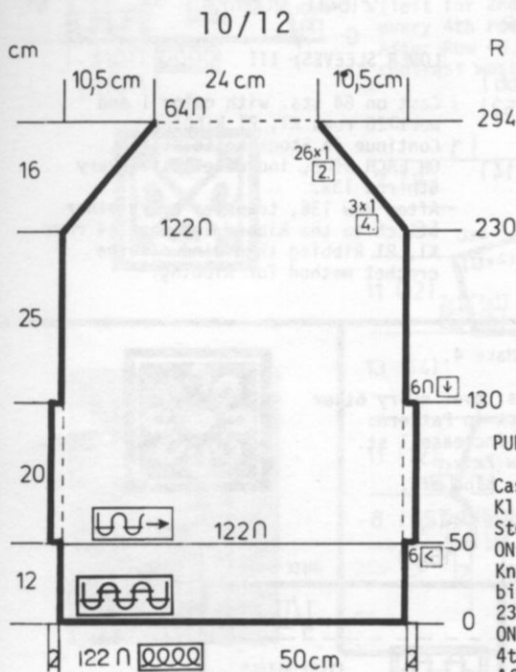

PULLOVER FRONT: I

Cast on 122 sts. and work 50 rows K1, P1 Ribbing. Continue in Stockinette stitch.

ON EACH SIDE, cast on 6 sts. Knit to Row 130. ON EACH SIDE, bind off 6 sts. then knit to Row 230. SHAPE RAGLAN: ON EACH SIDE, decrease 1 st. every 4th row 3x, every 2nd row 26x. After Row 294, transfer every other stitch to the Ribber and work 10 rows K1, P1 Ribbing. Bind off the crochet method for Ribbing.

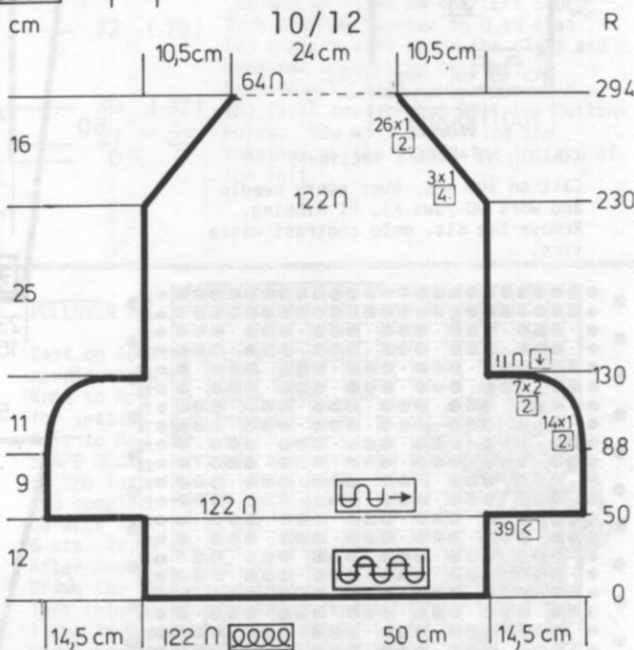

PULLOVER BACK: II

Cast on 122 sts. and work 50 rows K1, P1 Ribbing. Continue in Stockinette stitch. ON EACH SIDE, cast on 39 sts. Knit to Row 88. ON EACH SIDE, on every 2nd row, decrease 1 st. 14x, 2 sts. 7x. After Row 130, ON EACH SIDE, bind off 11 sts. Knit to Row 230. SHAPE RAGLAN: ON EACH SIDE, decrease 1 st. every 4th row 3x, every 2nd row 26x. After Row 294, transfer every other stitch to the Ribber and work 10 Rows K1, P1 Ribbing then bind off the crochet method for Ribbing.

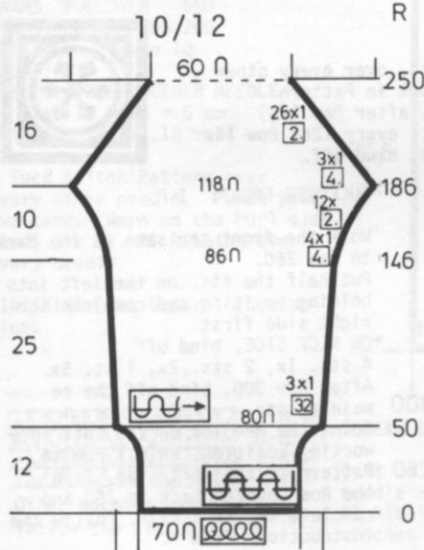

SLEEVES: III

With contrast waste yarn, cast on 80 sts. and work Stockinette stitch. Knit 8 to 10 rows, change to garment yarn and put COUNTER AT 50. ON EACH SIDE, increase 1 st. every 32nd row 3x.

After Row 146, ON EACH SIDE, increase 1 st. every 4th row 4x, every 2nd row 12x. After Row 186, SHAPE RAGLAN: ON EACH SIDE, decrease 1 st. every 4th row 3x, every 2nd row 26x. After Row 250, transfer every other stitch to the Ribber and work 10 rows K1, P1 Ribbing then bind off the crochet method for Ribbing.

Hang the open CAST ON sts. back onto the machine, decreasing 10 sts. evenly across. Knit 1 row stockinette, transfer every other stitch to the Ribber and work 50 rows K1, P1 Ribbing then bind off the crochet method for Ribbing.

KK 557

KID'S COAT & CAP

SIZES: 2/3 (4/5)
YARN: Vienna
STAMS: 600 650
ENSION: 5 to 7
GAUGE: 14 1/2 sts. 25 rows = 5 cm (2")
 1 1/2 yards purchased Braid.



The Punch Plie for Coat and Cap can only be made on the Studio Machine with Ribber. You can however, knit simulated stitch on any machine without a Ribber. For 820 and 830 machine owners, use CARD NO. 2 (in set of Cards with your machine) and for the Pattern, PUSH IN ONLY 1 TUCK BUTTON. The knit side is the right side.

FINISHING: See General Instructions. Leave the front bands in place then sew in a zipper. Weave the neckband in place. Sew braid down the fronts (see Picture). CAP: Sew center front seams together. Turn under 16 rows at back neck edge. Work 1 row single crochet around front and ear sections. Sew on Pom-Pom (see picture).

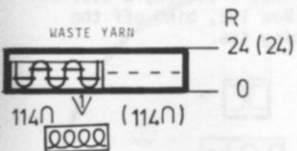

NECKBAND:

Cast on 114 sts. and work 24 rows K1, P1 Ribbing. Remove the sts. onto contrast waste yarn.

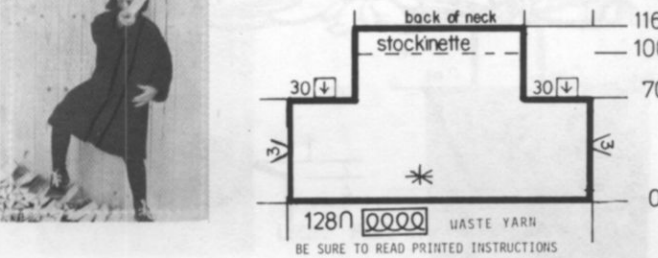
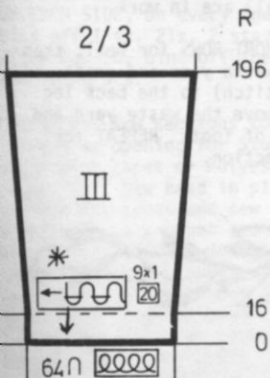

R CAP:

With contrast waste yarn, cast on 128 sts. and work Stockinette stitch. Knit 8 to 10 rows, change to garment yarn and put Counter at 0. Work in PATTERN: Knit to Row 70. ON EACH SIDE, bind off 30 sts. Knit to Row 100. Mark each side of hem. Knit stockinette to Row 116, then bind off.

Hang the open sts. of the cast on back onto the machine, decreasing 21 sts. evenly across. *Work 3 rows Stockinette stitch. Decrease 21 sts. evenly across and REPEAT 2 more times. Remove the sts. onto double strand of yarn and pull up for the top of cap.

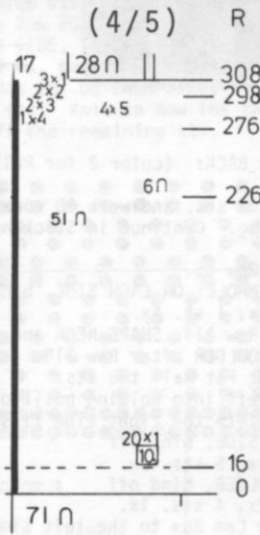
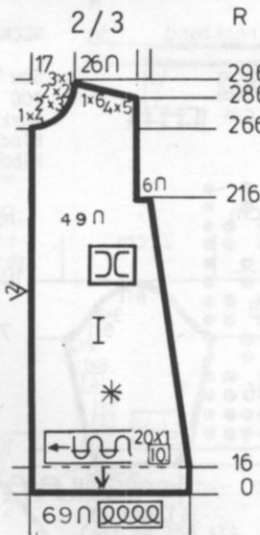

COAT FRONT: I Make 1, reverse 1.

Cast on 69 (71) sts. and work 16 rows Stockinette stitch. Continue in Pattern.

ON SIDE EDGE, decrease 1 st. every 10th row 20x. After Row 216 (226), ON SIDE EDGE, bind off 6 sts.

Knit to Row 267 (277).

SHAPE NECK: Bind off for both sizes, 4 sts. 1x, 3 sts. 2x, 2 sts. 2x, 1 st. 3x, AND SHAPE SHOULDER same as the back after Row 286 (298).

COAT BACK: II

Cast on 128 (134) sts. and work Stockinette stitch to Row 16. Continue in Pattern.

ON EACH SIDE, decrease 1 st. every 12th row 15x (16x).

After Row 216, ON EACH SIDE, bind off 6 sts.

Knit to Row 286 (298).

SHAPE SHOULDER and WATCH FOR NECK SHAPING:

FOR SHOULDER, bind off 5 sts. 4x, 6 sts. 1x, (5 sts. 4x, 8 sts. 1x), AT THE SAME TIME, after Row 290, (300) put half the sts. on the left into holding position and complete the right side first. *ON NECK SIDE, bind off 11 sts. 1x, 3 sts. 2x.

Bring the needles on the left into working position, knit 1 row in Pattern to the left side, turn the Row Counter back to 290 (300) and complete the left half. Follow the instructions from * and don't forget to complete the shoulder shaping.

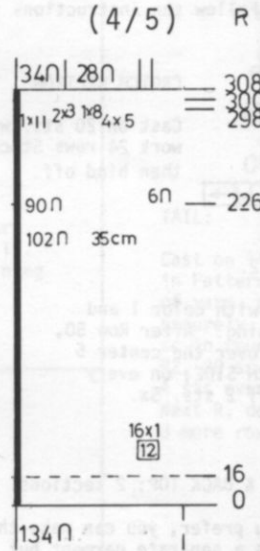
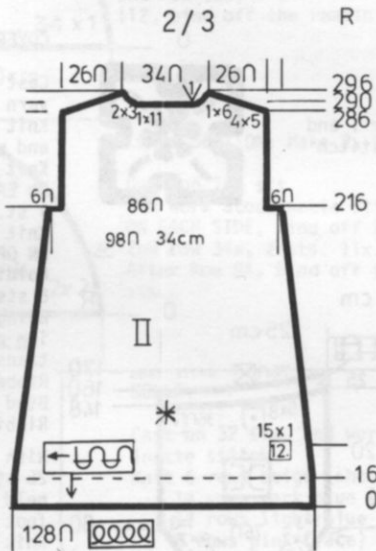

FRONT BANDS: Make 2.

Cast on 160 (168) sts. and work 8 rows K1, P1 Ribbing then remove the sts. onto contrast waste yarn.

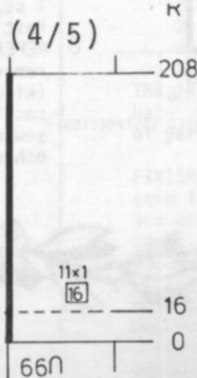

SLEEVES: III

Cast on 64 (66) sts. and work 16 rows Stockinette stitch. Continue in Pattern. ON EACH SIDE, increase 1 st. every 20th row 9x. (every 11th row 16x). Knit to Row 196 (208) then bind off.

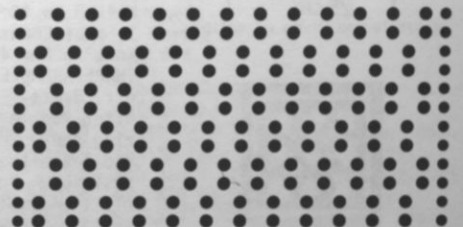

KK 558



BABY COVERALL & PULLOVER

SIZE: 9 months to 1 year.
YARN: Color 1 - Allegro
 Color 2 - Amore
GRAMS: color 1 150
 color 2 100
TENSION: 6 to 8
GAUGE:
 Coverall: 15 sts. 20 rows = 5 cm
 Pullover: 14 sts. 19 rows = 5 cm

Stockinette stitch with Ribbed Bands.

FINISHING: See General Instructions.



PULLOVER FRONT:

Work the front the same as the back to Row 104. Put half the sts. on the left into holding position and complete the right side first.
 *ON NECK SIDE, bind off 7 sts. 1x, 2 sts. 5x and after Row 118, SHAPE SHOULDER same as the back.
 Move the Cam Box to the left side, turn the Row Counter back to 104 and complete the left half.
 Follow the instructions from *.

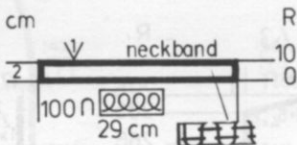
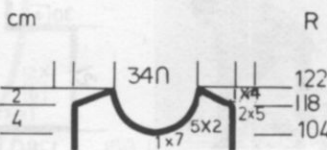

NECKBAND:

Sew 1 shoulder, then pick up 100 sts. around neckline and work 10 rows K1, P1 Ribbing. Bind off the crochet method for Ribbing.

9 months to 1 year

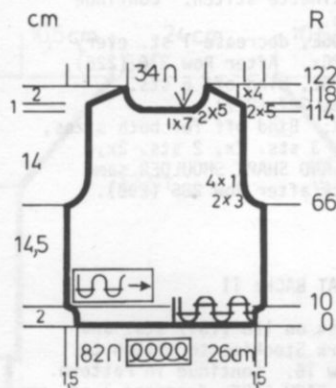

PULLOVER BACK: (color 2 for Pullover)

Cast on 82 sts. and work 10 rows K1, P1 Ribbing. Continue in Stockinette stitch.
 Knit to Row 66.
 SHAPE ARMHOLE: ON EACH SIDE, bind off 3 sts. 2x, 1 st. 4x.
 Knit to Row 114. SHAPE NECK and SHAPE SHOULDER after Row 118.
 FOR NECK: Put half the sts. on the left into holding position and complete the right side first.
 *ON NECK SIDE, bind off 7 sts. 1x, 5 sts. 2x.
 FOR SHOULDER, bind off 5 sts. 2x, 4 sts. 1x.
 Move the Cam Box to the left side, turn the Row Counter back to 114 and complete the left half.
 Follow the instructions from *.

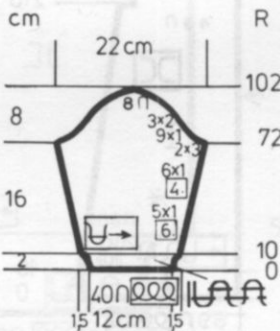

SLEEVES:

Cast on 40 sts. and work 10 rows K1, P1 Ribbing. Continue in Stockinette stitch.
 ON EACH SIDE, increase 1 st. every 6th row 5x, every 4th row 6x. Knit to Row 72.
 SHAPE CAP: ON EACH SIDE, bind off 3 sts. 2x, 1 st. 9x, 2 sts. 3x.
 After Row 102, bind off the remaining sts.

CROTCH SECTION:

Cast on 20 sts. with color 1 and work 24 rows Stockinette stitch then bind off.

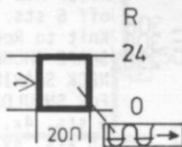

COVERALL: Make 1, reverse 1.

Cast on 50 sts. with contrast waste yarn and work Stockinette stitch. Knit 8 to 10 rows, put Counter at 0 and work with garment yarn (color 1). Knit to Row 64.
 ON EACH SIDE, increase 1 st. 4x, 2 sts. 3x, 3 sts. 1x. Knit to Row 147 then work SHORT ROWS. ON OPPOSITE SIDE OF CAM BOX, put into holding position 36 sts. 1x, then 8 sts. 5x.
 Bring all the needles back into working position and after Row 160, transfer every other stitch to the Ribber and work 10 Rows K1, P1 Ribbing. Bind off the crochet method for Ribbing.

STRAPS: Make 2.

Cast on 21 sts. with color 1 and work K1, P1 Ribbing. After Row 50, make BUTTONHOLE over the center 5 sts. then ON EACH SIDE, on every 2nd row, bind off 2 sts. 5x.

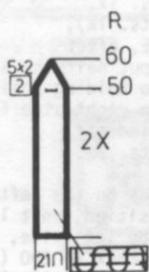

FRONT & BACK TOP: 2 sections.

If you prefer, you can make the top as a separate garment but you must cast on and work 14 rows of K1, P1 Ribbing. The garment in picture has the top (worked without ribbing) sewn to the top of ribbed band of the pants and the instructions for this follow.

With contrast waste yarn, cast on 76 sts. and work Stockinette stitch. Knit 8 to 10 rows, change to color 1. Put Counter at 0.
 Knit to Row 44.

SHAPE ARMHOLE: ON EACH SIDE, bind off, 3 sts. 2x, 2 sts. 4x, 1 st. 2x. After Row 70, make picots by transferring every 2nd st. to the next needle and leave the empty needles in working position. Knit to Row 80 then bind off the remaining sts. Make the 2nd section the same.

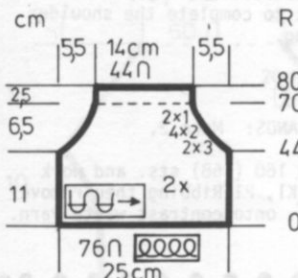

BE SURE TO READ PRINTED INSTRUCTIONS

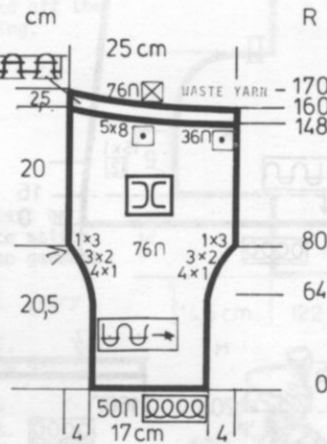

BE SURE TO READ PRINTED INSTRUCTIONS

With purl side facing you, hang 25 sts. of the front leg section held on waste yarn, then work the foot section.
 Knit 26 rows then work SHORT ROWS. ON OPPOSITE SIDE OF CAM BOX, put into holding position, 1 st. each row until 7 remain in center. Put back 1 st. until all are in work. Knit 26 rows.
 REPEAT THE SHORT ROWS for heel, then remove onto waste yarn and graft (kitchener stitch) to the back leg section. Remove the waste yarn and sew up sides of foot. REPEAT for other foot section.



KK 559

TOYS

YARN: Vienna for BUG & POODLE when using the simulated Pattern. Fine 2 ply yarn for Punch Pile on Studio machine with Ribber.

GRAMS: VIENNA only.

Poodle - 450 Color 1
Bug - 200 Color 1, 150 Color 2

Dolls: Left over yarns such as Amore, Vienna, Allegro

TENSION: 5 to 7 on Knitter

GAUGE: 13 sts. 17 rows = 5 cm (Stock).
13 sts. 20 rows = 5 cm (Punch Pile or simulated Stitch).

The Punch Pile for the Bug and Poodle can only be made on the Studio Machine with Ribber. You can, however, knit a simulated stitch on any machine without a Ribber. For 820 and 830 machine owners, use CARD NO. 2 (in set of cards with your machine) and for the Pattern, PUSH IN ONLY 1 TUCK BUTTON. The knit side is the right side.

FINISHING: Given with each Toy.

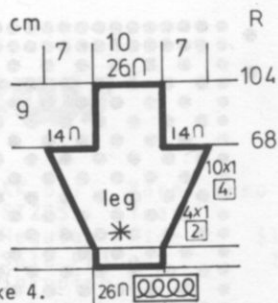

LEGS: Make 4.

Cast on 26 sts. and work in Pattern. Knit to Row 20.

ON EACH SIDE, increase 1 st. every 2nd row 4x, every 4th row 10x. After Row 68 ON EACH SIDE, bind off 14 sts. Knit to Row 104 then bind off the remaining sts.

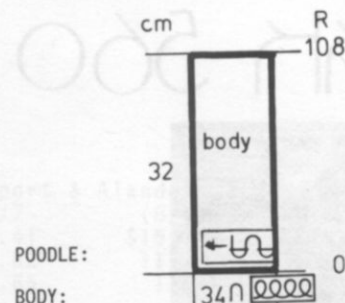
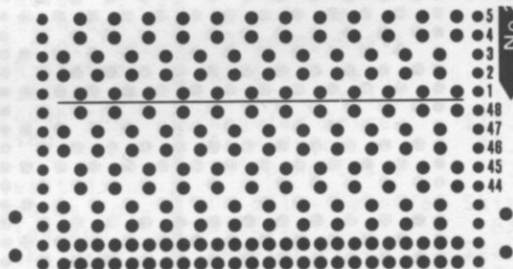

POODLE:

BODY:

Cast on 34 sts. and work Stockinette stitch to Row 108. Bind off.

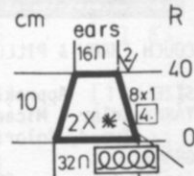

EARS: Make 2.

Cast on 32 sts. and work in Pattern. ON EACH SIDE, on every 4th row, decrease 1 st. After Row 40, bind off the remaining sts.

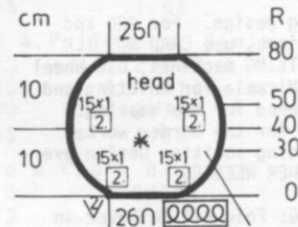

HEAD: (this is one part of head).

Cast on 26 sts. and work in Pattern. ON EACH SIDE, on every 2nd row, increase 1 st. 15x. Knit to Row 50. ON EACH SIDE, on every 2nd row, decrease 1 st. 15x. After Row 80, bind off the remaining sts.

TAIL:

Cast on 14 sts. and work 8 rows in Pattern. Remove onto strand of yarn, pull up and tie securely. At cast on end, work sc in rounds. R1, 20 sc. R2, 20 sc. Next R, decrease 4 sts evenly. Work 3 rows even. Next R, decrease 4 sts. Work 8 more rows even.

SNOOT:

Ch 3, form a ring. 6 sc in ring. Next 3 rows, sc, increasing 6 sts. around. Work even through 11th round. Next Round, increase 6 sts. Work 2 rows even. Next round, increase 4 sts. Work 1 row even. Fasten off.

HEAD: (2nd part).

Gather the outside edge of knitted head section, then work 40 sc around. Work 7 rows sc. Next round, decrease 10 st. Work 2 rows even. Fasten off.

FINISHING: Sew body together. Gather and sew up 1 end then stuff firmly and close other end in the same way. Sew up legs, and stuff. Stuff snout, head, tail. Sew all sections to body (see picture). Make tongue with red felt and sew in place.

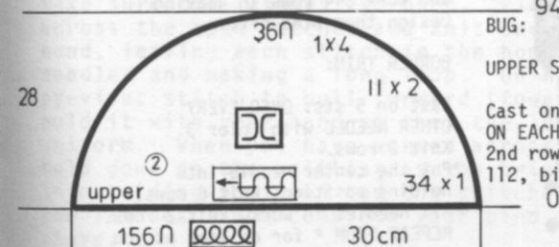

BUG:

UPPER SECTION: Make 2, COLOR 1.

Cast on 156 sts. and work in Pattern. ON EACH SIDE, bind off 2 sts. every 2nd row 42x, 3 sts. 14x. After Row 112, bind off the remaining sts.

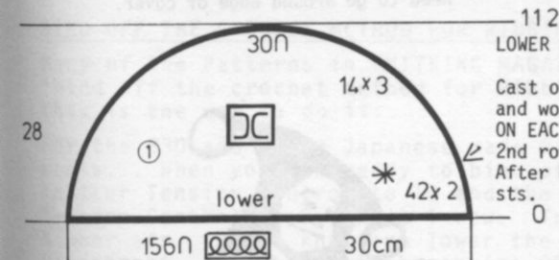

LOWER SECTION: Make 2, COLOR 2.

Cast on 156 sts. and work Stockinette stitch. ON EACH SIDE, bind off 1 st. every 2nd row 34x, 2 sts. 11x, 4 sts. 1x. After Row 94, bind off the remaining sts.

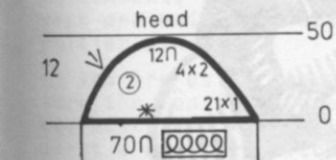

HEAD SECTION:

Cast on 70 sts. and work in Pattern. ON EACH SIDE, on every 2nd row, bind off 1 st. 21x, 2 sts. 4x. After Row 50, bind off the remaining sts.

FINISHING: Sew sections together leaving an opening for Stuffing. Stuff with Kapok or Polyester fiber fill. Sew head in place. Crochet the spots and sew in place. To crochet spots... With black, ch 3, join to form ring. Work 6 dc in ring, join. Ch 3, 2 dc in each st. Join. Ch 3, 2 dc in next st., 1 dc in next st. and repeat around. Join. Sew spots as shown in picture.

DOLLS:

Cast on 32 sts. and work stockinette stitch. Knit 6 rows beige (shoes) 14 rows dark blue (pants) 12 rows light blue (shirt) 8 rows pink (face) 2 rows dark blue 2 rows light blue 2 rows dark blue 2 rows white 2 rows dark blue 2 rows light blue 2 rows dark blue

The last 14 rows of stripes form hat. Remove the sts. onto strand of yarn and pull up.

FINISHING: Sew seam. Fold so that seam is down the back. Stuff, then sew up feet. Embroider eyes and mouth. With thread, sew through the whole body to form pants and do the same for arms (see picture). Make pom-pom or tassel for top of hat and sew or crochet a hanger at back of head or on top (see picture). Make a chain and sew in place for suspenders.

KK 560



COUCH THROW & PILLOW

SIZE: Approx. 32" x 63"
 YARN: Color 1 Micaela, Color 2, Alanda Tweed, Color 3, Binia
 GRAMS:
 color 1 800
 color 2 500
 color 3 200
 TENSION: 7 to 9
 GAUGE: 13 sts. 17 rows = 5 cm (2")

A Weaving Design. For 820 and 830 machines, use CARD NO. 1. AM 3 KNITTING machines, use Wheel No. 6. Micaela for knitting and Alanda Tweed for the Weaving. Binia is for the Border worked in a holding position Design over EVERY OTHER NEEDLE.

FINISHING: Fold Pillow Cover in half and sew seams leaving an opening for Pillow (or you can stuff it with Polyester Fiber fill). Close opening then work 1 row single crochet around edges. COUCH THROW: Block and hide all ends. Sew Trim around edges.

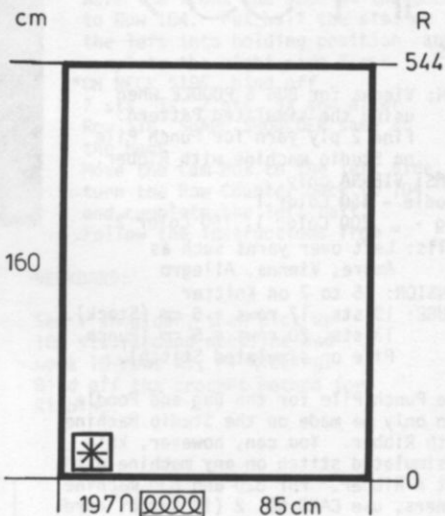
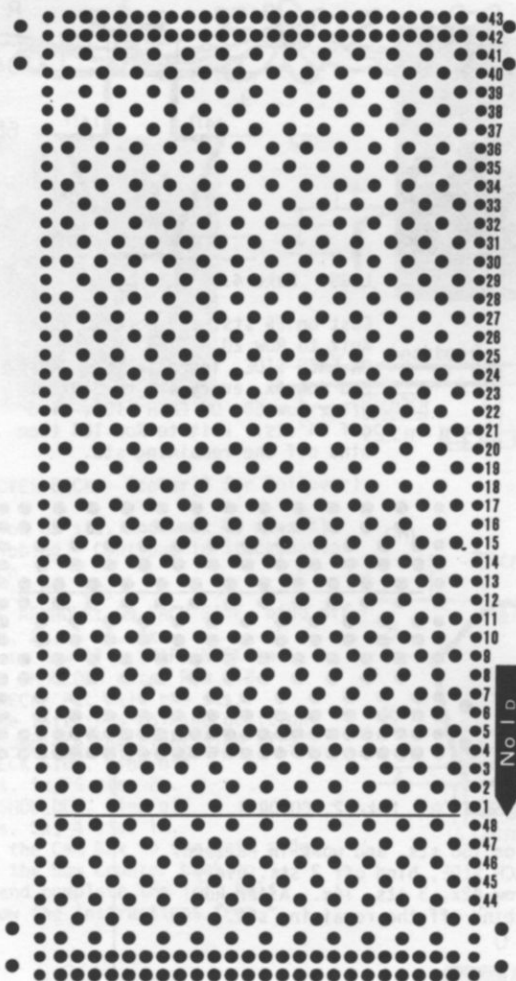

COUCH THROW:

Cast on 197 sts. with color 1 and work 544 rows in Weaving Design then bind off.

BORDER TRIM:

Cast on 5 sts. OVER EVERY OTHER NEEDLE with Color 3. Knit 2 rows.
 *Put the center needle into holding position, knit 6 rows. All needles in work, knit 2 rows. REPEAT FROM * for as long as you need to go around edge of cover.

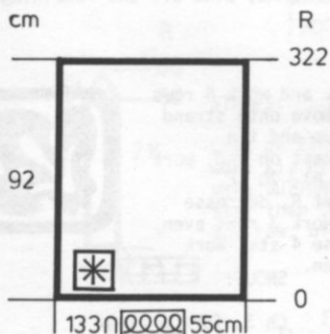

PILLOW:

Cast on 133 sts. with color 1 and work the Weaving Design to Row 322. Bind off.

At 3 - Use Wheel No. 6.





Knitking News

PRACTICAL KNITTING HINTS

THE CROCHET BIND OFF

The crochet method for binding off on the main machine is very simple and you can use this method on ANY knitting machine without the Ribber.

When you have completed a section, knit 1 row with a tension setting AT LEAST 4 numbers higher than the tension you used for knitting your garment. Now bring all the needles into holding position and with your latch tool, begin at the end OPPOSITE the yarn end. Take the first stitch off the machine needle onto the latch tool and allow it to go behind the latch. Remove the 2nd stitch and pull it through the stitch on the latch tool, then allow this stitch to go behind the latch of tool.. Continue in this manner until the last stitch has been removed. Pull the end of yarn through the last stitch on tool to secure the knitting.

If you cannot turn your tension up at least 4 numbers, you must knit this last row by hand as follows: Bring the needles into "D" position and make sure the latches are open. Place the yarn across the open latches and knit each stitch by hand, leaving each stitch in the hooks of the needles and making a long loop. Do not allow the previous stitch to pull forward (toward you)... hold it with your hand so that the loops are all uniform. When you have worked across the needles, hold down on the knitting as you bring the needles into holding position and the stitches go behind the latches. Now complete your bind off as given above.

BIND OFF THE CROCHET METHOD FOR RIBBING

Many of the Patterns in KNITKING MAGAZINE state "bind off the crochet method for Ribbing"... and this is the way to do it:

For the 830 and other Japanese made Ribbing Attachments... When you are ready to bind off, set the Knitter Tension Control to 10 and the Ribber Tension Control to 8. Knit 1 row. Transfer the Ribber sts. to the knitter, lower the Ribbing Attachment, then bind off beginning OPPOSITE the yarn end using the same method as given for the Knitter bind off.

If you are using heavy weight yarn and you cannot turn the tension numbers up at least 4 numbers, you must then knit this last row BY HAND, taking first a knitter stitch then a Ribber stitch. After all the stitches have been knit by hand, transfer the Ribber stitches to knitter and bind off the same crochet method.

KITS FOR THIS ISSUE OF KNITKING MAGAZINE

Be sure to take advantage of the Special Discounts on the Yarn Kits for garments in this issue of KNITKING MAGAZINE. Remember to give alternate colors and that the Special Discounts are only good until the next issue of the magazine.

DISCOUNTS ON YARN KITS FOR THIS ISSUE

KK 536 - Yarn: Euro Sport			
SIZES:	7/8	(9/10)	[11/12]
Regular Price	\$9.03	\$10.32	\$10.32
Sale Price	6.79	7.76	7.76
Shipping Costs	1.65	1.65	1.65

KK 537 - Yarn: Euro Sport & Alanda Tweed			
SIZES: Years	6/7	(8/9)	[10/11]
Regular Price	\$14.41	\$15.70	\$15.70
Sale Price	10.82	11.78	11.78
Shipping Costs	1.65	1.65	1.65

KK 538 - Yarn: Binia			
SIZES:	9/10	(11/12)	[13/14]
Regular Price	\$15.29	\$18.07	\$18.07
Sale Price	11.44	13.52	13.52
Shipping Costs	1.65	1.65	1.65

DK 539 - Yarn: Fortissima			
SIZES:	8/10	(12/14)	[16/18]
Regular Price	\$22.26	\$25.44	\$27.03
Sale Price	16.66	19.04	20.33
Shipping Costs	1.65	1.65	1.65

KK 540 - Yarn: Euro Sport			
SIZES: Years	11/12	(13/14)	[15/16]
Regular Price	\$14.19	\$16.77	\$19.35
Sale Price	10.67	12.61	14.55
Shipping Costs	1.65	1.65	1.65

DK 541 - Yarn for Skirt & Pullover - Binia			
SIZES:	8/10	(12/14)	
Regular Price	\$23.63	\$26.41	
Sale Price	17.68	19.72	
Shipping Costs	1.65	1.65	

DK 541 - Yarn for Bolero & Cap - Binia			
SIZES:	8/10	(12/14)	
Regular Price	\$9.73	\$13.90	
Sale Price	7.30	11.04	
Shipping Costs	1.65	1.65	

DK 542 - Yarn: Allegro			
SIZES:	8/10	(12/14)	
Regular Price	\$27.03	\$30.21	
Sale Price	20.23	22.61	
Shipping Costs	1.65	1.65	

KK 543 - Yarn Allegro			
SIZES:	1 to 2 years		
Regular Price	\$4.77		
Sale Price	3.58		
Shipping Costs	1.00		

KK 544 - Yarn: Euro Sport			
SIZES:	8	(10)	[12]
Regular Price	\$10.32	\$11.61	\$12.90
Sale Price	7.76	8.71	9.70
Shipping Costs	1.65	1.65	1.65

KK 545 - Yarn: Euro Sport			
SIZES:	1	(2)	[3]
Regular Price	\$12.90	\$14.19	\$15.48
Sale Price	9.70	10.67	11.64
Shipping Costs	1.65	1.65	1.65

DK 546 - Yarn: Binia			
SIZES:	8.10	(12/14)	
Regular Price	\$18.07	\$19.46	
Sale Price	13.52	14.56	
Shipping Costs	1.65	1.65	

KK 547 - Yarn: Fortissima			
SIZES:	1 to 2	(3 to 4)	
Regular Price	\$17.49	\$19.08	
Sale Price	13.09	14.28	
Shipping Costs	1.65	1.65	

KK 548 - Yarn: Allegro			
SIZES:	6 to 9 months		
Regular Price	\$7.95		
Sale Price	5.95		
Shipping Costs	1.00		

DK 549 - Yarn: Euro Sport
 SIZE: 10/12
 Regular Price \$16.77
 Sale Price 12.61
 Shipping Costs 1.65

DK 550 - Yarn: Allegro
 SIZES: 8/10 (12/14)
 Regular Price \$15.90 \$20.67
 Sale Price 11.90 15.47
 Shipping Costs 1.65 1.65

DK 551 - Yarn: Allegro
 SIZES: 8/10 (12) [14]
 Regular Price \$9.54 \$9.54 \$11.13
 Sale Price 7.14 7.14 8.33
 Shipping Costs 1.65 1.65 1.65

DK 552 - Yarn: Fortissima
 SIZES: 12 (14) [16/18]
 Regular Price \$25.44 \$28.62 \$31.80
 Sale Price 19.04 21.42 23.80
 Shipping Costs 1.65 1.65 1.65

HP 553 - Yarn: Binia
 SIZE 38/40
 Regular Price \$27.80
 Sale Price 20.85
 Shipping Costs 1.65

DK 554 - Yarn: Crocus
 SIZES: 12/14 (16/18)
 Regular Price \$41.80 \$43.89
 Sale Price 31.40 32.97
 Shipping Costs 1.65 1.65

DK 555 - Yarn: Allegro
 SIZE: 8/10
 Regular Price \$23.85
 Sale Price 17.85
 Shipping Costs 1.65

DK 556 - Yarn Amore
 SIZE: 10/12
 Regular Price \$23.84
 Sale Price 17.88
 Shipping Costs 1.65

KK 557 - Yarn: Vienna
 SIZES: 2/3 (4/5)
 Regular Price \$21.48 \$23.27
 Sale Price 16.11 17.42
 Shipping Costs 1.65 1.65

KK 558 - Yarn: Allegro & Amore
 SIZE: 9 months to 1 year
 Regular Price \$7.75
 Sale Price 5.81
 Shipping Costs 1.00

KK 559 - Poodle & Bug - Yarn: Vienna
 Regular Price \$25.06
 Sale Price 18.80
 Shipping Costs 1.65

KK 560 - Yarn: Micaela, Alanda Tweed & Binia
 SIZE: 32" x 63"
 Regular Price \$57.30
 Sale Price \$42.98
 Shipping Costs 2.15

WE HAVE THEM ALL... hundreds of them !!

NEW, DEMONSTRATORS AND TRADED MACHINES AT GIVE AWAY PRICES....

Nobody can beat our prices, so if you want a second machine, place your order as fast as possible... Maybe you have a friend that cannot afford a brand new machine... If so, please tell her about our low, low prices... and if you want a machine not listed below, let us know... We have too many to list them all.

SINGLE BED		CONDITION	LIST PRICE	SALE PRICE
KNITKING	AM3 -Cam operated with Ribber	(Like new)	\$549.00	\$299.00
	AM2 -Cam operated with Ribber	(Rebuilt like new)	449.00	199.00
	JUMBO Demonstrators	(Excellent)	179.00	95.00
BROTHER	830 with Lacemaker - Demonstrator	(Like New)	\$449.95	\$349.00
	800 Trade-in with Lacemaker	(Excellent)	349.95	125.00
	551 Trade-in with Lacemaker	(Excellent)	149.95	60.00
	800 Ribbing Attachment	(Excellent)	139.95	75.00
	551 Ribbing Attachment	(Very good)	99.50	35.00
GENIE	1800	(Excellent)	\$179.50	\$ 79.50
	CHJ 3	(Very good)	99.50	39.50
	1800 Ribbing Attachment	(Excellent)	139.50	75.00
STUDIO	313	(Very good)	\$369.00	\$125.00
JUKI	1200 With Lacer	(Excellent)	\$369.00	\$125.00
	1300 With Lacer	(Excellent)	369.00	125.00
	2400 Latest Model, 24 stitch Punch Card with Lacer	(Like new)	\$429.00	\$199.00
	1300 Ribber	(Excellent)	169.50	75.00
	Knit Copy	(Excellent)	79.50	39.50
DOUBLE BED				
ORION	1 only - 444 needle Electric with Table	(Excellent)	\$699.00	\$199.00
	444 needle	(Very good)	429.00	95.00
	360 needle	(Very good)	369.00	70.00
SWIFTOMATIC	400 needle	(Very good)	\$399.00	70.00

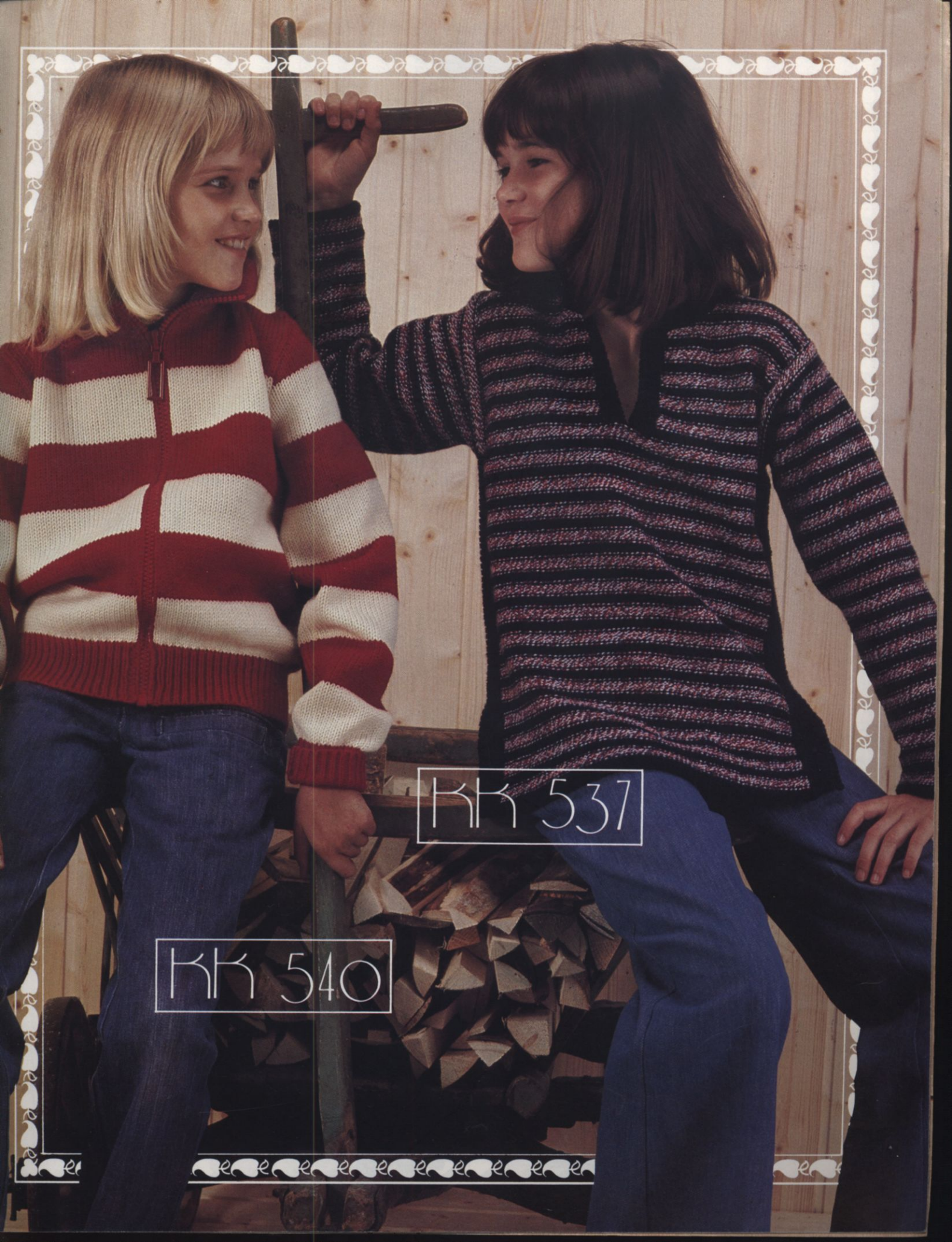

KK 537

KK 540

KK 547



KK 558



KK 557



KK 545



KK 548



KK 543

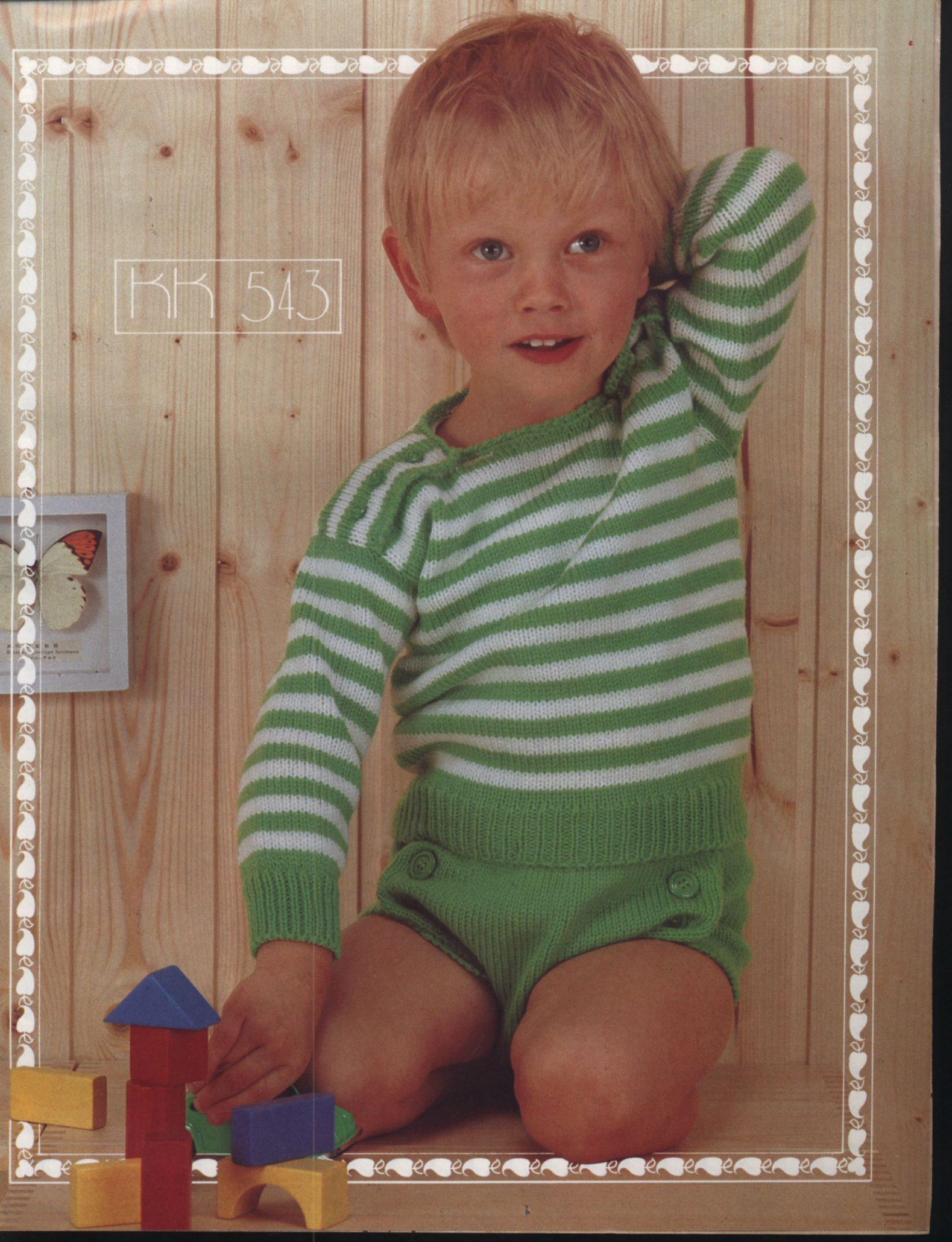

KK 560



KK 559





CK 555