

knitking

magazine





dk 686

dk 676





DK 684



dk 675

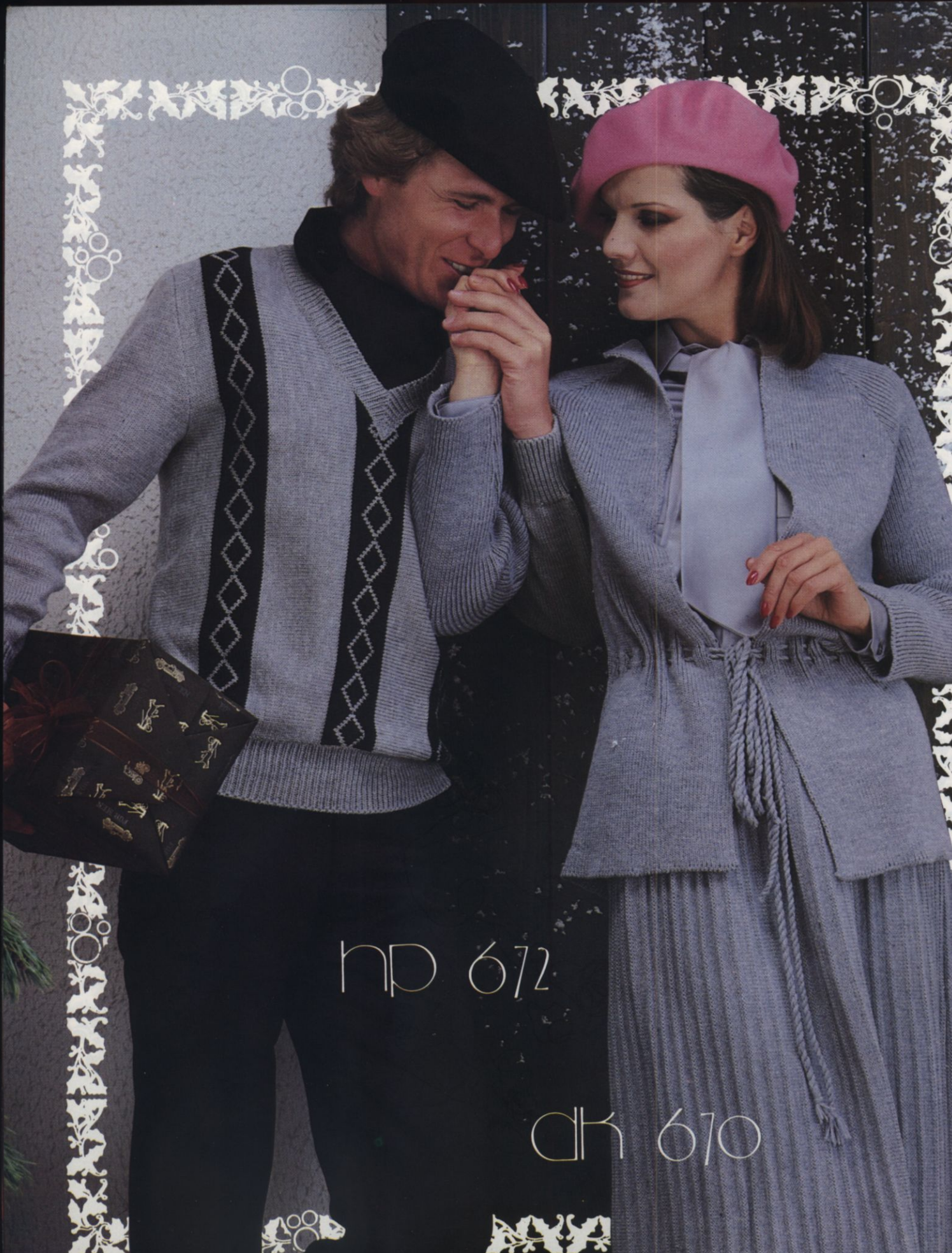

hp 672

dk 670



DK 674

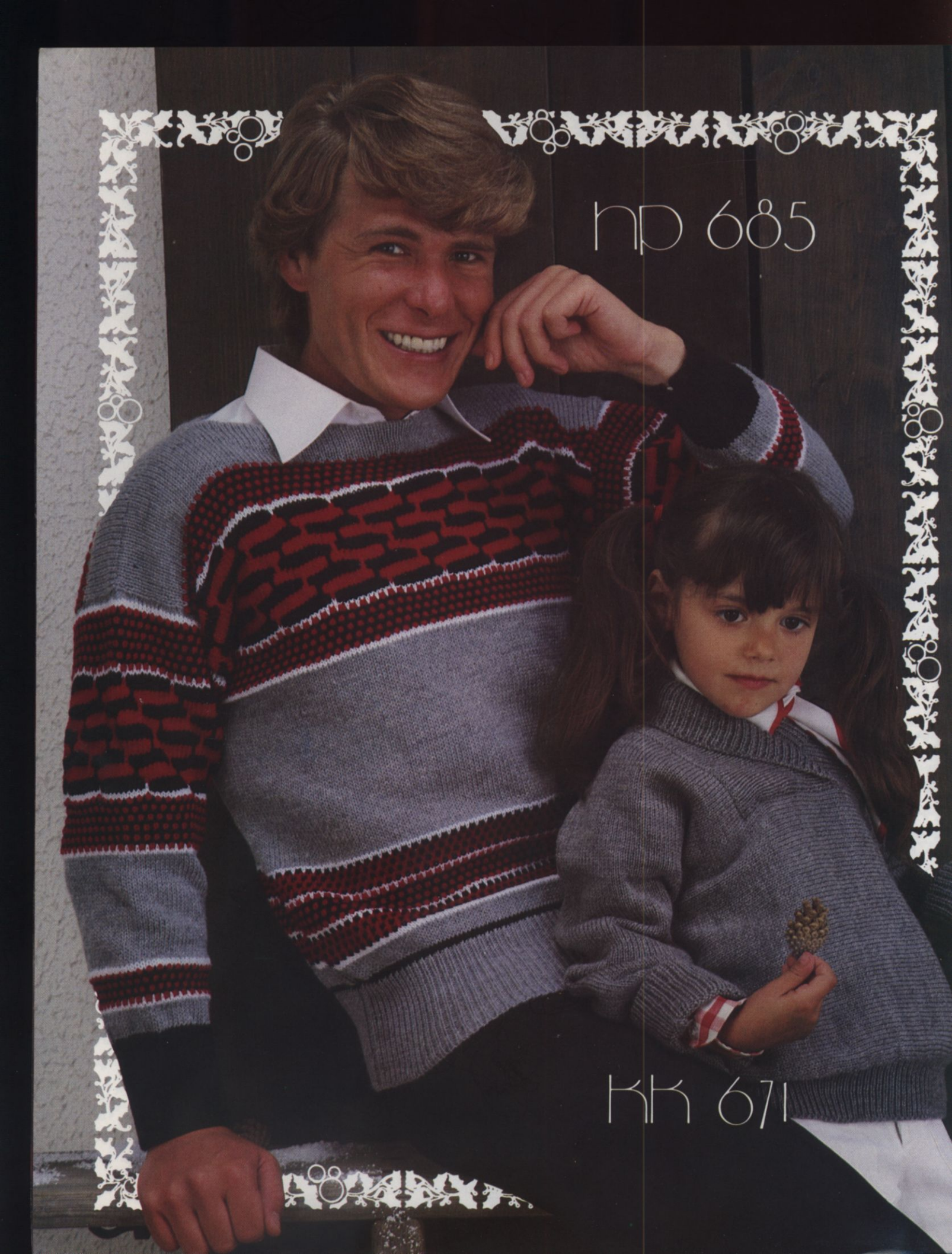

hp 685

KK 671

knitking

magazine

TABLE OF CONTENTS

PAGE NO.

DK 665	Woman's Pullover & Cap	14
HP 666	Man's Pullover	15
DK 667	Woman's Pullover	17
KK 677	Child's Pullover Cap & Mittens	18
KK 669	Child's Pullover & Cap	20
DK 670	Woman's Jacket & Skirt	22
KK 671	Child's Pullover	24
DK 675	Woman's Cardigan & Skirt	24
HP 672	Man's Pullover	27
KK 673	Girl's Pullover, Vest & Cap	29
DK 674	Woman's Jacket	31
DK 676	Woman's Suit	32
KK 678	Child's Pullover, Mittens & Cap.	34
DK 679	Woman's 3-piece Suit	36
KK 680	Teen Pullover	38
DK 681	Woman's Pullover & Headband	40
DK 682	Woman's Coat	40
DK 683	Woman's Jacket	43
DK 684	Woman's Twin Sweater Set	44
HP 685	Man's Pullover	46
DK 686	Woman's Evening Dress	47
DK 689	Woman's Suit	50
687	Rug	51
HP 688	Man's Pullover	52
DK 690	Woman's Vest	53
691	Coverlet & Pillows	54

editorial

As another year draws to a close, we pause to reflect on current activities and progress made by KNITKING during an extremely hectic 1978.

It was a good year... We became the first knitting machine distributor in the U.S.A. to market a range of machines to accommodate all types and weights of yarns from fine single plys (the weight of sewing thread) to Jumbo yarns. We introduced the JUMBO Knitter several years ago after which our manufacturers produced the same machine for the Brother Company and in the Brother name. There is also another bulky yarn knitter on the market. It was offered to KNITKING for resale prior to the introduction of our JUMBO, but our tests showed that it would not knit the range of yarns possible on the JUMBO.

We introduced in 1978, the excellent KH120 (258) needle machine... It too has proved very popular, especially for the larger person... The KH120 knits exquisite fine lace and has the capability of knitting up to 32 inches wide with beautiful dress yarns... Combined with its own Ribbing Attachment, and a total of 516 needles, it knits even wider.

There is no knitter yet made that matches the versatility and simplicity of operation of the KH830 with its Coordinated Ribber, automatic 4-Color Changers, both for the machine and knitter/ribber combination, and the Knitleader. The KH830 is easily the most popular knitting machine in the U.S.A. and the world.

















Our wonderful BELLINKY Seaming Machine rapidly became our most desired accessory and we experienced problems maintaining stocks to satisfy the demand... The popular BABY LOCK and BABY BLINDSTITCH machines maintained their superiority despite the introduction of several copies and we start 1979 by introducing a brand new 'BABY', the EF 405M that performs like no other portable overlock available anywhere.









KNITKING MAGAZINE maintains its position as the finest english language machine publication in the world today and we thank the many readers who take the time to write and tell us about their likes and dislikes.

We look forward with enthusiasm to a big year in 1979. We wish all subscribers and customers, health and happiness and we resolve to continue to offer only the best in merchandise and services at the lowest possible prices.

Pattern Symbols





Knitting – Chart Symbols

- () Size Symbols (2nd Size)
- < > 3rd Size
- ① Color Number
-  Cast on
-  Stitch
-  Row
-  Hem
-  Bind off
-  Stockinette stitch – worn on the Knit side.
-  Stockinette stitch – worn on the Purl side.
-  Knit 1, Purl 1 Ribbing
-  Ribbing Pattern – worn on the Knit side.
-  Ribbing Pattern – worn on the Purl side.
-  Closed Dart
-  Open Dart
-  Put on a stitch holder
-  Reverse 1 section
-  On every other needle
-  Number of Rows between Shapings. Make increase (or decrease) FIRST, then knit 4 rows. For example: 3 x 1  means decrease (or increase) 1 st., knit 4 rows; decrease 1 st., knit 4 rows; decrease 1 st., knit 4 rows; decrease 1 st., knit 4 rows. All decreasing (or increasing) without row numbers as shown must be shaped on every 2nd row.









-  Increase
-  Increase 2 sts. With a transfer tool, move the sts. over the left (or right) leaving 2 empty needles at the point of increase. At the increase point, move 1 st. to the left, (or right) so that there is an empty needles on each side of a stitch. On each side of the center stitch, pick up a stitch from the row below and hang it onto the empty needle.
-  3 stitches on 1 needle. The 1st and 3rd stitch in a group of 3 has been hung on the 2nd or center needle.
-  Short Row increase or decrease; for instance on a flared skirt knitted sideways.
-  Pattern Stitch
-  Pattern Stitch – worn on the Knit side.
-  Pattern Stitch – worn on the Purl side.
-  Repeat

- I = Front
- II = Back
- III = Sleeve
- IV = Skirt Front
- V = Skirt Back
- VI = Collar
- VII = Pocket
- VIII = Band
- IX = Belt
- X = Cuff
- XI = Pants Front
- XII = Pants Back

Finishing – Chart Symbols

-  Match numbers on section for assembling.
-  Ease
-  Fold Line
-  Turn to the wrong side and hem.

Stitch Symbols

-  Needles in holding position
-  Needles back into working position.
-  Empty needle (leave in working position)
-  Needle not used (in the out of work position).
-  Two stitches on 1 needle, either transferred from the right side or the left side, then put into holding position.
-  Needle holding 2 stitches. Stitch has been transferred from the RIGHT.
-  Needle holding 2 stitches. Stitch has been transferred from the LEFT.
-  Center of garment section



General Instructions

HOW TO READ THE CHARTS AND INSTRUCTIONS

There are 3 sizes given for each Pattern in KNITKING MAGAZINE. Above each Chart for the different sizes, you will see that the first and smaller sizes might be shown as 8/10, the second size as (12/14) and the third as [16/18]. Check the measurements at the bustline and hips on the Charts to be certain that you will knit the correct size, remembering these are ACTUAL measurements of the completed section and that there must be a bigger allowance at the bustline and hipline for a Jacket or a Coat than there would be for a fitted dress or a fitted blouse or pullover. The question in your mind should be "How do I want this garment to fit...?"

When you have chosen the size you need, you can follow the Charts as shown. You will notice that where the shapings are the same FOR ALL SIZES, only 1 set of shapings will be shown on the first Chart and if you are knitting the 2nd or 3rd size, you simply follow the shapings as given for the first size. If the shapings are different, this will be shown on the Charts and you should follow them as given.

On the Charts, increases and decreases will be shown as follows

5x1

6 The number in the box means number of ROWS between the shapings, while the 5x1 above the box means - 1 st. 5x... so you will increase or decrease 1 st. every 6th row 5x.

ARMHOLE SHAPINGS - NECK SHAPINGS - SHOULDER SHAPINGS - are made on every 2nd row UNLESS there is a number in a box along side or below the shapings. The rule is... where there is no box with a number, the shaping is made on every 2nd row.

THE PRINTED INSTRUCTIONS

You can follow the printed instructions or use them in combination with the Charts. Where there is any question in the printed instructions, you have the Charts to show you how the section will look.

The 3 sizes, with the different amounts of cast on stitches and the different shapings will look like this...

Cast on 124 (136) [148] sts. You will
Cast on 124 sts. for the first size.
Cast on 136 sts. for the 2nd size.
Cast on 148 sts. for the 3rd size.

The important thing to remember is that you MUST READ AHEAD so that you KNOW what to do for the size you are knitting. Sometimes where the number of stitches are the same but the number of times different, you will find shapings like this...
3 sts. 1x (2x) [3x], 2 sts. 1x (2x) [3x], 1 st. 3x (4x) [5x].
As you see, you MUST read ahead in order to follow the instructions as given for YOUR SIZE. The rows will be different for the different sizes in some cases... Shoulder and Neck shapings usually are worked at the SAME TIME for the back section - so watch for the words AT THE SAME TIME.

HOLDING STITCHES ON THE LEFT SIDE WHILE SHAPING THE RIGHT SIDE

When knitting a section of garment in stockinette stitch, it is easy to hold the stitches on the left side while knitting the right half, but when knitting a Pattern Stitch such as a Norwegian Design, a Holding Position Design, Weaving, etc., you should use the following method. For the NECK SHAPING, we tell you to bind off the center sts., put the needles on the left into holding position and complete the right half first... so with a strand of contrast yarn, knit ALL of the left side stitches manually by hand, pulling each stitch back against the needle bed to the OUT OF WORK position. When the right side is completed, carefully pull the stitches held on contrast, forward into working position and as you do so, undo the contrast yarn, line up the needles (KNITKING AM 3 machine owners, put the stitches under the sinkers) and complete the left half.

If you own a Japanese machine, you may find that when knitting the right half with the left side held in this way, the sinker plate will mark the left side while you are knitting the right half. To prevent this marking, you can tape a piece of paper over the knitting, underneath the sinkers, or if you own a Reversing Bar, you can hang this onto the Sinkers while you are knitting the right half. When hanging the Reversing Bar, be sure the eyes of the bar go BETWEEN the Sinker Posts on the upper part of the bar so that the tips of the bar only - show above the needle bed.

FULL FASHION DECREASING OR INCREASING

For Stockinette stitch, always use the Full Fashion method for increasing or decreasing.

TO DECREASE: Hang the 3rd stitch onto the 2nd stitch then move the stitches in to fill the empty needle.

TO INCREASE: Move the 2 end stitches 1 needle outward, then pick up the 3rd stitch from the row below and hang it onto the empty needle.

FINISHING: Block all sections. For PULLOVERS, JACKETS, and DRESSES: Join front to back at sides and shoulders. Sew sleeves together and set in. Hem lower edge and sleeve edges if needed. For a double neckband or armhole band, sew 1 edge to the inside and 1 to the outside of neck or armhole. For a single ribbed band, sew 1 edge to the outside of neck or armhole edge. For a cardigan or jacket with buttonholes, finish buttonholes and sew on buttons.

PANTS: Join front to back at sides. Sew inside leg seams, then join center front and back. Make hem at waistline and insert elastic. Hem lower edge of pants legs.

THE SAMPLE SWATCH

Before you begin to knit any garment, you will need to knit a sample piece using the yarn you have chosen for your garment, so that you can check the stitch and row gauge which must measure the correct number of stitches and rows in 5 cm (2 inches).

For each Pattern in KNITKING MAGAZINE, we give you 3 tension numbers to work from and if you use the specified yarn for the garment, you should be able to get the correct stitch and row gauge using one of these numbers. Here is a very easy way to make your sample swatch and count the stitches and rows without actually counting, by using our KNITKING Converta Tape.

Supposing the Tension Numbers for the Stitch and Row Gauge are given as 5 to 7. Set the Tension Dial to the first number which is 5. With contrast waste yarn, and using the quick cast on method, cast on 60 stitches and knit 10 rows. Change to garment yarn and turn the Row Counter to 0. Knit 30 rows. Counting from each end, knit the 10th stitch on each side by hand with a small piece of contrast yarn. Leave the needles in working position and knit 30 rows (Row 60), then knit 4 rows with contrast waste yarn. Turn the Row Counter to 0 and the Tension Dial to 6 and with garment yarn, knit 30 rows. Mark the 10th stitch on each side as you did before, knit 30 rows, then 4 rows with contrast waste yarn. Turn the Row Counter to 0 and with Tension 7, repeat the above once more, ending with 10 rows of contrast waste yarn. Remove the work from the machine by passing the Slide across the needles without yarn (sometimes called 'dropping').

Pull and stretch the sample piece both lengthwise and diagonally from corner to corner, then lengthwise again. Do not count the stitches and rows immediately, but allow the sample to rest for several hours or even overnight. This will allow the stitches and rows to return to their basic form.

When your sample has rested and you are ready to count the stitches and rows, the KNITKING CONVERTA TAPE will do the counting for you without any counting on your part. Use the Tape as follows:

Measure the stitches with the TAPE, BETWEEN the 40 stitches marked with contrast waste yarn. Push the SLIDE so that the LEFT EDGE lines up to this exact measurement. Now look down along side the SLIDE and find the number 40 on the TAPE. The number directly opposite on the SLIDE will be your Stitch Gauge to 5 cm (2"). To find the number of rows in 5 cm (2"), place the TAPE to measure over the 60 rows, push the SLIDE to this number with the left edge lined up, the look for the number 60 on the TAPE and directly opposite this will be the number of rows to 5 cm (2")

If you do not own a KNITKING CONVERTA TAPE, you must mark a 5 cm (2 inch) square in the center of the knitting, then count the number of stitches and rows within the square.

dk 665

WOMAN'S PULLOVER & CAP

SIZES: 6/8 (10/12) [14]
 YARN: Micaela
 GRAMS:
 color 1 300 350 400
 color 2 50 100 100
 TENSION 7 to 9
 GAUGE: 13 sts. 18 rows = 5 cm (2")

Stockinette stitch with a Norwegian Border Design. The bands are K2, P2 Ribbing (or K1, P1).

FINISHING: See General Instructions. Pullover Collar: Sew back seam then sew 1 edge to neckline using 78 sts. for the back neck and 104 sts. for the front neck edge. Fold in half to the outside. CAP: Sew back seam if you knitted it flat. Pull top sts. together and secure. Roll lower edge of Cap (see picture).

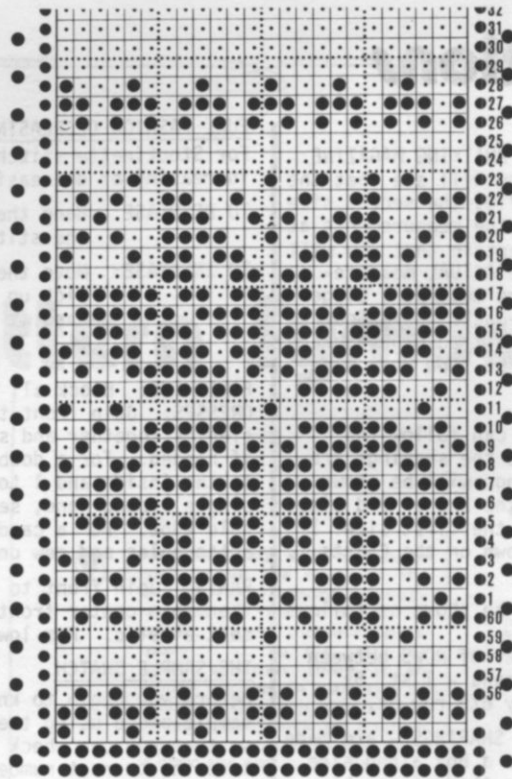

ROLL COLLAR:

Cast on 182 sts. with color 1 and work the Ribbing same as you did for front and back except that you must use a larger tension for 50 rows, then smaller tension for 26 rows. Remove onto waste yarn (or bind off loosely).

CAP: Use Tension 6 to 8

Cast on 130 sts. and work flat (or you can do circular knitting using the Ribber). Knit Stockinette stitch for 110 rows. Mark every 25th and 26th st. then decrease 1 st. before and after each marked stitch every 3rd row 4x, then every row until 10 sts. remain. Remove onto end of yarn and pull up.

FRONT: I

Cast on 130 (134) [140] sts. with color 1 and work K2, P2 (or K1, P1) Ribbing to Row 40. Transfer the Ribber sts. to main machine and work the 7 rows of Norwegian Design as shown on the Chart. Continue in Stockinette stitch with color 1. Knit to Row 148 (148) [152]. Continue in the Norwegian Design as shown on the Chart. After Row 158 (158) [162], SHAPE ARMHOLE: ON EACH SIDE, bind off 3 sts. 2x, 2 sts. 2x, 1 st. 3x. (3 sts. 2x, 2 sts. 2x, 1 st. 4x). [3 sts. 2x, 2 sts. 3x, 1 st. 3x]. When Norwegian Design is completed, continue in Stockinette stitch with color 1. After Row 220 (220) [226], SHAPE NECK: Put half the sts. on the left into holding position and complete the right side first. *ON NECK SIDE, bind off 4 sts. 1x, 3 sts. 2x, 2 sts. 3x, 1 st. 6x. (4 sts. 1x, 3 sts. 2x, 2 sts. 3x, 1 st. 7x). [4 sts. 1x, 3 sts. 2x, 2 sts. 3x, 1 st. 7x]. After Row 238 (238) [246] SHAPE SHOULDER: Bind off 6 sts. 5x. (6 sts. 4x, 8 sts. 1x). [7 sts. 4x, 6 sts. 1x]. Bring the Cam Box to the left side, turn the Row Counter back to 220 (220) [226] and complete the left half. Follow the instructions from *.

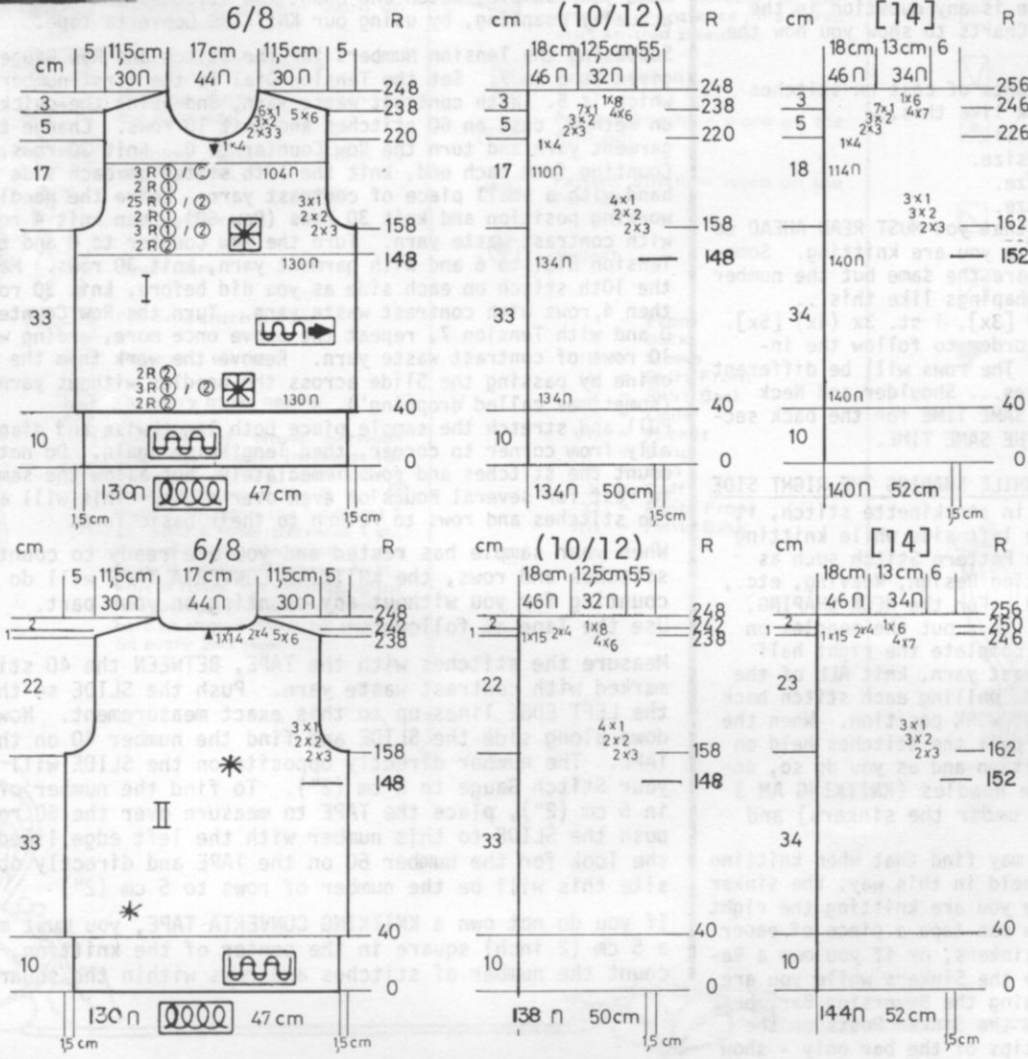

BACK: II

Cast on 130 (138) [144] sts. Work the back the same as the front to Row 158 (158) [162] then SHAPE ARMHOLE same as the front and knit to Row 238 (238) [246]. SHAPE SHOULDER SAME AS THE FRONT but AT THE SAME TIME, after Row 242 (242) [250], SHAPE NECK: Put half the sts. on the left into holding position and complete the right side first. *ON NECK SIDE, bind off 14 (15) [15] sts. 1x, 4 sts. 2x for all sizes. Bring the Cam Box to the left side, turn the Row Counter back to 242 (242) [250] and complete the left half. Follow the instructions from * and don't forget to complete the shoulder shaping. *

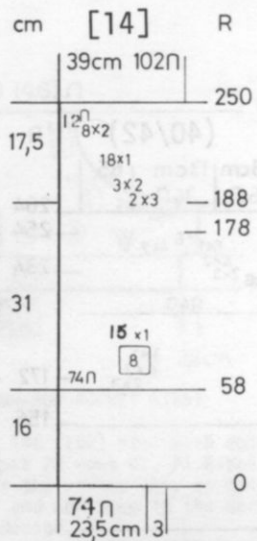
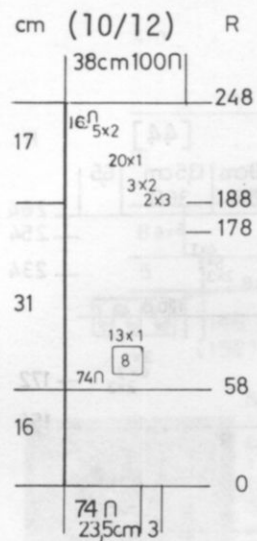
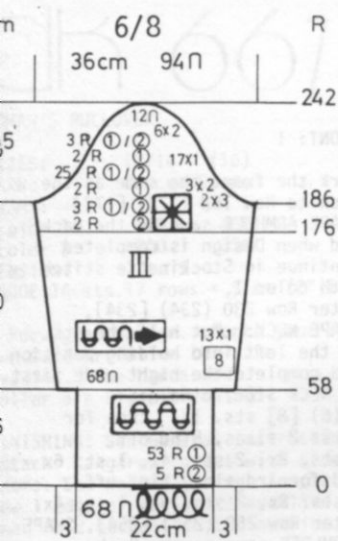

SLEEVES: III

Cast on 68 (74) [74] sts. with color 1 and work Ribbing same as front and back, working 5 rows color 1, 53 rows color 2. Transfer the Ribber sts. and continue in Stockinette stitch with color 1. ON EACH SIDE, increase 1 st. every 8th row 13x (13x) [15x]. After Row 176 (178) [178], continue with the Norwegian Design as shown on the Chart and AT THE SAME TIME, After Row 186 (188) [188], SHAPE CAP: ON EACH SIDE, bind off 3 sts. 2x, 2 sts. 3x, 1 st. 17x, 2 sts. 6x. (3 sts. 2x, 2 sts. 3x, 1 st. 20x, 2 sts. 5x). [3 sts. 2x, 2 sts. 3x, 1 st. 18x, 2 sts. 8x]. After Row 242 (248) [250], bind off the remaining sts.

DP 666

WOMEN'S PULLOVER

SIZE:	36/38	(40/42)	[44]
YARN:	Micaela		
COLOR 1:	400	450	450
COLOR 2:	100	100	100
VISION:	7 to 9		
GUGE:	13 sts. 18 rows = 5 cm (2")		



ROLL COLLAR:

Cast on 162 (170) [170] sts. with color 1 and work Ribbing same as front and back. Work 40 rows in larger tension then 30 rows in smaller tension. After Row 70, remove the sts. onto waste yarn.



BACK: II

Cast on 138 (148) [154] sts. with color 1 and work K2, P2 (or K1, P1) Ribbing to Row 40. Transfer the Ribber sts. to main machine and ON EACH SIDE, increase 1 st. Work 2 rows color 2 stockinette stitch then work the first 3 rows of the Norwegian Design and 2 rows color 2 stockinette stitch. Continue with Stockinette stitch and color 1. Knit to Row 156 then begin the Norwegian Design. After Row 168 (172) [172], SHAPE ARMHOLE: ON EACH SIDE bind off 3 sts. 2x, 2 sts. 3x, 1 st. 3x. (3 sts. 2x, 2 sts. 4x, 1 st. 3x). [3 sts. 2x, 2 sts. 4x, 1 st. 3x]. When Design is completed, continue in Stockinette stitch with color 1. Knit to Row 250 (254) [254]. SHAPE SHOULDER AND WATCH FOR NECK SHAPING. FOR SHOULDER, ON EACH SIDE, bind off 6 sts. 4x, 8 sts. 1x; (7 sts. 4x, 6 sts. 1x); [6 sts. 6x]; AT THE SAME TIME, after Row 254 (258) [258], Put half the sts. on the left into holding position and complete the right side first. *ON NECK SIDE, bind off 15 (15) [16] sts. 1x, 4 sts. 2x for all sizes. Bring the Cam Box to the left side, turn the Row Counter back to 254 (258) [258] and complete the left half. Follow the Instructions from * and don't forget to complete the shoulder shapping.

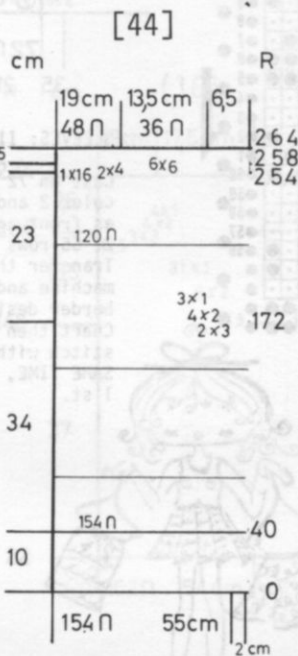
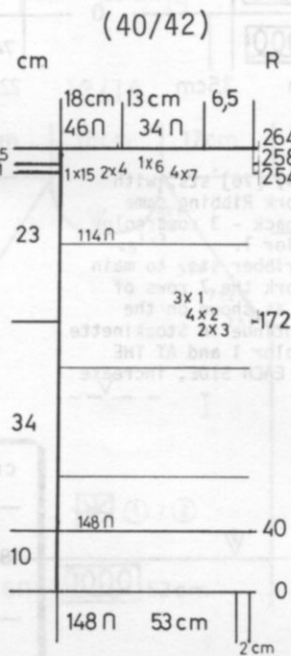
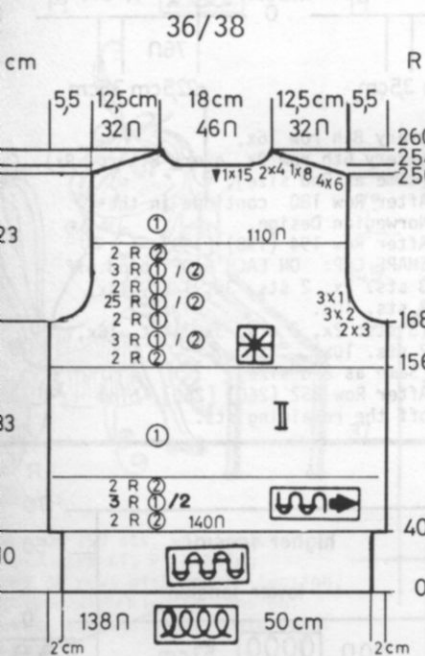

hp 666

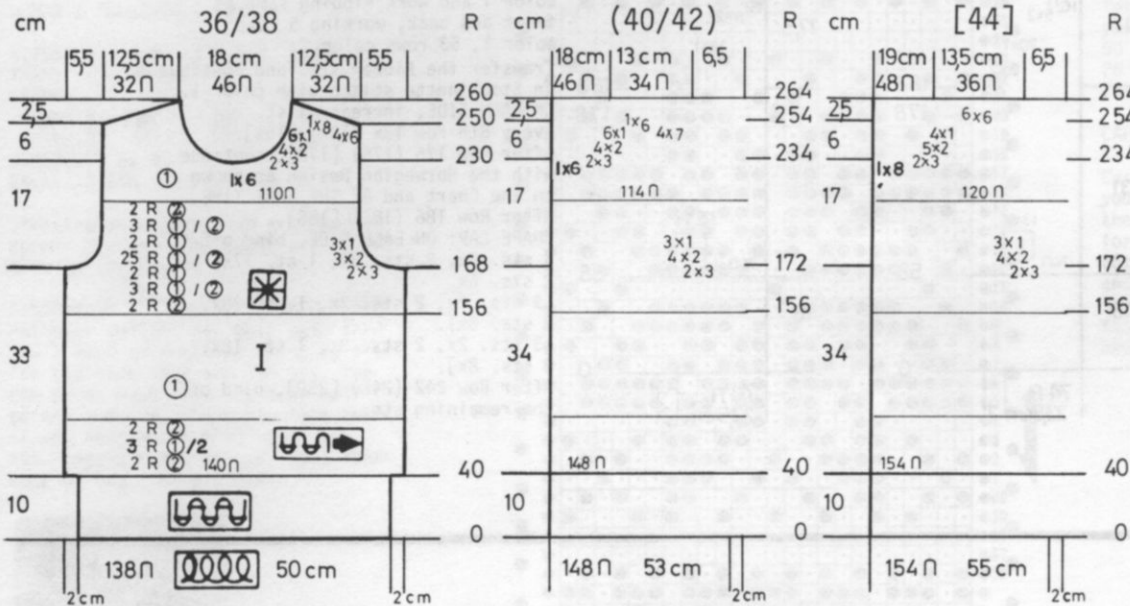

Work the front the same as the back to Row 168 (172) [172]. SHAPE ARMHOLE same as the back and when Design is completed continue in Stockinette stitch with color 1. After Row 230 (234) [234], SHAPE NECK: Put half the sts. on the left into holding position and complete the right side first *ON NECK SIDE, bind off 6 (6) [8] sts. 1x, then for first 2 sizes, bind off 3 sts. 2x, 2 sts. 4x, 1 st. 6x and for 3rd size, bind off 3 sts. 2x, 2 sts. 5x, 1 st. 4x. After Row 250 (254) [254], SHAPE SHOULDER same as the back. Bring the Cam Box to the left side, turn the Row Counter back to 230 (234) [234] and complete the left half. Follow the instructions from *.

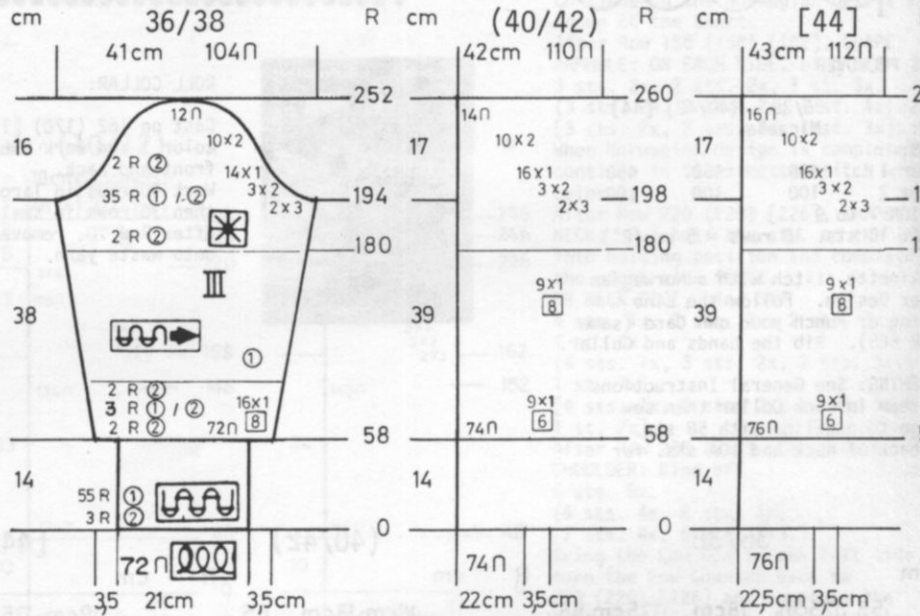
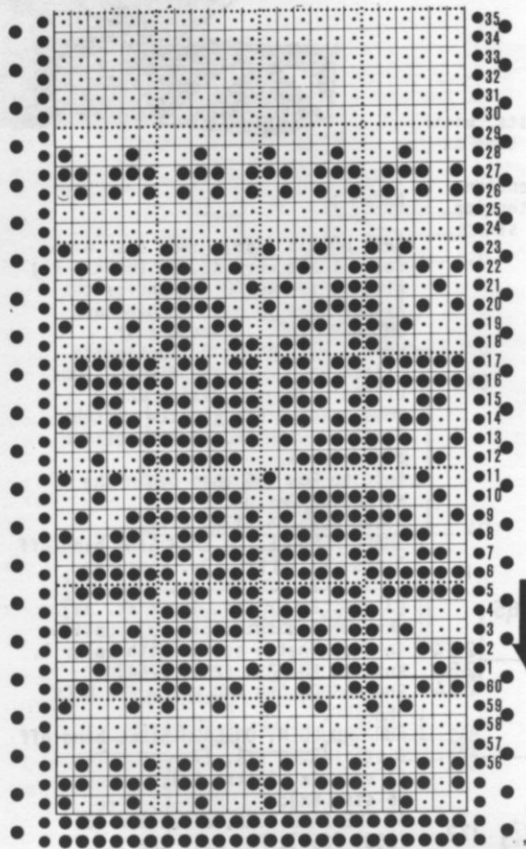

SLEEVES: III

Cast on 72 (74) [76] sts. with color 2 and work Ribbing same as front and back - 3 rows color 2, 55 rows color 1. Transfer the ribber sts. to main machine and work the 7 rows of border design as shown on the Chart then continue in Stockinette stitch with color 1 and AT THE SAME TIME, ON EACH SIDE, increase 1 st.

every 8th row 16x, (every 6th row 9x, every 8th row 9x), [same as 2nd size], After Row 180 continue in the Norwegian Design. After Row 194 (198) [198], SHAPE CAP: ON EACH SIDE, bind off 3 sts. 2x, 2 sts. 3x, 1 st. 14x, 2 sts. 10x. (3 sts. 2x, 2 sts. 3x, 1 st. 16x, 2 sts. 10x). [Same as 2nd size]. After Row 252 (260) [260], bind off the remaining sts.

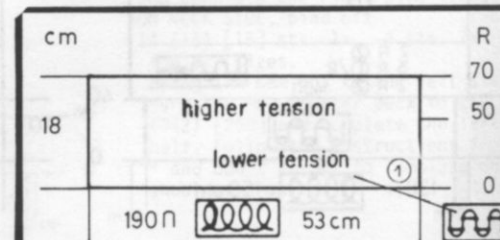

DK 667

WOMAN'S PULLOVER

SIZES: 12/14 (16)
YARN: Crocus Crepe
GRAMS:
 Color 1 400 450
 Color 2 300 350
LENGTH: 7 to 9
GAUGE: 14 sts. 17 rows = 5 cm (2") Pat.

Norwegian Design. Punch your own Card or follow the Line drawing. The bands and collar are K1, P1 Ribbing.

FINISHING: See General Instructions. Attach Kangaroo Pocket with side seams. Sew Pocket facings in place. Sew 1 edge of collar to neckline when fold in half to the outside.

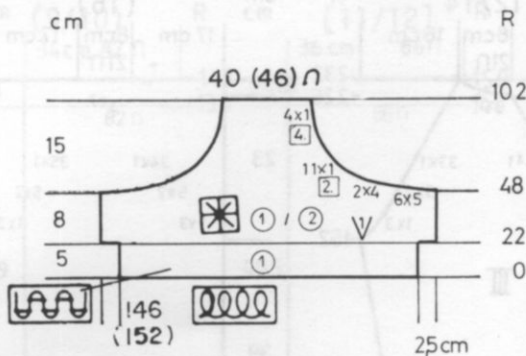

MAKE KANGAROO POCKET FIRST



Cast on 146 (152) sts. with color 1 and work 22 rows K1, P1 Ribbing. Transfer the ribber sts. to main machine and continue in the Norwegian Design. After Row 48, ON EACH SIDE, bind off 5 sts. 6x, 4 sts. 2x, then every 2nd row 1 st. 11x, every 4th row 1 st. 4x. After Row 102, remove the sts. onto waste yarn and put aside.

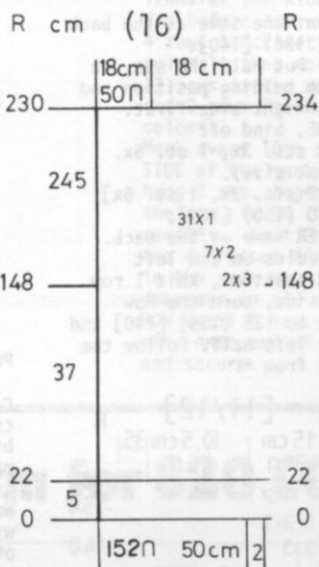
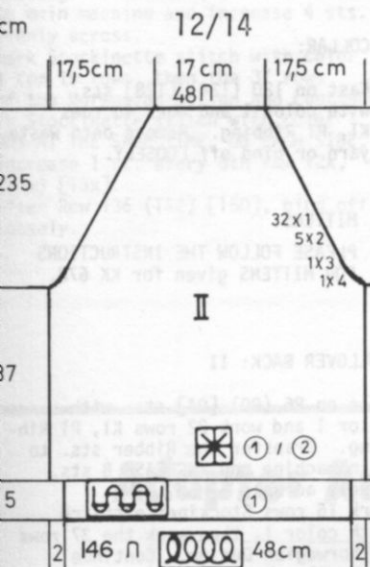
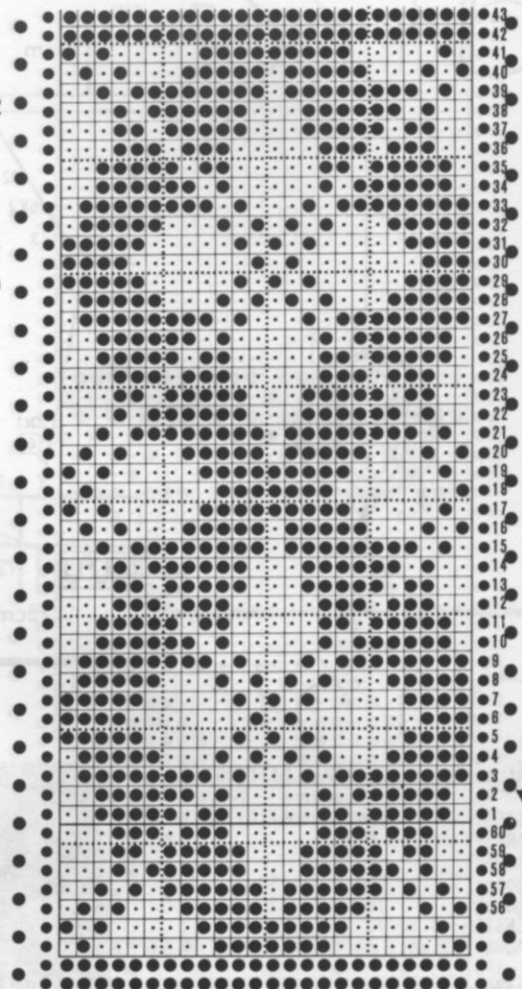

BACK: II

Cast on 146 (152) sts. with color 1 and work 22 rows K1, P1 Ribbing. Transfer the ribber sts. to main machine and continue in the Norwegian Design. Knit to Row 148. SHAPE RAGLAN: ON EACH SIDE, bind off 4 sts. 1x, 3 sts. 1x, 2 sts. 5x, 1 st. 32x. (3 sts. 2x, 2 sts. 7x, 1 st. 31x). After Row 230 (234), bind off the remaining sts.

FRONT: I

Cast on 146 (152) sts. with color 1 and PUT COUNTER AT 22. Work the Norwegian Design to Row 102. Remove the center 40 (46) sts. onto a stitch holder (waste yarn or garter bar) and with pur1 side facing you, hang the sts. of the Pocket onto these empty needles then REPLACE the center sts. from stitch holder on top of the pocket sts. and continue in the Norwegian Design to Row 148. SHAPE RAGLAN: ON EACH SIDE, bind off 3 sts. 1x, 2 sts. 7x, 1 st. 31x; (3 sts. 1x, 2 sts. 8x, 1 st. 31x); AT THE SAME TIME, after Row 200 (204), SHAPE NECK: Put half the sts. on the left into holding position and complete the right side first. (be sure to note pattern row). *ON NECK SIDE, bind off 5 sts. 1x, 3 sts. 3x, 2 sts. 3x, 1 st. 5x. (5 sts. 1x, 3 sts. 3x, 2 sts. 4x, 1 st. 4x). Bring the remaining needles into working position, knit 1 row in Pattern to the left side, turn the Row Counter back to 200 (204) and complete the left half. Follow the instructions from * and don't forget to complete the raglan shaping.



COLLAR:

Cast on 190 sts. with color 1 and work K1, P1 Ribbing. Work 50 rows with looser tension, 20 rows with tighter tension. Remove the sts. onto waste yarn.

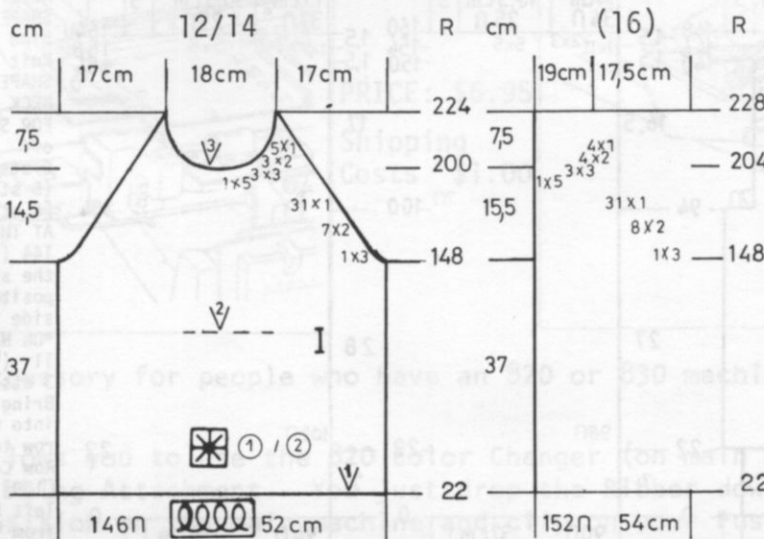

Continued

dk 667

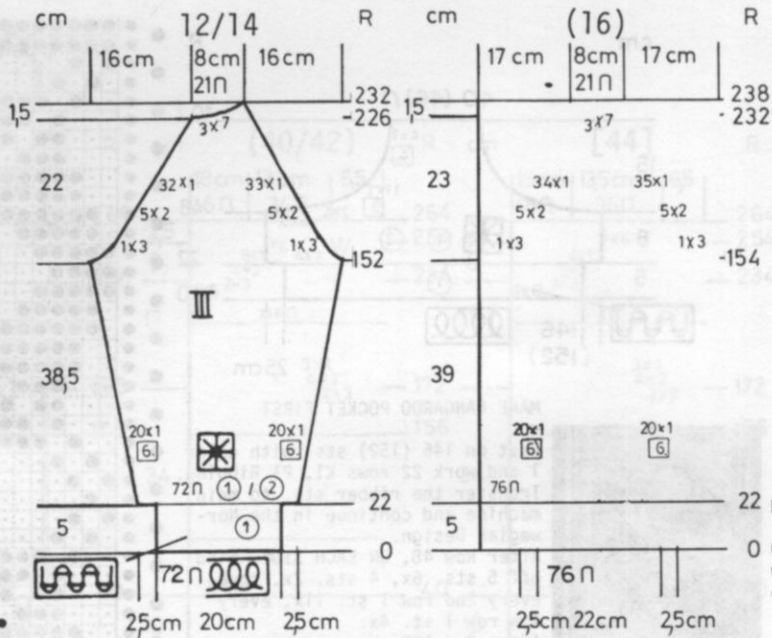

R SLEEVES: III Make 1, reverse 1.

Cast on 72 (76) sts. with color 1 and work 22 rows K1, P1 Ribbing. Transfer the ribber sts. as you did before and continue in the Norwegian Design. ON EACH SIDE, increase 1 st. every 6th row 20x. After Row 152 (154) SHAPE RAGLAN. ON EACH SIDE, bind off 3 sts. 1x. 2 sts. 5x for both sizes, then bind off 1 st. 33x (35x) for back side of sleeve and 1 st. 32x (34x) for front side of sleeve. After Row 225 (231) bind off 7 sts 3x for both sizes. Be sure to reverse the shaping for 2nd sleeve.

POCKET BANDS: Make 2.

0 Cast on 90 sts. with color 1 and work 8 rows K1, P1 Ribbing. Remove onto waste yarn. Sew to pocket edge.

kk 677

CHILDS PULLOVER, CAP & MITTENS

SIZES: 7/8 (9/10) [11/12]
 YARN: Crocus Crepe
 GRAMS
 color 1 500 550 500
 color 2 150 150 200
 TENSION: 9 to 10
 GAUGE: 12 sts. 14 1/2 rows = 5 cm (2")

Stockinette stitch with a Norwegian Design. The bands are Ribbed.

FINISHING: See General Instructions. Make Pom Pom using two colors and sew to top of cap.



PULLOVER FRONT: I

Work the front the same as the back to Row 128 (136) [140]. SHAPE NECK: Put half the sts. on the left into holding position and complete the right side first. *ON NECK SIDE, bind off 3 sts. 2x, 2 sts. 3x, 1 st. 5x. (Same as first size). [3 sts. 2x, 2 sts. 3x, 1 st. 6x]. After Row 140 (150) [154], SHAPE SHOULDER same as the back. Bring the needles on the left into working position, knit 1 row to the left side, turn the Row Counter back to 128 (136) [140] and complete the left half. Follow the instructions from *.

COLLAR:

Cast on 120 (124) [128] sts. with color 1 and work 40 rows K1, P1 Ribbing. Remove onto waste yarn or bind off LOOSELY.

MITTENS:

PLEASE FOLLOW THE INSTRUCTIONS FOR MITTENS given for KK 678.

PULLOVER BACK: II

Cast on 86 (90) [94] sts. with color 1 and work 22 rows K1, P1 Ribbing. Transfer the Ribber sts. to main machine and INCREASE 8 sts. evenly across. Work 16 rows Stockinette stitch with color 1, then work the 37 rows of Norwegian Design. Continue with color 1 and stockinette stitch. After Row 94 (100) [104], SHAPE ARMHOLE: ON EACH SIDE, bind off 7 (7) [8] sts. Knit to Row 140 (150) [154]. SHAPE SHOULDER and watch for NECK SHAPING. FOR SHOULDER, ON EACH SIDE, bind off 6 sts. 3x, 5 sts. 1x, (5 sts. 5x), [5 sts. 5x], AT THE SAME TIME, after Row 144 (154) [158], put half the sts. on the left into holding position and complete the right side first. *ON NECK SIDE, bind off 11 (11) [12] sts. 1x, then 3 sts. 2x for all sizes. Bring the needles on the left into working position, knit 1 row to the left side, turn the Row Counter back to 144 (154) [158] and complete the left half. Follow the instructions from * and don't forget to complete the shoulder shaping.

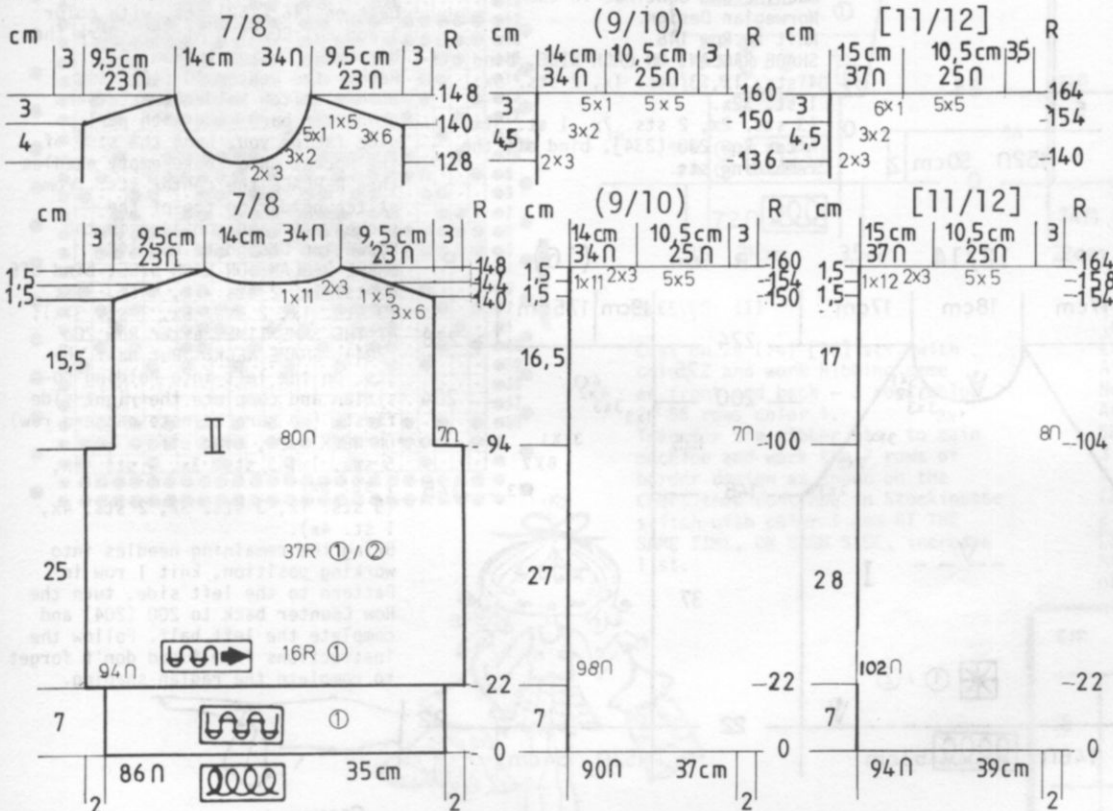

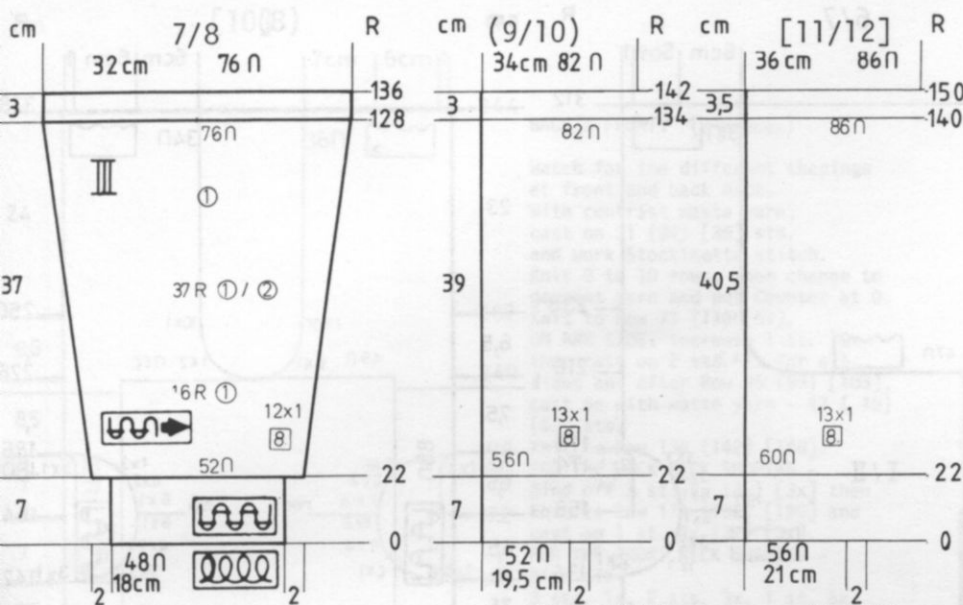

LEEVES: III

Cast on 48 (52) [56] sts. with color 1 and work 22 rows K1, P1 Ribbing. Transfer the Ribber sts. to main machine and increase 4 sts. evenly across.

Work Stockinette stitch with color 1 for 16 rows, then the 37 rows of the Norwegian Design and continue in Stockinette stitch with color 1 BUT AT THE SAME TIME, ON EACH SIDE, increase 1 st. every 8th row 12x, [13x] [13x].

After Row 136 (142) [150], bind off loosely.

CAP: CHART -Same as KK 676 on page 36.

Cast on 110 sts. with color 1 and work 28 rows K1, P1 Ribbing. Transfer the Ribber sts. as you did before and work 4 rows Stockinette stitch with color 1, then work 37 rows in the Norwegian Design, and 2 rows Stockinette stitch with color 1.

Mark every 10th st. and ON EACH SIDE of the marked stitches, hang 2 sts. together and move the sts. in to fill the empty needles. Knit 2 rows and REPEAT the decreases directly above in the same way 3x more, then decrease in the same way ON EVERY ROW until 5 sts. remain. Remove the sts. onto end of yarn and pull up and secure.

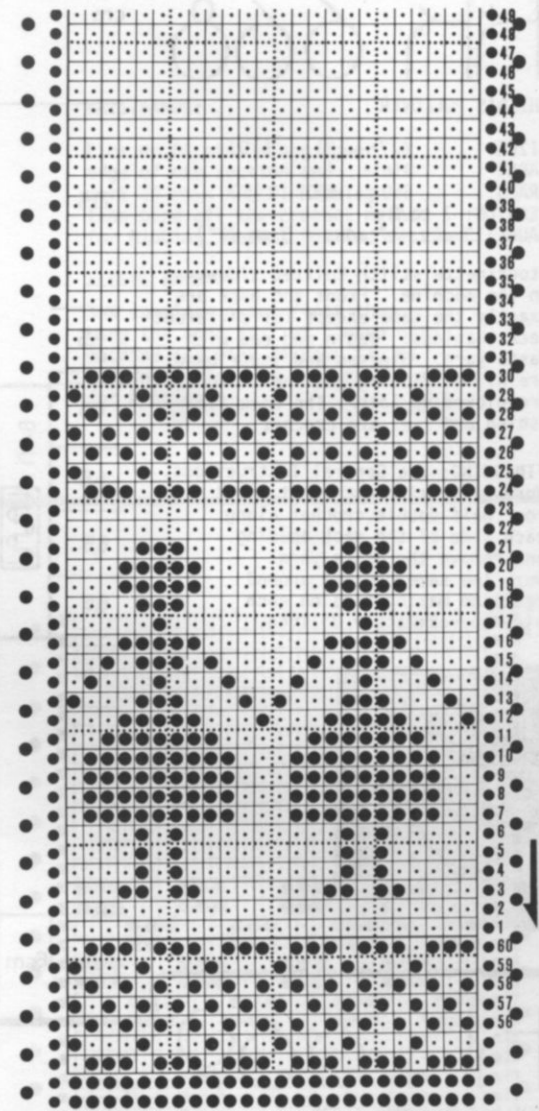

Adaptor Arm for 820 COLOR CHANGER

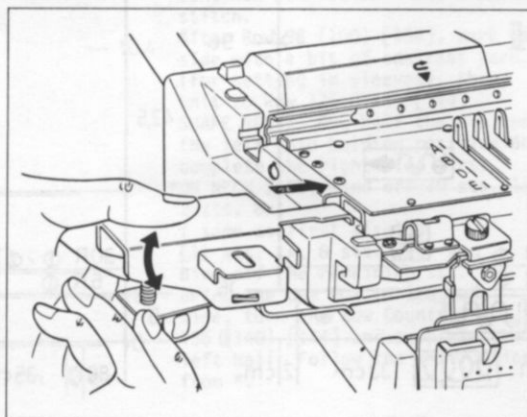

PRICE: \$6.95
Shipping Costs \$1.00

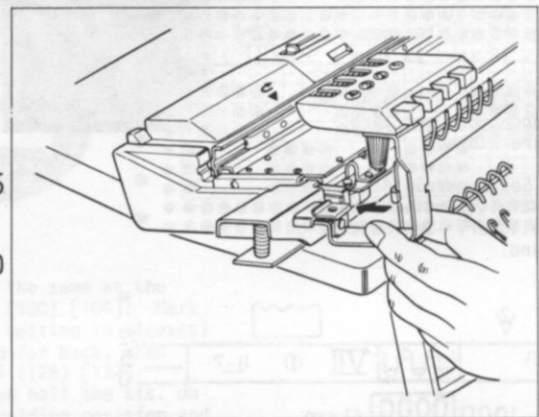

Here's a new Accessory for people who have an 820 or 830 machine with a Ribbing Attachment...

This Adaptor allows you to use the 820 Color Changer (on main machine) without removing the Ribbing Attachment. You just drop the Ribber down, slide the Adaptor into position on the main machine and clip on your Push Button Changer...

KK 668

CHILD'S PULLOVER

SIZES: 6/7 (8) [10]
 YARN: Binia
 GRAMS: 350 400 450
 TENSION: 7 to 8
 GAUGE: 13 sts. 17 rows = 5 cm (2")

Stockinette stitch knitted sideways on the machine. Front and back are exactly the same except for different neck shapings. Begin and end with waste yarn. Sleeves and lower band are K1, P1 Ribbing and the stitches are picked up later. The neck finishing and ties are crochet.

FINISHING: See General Instructions. Work 1 row single crochet and 1 row half double crochet along each side of the neck opening and remove the waste yarn. Work the same crochet around neckline making ties on each side approximately 8" long.

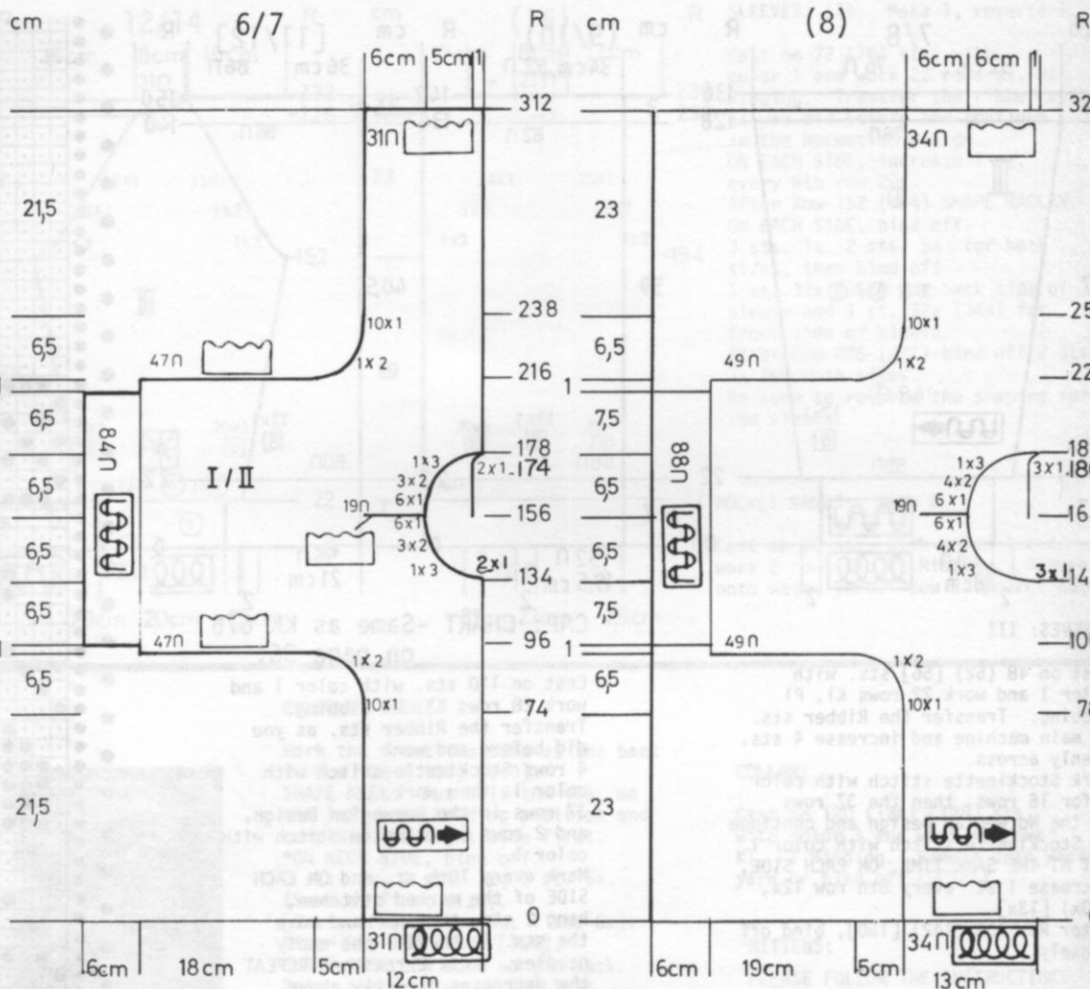

KK 669

CHILD'S PULLOVER & CAP

SIZES: 6 yr. (7 yr.) [8 yr.]
 YARN: Euro Sport
 GRAMS: color 1 300 350 400
 color 2 150 150 150
 TENSION: 8 to 10
 GAUGE: Stock-11 st. 14 rows = 5 cm (2")
 Pat - 12 sts. 15 rows = 5 cm (2")

Stockinette stitch with a Norwegian Design. Punch your own card. The bands are Ribbed.

FINISHING: See General Instructions. Sew neckband with buttonholes to front of pullover. Sew buttons on back neckband.

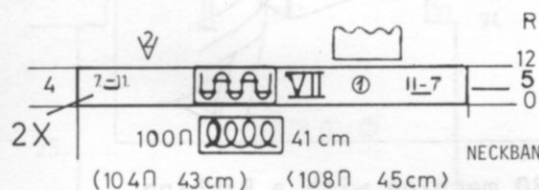
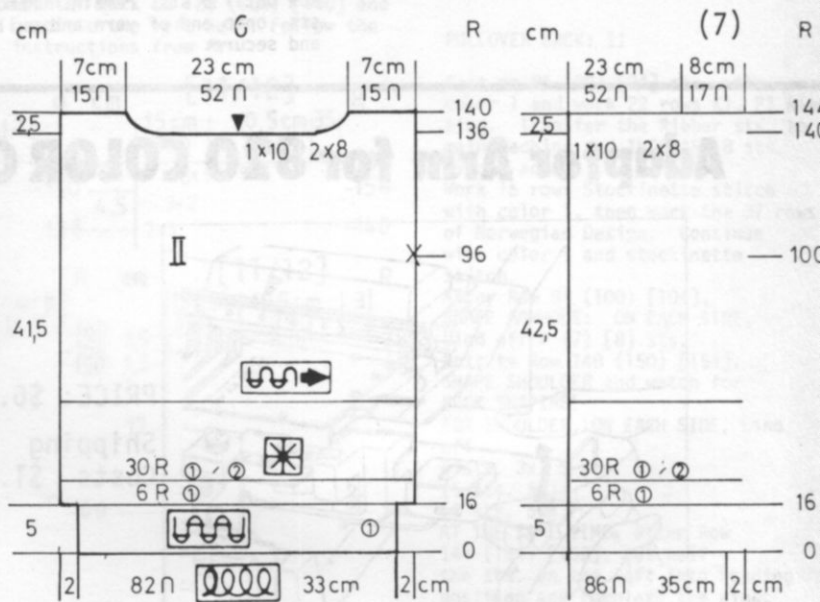

NECKBAND: Make 2 - omit buttonholes in 2nd section.

Cast on 100 (104) [108] sts. with color 1 and work K1, P1 Ribbing. After Row 5, work BUTTONHOLES ON EACH SIDE over needles 7 to 11 counting from the edge. Knit to Row 12 then remove the sts. onto waste yarn.

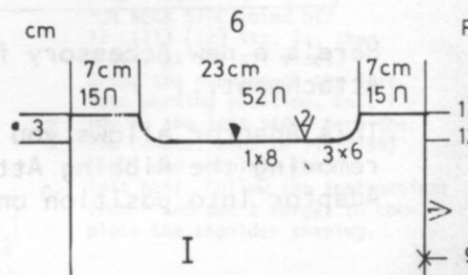

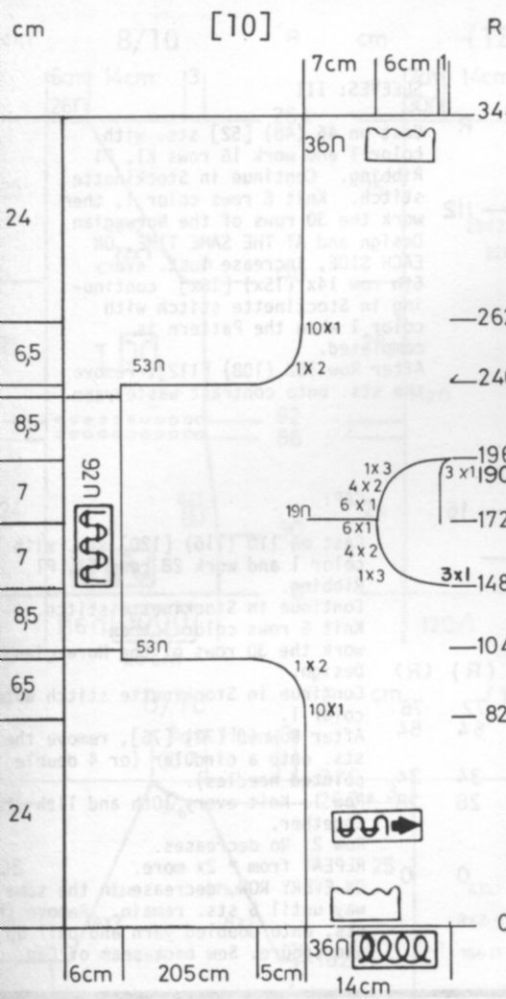

BACK & FRONT: (2 pieces)

Watch for the different shapings at front and back neck. With contrast waste yarn, cast on 31 (34) [36] sts. and work Stockinette stitch. Knit 8 to 10 rows, then change to garment yarn and put Counter at 0. Knit to Row 73 (77) [81].

ON ARM SIDE, increase 1 st. 10x then cast on 2 sts. 1x for all sizes and after Row 95 (99) [103], cast on with waste yarn - 47 (49) [53] sts. Knit to Row 134 (142) [148].

FOR THE BACK NECK SHAPING - Bind off 1 st. 2x (3x) [3x] then knit to Row 174 (180) [190] and cast on 1 st. 2x (3x) [3x].

FOR THE FRONT NECK SHAPING - Bind off 3 sts. 1x, 2 sts. 3x, 1 st. 6x. (3 sts. 1x, 2 sts. 4x, 1 st. 6x). [3 sts. 1x, 2 sts. 4x, 1 st. 6x]. After Row 156 (164) [172], hand knit 2 rows over 19 sts. on the right using waste yarn then continue shaping neck. Cast on 1 st. 6x, 2 sts. 3x, 3 sts. 1x. (1 st. 6x, 2 sts. 4x, 3 sts. 1x). [1 st. 6x, 2 sts. 4x, 3 sts. 1x] After Row 215 (227) [239], remove 47 (49) [53] sts. onto contrast waste yarn. then on arm side, bind off 2 sts. 1x, 1 st. 10x for all sizes.

Knit to Row 312 (328) [344] and remove the remaining sts. onto contrast waste yarn.

WAISTBANDS:

Pick up 84 sts. along lower edge of one section and work 24 rows K1, P1 Ribbing then bind off the crochet method for Ribbing. Repeat for 2nd section.

SLEEVE BANDS:

Sew shoulder seams first then hang the open sts. of sleeve onto machine and work 24 rows K1, P1 Ribbing. Bind off the crochet method for Ribbing.

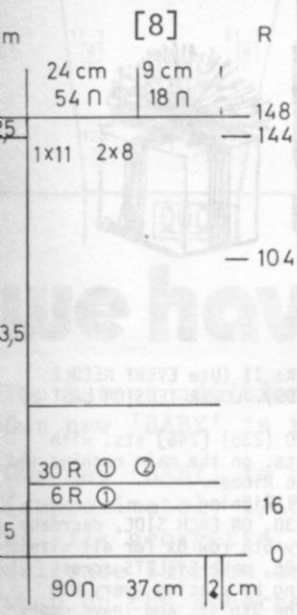
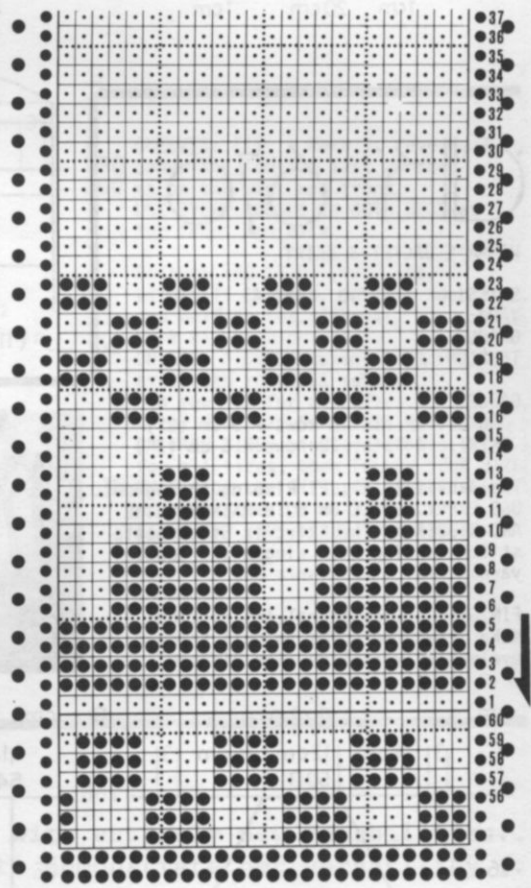

BACK: II

Cast on 82 (86) [90] sts. with color 1 and work 16 rows K1, P1 Ribbing. Transfer the Ribber sts. to main machine and work 6 rows Stockinette stitch with color 1 then work the 30 rows of the Norwegian Design. Continue with color 1 and Stockinette stitch.

After Row 96 (100) [104], mark each side with a bit of contrast yarn (for setting in sleeves). then knit to Row 136 (140) [144].

SHAPE NECK: Put half the sts. on the left into holding position and complete the right side first.

*ON NECK SIDE, bind off 10 sts. 1x, 2 sts. 8x. (same as first size). [11 sts. 1x, 8 sts. 2x]. Bind off the remaining sts. Bring the Cam Box to the left side, turn the Row Counter back to 136 (140) [144] and complete the left half. Follow the instructions from *.



FRONT: I

Work the front the same as the back to Row 96 (100) [104]. Mark each side (for setting in sleeves) same as you did for back, then knit to Row 124 (128) [132].

SHAPE NECK: Put half the sts. on the left into holding position and complete the right side first.

*ON NECK SIDE, bind off 8 sts. 1x, 6 sts. 3x. (same as first size). [9 sts. 1x, 6 sts. 3x]. After Row 132 (136) [140], bind off the remaining sts. Bring the Cam Box to the left side, turn the Row Counter back to 124 (128) [132] and complete the left half. Follow the instructions from *.

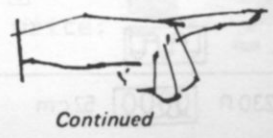
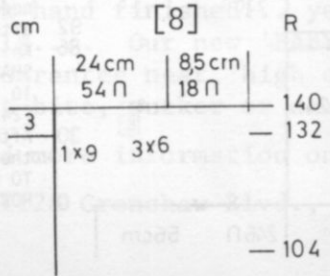
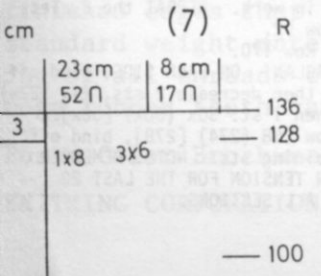

KK 669

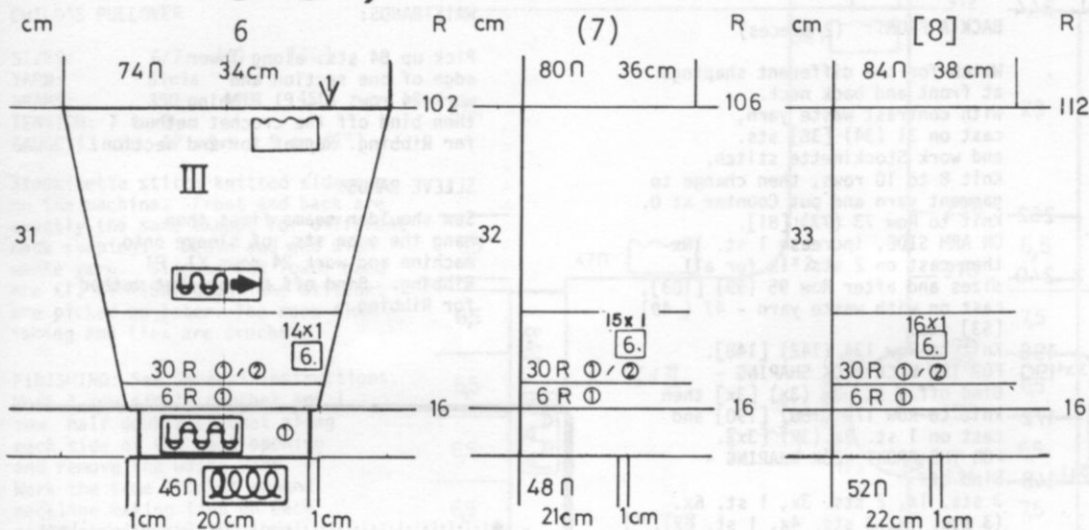

SLEEVES: III

Cast on 46 (48) [52] sts. with color 1 and work 16 rows K1, P1 Ribbing. Continue in Stockinette stitch. Knit 6 rows color 1, then work the 30 rows of the Norwegian Design and AT THE SAME TIME, ON EACH SIDE, increase 1 st. every 6th row 14x (15x) [16x] continuing in Stockinette stitch with color 1 when the Pattern is completed. After Row 102 (108) [112], remove the sts. onto contrast waste yarn.

CAP:

Cast on 110 (116) [120] sts. with color 1 and work 28 rows K1, P1 Ribbing. Continue in Stockinette stitch. Knit 6 rows color 1 then work the 30 rows of the Norwegian Design. Continue in Stockinette stitch with color 1. After Row 68 (72) [76], remove the sts. onto a circular (or 4 double pointed needles). *Row 1: Knit every 10th and 11th st together. Row 2: No decreases. REPEAT from * 2x more. ON EVERY ROW, decrease in the same way until 5 sts. remain. Remove sts. onto doubled yarn and pull up and secure. Sew back seam of Cap.

dk 670

WOMAN'S JACKET & SKIRT

SIZES: 8/10 (12/14) [16]
YARN:
GRAMS:
TENSION: 8.1 for JACKET
5.2 for SKIRT

GAUGE:
JACKET: 22 sts. 18 rows = 5 cm (2")
SKIRT: 14 sts. 22 rows = 5 cm (2")

The Jacket is K1, P1 Ribbing throughout. USE EVERY NEEDLE ON BOTH MAIN MACHINE AND RIBBER. The Skirt is Stockinette stitch working with single and double yarn.

FINISHING: See General Instructions. Make 2 twisted cords to pull through eyelets at waistline (See Picture).

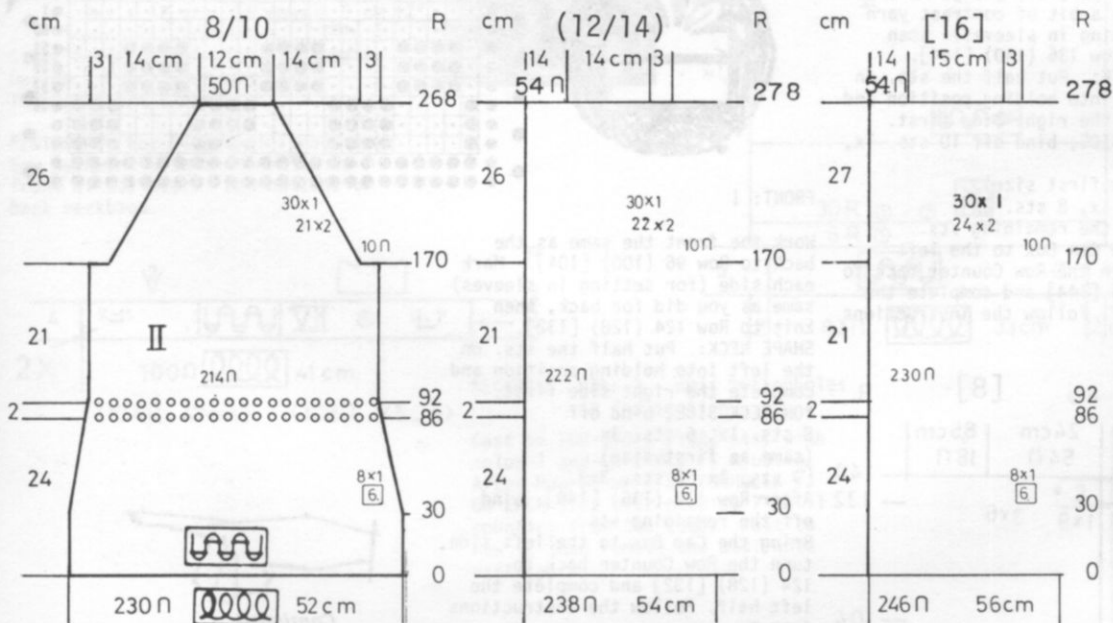
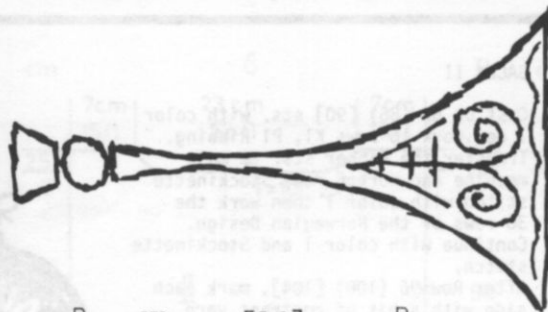
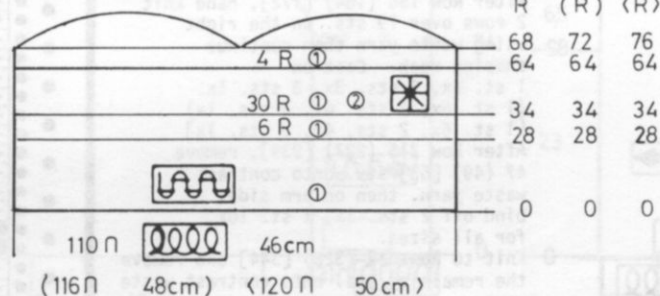

JACKET BACK: II (Use EVERY NEEDLE ON BOTH BEDS). LOWER TENSION LAST 20 ROWS. Cast on 230 (238) [246] sts. with half the sts. on the main machine and half on the Ribber. Work K1, P1 Ribbing. After Row 30, ON EACH SIDE, decrease 1 st. every 6th row 8x for all sizes. After Row 86, make EYELETS across the knitting by placing every 8th st. onto the 9th st. and leave empty needles in work. REPEAT the Eyelets after Row 92. Knit to Row 170. SHAPE RAGLAN: ON EACH SIDE, bind off 10 sts. then decrease 2 sts. 21x (22x) [24x] then 1 st. 30x (30x) [30x]. After Row 268 (274) [278], bind off the remaining sts. NOTE: REMEMBER TO LOWER TENSION FOR THE LAST 20 ROWS ON ALL SECTIONS.

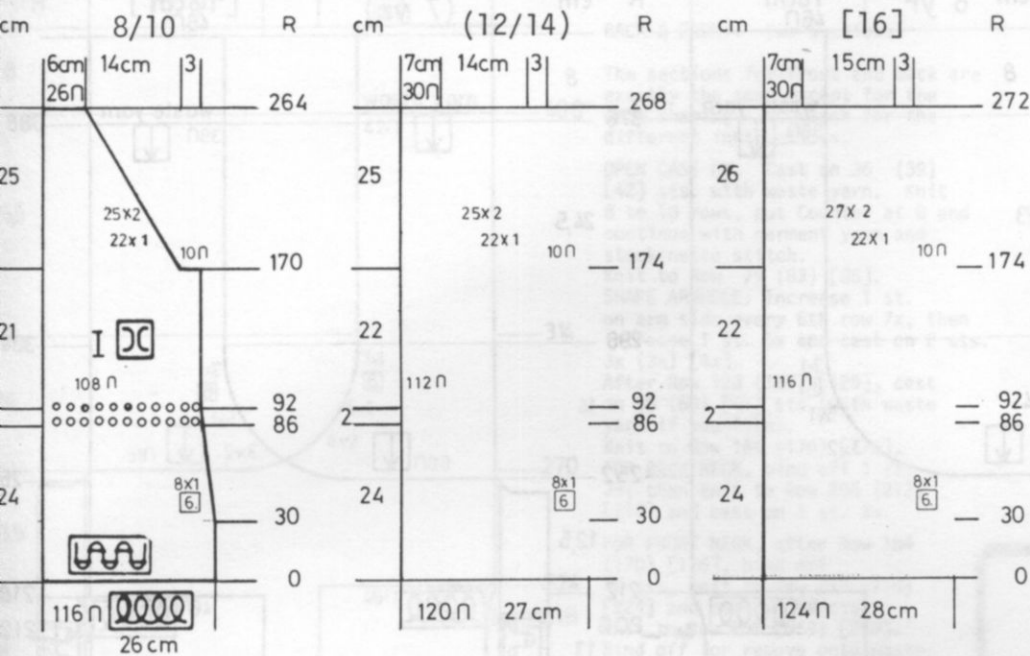

FRONT: I (EVERY NEEDLE BOTH BEDS)
Make 1, reverse 1. BE SURE TO
LOWER TENSION FOR LAST 20 ROWS.

Cast on 116 (120) [124] sts. with
half the sts. on main machine and
half on the Ribber. Work K1, P1
Ribbing.

After Row 30, ON SIDE EDGE, decrease
1 st. every 6th row 8x for all sizes.

After Rows 86 and 92, make Eyelets
same as you did for the back.
Knit to Row 170 (174) [174].

SHAPE RAGLAN: Bind off 10 sts.
then decrease 1 st. every 2nd
row 22x (22x) [22x] then 2 sts.
25x (25x) [27x].

After Row 264 (268) [272], bind
off the remaining sts.

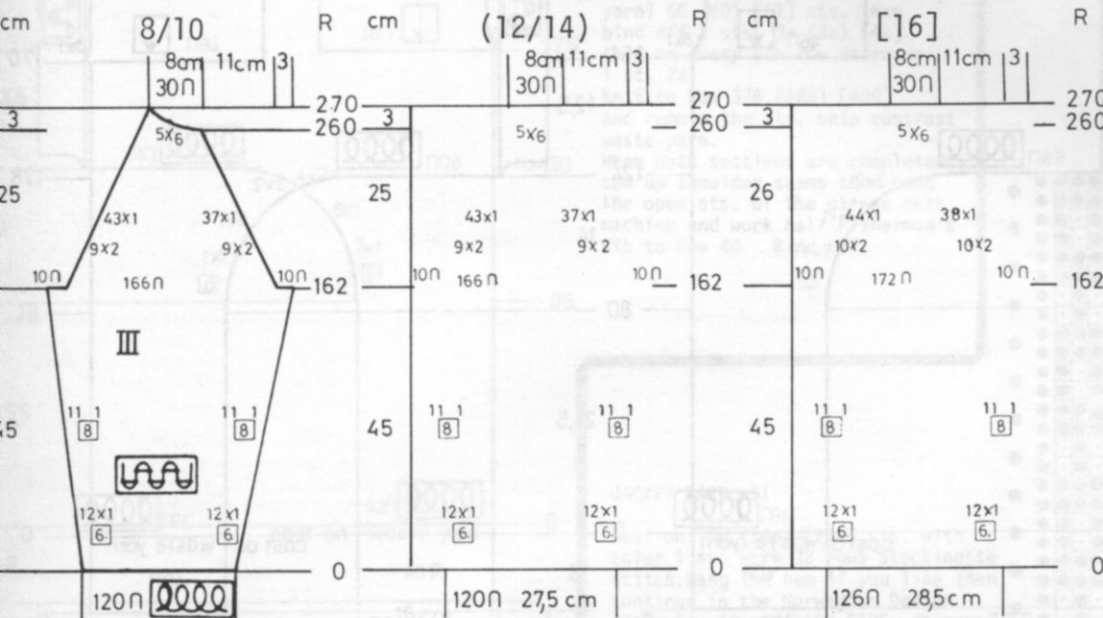

SLEEVES: III - Make 1, reverse 1.
Lower the Tension last 20 rows
as on the back and front.
USE EVERY NEEDLE ON BOTH BEDS as
for front and back.

Cast on 120 (120) [126] sts.
with half the sts. on main machine
and half on the Ribber.

Work K1, P1 Ribbing.

ON EACH SIDE, increase 1 st.

every 6th row 12x, every

8th row 11x for all sizes.

After Row 162, SHAPE RAGLAN:

ON EACH SIDE, bind off 10 sts.
for all sizes, then FOLLOW YOUR SIZE
CHART for the different decreases
on each side.

After Row 260, bind off 6 sts. 5x

for all sizes.

Work the 2nd sleeve with reverse
shaping.

We have a new 'baby'

The latest addition to the remarkable BABY LOCK family... and with entirely new capabilities...
Our new 'BABY' is registered as the EF-405M and she is ready to demonstrate her versatility...

Our new 'BABY' is a three thread overlock that adjusts from a stitch width of 1.5 mm
(approximately 1/16") to 3.5 mm. It is the perfect 'BABY' for sheer material such
as silk georgette, all negligee materials, fine linen... and single layers of
delicate fabrics are a breeze to cut and overlock, making it possible for you to
whip up the sheerest of scarves, placemats, handkerchiefs and ruffles with tiny
finished edges that look hand finished... yet it is able to cope with all
standard weight materials.... Our new 'BABY' automatically balances the feed-
ing of all threads to guarantee neat, high quality stitches... and her feed
dogs rubber teeth cannot bite, pucker or damage delicate materials...

For a Color Brochure and more information on the fantastic new 'BABY', write:

KNITTING CORPORATION - 1128 Crenshaw Blvd., Los Angeles, CA. 90019

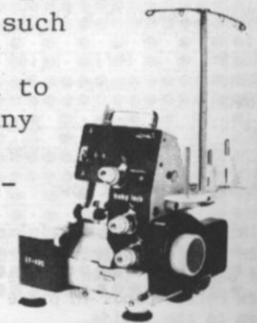

KK 671

CHILD'S PULLOVER

SIZES: 6 yr. (7 yr.) [10 yr.]
 YARN: Crocus
 GRAMS: 300 300 350
 TENSION: 7 to 9
 GAUGE: 13 sts. 17 rows = 5 cm (2")

Stockinette stitch with ribbed bands and collar. The Pullover is knitted sideways on the machine.

FINISHING: See General Instructions.

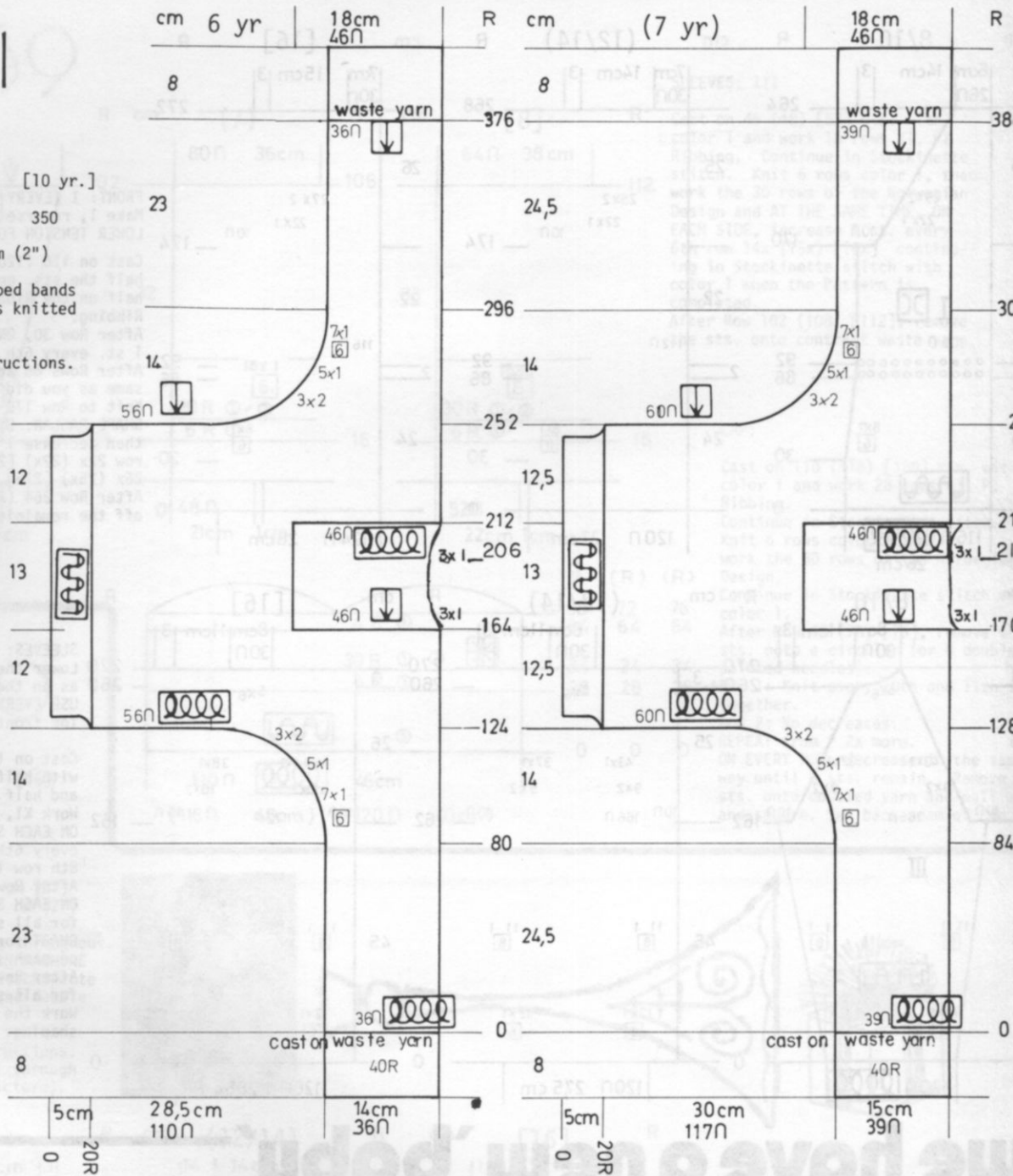

dk 675

WOMAN'S CARDIGAN & SKIRT

SIZES: 10/12 (14) [16]
 YARN: Amore
 GRAMS:
 color 1 600 650 700
 color 2 400 450 450
 TENSION: 5 to 7
 GAUGE: 15 sts. 18 rows = 5 cm (2")

FINISHING: See General Instructions.
 Sew Darts in Skirt and Front sections of Jacket as shown on the Charts.
 Sew Pocket Bands in place and fold & hem to the inside.

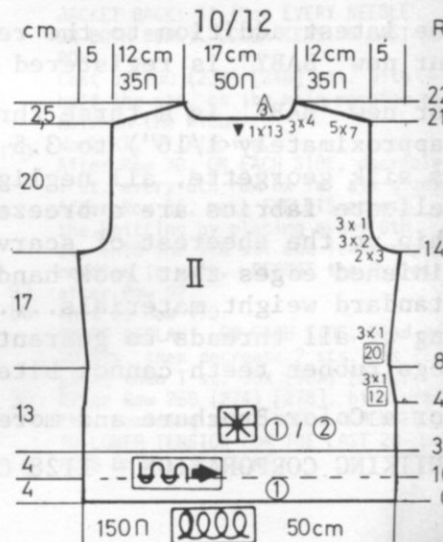

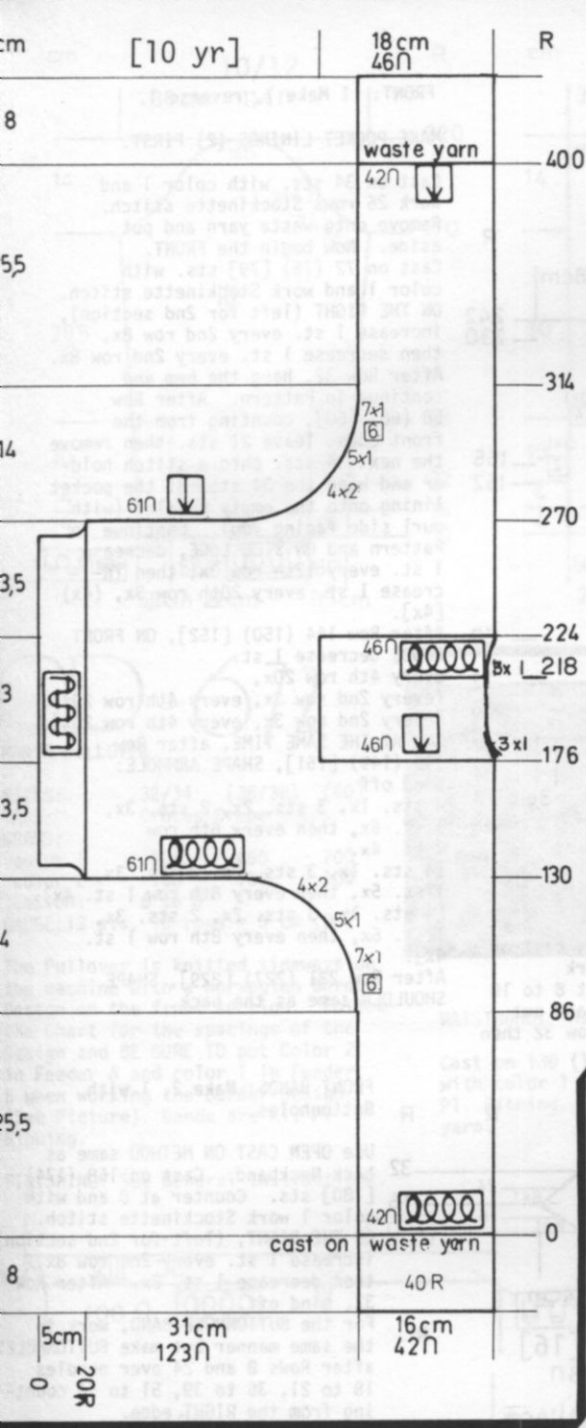

BACK & FRONT: Two sections.

The sections for front and back are exactly the same except for the neck shaping - so watch for the different instructions.

OPEN CAST ON. Cast on 36 (39) [42] sts. with waste yarn. Knit 8 to 10 rows, put Counter at 0 and continue with garment yarn and stockinette stitch.

Knit to Row 79 (83) [85].
SHAPE ARMHOLE: Increase 1 st. on arm side every 6th row 7x, then increase 1 st. 5x and cast on 2 sts. 3x (3x) [4x].

After Row 123 (127) [129], cast on 56 (60) [61] sts. (with waste yarn if you like).

Knit to Row 164 (170) [176].
FOR BACK NECK, bind off 1 st. 3x, then knit to Row 206 (212) [218] and cast on 1 st. 3x.

FOR FRONT NECK, after Row 164 (170) [176], bind off 46 sts. knit to Row 212 (218) [224] and cast on 46 sts.

Knit to Row 251 (259) [269]. Bind off (or remove onto waste yarn) 56 (60) [61] sts. then bind off 2 sts. 3x (3x) [4x] then on every 6th row decrease 1 st. 7x.

Knit to Row 376 (388) [400] and remove the sts. onto contrast waste yarn.

When both sections are completed, sew up shoulder seams then hang the open sts. of the sleeve onto machine and work half Fisherman's Rib to Row 40. Bind off.

COLLAR:

Cast on 166 sts. and work 46 rows K1, P1 Ribbing. Remove onto waste yarn. Lap the collar over in front (8 cm) then sew in place (see picture).

WAISTBAND:

Cast on 194 (198) [199] sts. and work 20 rows K1, P1 Ribbing. Remove onto waste yarn. Sew Band to lower edge.



JACKET BACK: II

Cast on 150 (156) [164] sts. with color 1 and work 32 rows Stockinette stitch. Hang the hem if you like then continue in the Norwegian Design. After Row 40, ON EACH SIDE, decrease 1 st. every 12th row 3x.

After Row 80, ON EACH SIDE, increase 1 st. every 20th row 3x (4x) [4x].

After Row 140 (142) [142], SHAPE ARMHOLE: ON EACH SIDE, bind off 3 sts. 2x, 2 sts. 3x, 1 st. 3x. (3 sts. 2x, 2 sts. 3x, 1 st. 5x). [4 sts. 1x, 3 sts. 1x, 2 sts. 3x, 1 st. 5x].

Knit to Row 212 (214) [214]. Put half the sts. on the left into holding position and complete the right side first.

*SHAPE SHOULDER AND NECK AT THE SAME TIME.

FOR SHOULDER, bind off 7 sts. 5x,

(7 sts. 4x, 9 sts. 1x), [7 sts. 5x, 4 sts. 1x],

FOR NECK, bind off 13 sts. 1x, 4 sts. 3x.

(13 sts. 1x, 4 sts. 3x). [14 sts. 1x, 4 sts. 3x].

Bring the needles on the left into working position, knit 1 row in Pattern to the left side, turn the Row Counter back to 212 (214) [214] and complete the left half. Follow the instructions from *.

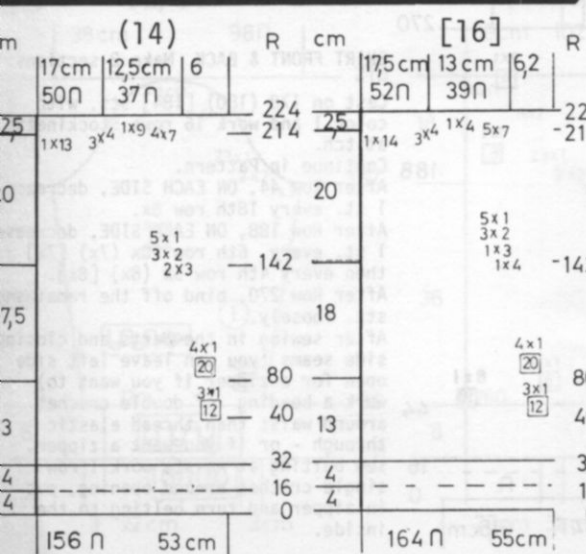
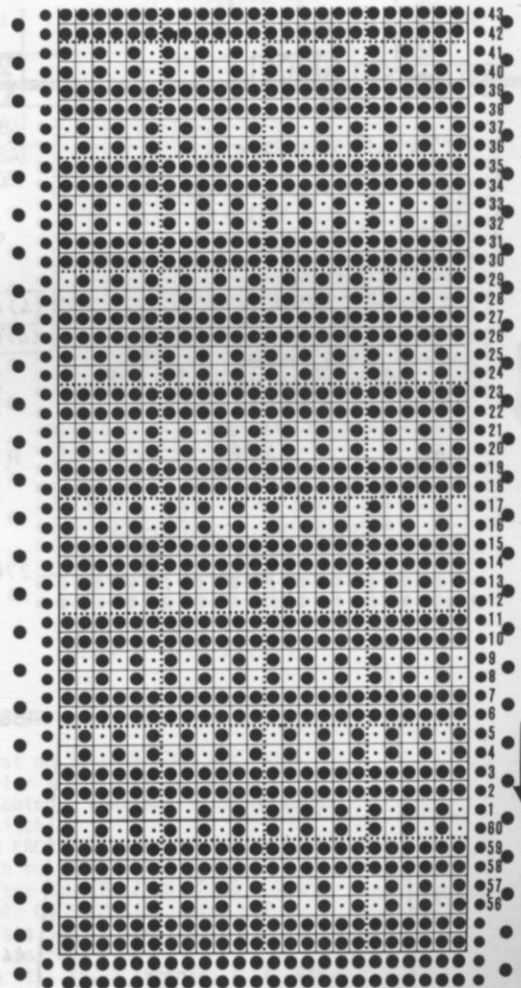

dk 675

POCKET BANDS:

Cast on 34 sts. with color 1 and work Stockinette stitch to Row 32. Remove the sts. onto waste yarn. Fold in half and sew 1 edge to outside and 1 to inside of pocket.

FRONT: I Make 1, reverse 1.

MAKE POCKET LININGS (2) FIRST.

Cast on 34 sts. with color 1 and work 26 rows Stockinette stitch. Remove onto waste yarn and put aside. Now begin the FRONT. Cast on 72 (76) [79] sts. with color 1 and work Stockinette stitch. ON THE RIGHT (left for 2nd section), increase 1 st. every 2nd row 8x, then decrease 1 st. every 2nd row 8x. After Row 32, hang the hem and continue in Pattern. After Row 58 (60) [60], counting from the front edge, leave 21 sts. then remove the next 34 sts. onto a stitch holder and hang the 34 sts. of the pocket lining onto the empty needles (with purl side facing you). Continue in Pattern and ON SIDE EDGE, decrease 1 st. every 12th row 3x, then increase 1 st. every 20th row 3x, (4x) [4x].

After Row 144 (150) [152], ON FRONT EDGE, decrease 1 st. every 4th row 20x, (every 2nd row 3x, every 4th row 20x), [every 2nd row 3x, every 4th row 20x], AND AT THE SAME TIME, after Row 149 (149) [151], SHAPE ARMHOLE: Bind off 4 sts. 1x, 3 sts. 2x, 2 sts. 3x, 1 st. 5x, then every 6th row 1 st. 4x. (4 sts. 1x, 3 sts. 2x, 2 sts. 3x, 1 st. 5x, then every 8th row 1 st. 4x).

After Row 221 (227) [229], SHAPE SHOULDER same as the back.

FRONT BANDS: Make 2, 1 with Buttonholes.

Use OPEN CAST ON METHOD same as back Neckband. Cast on 168 (174) [180] sts. Counter at 0 and with color 1 work Stockinette stitch. ON THE RIGHT, (left for 2nd section) increase 1 st. every 2nd row 8x, then decrease 1 st. 8x. After Row 32, bind off.

For the BUTTONHOLE BAND, work in the same manner but make BUTTONHOLE after Rows 8 and 24 over needles 18 to 21, 36 to 39, 51 to 54 counting from the RIGHT edge.

SKIRT FRONT & BACK Make 2 sections

Cast on 178 (180) [184] sts. with color 1 and work 16 rows Stockinette stitch.

Continue in Pattern. After Row 44, ON EACH SIDE, decrease 1 st. every 18th row 8x. After Row 188, ON EACH SIDE, decrease 1 st. every 6th row 10x (7x) [7x] then every 4th row 5x (8x) [8x]. After Row 270, bind off the remaining sts. loosely.

After sewing in the darts and closing side seams (you can leave left side open for a zipper if you want to) work a beading of double crochet around waist then thread elastic through - or if you want a zipper, sew belting at waist, work 1 row single crochet around opening, put in zipper and turn belting to the inside.

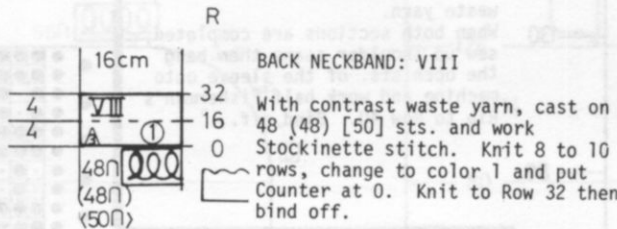
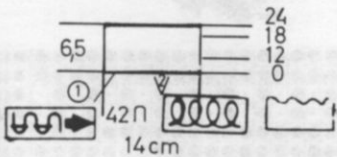
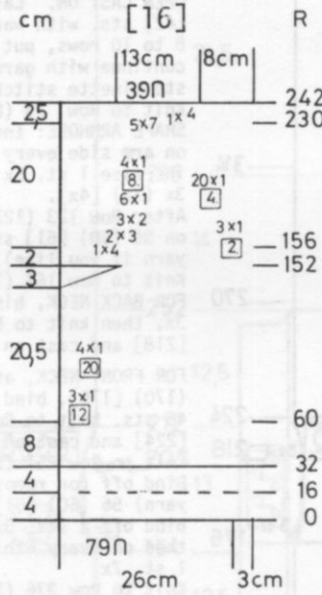
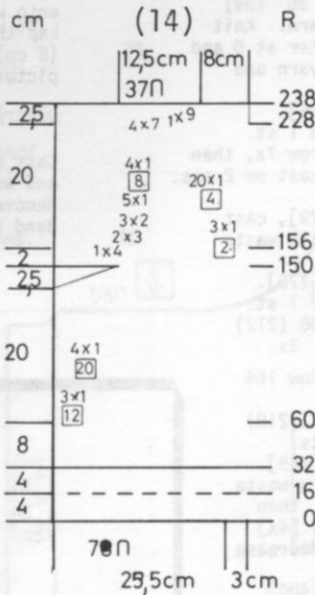
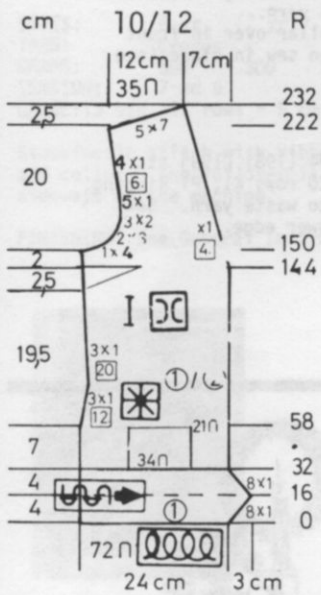

SLEEVE SLIT BAND: Make 2.

Open Cast on with waste yarn. Cast on 42 sts. Knit 8 to 10 rows, change to color 1 and put counter at 0. Knit Stockinette stitch to Row 24, then bind off. Sew this band to inner edge of sleeve slit, fold in half and sew to the inside. Turn band over the other side of sleeve and sew on buttons (see Picture).

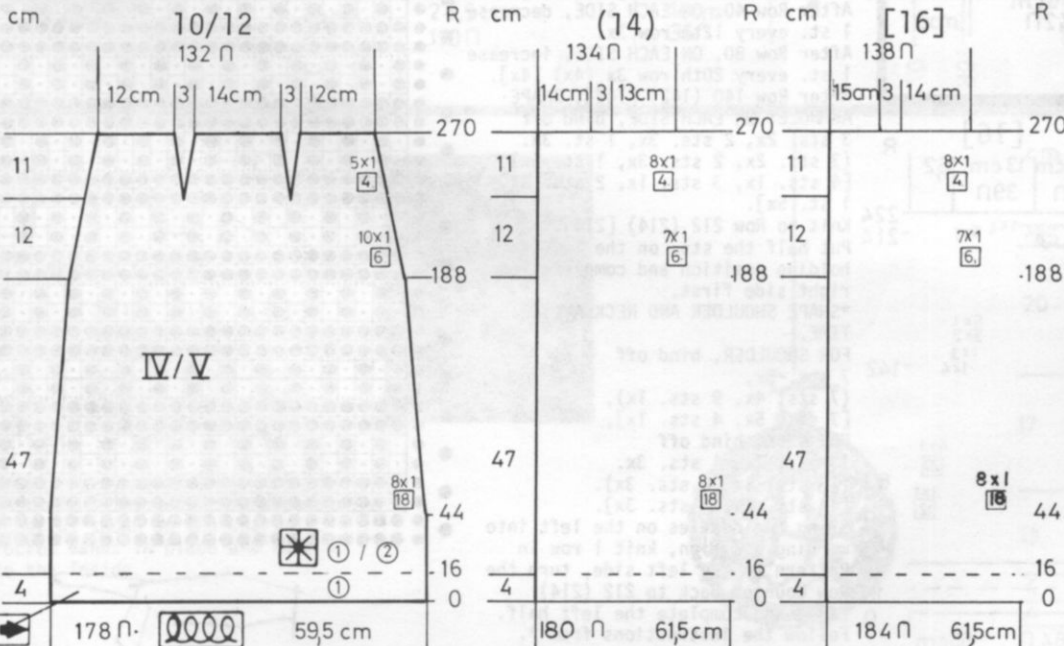
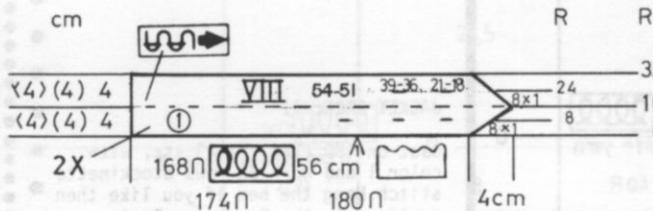

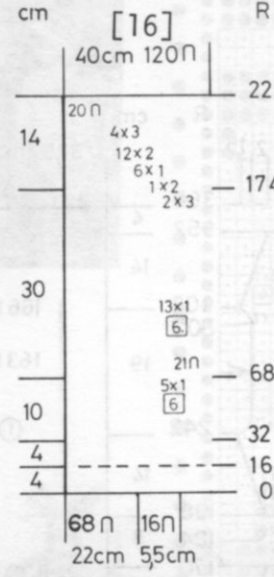
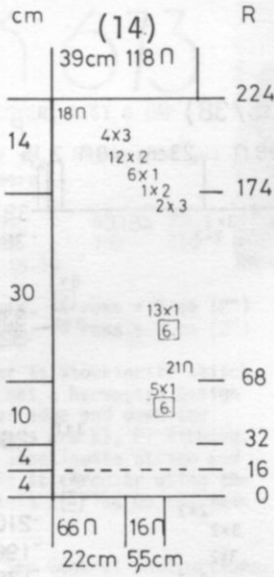
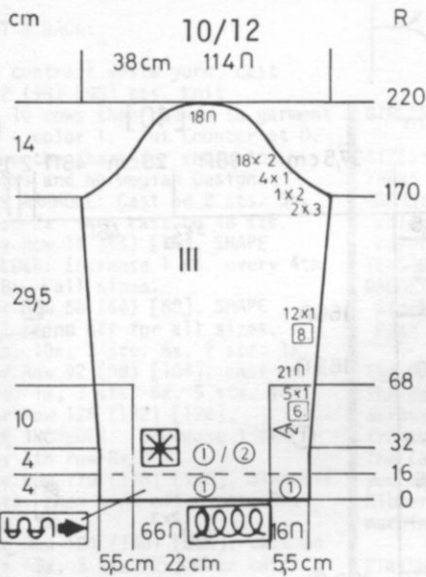

SLEEVES: III - Make 1, reverse 1.

To the right of 0, cast on 16 sts. with color 1 and work Stockinette stitch.

After Row 32, hang the hem and continue in Pattern. ON THE RIGHT, increase 1 st. every 6th row 5x. After Row 68, remove these sts. onto a stitch holder and put aside.

To the left of 0, cast on 66 (66) [68] sts. with color 1 and work Stockinette stitch.

After Row 32, hang the hem then continue in Pattern.

ON THE LEFT, increase 1 st. every 6th row 5x.

After Row 68, hang the sts. from the stitch holder onto the machine on the right of 0.

ON EACH SIDE, increase 1 st. every 8th row 11x. (every 6th row 13x). [every 6th row 13x].

After Row 170 (174) [174], SHAPE CAP: ON EACH SIDE, bind off 3 sts. 2x, 2 sts. 1x, 1 st. 4x, 2 sts. 18x. (3 sts. 2x, 2 sts. 1x, 1 st. 6x, 2 sts. 12x, 3 sts. 4x). [3 sts. 2x, 2 sts. 1x, 1 st. 6x, 2 sts. 12x, 3 sts. 4x].

After Row 220 (224) [224], bind off the remaining stitches.

Work the 2nd sleeve with reverse shaping, casting on the 16 sts. to the LEFT of 0 with the 66 (66) [68] sts. to the RIGHT of 0 and reading right for left etc. etc.

672

MAN'S PULLOVER

SIZES: 32/34 (36/38) (40)
 YARN: Crocus Crepe
 GRAMS: color 1 600 650 700
 color 2 100 100 100
 TENSION: 6 to 8
 GAUGE: 13 sts. 18 rows = 5 cm (2")



The Pullover is knitted sideways on the machine with a Norwegian Border Design on the front section. Follow the Chart for the spacings of the Design and BE SURE TO put Color 2 in Feeder A and color 1 in Feeder B when working the Border Design (See Picture). Bands are K1, P1 Ribbing.

WAISTBAND: Make 2.

Cast on 130 (136) [142] sts. with color 1 and work 28 rows K1, P1 Ribbing. Remove onto waste yarn.

NECKBAND: Make 1, reverse 1.

Cast on 100 sts. with color 1 and work K1, P1 Ribbing. ON THE LEFT, increase 2 sts. every 2nd row 4x. After Row 10, remove the sts. onto contrast waste yarn. Work the 2nd section with the increases on the RIGHT.

FINISHING: See General Instructions.

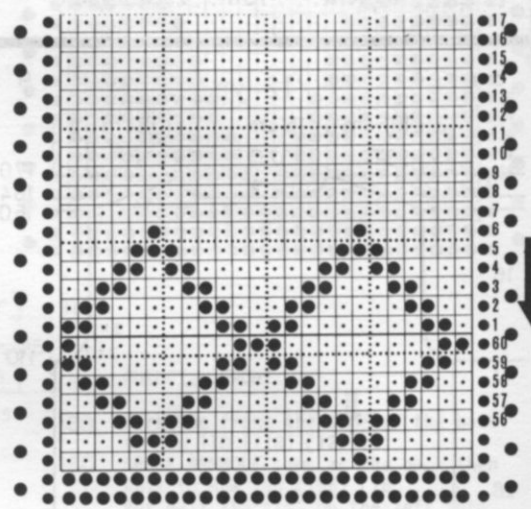
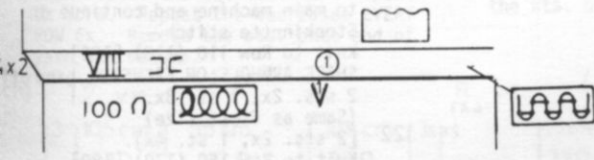

COLOR 2 in A FEEDER
 COLOR 1 in B FEEDER

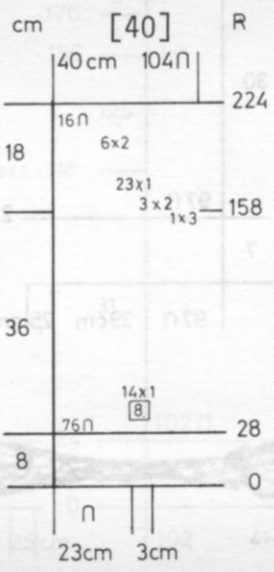
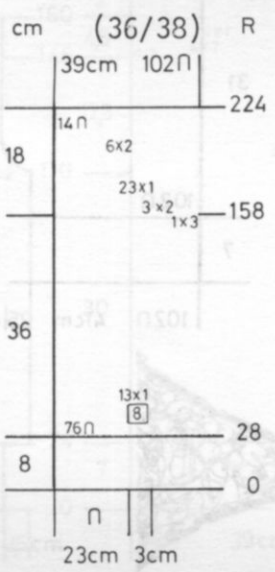
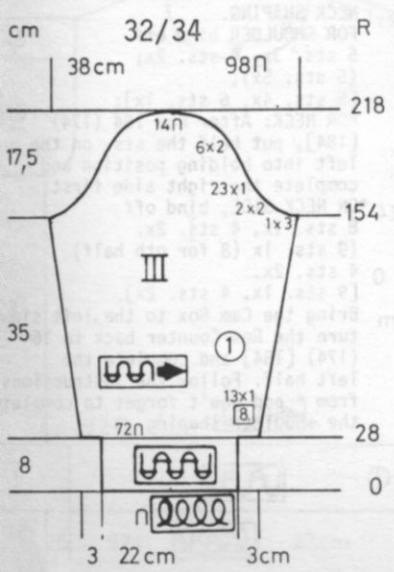

SLEEVES: III Make 2

Cast on 72 (76) [76] sts. with color 1 and work 28 rows K1, P1 Ribbing. Continue in Stockinette stitch.

ON EACH SIDE, increase 1 st. every 8th row 13x, (13x) [14x].

After Row 154 (158) [158] SHAPE CAP: ON EACH SIDE, bind off 3 sts. 1x, 2 sts. 2x, 1 st. 23x, 2 sts. 6x. (3 sts. 1x, 2 sts. 3x, 1 st. 23x, 2 sts. 6x).

[Same as 2nd size].

After Row 218 (224) [224], bind off the remaining sts.

hp 672

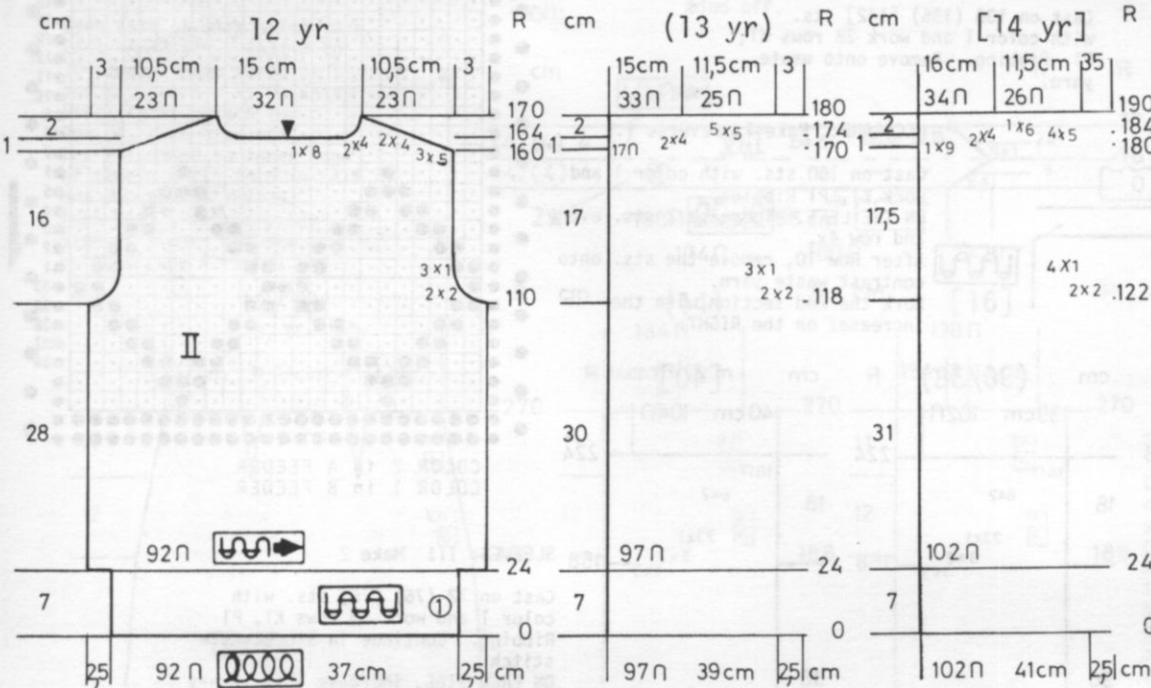
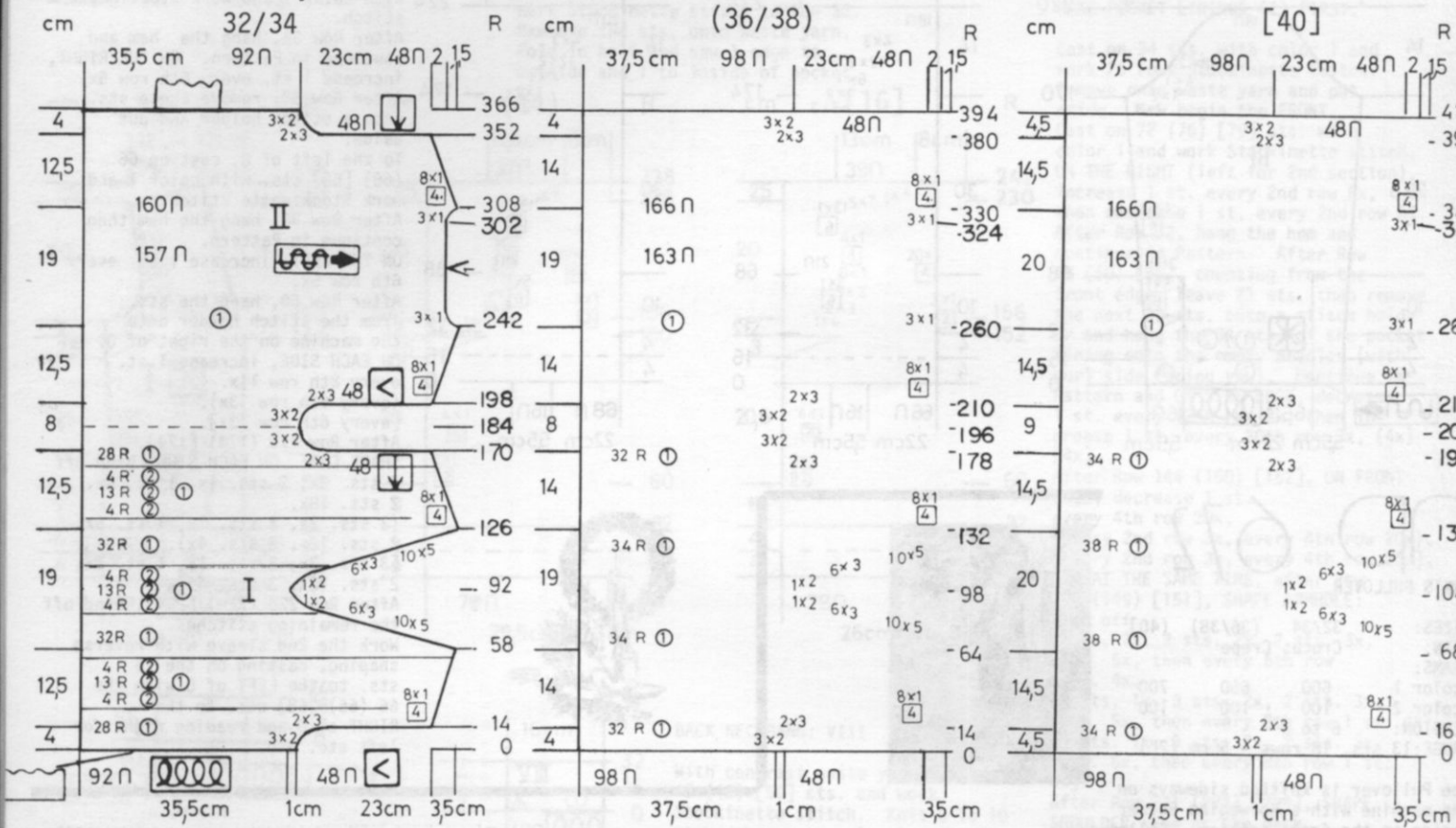

PULLOVER BACK: II

Cast on 92 (97) [102] sts. with color 1 and work 24 rows K1, P1 Ribbing. Transfer the ribber sts to main machine and continue in Stockinette stitch.
 Knit to Row 110 (118) [122].
 SHAPE ARMHOLE: ON EACH SIDE, bind off 2 sts. 2x, 1 st. 3x. (Same as first size) [2 sts. 2x, 1 st. 4x].
 Knit to Row 160 (170) [180].
 SHAPE SHOULDER and WATCH FOR NECK SHAPING.
 FOR SHOULDER bind off 5 sts. 3x, 4 sts. 2x; (5 sts. 5x); [5 sts. 4x, 6 sts. 1x];
 FOR NECK: After Row 164 (174) [184], put half the sts. on the left into holding position and complete the right side first.
 *ON NECK SIDE, bind off 8 sts. 1x, 4 sts. 2x. (9 sts. 1x (8 for oth half) 4 sts. 2x. [9 sts. 1x, 4 sts. 2x].
 Bring the Cam Box to the left side turn the Row Counter back to 164 (174) [184] and complete the left half. Follow the instruction from * and don't forget to complete the shoulder shaping.

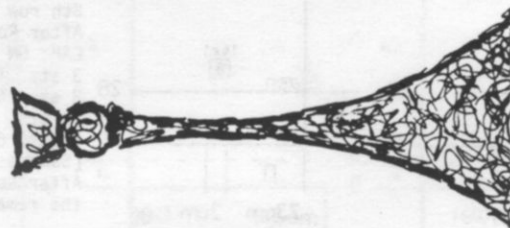

FRONT & BACK:

With contrast waste yarn, cast on 92 (98) [98] sts. Knit to 10 rows then change to garment yarn - color 1. Put Counter at 0. Follow the Chart for the color changes and Norwegian Design. SHAPE ARMHOLE: Cast on 2 sts. 3x, 3 sts. 2x then cast on 48 sts. After Row 14 (14) [16], SHAPE SHOULDER: Increase 1 st. every 4th row 8x - all sizes. After Row 58 (64) [68], SHAPE NECK: Bind off for all sizes, 5 sts. 10x, 3 sts. 6x, 2 sts. 1x. After Row 92 (98) [104], cast on 2 sts. 1x, 3 sts. 6x, 5 sts. 10x. After Row 126 (132) [138], SHAPE SHOULDER: Decrease 1 st. every 4th row 8x. After Row 170 (178) [190], bind off 18 sts. then bind off 3 sts. 2x, 2 sts. 3x. After Row 184 (196) [206], cast on 2 sts. 3x, 3 sts. 2x, then cast on 48 sts. After Row 198 (210) [264], SHAPE SHOULDER: Increase 1 st. every 4th row 8x. After Row 242 (260) [264] SHAPE NECK: Bind off 1 st. 3x, and after Row 302 (324) [340], cast on 1 st. 3x. After Row 308 (330) [346], SHAPE SHOULDER, decrease 1 st. every 4th row 8x. After Row 352 (380) [398], SHAPE ARMHOLE: Bind off 48 sts. then bind off 3 sts. 2x, 2 sts. 3x. After Row 366 (394) [414], remove the remaining sts. onto contrast waste yarn.

KK 673



GIRL'S PULLOVER, VEST & CAP

SIZES: 12 yr. (13 yr)[14 yr]
 YARN: Amore
 GRAMS: color 1 500 650 700
 color 2 100 100 150
 TENSION: 9 to 10
 GAUGE: Stock: 11 sts. 15 rows = 5 cm (2")
 Pat: 13 sts. 14 rows = 5 cm (2")

The Pullover is Stockinette stitch. The Bolero has a Norwegian Design across lower edge and down the fronts. Bands are K1, P1 Ribbing. The Cap is Stockinette stitch and you may knit it circular using the Ribber or knit it flat on the main machine.

FINISHING: See General Instructions. VEST: Weave shoulder and side seams then work 1 row single crochet and 1 row reverse single crochet around edge. CAP: Sew up back seam if you knitted it flat and roll lower edge to the outside.

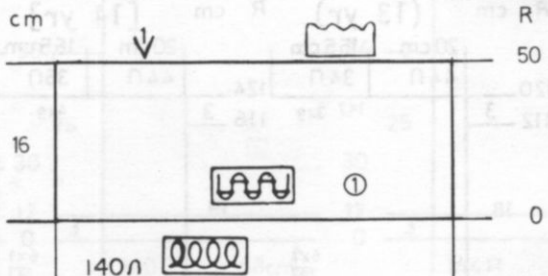

COLLAR:

Cast on 140 sts. with color 1 and work 50 rows K1, P1 Ribbing. Remove the sts. onto contrast waste yarn.

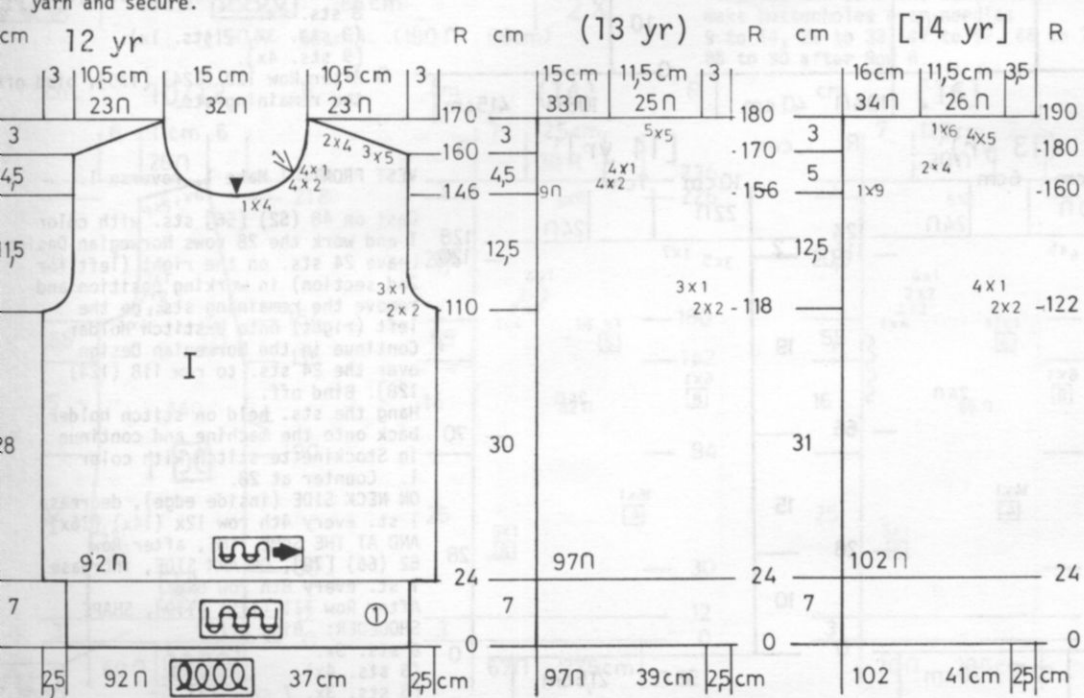
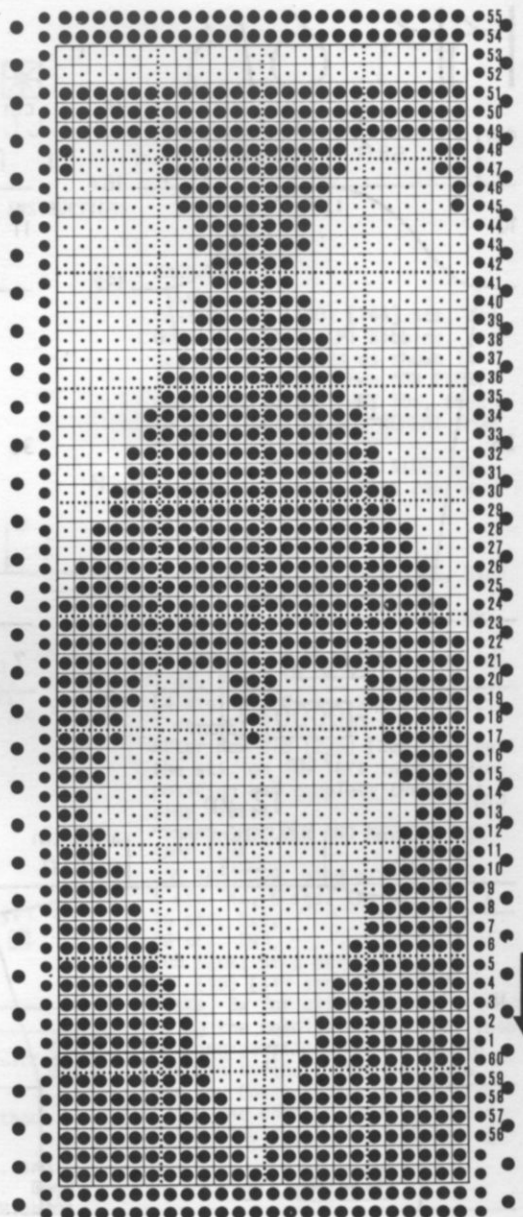

PULLOVER FRONT: I

Work the front the same as the back to Row 110 (118) [122]. SHAPE ARMHOLE same as the back then knit to Row 146 (156) [160]. Put half the sts. on the left into holding position and complete the right side first. *ON NECK SIDE, bind off 4 sts. 1x, 2 sts. 4x, 1 st. 4x. (9 sts. 1x (8 for 2nd half) 2 sts. 4x, 1 st. 4x). [9 sts. 1x, 4 sts. 2x]. After Row 160 (170) [180], SHAPE SHOULDER same as the back. Bring the Cam Box to the left side, turn the Row Counter back to 146 (156) [160] and complete the left half. Follow the instructions from *.



Continued

KK 673

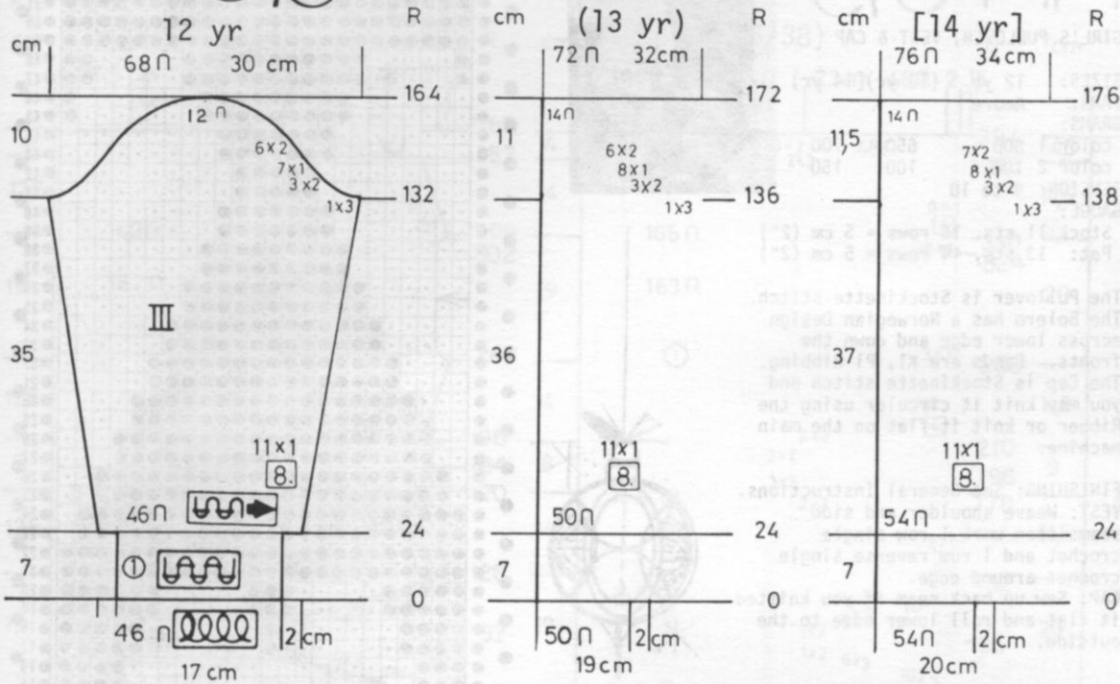

SLEEVES: III

Cast on 46 (50) [54] sts. with color 1 and work 24 rows K1, P1 Ribbing. Continue in Stockinette stitch.
 ON EACH SIDE, increase 1 st. every 8th row 11x for all sizes.
 After Row 132 (136) [138], SHAPE CAP: ON EACH SIDE, bind off 3 sts. 1x, 2 sts. 3x, 1 st. 7x, 2 sts. 6x.
 (3 sts. 1x, 2 sts. 3x, 1 st. 8x, 2 sts. 6x).
 [3 sts. 1x, 2 sts. 3x, 1 st. 8x, 2 sts. 7x].
 After Row 164 (172) [176], bind off the remaining sts.

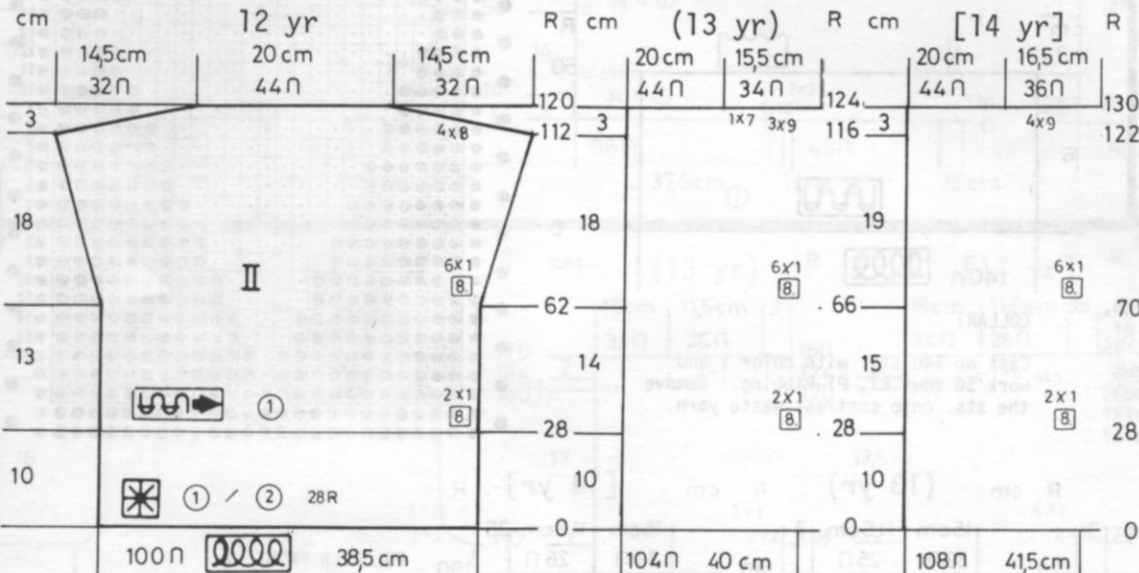

VEST BACK II

Cast on 100 (104) [108] sts. with color 1 and work 28 rows Norwegian Design. Continue in Stockinette stitch.
 ON EACH SIDE, decrease 1 st. every 8th row 2x.
 After Row 62 (66) [70], ON EACH SIDE, increase 1 st. every 8th row 6x.
 After Row 112 (116) [122], SHAPE SHOULDER: ON EACH SIDE, bind off 8 sts. 4x. (9 sts. 3x, 7 sts. 1x). [9 sts. 4x].
 After Row 120 (124) [130], bind off the remaining sts.

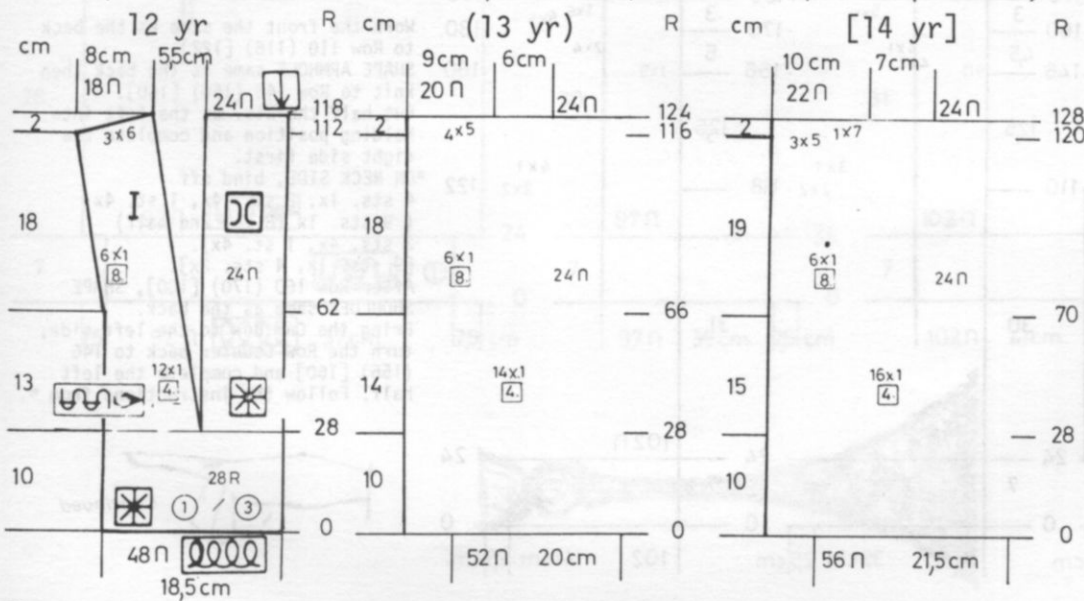

VEST FRONT: I Make 1, reverse 1.

Cast on 48 (52) [56] sts. with color 1 and work the 28 rows Norwegian Design. Leave 24 sts. on the right (left for 2nd section) in working position and remove the remaining sts. on the left (right) onto a stitch holder. Continue in the Norwegian Design over the 24 sts. to row 118 (124) [128]. Bind off.
 Hang the sts. held on stitch holder back onto the machine and continue in Stockinette stitch with color 1. Counter at 28.
 ON NECK SIDE (inside edge), decrease 1 st. every 4th row 12x (14x) [16x] AND AT THE SAME TIME, after Row 62 (66) [70], ON ARM SIDE, increase 1 st. every 8th row 6x.
 After Row 111 (115) [119], SHAPE SHOULDER: Bind off 6 sts. 3x. (5 sts. 4x). [5 sts. 3x, 7 sts. 1x].

DK 674

WOMAN'S JACKET

SIZES: 10/12 (14) [16]
 YARN: Crocus Crepe
 QUANTITIES: 750 800 800
 LENGTH: 10
 GAUGE: 12 sts. 16 rows = 5 cm (2")

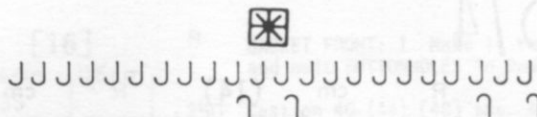

BE SURE TO READ PRINTED INSTRUCTIONS

The purl side of this Rib Pattern is the right side. You will need your Ribber and the design is made by Racking 10 sts. over and back. Bands are K1, P1 Ribbing.

FINISHING: See General Instructions.

BACK: II

Cast on 126 (140) [144] sts. and work 12 rows K1, P1 Ribbing. Set up the needles as shown in the Line Drawing then *ON EVERY ROW, rack to the left 10x, then to the right 10x and REPEAT from *.

After Row 30, ON EACH SIDE, decrease 1 st. every 10th row 4x. (every 8th row 5x). [every 8th row 5x].

After Row 154 (160) [160], SHAPE ARMHOLE: ON EACH SIDE, bind off

4 sts. 1x, 3 sts. 1x, 2 sts. 2x, 1 st. 3x. (4 sts. 1x, 3 sts. 2x, 2 sts. 2x, 1 st. 2x).

[4 sts. 3x, 3 sts. 2x, 2 sts. 2x, 1 st. 3x].

After Row 218 (226) [226] Put half the sts. on the left into holding position and complete the right side first.

*SHAPE SHOULDER AND NECK AT THE SAME TIME.

FOR SHOULDER, bind off

5 sts. 4x, 6 sts. 1x,

(6 sts. 5x),

[6 sts. 5x],

FOR NECK: Bind off

10 (10) [11] sts. 1x,

3 sts. 3x for all sizes.

Bring the needles on the left into working position, knit 1 row in Pattern to the left side, turn the Row Counter back to 218 (226) [226] and complete the left half. Follow the instructions from *.

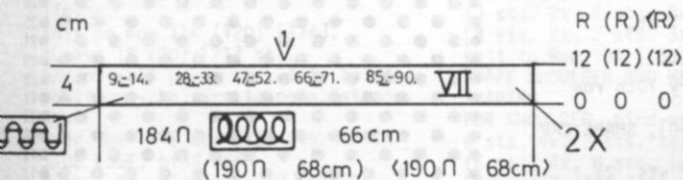
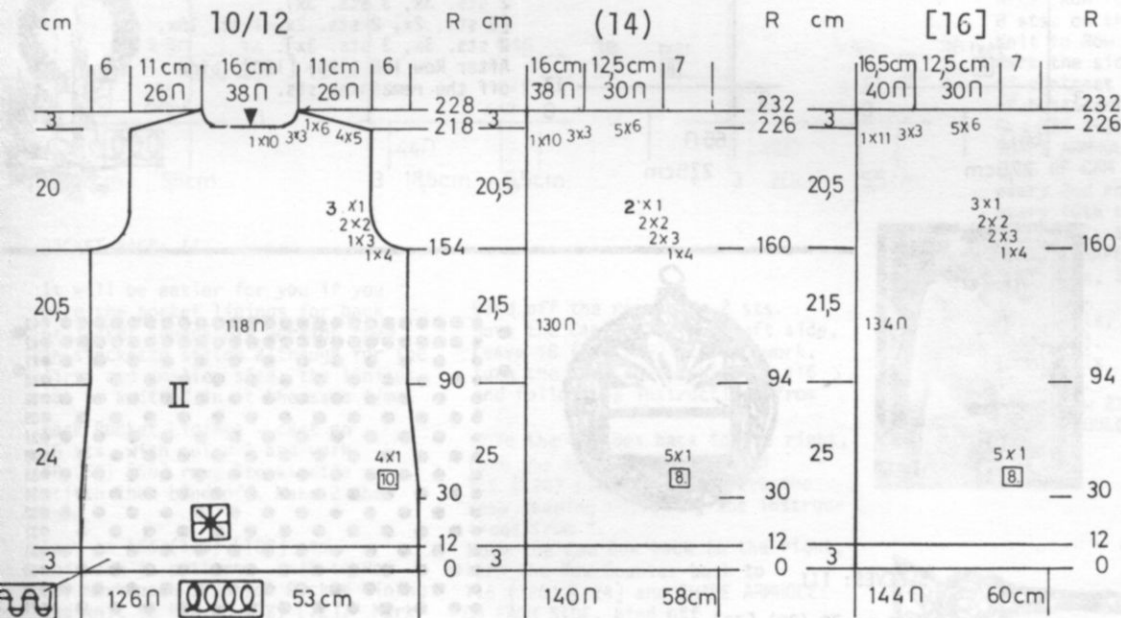

FRONT BANDS: Make 2 - 1 without buttonholes.

Cast on 184 (190) [190] sts. and work 12 rows K1, P1 Ribbing. Bind off the crochet method for Ribbing. Work the 2nd band the same except make buttonholes over needles 9 to 14, 28 to 33, 47 to 52, 66 to 71, 85 to 90 after Row 6.

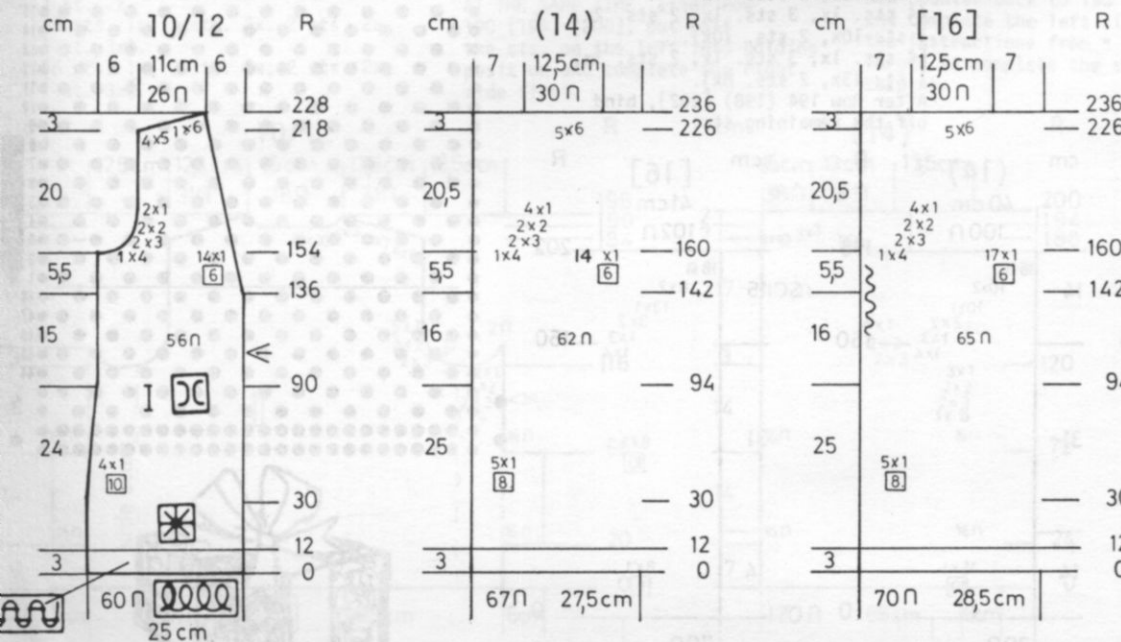

FRONT: I Make 1, reverse 1.

Cast on 60 (67) [70] sts. and work 12 rows K1, P1 Ribbing.

Set up the Pattern in the same way as you did for the back then continue in Pattern.

After Row 30, ON SIDE EDGE, decrease 1 st.

every 10th row 4x.

(Every 8th row 5x).

[every 8th row 5x].

After Row 136 (142) [142],

SHAPE NECK: Decrease 1 st.

every 6th row 14x (14x) [17x],

BUT AT THE SAME TIME, after

Row 153 (159) [159], SHAPE ARMHOLE:

Bind off

4 sts. 1x, 3 sts. 2x, 2 sts. 2x,

1 st. 2x.

(4 sts. 1x, 3 sts. 2x, 2 sts. 2x,

1 st. 4x).

[4 sts. 1x, 3 sts. 2x, 2 sts. 2x,

1 st. 4x].

12 After Row 217 (225) [225], SHAPE

SHOULDER same as the back.

Continued



dk 674

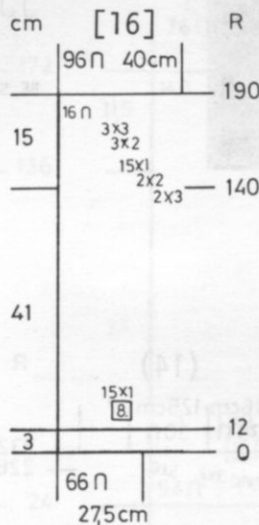
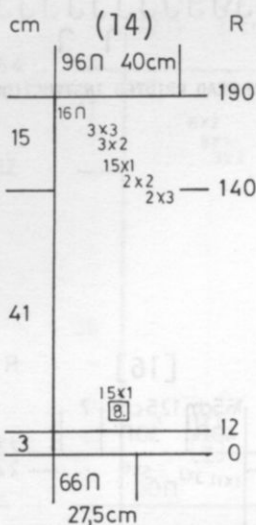
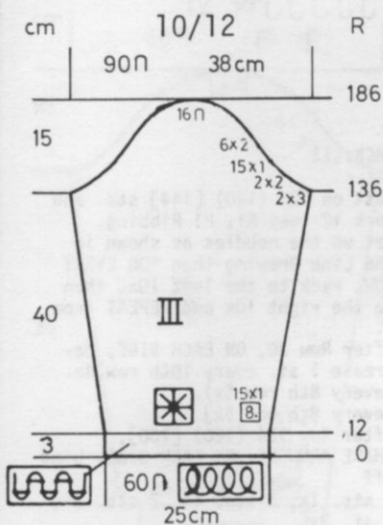

SLEEVES: III

Cast on 60 (66) [66] sts. and work 12 rows K1, P1 Ribbing. Set up the pattern same as for back and front and continue in Pattern.
ON EACH SIDE, increase 1 st. every 8th row 15x for all sizes. After Row 136 (140) [14], SHAPE CAP: ON EACH SIDE, bind off 3 sts. 2x, 2 sts. 2x, 1 st. 15x, 2 sts. 6x. (3 sts. 2x, 2 sts. 2x, 1 st. 15x, 2 sts. 3x, 3 sts. 3x). [3 sts. 2x, 2 sts. 2x, 1 st. 15x, 2 sts. 3x, 3 sts. 3x]. After Row 186 (190) [190], bind off the remaining sts.



dk 676

WOMAN'S SUIT

SIZES: 10/12 (14) [16]
YARN: Color 1 - Crocus Crepe
Color 2 - Beatrice Silver

GRAMS:
color 1 700 750 800
color 2 300 350 400

TENSION:

Stock: 6 to 7
Pat: 9.1

GAUGE: 12 1/2 sts. 17 rows = 5 cm (2")
in Weaving Pattern.

The Pattern is a REPEAT of 8 rows Stockinette stitch at Tension 6 or 7 using single strand of Venetia, plus 4 rows WEAVING using TWO STRANDS of Beatrice Silver and TENSION 9.1. (Purl Side). Use Card No. 1 (830/820 machines) or Punch your own Card.

FINISHING: See General Instructions. Sew up side seams then turn pocket Linings to inside and sew together. Make 3 sets of Cords using Beatrice Silver and make braid then sew around outside of Jacket, around sleeves and neckline (See Picture). Sew darts in skirt and bust darts on front of jacket.



SLEEVES: III

Cast on 70 (70) [70] sts. and work in Pattern.
ON EACH SIDE, increase 1 st. every 10th row 14x. (every 10th row 15x). [every 8th row 8x, every 10th row 8x].
After Row 146 (150) [150], SHAPE CAP: Bind off 4 sts. 1x, 3 sts. 1x, 2 sts. 2x, 1 st. 10x, 2 sts. 10x. (4 sts. 1x, 3 sts. 1x, 2 sts. 2x, 1 st. 10x, 2 sts. 10x). [4 sts. 1x, 3 sts. 1x, 2 sts. 3x, 1 st. 13x, 2 sts. 8x]. After Row 194 (198) [202], bind off the remaining sts.

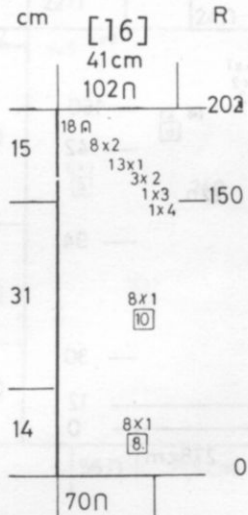
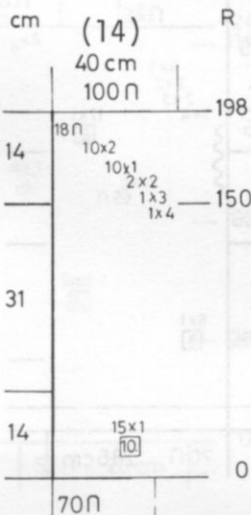
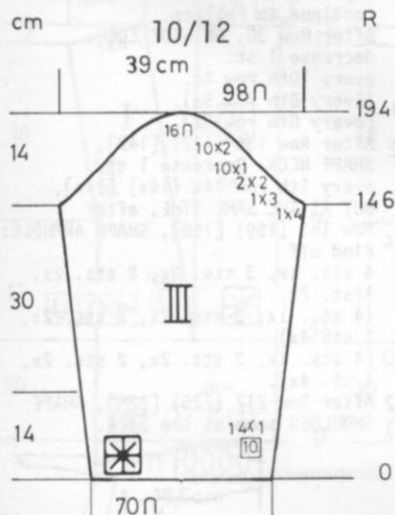
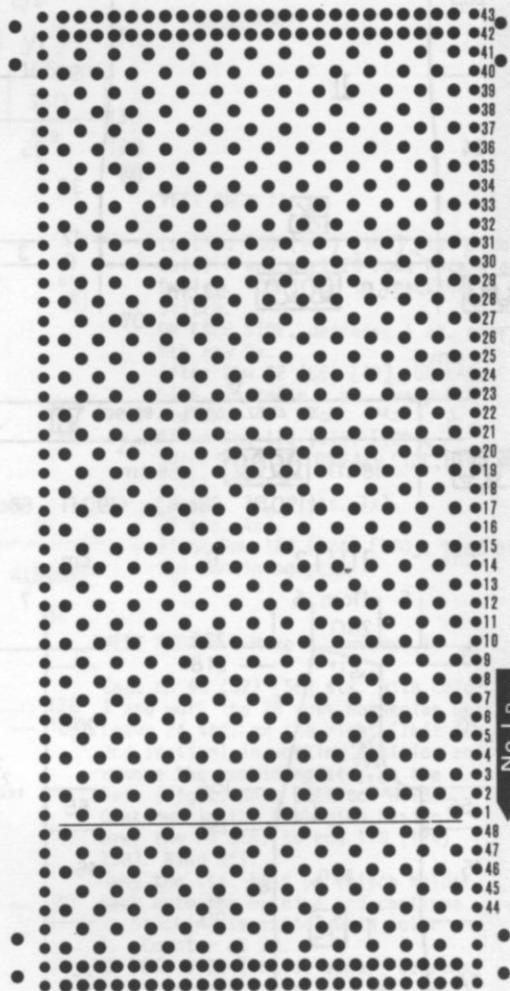

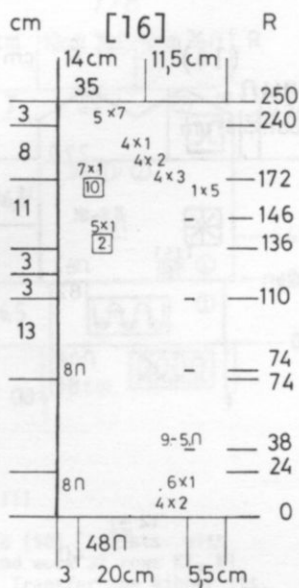
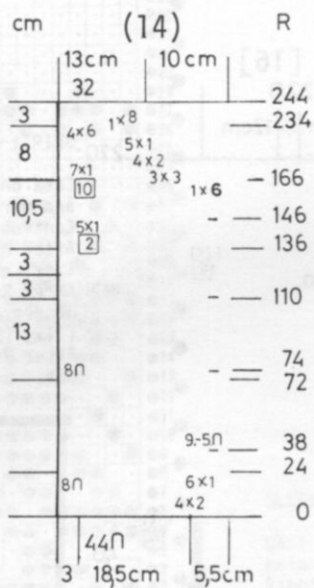
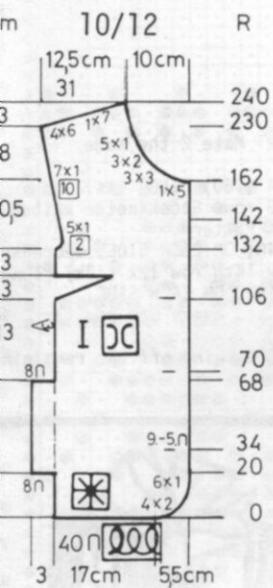

JACKET FRONT: I Make 1, reverse 1 and omit BUTTONHOLES in 2nd section.

Cast on 40 (44) [48] sts. and work in Pattern.
 ON THE RIGHT (left for 2nd section) on every 2nd row, cast on 2 sts. 4x, then 1 st. 6x. (Front Edge). After Row 20 (24) [24], with a separate yarn, ON SIDE EDGE, cast on 8 sts.
 After Row 34 (38) [38], make BUTTONHOLES over needles 5 to 9 counting from the right edge. REPEAT the BUTTONHOLES over the same needles after the Rows shown on the Chart for YOUR SIZE.
 After Row 70 (74) [74], bind off 8 sts. on the side edge.
 Knit to Row 106 (110) [110]. Mark the side edge with bit of contrast yarn for placement of bust dart, then knit to Row 132 (136) [136].
 SHAPE ARMHOLE: ON OPPOSITE SIDE OF CAM BOX, decrease 1 st. every 2nd row 5x, then 1 st. every 10th row 7x. BUT AT THE SAME TIME, after Row 162 (166) [172], SHAPE NECK: Bind off 5 sts. 1x, 3 sts. 3x, 2 sts. 3x, 1 st. 5x.
 (6 sts. 1x, 3 sts. 3x, 2 sts. 4x, 1 st. 5x).
 [5 sts. 1x, 3 sts. 4x, 2 sts. 4x, 1 st. 4x].
 After Row 231 (235) [241], SHAPE SHOULDER same as the back.

JACKET BACK: II

It will be easier for you if you make the pocket linings for back of jacket separately working them in stockette stitch although for the first and smaller size, the linings can be knitted in at the same time.

Back Pocket Linings - cast on 16 sts. with color 1 and work 48 (58) [58] rows Stockinette stitch then bind off. Make 2 the same.

Cast on 166 (170) [180] sts. and work in pattern. Knit to Row 20, mark each side for Pocket lining and knit to Row 68 (72) [72]. Mark each side again for top of pocket lining.

Knit to Row 116 (120) [124].

*Leave 18 (20) [21] sts. and put all other sts. into holding position - be sure to note Pattern Row.

*Over the 18 (20) [19] sts. ON INSIDE EDGE, bind off 4 sts. 1x, 3 sts. 2x, 2 sts. 2x, 1 st. 2x.
 (5 sts. 1x, 3 sts. 2x, 2 sts. 2x, 1 st. 3x).
 [6 sts. 1x, 3 sts. 2x, 2 sts. 2x, 1 st. 3x].

Bind off the remaining 2 sts. Move the Cam Box to the left side, Leave 18 (20) [19] sts. in work, turn the Row Counter back to 116 and follow the instructions from *.

Move the Cam Box back to the right, turn the Row Counter back to 116 (120) [124] and complete the same shaping following the instructions from *.

Move the Cam Box back to the right, turn the Row Counter back to 116 (120) [124] and SHAPE ARMHOLE: ON EACH SIDE, bind off 3 sts. 2x, 2 sts. 2x, 1 st. 5x. (3 sts. 2x, 2 sts. 2x, 1 st. 4x). [3 sts. 2x, 2 sts. 3x, 1 st. 4x]. Knit to Row 184 (188) [194]. SHAPE SHOULDER AND WATCH FOR NECK SHAPING.

FOR SHOULDER, bind off 6 sts. 4x, 7 sts. 1x, (6 sts. 4x, 8 sts. 1x), [5 sts. 7x]. AT THE SAME TIME, after Row 190 (194) [200], put half the sts. on the left into holding position and complete the right side first.

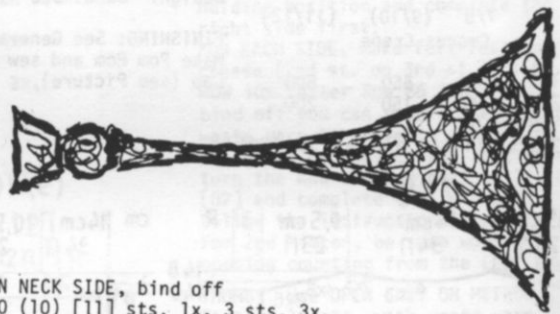

*ON NECK SIDE, bind off 10 (10) [11] sts. 1x, 3 sts. 3x. Bring the needles on the left into working position, knit 1 row in Pattern to the left side, turn the Row Counter back to 190 (194) [200] and complete the left side. Follow the instructions from * but don't forget to complete the shoulder shaping.



Continued

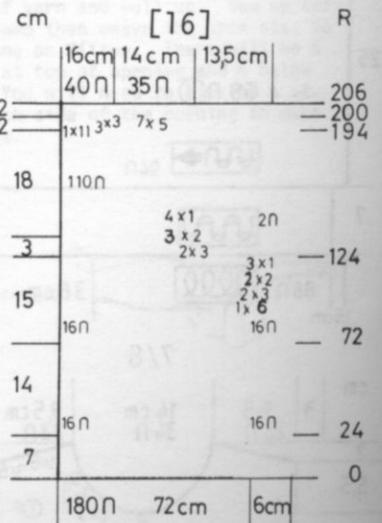
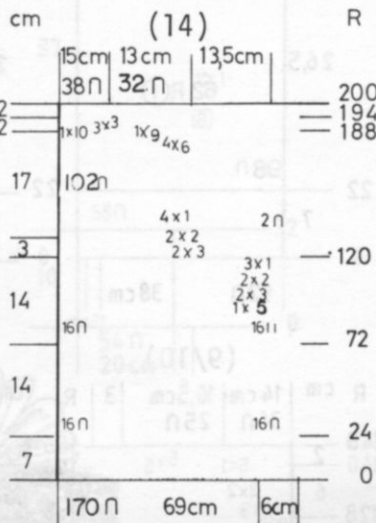
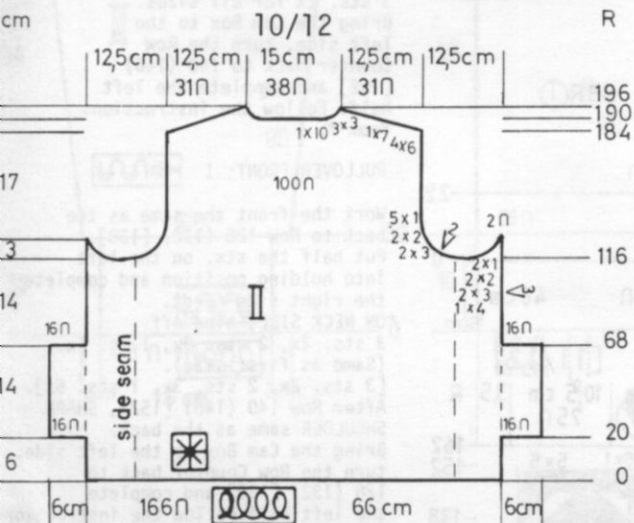

dk 676

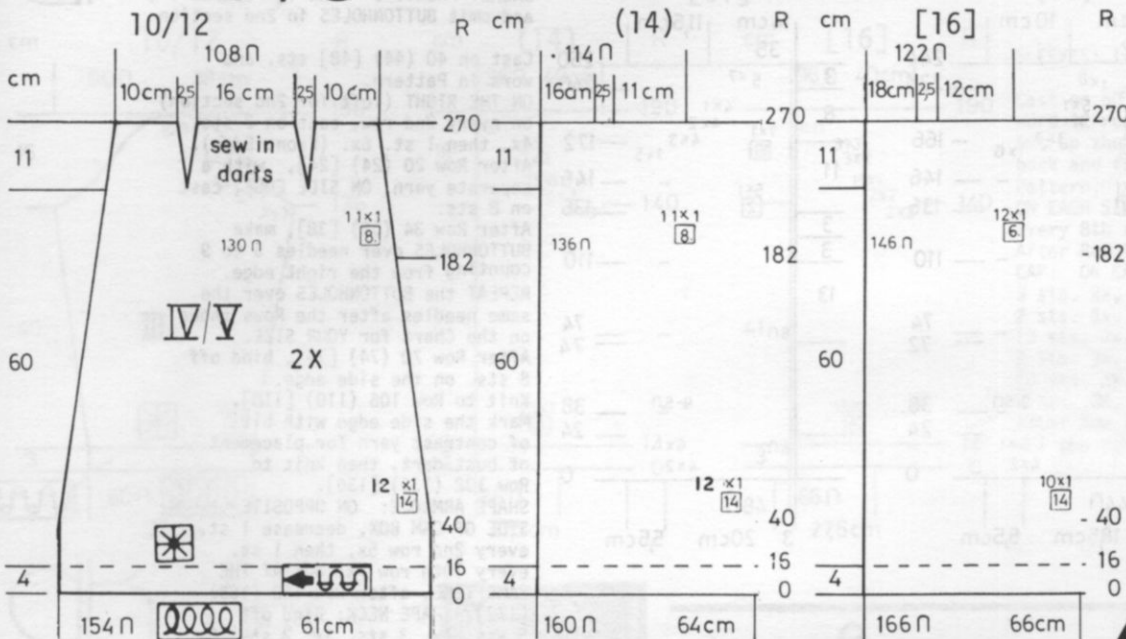

SKIRT: IV/V Make 2 the same.

Cast on 154 (160) [166] sts. and work 16 rows Stockinette stitch. Continue in Pattern. After Row 40, ON EACH SIDE, decrease 1 st. every 14th row 12x (12x) [10x] [88] After Row 182, ON EACH SIDE, decrease 1 st. every 8th row 11x (11x) [12x]. After Row 270, bind off the remaining sts.



kk 678

CHILDS PULLOVER, MITTENS & CAP

SIZES: 7/8 (9/10) [11/12]
 YARN: Crocus Crepe
 GRAMS: color 1 500 550 600
 color 2 150 150 200
 TENSION: 9 or 10
 GAUGE: 12 sts. 14 1/2 rows = 5 cm (2")

Stockinette stitch with a Norwegian Design. Bands are Ribbed.

FINISHING: See General Instructions. Make Pom Pom and sew to top of Cap (see Picture).



PULLOVER BACK: II

Cast on 86 (92) [96] sts. with color 1 and work 22 rows K1, P1 Ribbing. Transfer the Ribber sts. to main machine with color 1 work Stockinette stitch to Row 80 (84) [88] then work the 35 rows of the Norwegian Design BUT AT THE SAME TIME after Row 94 (98) [102], SHAPE ARMHOLE: ON EACH SIDE, bind off 2 sts. 2x, 1 st. 3x. (2 sts. 2x, 1 st. 3x). [2 sts. 2x, 1 st. 4x].

When Pattern is completed continue in Stockinette stitch with color 1.

Knit to Row 140 (146) [152]. SHAPE SHOULDER AND NECK AT THE SAME TIME. Put half the sts. on the left into holding position and complete the right side first.

*FOR SHOULDER, bind off 6 sts. 3x, 5 sts. 1x, (5 sts. 5x), [5 sts. 5x],

FOR NECK: Bind off 11 (11) [12] sts. 1x, then 3 sts. 2x for all sizes.

Bring the Cam Box to the left side, turn the Row Counter back to 140 (146) [152] and complete the left half. Follow the instructions from *.

PULLOVER FRONT: I

Work the front the same as the back to Row 128 (132) [138]. Put half the sts. on the left into holding position and complete the right side first.

*ON NECK SIDE, bind off 3 sts. 2x, 2 sts. 3x, 1 st. 5x. (Same as first size). [3 sts. 2x, 2 sts. 3x, 1 st. 6x]. After Row 140 (146) [152], SHAPE SHOULDER same as the back. Bring the Cam Box to the left side, turn the Row Counter back to 128 (132) [138] and complete the left half. Follow the instructions from *.

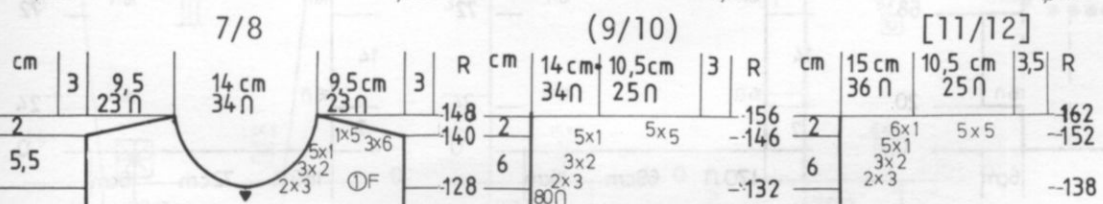
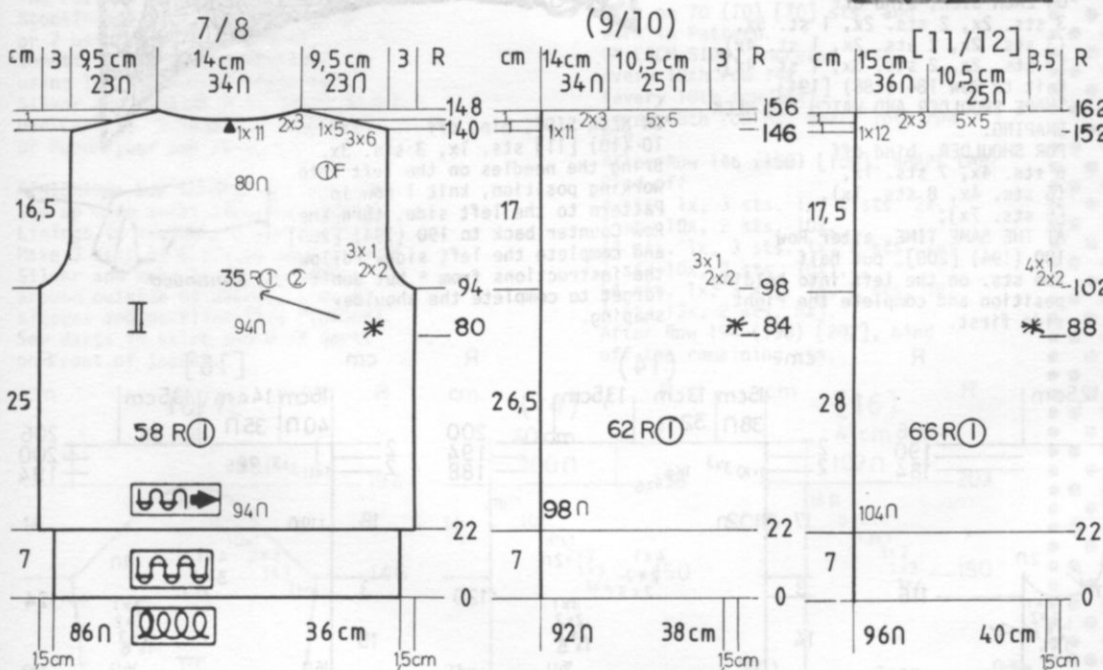

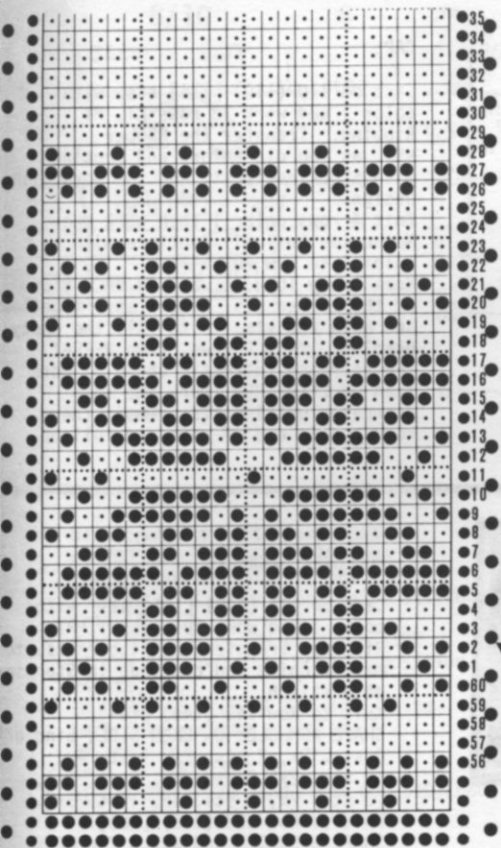

COLLAR:

Cast on 130 (134) [138] sts. with color 1 and work 46 rows K1, P1 Ribbing. Bind off the crochet method for Ribbing or you can remove the sts. onto contrast waste yarn.

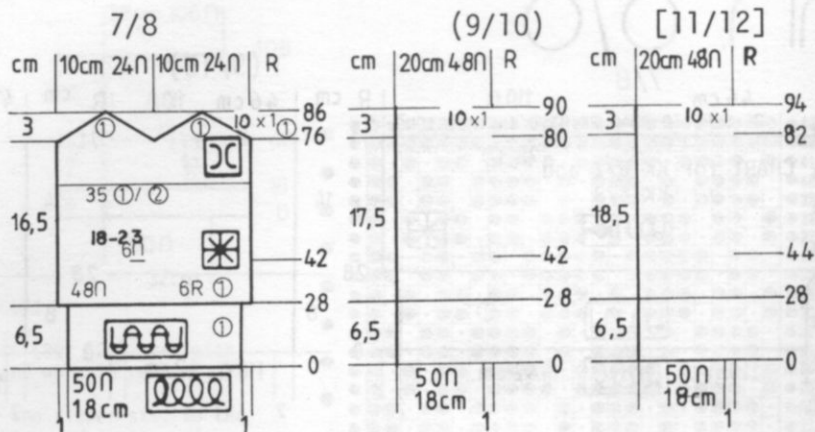

SLEEVES: III

Cast on 48 (50) [54] sts. with color 1 and work 32 rows K1, P1 Ribbing. Transfer the Ribber sts. as you did before and continue in Stockinette stitch with color 1. Increase 4 (4) [5] sts. evenly Across. ON EACH SIDE, increase 1 st. every 8th row 10x (11x) [11x] BUT AT THE SAME TIME, after Row 114 (120) [126], begin the 35 rows of the Norwegian Design and after Row 128 (134) [140] SHAPE CAP continuing with Stockinette stitch when the Norwegian Design is completed. FOR CAP SHAPING, on each side, bind off
3 sts. 1x, 2 sts. 2x, 1 st. 4x
2 sts. 10x.
(3 sts. 1x, 2 sts. 2x, 1 st. 2x, 2 sts. 12x).
[3 sts. 1x, 2 sts. 2x, 1 st. 3x, 2 sts. 12x].
After Row 162 (168) [176], bind off the remaining sts.

MITTENS: Make 2 and reverse the sides for Thumb opening on 2nd mitten.

Cast on 50 sts. with color 1 and work 28 rows K1, P1 Ribbing. Transfer the Ribber sts. to main machine and decrease 1 st. on EACH SIDE. Knit 6 rows Stockinette stitch with color 1 then work the 35 rows (37 rows for KK 677) of the Norwegian Design BUT AT THE SAME TIME, after Row 42 (42) [44], knit needles 18 to 24 counting from the right edge with a piece of contrast yarn but leave the needles in working position. When Pattern is completed, work Stockinette stitch with color 1 to Row 76 (80) [82]. Put half the sts. on the left into holding position and complete the right side first. *ON EACH SIDE, make full fashion decrease (2nd st. on 3rd st.) EVERY ROW 10x. After Row 86 (90) [94], bind off you can remove the sts. on waste yarn to weave to other side. Bring the Cam Box to the left side, turn the Row Counter back to 76 (80) [82] and complete the left half. Follow the instructions from *. For 2nd Mitten, be sure work the opening counting from the LEFT edge.

THUMB: Use OPEN CAST ON METHOD. Cast on 16 sts. with waste yarn. Knit 8 rows, change to color 1 and put Counter at 0. Work Stockinette stitch. Knit to Row 20. Hang every 4th st. onto neighboring needle and move the sts. in to fill empty needles. REPEAT the decreases every 2nd row 2x more. Remove the sts. onto end of yarn and pull up. Sew up seam of thumb then weave the open sts. to opening on Mitten. There will be 6 sts. at top of opening and 6 below it. You will need to pick up a st. on each side of the opening to make 16 sts.

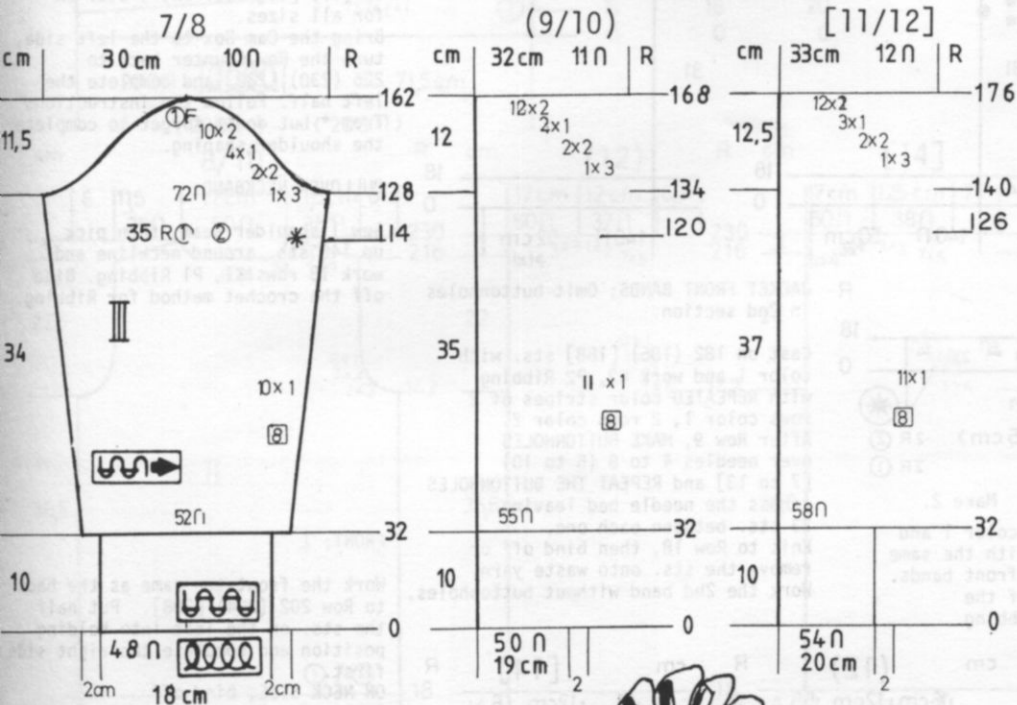

Continued



KK 678

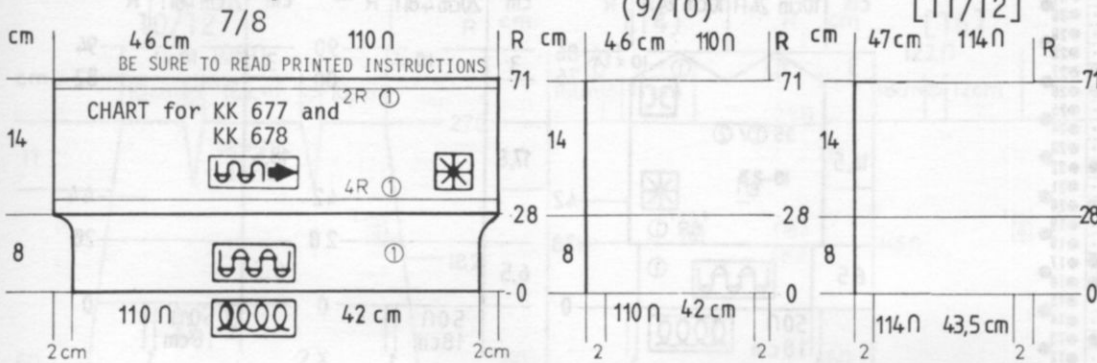

CAP:

Cast on 110 (110) [114] sts. with color 1 and work 28 rows K1, P1 Ribbing. Transfer the Ribber sts. as you did before and continue with Stockinette st. and the Norwegian Design. Knit 4 rows color 1 then work the Norwegian Design. Continue with color 1 to Row 70. Mark every 10th st. and ON EACH SIDE of the marked sts. hang 2 sts. together and move the sts. in to fill the empty needles. Knit 2 rows, then REPEAT the decreases directly above 3x more then ON EVERY ROW, work the same decreases until 5 sts. remain then remove onto end of yarn and pull up.

KK 679

WOMAN'S 3-PIECE SUIT

SIZES: 8/10 (12) [14]
 YARN: Amore
 GRAMS: color 1 750 900 1050
 color 2 250 300 350
 TENSION: 6 to 8
 GAUGE: Stock: 14 sts. 20 1/2 rows = 5 cm
 Nor. 15 sts. 17 rows = 5 cm (2")

SKIRT: Knitted sideways on the machine using Short Rows.
 PULLOVER - Stockinette stitch with Ribbed Bands.
 JACKET: Norwegian Design with Ribbed Bands.

FINISHING: See General Instructions.
 SKIRT: Weave the open sts. together and remove waste yarn. Make hem at lower edge. Fold top of skirt over to the wrong side using elastic as guide and sew in place. Insert elastic through casing.
 Sew on buttons.



PULLOVER BACK: II

Cast on 134 (140) [146] sts. with color 1 and work 18 rows K1, P1 Ribbing. Transfer the ribber sts. to main machine and continue in Stockinette stitch. Knit to Row 142 (144) [144].
 SHAPE ARMHOLE: ON EACH SIDE, bind off 3 sts. 2x, 2 sts. 2x, 1 st. 4x. (3 sts. 2x, 2 sts. 3x, 1 st. 5x). [3 sts. 2x, 2 sts. 3x, 1 st. 5x]. Knit to Row 222 (226) [228].
 SHAPE SHOULDER and watch for NECK SHAPING.
 FOR SHOULDER, bind off 5 sts. 5x, 6 sts. 1x, (5 sts. 5x, 6 sts. 1x), [5 sts. 5x, 8 sts. 1x], AT THE SAME TIME, after Row 226 (230) [232], put half the sts. on the left into holding position and complete the right side first.
 *ON NECK SIDE, bind off 10 (10) [11] sts. 1x, 4 sts. 3x for all sizes.
 Bring the Cam Box to the left side, turn the Row Counter back to 226 (230) [232] and complete the left half. Follow the instructions from * but don't forget to complete the shoulder shaping.

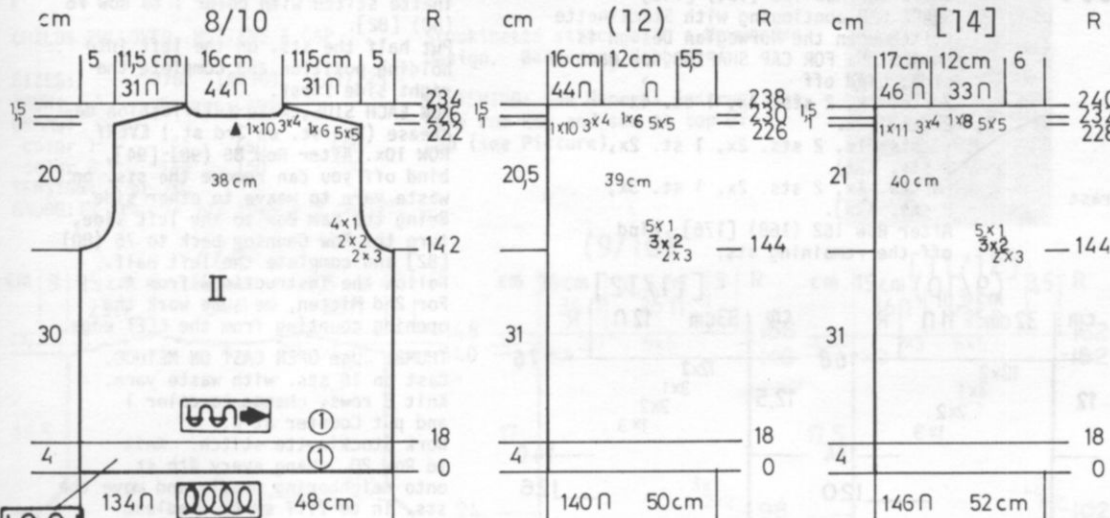

PULLOVER NECKBAND:

Sew 1 shoulder seam, then pick up 140 sts. around neckline and work 18 rows K1, P1 Ribbing. Bind off the crochet method for Ribbing.

JACKET FRONT BANDS: Omit buttonholes in 2nd section.

Cast on 182 (185) [188] sts. with color 1 and work K2, P2 Ribbing with REPEATED color stripes of 2 rows color 1, 2 rows color 2. After Row 9, MAKE BUTTONHOLES over needles 4 to 8 (5 to 10) [7 to 13] and REPEAT THE BUTTONHOLES across the needle bed leaving 23 sts. between each one. Knit to Row 18, then bind off or remove the sts. onto waste yarn. Work the 2nd band without buttonholes.

FRONT: I

Work the front the same as the back to Row 202 (204) [208]. Put half the sts. on the left into holding position and complete the right side first.
 ON NECK SIDE, bind off 3 sts. 2x, 2 sts. 3x, 1 st. 4x. (3 sts. 2x, 2 sts. 6x, 1 st. 4x). [4 sts. 1x, 3 sts. 2x, 2 sts. 4x, 1 st. 5x]. After Row 222 (226) [232], SHAPE SHOULDER same as the back.

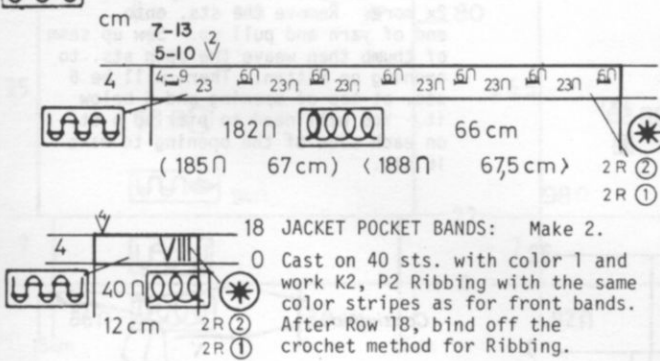

18 JACKET POCKET BANDS: Make 2.
 Cast on 40 sts. with color 1 and work K2, P2 Ribbing with the same color stripes as for front bands. After Row 18, bind off the crochet method for Ribbing.

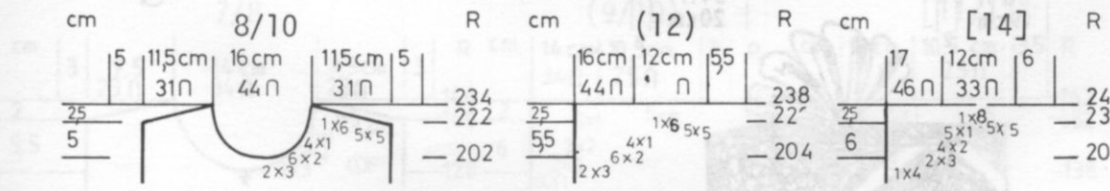

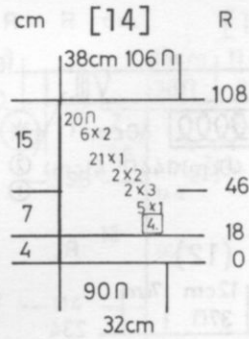
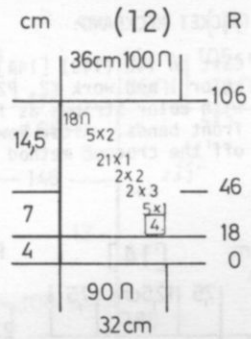
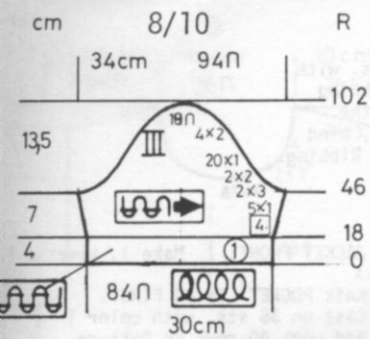

SLEEVES: III

Cast on 84 (90) [90] sts. with color 1 and work 18 rows K1, P1 Ribbing. Transfer the ribber sts. to the main machine and continue in Stockinette stitch. ON EACH SIDE, increase 1 st. every 4th row 5x. After Row 46, SHAPE CAP: ON EACH SIDE, bind off 3 sts. 2x, 2 sts. 2x, 1 st. 20x, 2 sts. 4x. (3 sts. 2x, 2 sts. 2x, 1 st. 21x, 2 sts. 5x). [3 sts. 2x, 2 sts. 2x, 1 st. 21x, 2 sts. 6x]. After Row 102 (106) [108], bind off the remaining sts.

SKIRT:

With contrast waste yarn, cast on 200 sts. Knit 8 to 10 rows then change to color 1, put Counter at 0. Work Stockinette stitch. *Knit 16 (18) [20] rows. Work SHORT ROWS. ON OPPOSITE SIDE OF CAM BOX, put into holding position, 24 sts. 7x. ON OPPOSITE SIDE OF CAM BOX, bring back into working position, 24 sts. 7x. Knit 16 (18) [20] rows. REPEAT FROM * 9x MORE. (Row 600(640)[680] Remove onto contrast waste yarn.

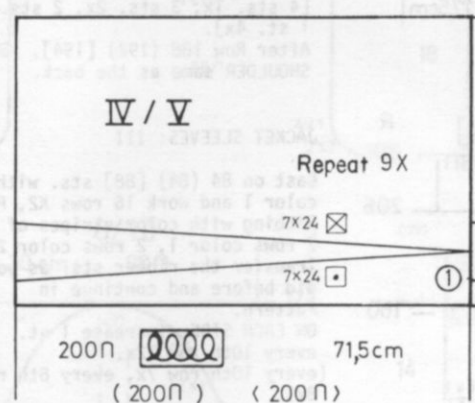

R	(R)	(R)
600	640	680

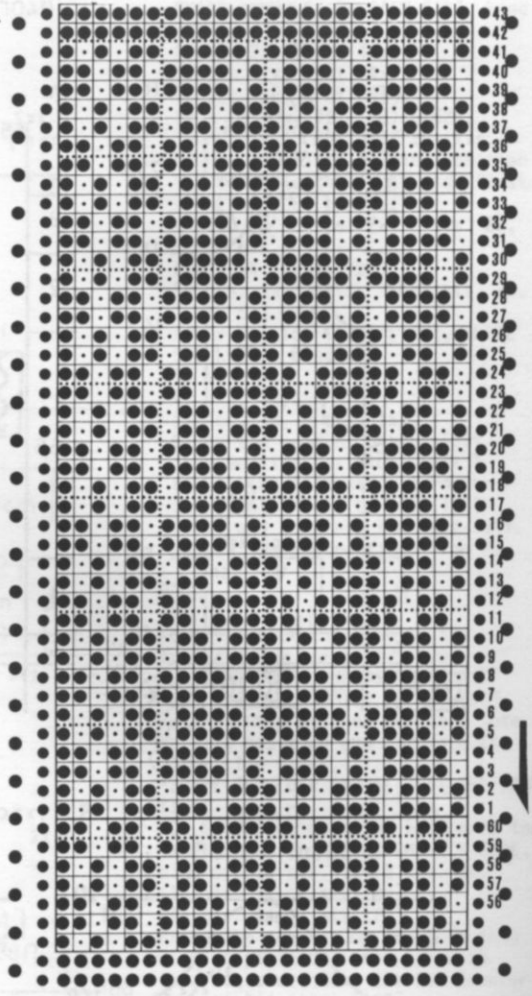
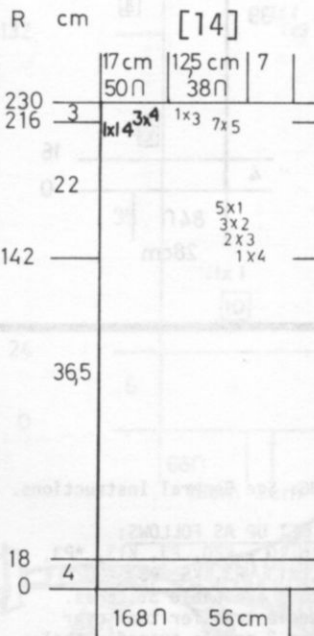
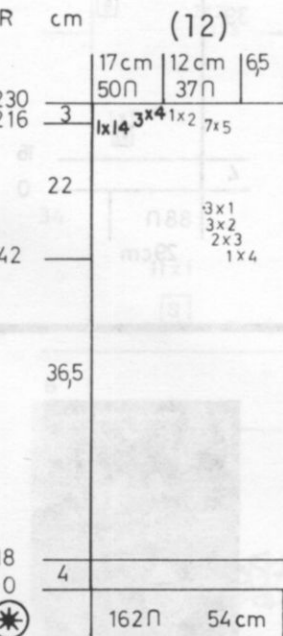
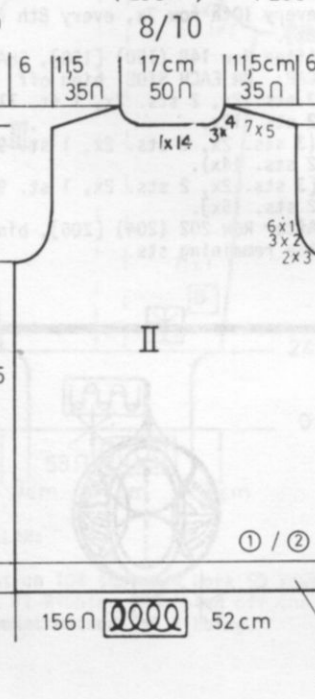

JACKET BACK: II

Cast on 156 (162) [168] sts. with color 1 and work 18 rows K2, P2 Ribbing. Transfer the ribber sts. to main machine and continue in Norwegian Design. Knit to Row 142. SHAPE ARMHOLE: ON EACH SIDE, bind off 3 sts. 2x, 2 sts. 3x, 1 st. 6x. (4 sts. 1x, 3 sts. 2x, 2 sts. 3x, 1 st. 3x). [4 sts. 1x, 3 sts. 2x, 2 sts. 3x, 1 st. 5x]. Knit to Row 216 for all sizes. SHAPE SHOULDER AND SHAPE NECK AT THE SAME TIME. Put half the sts. on the left into holding position and complete the right side first. *FOR SHOULDER, bind off 5 sts. 7x, (5 sts. 7x, 2 sts. 1x), [5 sts. 7x, 3 sts. 1x], FOR NECK, bind off 14 sts. 1x, 4 sts. 3x for all sizes. Bring the needles on the left into working position, knit 1 row in Pattern to the left side, turn the Row Counter back to 216 and complete the left half. Follow the instructions from *.

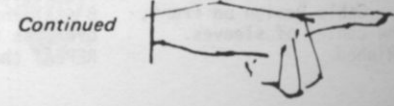

dk 679

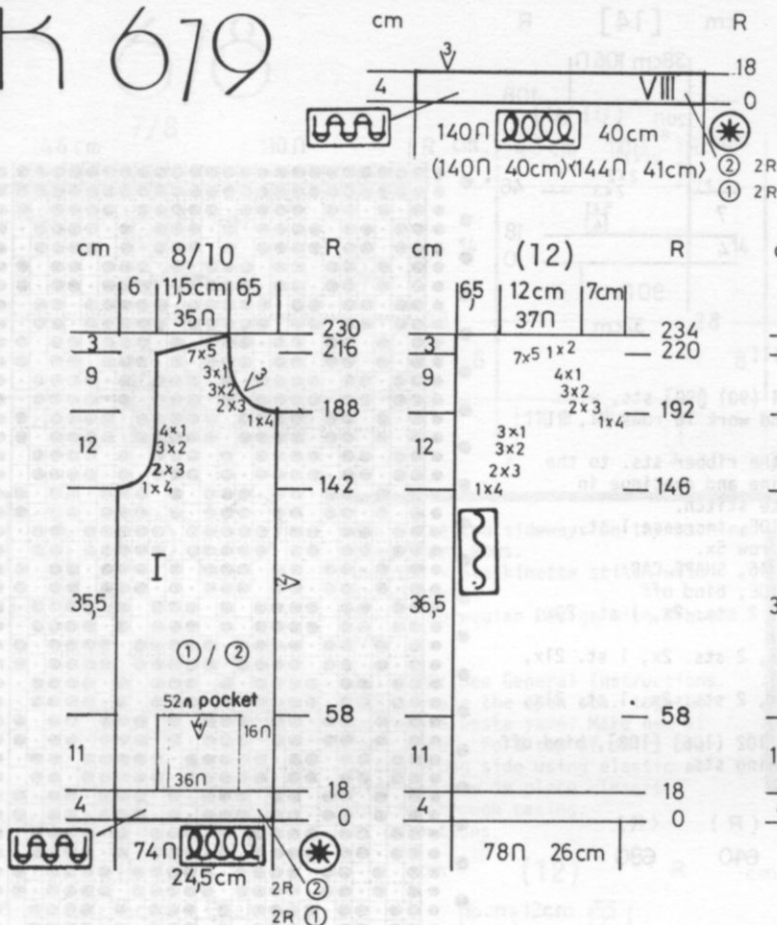

JACKET NECKBAND:

Cast on 140 (140) [144] sts. with color 1 and work K2, P2 Ribbing with color stripes as for the front bands. After Row 18, bind off the crochet method for Ribbing.

JACKET FRONT: I Make 1, reverse

Knit POCKET LINING FIRST. Cast on 36 sts. with color 1 and work 40 rows in Pattern. Remove onto waste yarn and put aside. Make 2 the same. FRONT: - Cast on 74 (78) [82] sts. with color 1 and work 18 rows K2, P2, Ribbing with color stripes of 2 rows color 1, 2 rows color 2. Transfer the ribber sts. to main machine and continue in the Norwegian Design. Knit to Row 58. Counting from the right (left for 2nd section) edge, remove stitches 17 to 52 onto a stitch holder and with purl side facing you, hang the pocket lining sts. onto these needles. Remove the waste yarn and continue in Pattern. Knit to Row 141 (145) 145]. SHAPE ARMHOLE: Bind off 4 sts. 1x, 3 sts. 2x, 2 sts. 3x, 1 st. 4x. (4 sts. 1x, 3 sts. 2x, 2 sts. 3x, 1 st. 3x). [4 sts. 1x, 3 sts. 2x, 2 sts. 4x, 1 st. 4x]. After Row 188 (192) [194], SHAPE SHOULDER same as the back.

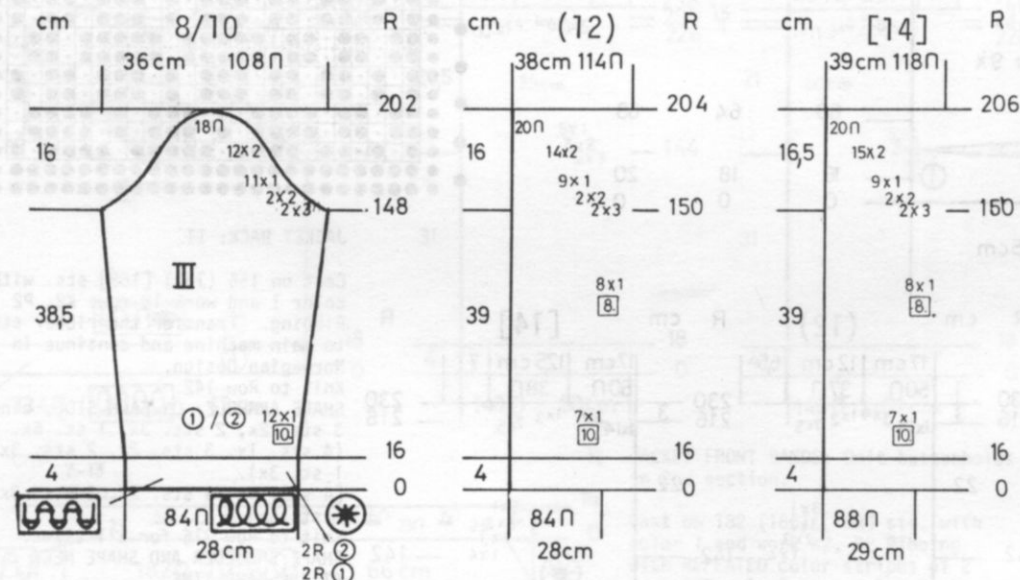

JACKET SLEEVES: III

Cast on 84 (84) [88] sts. with color 1 and work 16 rows K2, P2 Ribbing with color stripes of 2 rows color 1, 2 rows color 2. Transfer the ribber sts. as you did before and continue in Pattern. ON EACH SIDE, increase 1 st. every 10th row 12x. (every 10th row 7x, every 8th row 8x). [every 10th row 7x, every 8th row 8x]. After Row 148 (150) [150], SHAPE CAP: ON EACH SIDE, bind off 3 sts. 2x, 2 sts. 2x, 1 st. 11x, 2 sts. 12x. (3 sts. 2x, 2 sts. 2x, 1 st. 9x, 2 sts. 14x). [3 sts. 2x, 2 sts. 2x, 1 st. 9x, 2 sts. 15x]. After Row 202 (204) [206], bind off the remaining sts.

kk 680

TEEN PULLOVER

SIZES: 8 (10) [12]
YARN: Crocus Crepe
GRAMS: 450 500 550
TENSION: 8 to 9
GAUGE: 13 sts. 16 rows over Pattern.

Knitted with Main Machine plus the Ribber. Cable Design on front, back and the center of sleeves. Bands are Ribbed.

FINISHING: See General Instructions.

PATTERN SET UP AS FOLLOWS:

ROWS 1 to 10 - K20, P3, K13, *P3, K8, P3*, K13, P3, K6, P3, K20. From * to * are Cable Stitches. Use 2 needle transfer tool over 8 sts. and 3 needle transfer tool over the 6 sts. REPEAT the Cables every 10th row.



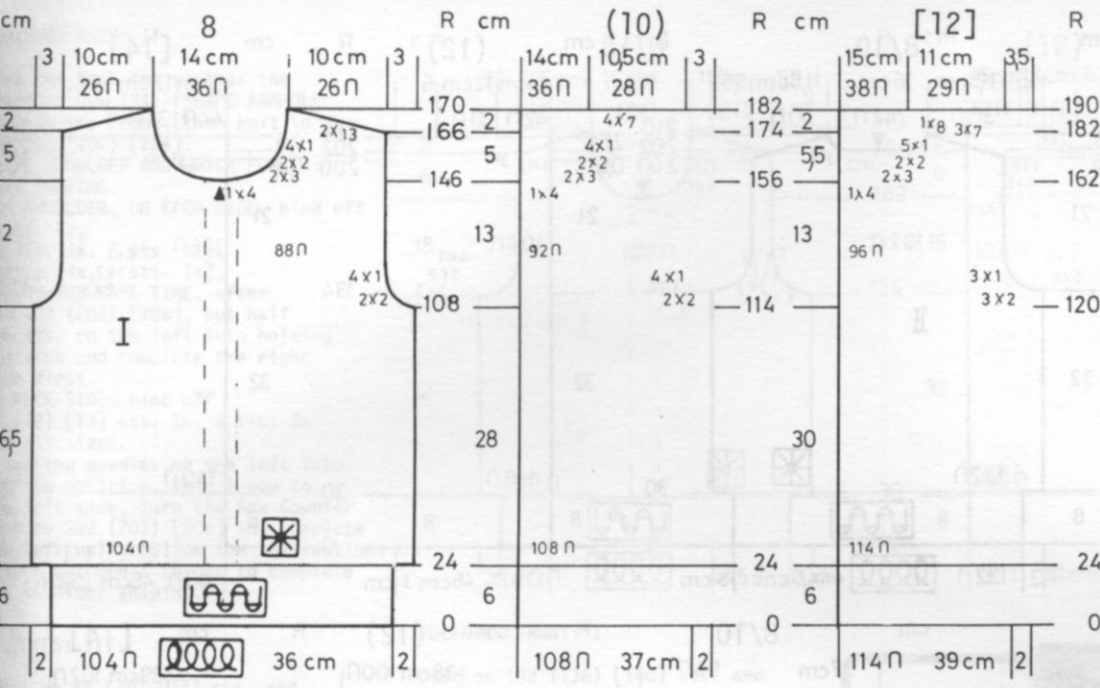

FRONT: I
 Cast on 104 (108) [114] sts. and work 24 rows K1, P1 Ribbing. Set into Pattern as given above and continue in the Cable Design. Knit to Row 108 (114) [120]. SHAPE ARMHOLE: ON EACH SIDE, bind off 2 sts. 2x, 1 st. 4x. (2 sts. 2x, 1 st. 4x). [2 sts. 3x, 1 st. 4x]. Knit to Row 146 (156) [162]. SHAPE NECK: Put half the sts. on the left into holding position and complete the right side first. *ON NECK SIDE, bind off 4 sts. 1x, 3 sts. 2x, 2 sts. 2x, 1 st. 4x. (Same as first size). [4 sts. 1x, 3 sts. 2x, 2 sts. 2x, 1 st. 5x]. After Row 166 (174) [182], SHAPE SHOULDER. Bind off 13 sts. 2x. (7 sts. 4x). [7 sts. 3x, 8 sts. 1x]. Bring the needles on the left into working position, knit 1 row to the left side, turn the Row Counter back to 146 (156) [162] and complete the left half. Follow the instructions from *.

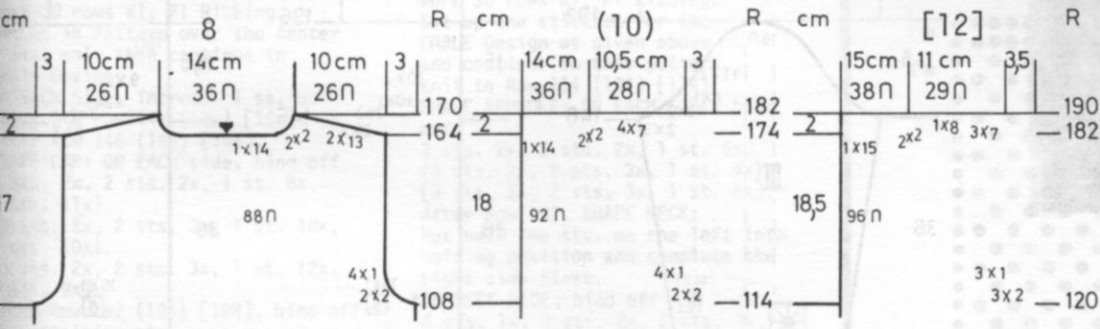

BACK: II
 Work the back the same as the front to Row 108 (114) [120]. SHAPE ARMHOLE SAME AS THE FRONT then knit to Row 164 (174) [182]. Put half the sts. on the left into holding position and complete the right side first. *SHAPE SHOULDER AND NECK AT THE SAME TIME. FOR SHOULDER, make the bind offs the same as the front and ON NECK SIDE, bind off 14 sts. 1x, 2 sts. 2x. (14 sts. 1x, 2 sts. 2x). [15 sts. 1x, 2 sts. 2x]. Bring the needles on the left into working position, knit 1 row to the left side, turn the Row Counter back to 164 (174) [182] and complete the left half. Follow the instructions from *.

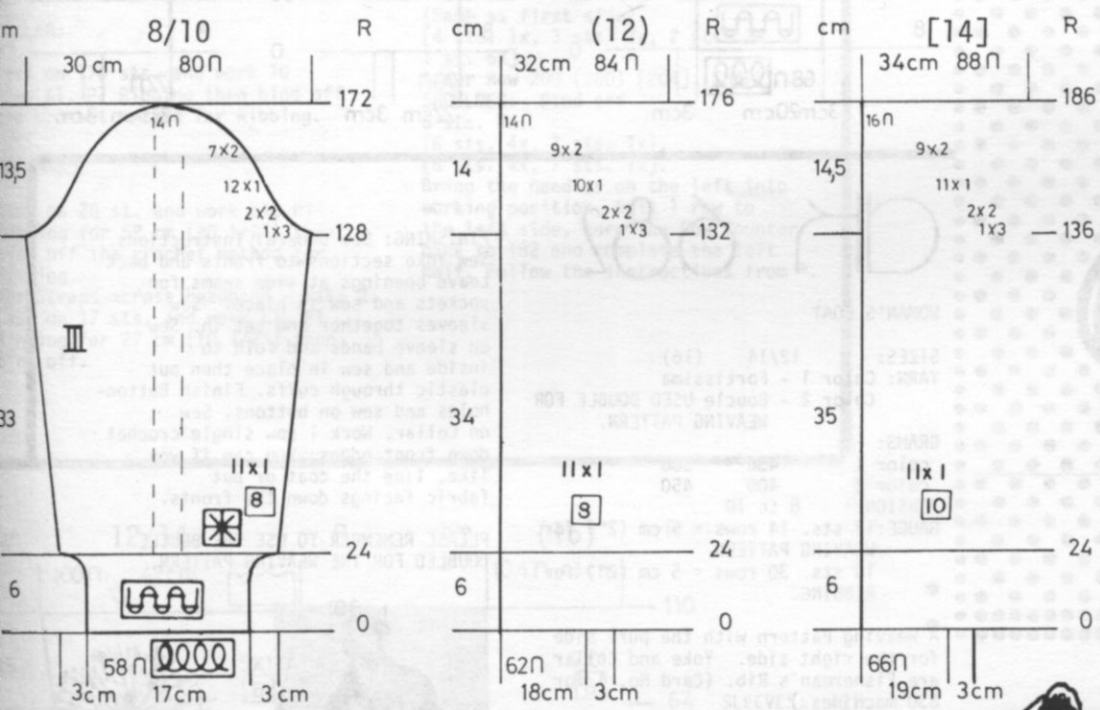

SLEEVES: III
 Cast on 58 (62) [66] sts. and work 24 rows K1, P1 Ribbing. Set up the Pattern ONLY OVER THE CENTER 8 sts. then continue working the Cables over these center sts. ON EACH SIDE, increase 1 st. every 8th row 11x (every 8th row 11x). [every 10th row 11x]. After Row 128 (132) [136], SHAPE CAP: ON EACH SIDE, bind off 3 sts. 1x, 2 sts. 2x, 1 st. 12x, 2 sts. 7x. (3 sts. 1x, 2 sts. 2x, 1 st. 10x, 2 sts. 9x). [3 sts. 1x, 2 sts. 2x, 1 st. 11x, 2 sts. 9x]. After Row 172 (176) [182], bind off the remaining sts.

COLLAR:
 Cast on 104 sts. and work 50 rows K1, P1 Ribbing then bind off the crochet method for Ribbing.

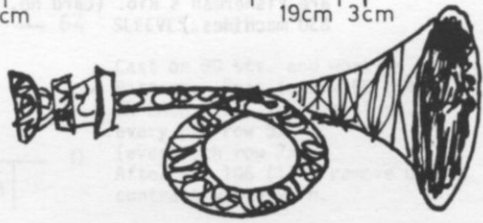

dk 601

WOMAN'S PULLOVER & HEADBAND

SIZES: 8/10 (12) [14]
 YARN: Crocus Crepe
 GRAMS: 700 750 800
 TENSION: 8 to 9
 GAUGE: 13 sts. 16 rows = 5 cm (2")

A Cable Design on front, back and center of sleeves. Bands and Headband are K1, P1 Ribbing.

FINISHING: See General Instructions.
 HEADBAND: Sew seam of larger band then cross and sew smaller bands in place (see Picture).

NEEDLE SET UP FOR CABLE DESIGN
 K29, P3, K6, P3, K6, P3, K18,
 P3, K8, P3, K18, P3, K6, P3,
 K29. K 10 rows then cross Cables
 using 3 needle transfer tool over
 the 6 sts. and 2 needle transfer
 tool over the 8 sts. REPEAT the
 Cables every 10 rows.

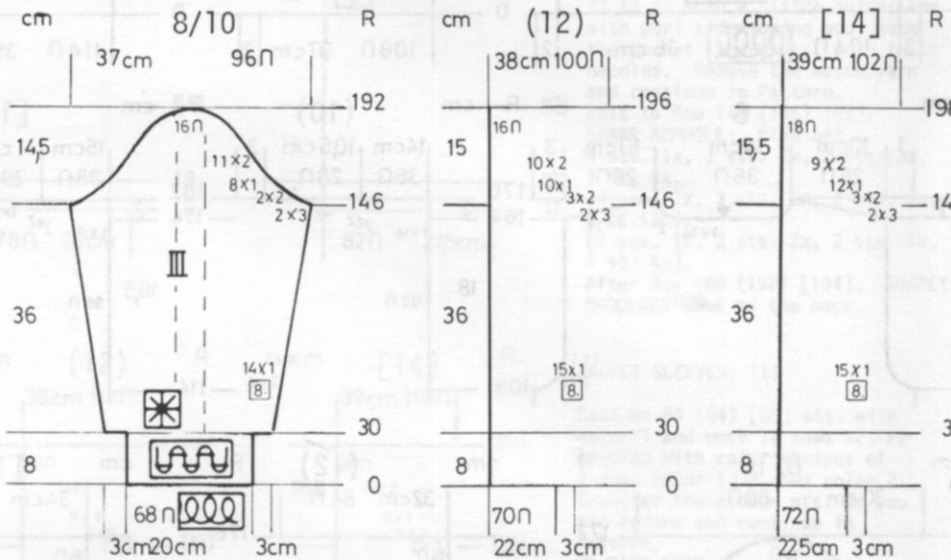
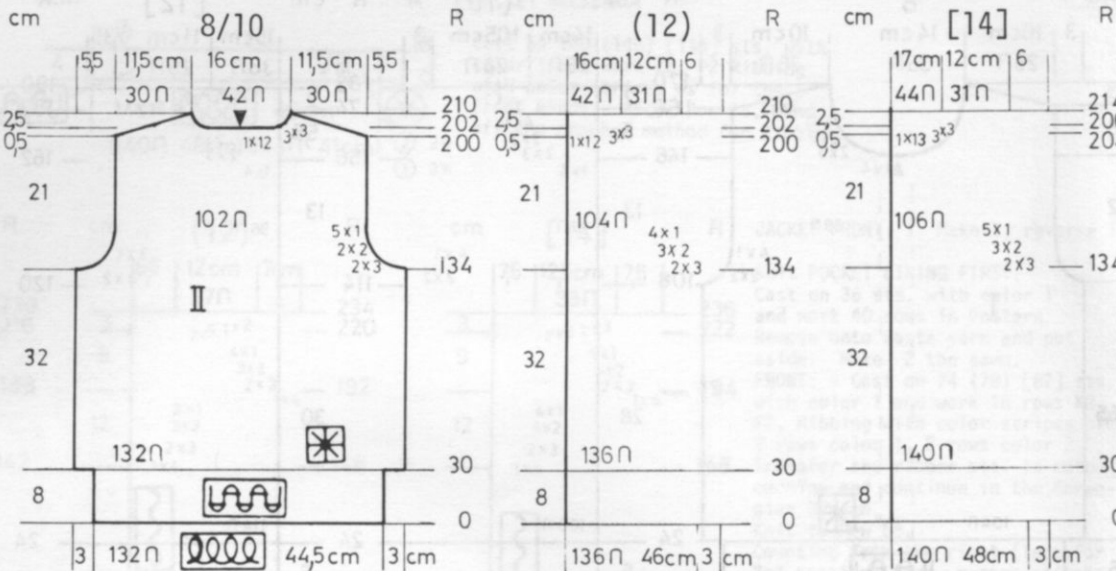

dk 602

WOMAN'S COAT

SIZES: 12/14 (16)
 YARN: Color 1 - Fortissima
 Color 2 - Boucle USED DOUBLE FOR WEAVING PATTERN.
 GRAMS:
 color 1 450 500
 color 2 400 450
 TENSION: 8 to 10
 GAUGE: 12 sts. 14 rows = 5 cm (2") for WEAVING PATTERN
 10 sts. 30 rows = 5 cm (2") for RIBBING.

A Weaving Pattern with the purl side for the right side. Yoke and Collar are Fisherman's Rib. (Card No. 1 for 830 machines.)

FINISHING: See General Instructions. Sew Yoke sections to fronts and back leave openings at side seams for pockets and sew in place. Sew sleeves together and set in. Sew on sleeve bands and fold to inside and sew in place then put elastic through cuffs. Finish Buttonholes and sew on buttons. Sew on Collar. Work 1 row single crochet down front edges. You can if you like, line the coat or put fabric facings down the fronts.

PLEASE REMEMBER TO USE THE BOUCLE DOUBLED FOR THE WEAVING PATTERN.



PULLOVER BACK: II

Work the back the same as the front to Row 134. SHAPE ARMHOLE same as the front, then knit to Row 200 (200) [204]. SHAPE SHOULDER AND WATCH FOR NECK SHAPING. ON SHOULDER, ON EACH SIDE, bind off 6 sts. 5x, (6 sts. 4x, 7 sts. 1x), (6 sts. 4x, 7 sts. 1x), BUT AT THE SAME TIME, after Row 202 (202) [206], put half the sts. on the left into holding position and complete the right side first. ON NECK SIDE, bind off 2 (12) [13] sts. 1x, 3 sts. 3x or all sizes. Bring the needles on the left into working position, knit 1 row to the left side, turn the Row Counter back to 202 (202) [206] and complete the left half. Follow the instructions from * but don't forget to complete the shoulder shaping.

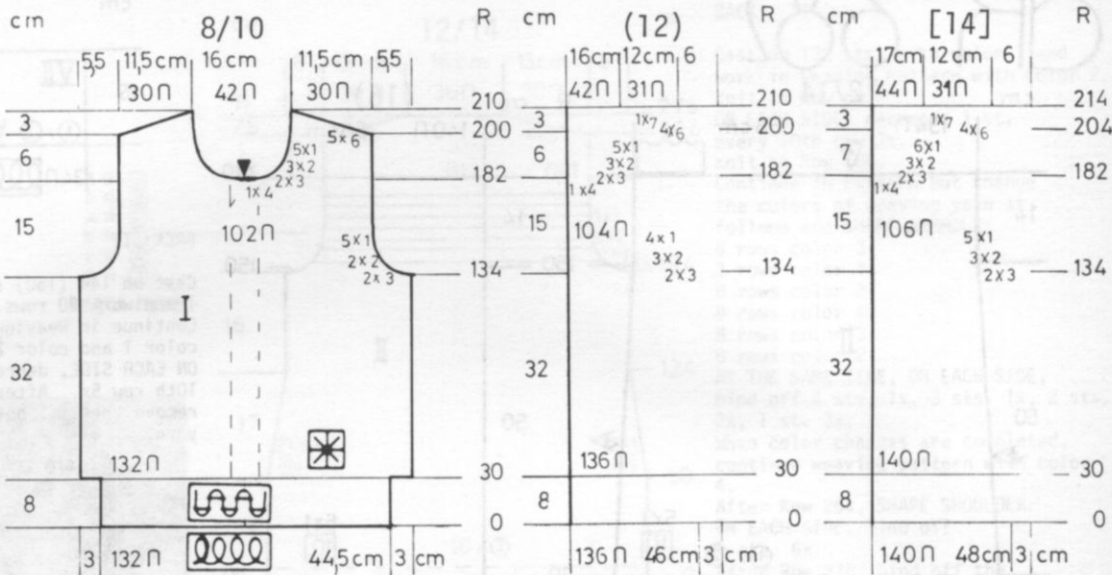

SLEEVES: III

Cast on 68 (70) [72] sts. and work 30 rows K1, P1 Ribbing. Set up in Pattern over the center 8 sts. only then continue in Cable Design. ON EACH SIDE, increase 1 st. every 8th row 14x (14x) [15x]. After Row 146 (146) [146], SHAPE CAP: ON EACH side, bind off 3 sts. 2x, 2 sts. 2x, 1 st. 8x, 2 sts. 11x). (3 sts. 2x, 2 sts. 3x, 1 st. 10x, 2 sts. 10x). (3 sts. 2x, 2 sts. 3x, 1 st. 12x, 2 sts. 9x). After Row 192 (196) [198], bind off the remaining sts.

PULLOVER FRONT: I

Cast on 132 (136) [140] sts. and work 30 rows K1, P1 Ribbing. Set up the stitches for the CABLE Design as given above and continue in this pattern. Knit to Row 134 (134) [134]. SHAPE ARMHOLE: ON EACH SIDE, bind off 3 sts. 2x, 2 sts. 2x, 1 st. 5x. (3 sts. 2x, 2 sts. 3x, 1 st. 4x). [3 sts. 2x, 2 sts. 3x, 1 st. 5x]. After Row 182, SHAPE NECK: Put half the sts. on the left into holding position and complete the right side first. *ON NECK SIDE, bind off 4 sts. 1x, 3 sts. 2x, 2 sts. 3x, 1 st. 5x. (Same as first size). [4 sts. 1x, 3 sts. 2x, 2 sts. 3x, 1 st. 6x]. After Row 200 (200) [204], SHAPE SHOULDER: Bind off 6 sts. 5x. (6 sts. 4x, 7 sts. 1x). [6 sts. 4x, 7 sts. 1x]. Bring the needles on the left into working position, knit 1 row to the left side, turn the Row Counter back to 182 and complete the left half. Follow the instructions from *.

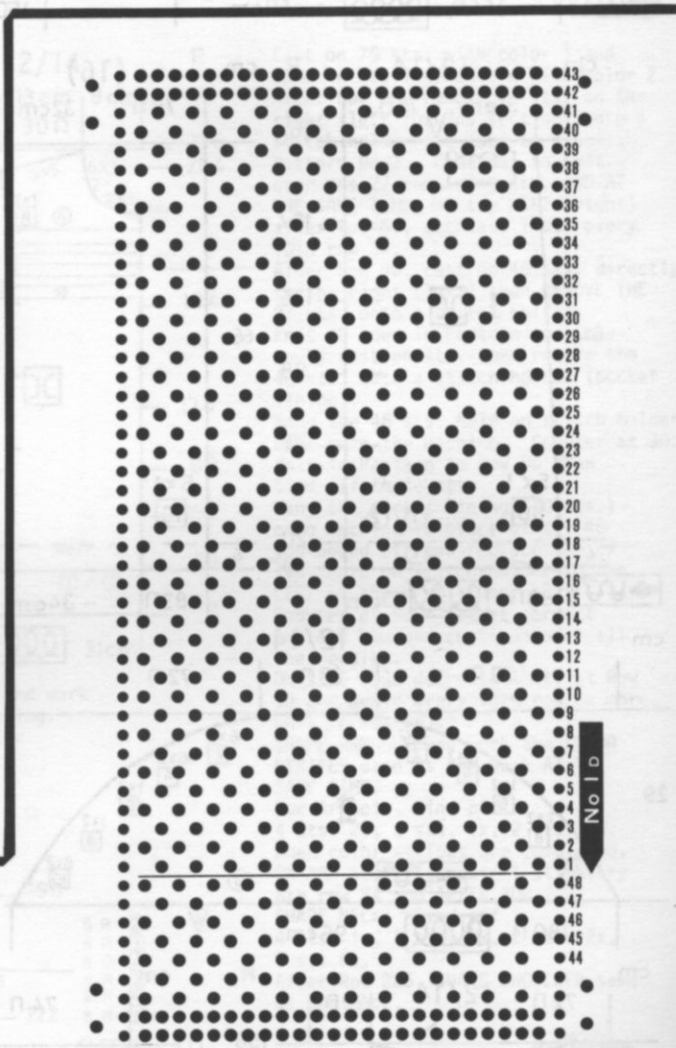

COLLAR:

Cast on 170 sts. and work 70 rows K1, P1 Ribbing then bind off the crochet method for Ribbing.

HEADBAND:

Cast on 28 st. and work K1, P1 Ribbing for 52 cm (20 1/2") then bind off the crochet method for Ribbing. For Straps across headband - make 2. Cast on 17 sts. and work K1, P1 Ribbing for 27 cm (10 1/2") then bind off.

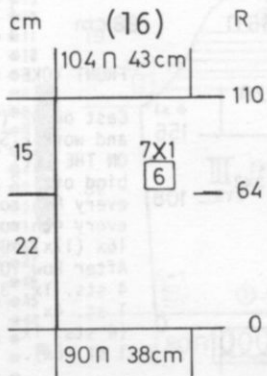
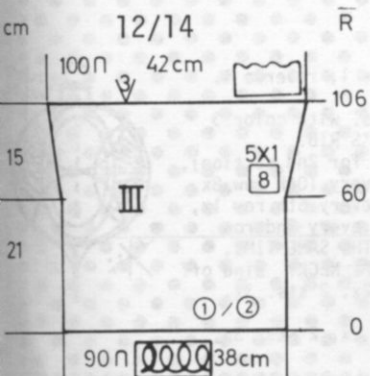

SLEEVES: III

Cast on 90 sts. and work in Pattern. Knit to Row 60 (64). ON EACH SIDE, increase 1 st. every 8th row 5x. (every 6th row 7x). After Row 106 (110) remove onto contrast waste yarn.



dk 682

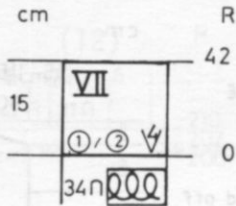
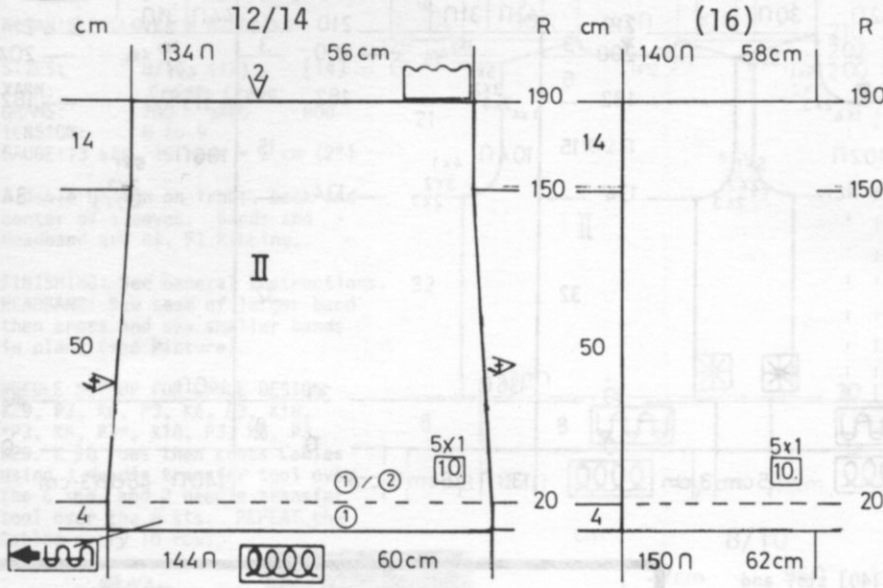

POCKET:
Cast on 34 sts. with color and work the Weaving Pattern to Row 42. Bind off.

BACK: II

Cast on 144 (150) sts. with color 1 and work 20 rows Stockinette stitch. Continue in Weaving Pattern using color 1 and color 2.
ON EACH SIDE, decrease 1 st. every 10th row 5x. After Row 190, remove the sts. onto contrast waste yarn.

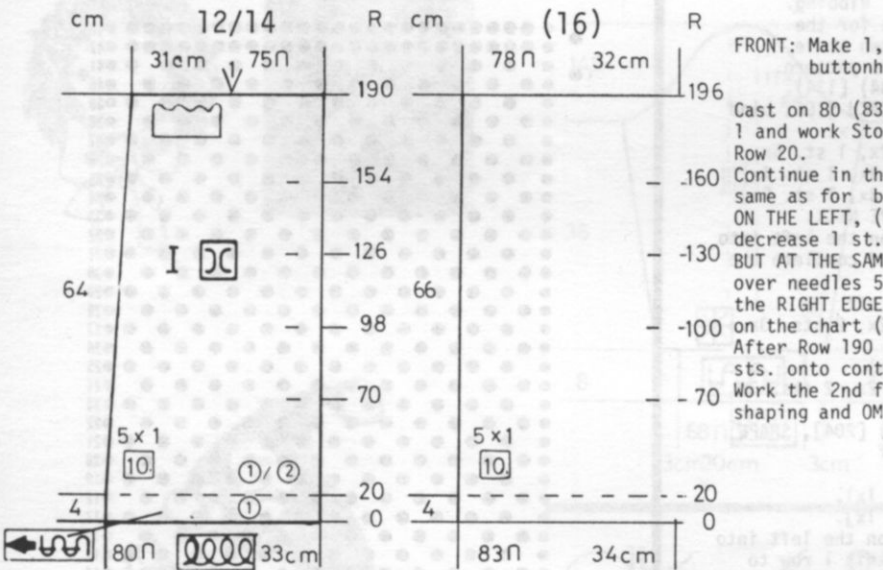

FRONT: Make 1, reverse 1 and omit buttonholes in 2nd section.

Cast on 80 (83) sts. with color 1 and work Stockinette stitch to Row 20.

Continue in the Weaving Pattern same as for back.
ON THE LEFT, (right for 2nd section) decrease 1 st. every 10th row 5x, BUT AT THE SAME TIME make BUTTONHOLES over needles 5 to 9 counting from the RIGHT EDGE after the Rows shown on the chart (use your size). After Row 190 (196), remove the sts. onto contrast waste yarn. Work the 2nd front with reverse shaping and OMIT the BUTTONHOLES.

COLLAR: V

Cast on 114 sts. with color 3 and work Fisherman's Rib. ON EACH SIDE, bind off 2 sts. every 10th row 6x. After Row 66, remove the sts. onto waste yarn.

BELT:

Cast on 24 sts. with color 3 and work K1, P1 Ribbing for 55 inches (140 cm). Bind off the crochet method for Ribbing.

SLEEVE BANDS:

Cast on 50 sts. and work 50 rows K1, P1 Ribbing. Bind off the crochet method for Ribbing.

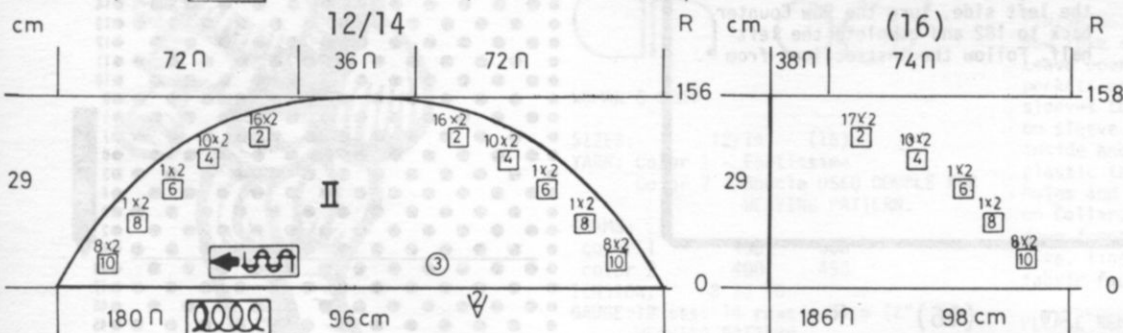

BACK YOKE: II

Cast on 180 (186) sts. with color 3 and work Fisherman's Rib. ON EACH SIDE, bind off 2 sts. every 10th row 6x, every 8th row 1x, every 6th row 1x, every 4th row 10x, every 2nd row 16x (17x). After Row 156 (158), bind off the remaining sts.

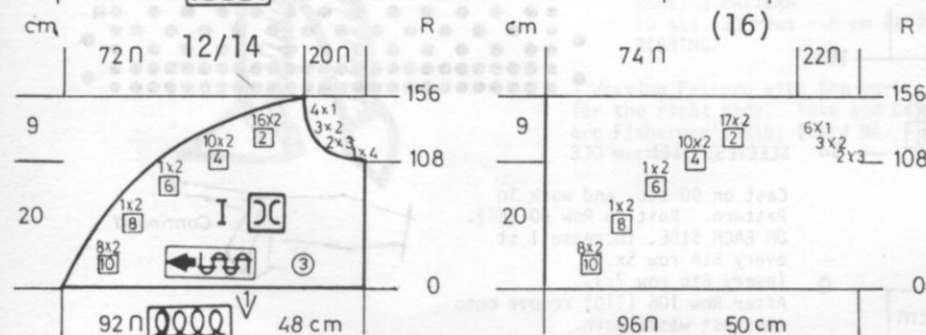

FRONT YOKE: I Make 1, reverse 1.

Cast on 92 (96) sts. with color 3 and work FISHERMAN'S RIB. ON THE LEFT (right for 2nd section), bind off 2 sts. every 10th row 8x, every 8th row 1x, every 6th row 1x, every 4th row 10x, every 2nd row 16x (17x). BUT AT THE SAME TIME, After Row 108, SHAPE NECK: Bind off 4 sts. 1x, 3 sts. 2x, 2 sts. 3x, 1 st. 4x. (4 sts. 1x, 3 sts. 2x, 2 sts. 3x, 1 st. 6x).



683

MAN'S JACKET

SIZE: 12/14
YARN: Color 1 - Fortissima
 Color 2, 3, 4, -Euro Sport
QUANTITIES:
 Color 1 600
 Color 2 400
 Color 3 100
 Color 4 50
CONVERSION: 7 to 9
GAUGE: 12 1/2 sts. 19 rows = 5 cm (2")

Weaving Pattern using same Card as 682. KNITTING 820/830, Card No. in your original set - or you can use your own card. Cuffs and Collar K2, P2 (or K1, P1) Ribbing.

FINISHING: See General Instructions. Sew Pocket Lining in place. Hem lower edge about 1 1/2". Make small hem on front edges then sew in a pocket. Optional: Pull in at waist with threading light weight round elastic through on the wrong side at waistline.



8 R ②
 8 R ③
 8 R ④
 8 R ⑤
 2 R ⑥
 8 R ⑦
 begin here

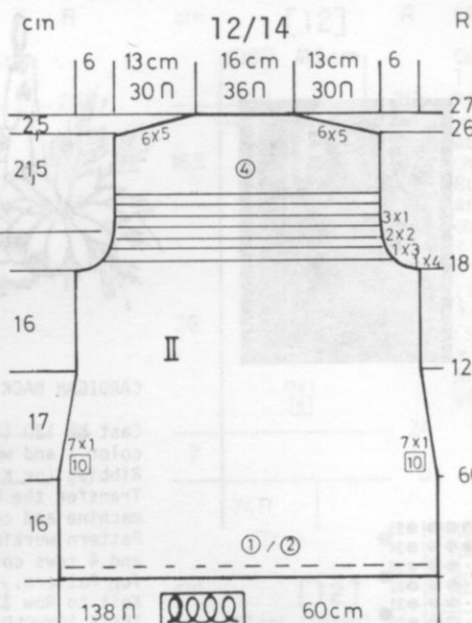

R BACK: II

Cast on 138 sts. with color 1 and work in Weaving Pattern with Color 2. Knit to Row 60. ON EACH SIDE, decrease 1 st. every 10th row 7x. Knit to Row 184. Continue in Pattern but change the colors of weaving yarn as follows and SHAPE ARMHOLE: 8 rows color 3, 2 rows color 4, 8 rows color 2, 8 rows color 4, 8 rows color 3, 8 rows color 2. AT THE SAME TIME, ON EACH SIDE, bind off 4 sts. 1x, 3 sts. 1x, 2 sts. 2x, 1 st. 3x. When color changes are completed, continue weaving pattern with color 4. After Row 264, SHAPE SHOULDER: ON EACH SIDE, bind off 5 sts. 6x. After Row 276, bind off the remaining sts.

FRONT: I Make 1, reverse 1.

COLLAR: With color 1, cast on 162 sts. and work K2, P1 (or K1, P1) Ribbing with 20 rows larger tension and 20 rows smaller tension. Bind off the crochet method for Ribbing.



CUFFS:

Cast on 60 sts. with color 1 and work 40 rows K2, P2 (or K1, P1) Ribbing. Bind off the crochet method for Ribbing.

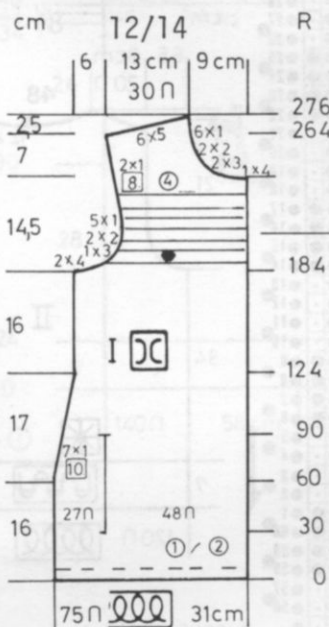

Cast on 75 sts. with color 1 and work in Weaving Pattern with color 2. After Row 30, remove 48 sts. on the right (left for 2nd section) onto a stitch holder (be sure to note Pattern Row). Continue to knit over the 27 remaining sts. AND AT THE SAME TIME, on the LEFT (right) after Row 60, decrease 1 st. every 10th row 3x. After Row 90, cast on 40 sts. directly to the right (left) then REMOVE THE 27 sts. onto a stitch holder. Knit 60 rows in Pattern over the newly cast on sts. then remove the 40 sts. onto a stitch holder (pocket lining). Hang the 48 sts. held on stitch holder back onto the machine. Counter at 30. Knit in Pattern to Row 90 then bind off these sts. Hang the pocket lining (40 sts.) onto machine in place of the 48 you bound off and replace the 27 sts. held on stitch holder to the LEFT of these stitches. Put Counter at 90. Set at correct Pattern Row and continue over all the needles. ON SIDE EDGE decrease 1 st. at Row 90 and again every 10th row 3x more. Knit to Row 183. SHAPE ARMHOLE and work the COLOR STRIPES same as the back AT THE SAME TIME. For Armhole, bind off 4 sts. 2x, 3 sts. 1x, 2 sts. 2x. When color stripes are completed, ON ARM SIDE, increase 1 st. every 8th row 2x and AFTER ROW 242, SHAPE NECK: Bind off 4 sts. 1x, 3 sts. 2x, 2 sts. 2x, 1 st. 6x. After Row 265, SHAPE SHOULDER same as the back.

SLEEVES: III

Cast on 80 sts. with color 1 and work in Pattern with color 2. ON EACH SIDE, increase 1 st. every 6th row 20x. After Row 122, SHAPE CAP and AT THE SAME TIME, work the color stripes same as back and front. ON EACH SIDE, decrease 1 st. every 2nd row 35x. After Row 196, bind off the remaining sts.

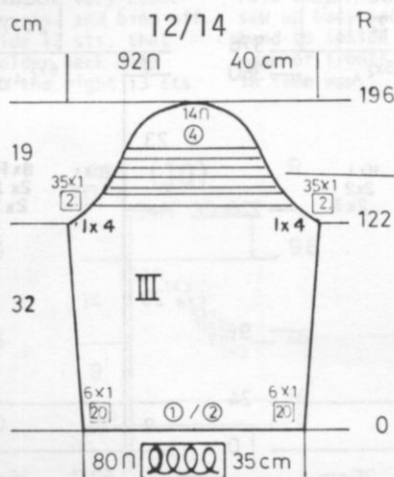
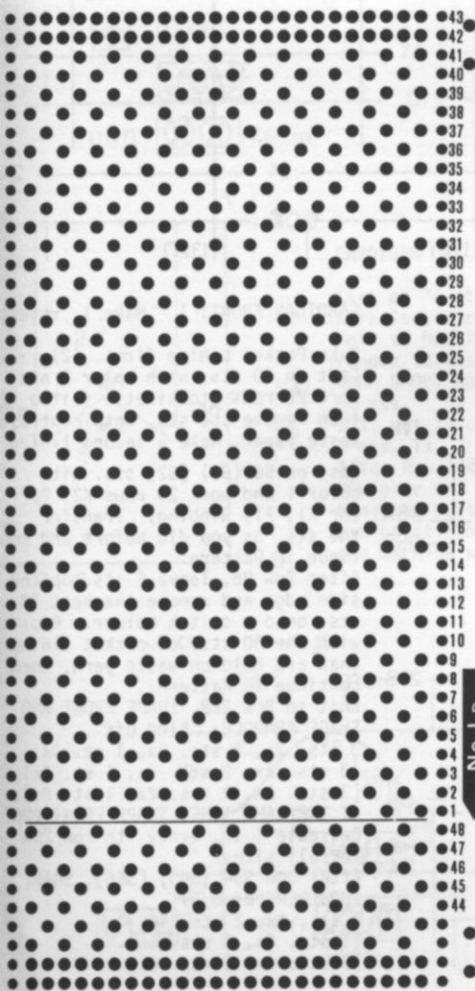

8 R ②
 8 R ③
 8 R ④
 8 R ⑤
 2 R ⑥
 8 R ⑦

dk 684

WOMAN'S TWIN SWEATER SET

SIZES: 8 (10) [12]

YARN: Crocus Crepe

GRAMS:

color 1 600 650 700

color 2 350 350 400

TENSION: 7 to 8

GAUGE:

Pat: 12 sts. 30 rows = 5 cm (2")

Stock: 13 1/2 sts. 18 rows = 5 cm (2")

A Tuck Stitch Pattern. Punch your own Card. Sleeve and Lower Bands are K2, P2, Ribbing (or K1, P1). The Collar and Front bands are Stockinette stitch.

FINISHING: See General Instructions.



CARDIGAN BACK: II

Cast on 120 (128) [132] sts. with color 1 and work 24 rows K2, P2 Ribbing (or K1, P1). Transfer the Ribber sts. to main machine and continue in Tuck Pattern working 4 rows color 1 and 4 rows color 2 and REPEAT for Pattern. Knit to Row 228. SHAPE ARMHOLE: ON EACH SIDE, bind off

3 sts. 2x, 2 sts. 2x, 1 st. 6x. (3 sts. 2x, 2 sts. 2x, 1 st. 8x). [3 sts. 2x, 2 sts. 2x, 1 st. 8x]. Knit to Row 354 (360) [366]. SHAPE SHOULDER and WATCH FOR NECK SHAPING. FOR SHOULDER, bind off ON EACH SIDE, 3 sts. 4x, 2 sts. 4x, (3 sts. 4x, 2 sts. 5x), [3 sts. 4x, 2 sts. 6x]. FOR NECK, after Row 364 (370) [376], put half the sts. on the left into holding position and complete the right side first. *ON NECK SIDE, bind off 14 sts. 1x, 3 sts. 2x, 2 sts. 2x. (Same as first size). [Same as first size]. Bring the needles on the left into working position, knit 1 row in Pattern to the left side, turn the Row Counter back to 364 (370) [376] and complete the left half. Follow the instructions from *.

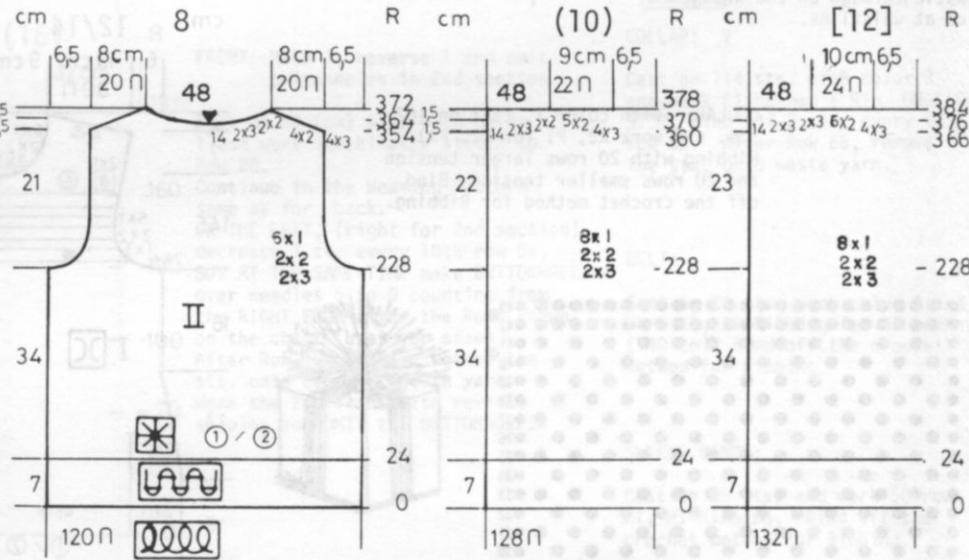
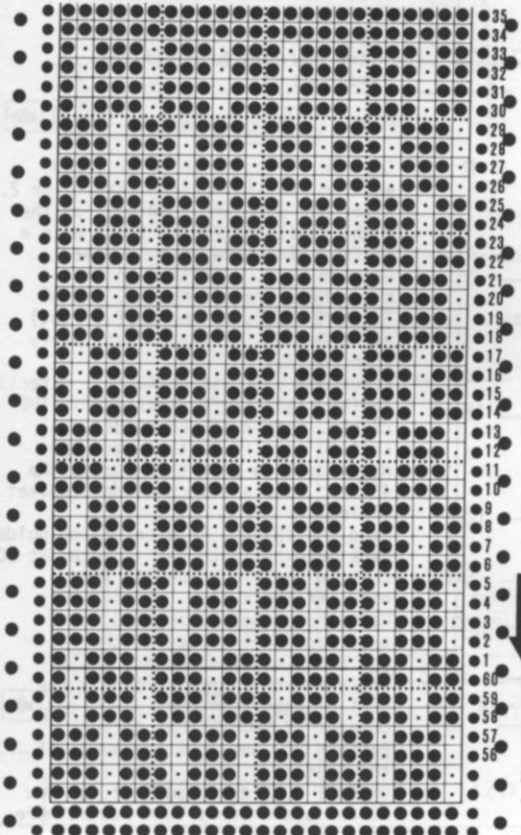

4 ROWS COLOR 1
4 ROWS COLOR 2

CARDIGAN FRONT: I Make 1, reverse

Make Pocket Lining first. (2) Cast on 30 sts. with color 1 and work 20 rows Stockinette stitch then remove the sts. onto contrast waste yarn. Make a second lining. Cast on 56 (60) [62] sts. with color 1 and work 24 rows K2, P2 (or K1, P1) Ribbing. Transfer the sts. as you did before and continue in Pattern. After Row 96, leave 6 sts. on the side edge and remove the next 30 sts. onto a stitch holder. Replace with the 30 sts. of pocket lining that are held on waste yarn, then continue in Pattern. Knit to Row 228. SHAPE FRONT AND SHAPE ARMHOLE: Bind off 3 sts. 2x, 2 sts. 2x, 1 st. 6x, (3 sts. 2x, 2 sts. 2x, 1 st. 8x), [3 sts. 2x, 2 sts. 2x, 1 st. 8x]. AT THE SAME TIME, SHAPE FRONT EDGE. Decrease 1 st. every 7th row 20x for all sizes. After Row 354 (360) [366], SHAPE SHOULDER: Bind off 3 sts. 4x, 2 sts. 4x. (3 sts. 4x, 2 sts. 5x). [3 sts. 4x, 2 sts. 6x].

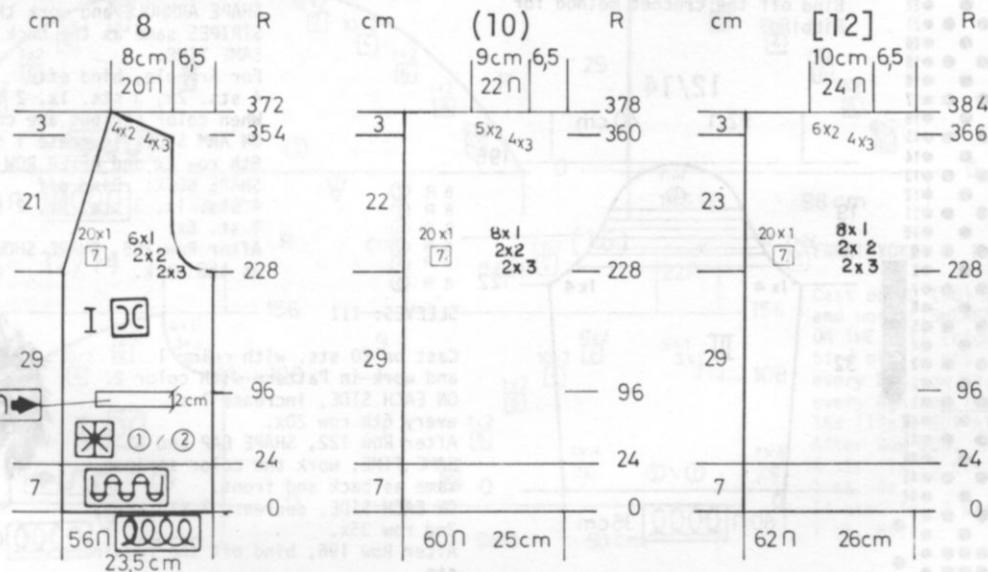

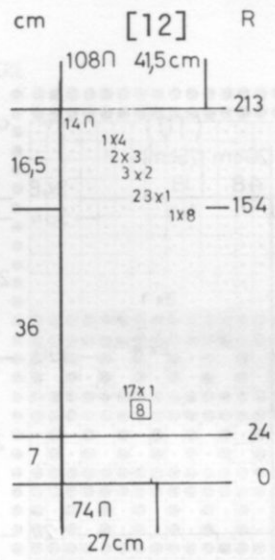
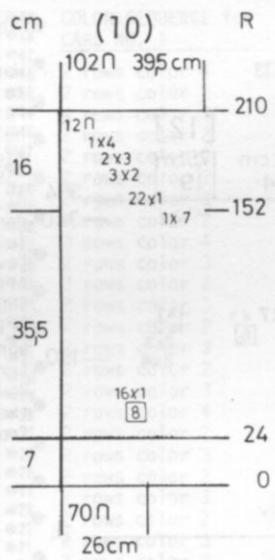
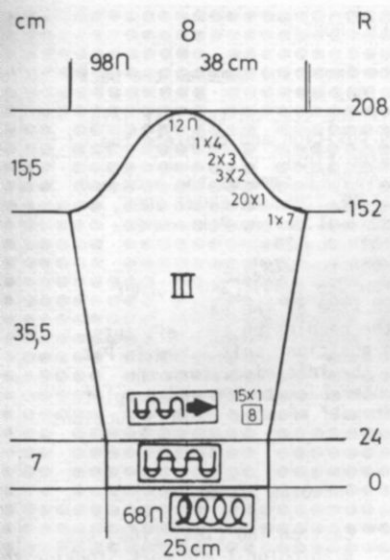

CARDIGAN SLEEVES: III
 Cast on 68 (70) [74] sts. with color 1 and work 24 rows K2, P2 (or K1, P1) Ribbing. Transfer the ribber sts. as you did before and continue in Stockinette stitch.
 ON EACH SIDE, increase 1 st. every 8th row 15x (16x) [17x].
 After Row 152 (152) [154], SHAPE CAP:
 ON EACH SIDE, bind off
 7 sts. 1x, 1 st. 20x, 2 sts. 3x, 3 sts. 2x, 4 sts. 1x.
 (7 sts. 1x, 1 st. 22x, 2 sts. 3x, 3 sts. 2x, 4 sts. 1x).
 [8 sts. 1x, 1 st. 23x, 2 sts. 3x, 3 sts. 2x, 4 sts. 1x].
 After Row 208 (210) [214], bind off the remaining sts.

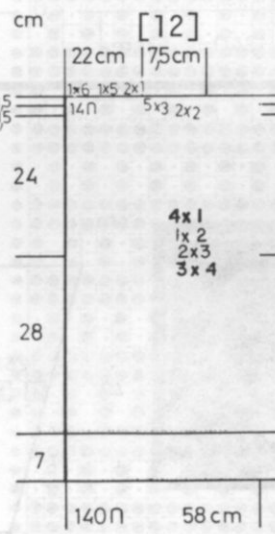
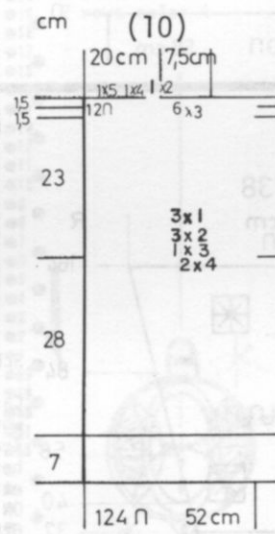
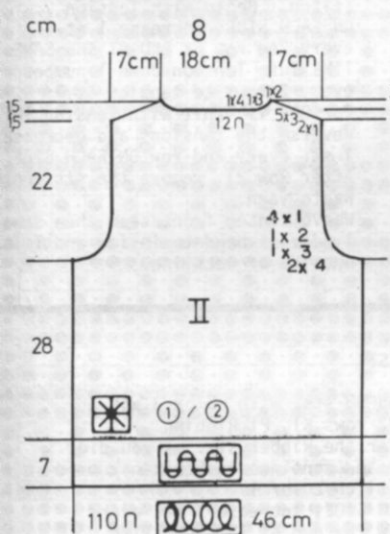

PULLOVER BACK: II
 Cast on 110 (124) [140] sts. with color 1 and work 24 rows K2, P2 (or K1, P1) Ribbing. Transfer the Ribber sts. to main machine and continue in Pattern.
 Knit to Row 190.
 SHAPE ARMHOLE: ON EACH SIDE bind off 4 sts. 2x, 3 sts. 1x, 2 sts. 1x, 1 st. 4x.
 (4 sts. 2x, 3 sts. 1x, 2 sts. 3x, 1 st. 3x).
 [4 sts. 3x, 3 sts. 2x, 2 sts. 1x, 1 st. 4x].
 Knit to Row 328 (334) [340].
 SHAPE SHOULDER and watch for NECK SHAPING.
 FOR SHOULDER, ON EACH SIDE bind off
 1 st. 2x, 3 sts. 5x,
 (3 sts. 6x),
 [2 sts. 2x, 3 sts. 5x],
 AT THE SAME TIME, after Row 336 (342) [348], put half the sts. on the left into holding position and complete the right side first.

*ON NECK SIDE, bind off
 12 (12) [14] sts. 1x, then
 4 sts. 1x, 3 sts. 1x, 2 sts. 1x.
 (5 sts. 1x, 4 sts. 1x, 2 sts. 1x).
 [6 sts. 1x, 5 sts. 1x, 1 st. 2x].
 Bring the needles on the left into working position, knit 1 row in Pattern to the left side, turn the Row Counter back to 336 (342) [348] and complete the left half. Follow the instructions from * but don't forget to complete the shoulder shaping.

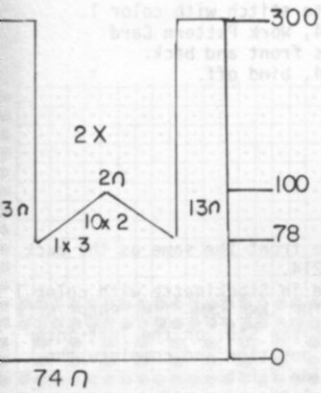

CARDIGAN COLLAR & FRONT BANDS. (2)
 Cast on 74 sts. with color 1 and work Stockinette stitch.
 Knit to Row 78. ON EACH SIDE, remove 13 sts. onto a stitch holder.
 WORK SHORT ROWS over the remaining 50 sts. ON OPPOSITE SIDE OF CAM BOX, put into holding position 3 sts. 1x, 2 sts. 10x ON EACH SIDE.
 After Row 100, knit 1 very LOOSE ROW over all the sts. and bind off.
 Hang the left side 13 sts. that are on stitch holder back onto the machine with the right 13 sts.

directly next to it on the RIGHT. Continue in Stockinette stitch to Row 302, then bind off.
 Make a 2nd section the same.
 Fold collar sections in half and sew up back seam. Sew 1 edge of band to inside and 1 to outside edge of fronts and sew on collar in same way.

SLEEVES: III
 Cast on 90 (94) [100] sts. with color 1 and work 14 rows K2, P2 (or K1, P1) Ribbing. Transfer the ribber sts. as you did before and continue in Stockinette stitch.
 Knit to Row 46.
 SHAPE CAP: ON EACH SIDE, bind off 3 sts. 1x, 1 st. 8x, 2 sts. 4x, 1 st. 5x, 2 sts. 6x, 3 sts. 1x, (3 sts. 1x, 1 st. 8x, 2 sts. 5x, 1 st. 5x, 2 sts. 6x, 3 sts. 1x).
 [3 sts. 1x, 1 st. 9x, 2 sts. 6x, 1 st. 5x, 2 sts. 6x, 3 sts. 1x].
 After Row 96 (98) [102], bind off the remaining sts.

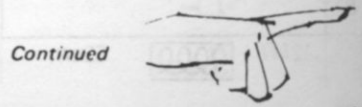
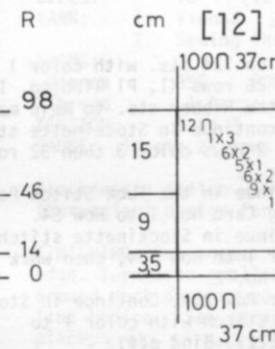
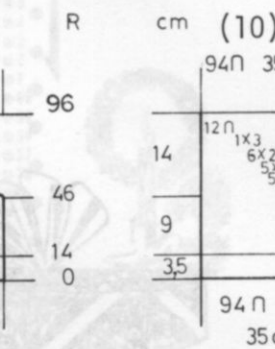
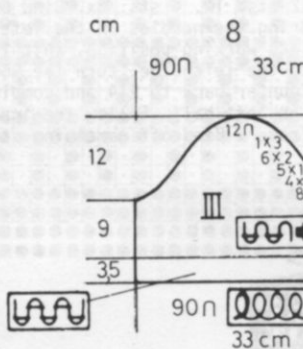

Continued

dk 684

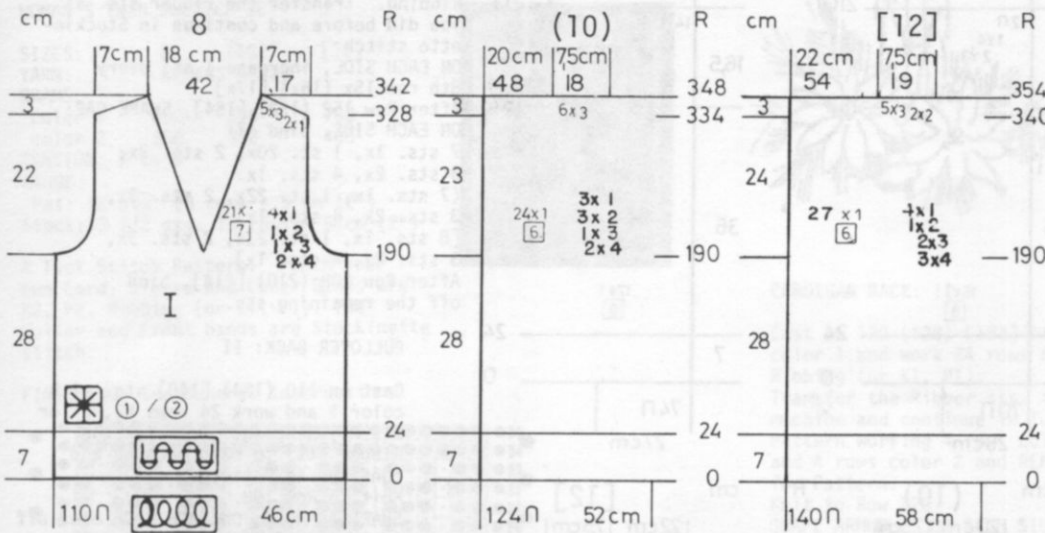

PULLOVER FRONT:

Work the front the same as the back to Row 190.
Put half the sts. on the left into holding position and complete the right side first.
*SHAPE ARMHOLE same as the back and AT THE SAME TIME, ON FRONT EDGE, decrease 1 st. every 7th row 21x (every 6th row 24x) [every 6th row 27x].
After row 328 (334) [340], SHAPE SHOULDER same as the back.
Bring the needles on the left into working position, knit 1 row in Pattern to the left side, turn the Row Counter back to 190 and complete the left half. Follow the instructions from *.

PULLOVER NECKBAND:

Cast on 160 (164) [168] sts. with color 1 and work Stockinette stitch. Begin with Tension 7. ON EACH SIDE, increase 1 st. every 2nd row 5x AND AT THE SAME TIME Turn Tension down 1 number every 2 rows to tension 5.
For ROW 11, knit with tension 10. Reverse the tensions and decrease 1 st. every 2nd row ON EACH SIDE. After Row 21, remove the sts. onto waste yarn.
Weave center front seam then sew 1 edge of band to inside and 1 to outside of neckline.

np 685

MAN'S PULLOVER

SIZES: 36/38
YARN: Crocus Crepe
GRAMS:
color 1 400
color 2 200
color 3 200
color 4 50
TENSION: 8 to 10
GAUGE: 12 sts. 16 rows = 5 cm (2")

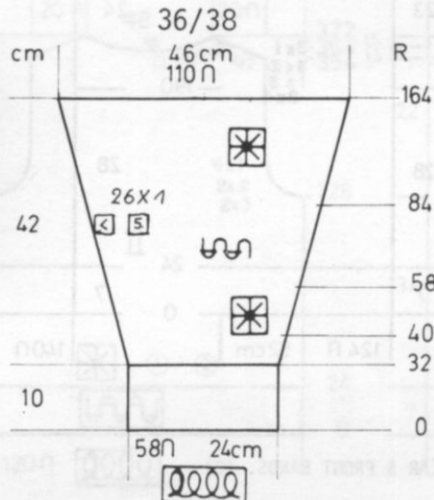

SLEEVES:

Cast on 58 sts. with color 3 and work 32 rows K1, P1 Ribbing. Transfer the Ribber sts. as you did before and continue in Stockinette stitch color 1.
ON EACH SIDE, increase 1 st. every 6th row 26x and AT THE SAME TIME, after Row 40, work Pattern Card No. 3 and after Row 58, continue in Stockinette stitch with color 1. After Row 84, Work Pattern Card No. 2 same as front and back. After Row 164, bind off.

A Tuck Stitch Pattern. Punch your own Cards and follow the color sequence as given. Bands are K1,P1 Ribbing.

FINISHING: Sew General Instructions. Sew Shoulder seams then sew on Neckband. Facing and sew to inside.

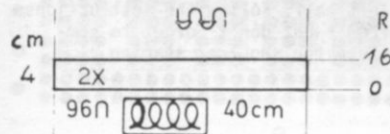

NECK FACING: Make 2.

Cast on 96 sts. with color 1 and work Stockinette stitch to Row 16. Bind off.

FRONT:

Work the front the same as the back to Row 214.
Continue in Stockinette with color 1 and AT THE SAME TIME SHAPE NECK. Put half the Sts. on the left into holding position and complete the right side first.
*ON NECK SIDE, bind off 12 sts. 1x, 4 sts. 3x. Bind off. Bring the needles on the left into working position, knit 1 row to the left side, turn the Row Counter back to 214 and complete the left half. Follow the instructions from *. Bind off remaining sts.

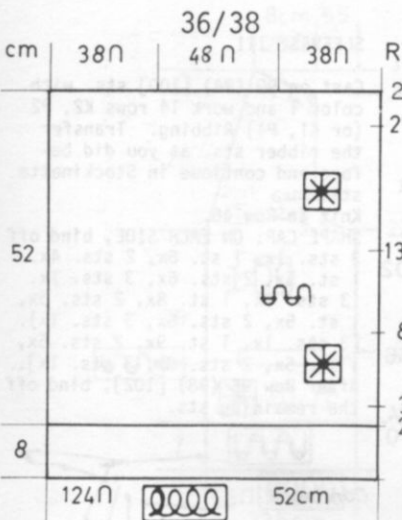

BACK:

Cast on 124 sts. with color 1 and work 26 rows K1, P1 Ribbing. Transfer the Ribber sts. to main machine and continue in Stockinette stitch. Knit 2 rows color 3 then 32 rows color 1.
Continue in the Tuck Stitch Pattern using Card No. 1 to Row 84.
Continue in Stockinette stitch with color 1 to Row 134, then work Card No. 2.
After Row 214, Continue in Stockinette stitch with color 1 to Row 222. Bind off.



dk 686

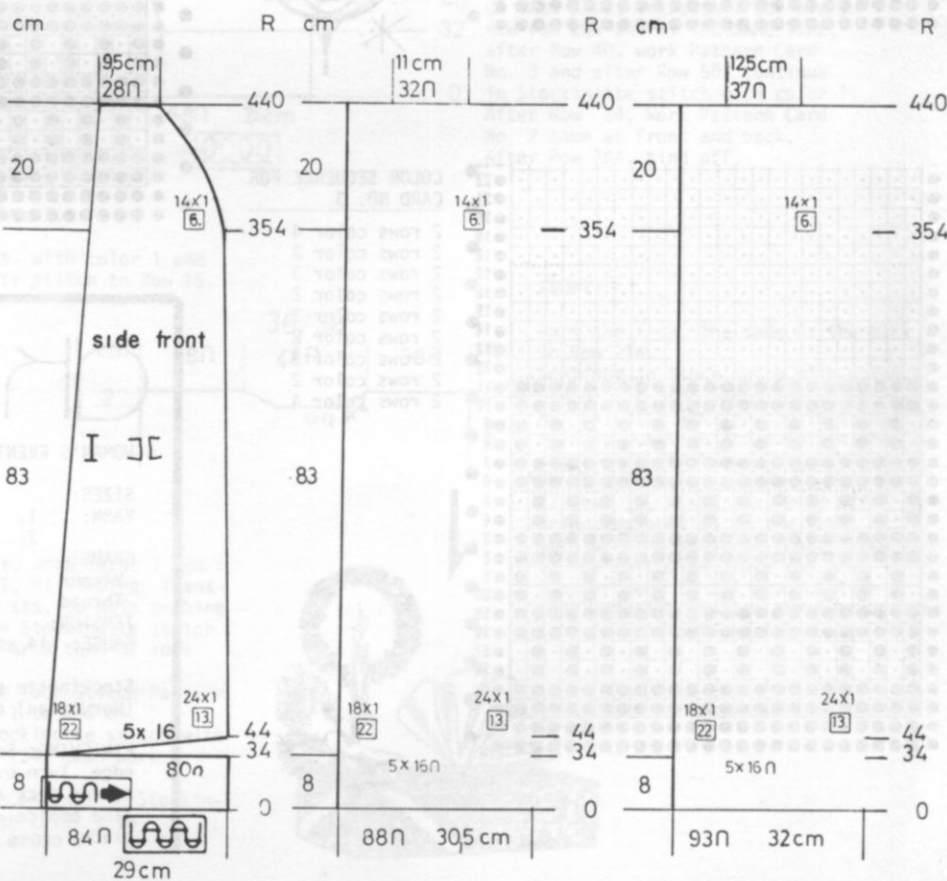
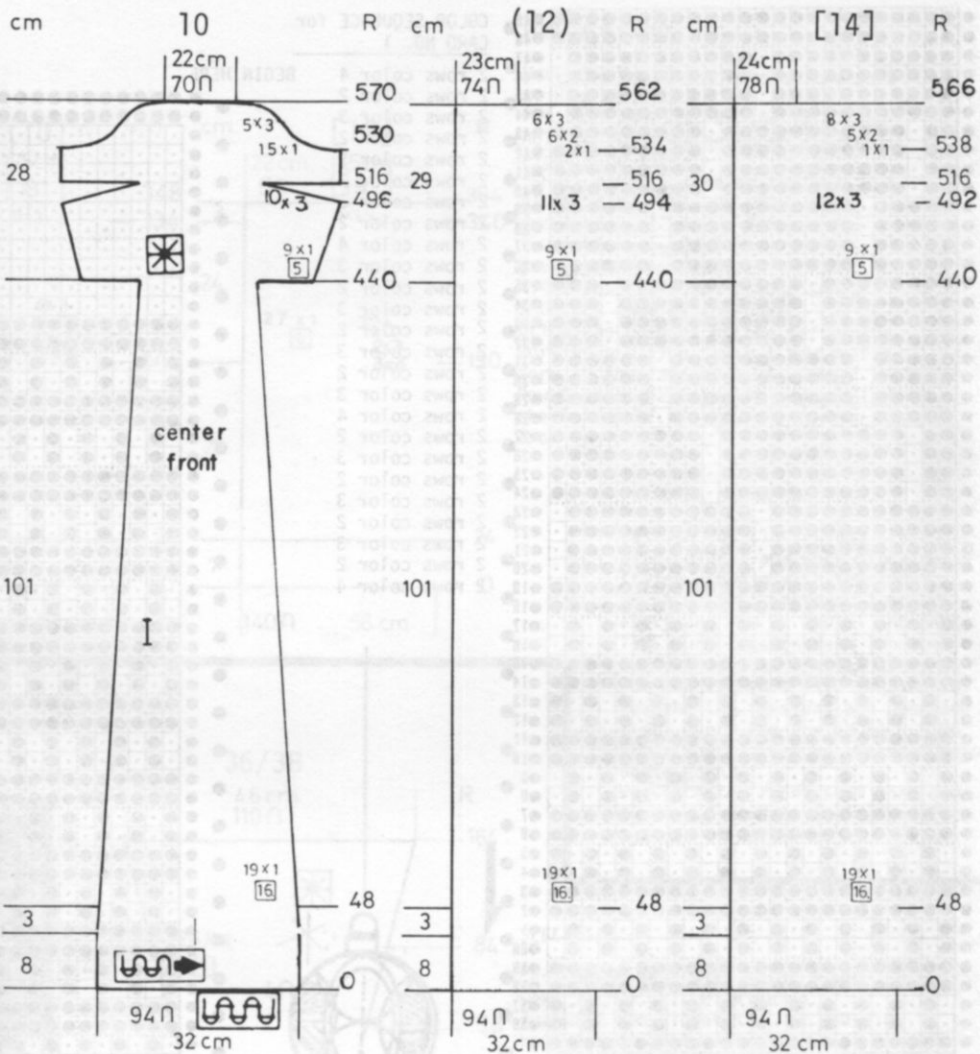
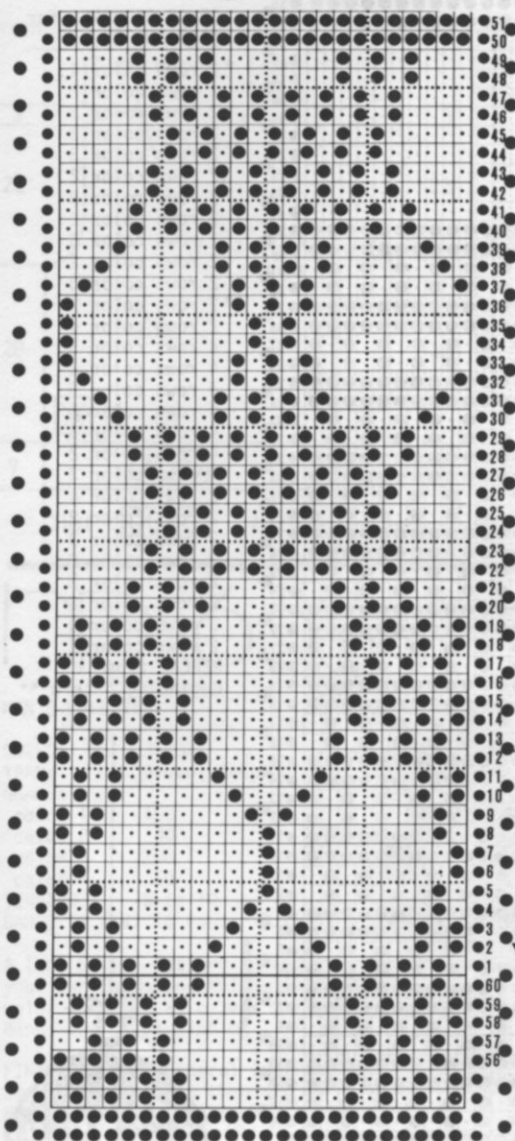

KNIT ALL SIDE SECTIONS FIRST.

FRONT SIDE SECTION Make 1. reverse 1.

Cast on 84 (88) [93] sts. with yarn 1 and work Stockinette stitch.
 Knit to Row 33. Work SHORT ROWS. ON OPPOSITE SIDE OF CAM BOX put into holding position 80 sts.
 Bring back into working position, 16 sts. 5x.
 After Row 44, ON THE RIGHT (left for 2nd section) decrease 1 st. every 13th row 24x and on the LEFT (right for 2nd section), decrease 1 st. every 22nd row 16x.
 After Row 354, on the Right (left), decrease 1 st. every 6th row 14x.
 After Row 440, remove the remaninst 28 (32) [37] sts. onto waste yarn. Make 2nd section with reverse shaping. It is easier for you if you put Counter at 0 on the LEFT after Casting on.

INTER FRONT:
 Cast on 94 sts. with yarn 1 and work Stockinette stitch.
 Knit to Row 48.
 ON EACH SIDE, decrease 1 st. every 16th row 19x.
 After Row 440, hang the SIDE FRONTS onto EACH SIDE and remove the waste yarn.
 CONTINUE IN PATTERN.
 ON EACH SIDE, increase 1 st. every 7th row 9x.
 After Row 496 (494) [492], work SHORT ROWS for the BUST DARTS. ON OPPOSITE SIDE OF CAM BOX, put into holding position 3 sts. 10x. (sts. 11x) [3 sts. 12x] bringing all the needles back into working position before knitting the next 2 rows.
 Knit to Row 530 (534) [538].
 ON EACH SIDE, bind off 1 st. 15x, 3 sts. 5x. (sts. 2x, 2 sts. 6x, 3 sts. 6x). (sts. 1x, 2 sts. 5x, 3 sts. 6x).
 After Row 570 (562) [566], bind off the remaining sts.

TRAPS: Make 2.
 Cast on 20 sts. with yarn 1 and work 170 rows Stockinette stitch. Bind off. Fold straps in half with right sides together, sew seam, turn to the right side.

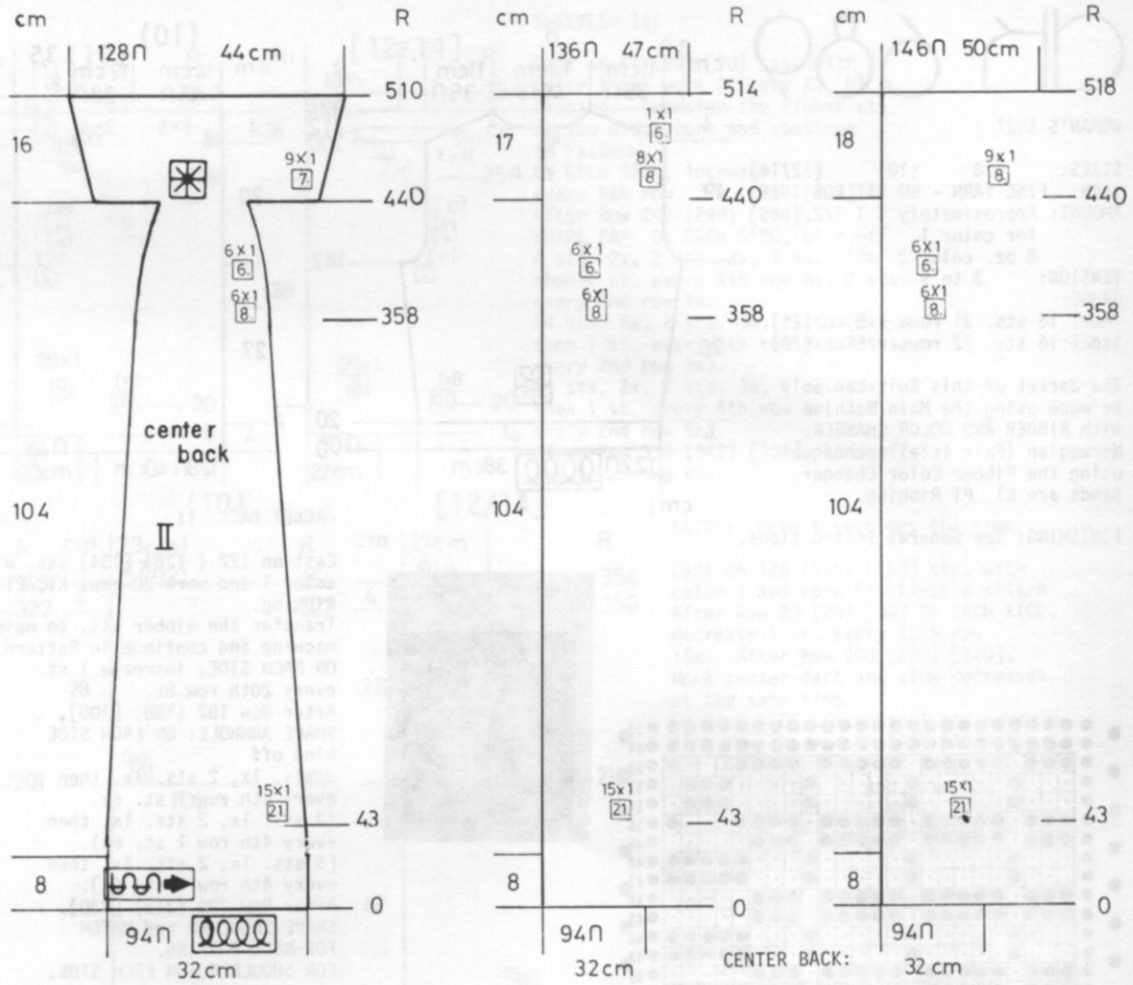

CENTER BACK: 32 cm
 Cast on 94 sts. with yarn 1 and work Stockinette stitch.
 Knit to Row 42.
 ON EACH SIDE, decrease 1 st. every 21st row 15x.
 After Row 358, ON EACH SIDE, decrease 1 st. every 8th row 6x, every 6th row 6x.
 After Row 440, hang the SIDE BACKS onto EACH SIDE and remove the waste yarn.
 CONTINUE IN PATTERN.
 ON EACH SIDE, increase 1 st. every 7th row 9x.
 (every 8th row 8x, every 6th row 1x). [every 8th row 9x].
 After Row 510 (514) [518], bind off the remaining sts.

BACK SIDE SECTIONS. Make 1, reverse 1.
 Cast on 84 (88) [94] sts. with yarn 1 and work Stockinette stitch.
 After Row 33, WORK SHORT ROWS. ON OPPOSITE SIDE OF CAM BOX, put into holding position, 80 sts. Bring back into working position, 16 sts. 5x.
 After Row 44, on the RIGHT (left for 2nd section), decrease 1 st. every 16th row 19x and ON THE LEFT (right for 2nd section) decrease 1 st. every 22nd row 18x.
 After Row 354, on the RIGHT (left) decrease 1 st. every 8th row 6x, every 6th row 8x.
 After Row 440, remove the remaining 35 (39) [44] sts. onto waste yarn. Work 2nd section with reverse Shaping. (Put Row Counter at 0 on the left side to make it easier for you.)

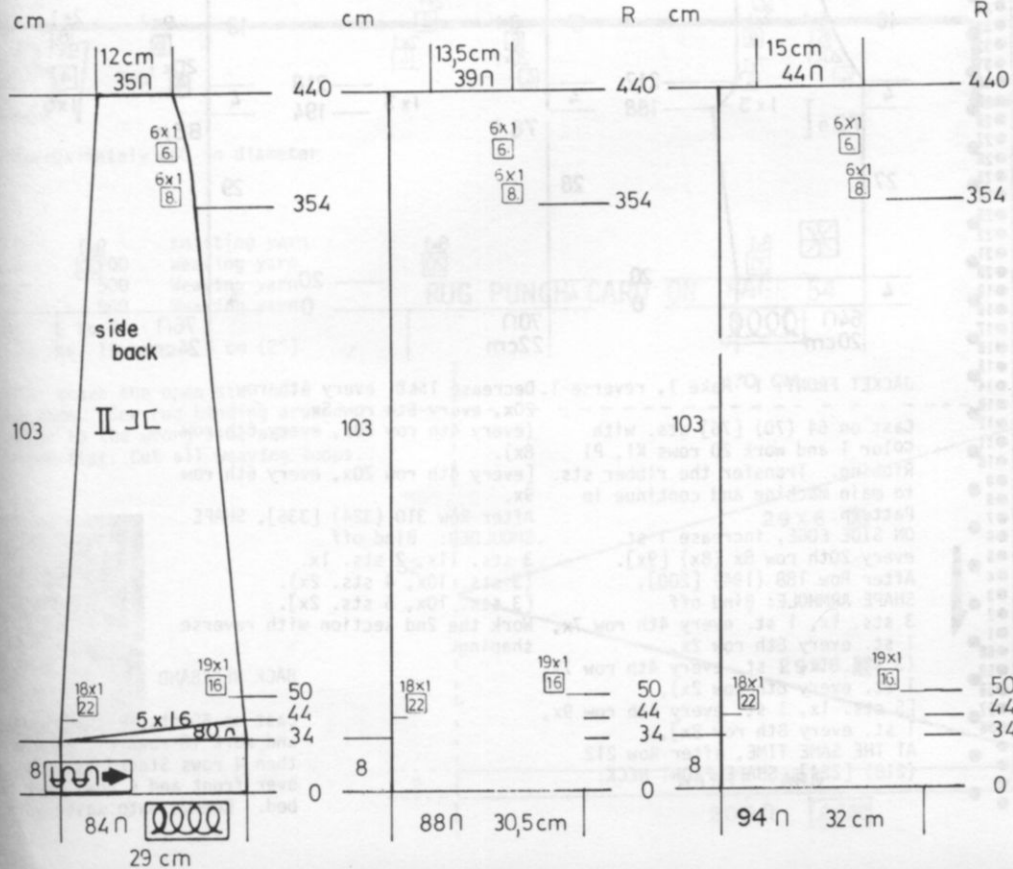

dk 689

WOMAN'S SUIT

SIZES: 8 (10) [12/14]
 YARN: FINE YARN - NO KIT FOR THIS
 AMOUNT: Approximately 1 1/2 lbs.
 for color 1
 8 oz. color 2
 TENSION: 3 to 5
 GAUGE:

Nor. 16 sts. 31 rows = 5 cm (2")
 Stock: 16 sts. 22 rows = 5 cm (2")

The Jacket of this Suit can only be made using the Main Machine with RIBBER AND COLOR CHANGER. Norwegian (Fair Isle) technique using the Ribber Color Changer. Bands are K1, P1 Ribbing.

FINISHING: See General Instructions.

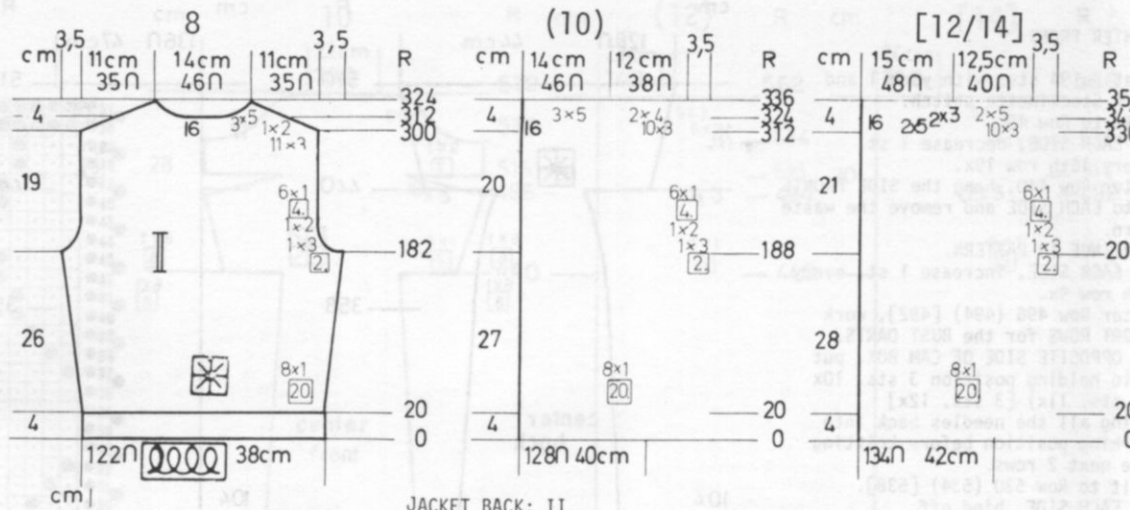

JACKET BACK: II

Cast on 122 (128) [134] sts. with color 1 and work 20 rows K1, P1 Ribbing. Transfer the Ribber sts. to main machine and continue in Pattern. ON EACH SIDE, increase 1 st. every 20th row 8x. After Row 182 (188) [200], SHAPE ARMHOLE: ON EACH SIDE bind off 3 sts. 1x, 2 sts. 1x, then every 4th row 1 st. 6x. (3 sts. 1x, 2 sts. 1x, then every 4th row 1 st. 6x). [3 sts. 1x, 2 sts. 1x, then every 4th row 1 st. 6x]. After Row 300 (312) [330], SHAPE SHOULDER AND WATCH FOR NECK SHAPING. FOR SHOULDER, ON EACH SIDE,

bind off 3 sts. 11x, 2 sts. 1x, (3 sts. 10x, 4 sts. 2x), [3 sts. 10x, 5 sts. 2x], FOR NECK: After Row 312 (324) [342], bind off the center 16 sts., put the needles on the left into holding position and complete the right side first. *ON NECK SIDE, bind off 5 sts. 3x. (5 sts. 3x). [5 sts. 2x, 3 sts. 2x]. Bring the needles on the left into working position, knit 1 row in Pattern to the left side, turn the Row Counter back to 312 (324) [342] and complete the left half. Follow the instructions from * but don't forget to complete the shoulder shaping.

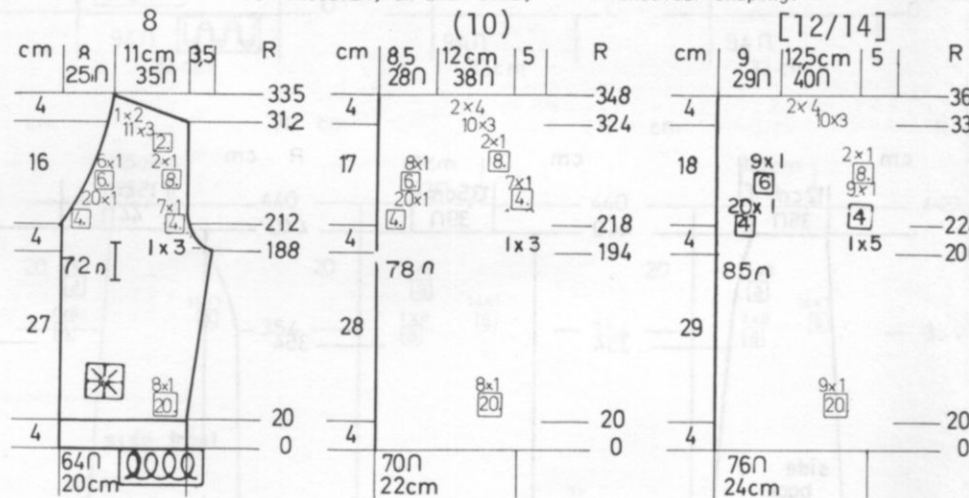
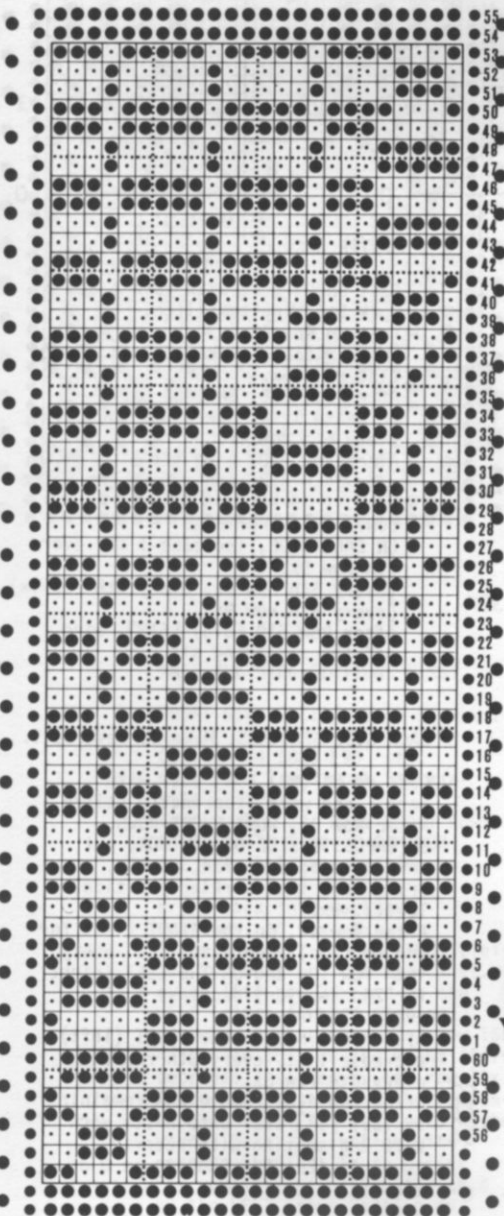

JACKET FRONT: I Make 1, reverse 1. Decrease 1 st. every 4th row

20x, every 6th row 5x. (every 4th row 20x, every 6th row 8x). [every 4th row 20x, every 6th row 9x]. After Row 310 (324) [336], SHAPE SHOULDER: Bind off 3 sts. 11x, 2 sts. 1x. (3 sts. 10x, 4 sts. 2x). [3 sts. 10x, 5 sts. 2x]. Work the 2nd section with reverse shaping.

BACK NECKBAND

Cast on 60 sts. with color 1 and work 18 rows K1, P1 Ribbing then 4 rows Stockinette stitch over front and 4 rows over back bed. Remove onto waste yarn.

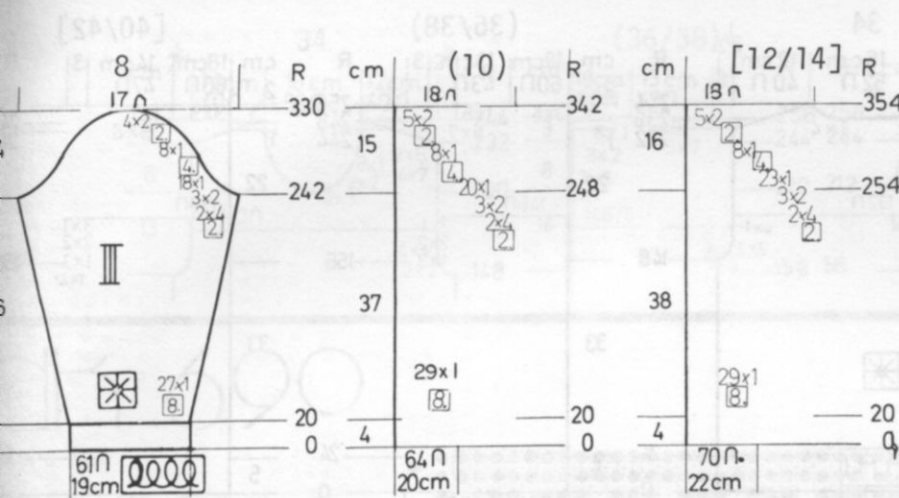

SLEEVES: III

Cast on 61 (64) [70] sts. with color 1 and work 20 rows K1, P1 Ribbing. Transfer the ribber sts. as you did before and continue in Pattern.
 ON EACH SIDE, increase 1 st. every 8th row 27x (29x) [29x]. After Row 242 (248) [254], SHAPE CAP: ON EACH SIDE, bind off 4 sts. 2x, 2 sts. 3x, 1 st. 18x then 1 st. every 4th row 8x, 2 sts. every 2nd row 4x. (4 sts. 2x, 2 sts. 3x, 1 st. 20x, then 1 st. every 4th row 8x, 2 sts. every 2nd row 5x). [4 sts. 2x, 2 sts. 3x, 1 st. 23x, then 1 st. every 4th row 8x, 2 sts. every 2nd row 5x]. After Row 330 (342) [354], bind off the remaining sts.

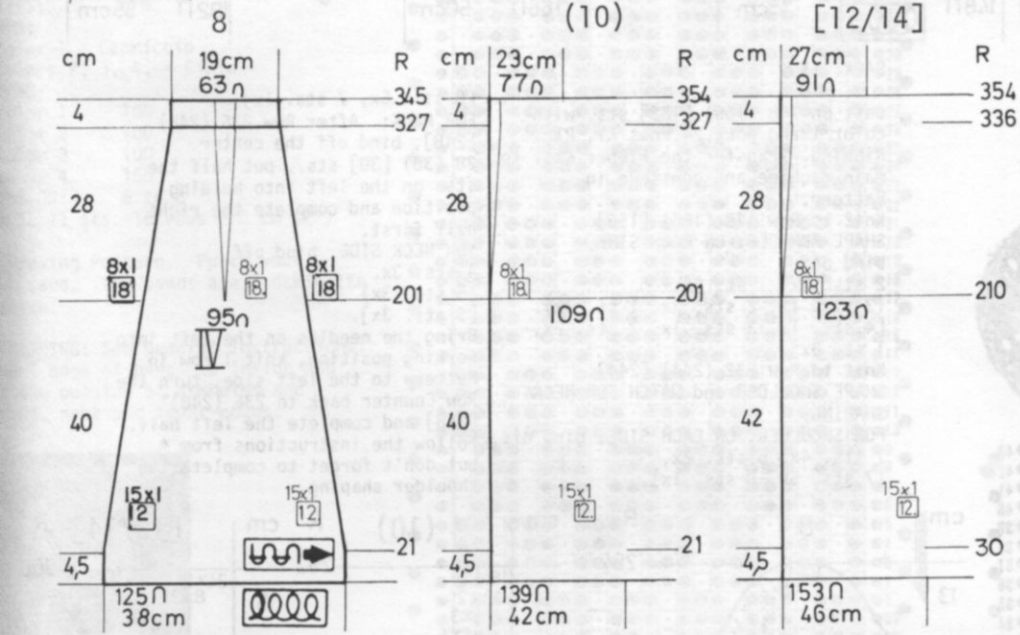

SKIRT: Make 4 sections the same.

Cast on 125 (139) [153] sts. with color 1 and work Stockinette stitch. After Row 20 (20) [30] ON EACH SIDE, decrease 1 st. every 12th row 15x. After Row 200 (200) [210], Work center dart and side decreases at the same time. ON EACH SIDE, decrease 1 st. every 18th row 8x and ON EACH SIDE of the CENTER stitch, decrease 1 st. every 18th row 8x and move the sts. in to fill the empty needles. After Row 344 (354) [354], bind off the remaining sts. loosely.

BUTTONHOLE & BUTTON BAND.

Cast on 200 sts. with color 1 and work K1, P1 Ribbing. After Row 8, make BUTTONHOLES over needles 7 to 11, 32 to 36, 57 to 61, 82 to 86, 107 to 111, 132 to 136. Knit to Row 18, then work 4 rows Stockinette stitch over front bed and 4 rows over back bed. Remove onto waste yarn. Omit the BUTTONHOLES in second section.

587 RUG

SIZE: Approximately 60" in diameter

- Color 1 Knitting yarn.
 - Color 2 1200 Weaving yarn
 - Color 3 500 Weaving yarn
 - Color 4 500 Weaving yarn
- FINISHING: Weave the open sts. held waste yarn. Sew rug binding around edges, turn to the wrong side and stitch down flat. Cut all weaving loops.

RUG PUNCH CARD ON PAGE 54

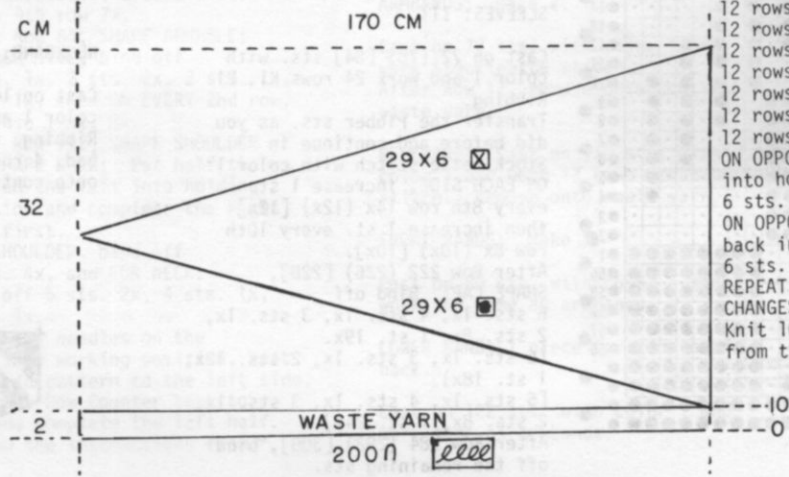

With contrast waste yarn, cast on 200 sts. Knit 10 rows. Change to color 1 and begin Pattern with SHORT ROWS. AT THE SAME TIME, change the weaving colors as follows, and REPEAT. Counter 0.
 12 rows color 2
 12 rows color 3
 12 rows color 2
 12 rows color 4
 12 rows color 2
 12 rows color 4
 12 rows color 2
 12 rows color 3
 12 rows color 2
 ON OPPOSITE SIDE OF CAM BOX, put into holding position, 6 sts. 29x.
 ON OPPOSITE SIDE OF CAM BOX, bring back into working position 6 sts. 29x.
 REPEAT THE SHORT ROWS AND COLOR CHANGES 16x MORE.
 Knit 10 rows waste yarn and remove from the machine.



hp 6000

MAN'S PULLOVER

SIZES: 34 (36/38) [40/42]
YARN: Amore

GRAMS:
color 1 400 400 450
color 2 150 150 150
color 3 50 50 50

TENSION: 5 to 7

GAUGE: Nor. (Fair Isle) -16 sts. 20 rows
= 5 cm (2")

Stock: 16 sts. 23 rows = 5 cm (2")

A Norwegian Design. Punch your own Card. The bands are K1, P1 Ribbing.

FINISHING: See General Instructions.
Sew 1 edge of neckband to outside and 1 to inside of neckline.

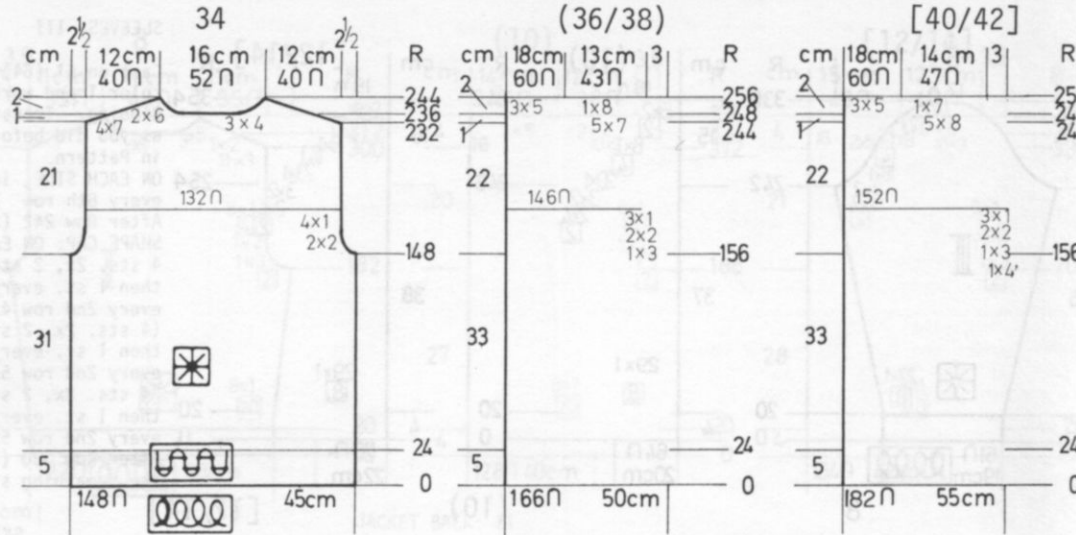

BACK: II

Cast on 148 (166) [182] sts. with color 1 and work 24 rows K1, P1 Ribbing. Transfer the ribber sts. to main machine and continue in Pattern.

Knit to Row 148 (156) [156]. SHAPE ARMHOLE: ON EACH SIDE, bind off

2 sts. 2x, 1 st. 4x.
(3 sts. 1x, 2 sts. 2x, 1 st. 3x).
[4 sts. 1x, 3 sts. 1x, 2 sts. 2x, 1 st. 3x].

Knit to Row 232 (244) [244]. SHAPE SHOULDER and WATCH FOR NECK SHAPING.

FOR SHOULDER, ON EACH SIDE, bind off 7 sts. 4x, 6 sts. 2x, (7 sts. 5x, 8 sts. 1x),

[8 sts. 5x, 7 sts. 1x],
FOR NECK: After Row 236 (248) [248], bind off the center 28 (30) [30] sts., put half the sts. on the left into holding position and complete the right half first.

*ON NECK SIDE, bind off 4 sts. 3x.

(5 sts. 3x).
[5 sts. 3x].

Bring the needles on the left into working position, knit 1 row in Pattern to the left side, turn the Row Counter back to 236 (248) [248] and complete the left half. Follow the instructions from * but don't forget to complete the shoulder shaping.

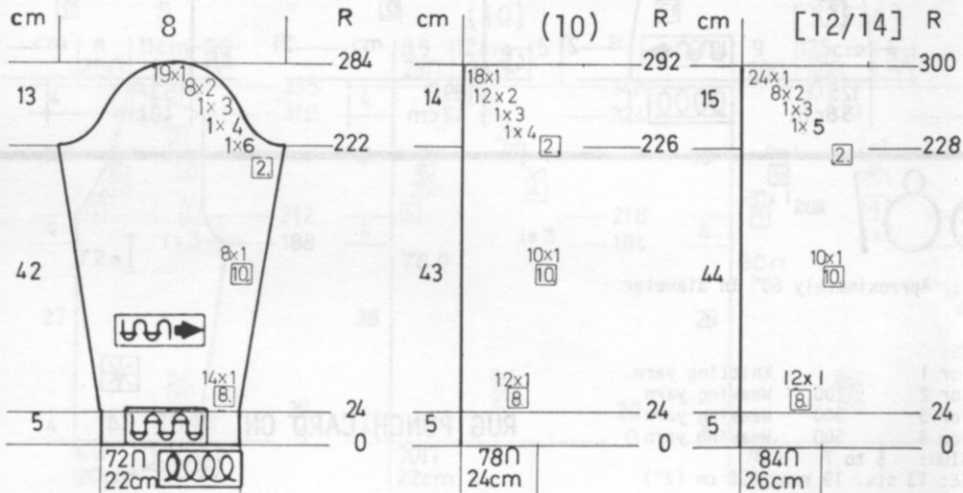
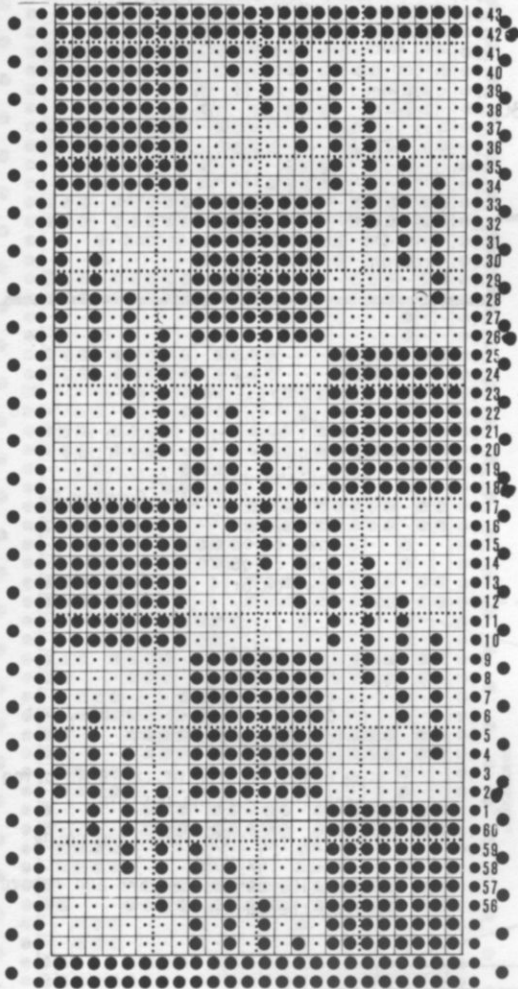

SLEEVES: III

Cast on 72 (78) [84] sts. with color 1 and work 24 rows K1, P1 Ribbing.

Transfer the ribber sts. as you did before and continue in Stockinette stitch with color 1 ON EACH SIDE, increase 1 st. every 8th row 14x (12x) [12x] then increase 1 st. every 10th row 8x (10x) [10x].

After Row 222 (226) [228],

SHAPE CAP: Bind off 6 sts. 1x, 4 sts. 1x, 3 sts. 1x, 2 sts. 8x, 1 st. 19x.
(5 sts. 1x, 3 sts. 1x, 2 sts. 12x, 1 st. 18x).

[5 sts. 1x, 4 sts. 1x, 3 sts. 1x, 2 sts. 8x, 1 st. 24x].
After Row 284 (292) [300], bind off the remaining sts.

NECKBAND:

Cast on 148 (154) [160] sts. with color 1 and work 20 rows K1, P1 Ribbing, then work 4 rows on front bed, 4 rows back bed and remove onto contrast waste yarn.



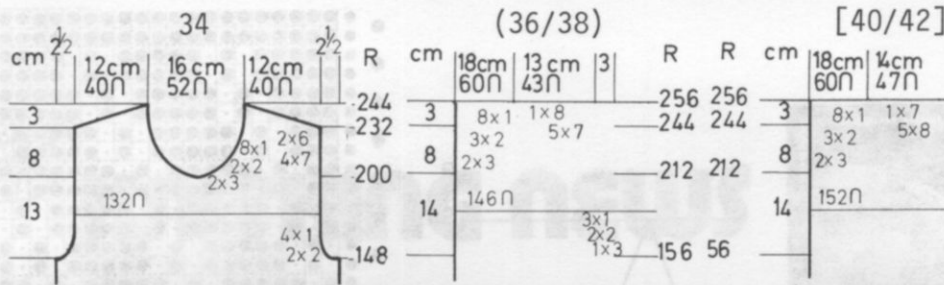

FRONT: I

Work the front the same as the back to Row 148 (156) [156].
 SHAPE ARMHOLE same as the back then knit to Row 200 (212) [212]. Bind off the center 16 (20) [20] sts., put the needles on the left into holding position and complete the right side first.
 *ON NECK SIDE, bind off 3 sts. 2x, 2 sts. 2x, 1 st. 8x. (3 sts. 2x, 2 sts. 3x, 1 st. 8x). [3 sts. 2x, 2 sts. 3x, 1 st. 8x]. After Row 232 (244) [244], SHAPE SHOULDER same as the back. Bring the needles on the left into working position, knit 1 row in Pattern to the left side, turn the Row Counter back to 200 (212) [212] and complete the left half. Follow the instructions from *.

DK 690

WOMAN'S VEST

SIZES: 6/8
 YARN: Color 1 = Capriccio
 Colors 2, 3, 4, = Binia
 RAMS: color 1 100
 color 2 100
 color 3 100
 color 4 150
 TENSION: 6 to 8
 GAUGE: 11 sts. 16 rows = 5 cm (2")

Weaving Pattern. Punch your own card. The bands are Stockinette stitch.

FINISHING: See General Instructions. Sew 1 edge of bands to inside and 1 edge to the outside of armholes and front, neck and lower edges.

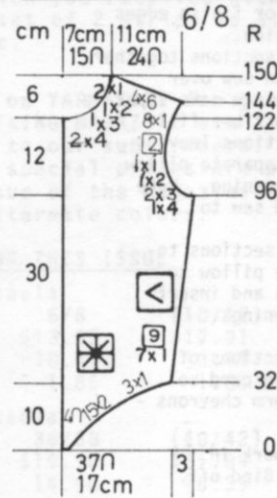
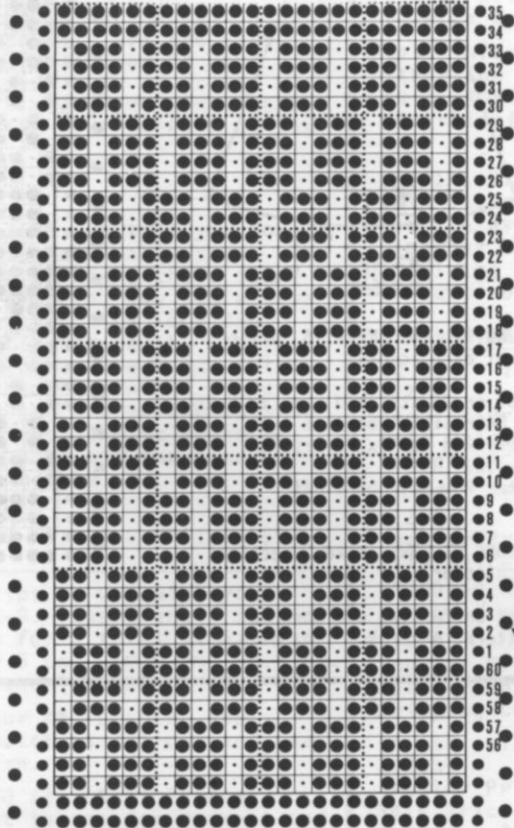

FRONT: I Make 1, reverse 1.

Cast on 37 sts. with color 1 and work in Pattern.
 ON THE RIGHT (left for 2nd section), cast on 2 sts. 15x, 1 st. 3x.
 After Row 32, ON SIDE EDGE, increase 1 st. every 9th row 7x.
 After Row 96, SHAPE ARMHOLE: Bind off 4 sts. 1x, 3 sts. 2x, 2 sts. 1x, 1 st. 1x, then on every 2nd row, increase 1 st. 8x.
 After Row 121, SHAPE NECK: Bind off 4 sts. 2x, 3 sts. 1x, 2 sts. 1x, 1 st. 2x, and SHAPE SHOULDER same as the back after Row 144.
 Work the 2nd section with reverse shaping.

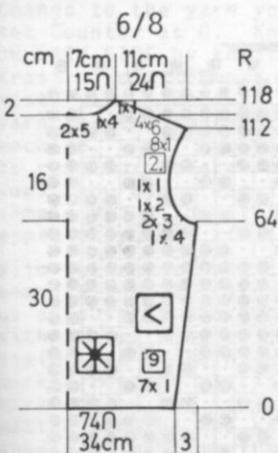

BACK: II

Cast on 74 sts. with color 1 and work in WEAVING PATTERN, with REPEATED COLOR STRIPES of 4 ROWS with color 2, 3, and 4.
 ON EACH SIDE, increase 1 st. every 9th row 7x.
 After Row 64, SHAPE ARMHOLE: ON EACH SIDE, bind off 4 sts. 1x, 3 sts. 2x, 2 sts. 1x, 1 st. 1x, then ON EVERY 2nd row, increase 1 st. 8x.
 After Row 112, SHAPE SHOULDER and SHAPE NECK; Put half the sts. on the left into holding position and complete the right side first.
 *FOR SHOULDER, bind off 6 sts. 4x, and FOR NECK: bind off 5 sts. 2x, 4 sts. 1x, 1 st. 1x.
 Bring the needles on the left into working position, knit 1 row in pattern to the left side, turn the Row Counter back to 112 and complete the left half. Follow the instructions from *.

ARMBANDS: Make 2.

Cast on 72 sts. with color 1 and work Stockinette stitch. After Row 12, remove onto contrast waste yarn.

NECKBAND: Cast on 110 sts. with color 1 and work 12 rows Stockinette stitch. Remove onto waste yarn.

FRONT BANDS: Make 2.

Cast on 80 sts. with color 1 and work the same as armbands.

LOWER BAND: 1 piece for fronts and back.

Cast on 122 sts. with color 1 and work same as armbands.



691

COVERLET & PILLOWS

SIZE: Coverlet - 62" x 104" (approx)

YARN: Euro Sport
GRAMS: COVERLET (or Bedspread)

color 1 500
color 2 500
color 3 500
color 4 500

For 2 Pillows, add 3 more balls.

TENSION: 8 or 9
GAUGE: 12 sts. 18 rows = 5 cm (2")

A Tuck Stitch Pattern. Punch your own Card.

FINISHING: Bedspread, - Sew sections together (see Picture) so that sections form chevrons. Work single crochet around edges or finish edges with trim of your choice.

CIRCULAR PILLOW: Sew sections together (8 for each side) then sew over a pillow form, or you can make separate pillow and stuff with fiber fill.

Sew around pillow sections leaving open enough to push separate pillow inside, then close opening. Make pom-pom or button and sew to centers.

OBLONG PILLOW: - Sew sections together. Make separate pillow to fit cover - sew seams and insert pillow then close openings.

BEDSPREAD: Make 3 sections of EACH COLOR and reverse card so that sections will form chevrons - see picture.

Cast on 50 sts. and work in Pattern to Row 720. Bind off.

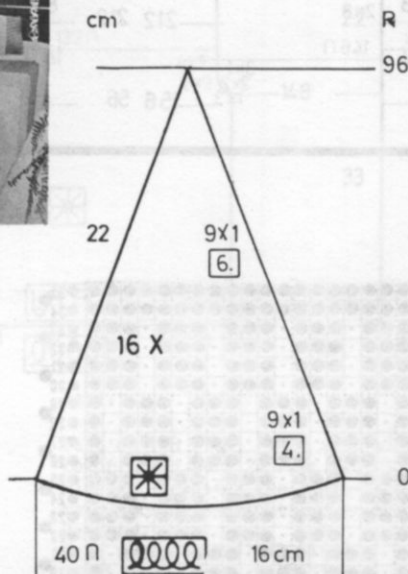

ROUND PILLOW: Make 16 sections (4 of each color).

Cast on 40 sts. and work in Pattern. ON EACH SIDE, decrease 1 st. every 4th row 9x, every 6th row 9x.

After Row 96, bind off

OBLONG PILLOW: Make 2 sections each color.

Cast on 28 sts. and work in Pattern. After Row 180, bind off.

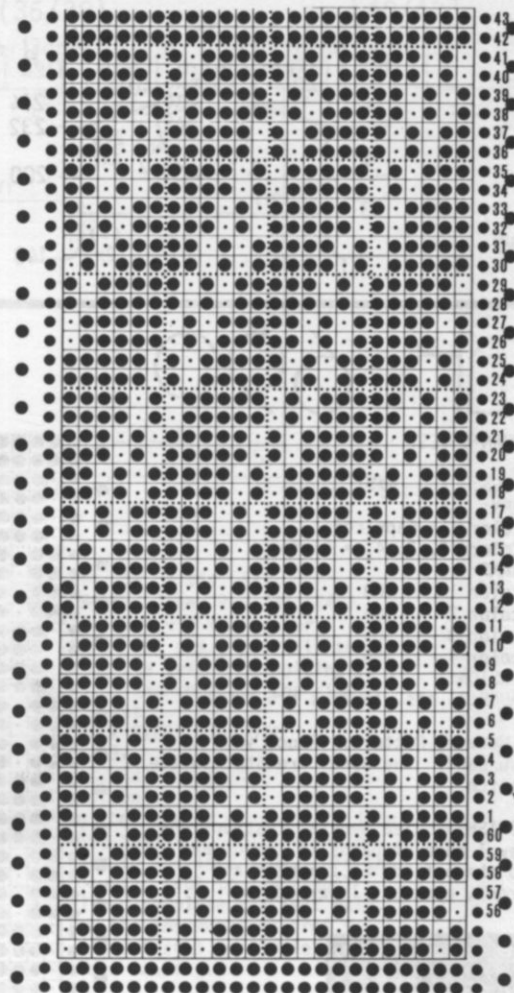

681

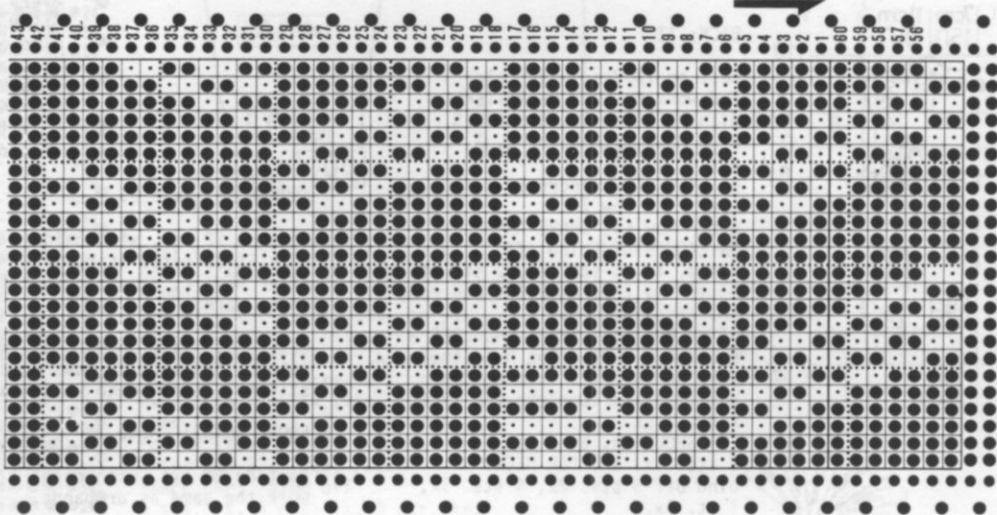
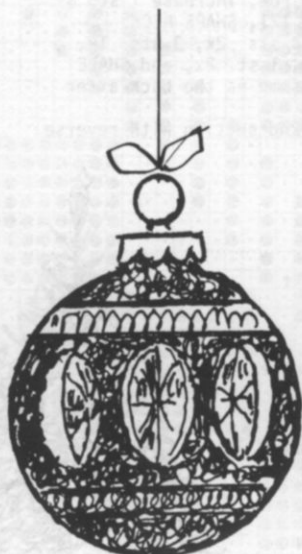



KNITTING NEWS

PRACTICAL KNITTING HINTS

RIBBING WITH HEAVY YARNS

When ribbing with heavier yarns such as Binia or Euro Sport, be sure to thoroughly wax the yarn. Hold a piece of ordinary paraffin wax in your hand and allow the yarn to run over it as you wind the yarn into a pull ball. Use EVERY OTHER NEEDLE on the main machine and EVERY OTHER NEEDLE on the ribber.

RIBBED BANDS

Sometimes in KNITTING MAGAZINE, we tell you to remove ribbed bands onto contrast waste yarn. To make it easy for you to sew or weave these open stitches to a neckline or armhole, you can always knit 4 rows of stockinette stitch ON EACH BED first, then remove the stitches onto the waste yarn. When you are ready to sew the bands onto the garment, one edge of the stockinette stitch must be sewn to the inside and one to the outside of the garment. If you do not like to weave or sew open stitches, you can bind off the band stitches using the crochet method.

STITCH GAUGE STRIPS FOR USE WITH THE KNITLEADER ON THE JUMBO CN-9

We now have a set of 2 strips to use with your KNITLEADER on the JUMBO CN-9. There are 4 sets of measurements on each strip for a total of 8. The measurements are 9.1 cm, 9.5 cm, 10.0 cm, 10.5 cm, 11.1 cm, 11.8 cm, 12.5 cm and 13.3 cm.

In order for you to use your KNITLEADER, you should make your sample swatch as follows and use knitting worsted weight yarn.

With waste yarn, cast on 30 sts. Knit 10 rows. Change to the yarn you want to use for garment and set Counter at 0. Knit 15 rows, mark the 5th st. ON EACH SIDE by knitting it with a piece of contrast. Knit 15 more rows, then knit 10 rows with waste yarn. Be sure to use the same weight of yarn for the contrast. Remove the swatch from the machine. Pull the sample into shape and allow it to rest for several hours or overnight. If it is wool, you can steam it. You can also wash the sample and allow it to dry thoroughly. This is especially good if it is a synthetic.

With the ruler that comes with your KNITLEADER, measure the 20 stitches between the markers. Let us suppose it measures 12.5 cm. Take the strip with the marking of 12.5 and check your sample against it by folding the knitting over at the marked row and placing the sample between the markings on the strip beginning at the center dotted line on the strip across to 20 sts. It should match with the ruler measurement of 12.5. This is the strip you will place on the KNITLEADER.

With your ruler, measure the 30 rows. Supposing it measures 14.5 cm which is 145 mm. Set the regulator on the KNITLEADER to 14 for the cm, then set the mm regulator to 5.

The TRIP for the movement of the KNITLEADER SHEET must move two times on every row. If you have

two Row Counter trips, one on each side of the Carriage, it will automatically trip twice, but if you do not have two Row Counter trips, you will have to move this trip the second time by hand.

This information is only a supplement to the Instruction Book which you received with your KNITLEADER. The set of 2 strips is \$1.50 plus 90¢ shipping costs.

SPECIAL DISCOUNTS on YARN KITS for garments in this issue of KNITTING MAGAZINE are listed below and are available to our subscribers. Please remember that the special prices are only good until the next issue of the magazine and you must be sure to list alternate colors.

DISCOUNTED KITS FOR THIS ISSUE

DK 665 - Yarn: Micaela			
SIZES:	6/8	(10/12)	[14]
Regular Price	\$13.93	\$17.91	\$19.90
Sale Price	10.43	13.41	14.90
Shipping Costs	1.85	1.85	1.85
HP 666 - Yarn: Micaela			
SIZES:	36/38	(40/42)	[44]
Regular Price	\$19.90	\$21.89	\$21.89
Sale Price	14.90	16.39	16.39
Shipping Costs	1.85	1.85	1.85
DK 667 - Yarn: Crocus Crepe			
SIZES:	12/14	(16)	
Regular Price	\$29.26	\$33.44	
Sale Price	20.86	25.12	
Shipping Costs	1.85	1.85	
KK 668 - Yarn: Binia			
SIZES:	6/7	(8)	[10]
Regular Price	\$ 9.73	\$11.12	\$12.51
Sale Price	7.30	8.32	9.36
Shipping Costs	1.85	1.85	1.85
KK 669 - Yarn: Euro Sport			
SIZES:	6	(7)	[8]
Regular Price	\$11.61	\$12.90	\$14.19
Sale Price	8.71	9.70	10.67
Shipping Costs	1.85	1.85	1.85
DK 670 - Yarn: Micaela			
SIZES:	8/10	(12/14)	[16]
Regular Price	\$41.79	\$45.77	\$47.76
Sale Price	31.29	34.28	35.77
Shipping Costs	2.50	2.50	2.50
KK 671 - Yarn: Crocus Crepe			
SIZES:	6	(7)	[10]
Regular Price	\$12.54	\$12.54	\$14.63
Sale Price	9.41	9.41	10.97
Shipping Costs	1.85	1.85	1.85
HP 672 - Yarn: Crocus Crepe			
SIZES:	32/34	(36/38)	[40]
Regular Price	\$29.26	\$31.35	\$33.44
Sale Price	21.98	23.51	25.12
Shipping Costs	1.85	1.85	1.85
KK 673 - Yarn: Amore			
SIZES:	Years 12	(13)	[14]
Regular Price	\$20.86	\$22.35	\$25.33
Sale Price	15.65	16.76	19.00
Shipping Costs	1.85	1.85	1.85

DK 674 - Yarn: Crocus Crepe
 SIZES: 10/12 (14) [16]
 Regular Price \$31.35 \$33.44 \$33.24
 Sale Price 23.51 25.12 25.12
 Shipping Costs 1.85 1.85 1.85

DK 675 - Yarn: - Amore
 SIZES: 10/12 (14) [16]
 Regular Price \$29.80 \$32.78 \$34.27
 Sale Price 22.35 24.56 25.71
 Shipping Costs 1.85 2.50 2.50

DK 676 - Yarn: Crocus Crepe & Beatrice Silver
 SIZES: 10/12 (14) [16]
 Regular Price \$45.40 \$50.18 \$54.96
 Sale Price 35.12 37.65 41.28
 Shipping Costs 2.50 2.50 2.50

KK 677 - Yarn: Crocus Crepe
 SIZES: 7/8 (9/10) [11/12]
 Regular Price \$27.17 \$29.26 \$33.44
 Sale Price 20.41 21.98 25.12
 Shipping Costs 1.85 1.85 1.85

KK 678 - Yarn: Crocus Crepe
 SIZES: 7/8 (9/10) [11/12]
 Regular Price \$27.17 \$29.26 \$33.44
 Sale Price 20.41 21.98 25.12
 Shipping Costs 1.85 1.85 1.85

DK 679 - Yarn: Amore
 SIZES: 8/10 (12) [14]
 Regular Price \$29.80 \$35.76 \$41.72
 Sale Price 22.35 26.83 31.31
 Shipping Costs 1.85 2.50 2.50

KK 680 - Yarn: Crocus Crepe
 SIZES: 8 (10) [12]
 Regular Price \$18.81 \$20.90 \$22.99
 Sale Price 14.11 15.68 17.24
 Shipping Costs 1.85 1.85 1.85

DK 681 - Yarn: Crocus Crepe
 SIZES: 8/10 (12) [14]
 Regular Price \$29.26 \$31.35 \$33.44
 Sale Price 21.98 23.51 25.12
 Shipping Costs 1.85 1.85 1.85

DK 682 - Yarn: Fortissima & Boucle
 SIZES: 12/14 (16) [18]
 Regular Price \$28.71 \$32.10 \$35.49
 Sale Price 21.51 24.05 26.59
 Shipping Costs 1.85 1.85 1.85

DK 683 - Yarn: Fortissima & Euro Sport
 SIZES: 12/14 (16) [18]
 Regular Price \$33.27 \$36.66 \$39.95
 Sale Price 24.95 27.49 29.93
 Shipping Costs 2.50 2.50 2.50

DK 684 - Yarn: Crocus Crepe
 SIZES: 8 (10) [12]
 Regular Price \$39.71 \$41.80 \$45.98
 Sale Price 29.83 31.40 34.54
 Shipping Costs 1.85 1.85 2.50

HP 685 - Yarn: Crocus Crepe
 SIZES: 36/38 (40/42) [44/46]
 Regular Price \$35.53 \$38.92 \$42.31
 Sale Price 26.69 28.26 30.83
 Shipping Costs 1.85 1.85 1.85

DK 686 - Yarn - Vienna
 Matching sewing thread not included in Kit.
 SIZES: 10 (12) [14]
 Regular Price \$30.43 \$32.22 \$34.01
 Sale Price 22.82 24.17 25.51
 Shipping Costs 1.85 1.85 1.85

687 - No Kit available for Rug.
 HP 688 - Yarn: - Amore
 SIZES: 34 (36/38) [40/42]
 Regular Price \$17.88 \$17.88 \$19.37
 Sale Price 13.41 13.41 14.53
 Shipping Costs 1.85 1.85 1.85

DK 689 - Yarn: Fine Yarn - NO KIT AVAILABLE.
 You will need approximately
 1 1/2 lbs. color 1 - 8 oz. color 2

DK 690 - Yarn: - Silver Capriccio & Binia
 SIZES: 6/8 (10) [12]
 Regular Price \$22.73 \$24.22 \$25.71
 Sale Price 17.06 18.55 19.94
 Shipping Costs 1.85 1.85 1.85

691 - Yarn: Euro Sport -3 extra balls needed for
 Matching Pillows (2)
 SIZES: Approximately 62" X 104"
 Regular Price \$51.60 Pillows: \$3.87
 Sale Price 38.80 2.90
 Shipping Costs 3.15 1.25

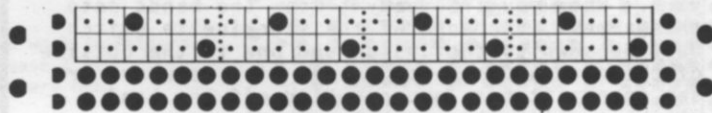

SLIPPERS - Knitting Worsted Weight. Approx. 2 1/2 oz.

No telling how many thousand pairs of these have been made since the instructions were printed in KNITTING MAGAZINE some years ago. We are updating them so you can knit them on any Punch Card machine.

Punch your card with a REPEAT of the two rows shown - long enough so the card will revolve when clipped together. EVERY 3rd NEEDLE is used and to find the exact needles you must use for the Card to work, begin as follows: Bring 60 needles into working position (every needle). Set your card and push in BOTH TUCK BUTTONS. Run the carriage across. Bring all the needles that set into pattern into holding position. Set the Cam Control to holding and run the carriage for the 2nd row. Bring the needles that set into pattern into holding position again. Return the holding Cam Control to knit. You will see that you have EVERY 3rd needle in holding position. Push all remaining needles in working position to OUT OF WORK. Bring the holding needles into working position and use them as a guide for casting on over EVERY 3rd needle. 16 sts.]5cm

SIZES: Small (Medium) [Large] Tension 9 or 10. 22 rows]5cm
 Cast on 33 (37) [41] sts. over EVERY 3rd NEEDLE. (See above information). Knit in TUCK PATTERN to Row 100 (112) [124]. Bring all the needles into working position and knit 1 very loose row by hand - be sure each loop is at least 1/4" long. Bind off the crochet method.

FINISHING: Pull the knitting into a square shape. Pull up the cast on edge. With purl side inside, fold the square into a triangle and pin with large pins. Thread a tapestry needle with yarn and over-cast, beginning at the folded point (toe) and rounding the last few stitches at end to form heel. Continue to sew up the instep for 3 or 3 1/2". Turn to the right side and sew bell to tip of toe then fold toe up about 1" and fasten. Fold the cuff to the right side. Make tassel in a contrast color and attach to point of cuff (see picture). For tassel, wind yarn around 4 fingers approximately 16 times. Tie through loop. Fold with tie at top then tie yarn about 1/2" from top of tassel. Pull ends through to hide them. Cut bottom of tassel. To make slippers larger or smaller, change the size of square according to your stitch and row gauge.

SALE

demonstrator and traded

MACHINES

NEW, DEMONSTRATORS AND TRADED MACHINES AT GIVE AWAY PRICES.....

Nobody can beat our prices, so if you want a second machine, place your order as fast as possible... Maybe you have a friend that cannot afford a brand new machine... and if so, please tell her about our low, low prices... and if you want a machine not listed below, let us know... We have too many to list them all.

MACHINE	CONDITION	LIST PRICE	SALE PRICE
KNITKING - AM3 - With Ribbing Attachment	LIKE NEW	\$549.00	\$299.00
KNITKING - AM2 - With Ribbing Attachment	REBUILT	449.00	199.00
KNITKING - KH830 - With Lacemaker	DEMO - LIKE NEW	489.95	349.00
KNITKING - KH120 - Fine Needle Knitter with 258 needles & Lacemaker	DEMO - LIKE NEW	429.95	275.00
BROTHER - KH820 - With Lacemaker & Ribber	EXCELLENT	609.90	299.00
BROTHER - KH820 - With Lacemaker	EXCELLENT	429.95	199.00
BROTHER - KH800 - With Lacemaker	EXCELLENT	369.95	125.00
BROTHER - KH588 - With Lacemaker	EXCELLENT	289.95	150.00
BROTHER - 500	VERY GOOD	99.95	35.00
BROTHER - KR586 - Ribbing Attachment suitable for 588 - 800 machines	NEW	159.95	79.00
BROTHER - KR580 - Ribbing Attachment suitable for 500 - 551 machines	NEW	99.95	39.00
GENIE - KH710 - With Lacemaker	DEMO - LIKE NEW	269.95	189.00
GENIE - CH1800 - With Ribber	EXCELLENT	319.00	150.00
GENIE - CH1800	EXCELLENT	179.50	80.00
GENIE - CHJ3	EXCELLENT	95.50	40.00
JUMBO - CN9	EXCELLENT	269.95	95.00
JUKI - 2400	LIKE NEW	469.95	195.00
JUKI - 1300	EXCELLENT	369.50	95.00
TOYOTA - K747 - With Knit Tracer & Lace Carriage . . .	LIKE NEW	499.00	175.00
TOYOTA - 727	EXCELLENT	299.00	95.00
STUDIO - 312	EXCELLENT	399.50	150.00
SPEED-O-KNIT - Gold color with Automatic Lock	EXCELLENT	269.50	60.00
MITSUBISHI - Color 7	VERY GOOD	199.95	60.00
ORION - 360 Needles - Double Bed	VERY GOOD	399.00	75.00
REGINA - 360 Needles - Double Bed	VERY GOOD	399.00	75.00
KNITKING - KL116 Knitleader	DEMO - LIKE NEW	89.95	55.00
BROTHER - KL113 Knitleader - For Model 800 . . .	DEMO - LIKE NEW	79.95	39.00
BROTHER - KL111 Knitleader - For Models 585 & 588 . . .	NEW	69.50	39.00
KNITKING - KRC830 Color Changer	DEMO - LIKE NEW	89.95	49.00
KNITKING - KHC820 Color Changer	DEMO - LIKE NEW	89.95	49.00
BABY LOCK - 605 - Sew-Overlock	LIKE NEW	429.00	299.00
BABY LOCK - 205 - Overlock only	EXCELLENT	349.00	175.00

California residents please add Sales Tax.
All machines shipped freight collect from Los Angeles.

**Your Knitter needs
a Linker, like your Washer
needs a Dryer**

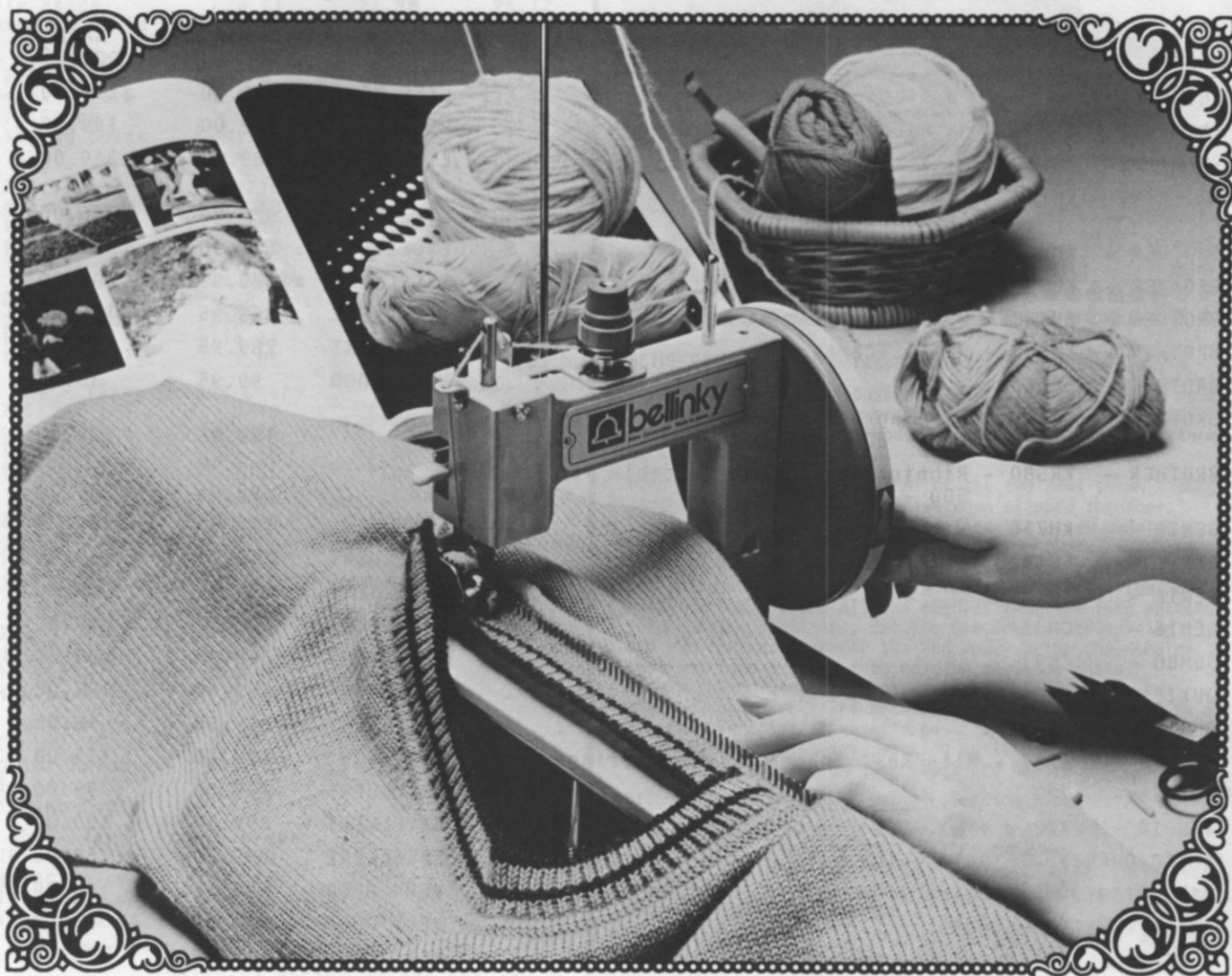

LINKING MACHINE
bellinky

For fast easy and accurate assembly of all your knits you need BELLINKY. It seams, attaches sleeves and collars, pleats, shirrs and it lets you work lace, leather and other fabrics into your knitting.... BELLINKY is well engineered, lightweight, easy to carry, compact for storage.

Order direct from KNITKING
1128 Crenshaw Blvd., Los Angeles, California 90019

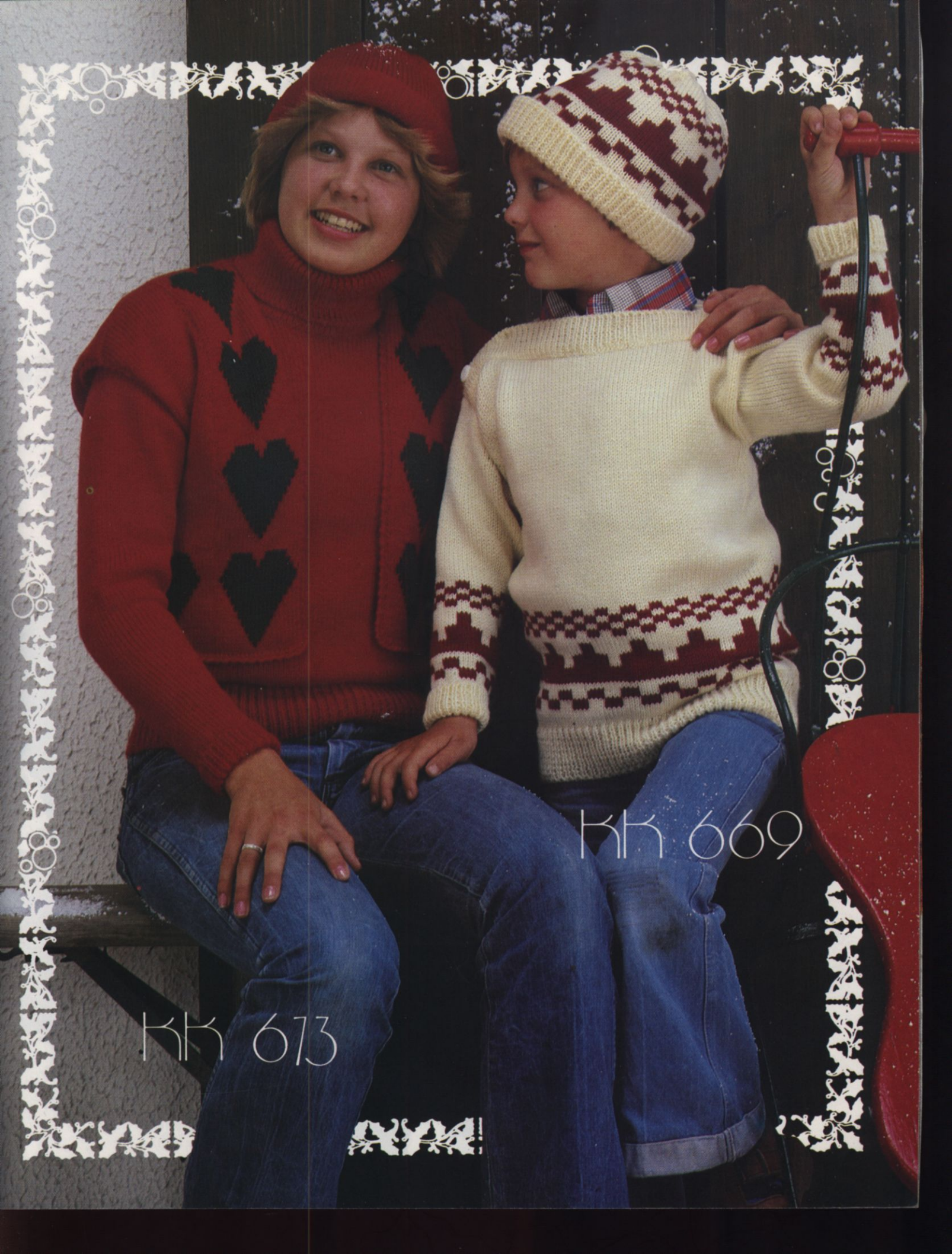

KH 673

KH 669



dk 682



dk 683



687



691

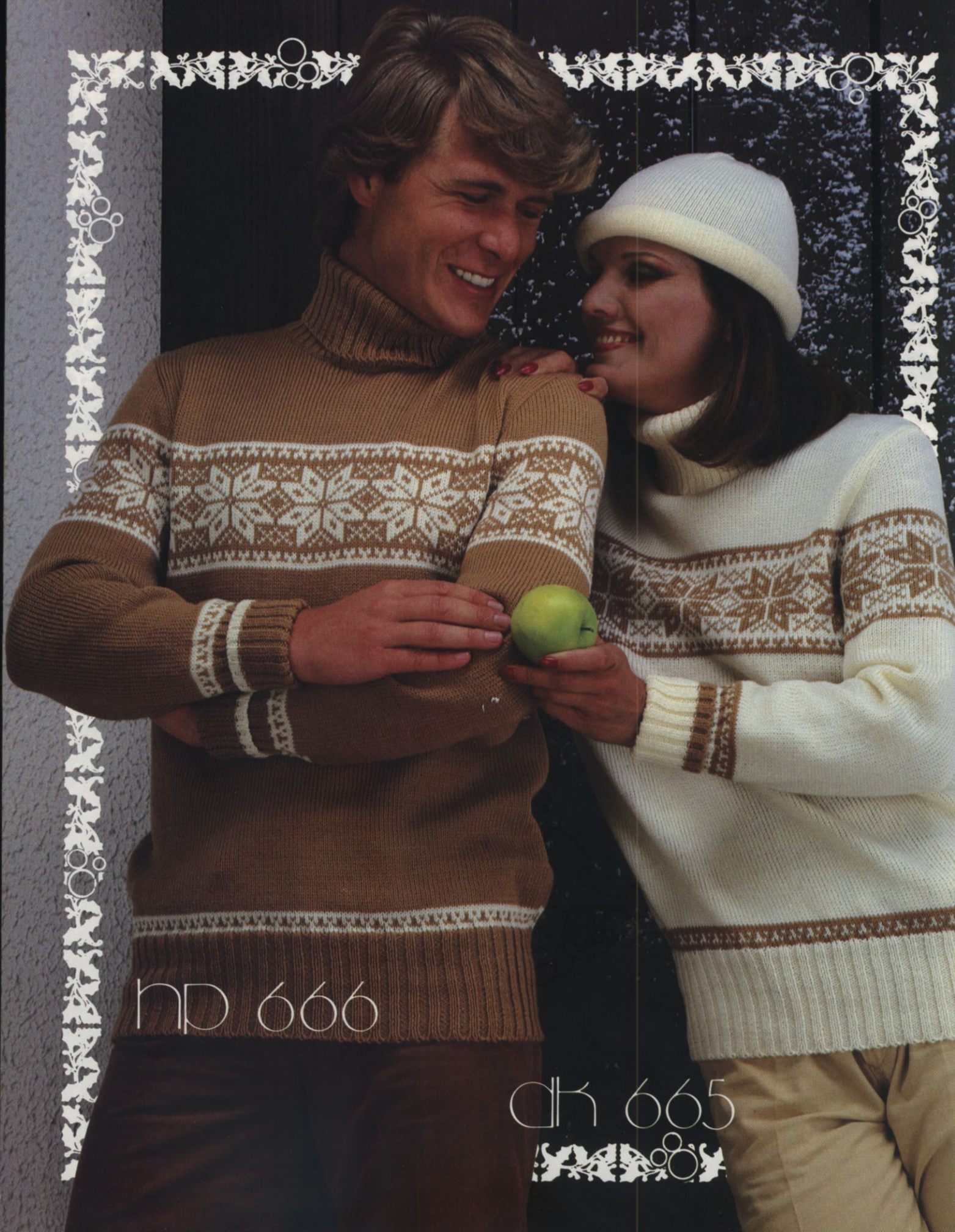

hp 666

dk 665



KK 678

KK 677



hp 600



KH 680

KH 681

