

knitking

magazine





DK998



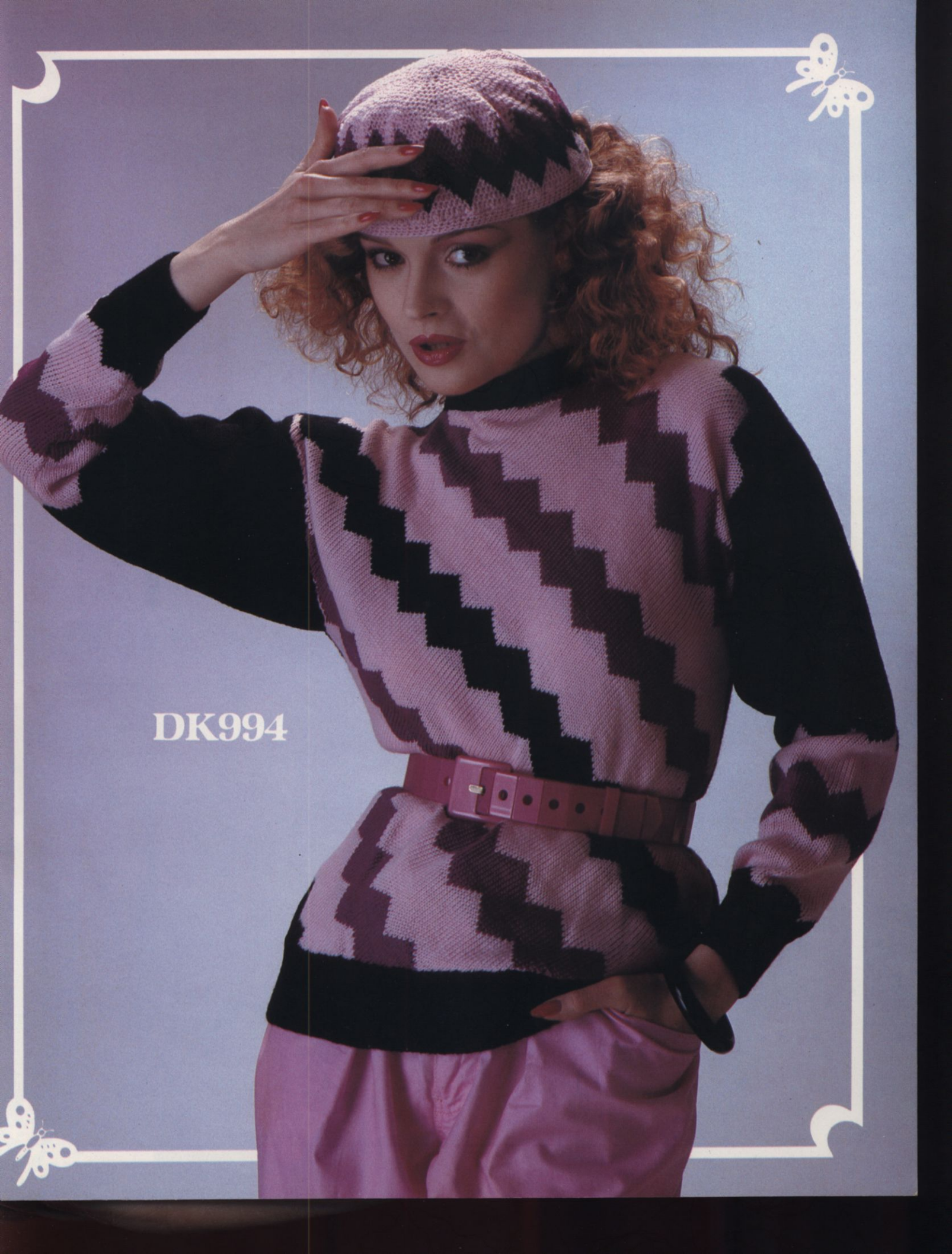

DK994

DK988





HP987

DK986



DK997



DK996





DK1000

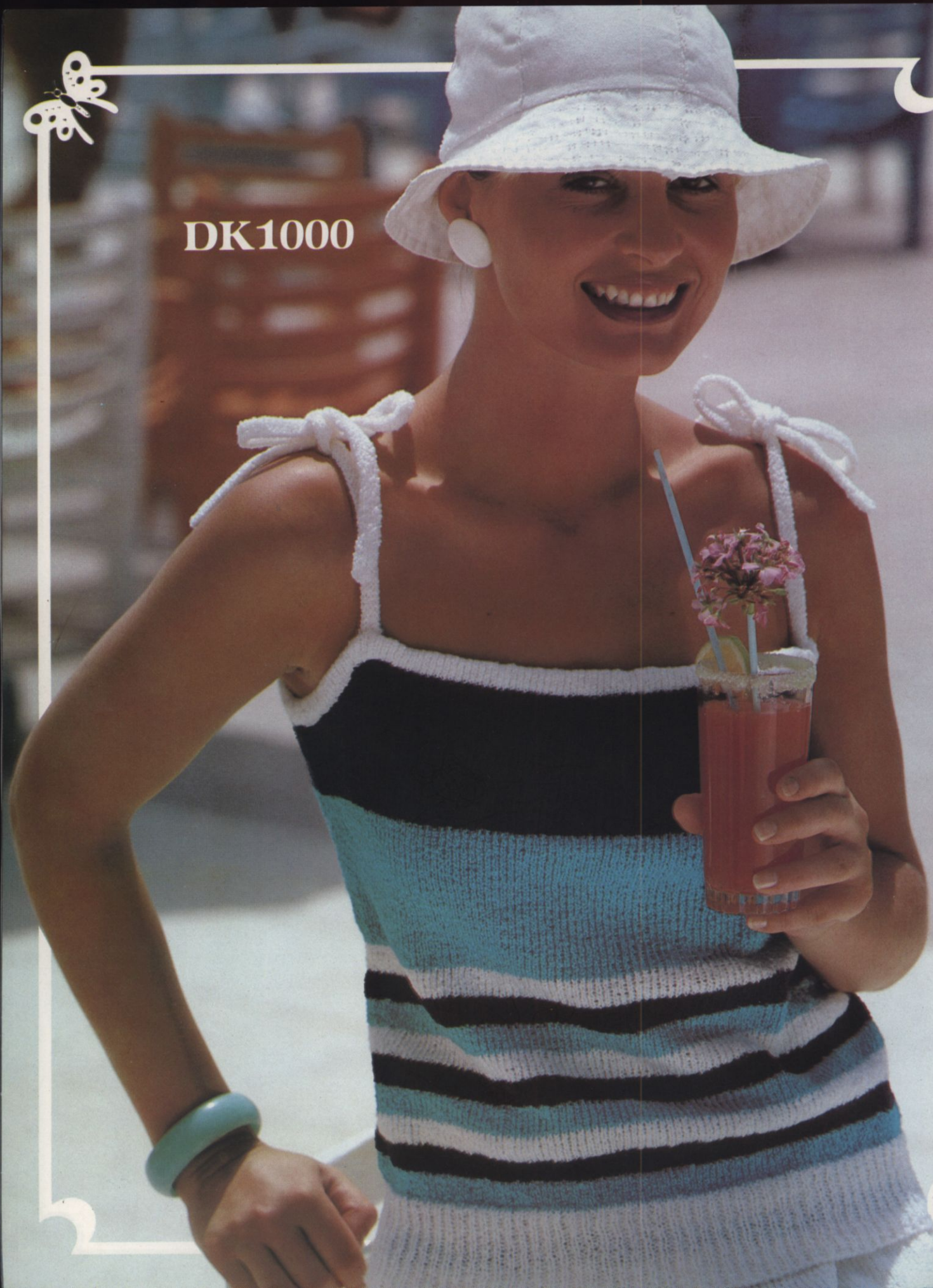



DK1000

KNIFE POLISH

DK985

DK984



knitking

magazine

editorial

TABLE OF CONTENTS	PAGE NO.
DK 983 Woman's Pullover	14
DK 984 Woman's Pullover	15
DK 985 Teen's Dress	16
DK 986 Woman's Pullover	17
HP 987 Man's Pullover	18
DK 988 Woman's Pullover	19
KK 989 Child's Pullover	20
DK 990 Woman's Tank Top & Jacket	21
DK 991 Woman's Pullover	22
DK 992 Woman's Pullover	23
DK 993 Woman's Vest	24
DK 994 Woman's Pullover	24
DK 995 Woman's Dress	26
DK 996 Woman's Pullover	27
DK 997 Woman's Pullover	28
DK 998 Woman's Dress	29
DK 999 Woman's Sleeveless Pullover & Jacket	30
DK 1000 Woman's Skirt & Jacket	31
DK 1001 Woman's Blouse	33
DK 1002 Woman's Vest & Top	34
DK 1003 Woman's Pullover	35
KK 1004 Child's Jacket	36
KK 1005 Child's Pullover	37

It's a brand new Model... THE KNITKING KH 881... with all of the outstanding features of previous KNITKING Punch Card machines plus many new features including a Lace Carriage that knits fine lace, normal lace and automatically retracts the end needles of your knitting, thereby eliminating the problems of pushing needles back manually every row... There are Lace Point Cams that permit you to isolate sections of lace card designs... There are new Motif Knitting Cams that make it easy for you to knit one, two or three Motifs as you desire and there is a new design Plating Finger that allows for much easier entry of yarns than on previous Models.

In our opinion the greatest improvement of all is the built in Knitleader with its entirely new and simplified system for chart drawing... Japan is the largest market in the world for knitting machines and the many hundreds of knitting machine schools there repeatedly emphasize the importance of drawing Knitleader Charts to size before starting to knit. Working with a Knitleader insures accuracy and a finished garment that fits.

We know that our readers fortunate enough to obtain a brand new KNITKING KH 881 will be more than thrilled with its ability and extreme versatility.

With the State of the Art Electronic KNITKING Compuknit KH 910... the all new KH 881 Punch Card machine... the 120/258 needles fine knitting machine... the Jumbo CN-9N for heavy yarns plus the Genie 710 Push Button economy priced knitter... and all of their accessories - Ribbers, Knitleaders, Color Changers etc., etc., we know that we have the finest range of knitting machines in the country, and that our services are second to none...

















KNITKING SEMINAR AND OPEN HOUSE - 1981



Plans continue and we will be ready for our finest Seminar ever when our doors open on October 12th. There will be many guest celebrities on hand to teach and help you with your knitting problems and we cannot emphasize enough the need to come prepared with your questions written down. It is so easy in the excitement of the moment to forget things, only to remember when you get back home and sit down at your own knitting machine.

The new KH 881 will be featured at the Seminar and we will have the Compuknit demonstrated by the worlds foremost authority Yukiko Mitsumata, the lady (from our suppliers in Japan) who was directly involved with the design of the Compuknit and the preparation of its Instruction Manuals.

Pattern Symbols

Knitting – Chart Symbols

- Size Symbols
() (2nd Size)
< > 3rd Size
① Color Number
-  Cast on
-  Stitch
-  Row
-  Hem
-  Bind off
-  Stockinette stitch – worn on the Knit side.
-  Stockinette stitch – worn on the Purl side.
-  Knit 1, Purl 1 Ribbing
-  Ribbing Pattern – worn on the Knit side.
-  Ribbing Pattern – worn on the Purl side.
-  Closed Dart
-  Open Dart
-  Put on a stitch holder
-  Reverse 1 section
-  On every other needle
-  Number of Rows between Shapings. Make increase (or decrease) FIRST, then knit 4 rows. For example: 3 x 1  means decrease (or increase) 1 st., knit 4 rows; decrease 1 st., knit 4 rows; decrease 1 st., knit 4 rows; decrease 1 st., knit 4 rows. All decreasing (or increasing) without row numbers as shown must be shaped on every 2nd row.

-  Increase
-  Increase 2 sts. With a transfer tool, move the sts. over the left (or right) leaving 2 empty needles at the point of increase. At the increase point, move 1 st. to the left, (or right) so that there is an empty needles on each side of a stitch. On each side of the center stitch, pick up a stitch from the row below and hang it onto the empty needle.

-  3 stitches on 1 needle. The 1st and 3rd stitch in a group of 3 has been hung on the 2nd or center needle.

-  Short Row increase or decrease; for instance on a flared skirt knitted sideways.

-  Pattern Stitch





-  Pattern Stitch – worn on the Knit side.

-  Pattern Stitch – worn on the Purl side.









-  Repeat

- I = Front
II = Back
III = Sleeve
IV = Skirt Front
V = Skirt Back
VI = Collar
VII = Pocket
VIII = Band
IX = Belt
X = Cuff
XI = Pants Front
XII = Pants Back

Finishing – Chart Symbols

-  Match numbers on section for assembling.
-  Ease
-  Fold Line
-  Turn to the wrong side and hem.

Stitch Symbols

-  Needles in holding position
-  Needles back into working position.
-  Empty needle (leave in working position)
-  Needle not used (in the out of work position).
-  Two stitches on 1 needle, either transferred from the right side or the left side, then put into holding position.
-  Needle holding 2 stitches. Stitch has been transferred from the RIGHT.
-  Needle holding 2 stitches. Stitch has been transferred from the LEFT.
-  Center of garment section



General Instructions

HOW TO READ THE CHARTS AND INSTRUCTIONS

There are 3 sizes given for each Pattern in KNITKING MAGAZINE. Above each Chart for the different sizes, you will see that the first and smaller sizes might be shown as 8/10, the second size as (12/14) and the third as [16/18]. Check the measurements at the bustline and hips on the Charts to be certain that you will knit the correct size, remembering these are ACTUAL measurements of the completed section and that there must be a bigger allowance at the bustline and hipline for a Jacket or a Coat than there would be for a fitted dress or a fitted blouse or pullover. The question in your mind should be "How do I want this garment to fit...?"

When you have chosen the size you need, you can follow the Charts as shown. You will notice that where the shapings are the same FOR ALL SIZES, only 1 set of shapings will be shown on the first Chart and if you are knitting the 2nd or 3rd size, you simply follow the shapings as given for the first size. If the shapings are different, this will be shown on the Charts and you should follow them as given.

On the Charts, increases and decreases will be shown as follows

5x1

6 The number in the box means number of ROWS between the shapings, while the 5x1 above the box means - 1 st. 5x... so you will increase or decrease 1 st. every 6th row 5x.

ARMHOLE SHAPINGS - NECK SHAPINGS - SHOULDER SHAPINGS - are made on every 2nd row UNLESS there is a number in a box along side or below the shapings. The rule is... where there is no box with a number, the shaping is made on every 2nd row.

THE PRINTED INSTRUCTIONS

You can follow the printed instructions or use them in combination with the Charts. Where there is any question in the printed instructions, you have the Charts to show you how the section will look.

The 3 sizes, with the different amounts of cast on stitches and the different shapings will look like this...

Cast on 124 (136) [148] sts. You will
Cast on 124 sts. for the first size.
Cast on 136 sts. for the 2nd size.
Cast on 148 sts. for the 3rd size.

The important thing to remember is that you MUST READ AHEAD so that you KNOW what to do for the size you are knitting. Sometimes where the number of stitches are the same but the number of times different, you will find shapings like this...

3 sts. 1x (2x) [3x], 2 sts. 1x (2x) [3x], 1 st. 3x (4x) [5x].
As you see, you MUST read ahead in order to follow the instructions as given for YOUR SIZE. The rows will be different for the different sizes in some cases... Shoulder and Neck shapings usually are worked at the SAME TIME for the back section - so watch for the words AT THE SAME TIME.

HOLDING STITCHES ON THE LEFT SIDE WHILE SHAPING THE RIGHT SIDE

When knitting a section of garment in stockinette stitch, it is easy to hold the stitches on the left side while knitting the right half, but when knitting a Pattern Stitch such as a Norwegian Design, a Holding Position Design, Weaving, etc., you should use the following method. For the NECK SHAPING, we tell you to bind off the center sts., put the needles on the left into holding position and complete the right half first... so with a strand of contrast yarn, knit ALL of the left side stitches manually by hand, pulling each stitch back against the needle bed to the OUT OF WORK position. When the right side is completed, carefully pull the stitches held on contrast, forward into working position and as you do so, undo the contrast yarn, line up the needles (KNITKING AM 3 machine owners, put the stitches under the sinkers) and complete the left half.

If you own a Japanese machine, you may find that when knitting the right half with the left side held in this way, the sinker plate will mark the left side while you are knitting the right half. To prevent this marking, you can tape a piece of paper over the knitting, underneath the sinkers, or if you own a Reversing Bar, you can hang this onto the Sinkers while you are knitting the right half. When hanging the Reversing Bar, be sure the eyes of the bar go BETWEEN the Sinker Posts on the upper part of the bar so that the tips of the bar only - show above the needle bed.

FULL FASHION DECREASING OR INCREASING

For Stockinette stitch, always use the Full Fashion method for increasing or decreasing.

TO DECREASE: Hang the 3rd stitch onto the 2nd stitch then move the stitches in to fill the empty needle.

TO INCREASE: Move the 2 end stitches 1 needle outward, then pick up the 3rd stitch from the row below and hang it onto the empty needle.

FINISHING: Block all sections. For PULLOVERS, JACKETS, and DRESSES: Join front to back at sides and shoulders. Sew sleeves together and set in. Hem lower edge and sleeve edges if needed. For a double neckband or armhole band, sew 1 edge to the inside and 1 to the outside of neck or armhole. For a single ribbed band, sew 1 edge to the outside of neck or armhole edge. For a cardigan or jacket with buttonholes, finish buttonholes and sew on buttons.

PANTS: Join front to back at sides. Sew inside leg seams, then join center front and back. Make hem at waistline and insert elastic. Hem lower edge of pants legs.

THE SAMPLE SWATCH

Before you begin to knit any garment, you will need to knit a sample piece using the yarn you have chosen for your garment, so that you can check the stitch and row gauge which must measure the correct number of stitches and rows in 5 cm (2 inches).

For each Pattern in KNITKING MAGAZINE, we give you 3 tension numbers to work from and if you use the specified yarn for the garment, you should be able to get the correct stitch and row gauge using one of these numbers. Here is a very easy way to make your sample swatch and count the stitches and rows without actually counting, by using our KNITKING Converta Tape.

Supposing the Tension Numbers for the Stitch and Row Gauge are given as 5 to 7. Set the Tension Dial to the first number which is 5. With contrast waste yarn, and using the quick cast on method, cast on 60 stitches and knit 10 rows. Change to garment yarn and turn the Row Counter to 0. Knit 30 rows. Counting from each end, knit the 10th stitch on each side by hand with a small piece of contrast yarn. Leave the needles in working position and knit 30 rows (Row 60), then knit 4 rows with contrast waste yarn. Turn the Row Counter to 0 and the Tension Dial to 6 and with garment yarn, knit 30 rows. Mark the 10th stitch on each side as you did before, knit 30 rows, then 4 rows with contrast waste yarn. Turn the Row Counter to 0 and with Tension 7, repeat the above once more, ending with 10 rows of contrast waste yarn. Remove the work from the machine by passing the Slide across the needles without yarn (sometimes called 'dropping').

Pull and stretch the sample piece both lengthwise and diagonally from corner to corner, then lengthwise again. Do not count the stitches and rows immediately, but allow the sample to rest for several hours or even over night. This will allow the stitches and rows to return to their basic form.

When your sample has rested and you are ready to count the stitches and rows, the KNITKING CONVERTA TAPE will do the counting for you without any counting on your part. Use the Tape as follows:

Measure the stitches with the TAPE, BETWEEN the 40 stitches marked with contrast waste yarn. Push the SLIDE so that the LEFT EDGE lines up to this exact measurement. Now look down along side the SLIDE and find the number 40 on the TAPE. The number directly opposite on the SLIDE will be your Stitch Gauge to 5 cm (2"). To find the number of rows in 5 cm (2"), place the TAPE to measure over the 60 rows, push the SLIDE to this number with the left edge lined up, the look for the number 60 on the TAPE and directly opposite this will be the number of rows to 5 cm (2")

If you do not own a KNITKING CONVERTA TAPE, you must mark a 5 cm (2 inch) square in the center of the knitting, then count the number of stitches and rows within the square.

DK 983

WOMAN'S PULLOVER

SIZES: 8/10 (12/14) [16/18]
 YARN: Vienna
 GRAMS: 200 250 300
 TENSION: 4 to 7
 GAUGE: 15 sts. 18 1/2 rows = 5 cm (2")

A Lace Pattern. Punch your own Card.
 The bands are Stockinette stitch.

FINISHING: See General Instructions.
 Work 1 row single crochet around neck slit then 1 row with chains for buttonholes on the right side. Sew Buttons on left side of slit. (See picture).

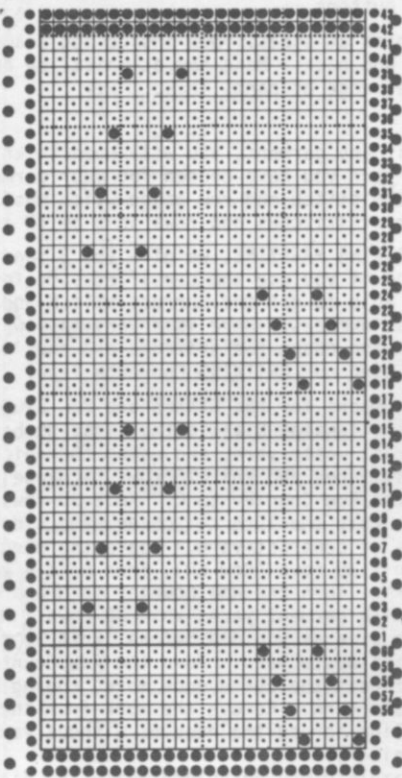

FRONT: I

Work the front the same as the back to Row 188 (192) [196].

SHAPE ARMHOLES same as the back and after Row 228 (232) [236]

Divide in the center, put the needles on the left into holding position and complete the right side first.

*ON NECK SIDE, bind off
 6 sts. 1x, 4 sts. 2x, 3 sts. 1x,
 2 sts. 2x, 1 st. 5x.
 (7 sts. 1x, 4 sts. 1x, 3 sts. 3x,
 2 sts. 2x, 1 st. 5x).
 [8 sts. 1x, 4 sts. 1x, 3 sts. 3x,
 2 sts. 2x, 1 st. 5x].

After Row 258 (266) [274], SHAPE SHOULDER same as the back. Bring the needles on the left into working position, knit 1 row in Pattern to the left side, turn the Row Counter back to 228 (232) [236] and complete the left half. Follow the instructions from *.



NECKBAND:

Sew 1 shoulder seam then pick up the sts. around neck - 148 (152) [152] sts. and work 16 rows Stockinette stitch. Hang the hem and bind off or you can bind off and turn hem to the inside and sew in place.

ARMBANDS: Pick up 108 (112) [116] sts. and work 16 rows Stockinette and complete same as Neckband.

BACK: II

Cast on 138 (150) [162] sts. and work 16 rows Stockinette stitch. Hang the hem, then continue in Pattern.

Knit to Row 188 (192) [196].
 SHAPE ARMHOLE: ON EACH SIDE, bind off 3 sts. 1x, 2 sts. 3x, 1 st. 3x, then 1 st. every 4th row 19x.
 (4 sts. 1x, 2 sts. 3x, 1 st. 3x, then 1 st. every 4th row 19x).

[3 sts. 1x, 2 sts. 3x, 1 st. 4x, then 1 st. every 4th row 19x].
 After Row 258 (266) [274], bind off the center 38 (44) [44] sts., put the needles on the left into holding position and complete the right side first.

*SHAPE SHOULDER AND NECK AT THE SAME TIME.

FOR SHOULDER, bind off
 6 sts. 2x
 (8 sts. 1x, 7 sts. 1x).
 [9 sts. 2x].

FOR NECK, bind off
 5 sts. 1x, 1 st. 2x.
 (4 sts. 1x, 1 st. 2x).
 [6 sts. 1x, 1 st. 3x].

Bring the needles on the left into working position, knit 1 row in Pattern to the left side, turn the Row Counter back to 258 (266) [274] and complete the left half. Follow the instructions from *.

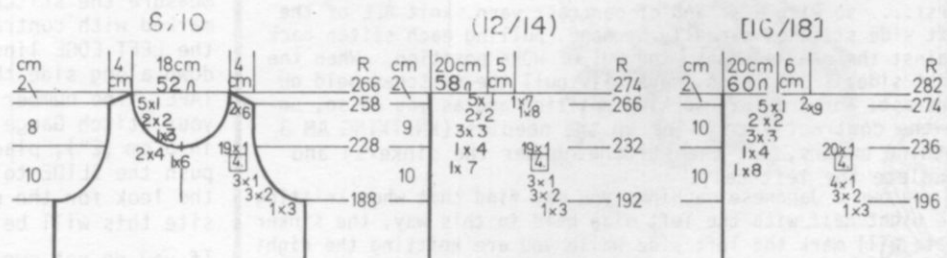
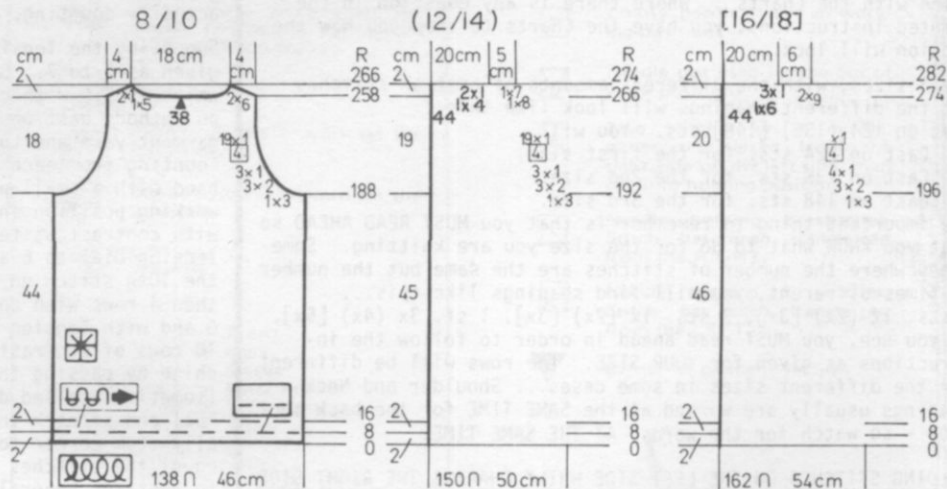

DK 984

WOMAN'S PULLOVER

SIZES: 10/12 (14)
YARN: Nomotta Viola (No Kit available) or use any yarn that gives stitch & Row Gauge.

GRAMS:
 color 1 250 300
 color 2 150 150
 color 3 150 150

TENSION: 8 or 9
GAUGE: 12 sts. 19 rows = 5 cm (2")

Color Stripes with an Intarsia Design on front and back sections. Bands are K1, P1 Ribbing.

FINISHING: See General Instructions.

NOTE: Follow the Chart for the Intarsia Design with stripes of 14 rows color 1, 8 rows color 3. Change colors as shown on the Chart. Begin with 3 balls of yarn. After Row 66, work with 4 balls and after Row 114 work with 5 balls. Be sure to cross the yarns when changing colors and move 1 st. over on every row as shown.

FRONT: I

Work the front the same as the back to Row 186 (194).
SHAPE ARMHOLE same as the back but after Row 230 (238) bind off the center 30 (30) sts., put the needles on the left into holding position and complete the right side first.
 *ON NECK SIDE, bind off
 3 sts. 1x, 2 sts. 1x, 1 st. 3x,
 1 st. every 4th row 4x.
 (3 sts. 1x, 2 sts. 2x, 1 st. 4x, then
 1 st. every 4th row 3x).
 After Row 262 (270), **SHAPE SHOULDER** same as the back.
 Bring the needles on the left into working position, knit 1 row to the left side, turn the Row Counter back to 230 (238) and complete the left half. Follow the instructions from *.

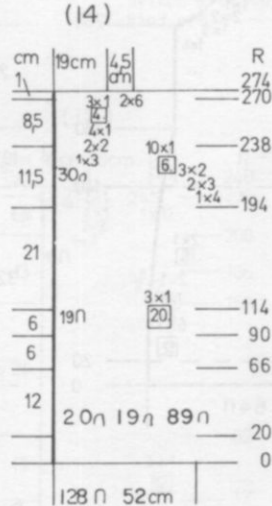
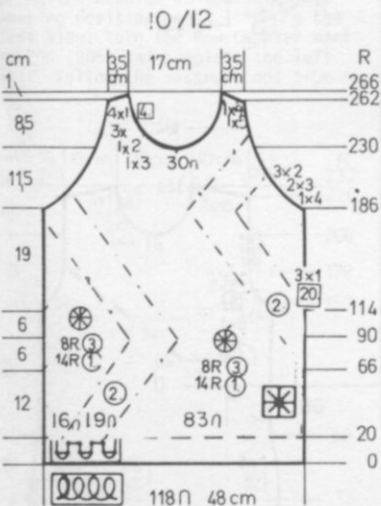

NECKBAND: Sew 1 shoulder first.

Pick up 120 (126) sts. around the neck and work 10 rows Ribbing. Bind off.

ARMBANDS:

Pick up 128 (132) sts. around armhole and work 10 rows Ribbing. Bind off.

BACK: II

Cast on 118 (128) sts. with color 1 and work 20 rows Ribbing. Continue in Pattern with color stripes as shown on the chart and be sure to read NOTE above.
 After Row 114, **ON EACH SIDE**, increase 1 st. every 20th row 3x.
 After Row 186 (194), **SHAPE ARMHOLE:** **ON EACH SIDE**, bind off 4 sts. 1x, 3 sts. 2x, 2 sts. 3x then 1 st. every 6th row 10x for both sizes.
 After Row 254 (262) bind off the center 34 (38) sts., put the needles on the left into holding position and complete the right side first.
 *ON NECK SIDE, bind off for both sizes
 4 sts. 1x, 3 sts. 1x, 2 sts. 1x, 1 st. 1x and after Row 262 (270) **SHAPE SHOULDER** by binding off 5 sts. 1x, 4 sts. 1x. (6 sts. 2x).
 Bring the needles on the left into working position, knit 1 row to the left side, turn the Row Counter back to 254 (262) and complete the left half. Follow the instructions from *.

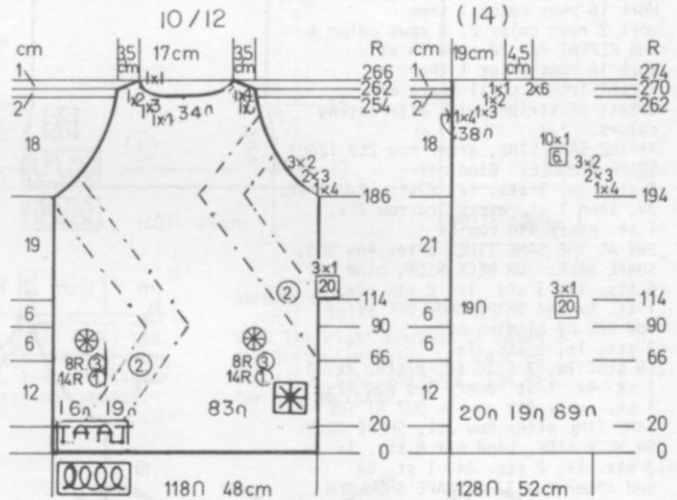

DK 985

WOMAN'S DRESS

SIZES: 7/8 (9/10)
 YARN: Nomotta Viola (No Kit available) or use any yarn that gives stitch & Row Gauge.
 GRAMS:
 color 1 400 450 = Rose
 color 2 150 150 = Lt. Blue
 color 3 100 100 = Yellow
 color 4 100 100 = Natural
 TENSION: 8 or 9
 GAUGE: 12 sts. 19 rows = 5 cm (2")



Stockinette stitch with color stripes. Lower edge of dress is K1, P1 Ribbing. Neck and Arm Bands are Garter stitch worked on hand knitting needles - or you can make the bands on the machine in Stockinette stitch and use the purl side as the right side of bands.

FINISHING: See General Instructions.

RIGHT FRONT: I

Cast on 64 sts. with color 1 and work 20 rows Ribbing. Continue in Stockinette stitch. ON SIDE EDGE, decrease 1 st. every 12th row 6x, every 8th row 2x, every 6th row 2x for both sizes. After Row 126, begin the color stripes.

*2 rows Color 2, 2 rows color 3 REPEAT from * for 22 rows in all. Work 16 rows color 1 then work 2 rows color 2, 2 rows color 4 and REPEAT for 22 rows in all. Work 16 rows color 1 then REPEAT from * until there are 5 sets of stripes with alternating colors.

AT THE SAME TIME, after Row 252 (260) SHAPE ARMHOLE: Bind off

4 sts. 1x, 3 sts. 1x, 2 sts. 2x, 1 st. 3x, then 1 st. every 3rd row 12x, 1 st. every 4th row 5x

BUT AT THE SAME TIME, after Row 303, SHAPE NECK: ON NECK SIDE, bind off 6 sts. 1x, 3 sts. 1x, 2 sts. 2x, 1 st. 5x and SHAPE SHOULDER after Row 322 by binding off 3 sts. 1x, 2 sts. 1x.

(5 sts. 1x, 3 sts. 1x, 2 sts. 2x, 1 st. 4x, 1 st. every 3rd row 12x, 1 st. every 4th row 5x BUT AT THE SAME TIME after Row 311, SHAPE NECK: ON NECK SIDE, bind off 8 sts. 1x, 3 sts. 1x, 2 sts. 2x, 1 st. 5x and after Row 330, SHAPE SHOULDER by binding off 3 sts. 1x, 2 sts. 1x).

WORK THE LEFT FRONT in the same way but have Counter at 0 on the left side and BEGIN THE COLOR STRIPES after Row 28 and have only 3 sets of color stripes then continue with color 1 only. Work all shapings the same.

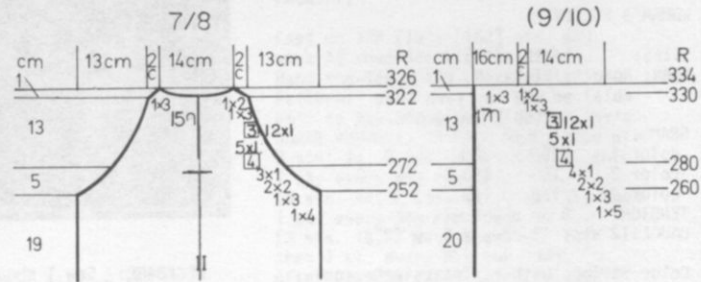

BACK: II

Work the BACK sections (2) exactly the same as the front sections except for the NECK SHAPING. Mark Row 272 (280) for center seam (and sew back seam to these markers). FOR THE NECK SHAPING, after Row 321 (329), bind off 15 (17) sts. then bind off 3 sts. 1x for both sizes. Work Shoulder same as the front after Row 322 (330). Sew the two back sections together up to the marked Row. Work 1 row single crochet around neck opening. Make chain loops for buttonholes and sew buttons to other side.

NECKBAND:

Sew 1 shoulder first, then pick up 90 sts. around neckline with hand knitting needles and work 5 rows garter stitch - or finish in any way you wish.

ARMBANDS:

Pick up 114 sts. and work same as for the Neckband.

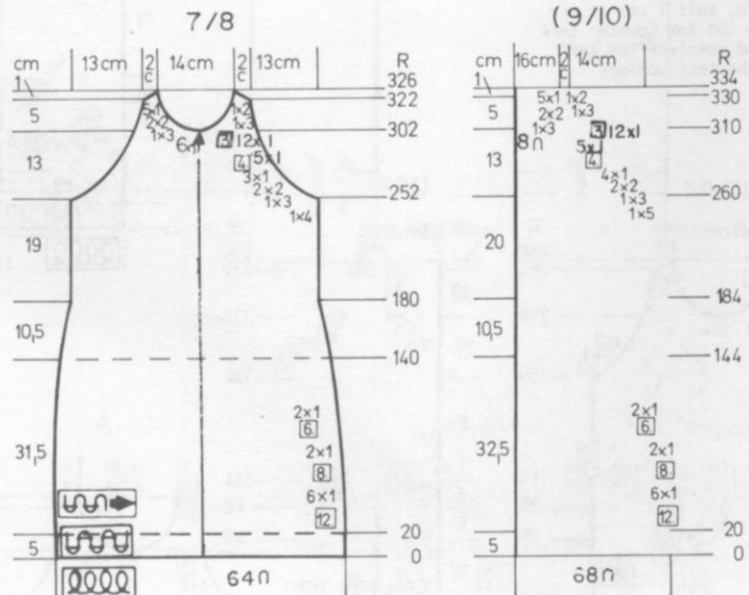

DK 986



WOMAN'S PULLOVER

SIZES: 8/10 (12)
 YARN: Vienna
 GRAMS:
 color 1 200 250
 color 2 100 100
 Small amounts of different colors for embroidery not included in Kit.
 TENSION: 4 to 7
 GAUGE: 15 sts. 19 rows = 5 cm (2")

Stockinette stitch with Intarsia on the Front section. Bands are Garter stitch worked on hand knitting needles or you can pick up the sts. and work K1, P1 Ribbing on the machine.

FINISHING: See General Instructions. Work 1 row single crochet down back neck opening making chain loop for buttonhole. Sew Button to left side. Embroider the Butterfly on front section. See Picture.

FRONT: I

Cast on 140 (150) sts. with color 2 and work 12 rows of K1, P1 Ribbing. Continue in Stockinette stitch with color 2 and ON EACH SIDE, decrease 1 st. every 12th row 3x for both sizes.

After Row 58 (62) begin the INTARSIA Design. Start with 2 sts. in color 1 and ON EVERY ROW, work 1 more stitch in color 1, crossing the yarns when changing color to prevent a hole.

After Row 150 (158) SHAPE ARMHOLE. ON EACH SIDE, bind off 4 sts. 1x, 3 sts. 1x, 2 sts. 2x, 1 st. 4x for both sizes.

After Row 200 (208), bind off the center 14 (16) sts., put the needles on the left into holding position and complete the right side first.

*ON NECK SIDE, bind off 3 sts. 1x, 2 sts. 2x, 1 st. 4x, 1 st. every 4th row 4x for both sizes.

After Row 226 (234), SHAPE SHOULDER. Bind off 10 sts. 3x. (10 sts. 1x, 12 sts. 2x). Bring the needles on the left into working position, knit 1 row to the left side, turn the Row Counter back to 200 (208) and complete the left half. Follow the instructions from *.

8 / 10

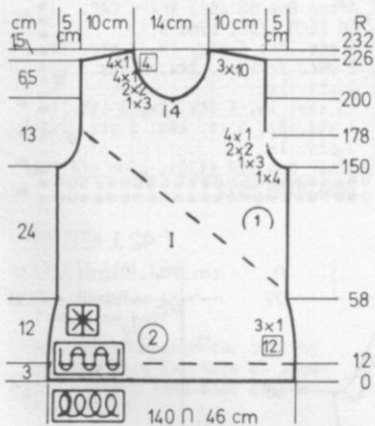

(12)

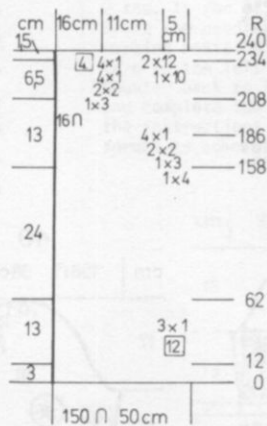

BACK: II

Work the back the same as the front EXCEPT begin with color 1 and after Row 58, (62) start with the 2 sts. in color 2. Work in the same way to Row 150 (158). SHAPE ARMHOLE same as the front and after Row 192 (200) divide in the center. Put the needles on the left into holding position and complete the right side first.

*After Row 220 (228) SHAPE NECK. ON NECK SIDE, bind off 16 (17) sts. 1x, then bind off 3 sts. 1x, 2 sts. 1x, 1 st. 1x for both sizes and after Row 226 (234) SHAPE SHOULDER same as the front.

Bring the needles on the left into working position, knit 1 row to the left side, turn the Row Counter back to 192 (200) and complete the left half. Follow the instructions from *.

8 / 10

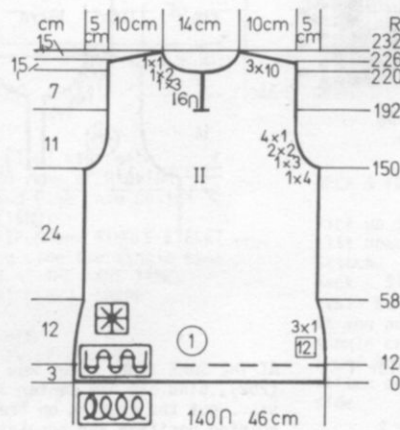

(12)

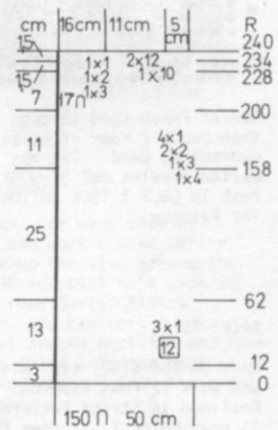

NECKBAND:

With color 1, cast on 120 (126) sts. and work 6 rows of Ribbing - or you can pick up the sts. and work Garter Stitch with hand knitting needles. Bind off.

ARMBANDS:

Work the right armband in color 1 and left with color 2. Cast on 107 (113) sts. and work same as for the Neckband.

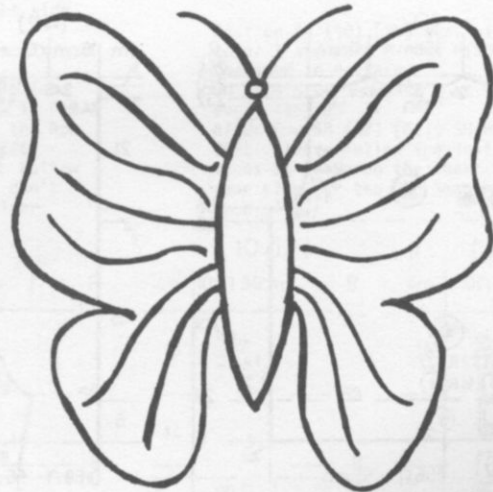

DK 987

MAN'S PULLOVER

SIZES: 40 (42)
YARN: Vienna
GRAMS:
 color 1 300 350
 color 2 50 50
TENSION: 4 to 7
GAUGE: 15 sts. 19 1/2 rows = 5 cm (2")



Stockinette stitch and stripes with a TUCK Stitch Pattern for upper section and sleeves. Bands are K1, P1 Ribbing. Punch your own card and push the marked needles (every 6th & 8th) to the OUT OF WORK POSITION. Push in 1 Tuck Button only.

FINISHING: See General Instructions.

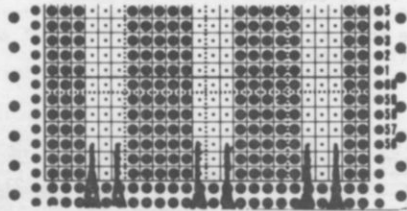

REPEAT Punch Card through Row 35 then punch 2 rows of holes for connecting Card. Set the marked needles OUT OF WORK. Push in ONLY 1 TUCK BUTTON for Pattern.

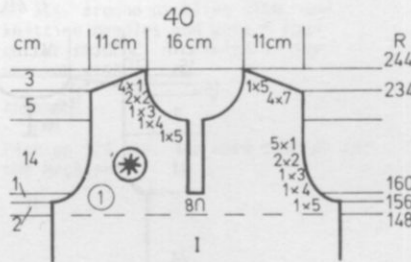

FRONT: I

Work the front the same as the back to Row 148 (156). Continue in Tuck Pattern and after Row 156 (164) SHAPE ARMHOLE same as the back BUT AT THE SAME TIME, after Row 160 (168) bind off the center 8 sts., put the needles on the left into holding position and complete the right side first. *Knit to Row 218 (230). After Row 219 (231) ON NECK SIDE bind off
 5 sts. 1x, 4 sts. 1x, 3 sts. 1x, 2 sts. 2x, 1 st. 4x.
 (5 sts. 1x, 4 sts. 1x, 3 sts. 2x, 2 sts. 2x, 1 st. 4x).
 SHAPE SHOULDER same as the back after Row 234 (246). Bring the needles on the left into working position, knit 1 row in Pattern to the left side, turn the Row Counter back to 160 (168) and complete the left half. Follow the instructions from *

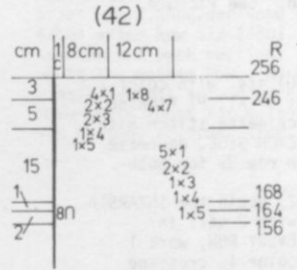

BACK: II

Cast on 156 (168) sts. with color 1 and work 22 rows Ribbing. Continue in Stripe Pattern of 14 rows Color 1, 2 rows Color 2. After Row 148 (156), continue in TUCK PATTERN with color 1. After Row 156 (164), SHAPE ARMHOLE: ON EACH SIDE, bind off 5 sts. 1x, 4 sts. 1x, 3 sts. 1x, 2 sts. 2x, 1 st. 5x for both sizes. After Row 232 (244) SHAPE SHOULDER and WATCH FOR NECK SHAPING. FOR SHOULDER, bind off ON EACH SIDE, 7 sts. 4x, 5 sts. 1x. (7 sts. 4x, 8 sts. 1x).

AT THE SAME TIME, after Row 240 (252), bind off the center 38 (44) sts., put the needles on the left into holding position and complete the right side first.

*ON NECK SIDE, bind off 5 sts. 2x for both sizes.

Bring the needles on the left into working position, knit 1 row in Pattern to the left side, turn the Row Counter back to 240 (252) and complete the left half. Follow the instructions from * and don't forget to complete the shoulder shaping.

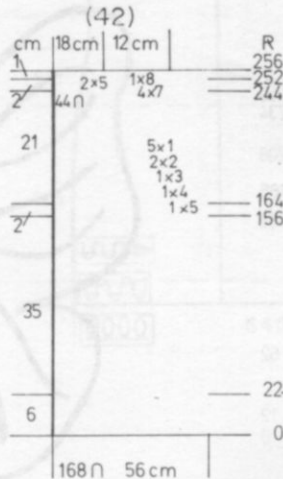
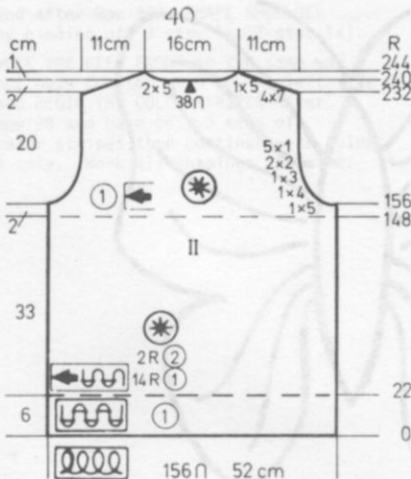

NECK & FRONT BANDS:

Cast on 153 (159) sts. with color 1 and work K1, P1 Ribbing. After Row 7, make a Buttonhole on the left side over needles 4, 5, 6. After Row 10, remove the center 127 (133) sts. onto waste yarn or you can bind them off if you prefer. Work K1, P1 Ribbing over the right 13 sts. for approximately 36 rows. 10.5 cm (4 1/2") then bind them off. Repeat for the 13 sts. on the left but make buttonholes every 10 rows (2 more) same as you did before.

SLEEVES: III

Cast on 96 (102) sts. with color 1 and work 12 rows Ribbing. Continue in TUCK Pattern. ON EACH SIDE, increase 1 st. every 7th row 6x for both sizes. After Row 58 (62) SHAPE CAP: ON EACH SIDE, bind off
 5 sts. 1x, 4 sts. 1x, 3 sts. 1x, 2 sts. 2x 1 st. 24x, 2 sts. 2x, 3 sts. 1x.
 (5 sts. 1x, 4 sts. 1x, 3 sts. 1x, 2 sts. 2x, 1 st. 26x, 2 sts. 2x, 3 sts. 1x.
 After Row 122 (130), bind off the remaining sts.

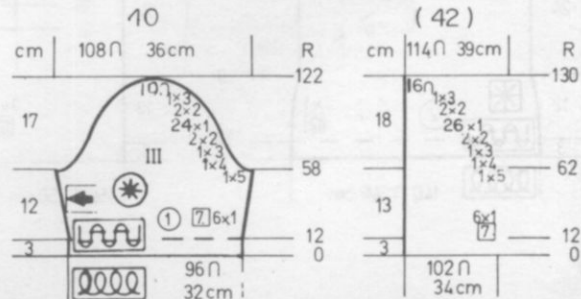

DK 988

WOMAN'S PULLOVER

SIZES: 7/8 (10/12) [14]
 YARN: Vienna
 GRAMS:
 color 1 250 300 300
 color 2 50 50 50
 color 3 50 50 50
 color 4 50 50 50
 TENSION: 4 to 7
 GAUGE: 15 sts. 19 rows = 5 cm (2")



Lace and Fine Lace are used for Pattern I with a Single Eyelet Row and color stripes for for the Yoke of this Pullover. Punch your own Cards and follow the changes as shown along side the Punch Cards. Bands are K1, P1 Ribbing except for Neck and front bands which are either Garter Stitch or you can work single crochet into the back stitches only.

FINISHING: See General Instructions.

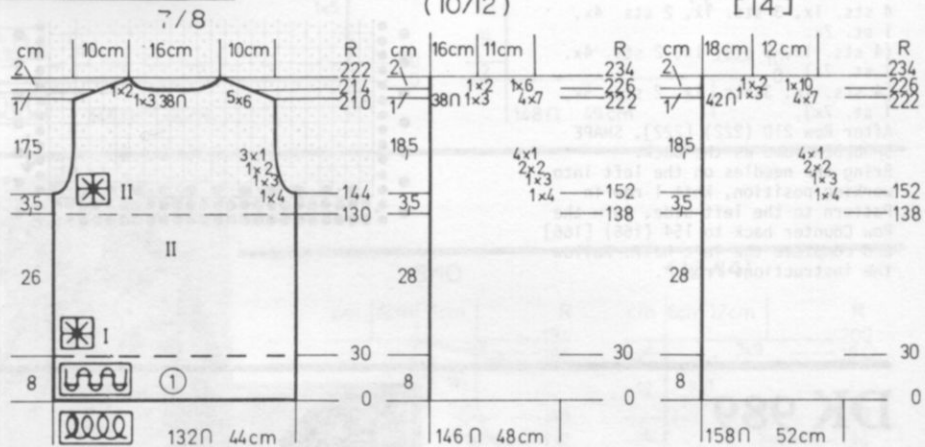
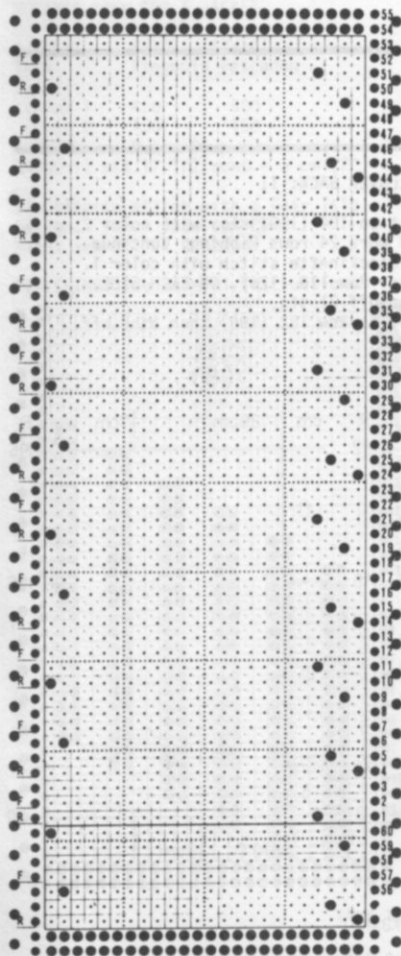

BACK: II

Cast on 132 (146) [158] sts. with color 1 and work 30 rows of Ribbing. Continue in Lace and Fine Lace Design to Row 130 (138) [158]. Work the COLOR STRIPES and SINGLE EYELET rows as shown along side the single eyelet Punch Card and AT THE SAME TIME, after Row 144 (152) [152], SHAPE ARMHOLE:
 ON EACH SIDE bind off
 4 sts. 1x, 3 sts. 1x, 2 sts. 1x,
 1 st. 3x.
 (4 sts. 1x, 3 sts. 1x, 2 sts. 2x,
 1 st. 4x).
 [4 sts. 1x, 3 sts. 1x, 2 sts. 2x,
 1 st. 4x].
 After Row 210 (222) [222], SHAPE SHOULDER and WATCH FOR NECK SHAPING. FOR SHOULDER, bind off ON EACH SIDE, 6 sts. 5x.
 (7 sts. 4x, 6 sts. 1x).
 [7 sts. 4x, 10 sts. 1x].
 FOR NECK: After Row 214 (226) [226], bind off the center 38 (38) [42] sts., put the needles on the left into holding position and complete the right side first.
 *ON NECK SIDE, bind off 3 sts. 1x, 2 sts. 1x for all sizes.
 Bring the needles on the left into working position, knit 1 row in Pattern to the left side, turn the Row Counter back to 214 (226) [226] and complete the left half. Follow the instructions from * and don't forget to complete the shoulder

NECK & FRONT BANDS:

Pick up 30 sts. for each side of slit opening and work 6 rows Garter Stitch- Pick up the sts. around the neck - 31 - 48 for back neck then 31 sts. Work 6 rows Garter Stitch. If you prefer, you can work 4 rows single crochet around neckline and down front opening going into the back of stitch only and working from the right side.

SLEEVES: III

Cast on 84 (90) [96] sts. with color 1 and work 8 rows Ribbing. Continue in Pattern I. ON EACH SIDE increase 1 st. every 4th row 7x.
 After Row 58 (62) [62], SHAPE CAP: Please follow the instructions as shown on the Chart for your size for the Cap Shaping on each side.

PATTERN I

LACE & FINE LACE.

R = Regular Lace
 F = Fine Lace

Be sure to change the setting on your Lace Carriage as shown on the left hand side of the Punch Card.

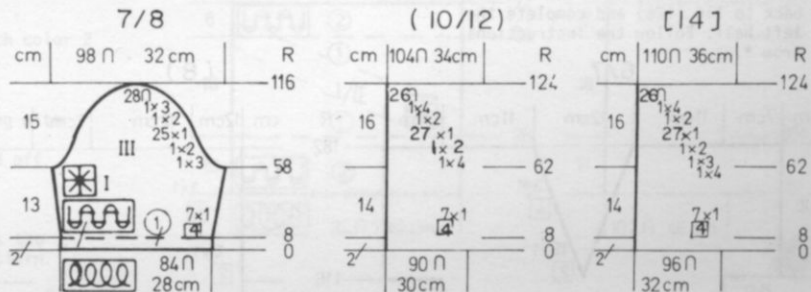

DK 988

FRONT: I

Work the front the same as the back to Row 130 (138) [138]. Change to Pattern II and after Row 144 (152) [152], SHAPE ARMHOLE SAME AS THE BACK. After Row 154 (166) [166], bind off the center 4 sts., put the needles on the left into holding position and complete the right side first.

*Knit to Row 193 (205) [205].

ON NECK SIDE, bind off

4 sts. 1x, 3 sts. 1x, 2 sts. 4x, 1 st. 2x.

(4 sts. 1x, 3 sts. 1x, 2 sts. 4x, 1 st. 7x).

[4 sts. 1x, 3 sts. 1x, 2 sts. 5x, 1 st. 7x].

After Row 210 (222) [222], SHAPE SHOULDER same as the back.

Bring the needles on the left into working position, knit 1 row in Pattern to the left side, turn the Row Counter back to 154 (166) [166] and complete the left half. Follow the instructions from *.

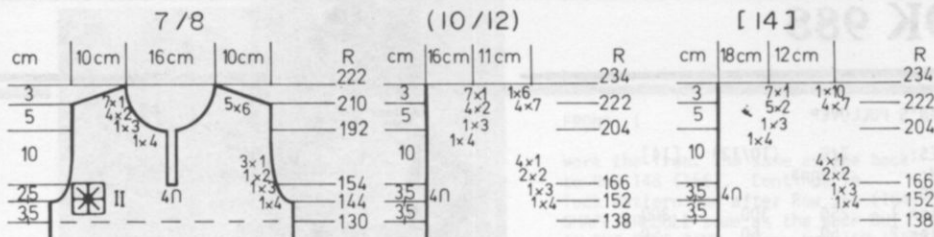

PATTERN II

COLOR STRIPES AND SINGLE EYELET ROWS.

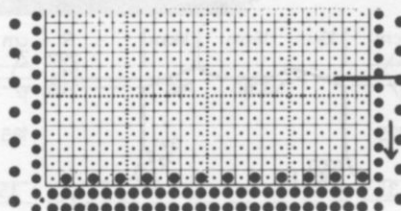

*4 rows color 1
2 rows color 3
8 rows color 2
2 rows color 1
Work EYELET ACROSS
2 rows color 1
2 rows color 4
2 rows color 1
Work EYELET ACROSS
8 rows color 1
2 rows color 3
8 rows color 2
REPEAT FROM *.

DK 989

CHILD'S PULLOVER & SHORTS

SIZES: 6/7 (8)

YARN: Amore

GRAMS:

color 1 350 400
color 2 50 50
color 3 50 50
color 4 50 50

TENSION: 5 to 7

GAUGE: 15 sts. 20 1/2 rows = 5 cm (2")

Stockinette stitch with bands in K2, P2 Ribbing.

FINISHING: See General Instructions. Make casing at top of shorts and pull elastic through. Sew on Neckband and armbands. Crochet a circle using all colors then sew onto the left side of Pullover (See Picture).

FRONT: I

Work the front the same as the back to Row 116 (126).

ON EACH SIDE, bind off 21 sts.

Divide in the center, put the left half into holding position and complete the right side first.

*ON NECK SIDE, on every 2nd row decrease 1 st. 15x then every 4th row decrease 1 st. 3x.

After Row 182 (196), bind off the remaining sts.

Bring the needles on the left into working position, turn the Row Counter back to 116 (126) and complete the left half. Follow the instructions from *.

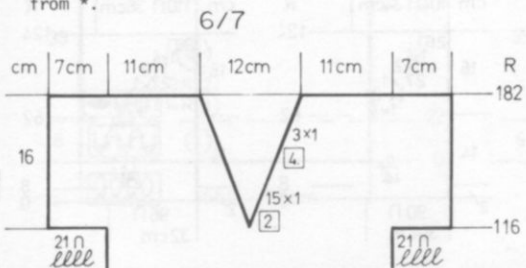

6/7

PULLOVER BACK: II

Cast on 104 (110) sts. with color 2 and work 24 rows Ribbing. Continue in Stockinette stitch with color 1. After Row 116 (126), ON EACH SIDE, bind off 21 sts. Knit to Row 182 (196) then bind off.

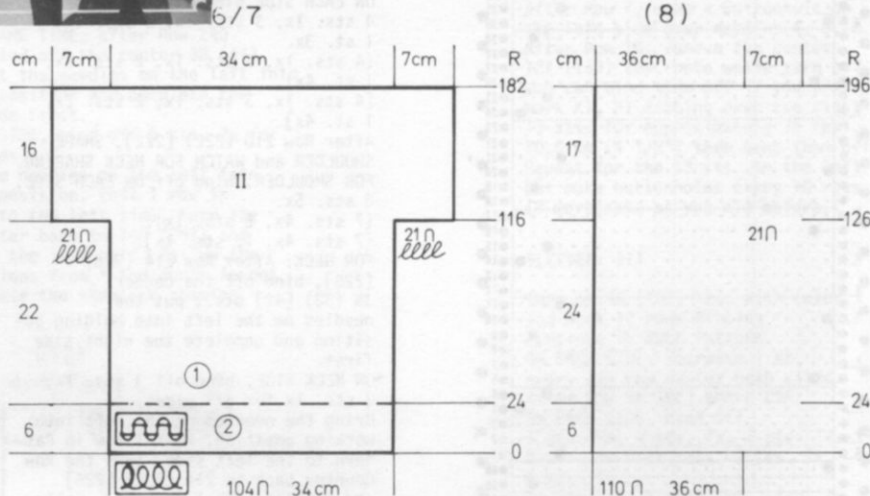

NECKBAND:

Cast on 172 (184) sts. with color 3 and work K2, P2 Ribbing. ON EACH SIDE, on every 2nd row, decrease 1 st. 4x. After Row 8 bind off.

ARMBANDS:

Cast on 116 (126) sts. with color 4 and work Ribbing same as Neckband. After Row 8, bind off.

DK 989

SHORTS: Make 1 reverse 1.

Cast on 140 (148) sts. with color 1 and work 10 rows Ribbing. Continue in Stockinette stitch. After Row 44 (48), ON EACH SIDE, bind off 5 sts. 1x, 4 sts. 1x, 3 sts. 1x, 2 sts. -x, 1 st. 2x, for both sizes. Knit to Row 153 (163) For second section, knit to Row 152 (162). Work SHORT ROWS: ON OPPOSITE SIDE OF CARRIAGE, put into holding position 8 sts. 1x, 16 sts. 6x. (4 sts. 1x, 18 sts. 6x). After Row 166 (176) bring all the needles into working position and bind off.

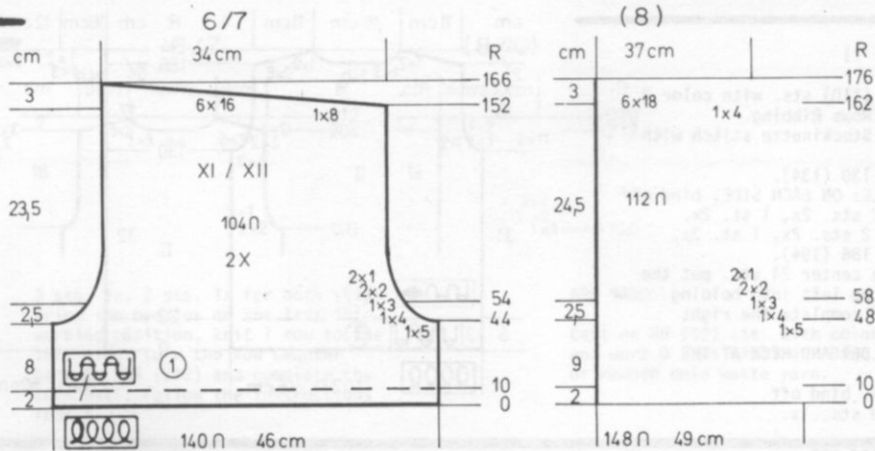

DK 990

DK 990

WOMAN'S TANK TOP & JACKET

SIZES: 8/10 (12/14)
YARN: Pingouin Pescadou
GRAMS: color 1 450 500, color 2 150 150
TENSION: 8 to 10
GAUGE: 11 sts. 17 1/2 rows = 5 cm (2")



Stockinette stitch with a Fair Isle Design. Punch your own Card. Bands are K2, P2 Ribbing.

FINISHING: See General Instructions.

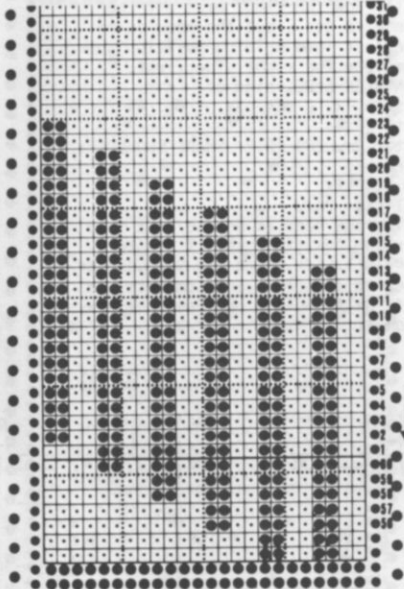

JACKET RIGHT FRONT: I Reverse shaping for left front and omit Pattern.

Cast on 48 (52) sts. with color 2 and work 22 rows Ribbing. Continue in Stockinette stitch with color 1. Knit to Row 130 (134). SHAPE ARMHOLE same as the back BUT AT THE SAME TIME, work the Pattern and after Row 147 (151), SHAPE NECK: Bind off 3 sts. 1x, 2 sts. 2x, 1 st. 3x, 1 st. every 4th row 4x for both sizes. After Row 186 (194), SHAPE SHOULDER same as the back.

SLEEVES: III

Cast on 62 (66) sts. with color 1 and work Stockinette stitch. ON EACH SIDE, increase 1 st. every 10th row 6x. After Row 70 (74), SHAPE CAP: ON EACH SIDE, bind off 3 sts. 1x, 2 sts. 1x, 1 st. 23x (25x), 2 sts. 1x, 3 sts. 1x then bind off the remaining sts.

TANK TOP FRONT: I

Cast on 94 (102) sts. with color 2 and work 36 rows Ribbing. Continue with Pattern. Knit to Row 90 (94). Continue in K2, P2 Ribbing with color 2. After Row 112 (120), bind off.

TANK TOP BACK: II

Work the back the same as the front except omit the Pattern.

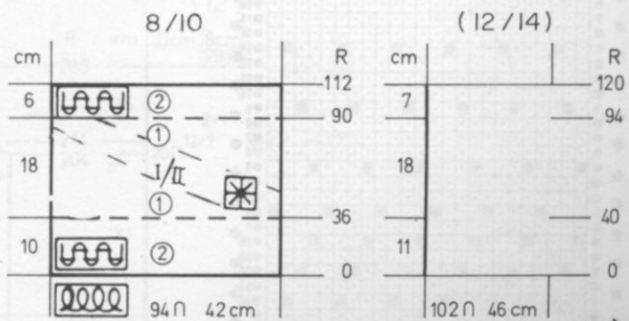
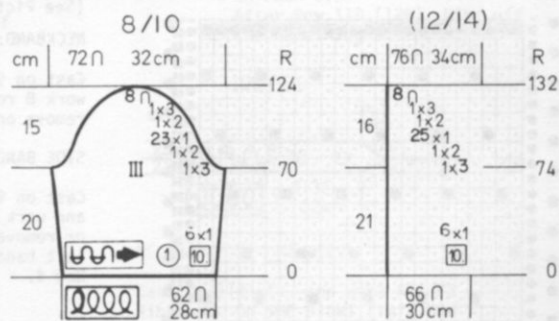
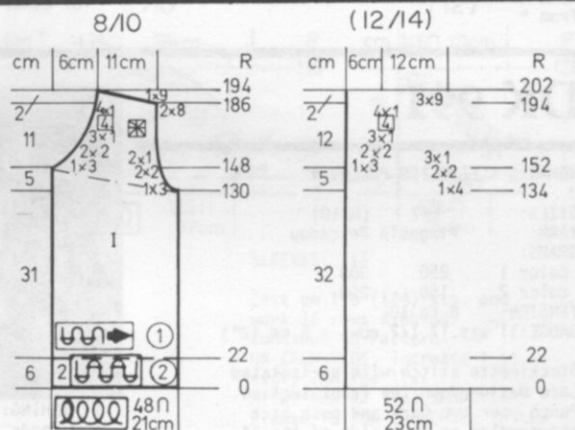

DK 990

JACKET BACK: II

Cast on 102 (110) sts. with color 2 and work 22 Rows Ribbing. Continue in Stockinette stitch with color 1.
 Lmot tp Row 130 (134).
SHAPE ARMHOLE: ON EACH SIDE, bind off 3 sts. 1x, 2 sts. 2x, 1 st. 2x. (4 sts. 1x, 2 sts. 2x, 1 st. 3x. Knit to Row 186 (194). Bind off the center 24 sts. put the needles on the left into holding position and complete the right side first.
***SHAPE SHOULDER AND NECK AT THE SAME TIME.**
FOR SHOULDER, bind off 8 sts. 2x, 9 sts. 1x. (9 sts. 3x).
FOR NECK, bind off 3 sts. 1x, 2 sts. 1x for both sizes. Bring the needles on the left into working position, knit 1 row to the left side, turn the Row Counter back to 186 (194) and complete the left half. Follow the instructions from *

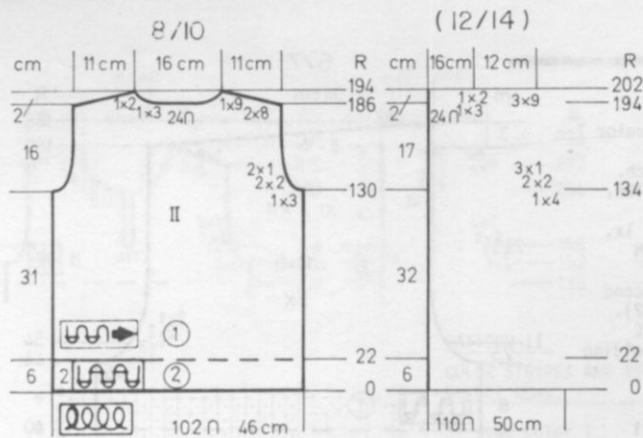

FRONT BANDS:

Pick up the sts. down front edge and work 10 rows Ribbing. Repeat for other side.

NECKBAND:

After sewing up 1 shoulder, pick up the sts. around neck and work 10 rows Ribbing. Bind off.

DK 991

WOMAN'S SLEEVELESS PULLOVER

SIZES: 6/7 (8/10)
YARN: Pingouin Pescadou
GRAMS:
 color 1 250 300
 color 2 150 200
TENSION: 8 to 10
GAUGE: 11 sts. 17 1/2 rows = 5 cm (2")

Stockinette stitch with an isolated Lace Design down the front section. Punch your own Card and push back the needles on each side of the 24 stitch Design. Bands K2, P2 Ribbing.



FINISHING: See General Instructions. Sew bands in place with button and Buttonhole band on the left side. (See Picture).

NECKBAND:

Cast on 90 sts. with color 2 and work 8 rows Ribbing. Bind off or remove onto waste yarn.

SIDE BANDS: Make 4.

Cast on 90 (95) sts. with color 2 and work 8 rows Ribbing. Bind off or remove onto waste yarn. On left band, work 3 Buttonholes after Row 4.

FRONT: I

Cast on 88 (98) sts. with color 2 and work 18 rows Ribbing. Continue in color 1, working the Lace Design down the center front. After Row 140 (144), **SHAPE ARMHOLE: ON EACH SIDE, bind off** 2 sts. 2x, 1 st. 3x. (3 sts. 1x, 2 sts. 2x, 1 st. 3x). After Row 180 (188) bind off the center 8 sts., put the needles on the left into holding position and complete the right side first.
***ON NECK SIDE, bind off** 3 sts. 1x, 2 sts. 3x, 1 st. 4x for both sizes.
After Row 204 (212) SHAPE SHOULDER: Bind off 10 sts. 2x. (11 sts. 2x). Bring the needles on the left into working position, knit 1 row to the left side, turn the Row Counter back to 180 (188) and complete the left half. Follow the instructions from *.

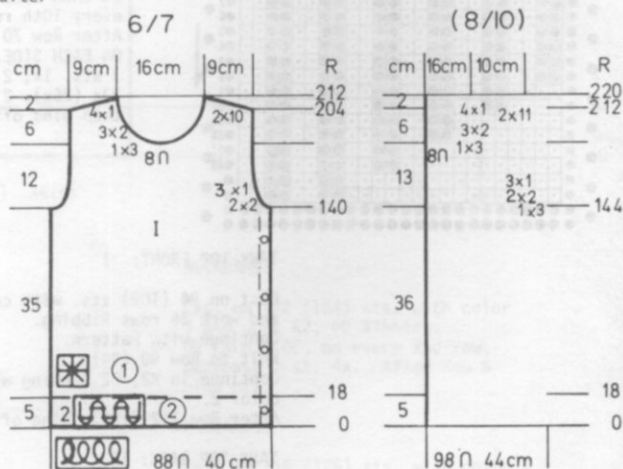
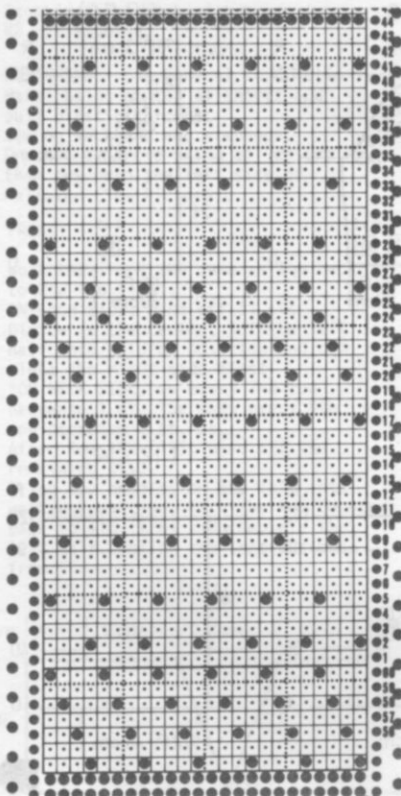

DK 991

BACK: II

Work the back the same as the front to Row 140 (144).
SHAPE ARMHOLE same as the front then knit to Row 204 (212).
Bind off the center 24 sts., put the needles on the left into holding position and complete the right side first.

*SHAPE SHOULDER AND NECK AT THE SAME TIME.

FOR SHOULDER, bind off

10 sts. 2x.

(11 sts. 2x).

FOR NECK, bind off

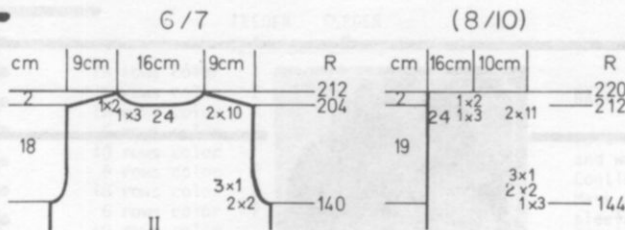

3 sts. 1x, 2 sts. 1x for both sizes. Bring the needles on the left into working position, knit 1 row to the left side, turn the Row Counter back to 204 (212) and complete the left half. Follow the instructions from *.

ARM BANDS:

Cast on 80 (90) sts. with color 2 and work 8 rows Ribbing. Bind off or remove onto waste yarn.

DK 992

WOMAN'S PULLOVER

SIZES: 8/10 (12)

YARN: 2/20 or any yarn to give stitch & Row Gauge.

AMOUNT: 1 Cone

TENSION: 2 to 3

GAUGE: 18 sts. 25 1/2 rows = 5 cm (2")

NO KIT AVAILABLE

A Lace Pattern. Punch your own Card. The bands are K2, P2 Ribbing.

FINISHING: See General Instructions. Sew back seam of neckband then sew 1 edge to outside and to the inside of neckline.

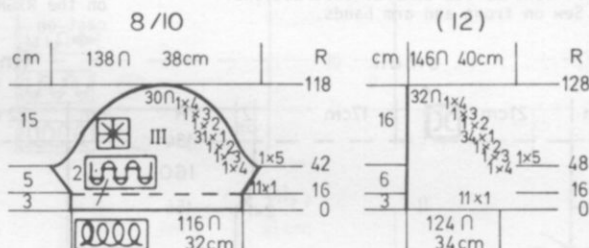

SLEEVES: III

Cast on 116 (124) sts. and work 16 rows Ribbing. Continue in Pattern. ON EACH SIDE, increase 1 st. every 2nd row 11x. After Row 42 (48) SHAPE CAP: Please follow the Chart in the size you need for the Cap Shaping ON EACH SIDE. After Row 118 (128), bind off the remaining sts.

GR. I/II

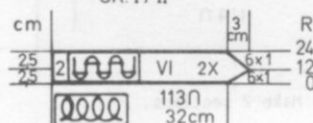

NECKBAND: VI Make 2.

Cast on 113 sts. and work K2, P2 Ribbing. ON THE RIGHT (left for 2nd section), increase 1 st. every 2nd row 6x then decrease 1 st. 6x. After Row 24, bind off.

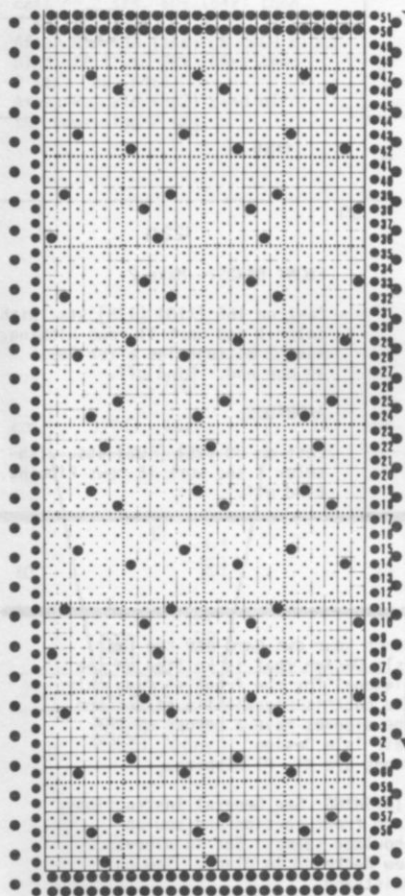

FRONT & BACK: I/II Both sections the same.

Cast on 160 (174) sts. and work 50 rows of Ribbing. Continue in Pattern. Knit to Row 204 (210).

SHAPE ARMHOLE: ON EACH SIDE bind off 5 sts. 1x, 4 sts. 1x, 2 sts. 3x, 1 st. 3x.

(5 sts. 1x, 4 sts. 1x, 2 sts. 3x, 1 st. 3x).

After Row 214 (220), bind off the center 20 sts., put the needles on the left into holding position and complete the right side first.

*ON NECK SIDE, bind off 2 sts. 12x, 1 st. 2x for both sizes.

After Row 286 (296) bind off the remaining sts.

Bring the needles on the left into working position, knit 1 row in Pattern to the left side, turn the Row Counter back to 204 (210) and complete the left half. Follow the instructions from *.

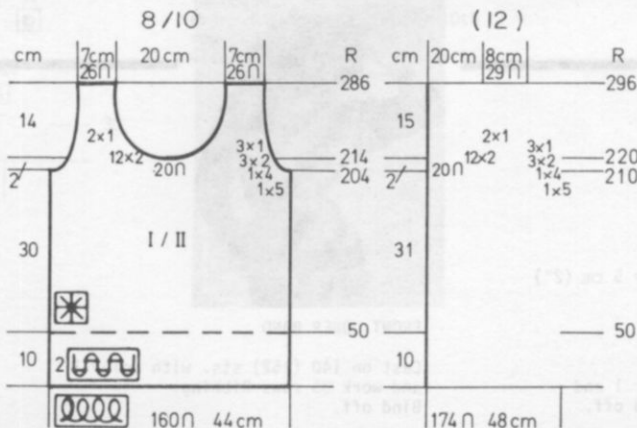

DK 993

WOMAN'S VEST

SIZES: Small (Medium) [Large]
 YARN: Amore
 GRAMS:
 color 1 100 100 150
 color 2 50 50 50
 color 3 50 50 50
 color 4 50 50 50
 color 5 50 50 50
 TENSION: 5 to 7
 GAUGE: 14 sts. 18 rows = 5 cm (2")

Stockinette stitch with color stripes as shown on the Chart. Knitted sideways on the machine. Bands are K1, P1 Ribbing.

FINISHING: See General Instructions. Sew on front and arm bands.



To the extreme left of machine cast on 6 (5) [3] sts. with color 1 and work Stockinette stitch with REPEATED color stripes of 4 rows color 1, 4 rows color 2, 4 rows color 4, 4 rows color 3, 4 rows color 5 AND AT THE SAME TIME on the RIGHT, on every 2nd row cast on

6 sts. 18x.
 (6 sts. 13x, 7 sts. 5x).
 [6 sts. 19x, 5 sts. 1x].
 Continue in the color stripes. Knit to Row 80 (84) [90].
 Bind off 53 (56) [59] sts.
 Knit to Row 110 (114) [120].
 Cast on 53 (56) [59] sts.
 Knit to Row 154 (162) [174].
 SHAPE NECK: Bind off 1 st. 2x, 2 sts. 1x for all sizes. After Row 184 (192) [204], work the 2nd half with reverse shaping, casting on for the neck shaping and binding off for the front shaping.

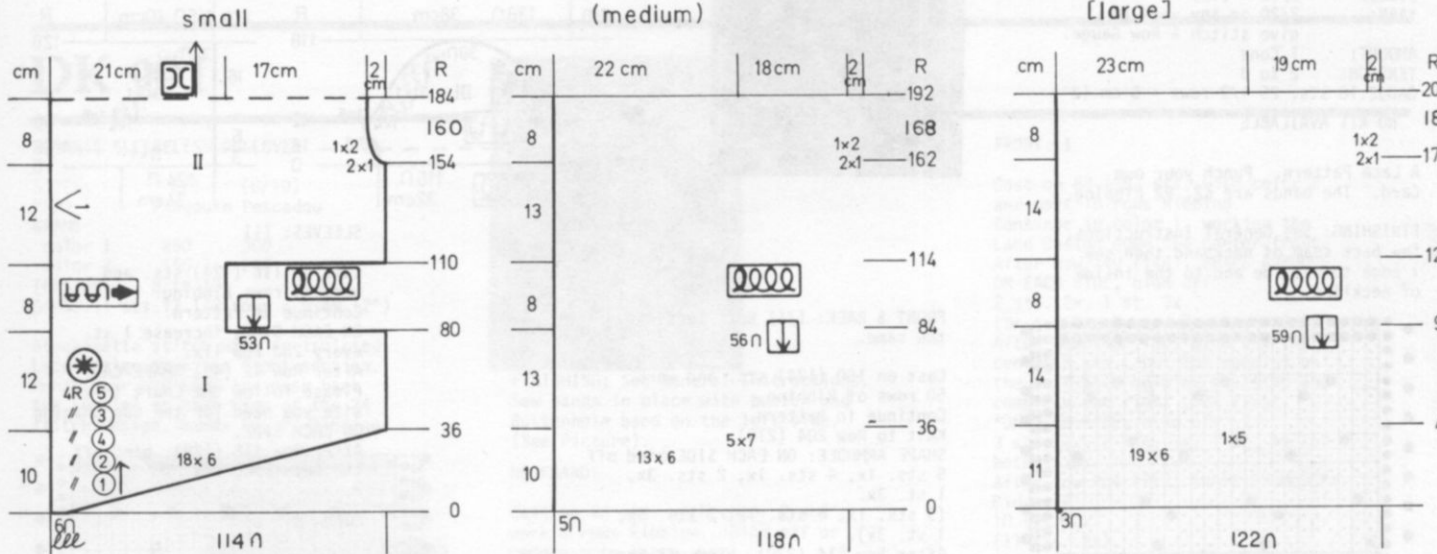

WAISTBAND: Make 2 sections.

Cast on 115 (120) [135] sts. with color 1 and work 22 rows Ribbing. Bind off.

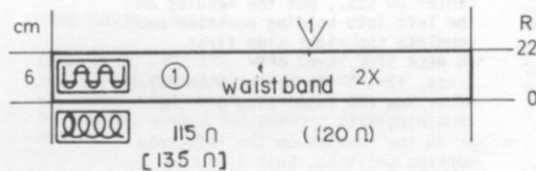

FRONT BANDS: Make 2

Cast on 165 (170) [175] sts. with color 1 and work 11 rows Ribbing. Make 2 Buttonholes after Row 5 at one end. Bind off.

ARMBANDS:

Cast on 90 (96) [102] sts. with color 1 and work 15 rows Ribbing. Bind off.

DK 994

WOMAN'S PULLOVER

SIZES: 8/10 (12/14)
 YARN: Amore
 GRAMS:
 color 1 250 300
 color 2 100 150
 color 3 100 100
 TENSION: 5 to 7
 GAUGE: 15 sts. 20 1/2 rows = 5 cm (2")

NECKBAND:

Cast on 108 sts. with color 1 and work 13 rows Ribbing. Bind off.



FRONT LOWER BAND

Cast on 140 (152) sts. with color 1 and work 36 rows Ribbing. Bind off.

Punch your own Card for the Fair Isle Design that is knitted on the diagonal for the front section only. The back is Stockinette stitch and the sleeves have a border of the Fair Isle Design. Bands are K1, P1 Ribbing.

FINISHING: See General Instructions. Turn front section and sew up shoulder seams. Set in sleeves. Sew neckband in place. Sew on Waistband.

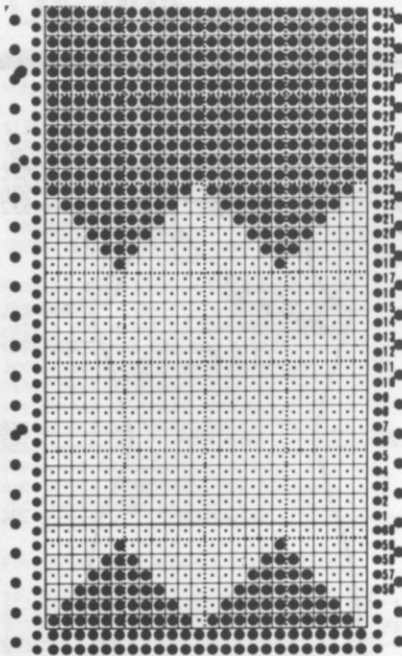

FEEDER A FEEDER B

18 rows color 1
 * 6 rows color 2 & 1
 18 rows color 2
 6 rows color 2 & 3
 10 rows color 2 3
 6 rows color 2 & 3
 18 rows color 2 3
 6 rows color 2 & 1
 10 rows color 2 1
 REPEAT FROM *

BACK: II

Cast on 140 (152) sts. with color 1 and work 36 rows Ribbing. Continue in Stockinette stitch. Mark Row 142 (150) for setting in sleeves then knit to Row 224 (240). Bind off.

FRONT: I

Cast on 2 sts. with color 1 and work in Pattern as shown along side the Punch Card and AT THE SAME TIME ON EACH SIDE, on every 2nd row, cast on 2 sts. 60x (64x) then 1 st. 78x (82x). After Row 138 (146) ON EACH SIDE, bind off 1 st. 78x (84x) then 2 sts. 60x (64x). After Row 276 (292) bind off the remaining 2 sts.

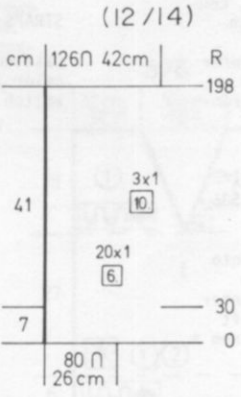
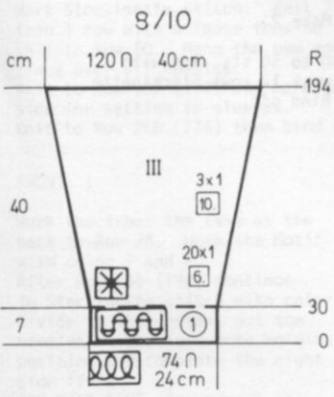
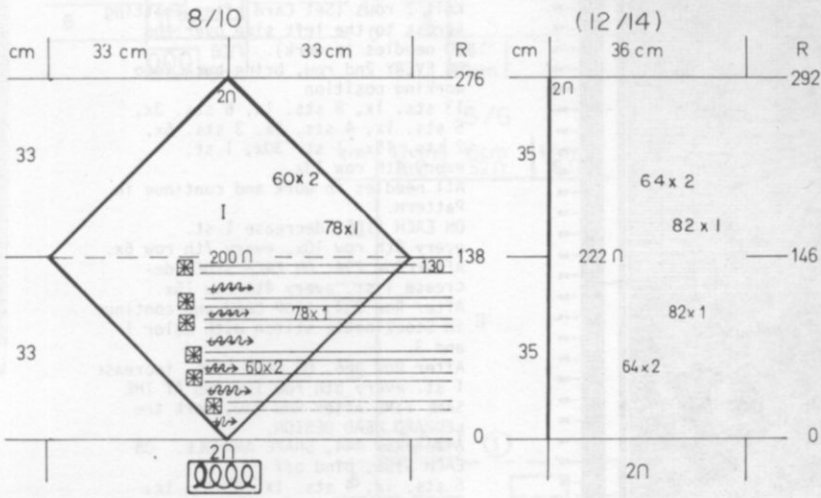
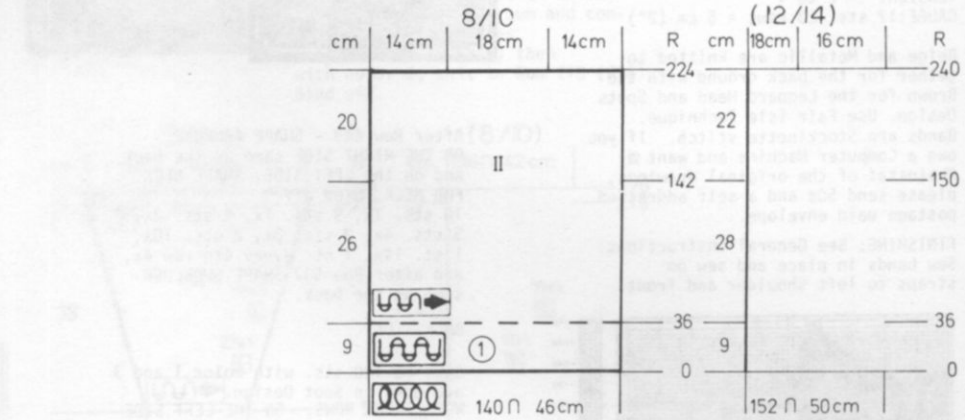

SLEEVES: III

Cast on 74 (80) sts. with color 1 and work 30 rows Ribbing. Work the Punch Card 1x only and AT THE SAME TIME, ON EACH SIDE increase 1 st. every 6th row 20x, every 10th row 3x. After Row 194 (198) bind off.

DK 995

WOMAN'S DRESS

SIZE 7/8

YARN: Vienna plus Metallic Mami Rex

GRAMS:

color 1 = Beige) Knitted
color 3 = Metallic Mami Rex } together
color 2 = Brown

TENSION: 2 to 4

GAUGE: 17 sts. 23 rows = 5 cm (2")

Beige and Metallic are knitted together for the back ground with the Brown for the Leopard Head and Spots Design. Use Fair Isle Technique. Bands are Stockinette stitch. If you own a Computer Machine and want a Photostat of the original drawings, please send 50¢ and a self addressed postage paid envelope.

FINISHING: See General Instructions. Sew bands in place and sew on straps to left shoulder and front.

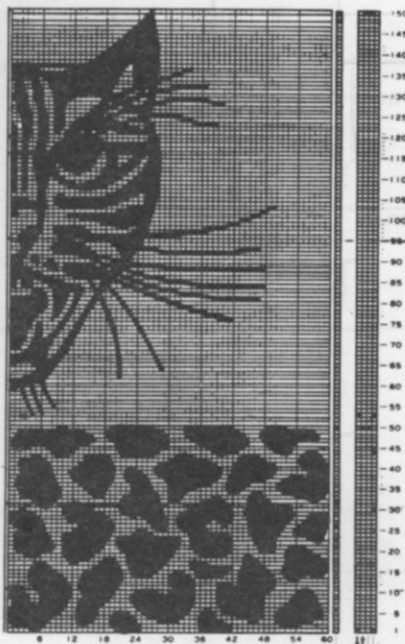

FRONT: I

For the FRONT, cast on 180 sts. from RIGHT TO LEFT. Carriage should be on the LEFT SIDE at 0 and work the Short Rows same as back but on the RIGHT SIDE. Set Card from RIGHT TO LEFT.

Work in the LEOPARD SPOT DESIGN throughout and all decreases and increases are the same as for Back.

After Row 443 - SHAPE ARMHOLE ON THE RIGHT SIDE same as the back and on the LEFT SIDE, SHAPE NECK. FOR NECK, bind off 10 sts. 1x, 9 sts. 1x, 4 sts. 2x, 5 sts. 4x, 3 sts. 8x, 2 sts. 10x, 1 st. 14x, 1 st. every 4th row 4x, and after Row 537 SHAPE SHOULDER same as the back.

BACK: II

Cast on 180 sts. with color 1 and 3 and work in Spot Design. WORK SHORT ROWS: ON THE LEFT SIDE put 150 sts. into holding position. Knit 2 rows (Set Card after knitting across to the left side over the 30 needles in work). ON EVERY 2nd row, bring back into working position 13 sts. 1x, 8 sts. 1x, 6 sts. 3x, 5 sts. 1x, 4 sts. 2x, 3 sts. 6x, 2 sts. 15x, 1 st. 30x, 1 st. every 4th row 13x. All needles in work and continue in Pattern. ON EACH SIDE, decrease 1 st. every 8th row 10x, every 7th row 6x. After Row 294, ON EACH SIDE, decrease 1 st. every 4th row 15x. After Row 354. STOP CARD and continue in Stockinette stitch with color 1 and 3. After Row 366, ON EACH SIDE, increase 1 st. every 5th row 15x AND AT THE SAME TIME after Row 430, work the LEOPARD HEAD DESIGN. After Row 444, SHAPE ARMHOLE. ON EACH SIDE, bind off 6 sts. 1x, 4 sts. 1x, 3 sts. 1x, 2 sts. 2x, 1 st. 2x, 1 st. every 4th row 3x. When Leopard Head is completed, continue in Stockinette stitch with color 1 & 3. After Row 532, bind off the center 30 sts., put the needles on the left into holding position and complete the right side first. *WATCH FOR SHOULDER SHAPING. ON NECK SIDE, bind off 10 sts. 1x, 4 sts. 1x, 3 sts. 2x and AT THE SAME TIME after Row 536 SHAPE SHOULDER by binding off 5 sts. 1x, 4 sts. 3x. Bring the needles on the left into working position, knit 1 row to the left side, turn the Row Counter back to 532 and complete the left half. Follow the instructions from *

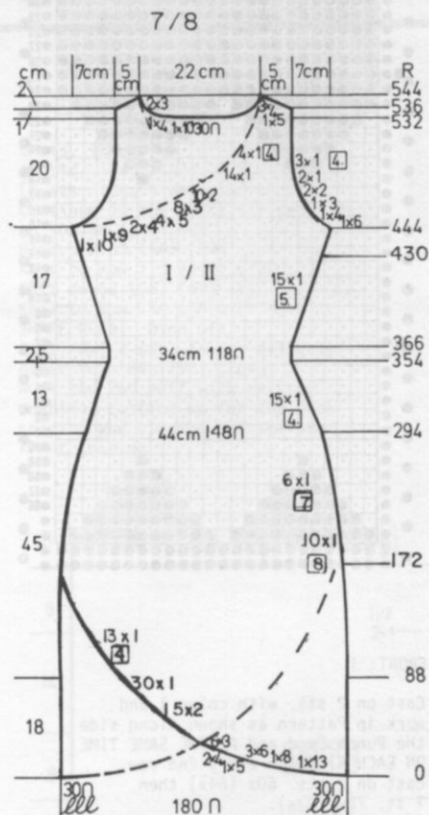

ARMBANDS:

Pick up the sts. with right side facing you, and with Color 2, work 12 rows Stockinette stitch. Fold in half and sew in place.

NECK BAND:

Pick up the sts. with right side facing you and with color 2 work 12 rows Stockinette stitch. Fold in half and sew in place.

STRAPS: Make 2.

Cast on 40 to 50 sts. and with color 2, work 12 rows Stockinette stitch. Bind off.

DK 996

WOMAN'S PULLOVER

SIZES: 5/6 (8/10)
 YARN: Amore
 GRAMS:
 color 1 400 450
 color 2 100 100
 TENSION: 5 or 6
 GAUGE: 16 sts. 21 1/2 rows = 5 cm (2")

Made on the Electronic Machine. If you own an Electronic Machine and want a photostat of the original drawings, send 50¢ and a self addressed postage paid envelope. Other machine owners can put in any design of their choice. Use Fair Isle Technique for the Design. Bands are Stockinette stitch over every 2nd needle for sleeve and lower bands and every needle for neckband.

FINISHING: See General Instructions.

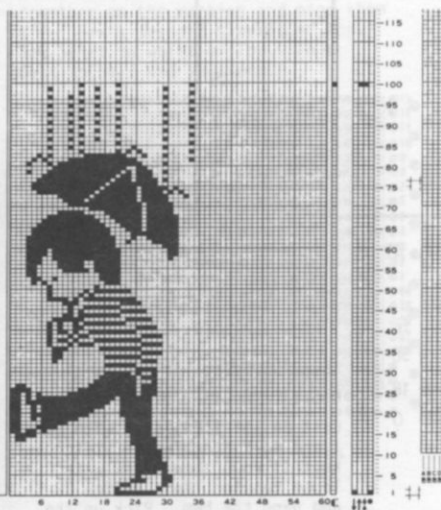

BACK: II

Bring 128 (136) needles into working position then push back every 2nd needle to the out of work position. Cast on over 64 (68) needles and with color 1 Work Stockinette stitch. Knit 25 rows then 1 row with a loose tension then knit to Row 50. Hang the hem and continue over all needles. Knit to Row 188 (192) and mark each side for setting in sleeves. Knit to Row 268 (276) then bind off.

FRONT: I

Work the front the same as the back to Row 76. Work the Motif with color 1 and 2. After Row 188 (192) continue in Stockinette stitch with color 1. Divide in the center, put the needles on the left into holding position and complete the right side first. *ON NECK SIDE, decrease 1 st. every 4th row 14x (16x), every 2nd row 12x (10x). After Row 268 (276), bind off. Bring the needles on the left into working position, knit 1 row to the left side, turn the row counter back to 188 (192) and complete the left half. Follow the instructions from *.



SLEEVES: III

Bring 60 (68) needles into working position then push back every 2nd needle to the out of work position. Cast on over the remaining 30 (34) needles and work Stockinette with color 1. Knit 25 rows then 1 row with a loose tension then knit to Row 50. Hang the hem and continue over all needles. Knit to Row 210 (218) then with color 2, knit to Row 218 (226). Bind off.

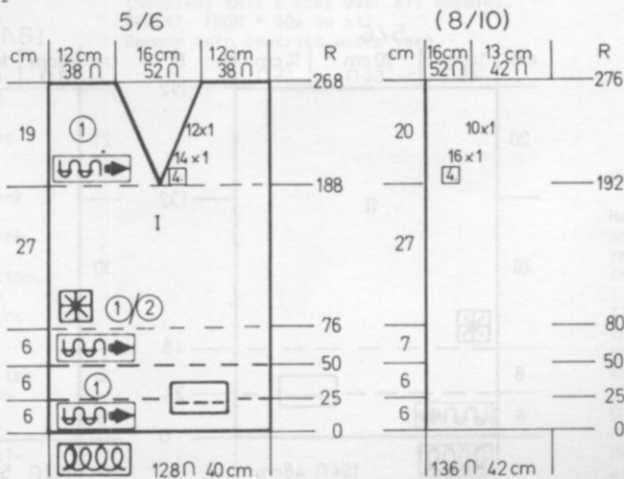
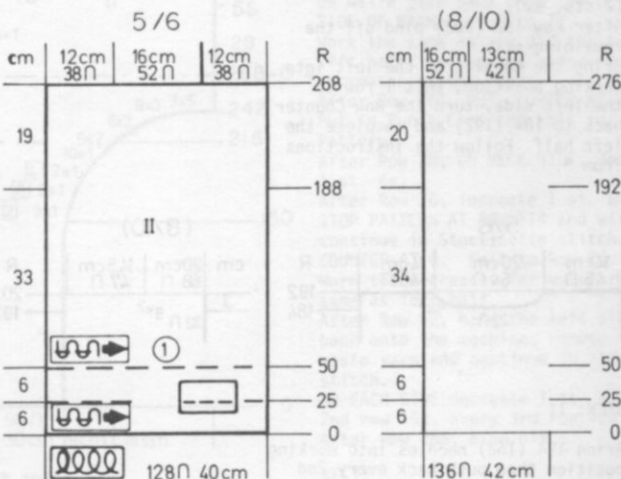
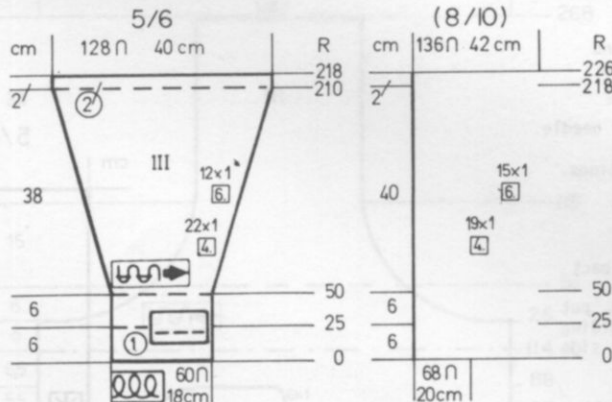

NECKBAND: Make 2.

Cast on 115 (122) sts. with color 2 and work Stockinette stitch. Knit to Row 13. Work 1 row with a loose tension then knit to Row 26. Bind off or remove onto waste yarn. Sew 1 edge to inside and 1 to outside of neckline.

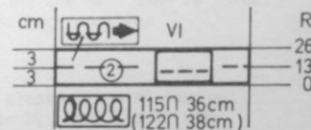

DK 997

WOMAN'S PULLOVER

SIZES: 5/6 (8/10)
YARN: Choose any 5 colors of Mohair or any yarn to give stitch and Row Gauge.

NO KIT AVAILABLE

GRAMS:
 color 1 150 200 = Dark Blue
 color 2 100 150 = Violet
 color 3 50 100 = Pink
 color 4 = Lurex
 color 5 50 50 = Mustard
TENSION: 5 to 7
GAUGE: 16 sts. 15 rows = 5 cm (2")

The trend today is toward using multiple cards, color designs and multiple color and textures - so use the Chart as a basis and mix and match your own Pattern Designs. Bands over every other needle.

FINISHING: See General Instructions.

FRONT: I

Work the front the same as the back to Row 184 (192). Bind off the center 22 (32) sts. put the needles on the left into holding position and complete the right side first.

*ON NECK SIDE, bind off

3 sts. 7x.

(2 sts. 9x).

After Row 192 (202) bind off the remaining sts.

Bring the needles on the left into working position, knit 1 row to the left side, turn the Row Counter back to 184 (192) and complete the left half. Follow the instructions from *.

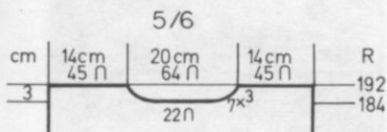

BACK: II

Bring 154 (162) needles into working position then push back every 2nd needle to the out of work position. Cast on With color 1, work Stockinette stitch and knit to Row 24. Knit 1 row with a loose tension, then knit to row 48 and hang the hem. Continue over all needles and work in Pattern Designs of your Choice. After Row 132 (138), mark each side for setting in sleeves then knit to Row 192 (202). Bind off.



SLEEVES: III

Cast on 136 (140) sts. with color 1 and work in Patterns of your choice. After Row 132 (136) bind off.

CUFFS: X Make 2.

Bring 68 needles into working position then push back every 2nd needle to the out of work position. With color 1, cast on over the remaining needles with color 1 and work Stockinette stitch to row 18 then work 1 row loose tension and knit to Row 36. Hang the hem then hang the sleeve edge onto the same needles and bind off.

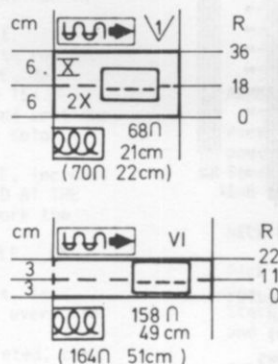
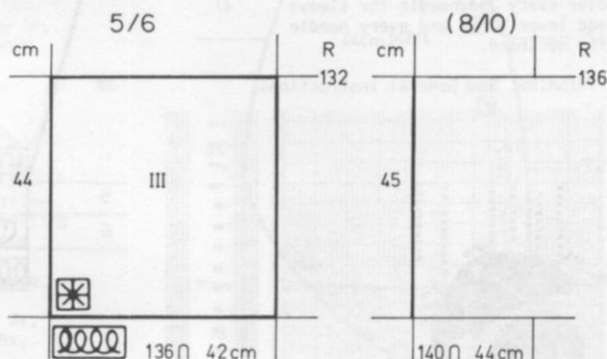

NECKBAND: VI

Close 1 shoulder first.

Cast on 156 (164) sts. with color 1 and work Stockinette stitch. Knit 11 rows then 1 row with loose tension. Knit to Row 22 and hang the hem. Pick up the sts. around neckline and hang onto the band then bind off.

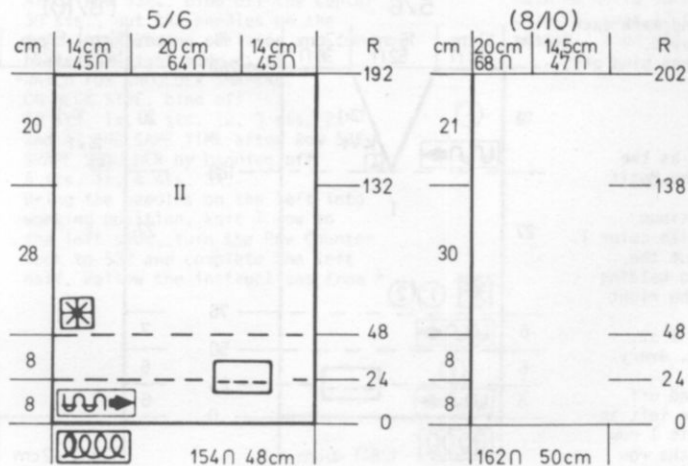

DK 998



WOMAN'S DRESS

SIZE: 8/10
 YARN: 2/20 or any yarn to give
 Stitch & Row Gauge.
 AMOUNT: 1 Cone Color 1
 1 Cone Color 2 (used double)
 TENSION: 4 for Stockinette Stitch
 (Sleeves).
 5 for Pattern.
 GAUGE: 15 sts. 22 rows = 5 cm (2" in
 Pattern.

A Punch Card is used for the Tuck
 Pattern in the TOP SECTION ONLY.
 The needles used for Pattern in the
 Skirt are selected BY HAND and put
 into HOLDING position - DO NOT USE
 THE CARD FOR THE SKIRT.
 USE THE KHC 820 Color Changer for
 knitting this dress.
 Bands and Belt are Stockinette stitch.

FINISHING: Hang the stitches of the
 Skirt sections held on waste yarn
 together on the machine and bind them
 off. Sew sides and sleeves of Top.
 Sew Skirt to waist of Top. Fold
 Belt in half and sew seam.

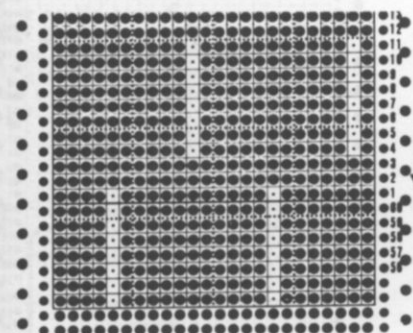

REPEAT THE PUNCH CARD THROUGH
 ROW 53 then punch 2 rows of holes
 for connecting Card.

SKIRT: Make with SHORT ROWS and
 Pattern selected by hand.
 Mark the needle bed of machine with
 a marking pen for the short rows and
 holding position of 4 needles - al-
 ternating needles 12, 24, 36, 49 then
 begin with 6, 18, 30, 42 counting
 from the right edge. BE SURE TO USE
 COLOR CHANGER FOR THE WHOLE GARMENT.
 Cast on 180 sts. with waste yarn.
 Knit at least 3 inches of waste yarn
 and hang weight across. Work 1 row
 of Ravel Cord.
 Carriage on the LEFT at Row 0.
 *Set machine for holding needles and
 work Short Rows with Color 1.
 Bring all except the first 32 needles
 on the left into holding position.
 Knit 2 rows.
 Bring back the next 50 needles to work
 and knit 2 rows.
 Bring back the next 50 needles to work
 and knit 2 rows. (Row 6).
 Of the 48 sts. left in holding position,
 begin on the extreme right and leave
 every 12th st. in holding - all others
 bring back into working position.
 Knit 8 rows (Row 14).
 Carefully bring the needles between the
 holding needles into holding position
 (ALL Pattern needles in HOLDING).
 Knit 2 rows (Row 16).
 Bring next 50 needles to holding posi-
 tion, knit 2 rows (Row 18).
 Bring next 50 needles to holding posi-
 tion, knit 2 rows (Row 20).

BODICE TOP

Cast on 90 sts. with color 2 and
 work Stockinette stitch.
 After Row 150, ON EACH SIDE,
 increase 1 st
 every 3rd row 12x, every 2nd row
 15x.

After Row 216, mark the center of
 the garment then remove the sts.
 onto contrast waste yarn.
 Take the left half of garment and
 place the sts. back onto the machine
 from 0 to 72 ON THE RIGHT SIDE OF MACHINE
 ON THE LEFT SIDE, on every 2nd row
 cast on 4 sts. 11x, then 5 sts. 2x.
 Knit even to Row 242.

Put in the Punch Card. Row Counter
 at 0. Work in Tuck Pattern of
 *8 rows color 1, then 2 rows color
 2 (doubled yarn). REPEAT from *.
 After Row 28, SHAPE NECK.

Bind off 20 sts. 2x, 14 sts. 1x,
 3 sts. 2x, 2 sts. 2x, 1 st. 6x.
 After Row 60, ON NECK SIDE,
 cast on 1 st. 6x, 2 sts. 2x,
 3 sts. 3x, 14 sts. 1x, 20 sts. 2x.

Continue in Pattern to Row 114.
 Continue in Stockinette stitch
 with color 1. COUNTER AT 0.
 After Row 25, SHAPE UNDERARM -
 Bind off 5 sts. 2x, 4 sts. 11x.

After Row 52, remove the sts. onto
 contrast waste yarn.
 Hang the right half of garment held
 on waste yarn back onto the LEFT
 SIDE OF MACHINE - 0 to 72.

Work the same as you did for the
 left half, making the underarm
 increases on the right.

After Row 268, PUT COUNTER AT 0.
 Put in Punch Card and knit in
 Pattern.

After Row 28, ON NECK SIDE, decrease
 1 st. 6x.

After Row 76, increase 1 st. 6x.
 STOP PATTERN AT ROW 114 and with color 1
 continue in Stockinette stitch.
 COUNTER AT 0. Knit to Row 26.
 Work the decreases for underarm
 same as left half.

After Row 52, hang the left side
 back onto the machine, remove the
 waste yarn and continue in Stockinette
 stitch.

ON EACH SIDE decrease 1 st. every
 2nd row 15x, every 3rd row 12x.
 After Row 268, bind off.

BELT:

Cast on 50 sts. with color 1 and
 work Stockinette stitch for as long
 as you need to tie around waist (See
 Picture).

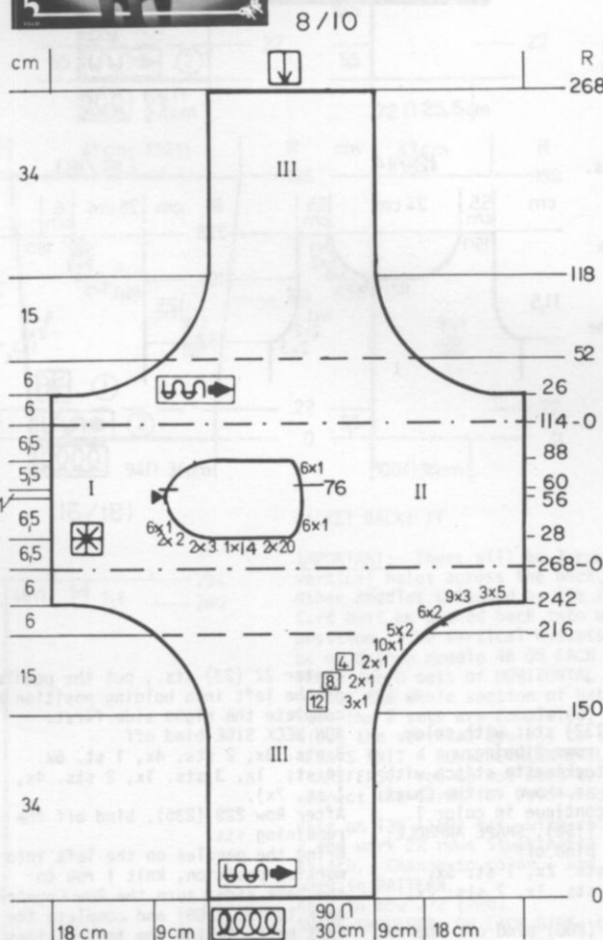

RELEASE HOLDING CAM and with color 2
 (doubled) knit 2 rows over all needles.
 REPEAT FROM * 40x in all.
 Remove onto contrast waste yarn.

FRONT & BACK NECKBANDS:

Hang the front neck onto machine
 and work Stockinette stitch with
 color 1.
 Knit 12 rows with a lower tension,
 1 row with a loose tension, then
 12 rows lower tension. Hang hem
 and bind off or you can bind off
 the sts. and sew band down in place.
 REPEAT for back neckband.

CUFFS:

Hang the sleeves onto 46 needles.
 With color 1, work Stockinette
 stitch to Row 80. Hang the hem
 and bind off.

DK 999



WOMAN'S SLEEVELESS PULLOVER & JACKET

SIZES: 12/14 (16/18)
YARN: Amore
GRAMS: (for both)
 color 1 600 700
 color 2 100 100
 color 3 100 100
TENSION: 6 to 8
GAUGE: 14 sts. 19 rows = 5 cm (2")

The Pullover is Stockinette stitch with color changes as shown on the Chart. The Jacket has an eyelet design. Punch your own Card. Pullover bands are K1, P1 Ribbing.

FINISHING: See General Instructions.

PULLOVER FRONT: I

Work the front the same as the back to Row 152 (156). SHAPE ARMHOLE same as the back then knit to Row 198 (206). Bind off the center 14 sts., put the needles on the left into holding position and complete the right side first.
 *ON NECK SIDE, bind off 5 sts. 1x, 3 sts. 3x, 2 sts. 5x, 1 st. 3x.
 (5 sts. 1x, 4 sts. 1x, 3 sts. 2x, 2 sts. 5x, 1 st. 4x).
 After Row 228 (236) bind off the remaining sts.
 Bring the needles on the left into working position, knit 1 row to the left side, turn the Row Counter back to 198 (206) and complete the left half. Follow the instructions from *.

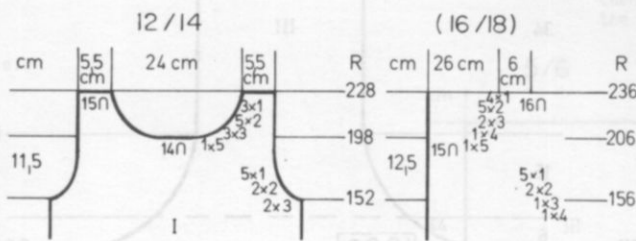

PULLOVER BACK:

Cast on 128 (137) sts. with color 1 and work 12 rows Ribbing. Continue in Stockinette stitch with color changes as shown on the Chart. After Row 80 continue in color 1. After Row 152 (156), SHAPE ARMHOLE: ON EACH SIDE, bind off 3 sts. 2x, 2 sts. 2x, 1 st. 5x. (4 sts. 1x, 3 sts. 1x, 2 sts. 2x, 1 st. 5x). After Row 192 (200) bind off the

center 22 (23) sts., put the needles on the left into holding position and complete the right side first.
 *ON NECK SIDE bind off 3 sts. 3x, 2 sts. 4x, 1 st. 6x. (4 sts. 1x, 3 sts. 1x, 2 sts. 4x, 1 st. 7x).
 After Row 228 (236), bind off the remaining sts.
 Bring the needles on the left into working position, knit 1 row to the left side, turn the Row Counter back to 192 (200) and complete the left half. Follow the instructions from *.

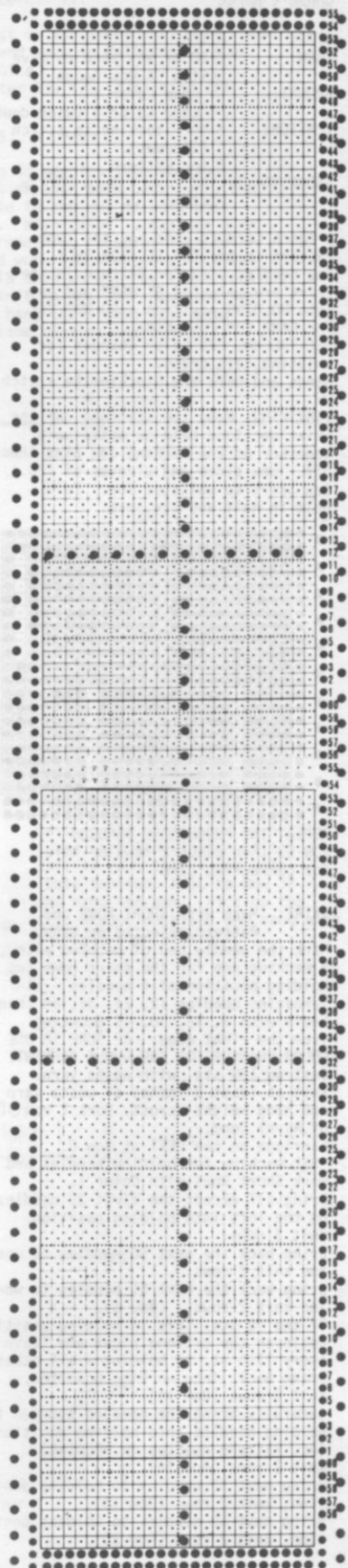
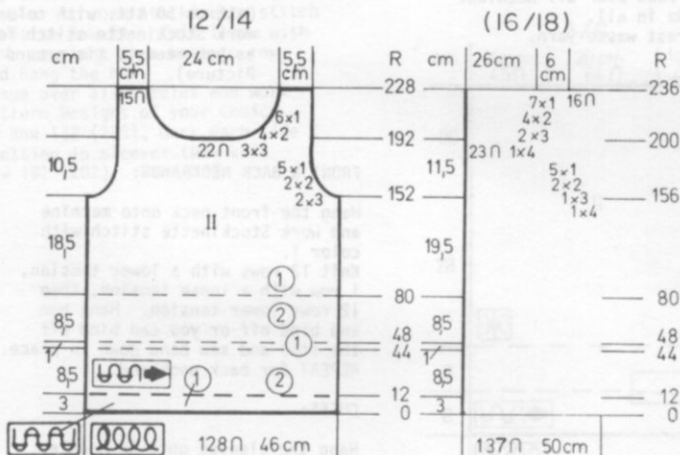

DK 999

PULLOVER NECKBAND

Cast on 182 sts. with color 1 and work 10 rows K1, P1 Ribbing. Bind off or remove onto waste yarn.

JACKET FRONT: Make 1, reverse 1.

Make Pocket Lining first. Cast on 32 sts. with color 1 and work 38 rows Stockinette stitch. Remove onto a stitch holder. Make 2nd pocket lining the same.

FRONT: - Bring 66 (72) needles into working position, beginning with needle 24 (27) on the LEFT side of 0 and ending with needle 42 (45) on the right side of 0.

Cast on with color 2 and work 22 rows Stockinette stitch. Continue in Pattern with ONLY THE 0 NEEDLE for the vertical eyelet. (BE SURE TO READ IMPORTANT NOTE with Jacket Back). Color 1.

After Row 60, leave 8 sts. on the right (left for 2nd section) then remove the next 32 sts. onto a stitch holder and hang the pocket lining sts. onto the empty needles. Continue in Pattern over all needles. After Row 144 (152), ON FRONT EDGE, decrease 1 st. every 8th row 18x (21x). After Row 272 (280) SHAPE SHOULDER same as the back.

Work the left front the same as the right, but cast on beginning with needle 24 (27) on the RIGHT SIDE OF 0 and ending with needle 42 (45) on the LEFT SIDE OF 0.

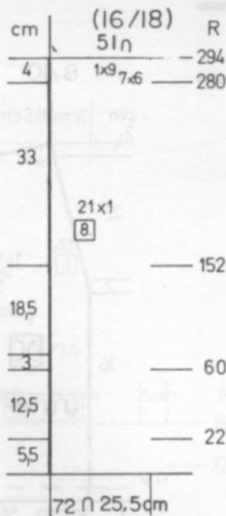
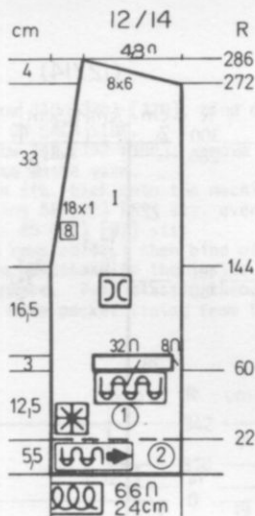

PULLOVER ARM BANDS:

Cast on 115 sts. with color 1 and work 10 rows K1, P1 Ribbing. Bind off or remove onto waste yarn.

POCKET BAND:

Pick up the sts. of pocket held on stitch holder and work 6 or 8 rows of Ribbing. Bind off.

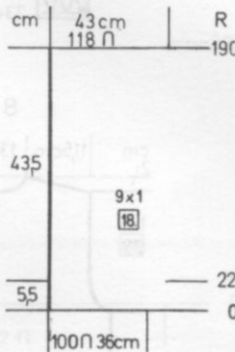
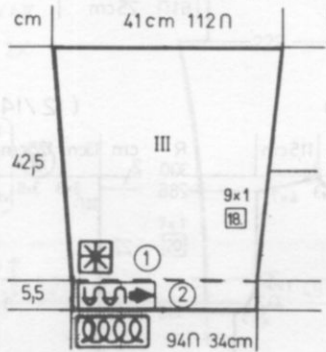

JACKET SLEEVES III

Cast on 94 (100) sts. with color 2 and work 22 rows Stockinette stitch. Continue in Pattern with color 1. ON EACH SIDE, increase 1 st. every 18th row 9x. After Row 186 (190), bind off.

JACKET FRONT BANDS: Make 2.

Cast on 198 sts. with color 2 and work 22 rows Stockinette stitch. Bind off or remove onto waste yarn. Sew 1 edge to inside and 1 to outside of Jacket.

12/14

(16/18)

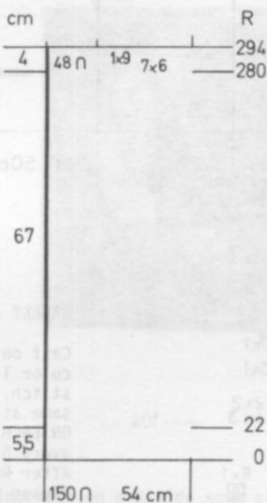
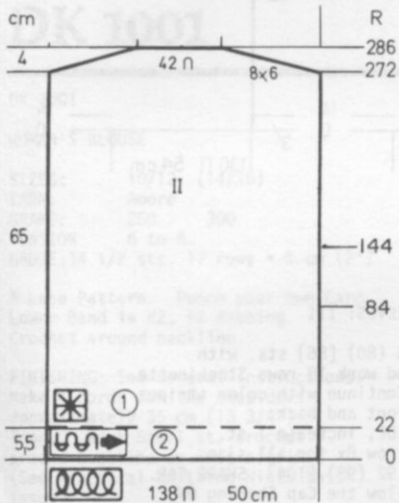

JACKET BACK: II

IMPORTANT: There will be 3 rows of vertical holes across the back - all other needles selected by the Punch Card must be pushed back into working position. The vertical eyelets must be on 0 then needle 48 ON EACH SIDE. There are 2 sets of HORIZONTAL eyelets across the whole section of back. When the 2 sets are completed, continue the vertical eyelets to the end. ALWAYS KNIT 4 ROWS BETWEEN EYELET TRANSFERS. You do not need to connect the Cards for revolving.

Cast on 138 (150) sts. with color 2 and work 22 rows Stockinette stitch. Change to color 1 and work in PATTERN. Knit to Row 272 (280). SHAPE SHOULDER: ON EACH SIDE, bind off 6 sts. 8x. (6 sts. 7x, 9 sts. 1x). After Row 286 (294) bind off the remaining sts.

DK 1000

DK 1000

WOMAN'S SKIRT, JACKET & CAMISOLE TOP

SIZES: 8/10 (12/14) (16)
YARN: Pingouin Pescadou
GRAMS:
color 1 700 750 800
color 2 250 250 250
color 3 250 250 250
TENSION: 8
GAUGE: 12 sts. 13 rows = 5 cm (2")



Stockinette stitch with color stripes as shown on the Chart. Camisole waistband K1, P1 Ribbing.

FINISHING: See General Instructions. SKIRT: Leave side seam open for pockets and sew pockets in place. JACKET: Ease in the sleeve cap (see picture). Make 4 straps for Top - approximately 40 cm (15 3/4") long or make cords for straps. Insert Elastic through hem at top.

FRONT BANDS: Make 2.

Cast on 180 (185) [190] sts. with color 1 and work 14 rows Stockinette stitch. Bind off. Fold in half and sew in place.

DK 1000

JACKET FRONT: I Make 1, reverse 1.

Cast on 56 (61) [66] sts. with color 1 and work 14 rows Stockinette stitch.

Continue in color stripes same as the back.

After Row 180 (190) [200]

SHAPE NECK: Decrease 1 st. every 6th row 17x (17x) [18x] and AT THE SAME TIME, SHAPE ARMHOLE after Row 190 (200) [210] same as the back. After Row 286 (296) [306], SHAPE SHOULDER same as the back.

JACKET BACK: II

Cast on 110 (120) [130] sts. with color 1 and work 14 rows Stockinette stitch. Continue in color stripes as shown on the Chart and repeating from *.

After Row 190 (200) [210], SHAPE ARMHOLE: ON EACH SIDE, bind off 3 sts. 2x, 2 sts. 2x, 1 st. 1x. (3 sts. 2x, 2 sts. 3x, 1 st. 2x) [4 sts. 1x, 3 sts. 1x, 2 sts. 3x, 1 st. 2x].

After Row 286 (296) [306], bind off the center 14 (14) [16] sts., put the needles on the left into holding position and complete the right side first.

*SHAPE SHOULDER AND NECK AT THE SAME TIME.

FOR SHOULDER, bind off 7 sts. 4x.

(6 sts. 1x, 8 sts. 3x).

[9 sts. 1x, 8 sts. 3x].

FOR NECK, bind off 3 sts. 3x for all sizes.

Bring the needles on the left into working position, knit 1 row to the left side, turn the Row Counter back to 286 (296) [306] and complete the left half. Follow the instructions from *.

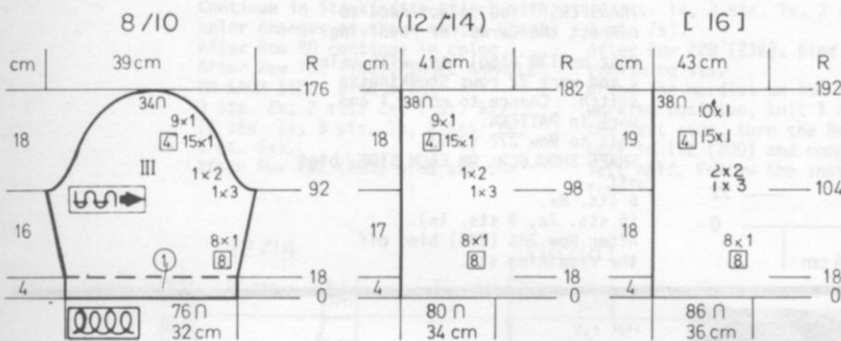
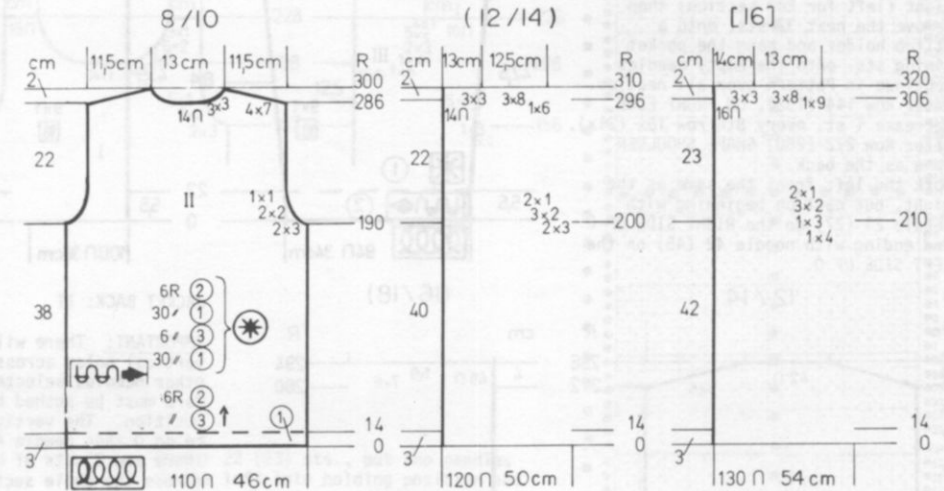
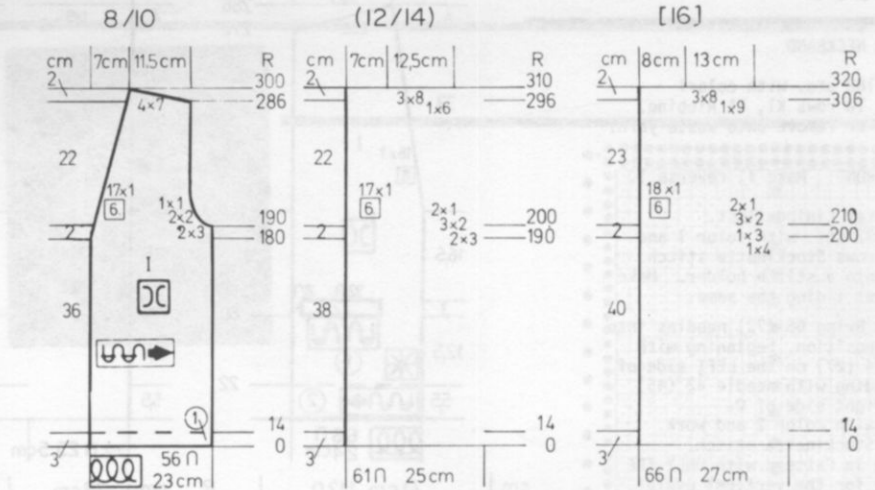

JACKET SLEEVES: III

Cast on 76 (80) [86] sts. with color 1 and work 18 rows Stockinette stitch. Continue with color stripes same as front and back.

ON EACH SIDE, increase 1 st. every 8th row 8x for all sizes.

After Row 92 (98) [104], SHAPE CAP. Please follow the Cap Shaping ON EACH SIDE, as shown on the Chart for your size.

After Row 176 (182) [192], bind off the remaining sts.

CAMISOLE TOP: I/II - 2 sections the same.

Cast on 100 (110) [118] sts. with color 1 and work 30 rows Ribbing. Continue in Stockinette stitch with color stripes as shown on the Chart.

After Row 162 (172) [182], SHAPE ARMHOLE: ON EACH SIDE, bind off 3 sts. 1x, 2 sts. 3x, 1 st. 3x. (Same as first size).

[4 sts. 1x, 3 sts. 1x, 2 sts. 2x, 1 st. 3x].

After Row 182 (192) [202], ON EACH SIDE, cast on 18 (20) [22] sts. Knit 16 rows. Fold in half and sew in place using the extra sts. to go around armhole.

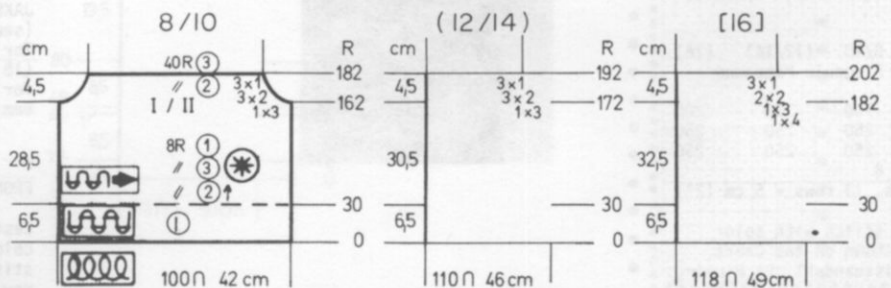

SKIRT: IV/V Make 2 sections the same.

Cast on 154 (162) [170] sts. with color 3 and work Stockinette stitch with color stripes as shown on the Chart.

After Row 20, ON EACH SIDE, decrease 1 st. every 20th row 7x for both sizes.

After Row 222 (232) [232], cast on 12 sts. ON EACH SIDE for pocket.

After Row 310 (320) [320], bind off 12 sts. ON EACH SIDE.

After Row 342 (352) [352], remove the sts. onto waste yarn.

Hang the sts. back onto the machine decreasing 55 (57) [59] sts. evenly across - 85 (91) [97] sts.

Knit 28 rows color 1 then bind off.

Fold the waistband to the inside and sew in place. Pull elastic through casing. Make pocket lining from Taffeta.

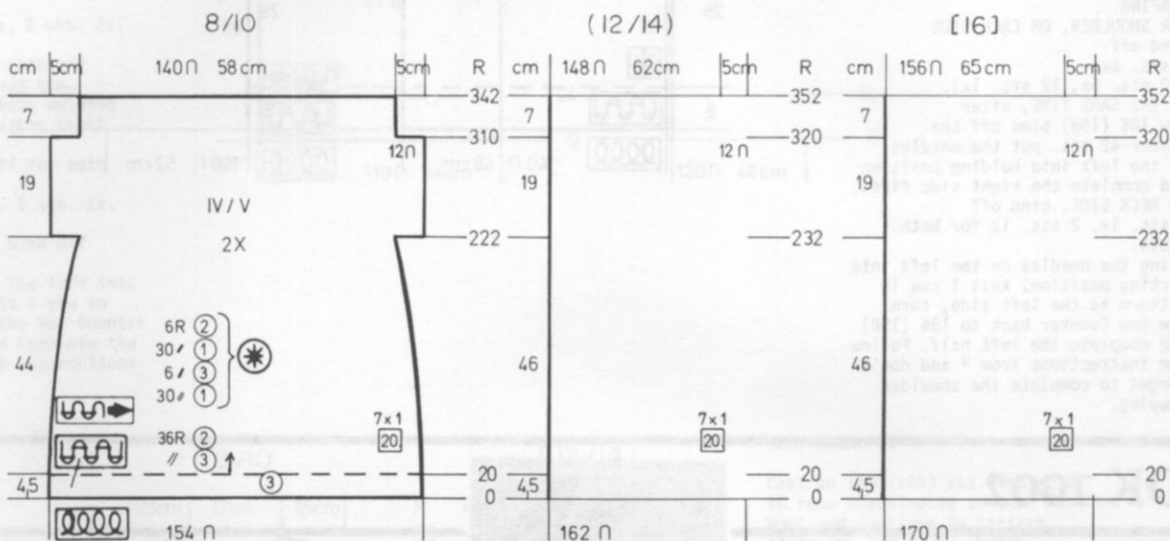

DK 1001

DK 1001

WOMAN'S BLOUSE

SIZES: 10/12 (14/16)
 YARN: Amore
 GRAMS: 250 300
 TENSION: 6 to 8
 GAUGE: 14 1/2 sts. 17 rows = 5 cm (2")

A Lace Pattern. Punch your own Card.
 Lower Band is K2, P2 Ribbing.
 Crochet around neckline.

FINISHING: See General Instructions.
 Make 4 cords for the shoulders approximately 35 cm (13 3/4") long. Work Shell st. crochet around neckline or knit a trim (See Practical Knitting Hints this issue).

FRONT: I

Work the front the same as the back to Row 118 (126).
 Divide in the center, put the needles on the left into holding position and complete the right side first.

* SHAPE ARMHOLE AND NECK AT THE SAME TIME.

Increase on arm side same as you did for the back and ON NECK SIDE, decrease 1 st. every 2nd row 26x for both sizes.

After Row 180 (192) SHAPE SHOULDER same as the back.

Bring the needles on the left into working position, knit 1 row in Pattern to the left side, turn the Row Counter back to 118 (126) and complete the left half. Follow the instructions from *.

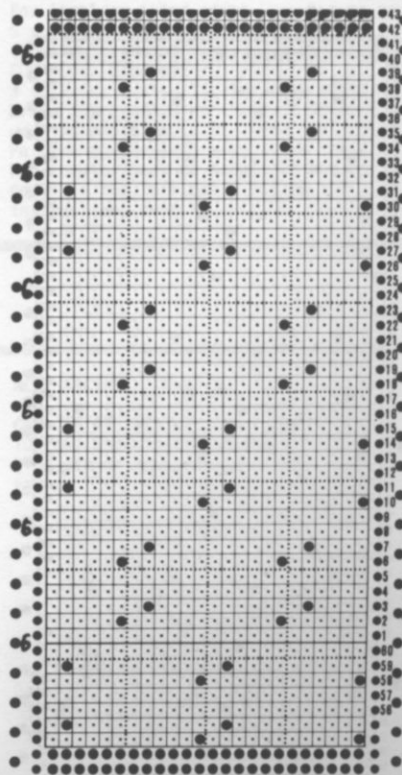
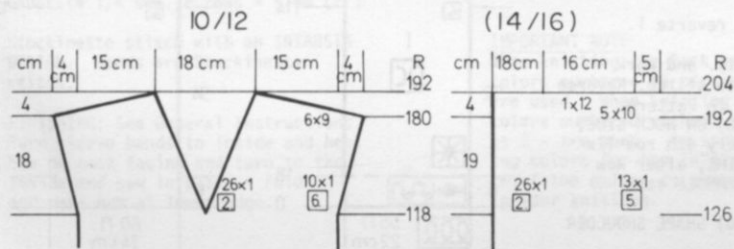

Knit 6 rows between Designs and be sure to mark Punch Card as shown.



DK 1001

BACK: II

Cast on 140 (150) sts. and work 28 Rows K2, P2 Ribbing. Continue in Lace Pattern. After Row 118 (126), ON EACH SIDE increase 1 st. every 6th row 10x (every 5th row 13x). After Row 180 (192) SHAPE SHOULDER and WATCH FOR NECK SHAPING. FOR SHOULDER, ON EACH SIDE bind off 9 sts. 6x (10 sts. 5x, 12 sts. 1x). AT THE SAME TIME, after Row 186 (198) bind off the center 42 sts. put the needles on the left into holding position and complete the right side first. *ON NECK SIDE, bind off 3 sts. 1x, 2 sts. 1x for both sizes. Bring the needles on the left into working position, knit 1 row in Pattern to the left side, turn the Row Counter back to 186 (198) and complete the left half. Follow the instructions from * and don't forget to complete the shoulder shaping.

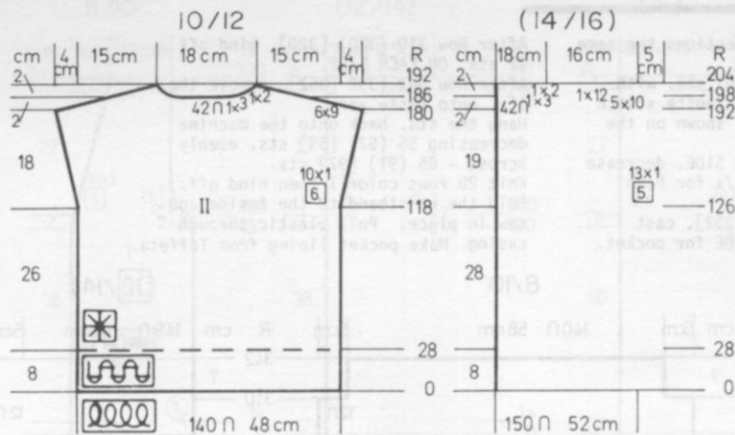

DK 1002

DK 1002

WOMAN'S SLEEVELESS TOP AND VEST

SIZES: 8/10 (12/14)
 YARN: Amore
 GRAMS: 350 400
 TENSION: 10
 GAUGE: 12 1/2 sts. 15 rows = 5 cm (2")

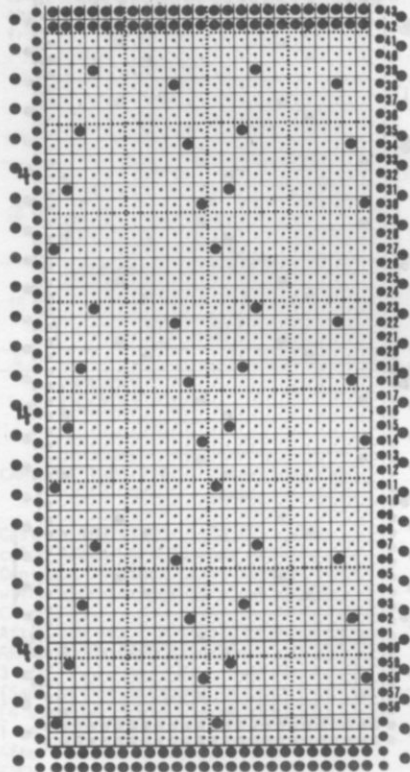

Mark Card as shown and knit 4 rows between each Pattern Set.



The Top is Stockinette stitch worn on the Purl side. The Vest is a Lace Pattern. Punch your own Card and remember to knit 4 rows between each Pattern set as marked on the Card.

FINISHING: See General Instructions. Work 1 row single crochet then 1 row of picots around neck and armholes.

FRONT: I Make 1, reverse 1.

Cast on 55 (60) sts. and work 18 rows Stockinette stitch. Reverse Work and continue in Pattern. After row 114 (120) ON NECK SIDE, decrease 1 st. every 4th row 17x AND AT THE SAME TIME, after Row 130 (136) SHAPE ARMHOLE same as the back. After Row 190 (200) SHAPE SHOULDER SAME AS THE BACK.

ARMBANDS: Make 2.

Cast on 100 sts. and work 18 rows Stockinette stitch. Bind off or remove onto waste yarn. Sew to armhole so that the PURL side is the right side with 1 edge to inside and one to the outside of armhole.

NECK & FRONT BANDS: Make 2.

Cast on 155 sts. and work 18 rows Stockinette stitch. Bind off or remove onto waste yarn. Sew to front and neck edge in the same way as armhole bands.

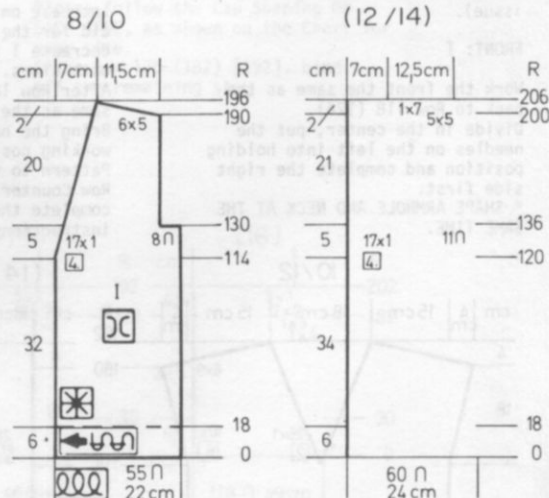

DK 1002

TOP BACK & FRONT I/II Make 2 sections the same.

Cast on 110 (120) sts. and work 24 rows K1, P1 Ribbing. Continue in Stockinette stitch.

Knit to Row 102 (108).
SHAPE ARMHOLE: ON EACH SIDE, bind off

4 sts. 1x, 3 sts. 1x, 2 sts. 2x, 1 st. 3x.
(5 sts. 1x, 3 sts. 1x, 2 sts. 2x, 1 st. 4x).

After Row 120 (126), bind off the center 18 sts., put the needles on the left into holding position and complete the right side first.

ON NECK SIDE, bind off for both sizes

4 sts. 1x, 3 sts. 1x, 2 sts. 2x, 1 st. 4x.

After Row 162 (168), bind off the remaining sts.
Bring the needles on the left into working position, knit 1 row to the left side, turn the Row Counter back to 120 (126) and complete the left half. Follow the instructions from *.

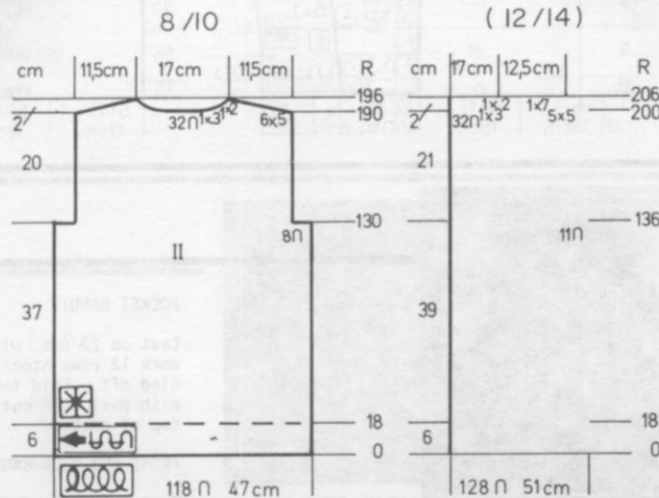
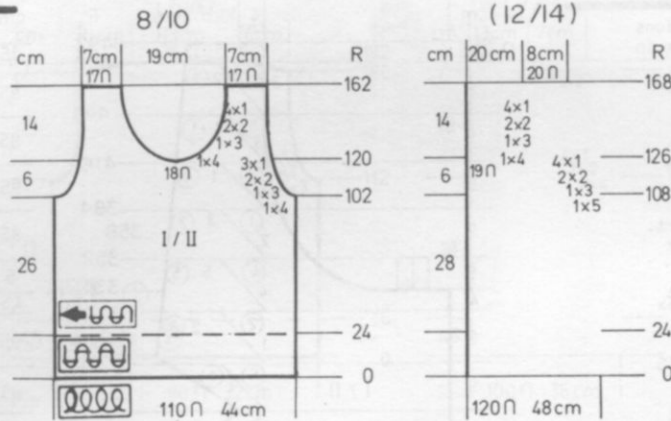

VEST BACK: II

Cast on 118 (128) sts. and work 18 rows Stockinette stitch. Reverse Work and continue in Pattern.

After Row 130 (136), SHAPE ARMHOLE: ON EACH SIDE, bind off

8 (11) sts.
Knit to Row 190 (200).
Bind off the center 32 sts., put the needles on the left into holding position and complete the right side first.

*SHAPE SHOULDER AND NECK AT THE SAME TIME.

For Shoulder, bind off 5 sts. 6x.

(5 sts. 5x, 7 sts. 1x).

FOR NECK: Bind off 3 sts. 1x, 2 sts. 1x, for both sizes.

Bring the needles on the left into working position, knit 1 row in Pattern to the left side, turn the Row Counter back to 130 (136) and complete the left half. Follow the instructions from *.

KK 1003

WOMAN'S PULLOVER

SIZES: 10/12 (14/16)

YARN: Amore

GRAMS:

color 1	100	100
color 2	100	100
color 3	100	100
color 4	100	100
color 5	100	100

TENSION: 7 or 8

GAUGE: 14 1/4 sts. 18 rows = 5 cm (2")

Stockinette stitch with an INTARSIA DESIGN. Bands are Stockinette stitch.

FINISHING: See General Instructions. Turn sleeve bands to inside and hem. Sew on neck facing and turn to the inside and sew in place. Fold and make hem at lower edge.



IMPORTANT NOTE

When knitting the Back section, colors numbered in circles 0 are used. When knitting the front, colors numbered without circles such as 2 - are used. Be sure when changing colors for the INTARSIA that you twist the colors to prevent a hole in your knitting.

NECK FACING: Make 2

Cast on 44 (46) sts. and work 10 rows Stockinette stitch. Bind off or remove onto waste yarn.



KK 1003

BACK & FRONT: 1/II - Both sections are the same except for changes in colors.

Cast on 40 (40) sts. with color 2 and work 12 rows Stockinette stitch.

Continue in the INTARSIA Design beginning with 20 sts. for each color.

ON EVERY ROW, move the colors over 1 st. as shown on the Chart. Follow the Chart throughout for the Design and color changes.

After Row 44, ON SHOULDER SIDE, increase 1 st. every 6th row 15x and AT THE SAME TIME, After Row 76 (80) SHAPE UNDERARM.

PLEASE FOLLOW THE CHART FOR THIS SHAPING IN THE SIZE YOU NEED.

After Row 204 (214) SHAPE NECK.

ON NECK SIDE, decrease (or bind off) 2 sts. 21x (22x).

After Row 246 (260) ON NECK SIDE, increase 2 sts. 21x (22x).

After Row 333 (353) Bind off

45 (51) sts. then continue the UNDERARM SHAPING IN REVERSE.

After Row 358 (386) ON SHOULDER SIDE, decrease 1 st. every 6th row 15x.

After Row 480 (508) work 12 rows Stockinette stitch with color 3.

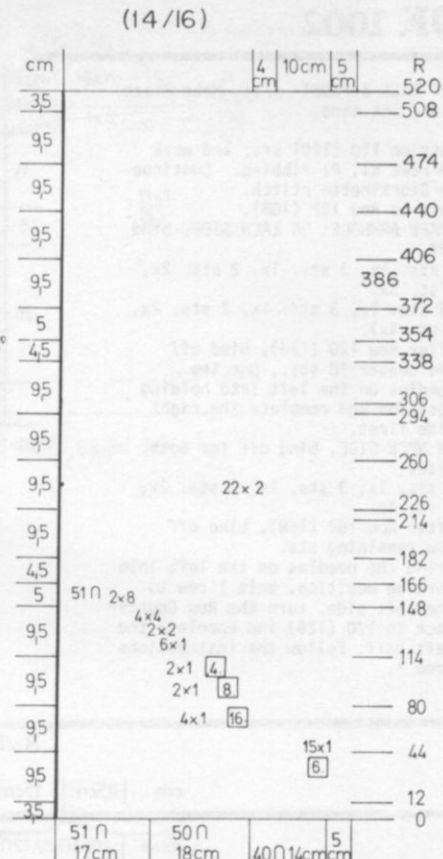
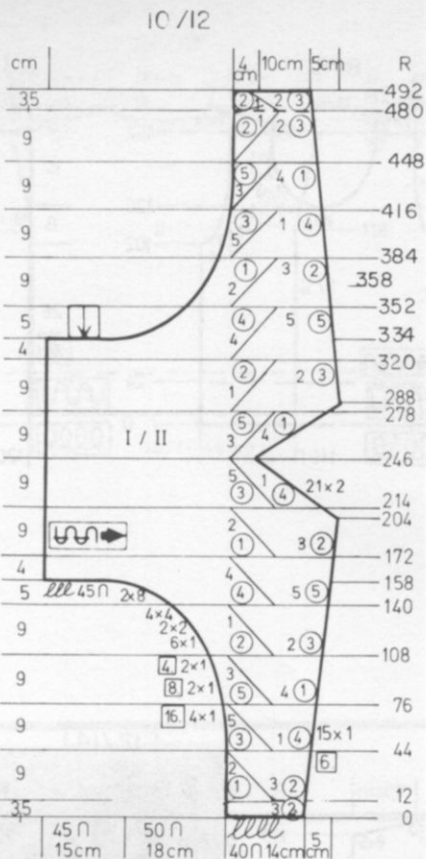

KK 1004

CHILD'S JACKET

SIZES: 5/6 (7/8)

YARN: Amore

GRAMS:

color 1 150 200

color 2 50 50

TENSION: 8

GAUGE: 14 sts. 28 rows = 5 cm in

Pattern.

A Tuck Stitch Pattern. Punch your own Card. The bands are Stockinette stitch with the Purl side as the right side.

FINISHING: See General Instructions. Sew 1 edge of bands to the inside and fold in half and sew other edge to the outside - with the purl side as the right side.

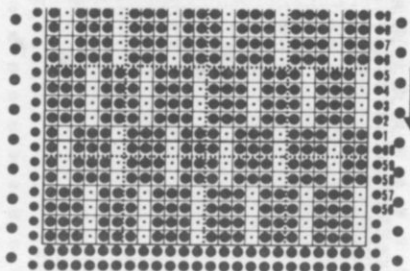

REPEAT the Punch Card through Row 41 then punch 2 rows of holes for connecting Card.



FRONT: I Make 1, Reverse 1. Make Pocket Linings first.

For the Pocket Lining, cast on 22 sts. with color 1 and work 18 rows in Pattern. Remove onto a stitch holder. Make 2.

FOR THE FRONT, cast on 37 (42) sts. with color 2 and work 16 Rows Stockinette stitch.

Continue in Pattern with color 1.

After Row 36. counting from the side edge, skip 3 sts., then remove the next 22 sts. onto a stitch holder. Hang the pocket lining sts. onto the empty needles and continue in pattern. (Check to be sure the pattern matches to the pocket lining and change the placement of pocket lining if necessary).

After Row 112 (124), SHAPE ARMHOLE same as the back then knit to Row 151 (163).

SHAPE NECK: Bind off 3 sts. 1x, 2 sts. 3x, 1 st. 1x for both sizes and after Row 186 (198)

SHAPE SHOULDER same as the back.

POCKET BAND:

Cast on 22 sts. with color 2 and work 12 rows Stockinette stitch. Bind off. Fold the band in half with purl side out and sew to top of pocket.

FRONT AND NECK BAND:

Cast on 12 sts. with color 2 and work Stockinette stitch for approximately 80/90 cm (224/252) Rows.

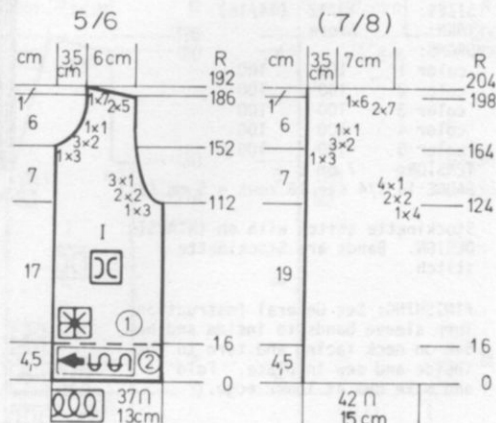

KK 1004

BACK: II

Cast on 90 (100) sts. with color 2 and work 16 rows Stockinette stitch. Continue in Pattern with color 1.
 Knit to Row 112 (124).
 SHAPE ARMHOLE: ON EACH SIDE, bind off
 3 sts. 1x, 2 sts. 2x, 1 st. 3x.
 (4 sts. 1x, 2 sts. 2x, 1 st. 4x).
 After Row 186 (198), SHAPE SHOULDER:
 ON EACH SIDE, bind off
 5 sts. 2x, 7 sts. 1x.
 (7 sts. 2x, 6 sts. 1x).
 After Row 192 (204) bind off the remaining sts.

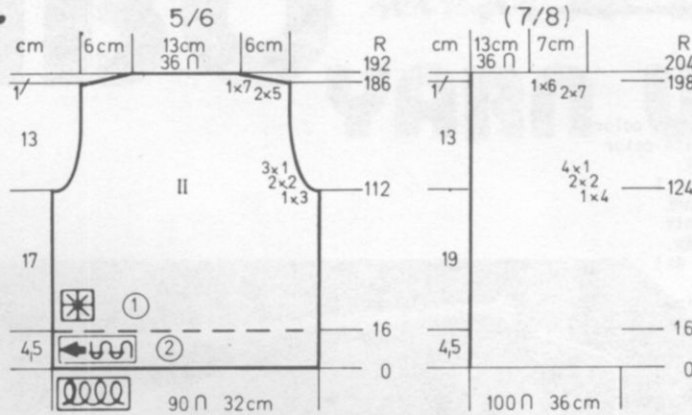

SLEEVES: III

Cast on 45 (50) sts. with color 2 and work 16 rows Stockinette stitch. Continue in Pattern with color 1.
 ON EACH SIDE, increase 1 st. every 18th row 6x for both sizes.
 After Row 134 (140) SHAPE CAP:
 Please follow the bind-offs on each side for the Cap Shaping in your size.
 After Row 174 (186), bind off the remaining sts.

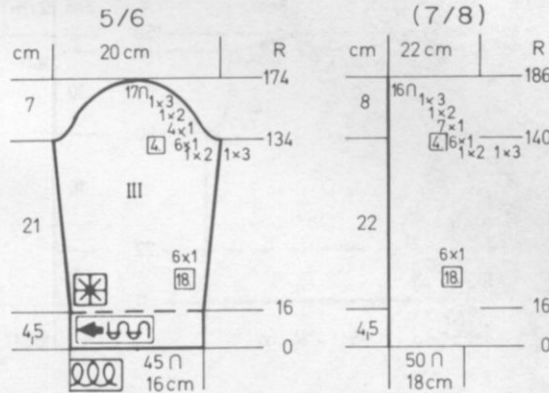

KK 1005

CHILD'S PULLOVER VEST

SIZES: 5/6 (7/8) [10/12]
 YARN: Amore
 GRAMS:
 color 1 100 150 200
 color 2 50 50 50
 TENSION: 8
 GAUGE: 14 sts. 28 rows = 5 cm (2")



REPEAT the Punch Card through Row 41 then punch 2 rows of holes for connecting Card.

FRONT: I Make 1, reverse 1.

Cast on 50 (56) [58] sts. with color 1 and work 22 rows Ribbing with color changes same as the back.
 Continue in Pattern with color 1.
 After Row 82 (90) [94], ON FRONT EDGE, decrease 1 st. every 4th row 19x (20x) [22x] AND AT THE SAME TIME, after Row 90 (102) [108], SHAPE ARMHOLE same as the back.
 After Row 146 (158) [170], SHAPE SHOULDER same as the back.

A Tuck stitch Pattern. Punch your own Card and push in both Tuck Buttons. Waist Band is K1, P1 Ribbing. Crochet around front and sleeve edges.

FINISHING: See General Instructions.
 Work Crochet around edges as follows:
 1) Hook 1 row single crochet down fronts and around neck.
 2) *Make cluster of 4 double crochets (yarn over hook, into next st. and pull up loop and repeat 4 x in all. Yarn over hook and pull through all loops on hook) Ch 2, skip 1 and repeat from *.
 3) 1 Row single crochet around.
 Sew up front approximately 9 or 10 cm.

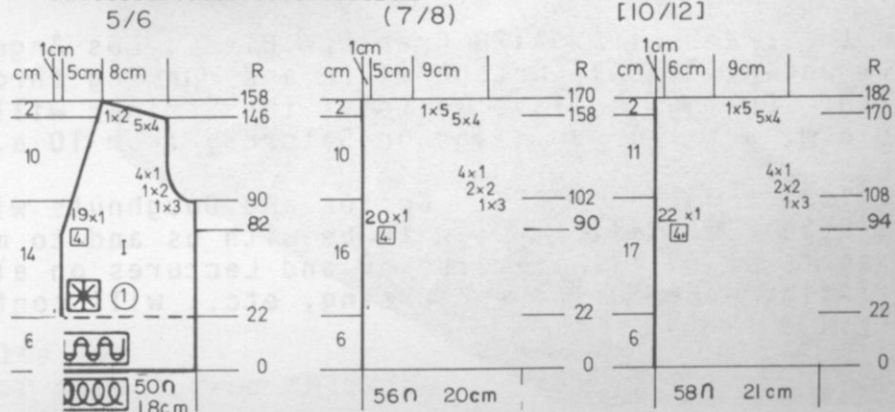
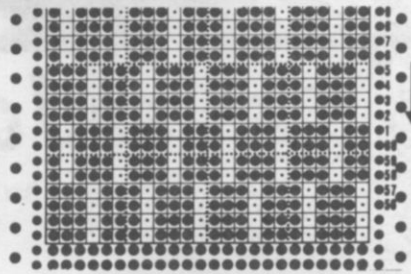

KK 1005

BACK: II

Cast on 96 (106) [111] sts. with color 1 and work 22 rows Ribbing with color changes as shown on the Chart. Continue in Pattern with color 1.

After Row 90 (102) [108], SHAPE ARMHOLE: ON EACH SIDE, bind off 3 sts. 1x, 2 sts. 1x, 1 st. 4x. (3 sts. 1x, 2 sts. 2x, 1 st. 4x) [Same as 2nd size].

After Row 146 (158) [170], bind off the center 26 (26) [31] sts., put the needles on the left into holding position and complete the right side first.

*SHAPE SHOULDER AND NECK AT THE SAME TIME.

FOR SHOULDER, bind off 4 sts. 5x, 2 sts. 1x. (4 sts. 5x, 5 sts. 1x). [4 sts. 5x, 5 sts. 1x].

FOR NECK, bind off 2 sts. 2x for all sizes.

Bring the needles on the left into working position, knit 1 row to the left side in Pattern, turn the Row Counter back to 146 (158) [170] and complete the left half. Follow the instructions from *

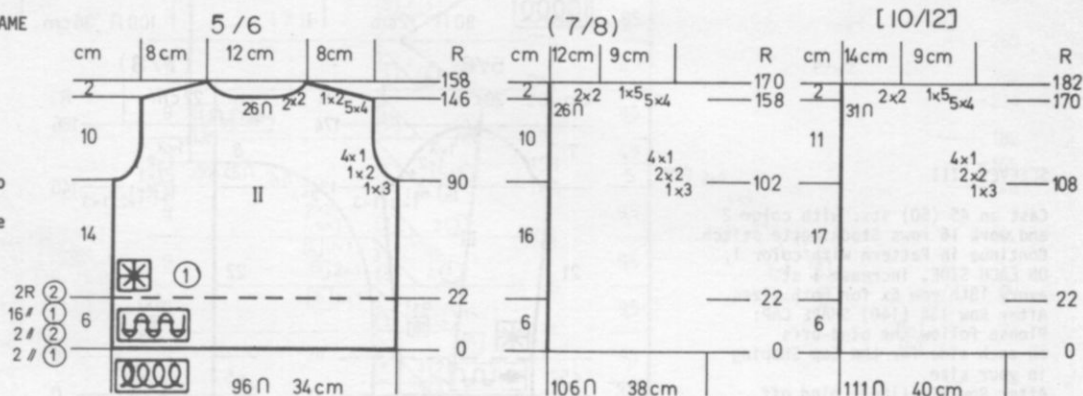

knitking announces their

SEMINAR

and open house

1981



On the premises at 1128 Crenshaw Blvd., Los Angeles, Calif. 90019. Commencing-Monday, October 12th and running through Saturday, the 17th. During the five weekdays the Seminar will operate from 10 a.m. until 4 p.m., and on Saturday from 10 a.m until 1 p.m.

Admission will be FREE - Coffee and Doughnuts will be available at 9:30 a.m. daily. Plan to be with us and to meet the knitting experts at KNITKING. Classes and Lectures on all phases of machine knitting - Measuring - Charting, etc., will continue throughout every day.

JUMBO *winds an eight oz. ball* YARN WINDER



NEW AND
REVOLUTIONARY DESIGN

Winds yarn without
twisting it. The Cone
lifts off and stands
behind your machine... or
you can remove the ball and
pull yarn from its center.

price

\$24.95

Calif. residents add Sales Tax
Order from your dealer or direct from KNITTING

KNITTING fights INFLATION!

SAVE \$134.00

on a babylock EA 605

Volume purchasing combined with the strengthening of the U.S. dollar, allows us to reduce the price of the fabulous Cut-Sew Overlock - Model EA 605 to below \$300.00 for the first time in several years. The regular price of this handsome 'BABY' is \$429.00... Use it for that professional finish on all your sewing... and to assemble your knits... Take advantage of our inflation fighting price now... We cannot guarantee to repeat this LOW, LOW PRICE.

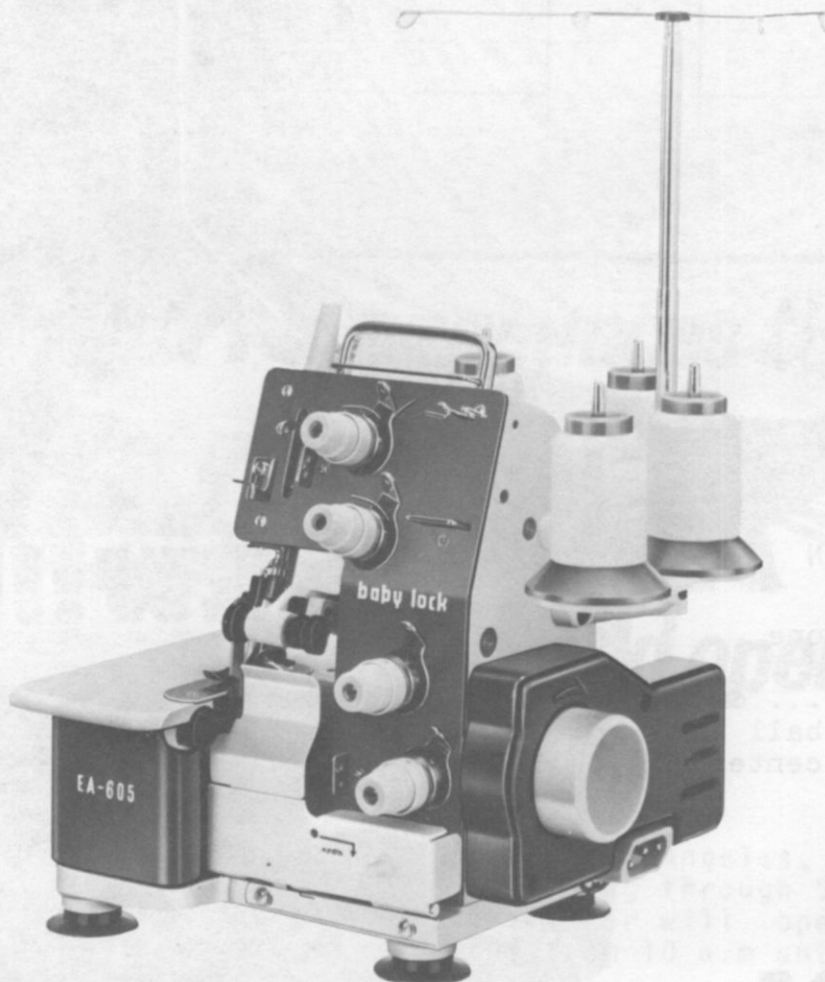

\$295

Order direct from

knitking

1128 Crenshaw Boulevard, Los Angeles, California 90019



KNITKING NEWS

PRACTICAL KNITTING HINTS

TRIM FOR DK 1001

If you want to make a knitted trim on the machine in place of a crochet edging - try this...

TENSION: 5

Cast on over 5 needles.

Knit 2 rows.

Set machine for holding needles.

*Put the 2 end needles on the LEFT into holding position and knit 10 rows over 3 needles.

Push the 4th needle into working position

Knit 2 rows.

Push the end needle into working position

Knit 2 rows.

REPEAT FROM * for as long as you need.

Here is a new card for you to punch for use with your COLOR CHANGER. Use Fair Isle (Norwegian) technique and begin with *8 rows using 2 colors then 2 rows using 1 color then REPEAT from *. After you have made a sample, be creative and change the colors to make up your own design. The design can be used for Chair Covers, Place Mats, Cushions and other household items as well as for garments.

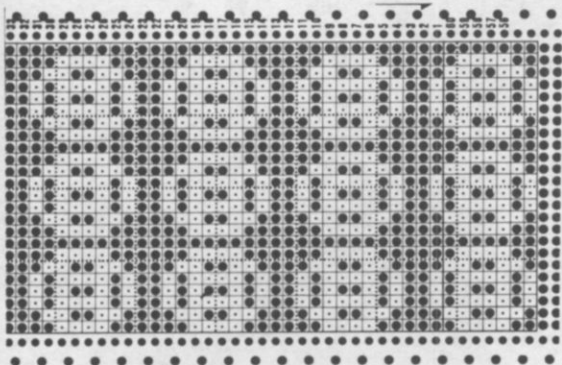

NEW MAXI LACE BOOK

The following was omitted from our Summer Sale Literature... Another book that sold out rapidly was the LACY PLEAT book... Unfortunately it went out of print and we were unable to restock... If you have one on back order, it will be replaced with the new MAXI LACE book offered in this Sale. We like the up-dated book even better, it has a total of 13 outstanding lace patterns, all illustrated in color. There are Skirts, Tops, Dresses and two garments made on the JUMBO. All Punch Cards are illustrated so that you can punch your own cards and all Charts and Line Drawings have English numerals... The book is printed in Japanese... This is a good buy at our Special price of \$3.95.

KNITKING OPEN HOUSE AND SEMINAR

Don't forget the dates for our Annual Seminar and Open House... October 12th through October 17th. If you are coming from out of town and need a place to stay, here is a list of Hotels and Motels available.

- Wilshire Dunes Motor Hotel - 4300 Wilshire Blvd. (nearest to our premises) Los Angeles CA 90010 Tel: 213-938-3616
- Ambassador Hotel - 3400 Wilshire Blvd. Los Angeles, CA 90010 Tel: 213-387-7011
- Hilton - Downtown Los Angeles - 9876 Wilshire Blvd. 90017 -Tel:213-629-4321
- Hilton - Beverly Hills - 9876 Wilshire Blvd. 90210 - Tel:213-274-7777
- Hilton Hotels - 3540 So. Figueroa, Los Angeles 90007 Tel:213-748-4141
- Wilshire Hyatt House - 3515 Wilshire Blvd. Los Angeles, CA 90010 Tel:Toll Free - 800-228-9000
- Century Plaza Hotel - Beverly Hills -Century City area- Avenue of the Stars 90067 Tel:213-277-2000
- Olympian Motor Hotel - 1903 W. Olympic Blvd., L.A. 90006 - Tel: 213-385-7141



KNITKING BINDERS — Holds One Complete Year's Copies

Keep all your KnitKing Magazines together and build a beautiful library of patterns

\$5.95 ea. Available from KNITKING: 1128 Crenshaw Blvd. Los Angeles, Calif. 90019

I enclose \$__ for __ Binders (Calif. residents add Sales Tax) plus \$1.25 Shipping costs.(Canada \$2.75)

Name

Address

ZIP

DISCOUNTED YARN KITS FOR THIS ISSUE

The Yarn Kits for this issue of KNITTING MAGAZINE are available at special discounts to our subscribers and the prices are only good until the next issue of the magazine. Be sure to check the colors available listed at the end of this NEWS-LETTER and make certain to give alternate colors.

DK 983 - Yarn: Vienna
 SIZES: 8/10 (12/14) [16/18]
 Regular Price \$10.80 \$13.50 \$16.20
 Sale Price 8.64 10.80 12.96
 Shipping costs 1.85 1.85 1.85

DK 984 - Yarn: Schachenmayr Viola - or any yarn to give stitch and row gauge.
 NO KIT AVAILABLE

DK 985 - Yarn: Schachenmayr Viola - or any yarn to give stitch and row gauge.
 NO KIT AVAILABLE

DK 986 - Yarn: Viena
 SIZES: 8/10 (12)
 Regular Price \$16.20 \$18.90
 Sale Price 12.96 15.12
 Shipping costs 1.85 1.85

HP 987 - Yarn: Vienna
 SIZES: 40 (42)
 Regular Price \$18.90 \$21.60
 Sale Price 15.12 17.28
 Shipping costs 1.85 1.85

DK 988 - Yarn: Vienna
 SIZES: 7/8 (10/12) [14]
 Regular Price \$21.60 \$24.30 \$24.30
 Sale Price 17.28 19.44 19.44
 Shipping costs 1.85 1.85 1.85

KK 989 - Yarn: Amore
 SIZES: 6/7 (8)
 Regular Price \$23.90 \$26.29
 Sale Price 19.12 21.03
 Shipping costs 1.85 1.85

DK 990 - Yarn: Pingouin Pescadou
 SIZES: 8/10 (12/14)
 Regular Price \$47.40 \$51.35
 Sale Price 37.92 41.08
 Shipping costs 2.25 2.25

DK 991 - Yarn: Pingouin Pescadou
 SIZES: 8/10 (12/14)
 Regular Price \$31.60 \$39.50
 Sale Price 25.28 31.60
 Shipping costs 2.25 2.25

DK 992 - Yarn: 2/20 or any yarn to give stitch and row gauge.
 NO KIT AVAILABLE

DK 993 - Yarn: Amore
 SIZES: Small (Medium) [Large]
 Regular Price \$14.34 \$14.34 \$16.73
 Sale Price 11.47 11.47 13.38
 Shipping Costs 1.85 1.85 1.85

DK 994 - Yarn: Amore
 SIZES: 8/10 (12/14)
 Regular Price \$21.51 \$28.68
 Sale Price 17.21 22.94
 Shipping costs 1.85 1.85

DK 995 - Yarn: Vienna & Metallic Mami Rex
 SIZES: 7/8
 Regular Price \$39.90
 Sale Price 31.92
 Shipping costs 1.85

DK 996 - Yarn: Amore
 SIZES: 5/6 (8/10)
 Regular Price \$23.90 \$26.29
 Sale Price 19.12 21.03
 Shipping costs 1.85 1.85

DK 997 - Yarn: Choose any 5 colors of Mohair or any yarn to give stitch & row gauge. NO KIT AVAILABLE.

DK 998 - Yarn: 2/20 or any yarn to give stitch and row gauge. NO KIT AVAILABLE.

DK 999 - Yarn: Amore
 SIZES: 12/14 (16/18)
 Regular Price \$38.24 \$43.02
 Sale Price 30.59 34.42
 Shipping costs 1.85 1.85

DK 1000 - Yarn: Pingouin Pescadou
 SIZES: 8/10 (12/14) [16]
 Regular Price \$94.80 \$98.75 \$102.70
 Sale Price 75.84 79.00 82.16
 Shipping costs 2.25 2.25 2.25

DK 1001 - Yarn: Amore
 SIZES: 10/12 (14/16)
 Regular Price \$11.95 \$14.34
 Sale Price 9.56 11.47
 Shipping costs 1.85 1.85

DK 1002 - Yarn: Amore
 SIZES: 8/10 (12/14)
 Regular Price \$16.73 \$19.12
 Sale Price 13.38 15.30
 Shipping costs 1.85 1.85

DK 1003 - Yarn: Amore
 SIZES: 10/12 (14/16)
 Regular Price \$23.90 \$23.90
 Sale Price 19.12 19.12
 Shipping costs 1.85 1.85

KK 1004 - Yarn: Amore
 SIZES: 5/6 (7/8)
 Regular Price \$9.56 \$11.75
 Sale Price 7.65 9.56
 Shipping costs 1.85 1.85

KK 1005 - Yarn: Amore
 SIZES: 5/6 (7/8) [10/12]
 Regular Price \$7.17 \$9.56 \$11.95
 Sale Price 5.74 7.65 9.56
 Shipping costs 1.85 1.85 1.85

CHOOSE YOUR YARN KITS FROM THE FOLLOWING COLORS

VIENNA . . White, Yellow, Red, Gold, Navy, Lt. Green, Peach, Lilac, Beige, Med. Blue, Dk. Green, Plum, Brown, Bottle Green, Sea Foam, Aqua.

AMORE . . . Med. Blue, Lt. Grey, Dk. Grey, Red, Beige, Navy, Pink, Black, White, Turq. Yellow, Dk. Green, Hot Pink, Lilac, Rose Tweed, Plum, Jade, Brown, Rust, Strawberry, Orange Tweed, Burgundy, Sky Blue, Coral.

PINGOUIN PESCADOU. . Colors as shown in Magazine.





DK1002



DK991



DK990



DK992



DK993



DK995





DK995



DK983



DK1001





KK1005

KK1004



KK989





DK1003

