

knitking

magazine





dk 651



X 5/6-78





OK 645





MD 636

dk 637





hp 650





KK 659

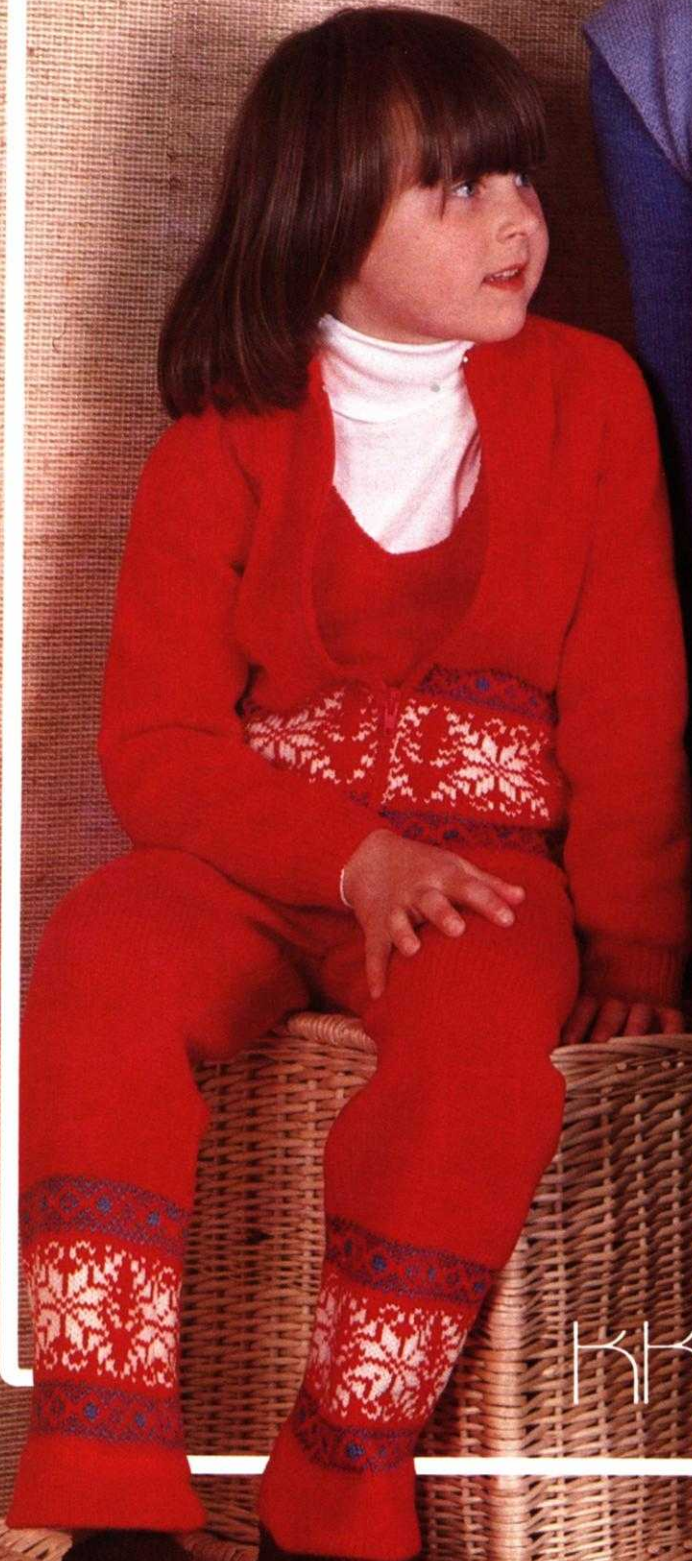

KK 658





dk 646



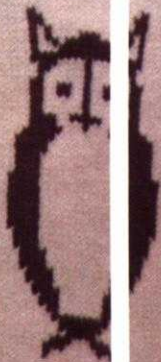

KK 639





KK 642



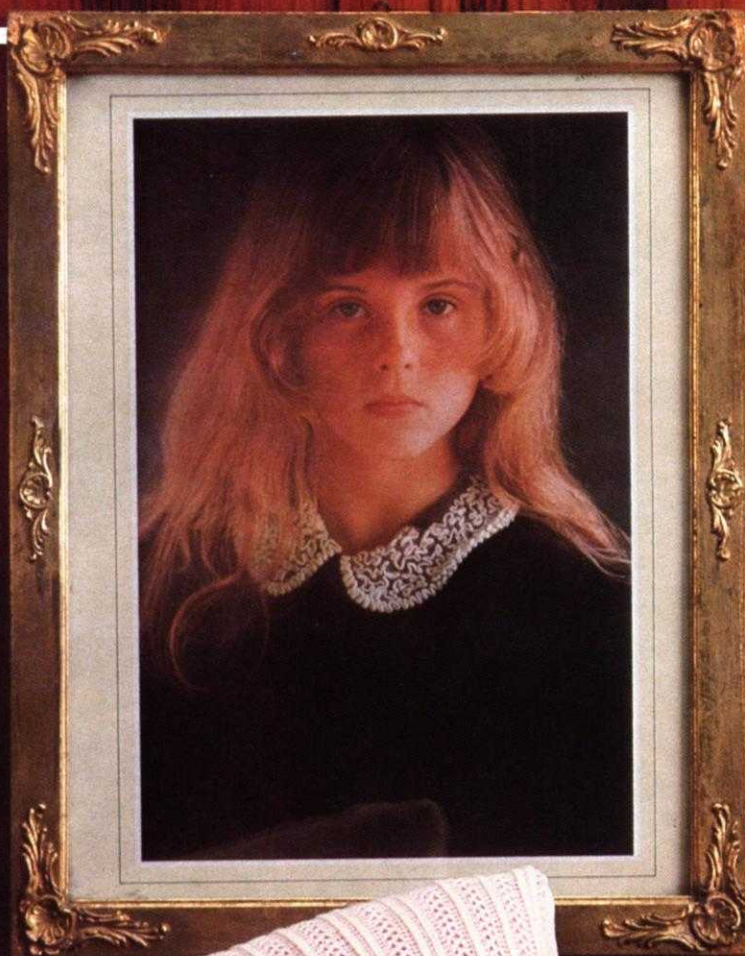

638



VOLUME 14, NO. 4

knitking *magazine*

TABLE OF CONTENTS	PAGE NO.
HP 636 Man's Pullover	14
DK 637 Woman's Pullover	15
638 Lampshade & Pillow Cover	26
KK 639 Baby Pullover & Overalls	16
KK 640 Girl's Poncho	18
KK 641 Baby Jacket & Bonnet	19
KK 642 Baby's Sleeper	20
DK 643 Woman's Two-piece Suit	20
KK 644 Girl's Jumper	22
DK 645 Woman's Three-piece Suit	23
DK 646 Woman's Scarf, Hat & Mittens	25
KK 647 Child's Slipper Sox.	27
KK 648 Child's Mittens, Cap & Scarf	27
KK 649 Girl's Dress	28
HP 650 Man's Jacket	30
DK 651 Woman's Skirt & Jacket	31
KK 652 Girl's Pullover	32
KK 653 Child's Pullover & Overalls	33
654 Hassock	34
KK 655 Girl's Hooded Jacket & Legwarmers	36
KK 656 Girl's Dress	38
KK 657 Girl's Cardigan	40
KK 658 Girl's Pullover, Jumper & Bolero	41
KK 659 Child's Coveralls & Jacket	43
KK 660 Child's Hooded Jacket & Leggins	44
KK 661 Teen Size Poncho	46
DK 662 Woman's Poncho	46
KK 663 Child's Pullover	47
664 Wall Hanging with Pockets	47
664 Pictures	48

Publisher: KNITKING CORPORATION, 1128 Crenshaw Blvd., Los Angeles, Calif. 90019. Telephone: (213) 938-2079. Published bi-monthly. Subscriptions: USA — \$12.00 annually, single copies \$3.00; Canada — \$14.00; other parts of the world — \$18.00. The entire contents of KNITKING MAGAZINE are copyright and must not be reproduced in any shape or form without the express permission, in writing of the publisher. © COPYRIGHT 1978 by KNITKING CORPORATION.

editorial

KNITKING SEMINAR, 1978

Don't forget the dates October 9th through the 14th, daily from 9:30 a.m. until 4:00 p.m. and on Saturday from 9:30 a.m. until 1:00 p.m.

There will be people coming in from all over the U.S.A. and some from other countries... Even as far away as New Zealand... There will be wonderful opportunities for you to exchange ideas and make new friends... In addition to the KNITKING team of experts, celebrities such as Carlos Arias, Tami Nobuyuki and Mitzie Tani will be with us to conduct classes and demonstrate their great talents.

The full range of KNITKING machines (including the new GENIE and KH 120 will be available for sale at low, low inflation prices... All Accessories will be discounted to visitors and we are filling up our warehouses with yarns for sale at up to 75% discounts...!! Gorgeous, top quality yarns in a range of colors that will dazzle you... Kits will be available for the stunning garments the KNITKING people will be modeling daily... and please be sure to wear some of your own creations... we and other guests would love to see them.

Admission is FREE... Coffee and doughnuts (also free) will be available at 9:30 a.m. daily. Come early and join the fun at the KNITKING SEMINAR....

KNITKING MACHINE DEALERS

















If you are a licensed Knitting Machine Dealer and interested in offering the new machines and other KNITKING products to your customers, please write to us on your letter heading... We will be happy to send you full information.



CHRISTMAS EDITION KNITKING MAGAZINE

The next issue of KNITKING MAGAZINE will be our Christmas issue and it will be filled with lovely things to make, wear and use over the holiday and winter season. There will be Suits, Dresses, Sweaters and Cardigans for Women, some handsome Sweaters for Men, an assortment of warm good looking clothing the kids will love and we even have a spectacular woven Bedspread with round and square Pillows to match. It will be a popular issue so please make sure your subscription is up-to-date... we wouldn't want you to miss it.

Pattern Symbols

Knitting – Chart Symbols

- () Size Symbols
(2nd Size)
- < > 3rd Size
- ① Color Number
-  Cast on
-  Stitch
-  Row
-  Hem
-  Bind off
-  Stockinette stitch – worn on the Knit side.
-  Stockinette stitch – worn on the Purl side.
-  Knit 1, Purl 1 Ribbing
-  Ribbing Pattern – worn on the Knit side.
-  Ribbing Pattern – worn on the Purl side.
-  Closed Dart
-  Open Dart
-  Put on a stitch holder
-  Reverse 1 section
-  On every other needle
-  Number of Rows between Shapings. Make increase (or decrease) FIRST, then knit 4 rows. For example: 3 x 1  means decrease (or increase) 1 st., knit 4 rows; decrease 1 st., knit 4 rows; decrease 1 st., knit 4 rows; decrease 1 st., knit 4 rows. All decreasing (or increasing) without row numbers as shown must be shaped on every 2nd row.

-  Increase
-  Increase 2 sts. With a transfer tool, move the sts. over the left (or right) leaving 2 empty needles at the point of increase. At the increase point, move 1 st. to the left, (or right) so that there is an empty needles on each side of a stitch. On each side of the center stitch, pick up a stitch from the row below and hang it onto the empty needle.

-  3 stitches on 1 needle. The 1st and 3rd stitch in a group of 3 has been hung on the 2nd or center needle.

-  Short Row increase or decrease; for instance on a flared skirt knitted sideways.

-  Pattern Stitch





-  Pattern Stitch – worn on the Knit side.

-  Pattern Stitch – worn on the Purl side.









-  Repeat

- I = Front
II = Back
III = Sleeve
IV = Skirt Front
V = Skirt Back
VI = Collar
VII = Pocket
VIII = Band
IX = Belt
X = Cuff
XI = Pants Front
XII = Pants Back

Finishing – Chart Symbols

-  Match numbers on section for assembling.
-  Ease
-  Fold Line
-  Turn to the wrong side and hem.

Stitch Symbols

-  Needles in holding position
-  Needles back into working position.
-  Empty needle (leave in working position)
-  Needle not used (in the out of work position).
-  Two stitches on 1 needle, either transferred from the right side or the left side, then put into holding position.
-  Needle holding 2 stitches. Stitch has been transferred from the RIGHT.
-  Needle holding 2 stitches. Stitch has been transferred from the LEFT.
-  Center of garment section



General Instructions

HOW TO READ THE CHARTS AND INSTRUCTIONS

There are 3 sizes given for each Pattern in KNITKING MAGAZINE. Above each Chart for the different sizes, you will see that the first and smaller sizes might be shown as 8/10, the second size as (12/14) and the third as [16/18]. Check the measurements at the bustline and hips on the Charts to be certain that you will knit the correct size, remembering these are ACTUAL measurements of the completed section and that there must be a bigger allowance at the bustline and hipline for a Jacket or a Coat than there would be for a fitted dress or a fitted blouse or pullover. The question in your mind should be "How do I want this garment to fit...?"

When you have chosen the size you need, you can follow the Charts as shown. You will notice that where the shapings are the same FOR ALL SIZES, only 1 set of shapings will be shown on the first Chart and if you are knitting the 2nd or 3rd size, you simply follow the shapings as given for the first size. If the shapings are different, this will be shown on the Charts and you should follow them as given.

On the Charts, increases and decreases will be shown as follows

5×1
 $\boxed{6}$ The number in the box means number of ROWS between the shapings, while the 5×1 above the box means - 1 st. $5 \times \dots$ so you will increase or decrease 1 st. every 6th row $5 \times$.

ARMHOLE SHAPINGS - NECK SHAPINGS - SHOULDER SHAPINGS - are made on every 2nd row UNLESS there is a number in a box along side or below the shapings. The rule is... where there is no box with a number, the shaping is made on every 2nd row.

THE PRINTED INSTRUCTIONS

You can follow the printed instructions or use them in combination with the Charts. Where there is any question in the printed instructions, you have the Charts to show you how the section will look.

The 3 sizes, with the different amounts of cast on stitches and the different shapings will look like this...

Cast on 124 (136) [148] sts. You will
Cast on 124 sts. for the first size.
Cast on 136 sts. for the 2nd size.
Cast on 148 sts. for the 3rd size.

The important thing to remember is that you MUST READ AHEAD so that you KNOW what to do for the size you are knitting. Sometimes where the number of stitches are the same but the number of times different, you will find shapings like this...
3 sts. 1x (2x) [3x], 2 sts. 1x (2x) [3x], 1 st. 3x (4x) [5x].
As you see, you MUST read ahead in order to follow the instructions as given for YOUR SIZE. The rows will be different for the different sizes in some cases... Shoulder and Neck shapings usually are worked at the SAME TIME for the back section - so watch for the words AT THE SAME TIME.

HOLDING STITCHES ON THE LEFT SIDE WHILE SHAPING THE RIGHT SIDE

When knitting a section of garment in stockinette stitch, it is easy to hold the stitches on the left side while knitting the right half, but when knitting a Pattern Stitch such as a Norwegian Design, a Holding Position Design, Weaving, etc., you should use the following method. For the NECK SHAPING, we tell you to bind off the center sts., put the needles on the left into holding position and complete the right half first... so with a strand of contrast yarn, knit ALL of the left side stitches manually by hand, pulling each stitch back against the needle bed to the OUT OF WORK position. When the right side is completed, carefully pull the stitches held on contrast, forward into working position and as you do so, undo the contrast yarn, line up the needles (KNITKING AM 3 machine owners, put the stitches under the sinkers) and complete the left half.

If you own a Japanese machine, you may find that when knitting the right half with the left side held in this way, the sinker plate will mark the left side while you are knitting the right half. To prevent this marking, you can tape a piece of paper over the knitting, underneath the sinkers, or if you own a Reversing Bar, you can hang this onto the Sinkers while you are knitting the right half. When hanging the Reversing Bar, be sure the eyes of the bar go BETWEEN the Sinker Posts on the upper part of the bar so that the tips of the bar only - show above the needle bed.

FULL FASHION DECREASING OR INCREASING

For Stockinette stitch, always use the Full Fashion method for increasing or decreasing.

TO DECREASE: Hang the 3rd stitch onto the 2nd stitch then move the stitches in to fill the empty needle.

TO INCREASE: Move the 2 end stitches 1 needle outward, then pick up the 3rd stitch from the row below and hang it onto the empty needle.

FINISHING: Block all sections. For PULLOVERS, JACKETS, and DRESSES: Join front to back at sides and shoulders. Sew sleeves together and set in. Hem lower edge and sleeve edges if needed. For a double neckband or armhole band, sew 1 edge to the inside and 1 to the outside of neck or armhole. For a single ribbed band, sew 1 edge to the outside of neck or armhole edge. For a cardigan or jacket with buttonholes, finish buttonholes and sew on buttons.

PANTS: Join front to back at sides. Sew inside leg seams, then join center front and back. Make hem at waistline and insert elastic. Hem lower edge of pants legs.

THE SAMPLE SWATCH

Before you begin to knit any garment, you will need to knit a sample piece using the yarn you have chosen for your garment, so that you can check the stitch and row gauge which must measure the correct number of stitches and rows in 5 cm (2 inches).

For each Pattern in KNITKING MAGAZINE, we give you 3 tension numbers to work from and if you use the specified yarn for the garment, you should be able to get the correct stitch and row gauge using one of these numbers. Here is a very easy way to make your sample swatch and count the stitches and rows without actually counting, by using our KNITKING Converta Tape.

Supposing the Tension Numbers for the Stitch and Row Gauge are given as 5 to 7. Set the Tension Dial to the first number which is 5. With contrast waste yarn, and using the quick cast on method, cast on 60 stitches and knit 10 rows. Change to garment yarn and turn the Row Counter to 0. Knit 30 rows. Counting from each end, knit the 10th stitch on each side by hand with a small piece of contrast yarn. Leave the needles in working position and knit 30 rows (Row 60), then knit 4 rows with contrast waste yarn. Turn the Row Counter to 0 and the Tension Dial to 6 and with garment yarn, knit 30 rows. Mark the 10th stitch on each side as you did before, knit 30 rows, then 4 rows with contrast waste yarn. Turn the Row Counter to 0 and with Tension 7, repeat the above once more, ending with 10 rows of contrast waste yarn. Remove the work from the machine by passing the Slide across the needles without yarn (sometimes called 'dropping'). Pull and stretch the sample piece both lengthwise and diagonally from corner to corner, then lengthwise again. Do not count the stitches and rows immediately, but allow the sample to rest for several hours or even overnight. This will allow the stitches and rows to return to their basic form.

When your sample has rested and you are ready to count the stitches and rows, the KNITKING CONVERTA TAPE will do the counting for you without any counting on your part. Use the Tape as follows:

Measure the stitches with the TAPE, BETWEEN the 40 stitches marked with contrast waste yarn. Push the SLIDE so that the LEFT EDGE lines up to this exact measurement. Now look down along side the SLIDE and find the number 40 on the TAPE. The number directly opposite on the SLIDE will be your Stitch Gauge to 5 cm (2"). To find the number of rows in 5 cm (2"), place the TAPE to measure over the 60 rows, push the SLIDE to this number with the left edge lined up, the look for the number 60 on the TAPE and directly opposite this will be the number of rows to 5 cm (2")

If you do not own a KNITKING CONVERTA TAPE, you must mark a 5 cm (2 inch) square in the center of the knitting, then count the number of stitches and rows within the square.

hp 636

MAN'S PULLOVER

SIZES: 36 (38/40)
 YARN: Euro Sport
 GRAMS: 750 800
 TENSION: 10
 GAUGE: 12 sts. 15 rows = 5 cm (2")



A Cable Design on the Front section and Sleeves. The bands are K1, P1 Ribbing.

FINISHING: See General Instructions. Sew Neckband and Pocket Bands in place.

NEEDLE SET UP FOR PATTERN.

*16 knit sts., 1 purl st., 5 knit sts., 1 purl st. REPEAT from *.
 PATTERN: Knit 10 rows, then make Cable over the 5 knit sts. by twisting sts. 1 and 2 with 4 and 5. REPEAT every 10th row.

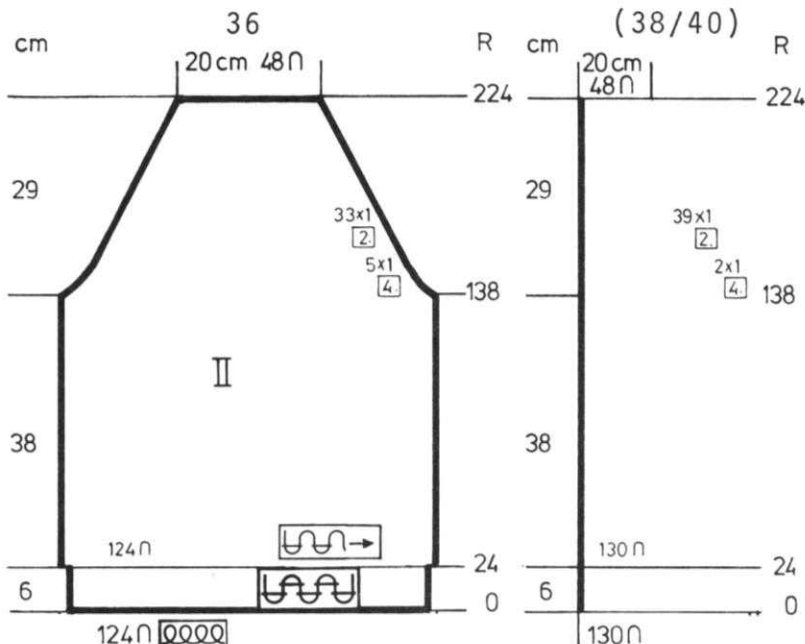

BACK: II

Cast on 124 (130) sts. and work 24 rows K1, P1 Ribbing. Continue in Stockinette stitch. Knit to Row 138. SHAPE RAGLAN: ON EACH SIDE, decrease 1 st. every 4th row 5x (2x), every 2nd row 33x (39x). After Row 224, bind off the remaining sts.

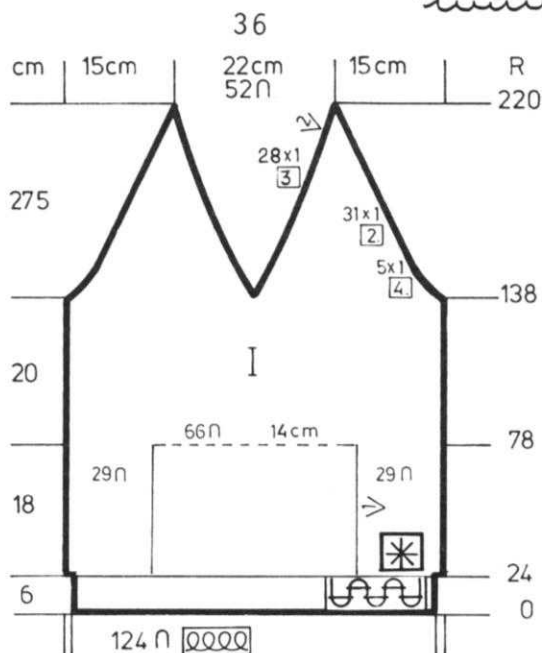

(38/40)

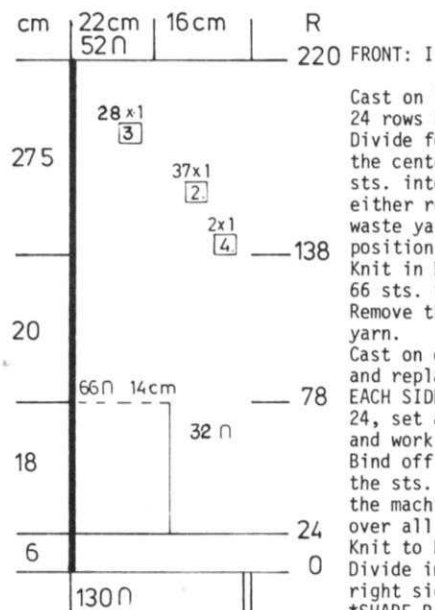

FRONT: I

Cast on 124 (130) sts. and work 24 rows K1, P1 Ribbing. Divide for pocket. Work over the center 66 sts. only. Set these sts. into Pattern and ON EACH SIDE, either remove 29 (32) sts. onto waste yarn or put them into holding position. Knit in Pattern over the center 66 sts. to Row 78. Remove these sts. onto contrast waste yarn. Cast on over the center 66 needles and replace the 29 (32) sts. ON EACH SIDE. Put Counter back to 24, set all the needles into Pattern and work the Cable Pattern to Row 78. Bind off the center 66 sts. then hang the sts. held on waste yarn onto the machine and continue in Pattern over all the needles. Knit to Row 138. Divide in the center and complete the right side first. *SHAPE RAGLAN AND NECK AT THE SAME TIME. FOR RAGLAN, decrease 1 st. every 4th row 5x, every 2nd row 31x, (every 4th row 2x, every 2nd row 37x), FOR NECK, decrease 1 st. every 3rd row 28x for both sizes. Bring the needles on the left into working position, turn the Row Counter back to 138 and complete the left half. Follow the instructions from *.

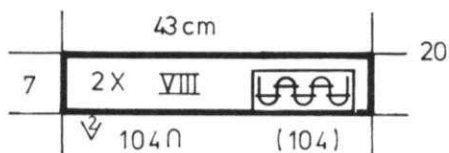

NECKBAND: VIII Make 2.

Cast on 104 sts. and work 20 rows K1, P1 Ribbing then bind off the crochet method for Ribbing.

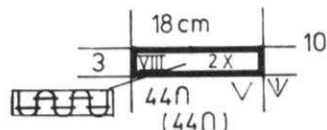
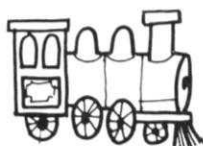

POCKET BANDS: VIII Make 2.

Cast on 44 sts. and work 10 rows K1, P1 Ribbing then bind off the crochet method for Ribbing.



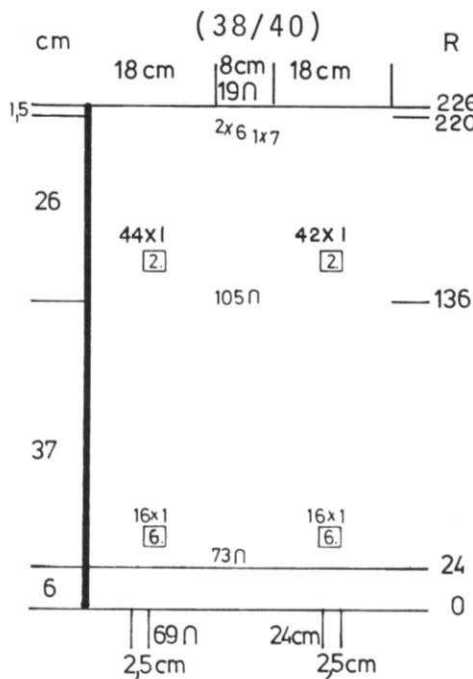
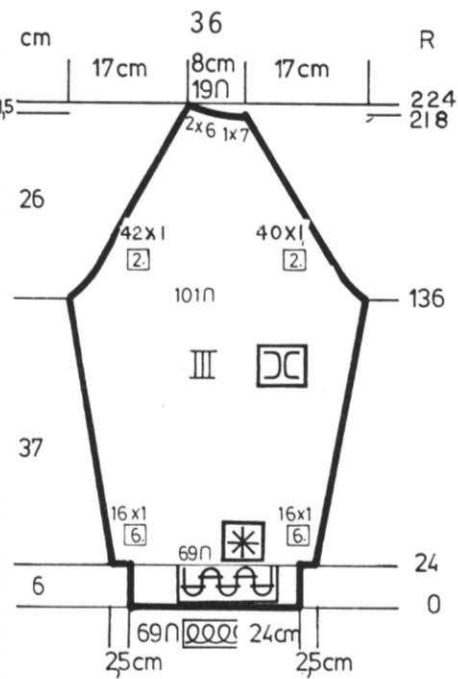

SLEEVES: III Make 1, reverse 1.

Cast on 69 sts. and work 24 rows K1, P1 Ribbing.
Continue in Pattern.
ON EACH SIDE, increase 1 st. every 6th row 16x.
Knit to Row 136.
SHAPE RAGLAN:
ON FRONT SIDE of raglan, decrease 1 st. every 2nd row 40x (42x) and on BACK SIDE, decrease 1 st. every 2nd row 42x (44x).
After Row 218 (220), bind off 7 sts. 1x, 6 sts. 2x for both sizes.
REVERSE the shapings for 2nd Sleeve.

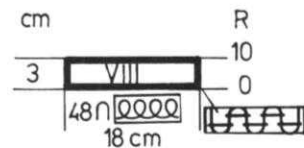

POCKET BANDS: Make 2.

Cast on 48 sts. and work 10 rows K1, P1 Ribbing. Bind off the crochet method for Ribbing.

dk 637

A Cable Design with bands and collar K1, P1 Ribbing. You will set up the needles with 4 sts. on the main machine and 1 on the Ribber - across the needle bed. After Every 10 rows, use two double transfer tools and remove 2 sts. on each tool, twist the stitches and hang them back onto the machine. The Cable Design is on the front section and the center of sleeves. The back is Stockinette stitch.



FINISHING: See General Instructions.

FRONT:

BE SURE TO READ THE INSTRUCTIONS FOR CABLE as given above the FINISHING:

Cast on 125 (131) sts. and work 30 rows K1, P1 Ribbing. Continue in Stockinette stitch with Cable Design as shown on the Line Drawing, leaving 39 sts. in the center on the main machine with the Cable Pattern set up on each side.

After Row 44, ON EACH SIDE, remove 16 (19) sts. onto waste yarn (or you can put them in holding but you must transfer the Ribber sts. to main machine first.

ON EACH SIDE of the 93 sts., decrease 2 sts. every 2nd row 6x, 1 st. 15x. After Row 84, remove these 39 sts. onto waste yarn.

With garment yarn cast on over the 93 empty needles (closed cast on). Counter at 30.

Knit 14 rows, then rehang the 16 sts. held on waste yarn onto the machine. Set the Pattern on each side of the center 93 sts.

Knit to Row 84. Bind off the center 39 sts. then hang the sts. held on waste yarn onto the machine and set in Pattern across.

Knit to Row 134 (138). SHAPE RAGLAN: ON EACH SIDE, on every 2nd row, decrease 2 sts. 6x (6x) 1 st. 29x (31x).

AT THE SAME TIME, after Row 186 (190) Bind off the center 15 (15) sts. put the needles on the left into holding position and complete the right side first.

*ON NECK SIDE, bind off 3 sts. 2x, 2 sts. 2x, 1 st. 4x (5x). Bring the needles on the left into working position, knit 1 row to the left side, turn the Row Counter back to 186 (190) and complete the left half. Follow the instructions from * and don't forget to complete the raglan shaping.



WOMAN'S PULLOVER

SIZES: 10/12 (14/16)
YARN: Euro Sport
GRAMS: 750 800
TENSION: 10
GAUGE: 12 sts. 15 rows = 5 cm (2")

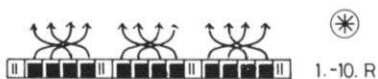

10/12

(14/16)

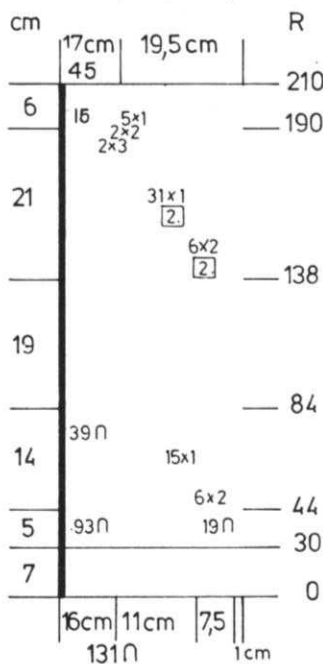
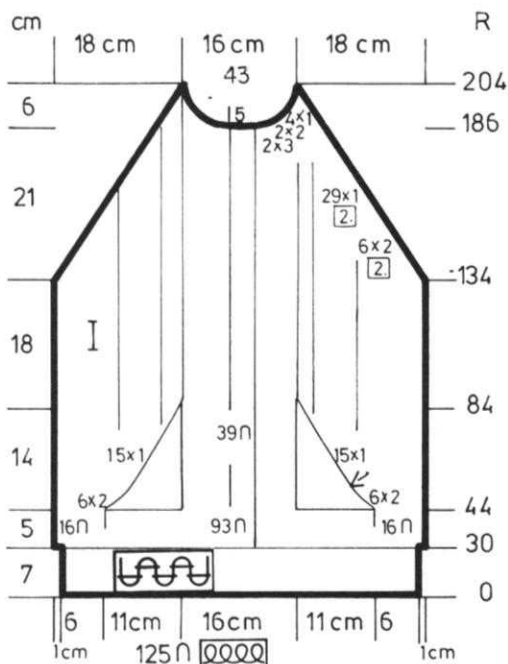

dk 637

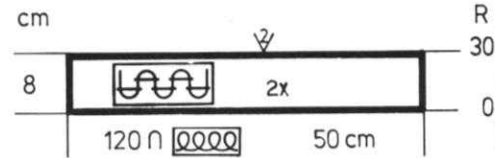
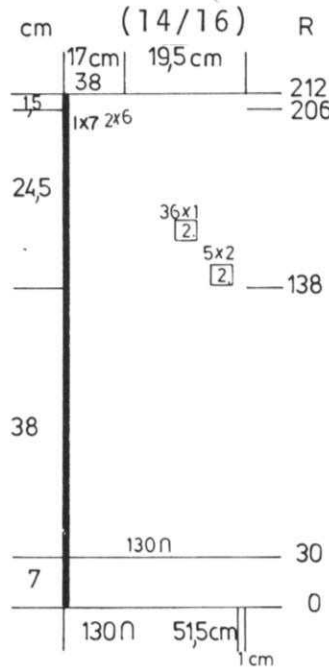
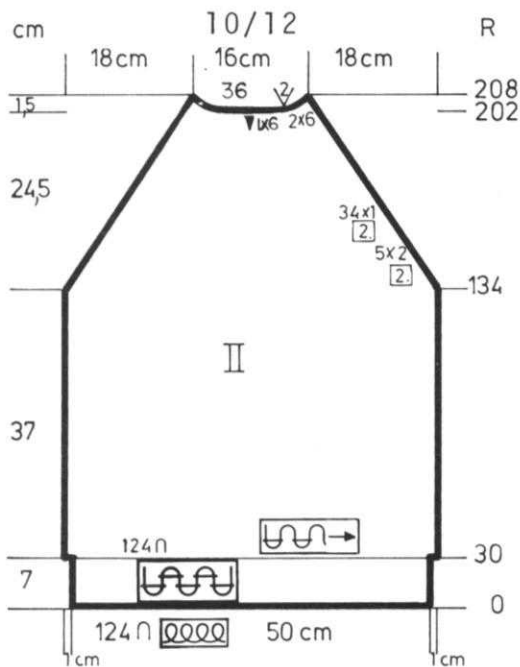

COLLAR: Make 2 sections.

Cast on 120 sts. and work 30 rows K1, P1 Ribbing, bind off the crochet method for Ribbing.

BACK: II

Cast on 124 (130) sts. and work 30 Rows K1, P1 Ribbing. Continue in Stockinette stitch. Knit to Row 134 (138)

SHAPE RAGLAN: ON EACH SIDE

ON EVERY 2nd Row, decrease

2 sts. 5x, then 1 st. 34x (36x).

After Row 202 (206), SHAPE NECK: Put half the sts. on the left into holding position and complete the right side first.

*ON NECK SIDE, bind off

6 (7)sts. 1x, 6 sts. 2x for both sizes.

Bring the needles on the left into working position, knit 1 row to the left side, turn the Row Counter back to 202 (206) and complete

the left half. Follow the instructions from *

SLEEVES: Make 1, reverse 1.

Cast on 60 (62) sts. and work 24 rows K1, P1 Ribbing.

Increase 1 st. and continue in Stockinette stitch with Cable Pattern over the center needles as follows: -

Leave 9 sts. in the center on the main machine then set up the Cable as shown on the

Line Drawing - 3 Cables on each side of the center 9 sts. Explanation of the Cable is given above the Finishing.

ON EACH SIDE, increase 1 st. every 6th row 16x (17x).

Knit to Row 124.

SHAPE RAGLAN: Make the RAGLAN

DECREASES on Every 2nd row

37x on the Left, 38x on the right.

(39x on the left, 40x on the right).

After Row 194 (198), work SHORT

ROWS: ON OPPOSITE SIDE OF CAM BOX,

put into holding position

6 sts. 3x.

After Row 200 (204) Bring all

the needles into work, knit 1 row

then bind off.

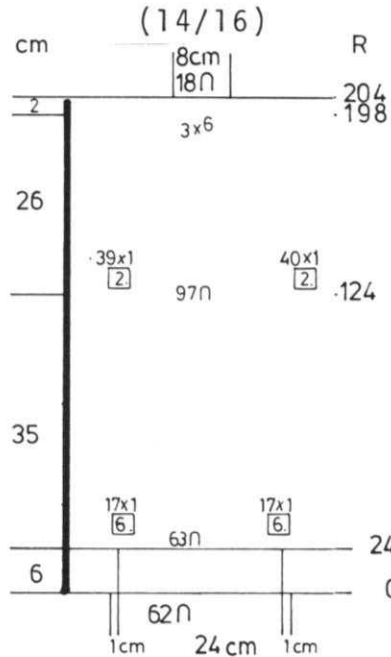
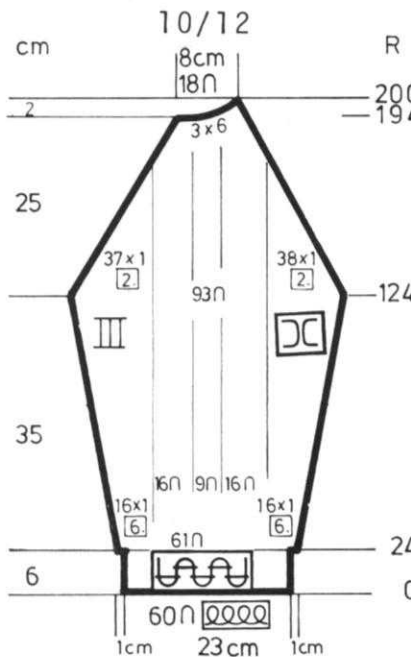

kk 639

BABY PULLOVER & OVERALLS

SIZES: 12 to 18 months (2 years)

YARN: Amore

GRAMS:

color 1 200 200

color 2 100 100

TENSION: 7 to 9

GAUGE: 17 sts. 19 rows = 5 cm (2")

The Overall is Stockinette stitch with a Norwegian Border Design on front Bib. The Pullover is a Norwegian Design. Leg Bands and Pullover lower edge are in Stockinette stitch.

FINISHING: Pullover: Weave shoulder & sleeve seams and sew sides together.

Work 1 row single crochet and 1 row reverse single crochet around

front and neck edges and AT THE

SAME TIME on front diagonal shaping

crochet 4 small buttonholes. Work

the same crochet around sleeves.

OVERALLS: Sew fabric strips to

sides of front and back sections

then put in gripper snaps. Work

the same crochet edging as on

Pullover around the bib section

after sewing it in place. Crochet

around straps making loop for

buttonhole and sew buttons to

front of bib (see picture).

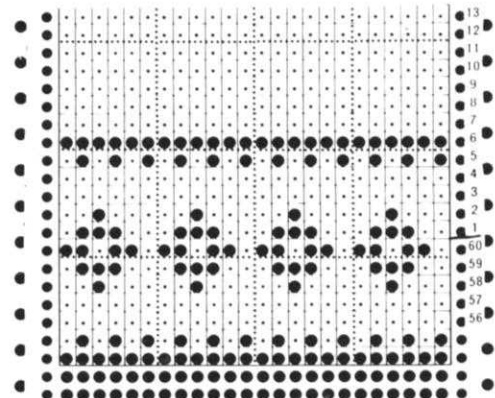

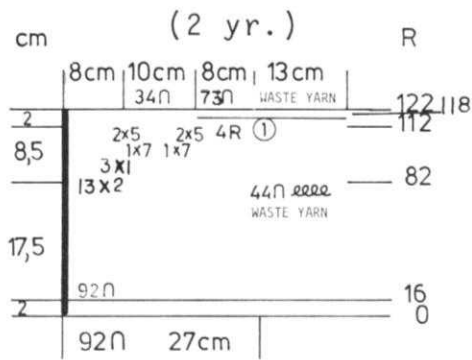
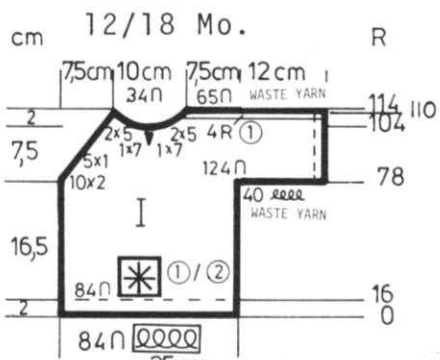

RIGHT FRONT: I
 Cast on 84 (92) sts. with color 1 and work 16 rows Stockinette stitch. Continue in the Norwegian Design. After Row 78 (92) ON THE RIGHT, cast on 40 (44) sts. with contrast waste yarn. ON THE LEFT, after Row 79 (83), bind off 2 sts. 10x, 1 st. 5x, (2 sts. 13x, 1 st. 3x), AND AT THE SAME TIME, after Row 104 (112) divide for NECK. Leave 82 (90) sts. on the right side in working position and put the remaining sts. on the left into holding position. *ON NECK SIDE, bind off 7 sts. 1x, 5 sts. 2x for both sizes and AFTER ROW 110 (118), work 4 rows Stockinette stitch with color 1. After Row 114 (122) remove the sts. onto contrast waste yarn. Bring the needles on the left into working position, knit 1 row in Pattern to the left side, turn the Row Counter back to 104 (112) and complete the left half. Follow the instructions from * for the NECK SHAPING and don't forget to complete the diagonal shaping on the LEFT.

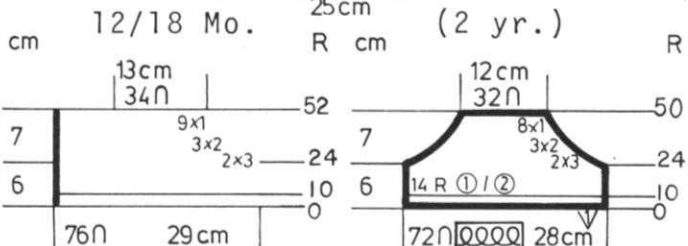

BIB:
 Cast on 72 (76) sts. with color 1 and work 10 rows Stockinette stitch. Work 14 rows of the Norwegian Design then continue in Stockinette stitch with color 1 and ON EACH SIDE, bind off 3 sts. 2x, 2 sts. 3x, 1 st. 8x (9x). After Row 50 (52) bind off the remaining sts.

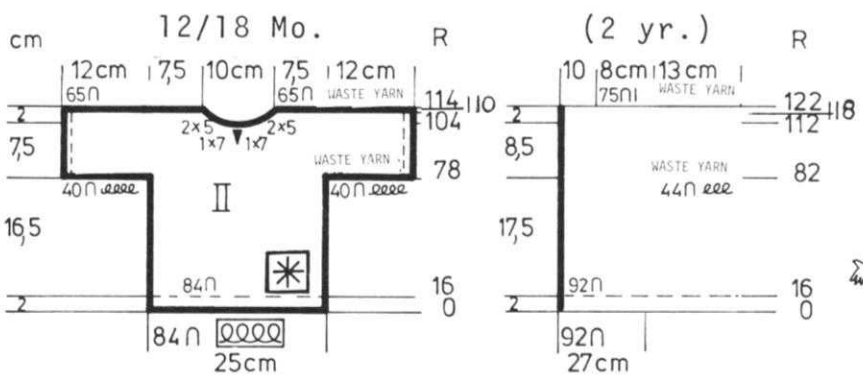

PULLOVER BACK: II

Cast on 84 (92) sts. with color 1 and work 16 rows Stockinette stitch. Continue in the Norwegian Design. Knit to Row 78 (82). With contrast waste yarn, cast on 40 (44) sts. ON EACH SIDE.

After Row 104 (112), divide in the center, put the needles on the left into holding position and complete the right side first. *ON NECK SIDE, bind off 7 sts. 1x, 5 sts. 2x, for both sizes. After Row 110 (118), work 4 rows Stockinette stitch with color 1. After Row 114 (122) remove the sts. onto contrast waste yarn. Bring the needles on the left into working position, knit 1 row in Pattern to the left side, turn the Row Counter back to 104 (112) and complete the left half. Follow the instructions from *.

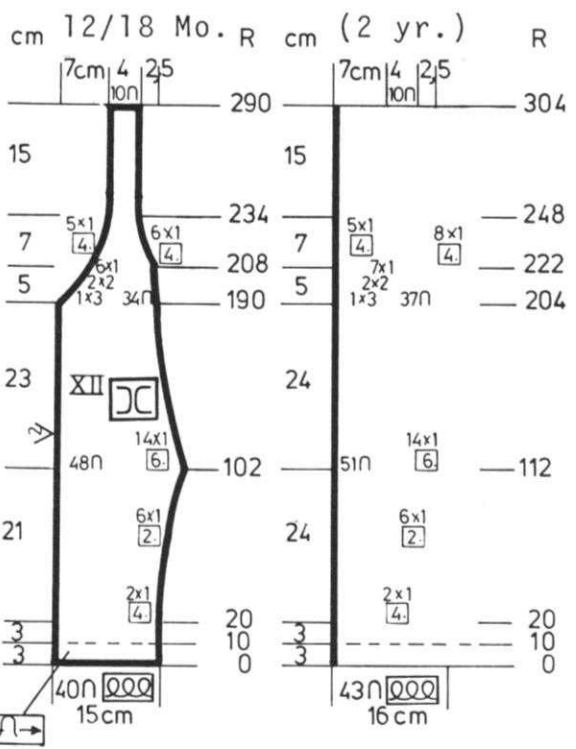
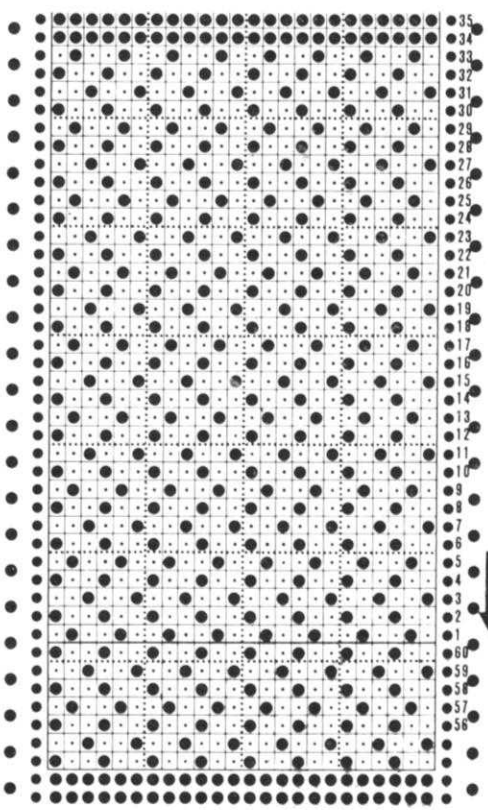

OVERALLS BACK XII (Make 1, reverse 1).
 Cast on 40 (43) sts. color 1 and work Stockinette stitch. Knit to Row 20. ON CENTER BACK, increase 1 st. every 4th row 2x, every 2nd row 6x for both sizes. After Row 102 (112) ON CENTER BACK, decrease 1 st. every 6th row 14x for both sizes. After Row 189 (203), SHAPE ARMHOLE: Bind off 3 sts. 1x, 2 sts. 2x, 1 st. 6x (7x) then on every 4th row, decrease 1 st. 5x BUT AT THE SAME TIME, after Row 208 (222) SHAPE NECK, decrease 1 st. every 4th row 6x (8x). Knit to Row 290 (304) then bind off the remaining sts.



KK 639



cm 12/18 Mo. R

cm (2 yr.) R

OVERALLS FRONT: XI
Make 1, reverse 1.

LEFT FRONT: I

Cast on 40 (43) sts. with color 1 and work Stockinette stitch. After Row 20, ON CENTER FRONT, increase 1 st. every 4th row 2x, every 6th row 6x for both sizes. After Row 101 (111) ON CENTER FRONT, bind off 2 sts. 1x, then decrease 1 st. every 4th row 8x for both sizes. After Row 162 (176), bind off the remaining sts.

Cast on 40 (42) sts. with color 1 and work 16 rows Stockinette stitch. Continue in the Norwegian Design. After Row 78 (82), with contrast waste yarn, cast on 40 (44) sts. on the LEFT SIDE. After Row 104 (112) SHAPE NECK: Bind off 5 sts. 3x. (5 sts. 2x, 3 sts. 1x). After Row 110 (118), work 4 rows Stockinette stitch with color 1. After Row 114 (122) remove the sts. onto contrast waste yarn.

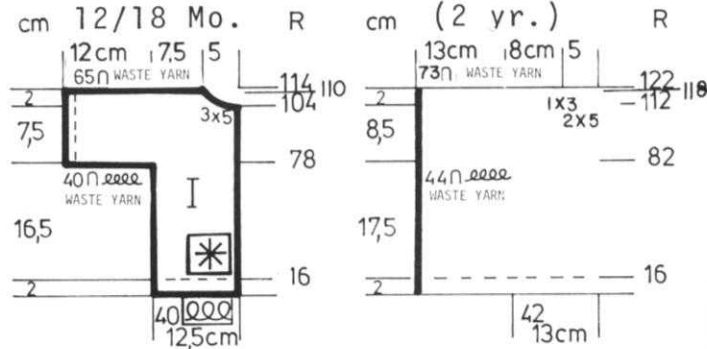
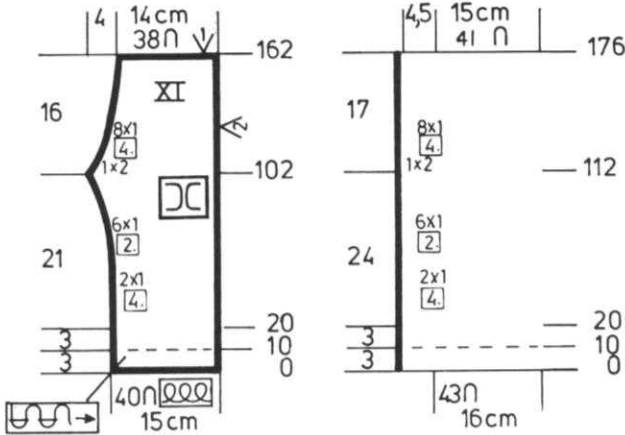

KK 640

GIRL'S PONCHO

SIZES: 12 (14)
YARN: Euro Sport
GRAMS:
color 1 550 600
color 2 50 100
TENSION: 10
GAUGE: 12 1/2 sts. 15 rows = 5 cm (2")



Stockinette stitch worn on the Purl side with a Norwegian Design set in down the shoulder sections and sides.

FINISHING: Sew sections together leaving openings for arm slits. On lower edge, pick up onto circular needle, taking 18 sts. from bottom of small section (314 sts. altogether). Knit 6 rows garter stitch then bind off. HOOD: sew back seam. Work 1 row single crochet around face opening taking 2 sts. together then work 1 row reverse single crochet.

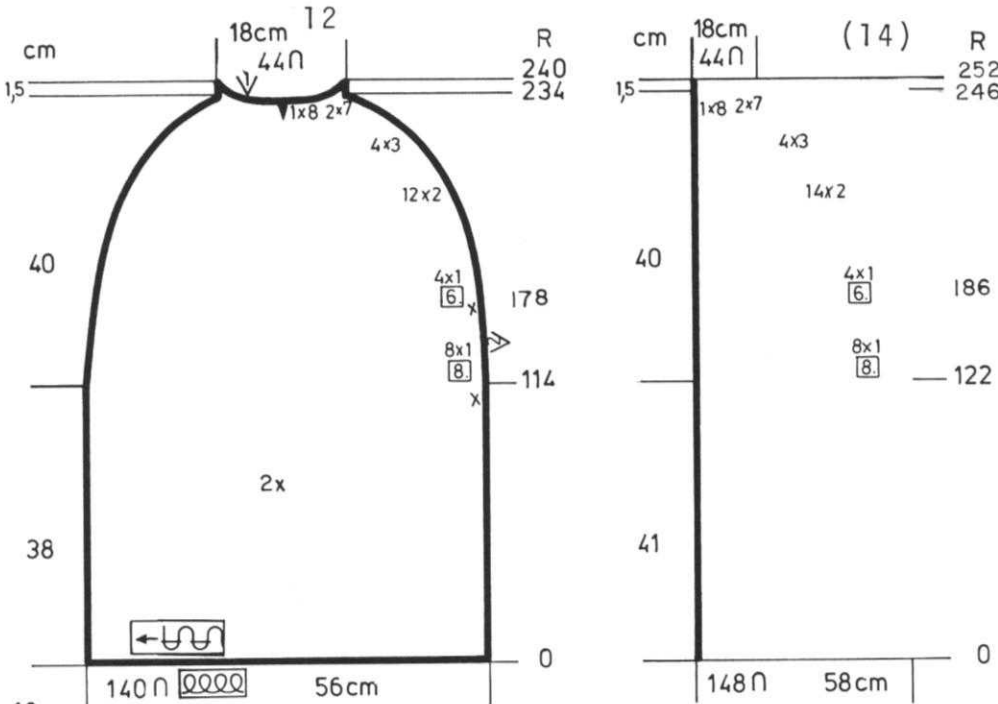
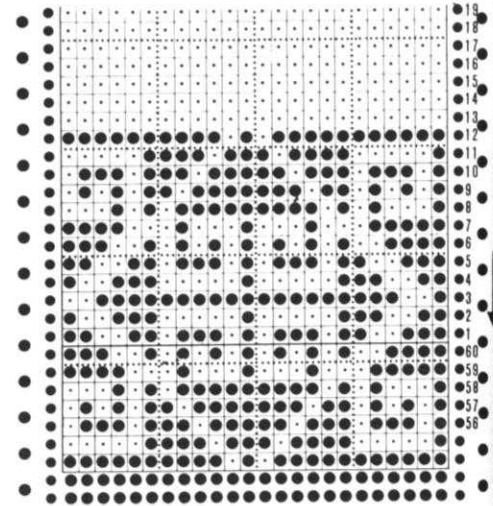

FRONT AND BACK (both sections the same).

Cast on 140 (148) sts. with color 1 and work Stockinette stitch. Knit to Row 114 (122). Mark each side with contrast yarn for arm opening, (also Row 178 (186)). ON EACH SIDE, decrease 1 st. every 8th row 8x, every 6th row 4x. ON EACH SIDE, decrease 2 sts. 12x (14x) then 3 sts. 4x for both sizes. After Row 234 (246) divide in the center and work the right side first. (You can use short rows for shaping the neck if you like). *ON NECK SIDE, bind off 8 sts. 1x, 7 sts. 2x for both sizes. Move the Cam Box to the left side, turn the Row Counter back to 234 (246) and complete the left half. Follow the instructions from *

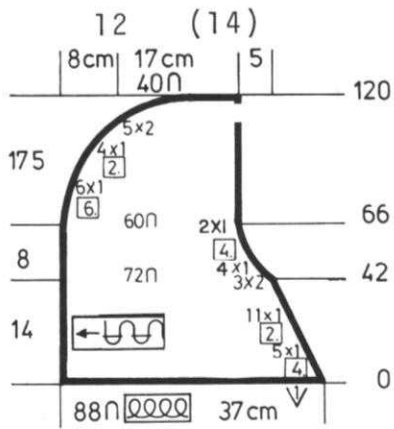

HOOD Make 1, reverse 1.

Cast on 88 sts. with color 1 and work Stockinette stitch. ON THE RIGHT (left for 2nd section) decrease 1 st. every 4th row 5x, every 2nd row 11x. After Row 42, bind off 2 sts. 3x, 1 st. 4x, then every 4th row 1 st. 2x. After Row 66, ON THE LEFT (right for 2nd section) decrease 1 st. every 6th row 6x, every 2nd row 4x, then bind off 2 sts. 5x. After Row 120, bind off the remaining sts.

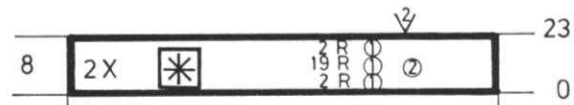

SHOULDER STRIPS: Make 2

Cast on 200 sts. with color 1 and work 2 rows Stockinette stitch then 19 rows Norwegian Design and 2 rows color 1. Bind off.

You will need an extra piece for each strip - so cast on 12 sts. and work in same pattern as above.



KK 641

BABY JACKET & BONNET

SIZE: 6 to 9 Months
 YARN: Micaela
 GRAMS: 150
 TENSION: 4 to 6
 GAUGE: 16 sts. 32 rows = 5 cm (2")

A Tuck Stitch Pattern with 3 stitches on the main machine and 1 stitch on the Ribber. Punch your own Card. AM 3 machine owners, follow the Line Drawing for a Holding Position Design.

FINISHING: See General Instructions. Work crochet edging as follows around edges.
 1 Row single crochet
 Row 2 -*Yarn over hook, go into 2nd stitch and pull through 7x (cluster), chain 1 and REPEAT. Hat: Fold the 38 bound off sts. to the sides of back and sew in place. Work same crochet around edges. Make 2 cords for ties.



cm 6 to 9 Months R

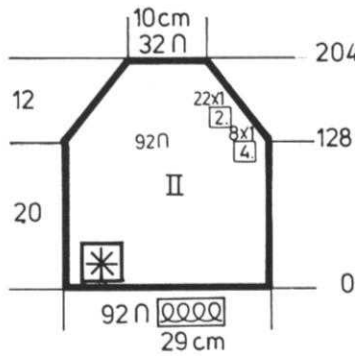

FRONT: I Make 1, reverse 1.

Cast on 50 sts. and work in Pattern. Knit to Row 40. Make BUTTONHOLE by transferring the 2nd st. to the 3rd st. on front edge and leave the needle in working position. REPEAT THE BUTTONHOLES after the rows shown on the Chart. After Row 128, SHAPE RAGLAN same as the back and AT THE SAME TIME after Row 185, SHAPE NECK: Bind off 6 sts. 1x, 4 sts. 1x, 2 sts. 3x, 1 st. 4x.

BACK: II

Cast on 92 sts. and work in Pattern. Knit to Row 128. SHAPE RAGLAN: ON EACH SIDE, decrease 1 st. every 4th row 8x, every 2nd row 22x. After Row 204, bind off the remaining sts.

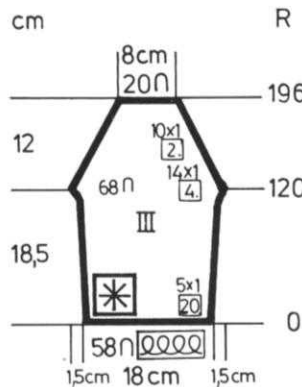
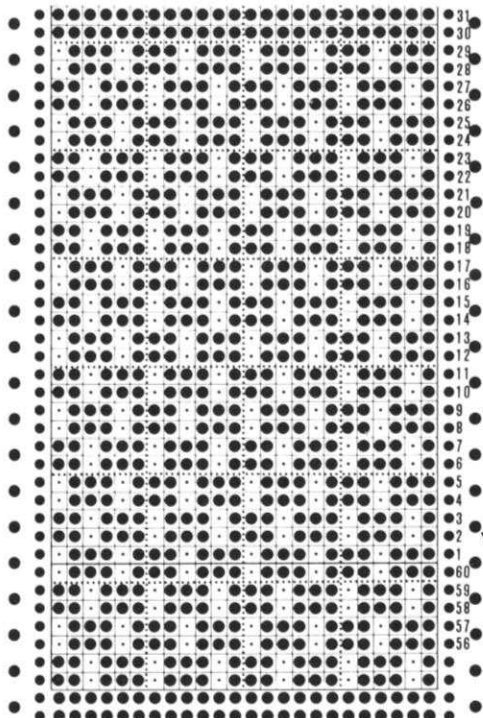

SLEEVES: III

Cast on 58 sts. and work in Pattern. ON EACH SIDE, increase 1 st. every 20th row 5x. After Row 120, SHAPE RAGLAN: ON EACH SIDE, decrease 1 st. every 4th row 14x, every 2nd row 10x. After Row 196, bind off the remaining sts.

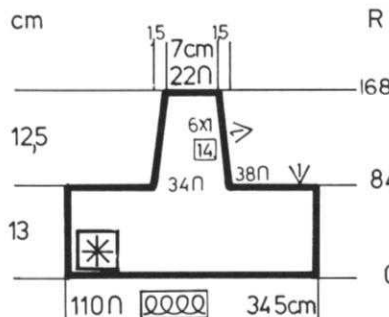
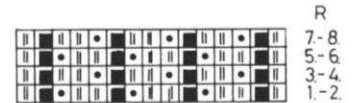

HAT:

Cast on 110 sts. and work in Pattern. Knit to Row 84. ON EACH SIDE, bind off (or you may remove onto waste yarn) 38 sts. ON EACH SIDE, decrease 1 st. every 14th row 6x. After Row 168, bind off the remaining stitches.

KK 642

BABY'S SLEEPER

SIZES: 9 to 12 Mo. (13 to 16 Mo.)
YARN: Amore
GRAMS:
 color 1 150 200
 color 2 50 50
 color 3 50 50
TENSION: 6 to 8
GAUGE: 12 sts. 30 rows = 5 cm (2")

A Tuck Stitch Pattern. Punch Card machine owners, punch your own card. Push in BOTH Tuck Buttons for Pattern AM 3 machine owners, use Wheel No. 6, Dial 1 and 2. Follow the Chart for the color changes.

FINISHING: Fold sections in half and sew shoulder seams. Set in sleeves. Sew up back seam then sew leg seams. Work 1 row single crochet down front then sew in zipper. Work 2 rows single crochet with color 1 around leg and sleeve edges skipping every 2nd st. (31 sts.) With color 2, work Shell stitch - *7 double crochet in 2nd st., 1 single crochet in next st., skip 1 sc, then REPEAT FROM *. Work 2 rows single crochet with color 1 around neckline then with color 2, work the same shell stitch as for leg and sleeve edges.



use same punch card as KK 663

BACK & FRONT: I/II Make 1, reverse 1

Cast on 114 (122) sts. with color 1 and work in Pattern.
 ON EACH SIDE, decrease 1 st. every 6th row 19x for both sizes.
 After Row 144 (156), SHAPE CENTER FRONT & CENTER BACK AT THE SAME TIME. (both sizes the same).
 ON FRONT EDGE, bind off 2 sts. 1x, 1 st. 6x and ON CENTER BACK, decrease 1 st every 4th row 8x.
 After Row 158 (188), work the color stripes as shown on the Chart.

After Row 264 (278) Divide in the center, put the needles on the left into holding position and complete the right side first. Knit to Row 310 (334). SHAPE FRONT NECK: Bind off 3 sts. 2x, 2 sts. 2x, 1 st. 3x. (3 sts. 2x, 2 sts. 3x, 1 st. 3x). After Row 326 (350), bind off the remaining sts.

Bring the needles on the left into working position, knit 1 row in Pattern to the left side, turn the Row Counter back to 264 (278) and complete the left half. Knit to Row 320 (344) SHAPE BACK NECK: Bind off 5 sts. 2x, 3 sts. 1x. (5 sts. 3x).

After Row 326 (350), bind off the remaining sts.

REVERSE THE SHAPINGS FOR 2nd section.

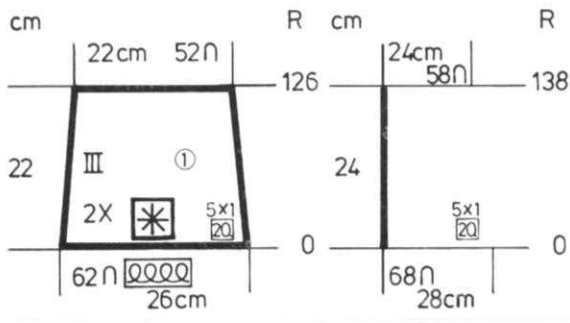
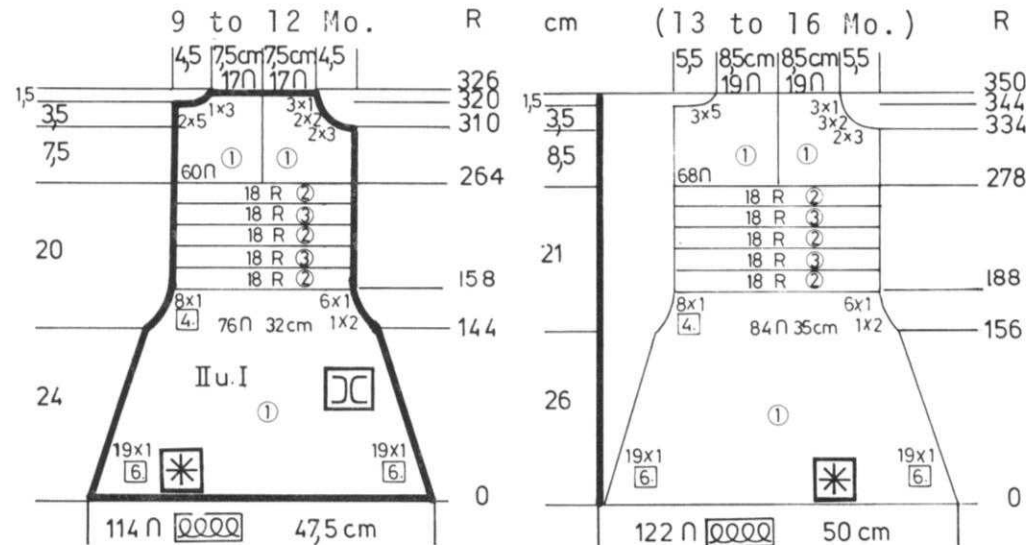

SLEEVES: III

Cast on 62 (68) sts. with color 1 and work in Pattern.
 ON EACH SIDE, decrease 1 st. every 20th row 5x for both sizes.
 After Row 126 (138), bind off the remaining sts.

KK 643

WOMAN'S TWO PIECE SUIT

SIZES: 10 (12) [14]
YARN: Vienna
GRAMS:
 color 1 500 550 600
 color 2 500 550 600
TENSION: 6 to 8
GAUGE: 16 sts. 17 rows = 5 cm (2")



A Norwegian Design. Punch your own Card.

FINISHING: See General Instructions.
SKIRT: Baste pleats in x to x shown on Chart. Turn 10 pocket sts. in and line with pellon. **JACKET:** Face Jacket facings with Pellon. Finish Buttonholes and sew on Buttons.

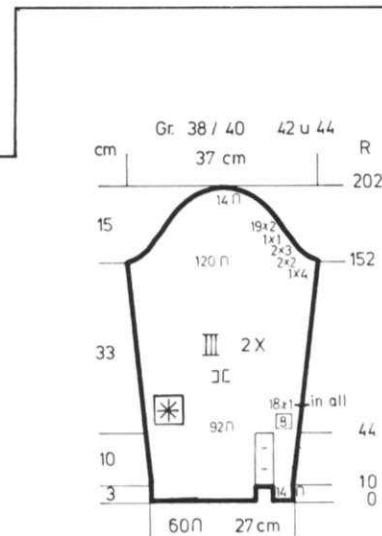
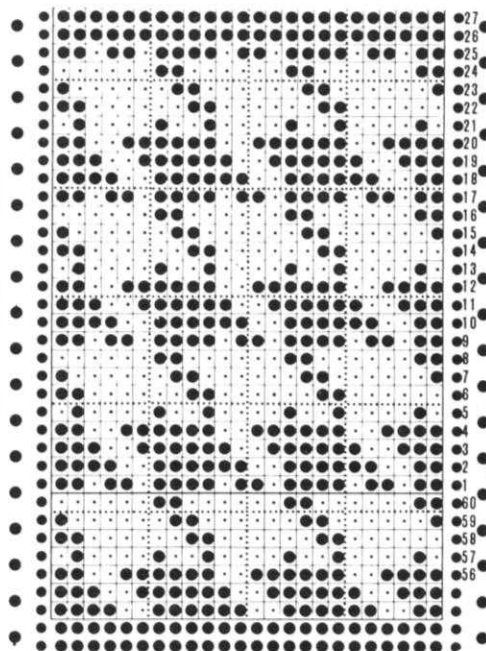

SLEEVES: Make 1, reverse 1.

Cast on 14 sts. and work in Pattern.
 ON THE RIGHT, increase 1 st. every 8th row 3x BUT AT THE SAME TIME, after Row 10, with waste yarn, cast on 20 sts. to the left of the 14 sts. Counter at 0 and with garment yarn, knit 44 rows. Remove onto contrast waste yarn and set aside.

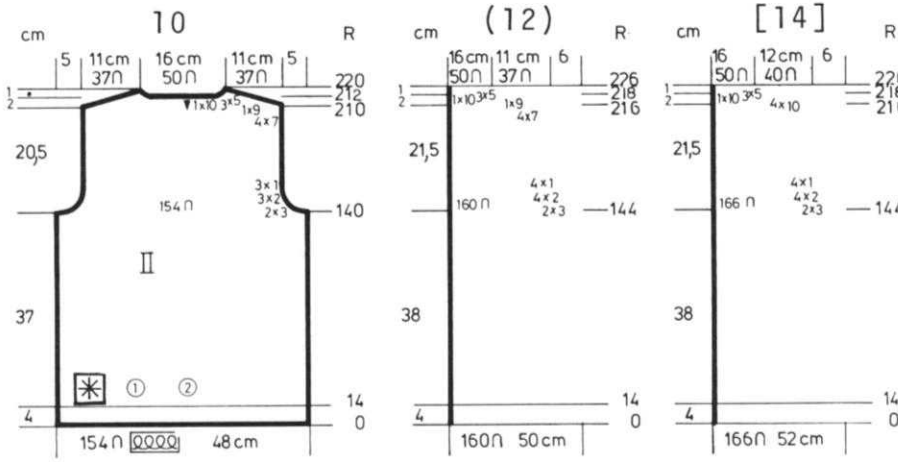

JACKET BACK: II

Cast on 154 (160) [166] sts. with color 1 and work in Pattern. Knit to Row 140 (144) [144].

SHAPE ARMHOLE: ON EACH SIDE, bind off 3 sts. 2x, 2 sts. 3x, 1 st. 3x. (3 sts. 2x, 2 sts. 4x, 1 st. 4x). [3 sts. 2x, 2 sts. 4x, 1 st. 4x]. After Row 210 (216) [216], SHAPE SHOULDER and watch for NECK SHAPING.

FOR SHOULDER, bind off 7 sts. 4x, 9 sts. 1x, (same as first size) [10 sts. 4x], AT THE SAME TIME, after Row 212 (218) [218], put half the sts. on the left into holding position and complete the right side first.

*ON NECK SIDE, bind off 10 sts. 1x, 5 sts. 3x for all sizes. Bring the needles on the left into working position, knit 1 row in Pattern to the left side, turn the Row Counter back to 212 (218) [218] and complete the left half. Follow the instructions from * and don't forget to complete the shoulder shaping.

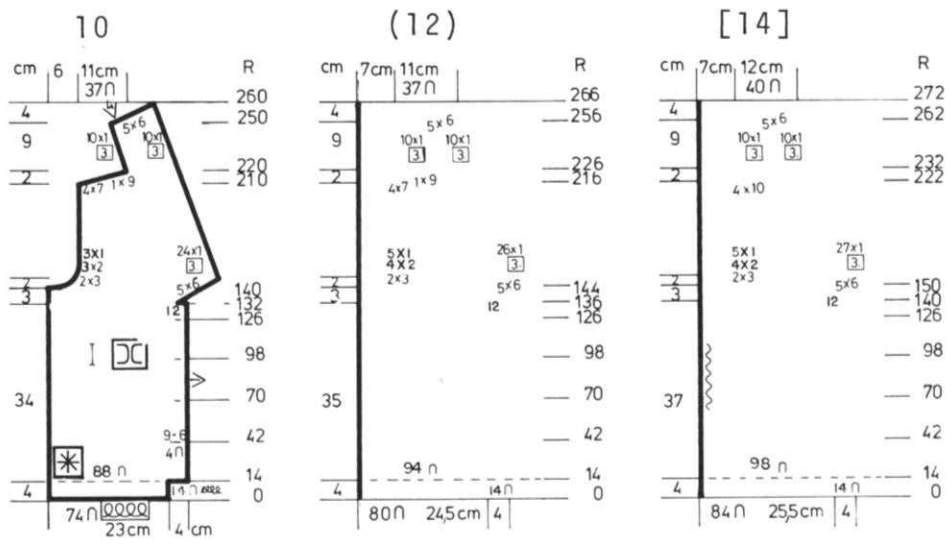

FOR ARMHOLE, bind off 3 sts. 2x, 2 sts. 3x, 1 st. 3x; (3 sts. 2x, 2 sts. 4x, 1 st. 5x); [3 sts. 2x, 2 sts. 4x, 1 st. 5x];

FOR FRONT COLLAR, decrease 1 st. every 3rd row 24x (26x) [27x] and AT THE SAME TIME, after Row 209 (215) [221], for SHOULDER, bind off 7 sts. 4x, 9 sts. 1x. (7 sts. 4x, 9 sts. 1x). [10 sts. 4x].

After Row 220 (226) [232], on every 3rd row, decrease 1 st. on the right and INCREASE 1 st. on the LEFT 10x.

After Row 249 (255) [261], bind off 6 sts. 5x.

Work the RIGHT FRONT with reverse shaping, making BUTTONHOLES over needles 6 to 9 counting from the LEFT edge after Rows 42, 70, 98, 126.

JACKET FRONT: Make 1, reverse 1



DO NOT MAKE BUTTONHOLES IN THIS SECTION.

Cast on 74 (80) [84] sts. with color 1 and work in Pattern.

After Row 14, cast on 14 sts. on the Right.

After Row 132 (136) [140], remove 12 sts. on the right onto waste yarn or a stitch holder then cast on 6 sts. 5x AND AT THE SAME TIME, on the left SHAPE ARMHOLE after Row 139 (143) [149] and SHAPE FRONT COLLAR.

To the LEFT OF 0, cast on 60 sts. ON THE LEFT, increase 1 st. every 8th row 3x, BUT AT THE SAME TIME, after Row 10, to the right of these sts. cast on 20 sts. with waste yarn. Counter at 0. With garment yarn knit 44 rows. Remove 20 sts. on the right onto waste yarn. Take the separate piece held on waste yarn, fold back 10 sts. on the left of the piece then hang these doubled sts. onto machine to the right of the knitting. Hang the remaining sts. of this piece onto machine. Continue with Pattern over all the needles. COUNTER AT 44. ON EACH SIDE, increase 1 st. every 8th row 15x. After Row 152, SHAPE CAP: ON EACH SIDE, bind off 4 sts. 1x, 2 sts. 2x, 3 sts. 2x, 1 st. 1x, 2 sts. 19x. After Row 202, bind off the remaining sts. Weave the open sts. of sleeve and remove waste yarn. Fold 10 rows of sleeve edge under and hem in place. Sew 2 buttons on top (see Picture). Work the second sleeve with reverse shapings - reading right for left, etc.

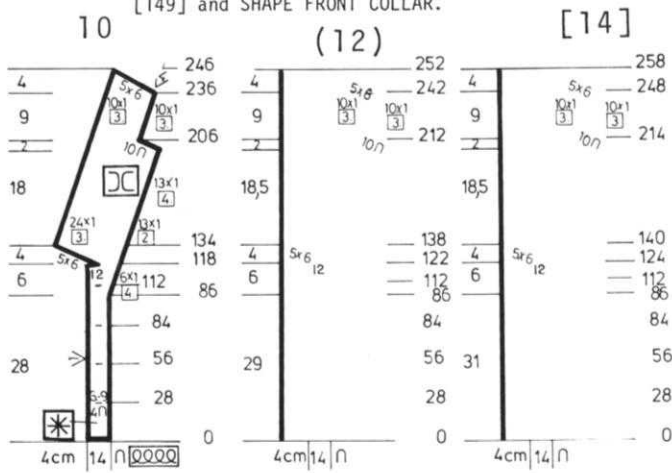

RIGHT FRONT FACING: Reverse for LEFT

Cast on 14 sts. with color 1 and work in Pattern. MAKE BUTTONHOLES over needles 6 to 9 counting from the LEFT after Rows 28, 56, 84, 112, BUT AT THE SAME TIME, after Row 86, begin the increases on the RIGHT. Increase 1 st. every 4th row 6x, every 2nd row 13x, every 4th row 13x BUT AT THE SAME TIME, after Row 118 (122) [124], remove 12 sts. on the LEFT onto a stitch holder then cast on 6 sts. 5x. After Row 134 (138) [140], ON THE LEFT, decrease 1 st. every 3rd row 24x and after Row 206 (212) [214], remove 10 sts. on the right onto a stitch holder then increase 1 st. on the RIGHT and DECREASE 1 st. on the left every 3rd row 10x. After Row 236 (242) [248], bind off 6 sts. 5x. Work the LEFT FRONT FACING with reverse shapings and OMIT THE BUTTONHOLES.



dk 643

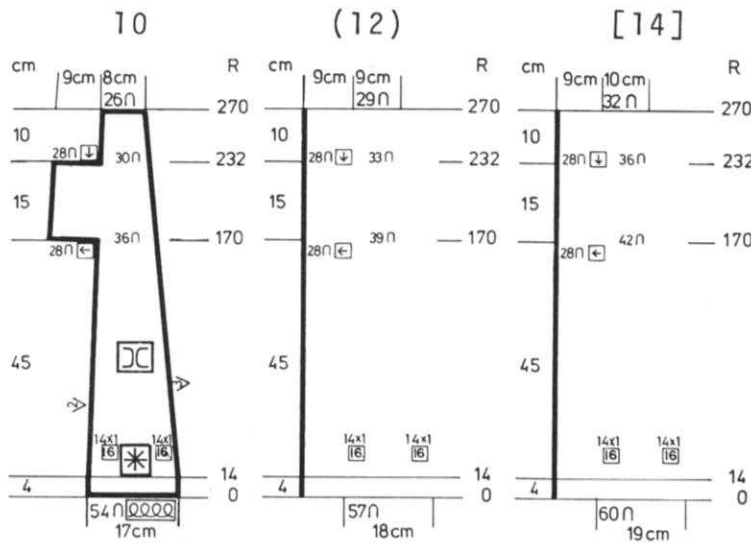

SKIRT SIDE PANELS: Make 1, reverse 1.
 Cast on 54 (57) [60] sts. with color 1 and work in Pattern.
 After Row 28, ON EACH SIDE, decrease 1 st. every 16th row 14x for all sizes.
 After Row 170, ON THE LEFT (right for 2nd section) cast on 28 sts.
 After Row 232, bind off these same 28 sts.
 After Row 270, bind off the remaining sts.

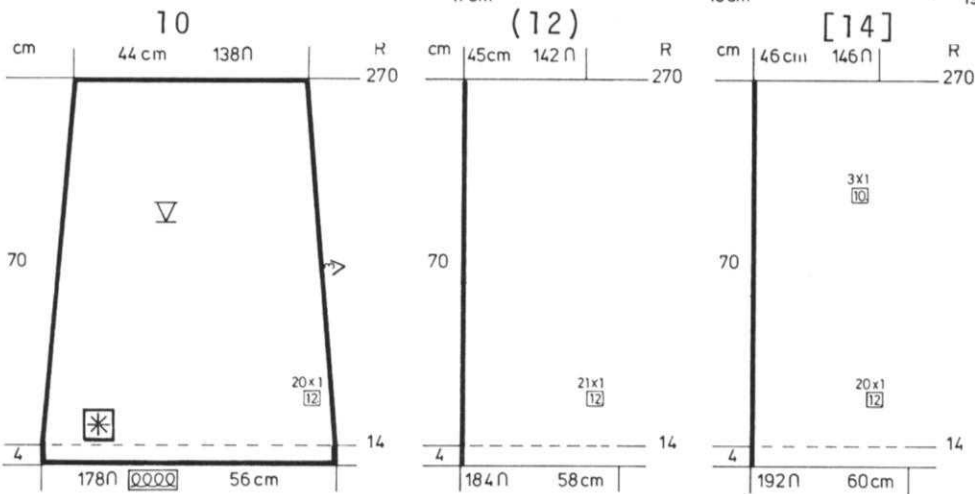

SKIRT BACK: V
 Cast on 178 (184) [192] sts. with color 1 and work in Pattern.
 ON EACH SIDE, after Row 28, decrease 1 st. every 12th row 20x (21x) [20x, then 1 st. every 10th row 3x].
 After Row 270, bind off.
 SKIRT FRONT: IV
 Cast on 160 (164) [168] sts. with color 1 and work in Pattern.
 After Row 28, ON EACH SIDE, decrease 1 st. every 16th row 13x for all sizes.
 After Row 170, ON EACH SIDE, cast on 10 sts.
 After Row 232, ON EACH SIDE, bind off 10 sts.
 After Row 270, bind off the remaining sts.

kk 644



GIRL'S JUMPER
 SIZES: 6 year (7 year) [8 year]
 YARN: Vienna
 GRAMS: 400 450 500
 TENSION: 6 to 8
 GAUGE: 14 sts. 21 rows = 5 cm (2")

Stockinette stitch with a diagonal knit Ruffle along the outside of straps.

FINISHING: Make pocket lining from tafetta and sew in place after seaming the side edges of skirt section. Overlap straps and insert into waistband and sew in place.

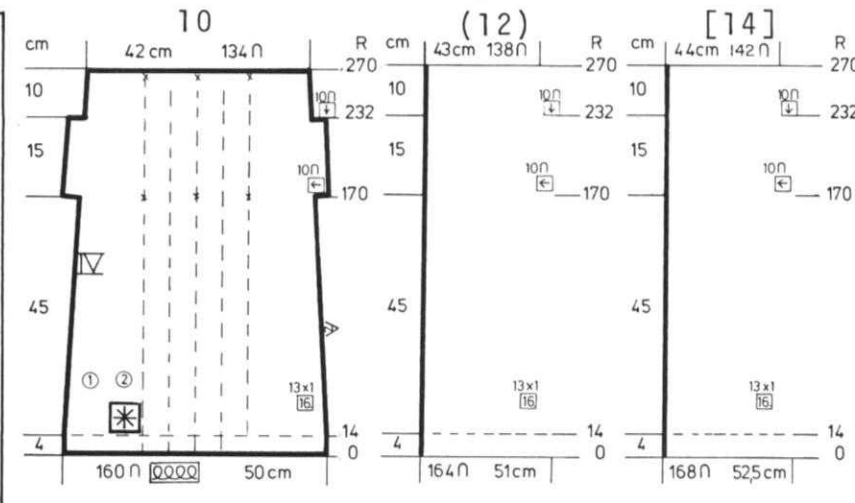

SKIRT SECTION: Make 2.
 Cast on 174 (180) [186] sts. and work Stockinette stitch. Knit to Row 96 (104) [112].
 ON EACH SIDE, cast on 6 sts. Knit to Row 142 (150) [158].
 ON EACH SIDE, bind off 6 sts. Knit to Row 190 (198) [206].
 Bind off.

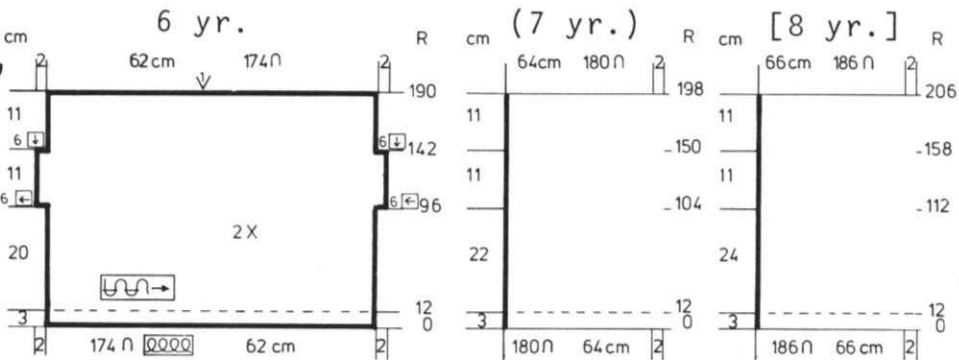

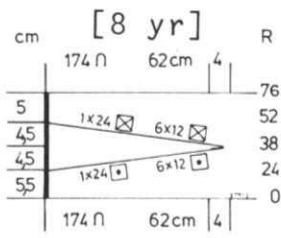
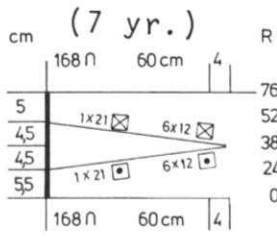
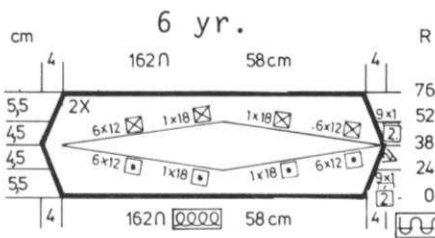

STRAPS: Make 2.

Cast on 162 (168) [174] sts. and work Stockinette stitch.
 ON EACH SIDE, increase 1 st. every 2nd row 9x for all sizes BUT AT THE SAME TIME, after Row 24, WORK SHORT ROWS: ON OPPOSITE SIDE OF CAM BOX, put into holding position 12 sts. 6x, 18 sts. 1x. (12 sts. 6x, 21 sts. 1x). [12 sts. 6x, 24 sts. 1x]. After Row 38, ON EACH SIDE, WORK SHORT ROWS, ON OPPOSITE SIDE OF CAM BOX, bring back into working position, 18 sts. 1x, 12 sts. 6x. (21 sts. 1x, 12 sts. 6x). [24 sts. 1x, 12 sts. 6x].
 ON EACH SIDE, decrease 1 st. every 2nd row 9x
 After Row 76, bind off.

R WAISTBAND: Make 2.

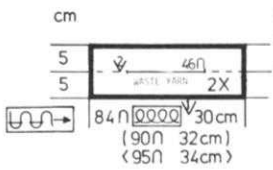

Cast on 84 (90) [95] sts. and work Stockinette stitch.
 After Row 21, remove the center 46 sts. onto waste yarn then immediately cast on over the same needles using waste yarn.
 Continue knitting over all the needles to Row 42, then bind off.

DIAGONAL RUFFLE Make 2.

Cast on 20 sts. and work Stockinette stitch.
 ON EVERY 2nd row, increase 1 st. on the RIGHT (left for 2nd ruffle) and decrease 1 st. on the LEFT (right for 2nd ruffle) until piece is 60" long. Bind off.
 After folding strap in half, gather ruffle to fit outside edge of strap then sew in place.

DK 645

WOMAN'S 3-PIECE SUIT

SIZES: 8/10 (12) [14]
 YARN: Venetia
 GRAMS: color 1 1 Cone, color 2 1 Cone
 TENSION: 6 to 8
 GAUGE: Stock: 14 sts. 18 rows = 5 cm (2")
 Pat: 16 sts. 16 rows = 5 cm (2")



A Norwegian Design for Skirt and trim.
 Bands are K1, P1 Ribbing.

FINISHING: See General Instructions.
 Sew pockets in place.

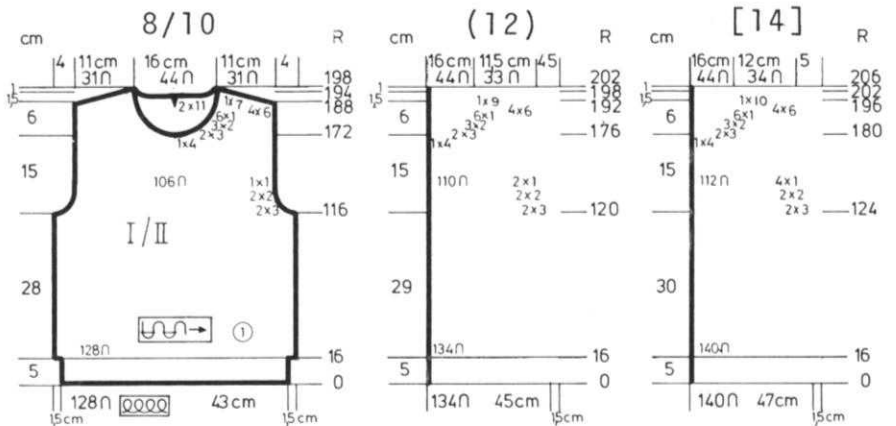

PULLOVER FRONT: I

Work the front the same as the back to Row 116 (120) [124].
 SHAPE ARMHOLE same as the back then knit to Row 172 (176) [180].
 Put half the sts. on the left into holding position and complete the right side first.
 *ON NECK SIDE, bind off 4 sts. 1x, 3 sts. 2x, 2 sts. 3x, 1 st. 6x for all sizes.
 After Row 188 (192) [196], SHAPE SHOULDER same as the back.
 Bring the needles on the left into working position, knit 1 row to the left side, turn the Row Counter back to 172 (176) [180] and complete the left half. Follow the instructions from *.

PULLOVER BACK: II

Cast on 128 (134) [140] sts. with color 1 and work 16 rows K1, P1 Ribbing.
 Continue in Stockinette stitch.
 Knit to Row 116 (120) [124].
 SHAPE ARMHOLE: ON EACH SIDE, bind off 3 sts. 2x, 2 sts. 2x, 1 st. 1x. (3 sts. 2x, 2 sts. 2x, 1 st. 2x). [3 sts. 2x, 2 sts. 2x, 1 st. 4x].
 Knit to Row 188 (192) [196].
 SHAPE SHOULDER and watch for NECK SHAPING.
 FOR SHOULDER, bind off 6 sts. 4x, 7 sts. 1x, (6 sts. 4x, 9 sts. 1x), [6 sts. 4x, 10 sts. 1x],
 FOR NECK, after Row 194 (198) [202], put half the sts. on the left into holding position and complete the right side first.
 *ON NECK SIDE, bind off 11 sts. 2x for all sizes.
 Bring the needles on the left into working position, knit 1 row to the left side, turn the Row Counter back to 194 (198) [202] and complete the left half.
 Follow the instructions from * and complete the shoulder shaping.

PULLOVER COLLAR:

Cast on 180 sts. and work K1, P1 Ribbing for 8".
 Bind off the crochet method for Ribbing.

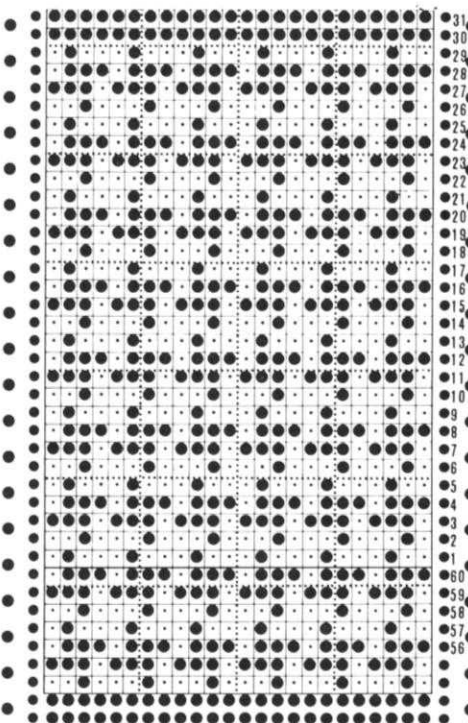

dk 645

JACKET SLEEVES: III

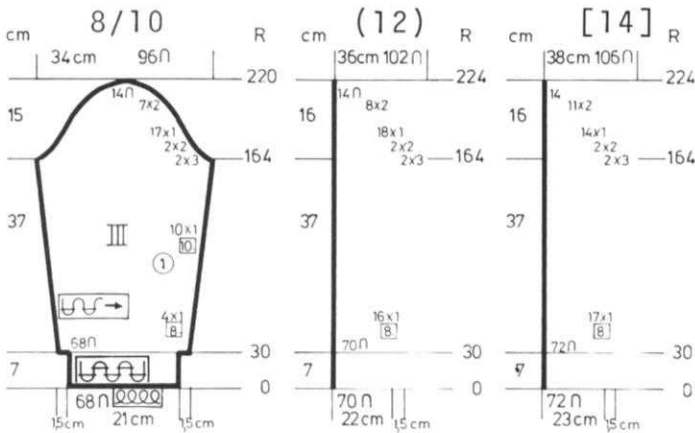

Cast on 68 (70) [72] sts. with color 1 and work 30 rows K1, P1 Ribbing. Continue in Stockinette stitch.
ON EACH SIDE, increase 1 st. every 8th row 4x, every 10th row 10x. (every 8th row 16x).
 [every 8th row 17x].
 After Row 164, **SHAPE CAP:**
ON EACH SIDE, bind off
 2 sts. 2x, 2 sts. 2x, 1 st. 17x, 2 sts. 7x.
 (3 sts. 2x, 2 sts. 2x, 1 st. 18x, 2 sts. 8x).
 [3 sts. 2x, 2 sts. 2x, 1 st. 14x, 2 sts. 11x].
 After Row 220 (224) [224], bind off the remaining sts.

JACKET I

FRONT: Make 1, reverse 1 and be sure to have the pockets knitted and ready to use.

Cast on 66 (70) [70] sts. with color 1 and work 30 rows K1, P1 Ribbing. Continue in Stockinette stitch.

After Row 68, put 19 sts. counting from the front edge into holding position. Remove the next 32 sts. onto waste yarn, then hang the pocket sts. onto these 32 empty needles, then return the 32 sts. on top of the pocket sts. Remove waste yarn. Continue knitting over all the needles.

After Row 130 (134) [138], **SHAPE FRONT:** Decrease 1 st. at front edge every 5th row 17x **BUT AT THE SAME TIME.** after Row 143 (147) [151], **SHAPE ARMHOLE:** Bind off 3 sts. 2x, 2 sts. 2x, 1 st. 4x. (3 sts. 2x, 2 sts. 2x, 1 st. 4x). [3 sts. 2x, 2 sts. 2x, 1 st. 4x].

After Row 208 (212) [216], **WORK SHORT ROWS:** ON OPPOSITE SIDE OF CAM BOX, put into holding position 7 sts. 5x (6 sts. 6x) [6 sts. 6x].

Bring all the needles into working position and work in **PATTERN**, increasing 1 st. at front edge every 2nd row 3x.
 After Row 240 (246) [250], bind off.

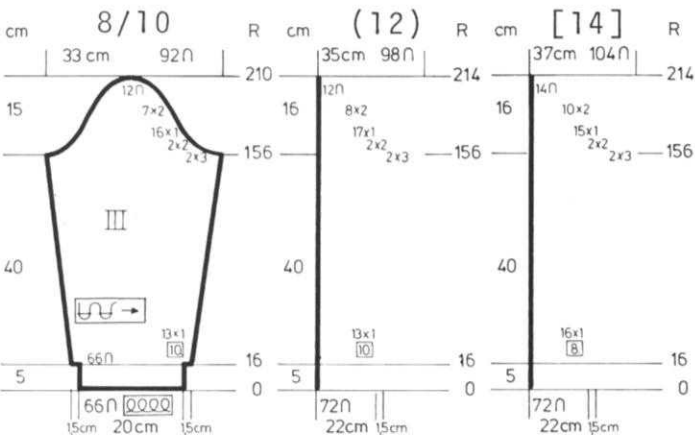
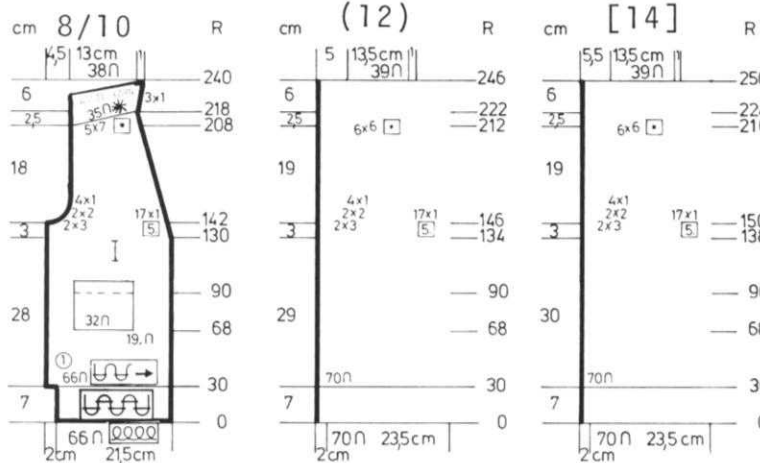

PULLOVER SLEEVES: III
 Cast on 66 (72) [72] sts. with color 1 and work 16 rows K1, P1 Ribbing. Continue in Stockinette stitch.
ON EACH SIDE, increase 1 st. every 10th row 13x. (every 10th row 13x).
 [every 8th row 16x].
 After Row 156 (156) [156], **SHAPE CAP:**
ON EACH SIDE, bind off
 3 sts. 2x, 2 sts. 2x, 1 st. 16x, 2 sts. 7x.
 (3 sts. 2x, 2 sts. 2x, 1 st. 17x, 2 sts. 8x).
 [3 sts. 2x, 2 sts. 2x, 1 st. 15x, 2 sts. 10x].
 After Row 210 (214) [214], bind off the remaining sts.

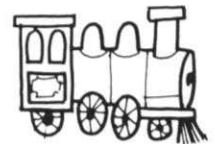

JACKET BACK: II

Cast on 134 (140) [146] sts. with color 1 and work 30 rows K1, P1 Ribbing. Continue in Stockinette stitch.

Knit to Row 142 (146) [150]. **SHAPE ARMHOLE:** ON EACH SIDE, bind off 3 sts. 2x, 2 sts. 2x, 1 st. 2x.

(3 sts. 2x, 2 sts. 2x, 1 st. 4x). [3 sts. 2x, 2 sts. 3x, 1 st. 3x].
 After Row 206 (214) [218], **SHAPE SHOULDER** and watch for **NECK SHAPING.**
FOR SHOULDER, bind off
 7 sts. 5x,
 (6 sts. 6x),
 [6 sts. 6x].

AT THE SAME TIME after Row 212 (220) [224], put half the sts. on the left into holding position and complete the right side first.

***ON NECK SIDE, bind off 10 sts. 2x (10 sts. 2x) [11sts. 2x].**
 Bring the needles on the left into working position, knit 1 row to the left side, turn the Row Counter back to 212 (220) [224] and complete the left half. Follow the instructions from * and don't forget to complete the shoulder shaping.

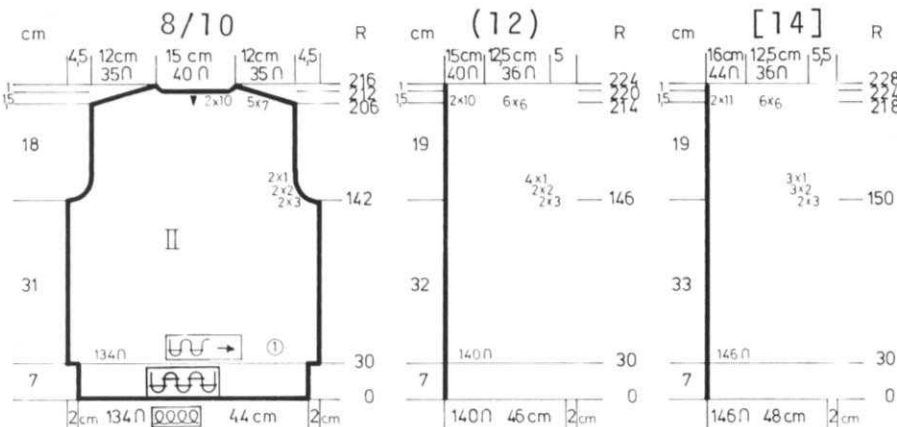

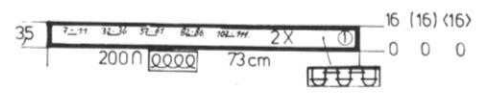
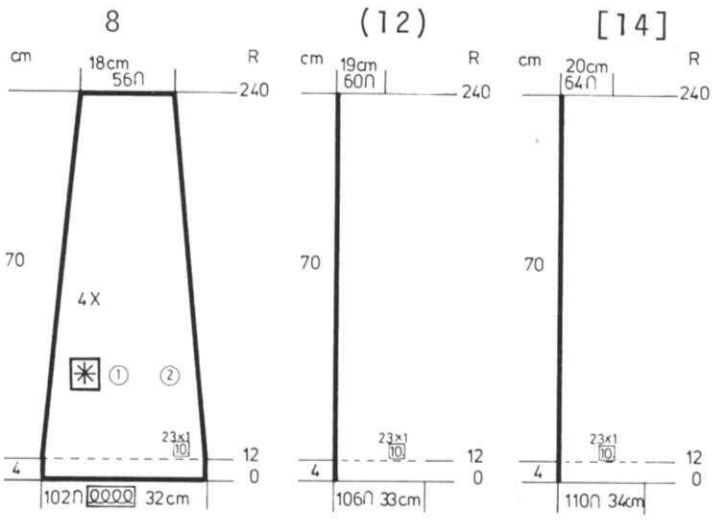

JACKET FRONT BANDS: Make 2, omitting buttonholes in one section.

Cast on 200 sts. with color 1 and work K1, P1 Ribbing. After 8, MAKE BUTTONHOLES over needles 7 to 11, 32 to 36, 57 to 61, 82 to 86, 107 to 111. After Row 16, bind off the crochet method for Ribbing.

SKIRT: Make 4 sections.

Cast on 102 (106) [110] sts. with color 1 and work in Pattern. After Row 12, ON EACH SIDE, decrease 1 st. every 10th row 23x. After Row 240, bind off.

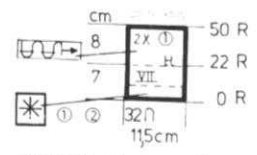

POCKETS: Be sure to make the 2 pockets before knitting the fronts.

Cast on 32 sts. with color 1 and work in Pattern to Row 22. Form the hem then continue in Stockinette stitch with color 1 to row 50. Remove the sts. onto contrast waste yarn.

dk 646

WOMAN'S SCARF, HAT & MITTENS

- SIZE: Adult
 YARN: Vienna
 GRAMS:
 color 1 200
 color 2 50
 color 3 50
 color 4 50
 color 5 50
 TENSION: 6 to 8
 GAUGE: 16 sts. 16 rows = 5 cm (2")

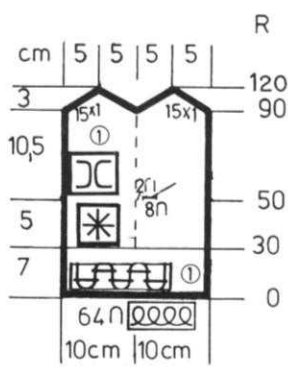

MITTENS: Make 2, but reverse sides for thumb opening.

Cast on 64 sts. with color 1 and work 30 rows K1, P1 Ribbing. Continue in the Norwegian Design. After Row 50, counting from the RIGHT (left for 2nd mitten) knit needles 23 to 30 by hand with contrast waste yarn and continue in Pattern (thumb opening). Knit to Row 90. Divide in the center and work the right side first, continue in Stockinette stitch with color 1. Put the needles on the left into holding position. ON EACH SIDE, decrease 1 st. every 2nd row 15x. Remove the remaining sts. on end of yarn. REPEAT for other half.

THUMB:

Cast on 15 sts. and work 10 rows Stockinette stitch with color 1. ON EACH SIDE, decrease 1 st. every 2nd row 4x. Remove on end of yarn.

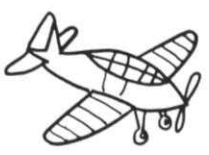

HAT:

Cast on 160 sts. with color 1 and work 16 rows K1, P1 Ribbing. Continue in the Norwegian Designs. Knit to Row 76. Remove the sts. onto Reversing Bar (or you can remove them onto waste yarn) and REVERSE the knitting. Continue in Stockinette stitch with color 1. After Row 86, Decrease 15 sts. evenly across. Decrease 15 sts. evenly across after the following rows - 92, 98, 100, 102, 104, 106, 108. Knit even to Row 164, then remove the sts. onto the end of yarn and pull up and secure.

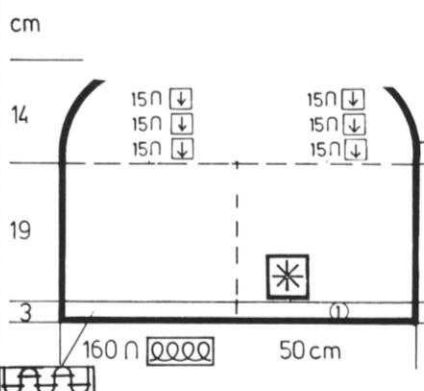

- 5R (3) (2)
- 2R (3)
- 2R (5)
- 5R (1) (5)
- 2R (6)
- 2R (4)
- 3R (4) (3)
- 2R (4)
- 2R (1) (4)
- 2R (1)
- 2R (2) (3)
- 2R (3)
- 2R (3)
- 5R (3) (4)
- 2R (3)
- 2R (1)
- 5R (1) (4)
- 2R (1)
- 4R (1) (5)
- 2R (5)

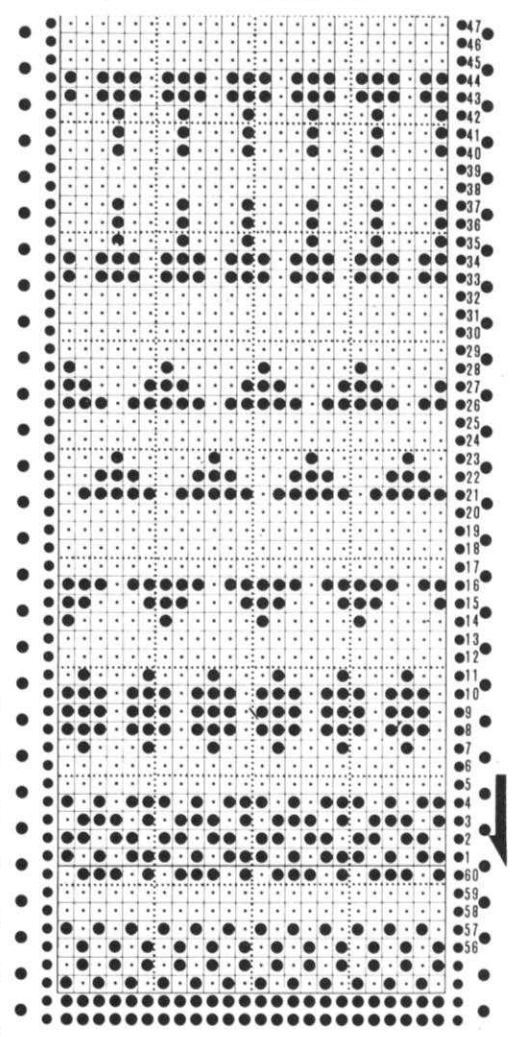

dk 646

638

LAMPSHADE COVER & PILLOW COVER

SIZES:

Lampshade Cover = 61.5 x 30.5 cm.
(24" x 12" deep)
PILLOW COVER = 41 x 41 cm
(16" x 16")

YARN: Amore & Matching sewing thread.

GRAMS:

C1 - Amore = 100 for each article
C2 - Thread = 1 Spool

TENSION: 8

GAUGE: 15 sts. 15 rows = 5 cm (2")

Norwegian Technique with the spool of thread as 2nd color. Punch Card.

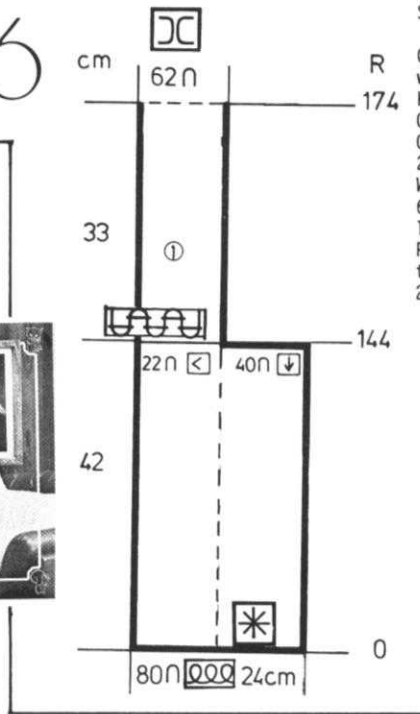

SCARF:

Cast on 80 sts. with color 1 and work the Norwegian Design.
Knit to Row 144.
ON THE RIGHT, bind off 40 sts.
Over the remaining sts., increase 22 sts. evenly across.
Work K1, P1 Ribbing over the 62 sts. to Row 174.
This is the center of Scarf.
Reverse the instructions and the Norwegian Design for the 2nd half of scarf.

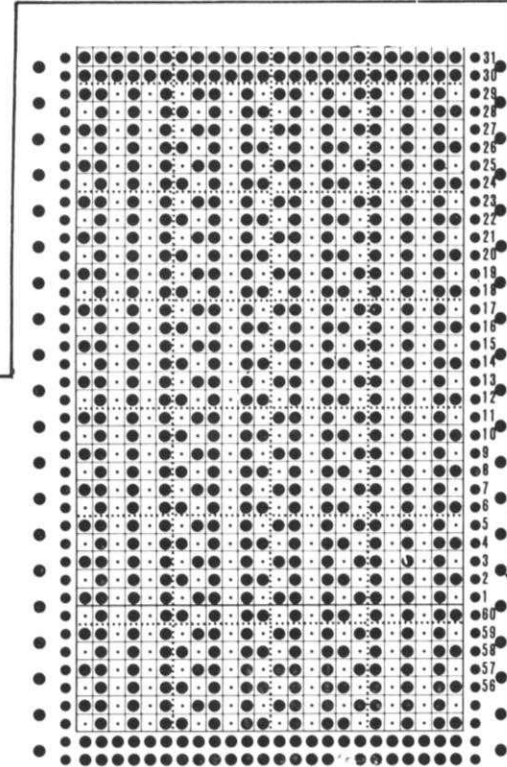

FINISHING:

LAMPSHADE: - Wet Block and allow to dry thoroughly. Sew up seam, work single crochet through open sts. doubling the stitches (top of shade). Pull cover over shade. Wind yarn around a 6" cardboard and cut only 1 edge. Use 2 strands and knot into every stitch for fringe.

Use 6 strands of yarn and make twisted cord. Tie around top of shade.

PILLOW COVER: - Wet block same as for Lampshade cover. Fold in half and sew edges together leaving an opening for pillow. Pull cover over pillow and sew up opening.

LAMPSHADE COVER:

Cast on 184 sts with color 1 and work 8 rows Stockinette stitch then continue in Pattern. Set Counter at 0 and knit 76 rows. Knit 8 rows stockinette stitch with color 1. Remove the sts. onto contrast waste yarn.

PILLOW COVER:

Cast on 122 sts. with color 1 Knit 2 rows Stockinette stitch then continue in Pattern to Row 242. Knit 2 rows Stockinette stitch with color 1. Bind off.

Adaptor Arm for 820 COLOR CHANGER

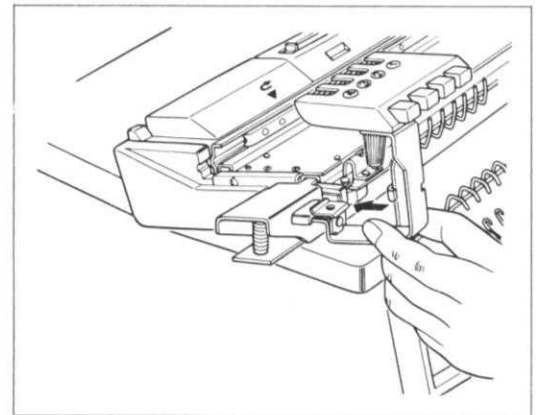
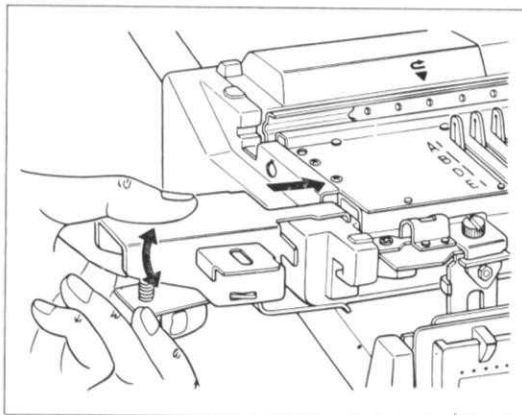

Here's a new Accessory for people who have an 820 or 830 machine with a Ribbing Attachment...

This Adaptor allows you to use the 820 Color Changer (on main machine) without removing the Ribber Attachment. You just drop the Ribber down, slide the Adaptor into position on the main machine and clip on your Push Button Changer...

KK 647

CHILD'S SLIPPER SOX

SIZES: 4/5 (6) [7]
 YARN: Euro Sport
 GRAMS: color 1 150 150 150
 color 2, 3, 4, small amounts
 of left over yarn - not included
 in kit.
 TENSION: 10
 GAUGE: 14 sts. 15 rows = 5 cm (2")



The cuff of the Slipper Sox is K1, P1 Ribbing and it is suggested that you LATCH up every other stitch for the Ribbing for a hand knit look. Wax the yarn. The legs are a Norwegian Design as is the instep and top of foot. Punch your own Card and follow the color changes as given.

FINISHING: Block lightly on the wrong side. Sew up back seam. Weave heel sts. together and instep to sole. To make slippers more serviceable, sew onto purchased leather soles.

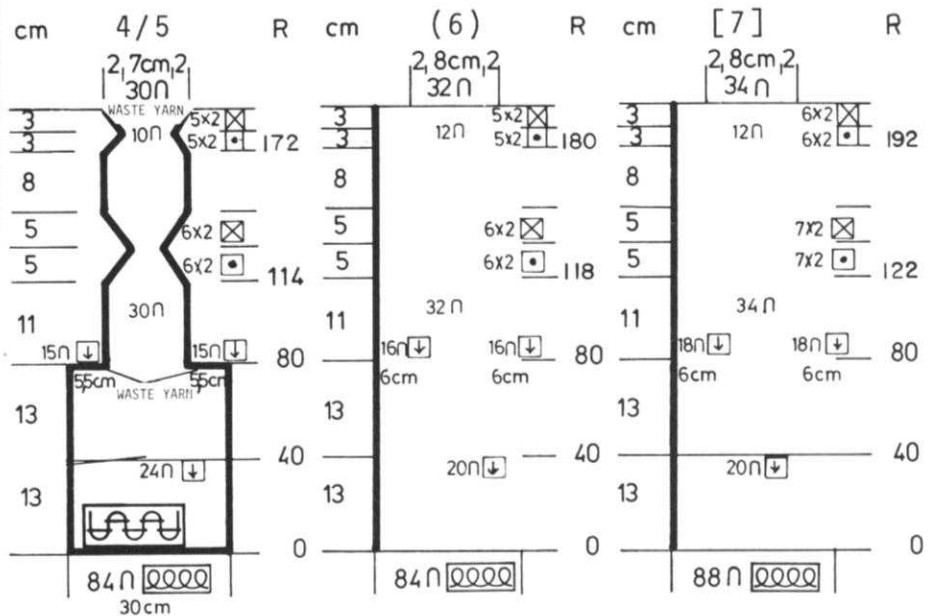

Cast on 84 (84) [88] sts. with color 1 and work 40 rows Stockinette stitch. LATCH EVERY OTHER STITCH into a Rib stitch then remove the stitches onto contrast waste yarn.
 Hang the sts. back onto the machine decreasing 24 (20) [20] sts. evenly across.
 Insert Punch Card UPSIDE DOWN and continue in the Norwegian Design following the color changes as given.
 After Row 80, ON EACH SIDE, remove 15 (16) [18] sts. onto waste yarn. Continue in the Norwegian Design to Row 114 (118) [122].

Continue in Stockinette stitch with color 1.
 Work SHORT ROWS: ON OPPOSITE SIDE OF CAM BOX, put into holding position 2 sts. 6x (6x) [7x] ON EACH SIDE.
 ON OPPOSITE SIDE OF CAM BOX, bring back into working position 2 sts. 6x (6x) [7x].
 Knit to Row 172 (180) [192].
 WORK SHORT ROWS same as you did before - 2 sts. 5x (5x) [6x] ON EACH SIDE, then bring them back into working position in the same way.
 After Row 192 (210) [212], remove the sts. onto contrast waste yarn.
 Make 2nd sock the same.

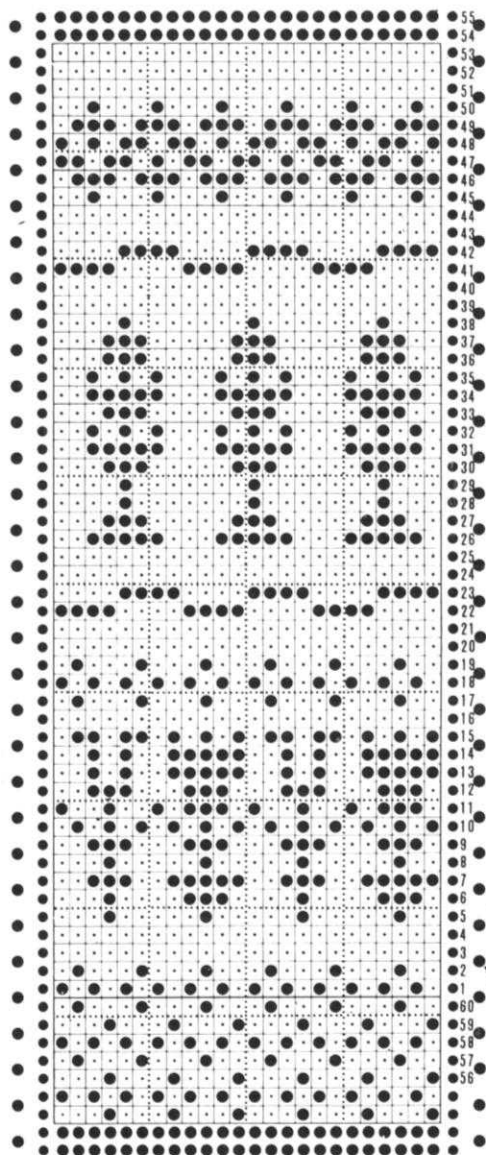

BEGIN HERE
 9 rows 1 & 2
 2 rows color 3
 2 rows color 4
 2 rows color 1
 11 rows color 1 & 2
 2 rows color 1
 2 rows color 4
 2 rows color 3
 2 rows color 3
 3 rows color 4 & 3
 2 rows color 1
 13 rows color 2 & 3
 2 rows color 1
 2 rows color 2 & 3
 2 rows color 1
 6 rows color 1 & 4

KK 648

CHILD'S MITTENS, CAP & SCARF

SIZES: Pre-teen - Small, Medium & Large.
 YARN: Vienna - Same amount for all sizes.
 GRAMS: - color 1 200
 color 2 150
 color 3 50
 color 4 50
 TENSION: -6 to 8
 GAUGE: 24 sts. 20 rows = 5 cm (2")
 Measure gauge without stretching.

Knit 1, Pur1 Ribbing is used throughout. Turn Tension down for cuff of Mitten.

FINISHING: Sew seam of thumb then weave the open sts to mitten opening with the seam facing the inside of hand. It is easier if you press the open sts. lightly and remove the waste yarn 1 stitch at a time as you weave the open stitches. Sew Mitten seam.



SCARF:

Cast on 78 sts. with color 1 and work K1, P1 Ribbing with color stripes of
 40 rows Red, 20 rows Blue, 20 rows Yellow, 20 rows Green, 320 rows Red, 20 rows Green, 20 rows Yellow, 20 rows Blue, 40 rows Red.
 Bind off.
 Mix the colors and put fringe at each end.

KK 648

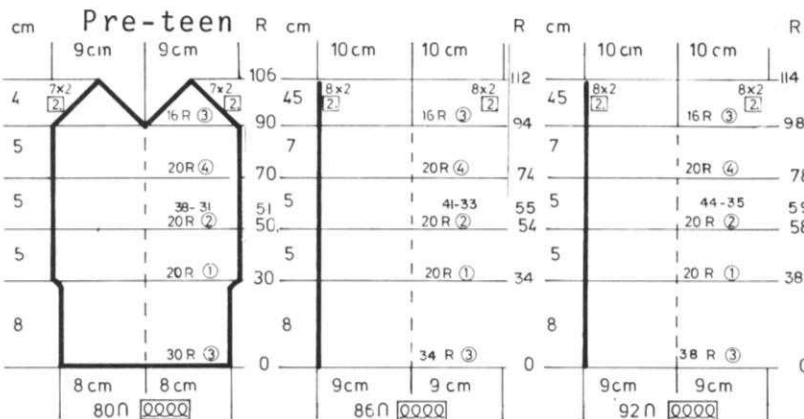

CAP:

Cast on 180 sts. with color 2 and work K1, P1 Ribbing with color stripes of
 40 rows Yellow 20 rows Green, 20 rows Red, 20 rows Blue, 20 rows Yellow.
 After Row 100, hang all the purl sts. onto the knit sts. (90 sts.).
 Remove the sts. onto waste yarn then hang them back onto the knitter onto 90 needles. Be careful to make sure you pick up the doubled sts. together. Continue in Stockinette stitch.
 Knit 2 rows.
 Hang stitch 2 on needle 1 then hang every 13th st. onto 14th needle, every 16th st. onto 15th needle across then hang the 89th st. onto 90th needle. Move the sts. in to fill the empty needles.
 Knit 2 rows.
 REPEAT these decreases DIRECTLY ABOVE 6x more, each time moving the sts. in to fill the empty needles and knit 2 rows.
 Remove the remaining sts. onto end of yarn and pull up and secure.

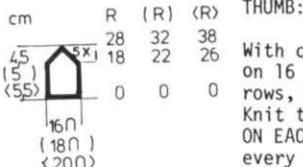

THUMB:

With contrast waste yarn, cast on 16 (18) [20] sts. Knit several rows, then change to color 2. Knit to Row 18 (22) [26]. ON EACH SIDE, decrease 1 st. every 2nd row 5x.
 After Row 28 (32) [38], remove the remaining sts. onto end of yarn and pull up tightly and secure.

MITTENS: Make 2 - one with opening on the right, one on the left.

With color 3, cast on 80 (86) [92] sts. and work K1, P1 Ribbing. LOWER the tension to Row 30 (34) [38] Continue with garment tension and work the color changes as shown on the Chart.

After Row 51 (55) [58], work the opening for thumb. With waste yarn, knit 2 rows by hand over needles 31 to 38 (33 to 41) [35 to 44] counting from the right (left for 2nd mitten) edge. Continue in pattern over all the needles.

Knit to Row 90 (94) [98]. Put half the sts. on the left into holding position (or you can remove them onto waste yarn).

*ON EACH SIDE, bind off 2 sts. every 2nd row 7x (8x) [8x]. Remove the remaining sts. onto end of yarn and pull up and secure.

Bring the remaining needles into working position, turn the Row Counter back to 90 (94) [98]. Follow the instructions from *.

For the 2nd mitten, be sure to make the thumb opening on the left side.

BACK:

Cast on 148 (154) [160] sts. with color 1 and work Stockinette stitch. Knit to Row 36. Continue in Pattern. ON EACH SIDE, decrease 1 st. every 6th row 20x and AT THE SAME TIME, when Pattern is completed at Row 72, Work SHORT ROWS: ON OPPOSITE SIDE OF CAM BOX, put into holding position, 27 (30) [33] sts. before knitting the next 2 rows.

ON OPPOSITE SIDE OF CAM BOX, bring back into working position 9 (10) [11] sts. 3x ON EACH SIDE. After Row 158 (174) [190], transfer every other stitch to the Ribber.

After Row 166 (182) [198], make eyelets across by transferring every 4th st. to the adjacent needle and leave empty needles in work. After Row 176 (192) [208], Continue in Stockinette stitch. ON EACH SIDE, decrease 1 st. every 6th row 5x (4x) [4x].

After Row 220 (240) [260], SHAPE ARMHOLE: ON EACH SIDE, bind off

3 sts. 1x, 2 sts. 2x, 1 st. 6x. (3 sts. 1x, 2 sts. 1x, 1 st. 6x). [3 sts. 1x, 2 sts. 2x, 1 st. 6x]. After Row 268 (290) [312], SHAPE SHOULDER and watch for NECK SHAPING. FOR SHOULDER bind off

3 sts. 7x, (4 sts. 2x, 3 sts. 5x), [4 sts. 6x], and AFTER ROW 276 (298) [320], put half the sts. on the left into holding position and complete the right side first.

*FOR NECK, bind off 7 sts. 1x, 8 sts. 1x for all sizes. Bring the needles on the left into working position, knit 1 row to the left side, turn the Row Counter back to 276 (298) [320] and complete the left half. Follow the instructions from * and don't forget to complete the shoulder shaping.

KK 649

GIRL'S DRESS

SIZES: 2 (4) [6]
 YARN: Amore
 GRAMS:
 color 1 250 300 300
 color 2 100 100 100
 color 3 50 50 50
 TENSION: 4 for Ribbing
 5 to 7 for Stock. & Pat.
 GAUGE: 16 sts. 22 rows = 5 cm (2")

Stockinette stitch with a Norwegian Design on skirt section. Bands are K1, P1 Ribbing.

FINISHING: See General Instructions. Sew on all ribbed bands. Fake pocket on bodice - just sew band onto right side (see picture). Embroider the balloons. Make cord and pull through eyelets at waistline.

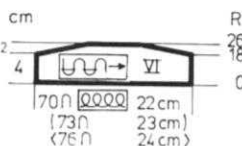

COLLAR: VI

Cast on 70 (73) [76] sts. with color 1 and work Stockinette stitch. After Row 18, ON EACH SIDE, bind off 4 sts. 4x. After Row 26, bind off the remaining sts.

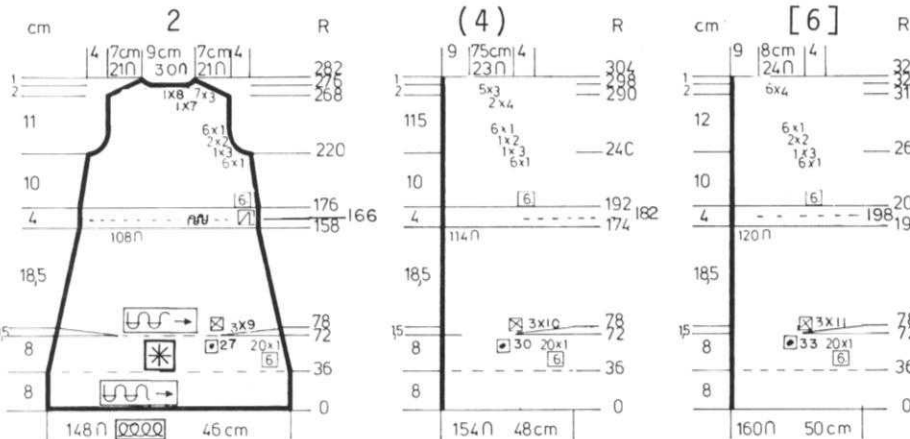

cm	2	R	cm	(4)	R	cm	[6]	R
7cm	21n		7, 7,5cm	24, 23n		7, 8cm	24, 24n	
3		282	3		304	3		326
2,5		258	4,5		290	4,5		312
8,5		258	9		280	9,5		302
		220			240			260
10			11			12		
		176			192			208
4		158	4		174	4		190
3		145	3		161	3		177
7		114	7		130	7		146

FRONT: I

Work the front the same as the back to Row 114 (130) [146]. Divide for Pocket openings. Counting from the CENTER, mark the 22nd stitch on each side, then work the 3 sections separately putting the remaining sts. in holding position. Be sure to continue the side decreases AS ON THE BACK. Knit to Row 144 (160) [176]. After all 3 sections are completed, bring all the needles into working position and knit to Row 158 (174) [190]. Transfer every other stitch to the Ribber as you did for the back and work K1, P1 Ribbing to Row 176 (192) [208]. DON'T FORGET THE EYELETS... Continue in Stockinette stitch. Bind off the center 6 sts. put the needles on the left into holding position and complete the right side first.

*ON SIDE EDGE, decrease 1 st. every 6th row 5x (4x) [4x]. After Row 220 (240) [260], SHAPE ARMHOLE: Bind off 3 sts. 1x, 2 sts. 2x, 1 st. 6x. (4 sts. 1x, 3 sts. 1x, 2 sts. 1x, 1 st. 6x). [4 sts. 1x, 3 sts. 1x, 2 sts. 2x, 1 st. 6x]. After Row 257 (279) [303], SHAPE NECK: Bind off 2 sts. 2x, 1 st. 8x for all sizes and after Row 268 (290) [312], SHAPE SHOULDER same as the back. Bring the needles on the left into working position, knit 1 row to the left side, turn the Row Counter back to 176 (192) [208] and complete the left half. Follow the instructions from *.

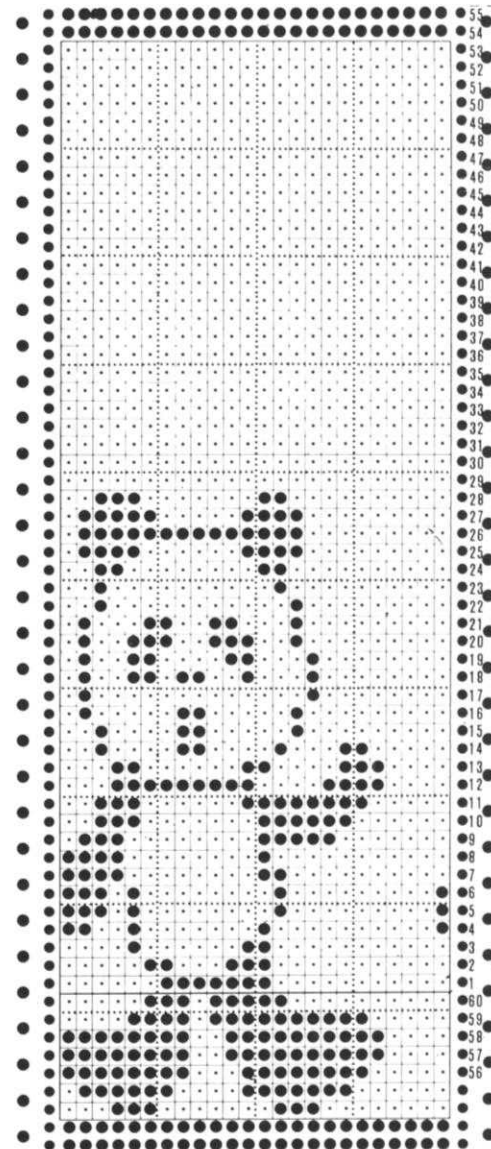

POCKET BANDS: Make 2.

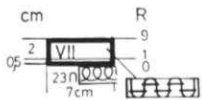

Cast on 23 sts. with color 3 and work K1, P1 Ribbing. Knit 1 row color 3 then continue with color 2 to Row 9. Bind off the crochet method for Ribbing.

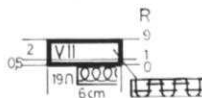

BREAST POCKET BAND:

Cast on 19 sts. with color 3 and work K1, P1 Ribbing. Knit 1 row color 3 then change to color 2 and knit to Row 9. Bind off the crochet method for Ribbing.

SLEEVES: III

Cast on 78 (83) [88] sts. with color 1 and work Stockinette stitch. ON EACH SIDE, decrease 1 st. every 14th row 7x. (every 12th row 6x, every 20th row 2x). [every 10th row 3x, every 14th row 6x]. After Row 104 (112) [118], SHAPE CAP: ON EACH SIDE, bind off 3 sts. 1x, 1 st. 3x, 1 st. 17x, 2 sts. 1x, 4 sts. 1x. (3 sts. 1x, 1 st. 3x, 1 sts. 18x, 2 sts. 1x, 4 sts. 1x). [3 sts. 1x, 1 st. 3x, 1 st. 18x, 2 sts. 2x, 4 sts. 1x]. After Row 148 (160) [168], bind off the remaining sts.



cm	2	R	cm	(4)	R	cm	[6]	R
10		148	11		160	11		168
		104			112			118
23,5			25			27,5		
		0			0			0
	78n	24cm		83n	255cm		88n	27cm

SLEEVE BANDS: Make 2.

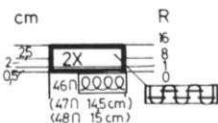

Cast on 46 (47) [48] sts. with color 3 and work K1, P1 Ribbing. Knit 1 row with color 3, then with color 2, knit to Row 8, with color 1, knit to Row 16. Bind off the crochet method for Ribbing.

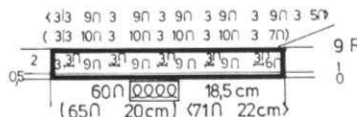

FRONT BAND: Make 2 and omit buttonholes in one piece.

Cast on 60 (65) [71] sts. with color 3 and work K1, P1 Ribbing. Knit 1 row color 3, then with color 2, knit to Row 9. Bind off the crochet method for Ribbing. Work the BUTTONHOLE BAND the same but make the BUTTONHOLES after Row 4, over the needles as shown for size you need.

hp 650

MAN'S JACKET

SIZES: 38 (40) [42]
 YARN: Fortissima
 GRAMS: 500 550 600
 TENSION: 5 to 7
 GAUGE: 15 sts. 20 rows = 5 cm (2")



Stockinette stitch with lower band and sleeve bands in K2, P2 (or K1, P1) Ribbing. Worn on the purl side.

FINISHING: Block. Sew seams, fold buttonhole band in half and sew in place. Cut leather 2.5 cm wide for collar, 6 cm wide and 16 cm long for shoulder trim. Sew leather strips in place, (see picture).

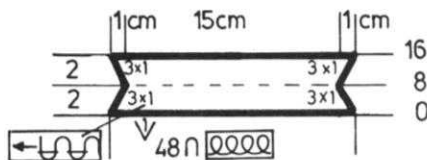

POCKET BAND:

Cast on 48 sts. and work Stockinette stitch.
 ON EACH SIDE, decrease 1 st. every 2nd row 3x, then after Row 8, ON EACH SIDE, increase 1 st. every 2nd row 3x.
 After Row 16, bind off.

BACK: II

Cast on 162 (170) [170] sts. and work 32 rows K2, P2 (or K1, P1) Ribbing. Continue in Stockinette stitch.
 Knit to Row 160 (168) [168].
SHAPE ARMHOLE: ON EACH SIDE, bind off 3 sts. 2x, 2 sts. 3x, 1 st. 6x. (3 sts. 2x, 2 sts. 4x, 1 st. 6x). [3 sts. 2x, 2 sts. 4x, 1 st. 6x]. ON EACH SIDE, increase 1 st. every 4th row 9x for all sizes.
 After Row 242 (248) [248], **SHAPE SHOULDER** and watch for **NECK SHAPING**. FOR **SHOULDER**, bind off 5 sts. 8x, 4 sts. 2x, (5 sts. 10x), [5 sts. 10x].
***FOR NECK:** After Row 256 (262) [262], put half the sts. on the left into holding position and complete the right side first.
 ON **NECK SIDE**, bind off 8 sts. 3x for all sizes.
 Bring the needles on the left into working position, knit 1 row to the left side, turn the Row Counter back to 256 (262) [262] and complete the left half. Follow the instructions from * and don't forget to complete the shoulder shaping.

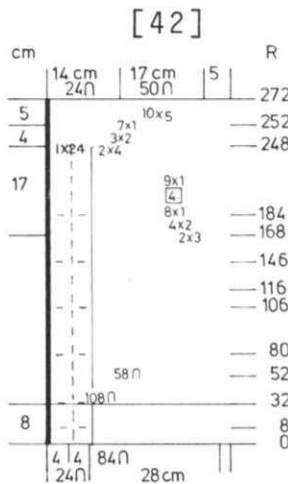
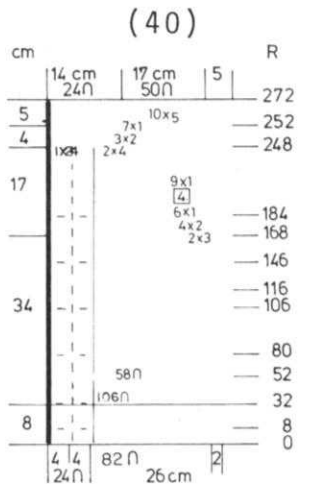
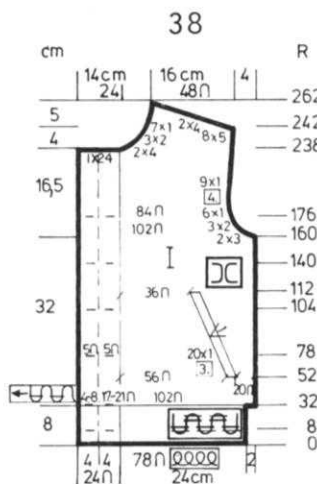
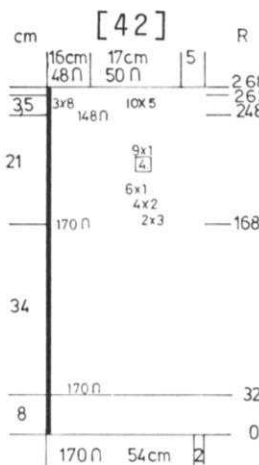
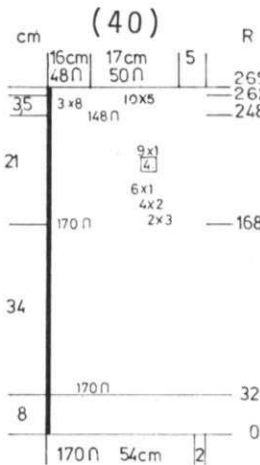
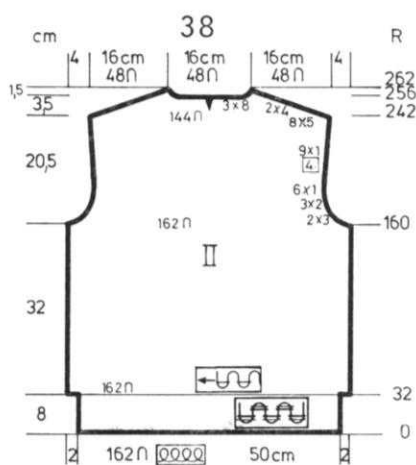

FRONT: Make 1, reverse 1.

Cast on 102 (106) [108] sts. and work K2, P2 (or K1, P1) Ribbing OVER 78 (82) [84] sts. on the RIGHT and keep 24 front edge sts. in Stockinette sts.
MAKE BUTTONHOLES over needles 4 to 8 and 17 to 21 after Row 8 on the LEFT.
 After Row 32, continue in Stockinette stitch.
 Make the following **BUTTONHOLES** over the same needles after the Rows shown on the Chart for YOUR SIZE.
 After Row 52, **SPLIT FOR POCKET**. Remove 20 sts. from SIDE EDGE onto waste yarn. ON THE REMAINING stitches, knit to Row 112 (116) [116] BUT AT THE SAME TIME, for pocket, decrease 1 st. every 3rd row 20x.
 After Row 112 (116) [116], remove the sts. onto contrast waste yarn. Cast on over needles 41 to 77 then hang the 20 lining sts., put Row Counter at 52 and knit to Row 112 (116) [116]. Hang the sts. held on waste yarn onto the machine with 2 sts. on needles 41 to 77.
 Knit to Row 160 (168) [168].
SHAPE ARMHOLE same as the back then increase 1 st. every 4th row 9x.
 After Row 237 (247) [247], **SHAPE NECK:** Bind off 24 sts. 1x, then bind off 4 sts. 2x, 2 sts. 3x, 1 st. 7x for all sizes.
 After Row 242 (252) [252], **SHAPE SHOULDER** same as the back.
 Work the 2nd section with reverse shaping but OMIT THE BUTTONHOLES.

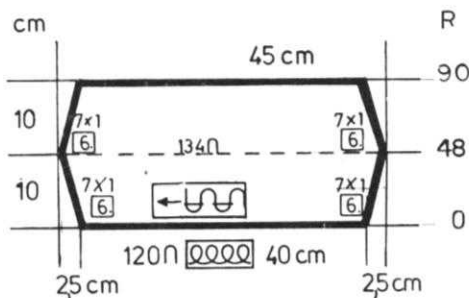

COLLAR:

Cast on 120 sts. and work Stockinette stitch.
 ON EACH SIDE, increase 1 st. every 6th row 7x.
 After Row 48, ON EACH SIDE, decrease 1 st. every 6th row 7x.
 After Row 90, bind off.

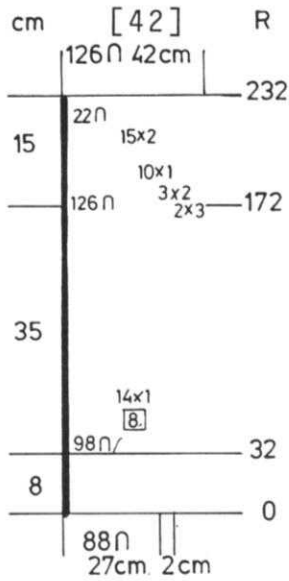
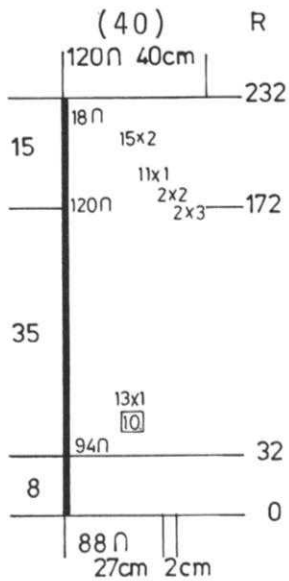
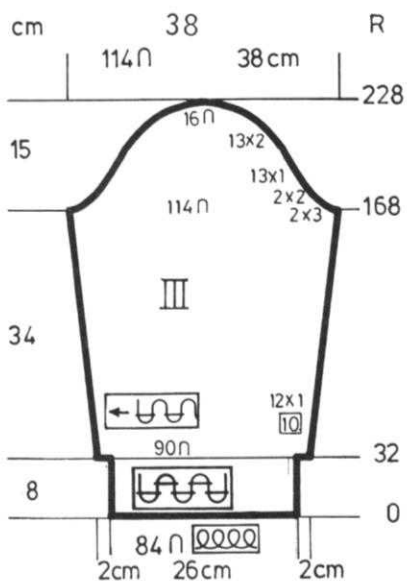

SLEEVES: III

OPEN CAST ON WITH WASTE YARN. Cast on 90 (94) [98] sts. with waste yarn and knit 8 to 10 rows. Change to Garment yarn and PUT COUNTER AT 32. Continue in Stockinette stitch. ON EACH SIDE, increase 1 st. every 10th row 12x. (every 10th row 13x). [every 8th row 14x]. After Row 168 (172) [172], SHAPE CAP: ON EACH SIDE, bind off 3 sts. 2x, 2 sts. 2x, 1 st. 13x, 2 sts. 13x. (3 sts. 2x, 2 sts. 2x, 1 st. 11x, 2 sts. 15x). [3 sts. 2x, 2 sts. 3x, 1 st. 10x, 2 sts. 15x]. After Row 228 (232) [232], bind off the remaining sts. Hang the sts. held on waste yarn back onto the machine, decreasing to 84 (88) [88] sts. Transfer every other stitch to the Ribber and work 32 rows K1, P1 Ribbing then bind off the crochet method for Ribbing.

dk 651

WOMAN'S SKIRT & JACKET

SIZES: 12 (14) [16]
 YARN: Cheri
 GRAMS: 1 Cone (approx. 1 lb. 11 oz) for all sizes.
 TENSION: 6 to 8
 GAUGE: 14 sts. 21 rows = 5 cm (2")

A Ribbing Pattern of 7 sts. on main machine and 7 sts. on the Ribber for Pattern 1. Pattern 2 is K1, P1 Ribbing.

FINISHING: See General Instructions. JACKET: Turn under 2" on front edge and sew in place. NECKBAND & TIE: Sew center seam of neckband then sew 116 sts. to neckline fold in half and sew in place. (See picture).

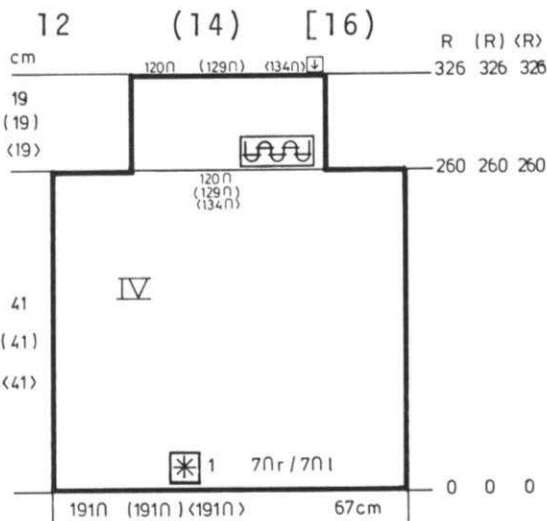
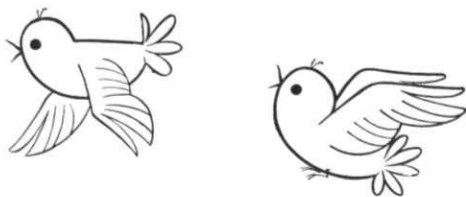

SKIRT: Make 2 sections the same.

Cast on 191 sts. and set in Pattern 1 of 7 sts. on main machine and 7 sts. on the Ribber (Be sure to keep in pattern sequence when working the 2nd section). Knit in Pattern to Row 260. Transfer the Ribber sts. to main machine then remove onto waste yarn. Hang the sts. back onto the machine decreasing to 120 (129) [134] sts. Transfer every other stitch to the Ribber and work K1, P1 Ribbing to Row 326. Bind off LOOSELY.

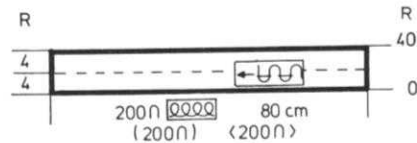

NECKBAND & TIES: Make 2.

Cast on 200 sts. and work 40 rows Stockinette stitch then bind off.

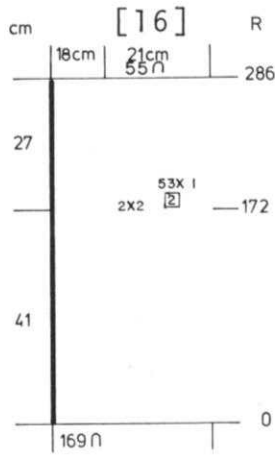
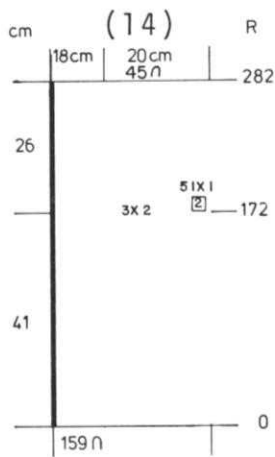
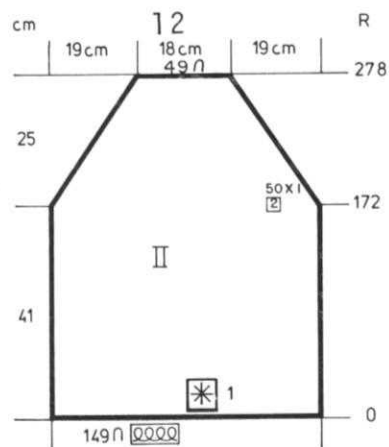

JACKET BACK: II

Cast on 149 (159) [169] sts. and set in Pattern 1. Knit to Row 172. SHAPE RAGLAN: ON EACH SIDE, decrease 1 st. every 2nd row 50x for the first size. FOR 2nd SIZE, bind off 2 sts. 3x, then decrease 1 st. every 2nd row 51x. FOR 3rd SIZE: bind off 2 sts. 2x, then decrease 1 st. every 2nd row 53x. After Row 278 (282) [286], bind off the remaining sts.



dk 651

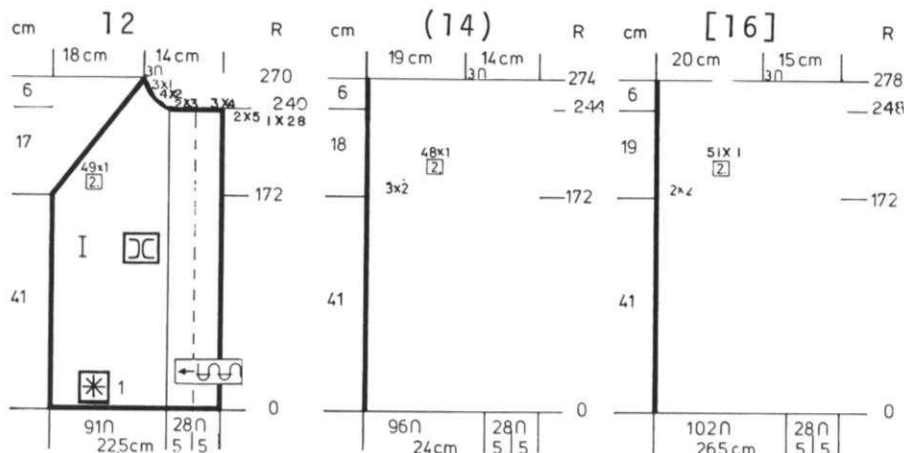

FRONT: Make 1, reverse 1

Cast on 119 (124) [130] sts. and set 91 (96) [102] sts. on the LEFT (right for 2nd section) into Pattern 1. Keep the 28 sts. on the RIGHT (left) in Stockinette stitch.
 Knit to Row 172. SHAPE RAGLAN. ON OPPOSITE SIDE OF CAM BOX, decrease 1 st. every 2nd row 49x. (bind off 2 sts. 3x, then decrease 1 st. every 2nd row 48x). [bind off 2 sts. 2x, then decrease 1 st. every 2nd row 51x].
 AT THE SAME TIME, after Row 240 (244) [248], SHAPE NECK: Bind off for all sizes, 28 sts. 1x, 5 sts. 2x, 4 sts. 3x, 3 sts. 2x, 2 sts. 4x, 1 st. 3x. Work the 2nd section with reverse shaping.

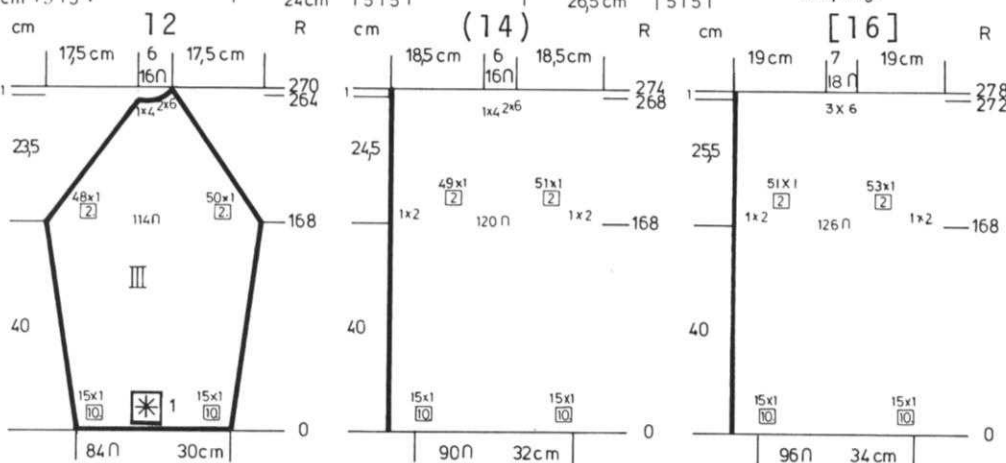

SLEEVES: III Make 1, reverse 1.

Cast on 84 (90) [96] sts. and set in Pattern 1. ON EACH SIDE, increase 1 st. every 10th row 15x for all sizes. After Row 168, SHAPE RAGLAN: PLEASE FOLLOW THE CHART IN YOUR SIZE FOR THE DIFFERENT SHAPINGS ON EACH SIDE. Work the 2nd sleeve with reverse shaping.



kk 652

GIRL'S PULLOVER

SIZES: 8 (10) [12]
 YARN: Binia
 GRAMS:
 color 1 350 350 400
 color 2 50 50 50
 TENSION: 8 to 10
 GAUGE: 13 sts. 19 rows = 5 cm (2")



Stockinette stitch with a Norwegian Design on Sleeves: Punch Card.
 The bands are K1, P1 Ribbing.

FINISHING: See General Instructions.

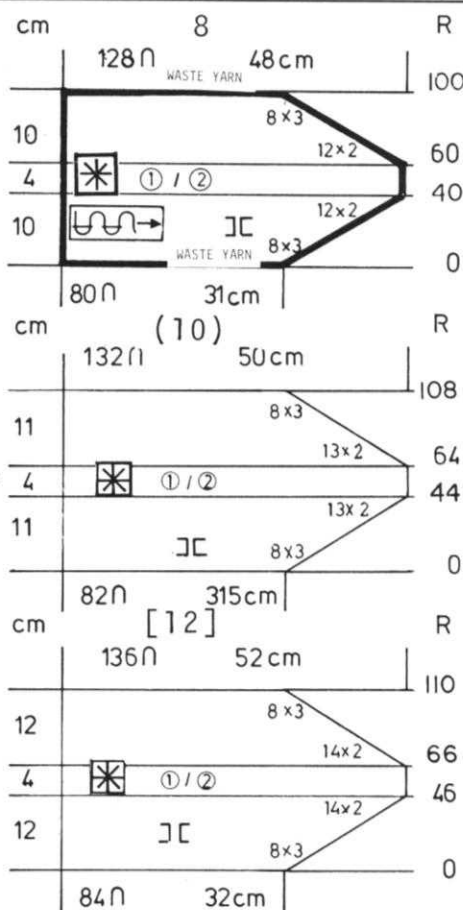
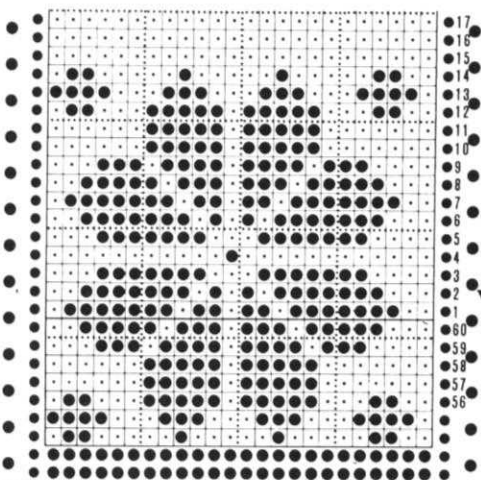

SLEEVES: III Make 1, reverse 1.

The Sleeves are knitted SIDEWAYS on the machine. With contrast waste yarn, cast on 80 (82) [84] sts. Knit 8 to 10 rows then change to color 1 and put Counter at 0. Continue in Stockinette stitch. ON THE RIGHT, on every 2nd row, cast on 3 sts. 8x, then 2 sts. 12x (13x) [14x]. After Row 40 (44) [46], work the Norwegian Design to Row 60 (64) [66] then continue in Stockinette stitch with color 1. ON THE RIGHT, on every 2nd row, bind off 2 sts. 12x (13x) [14x] then 3 sts. 8x for all sizes. After Row 100 (108) [110], remove the remaining sts. on waste yarn. Work the 2nd sleeve with reverse shaping, casting on from RIGHT TO LEFT. Cam Box will be on the left side at Row 0 and the shaping will be on the LEFT.

SLEEVE CUFFS:

Pick up 52 (56) [60] sts. and work 24 rows K1, P1 Ribbing then bind off loosely the crochet method for Ribbing.

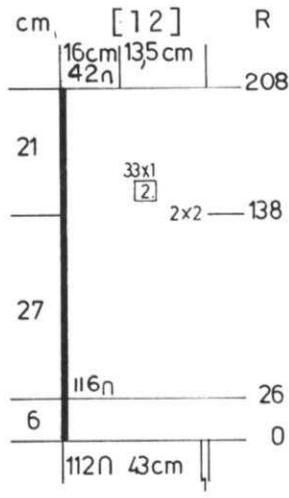
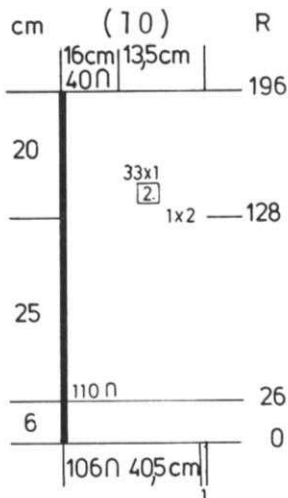
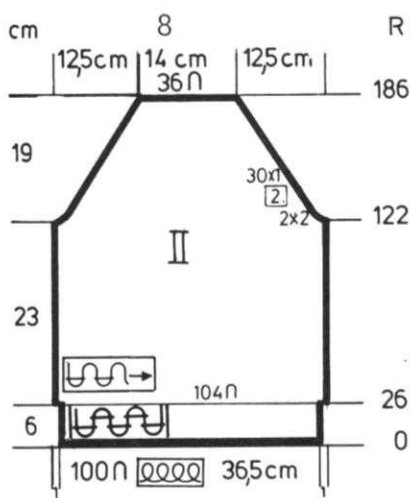

BACK: II

Cast on 100 (106) [112] sts. with color 1 and work 26 rows K1, P1 Ribbing. Transfer the Ribber sts. then remove from machine and hang them back onto the machine increasing to 104 (110) [116] sts. Continue in Stockinette stitch. Knit to Row 122 (128) [138]. SHAPE RAGLAN: ON EACH SIDE, bind off 2 sts. 2x (1x) [2x], then decrease 1 st. every 2nd row 30x (33x) [33x]. After Row 186 (196) [208], bind off the remaining sts.

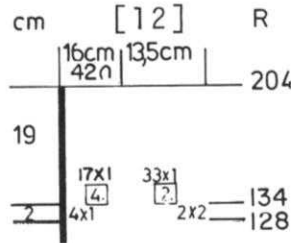
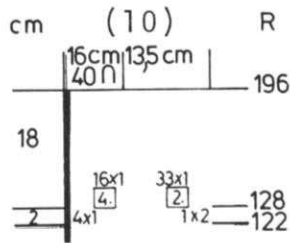
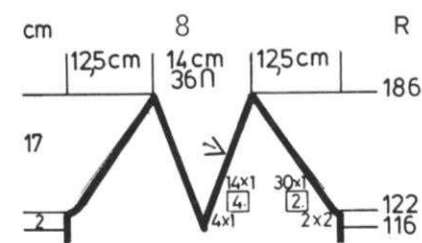

FRONT: I

Work the front the same as the back to Row 116 (122) [128]. Divide in the center, put the needles on the left into holding position and complete the right side first.

*ON NECK SIDE, decrease 1 st. 4x then every 4th row decrease 1 st. 14x, (16x) [17x] AND AT THE SAME TIME, SHAPE RAGLAN same as the back after Row 122 (128) [134]. Bring the needles on the left into working position, knit 1 row to the left side, turn the Row Counter back to 116 (122) [128] and complete the left half. Follow the instructions from *.

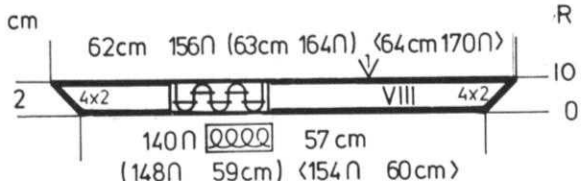

R (R) <R> NECKBAND: VIII

Cast on 140 (148) [154] sts. with color 1 and work K1, P1 Ribbing. ON EACH SIDE, increase 2 sts. every 2nd row 4x. After Row 10, bind off the Crochet method for Ribbing.

KK 653

CHILD'S PULLOVER & OVERALLS

SIZES: 1 (2) [3]
 YARN: Binia
 GRAMS:
 color 1 250 300 350
 color 2 150 150 150
 color 3 150 150 150
 TENSION: 8 to 10
 GAUGE: 14 sts. 19 rows = 5 cm (2")

The Pullover is Stockinette stitch with Ribbed bands and Yoke.
 The Overalls are Stockinette stitch with color stripes as shown on the Chart.

FINISHING: See General Instructions. Make a twisted Cord and pull through Eyelets at neckline (see Picture). Hem pants then work 1 row single crochet, 1 row reverse single crochet around armholes of overalls.

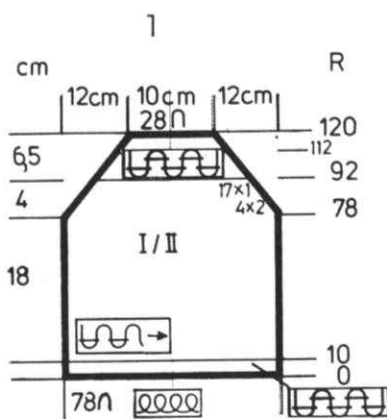

PULLOVER BACK & FRONT: 2 sections the same.

Cast on 78 (86) [94] sts. with color 1 and work 10 rows K1, P1 Ribbing. Continue in Stockinette stitch. After Row 78 (86) [94], SHAPE RAGLAN: ON EACH SIDE, decrease 2 sts. 4x (4x) [5x], then 1 st. 17x (19x) [18x] AND AT THE SAME TIME, after Row 92 (104) [112], continue in K1, P1 Ribbing and after Row 112 (124) [132], make EYELETS across by transferring every 5th st. to the 6th and leave empty needles in work. After Row 120 (132) [140], bind off the remaining sts. the crochet method for Ribbing.

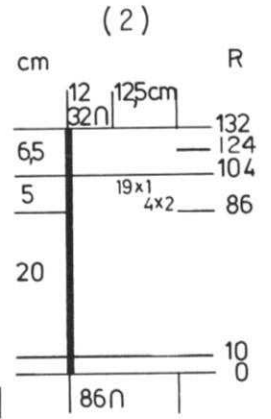

cm R (R) <R>

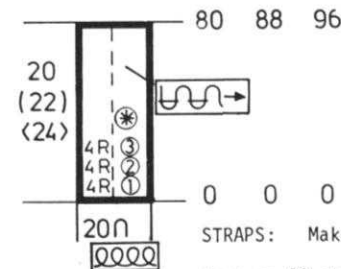

STRAPS: Make 2.

Cast on 20 sts. and work Stockinette stitch with REPEATED color stripes as shown on the Chart. After Row 80 (88) [96], bind off. Sew straps to back (fold in half first and sew together) of Overalls. Sew Buttons to front straps.



KK 653

SLEEVES: III

Cast on 48 (54) [60] sts. with color 1 and work 10 rows K1, P1 Ribbing. Continue in Stockinette stitch.

ON EACH SIDE, increase 1 st. every 10th row 7x for all sizes. After Row 72 (82) [90], SHAPE RAGLAN: ON EACH SIDE, ON EVERY 2nd ROW, decrease 1 st. 21x (23x) and for 3rd size, bind off 2 sts. 1x, then decrease 1 st. every 2nd row 23x, BUT AT THE SAME TIME, after Row 86 (100) [108], continue in K1, P1 Ribbing and after Row 106 (120) [132], make EYELETS the same as you did for front and back. After Row 114 (128) [140], bind off the crochet method for Ribbing.

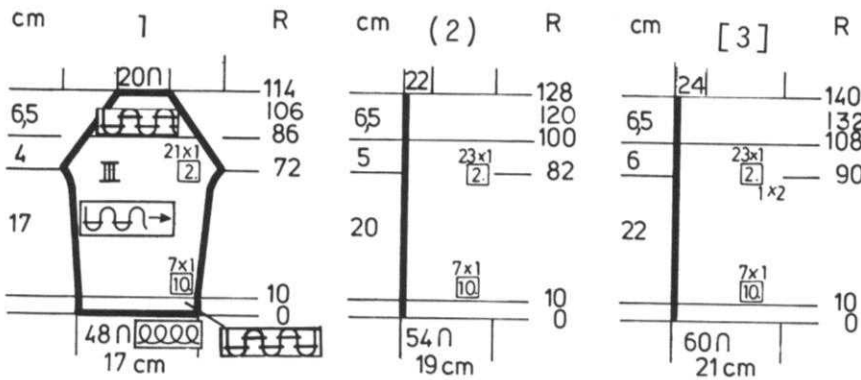

OVERALLS: Make 2, but omit BUTTONHOLES in BACK section.

*Cast on 51 (56) [62] sts. with color 1 and work Stockinette stitch with REPEATED color stripes as shown on the Chart. ON EACH SIDE, decrease 1 st. every 10th row 7x (6x) [7x]. After Row 104 (118) [128] remove the sts. onto contrast waste yarn. For the 2nd leg, REPEAT from * to row 104 (118) [128]. Hang the sts. held on waste yarn for the other leg, back onto the machine alongside the 2nd leg on the machine and continue. ON EACH SIDE, decrease 1 st. every 10th row 3x (4x) [4x]. After Row 184 (204) [224], SHAPE ARMHOLES: ON EACH SIDE, bind off 3 sts. 2x, 2 sts. 3x, 1 st. 5x. (3 sts. 2x, 2 sts. 5x, 1 st. 7x). [3 sts. 3x, 2 sts. 5x, 1 st. 7x]. After Row 222 (244) [266], bind off the remaining sts. FOR THE FRONT - After Row 202 and 214 (224 & 236) [246 & 258], ON EACH SIDE, MAKE BUTTONHOLES over needles 6 to 9.

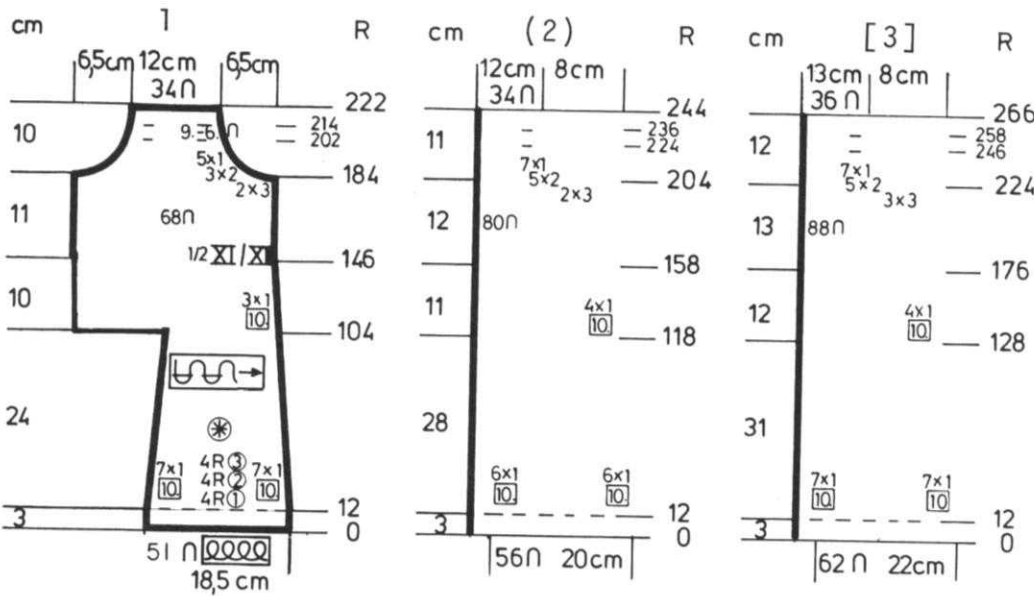

654

HASSOCK

You will need a Foam Pillow Form - 14" high, 20" wide and 20" depth.

You will need approximately 800 grams total of 6 different colors. Can use Crocus Crepe but there is no Kit for this. Can use Sport Weight Yarn.

TENSION: 4 to 6

GAUGE: 16 sts. 19 rows = 5 cm (2")

Norwegian Technique. Punch your own Cards. Elongate the Rows. KH 830 set your machine for elongating. AM 3 machine owners, knit 2 rows for every row of Pattern.

FINISHING: Sew all but bottom seams. Insert Foam Pillow form then close opening from the right side.



Make 4, using the designs and colors of your choice.

Cast on 164 sts. color 1 and work 14 rows Stockinette stitch. Continue in the Norwegian Design to Row 134 then work 14 rows Stockinette stitch with color 1. After Row 148, bind off.

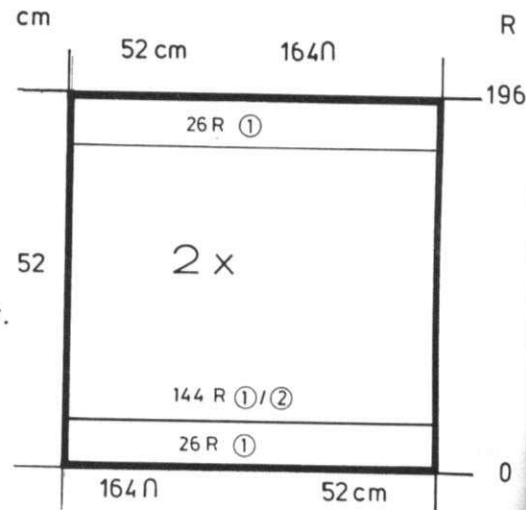
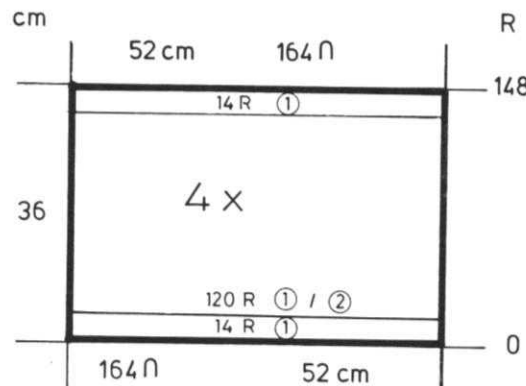

Make 2, using the designs and colors of your choice.

Cast on 164 sts. with color 1 and work 26 rows Stockinette stitch then continue in the Norwegian Design. After Row 170, work 26 rows Stockinette stitch with color 1. After Row 196, bind off.

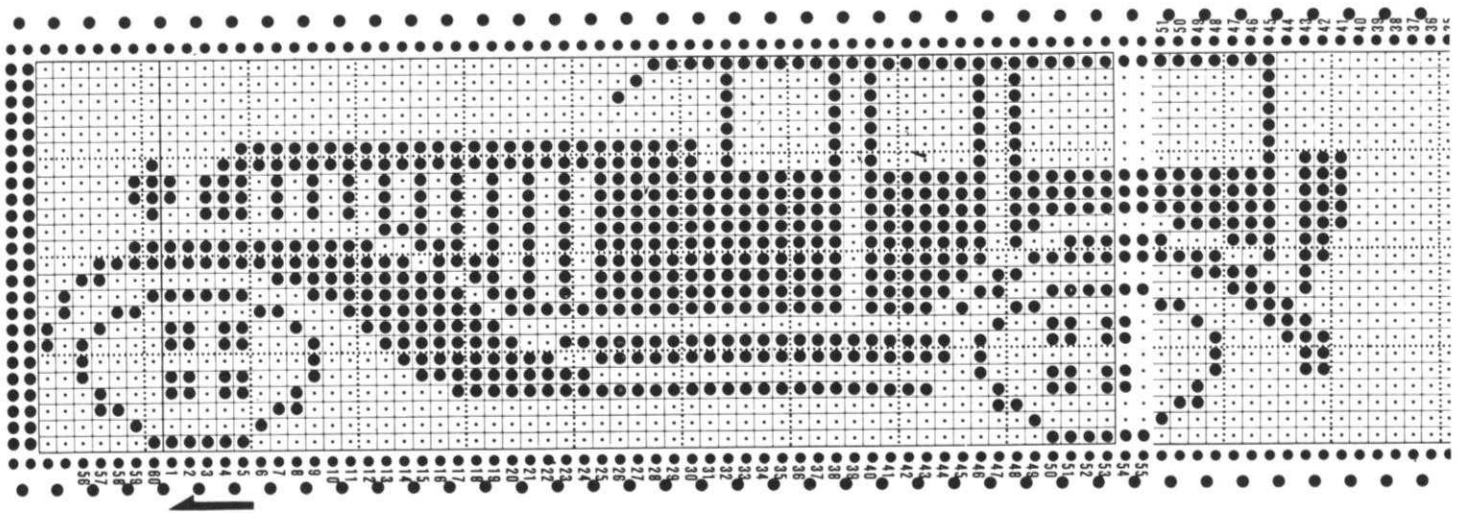
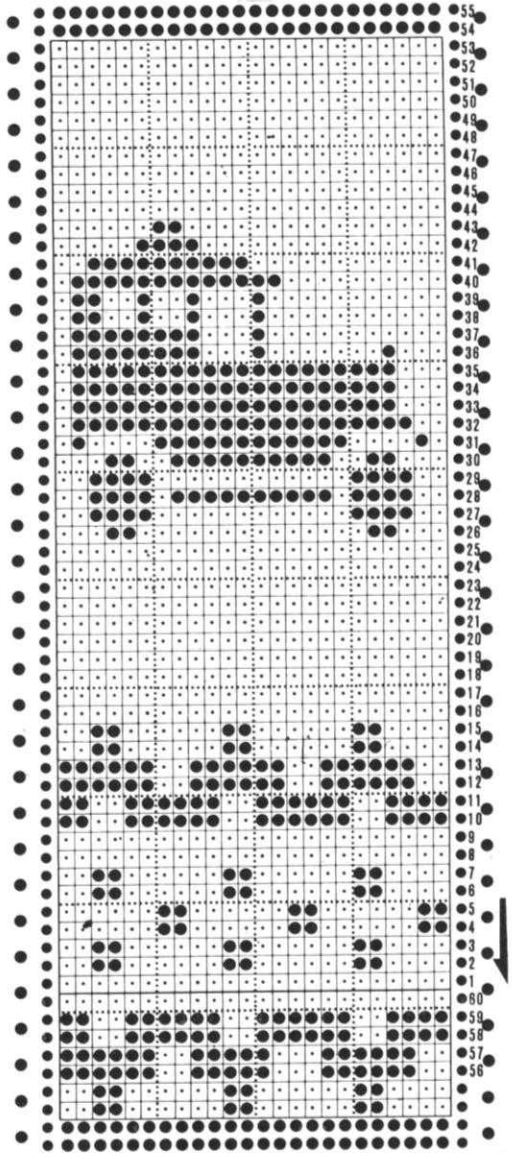
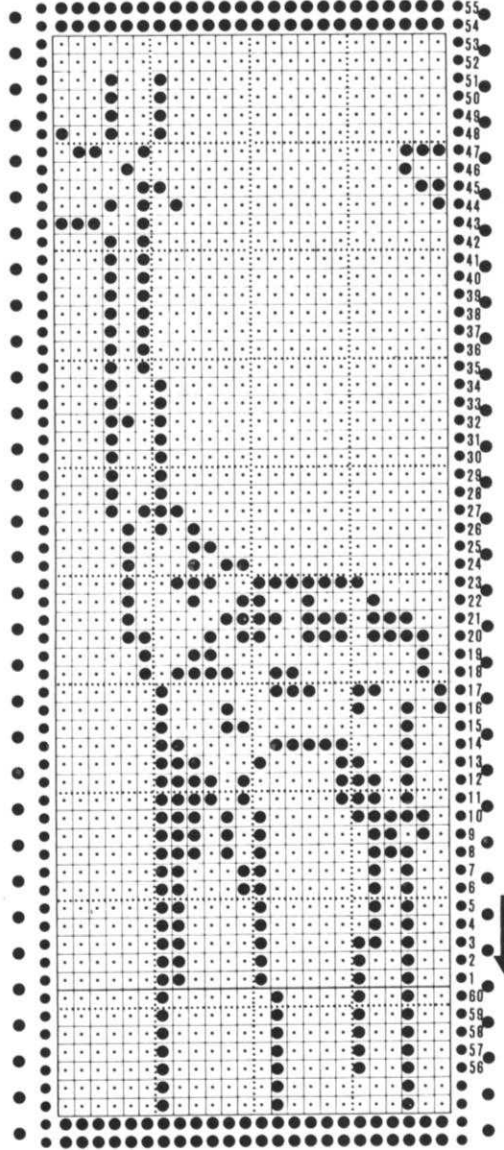
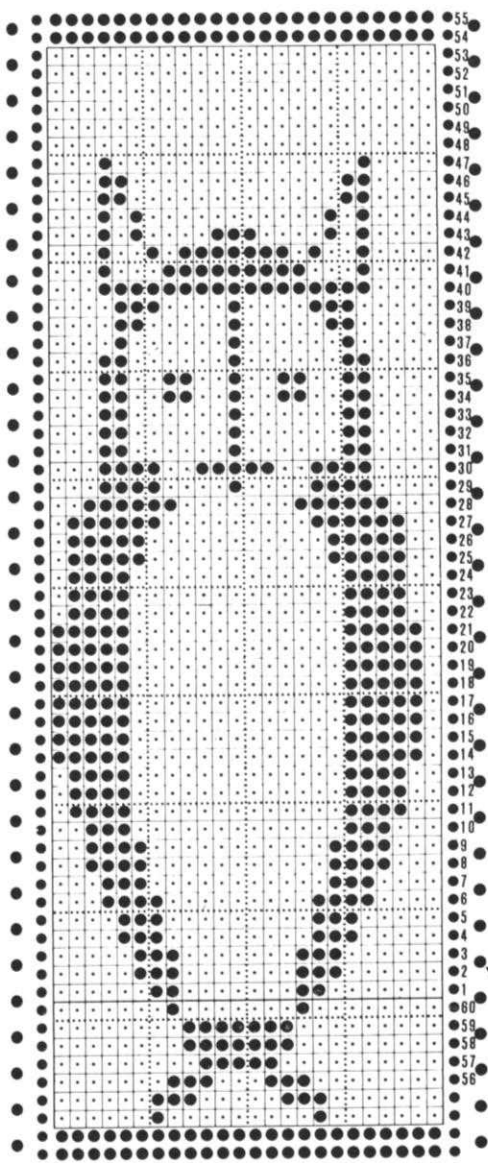

654

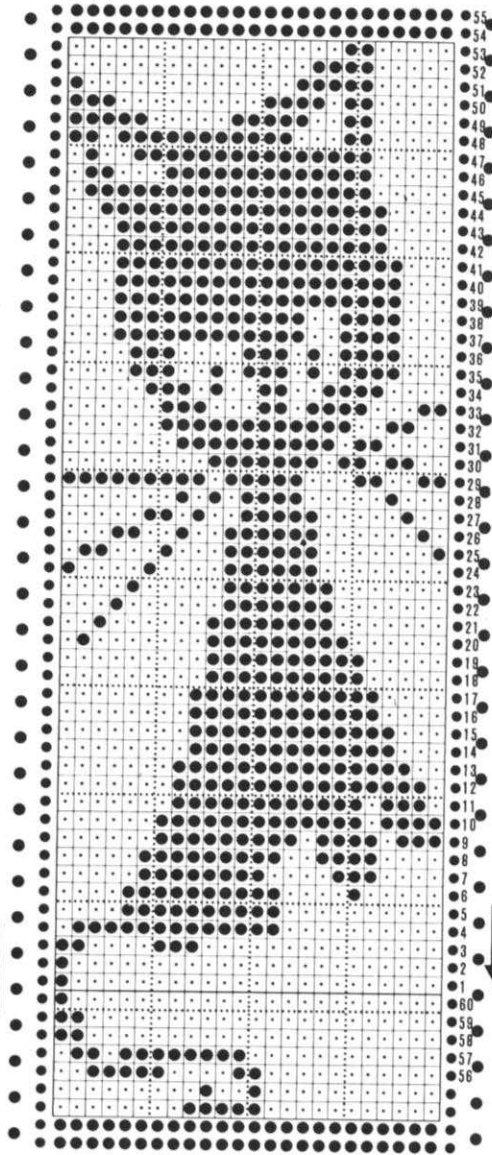
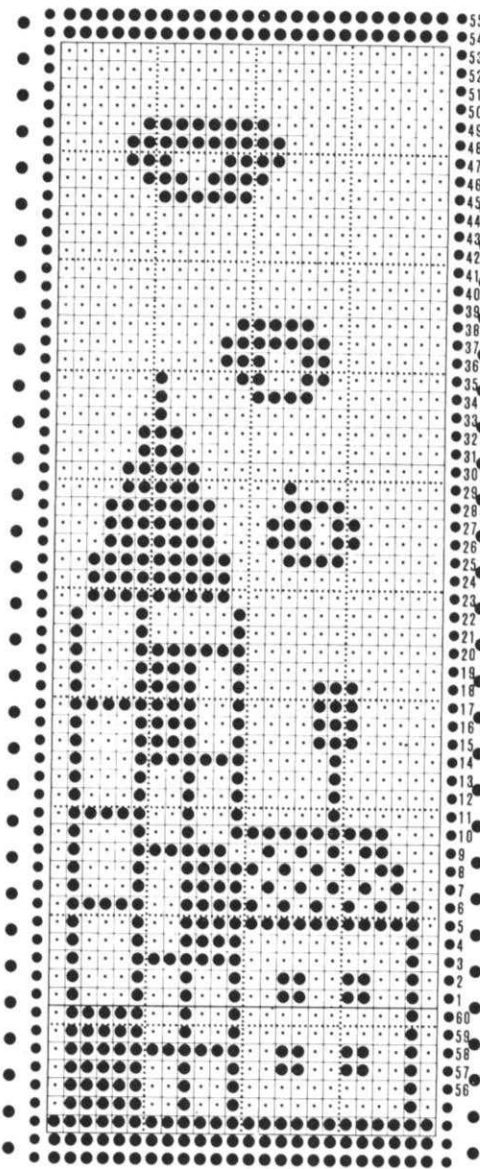
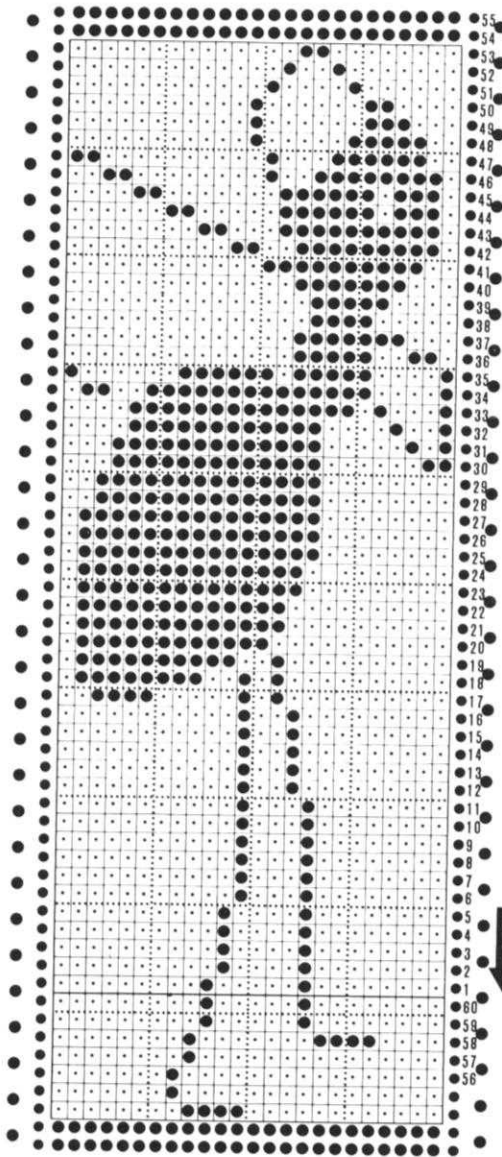

KK 655

GIRL'S HOODED JACKET & LEGWARMERS

SIZES: 9 yr. (10 yr) [11 yr]
 YARN: Binia

GRAMS:
 color 1 550 600 650
 color 2 100 100 100

TENSION: 10

GAUGE: 13 sts. 15 rows = 5 cm (2") Nor.

Stock: 19 sts. 25 rows = 5 cm (2")

You will also need a separating zipper.



PATTERN 1 is a TWEED STITCH. Punch your own card or use Card No.2D (tuck). This is used on the Pur1 side and the knitting must be REVERSED for Pattern 2 - the Norwegian Design. Bands are K1, P1 Ribbing.

FINISHING: See General Instructions. Sew Hood to neck. Fold all bands in half and sew in place. Single crochet along front edges then sew in zipper.

LEGWARMERS: Sew back seam together.

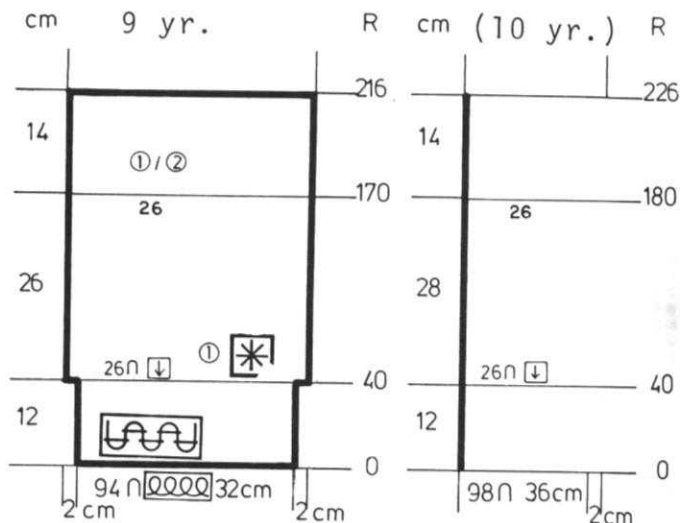

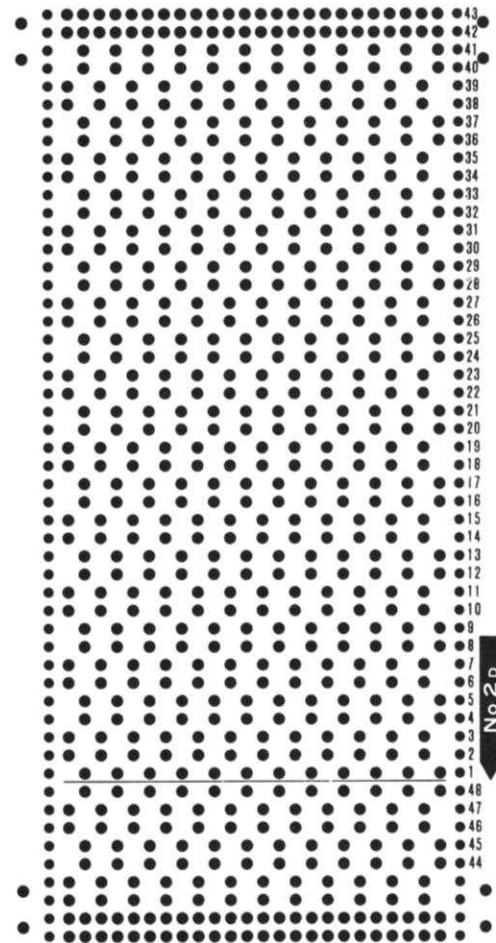
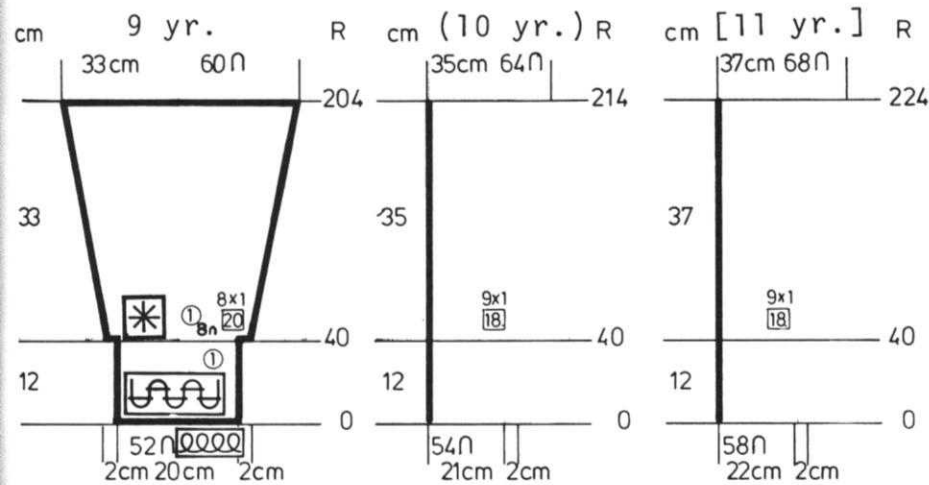

SLEEVES:

Cast on 52 (54) [58] sts. with color 1 and work 40 rows K1, P1 Ribbing.
 Decrease 8 sts. evenly across then continue in Pattern 1.
 ON EACH SIDE, increase 1 st. every 20th row 8x.
 (every 18th row 9x).
 [every 18th row 9x].
 After Row 204 (214) [224], bind off.

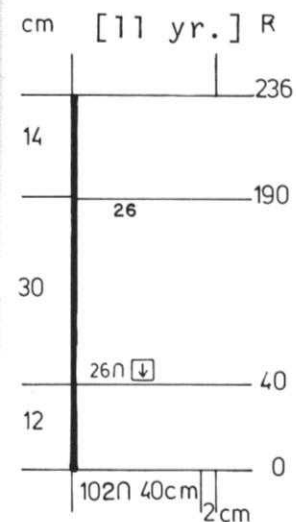
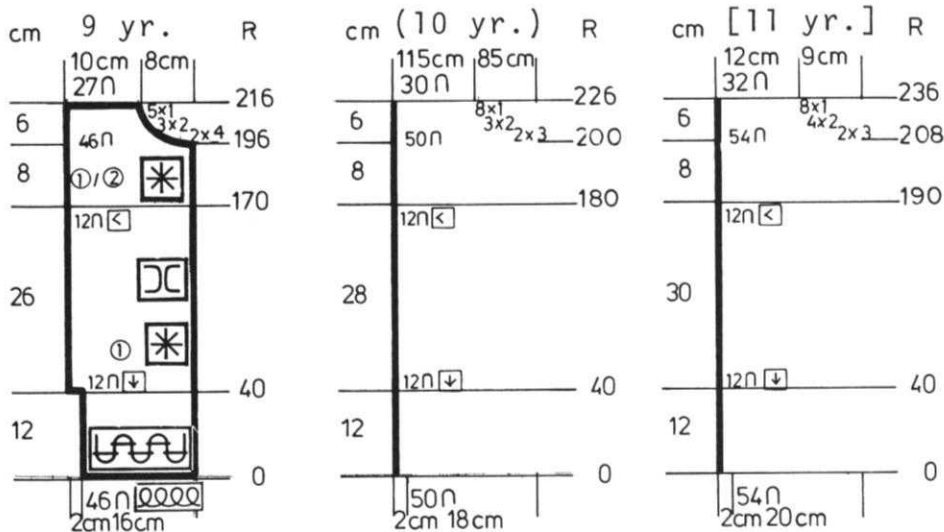
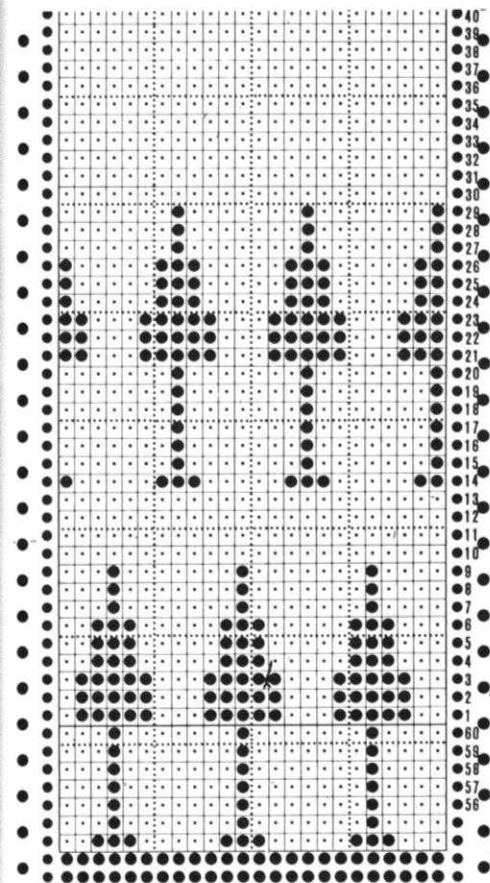

BACK:

Cast on 94 (98) [102] sts. with color 1 and work 40 rows K1, P1 Ribbing.
 Remove the sts. from the machine onto waste yarn then hang them back, decreasing 26 sts. evenly across.
 Continue in Pattern 1 (tweed stitch).
 Knit to Row 170 (180) [190].
 Remove the sts. onto waste yarn and hang them back onto the machine in REVERSE, INCREASING 26 sts. evenly across.
 Continue in Pattern 2 - the Norwegian Design.
 After Row 216 (226) [236], bind off.

FRONT: Make 1, reverse 1.

Cast on 46 (50) [54] sts. with color 1 and work 40 rows K1, P1 Ribbing.
 Remove the sts. as you did before and hang them back, decreasing 12 sts. evenly across.
 Continue in Pattern 1 (Tweed Stitch).
 Knit to Row 170 (180) [190].
 Remove the sts. from the machine, REVERSE, then hang them back onto machine, INCREASING 12 sts. evenly across.
 Continue in the Norwegian Design.
 Knit to Row 196 (200) [208].
SHAPE NECK: Bind off
 4 sts. 2x, 2 sts. 3x, 1 st. 5x.
 (3 sts. 2x, 2 sts. 3x, 1 st. 8x).
 [3 sts. 2x, 2 sts. 4x, 1 st. 8x].
 After Row 216 (226) [236], bind off.



KK 655

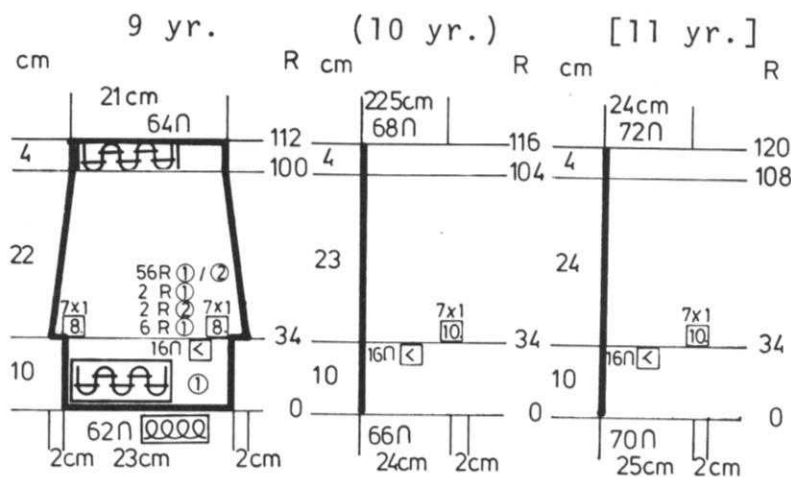

LEGWARMERS: Make 2.

Cast on 62 (66) [70] sts. with color 1 and work 34 rows K1, P1 Ribbing.
Remove the sts. from the machine and hang them back, decreasing 16 sts. evenly across.
Continue with color stripes of 6 rows color 1, 2 rows color 2, 2 rows color 1 then 56 rows Norwegian Design BUT AT THE SAME TIME, ON EACH SIDE, decrease 1 st. every 8th row 7x, (every 10th row 7x), [every 10th row 7x], AND BE SURE TO PUT THE PUNCH CARD IN UPSIDE DOWN.
After Row 100 (104) [108], Continue in K1, P1 Ribbing to Row 112 (116) [120], then bind off the crochet method for Ribbing.

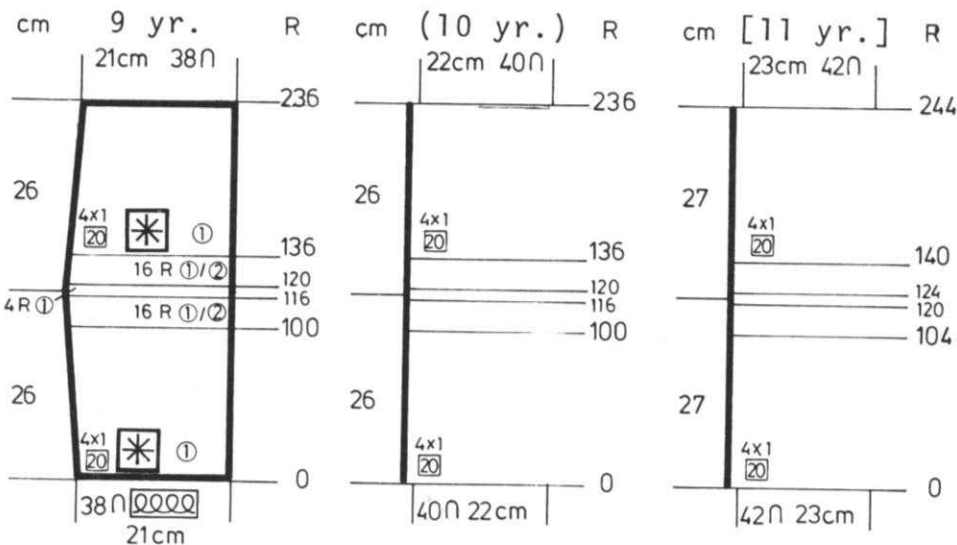

HOOD:

Cast on 38 (40) [42] sts. with color 1 and work in Pattern 1.
ON THE LEFT, increase 1 st. every 20th row 4x.
After Row 100 (100) [104], REVERSE THE KNITTING and work 16 Rows Norwegian Design.
Work 4 rows color 1 then put the Punch Card in UPSIDE DOWN and work 16 rows Norwegian Design.
After Row 136 (136) [140], REVERSE THE KNITTING and continue with Pattern 1, color 1.
ON THE LEFT, decrease 1 st. every 20th row 4x.
After Row 236 (236) [244], bind off

KK 656

GIRL'S DRESS

SIZES: 6 yr. (7 yr.) [8 yr.]

YARN: Amore

GRAMS:

color 1	450	500	550
color 2	200	200	200
color 3	200	200	200
color 4	50	50	50

TENSION: 5 to 7

GAUGE: 15 sts. 21 rows = 5 cm (2")

Stockinette stitch with Norwegian Motifs on the front section of bodice. Punch your own cards.

FINISHING: See General Instructions. Leave opening in skirt for pockets. Run elastic thread through top of skirt section and gather to fit. Sew bodice to skirt. Hem.

On sleeve edges, with color 3, work 1 row single crochet, 1 row reverse single crochet.

On neck edge, with color 2, work 1 row single crochet. *Row 2, (shell) - 1 single crochet in 2nd stitch, skip 1 st. work 5 double crochets in next st. REPEAT from *.

Row 3. With color 3, in every double crochet st. and single crochet stitch; work 1 single crochet.

Make a cord with 6 strands approximately 70 cm long and pull through sleeves. Sew fabric pockets in Skirt.



BODICE BACK:

With contrast waste yarn, cast on 90 (96) [102] sts. and work Stockinette stitch. Knit 8 to 10 rows, change to garment yarn -color. Put counter at 0.

Continue with stockinette stitch. Knit to Row 58 (64) [68].

SHAPE ARMHOLE: ON EACH SIDE, bind off 2 sts. 1x, 1 st. 4x.

[2 sts. 1x, 1 st. 4x].

[2 sts. 2x, 1 st. 4x].

After Row 112 (122) [130], SHAPE SHOULDER AND NECK AT THE SAME TIME. Put half the sts. on the left into holding position and complete the right side first.

*FOR SHOULDER, bind off

6 sts. 2x, 9 sts. 1x,

(7 sts. 2x, 9 sts. 1x),

[6 sts. 4x].

FOR NECK, bind off 10 (11) [11]

sts. 1x, 8 sts. 1x for all sizes.

Bring the needles on the left into working position, knit 1 row to the left side, turn the Row Counter back to 112 (122) [130] and complete the left half. Follow the instructions from *.

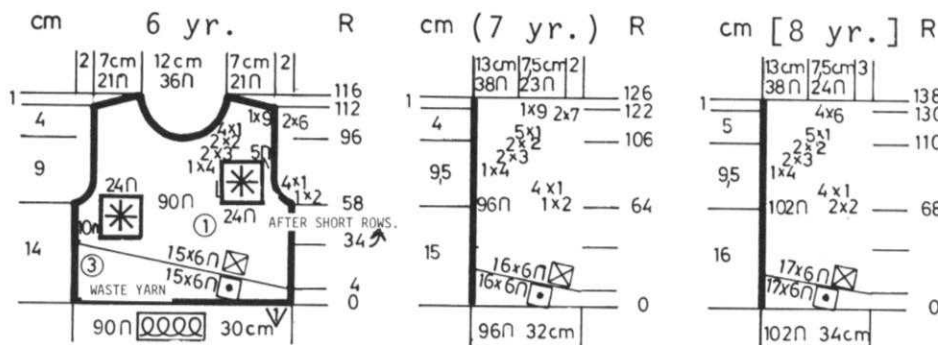

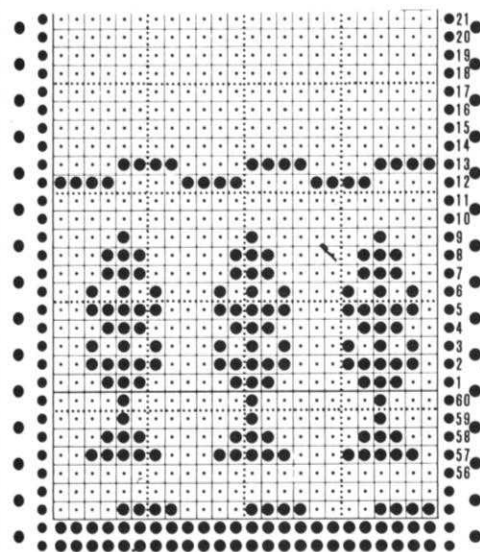

6 yr. (7 yr.) [8 yr.]

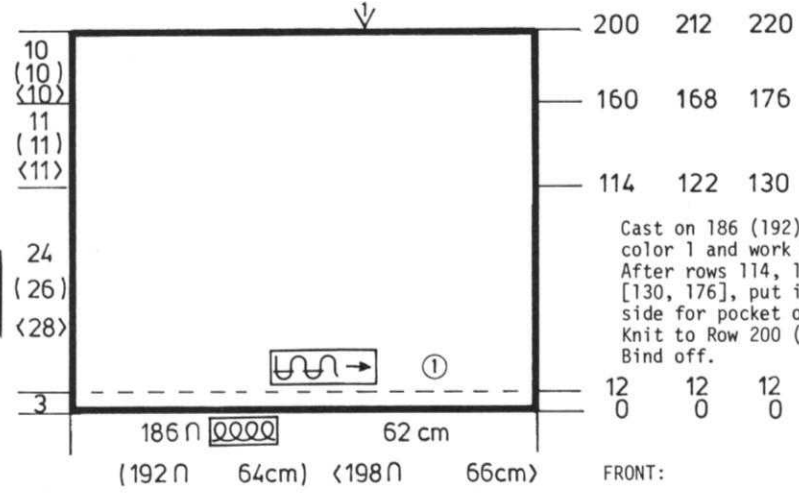

SKIRT: Make 2.

Cast on 186 (192) [198] sts. with color 1 and work Stockinette stitch. After rows 114, 160 (122, 168) [130, 176], put in markers on each side for pocket openings. Knit to Row 200 (212) [220]. Bind off.

12 12 12
0 0 0

FRONT:

OPEN CAST ON with waste yarn. 90 (96) [102] sts. After knitting 8 to 10 rows, change to color 3 and put Counter at 0. Knit 3 rows. ON OPPOSITE SIDE OF CAM BOX, put into holding position, 6 sts. 15x (16x) [17x]. After Row 33, change to color 2 and push back into working position 6 sts. 15x, (16x) [17x]. Continue with color 2. COUNTER AT 34. After Row 38, start Motifs. The first Motif over needles 57 to 80. After Row 58, work the 2nd Motif over needles 13 to 36 (see Chart). The flowers are duplicate stitch embroidery.

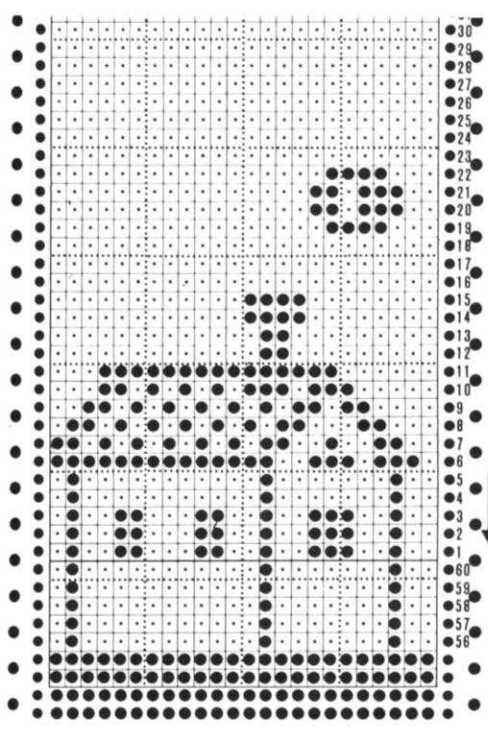
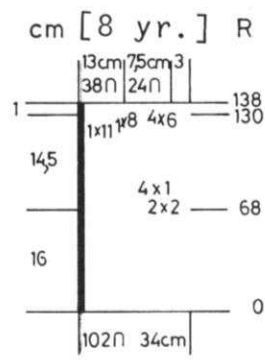
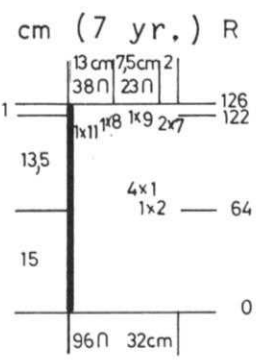
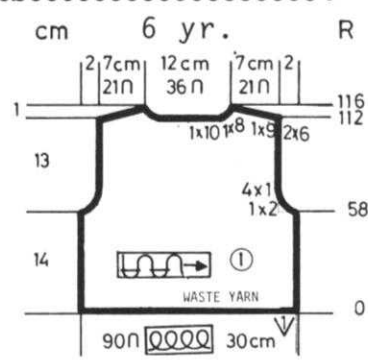

BELT: Make 2.

Cast on 20 sts. with color 3 and work K1, P1 Ribbing for 50 cm (19 3/4"). Sew belt to each side seam at waistline.

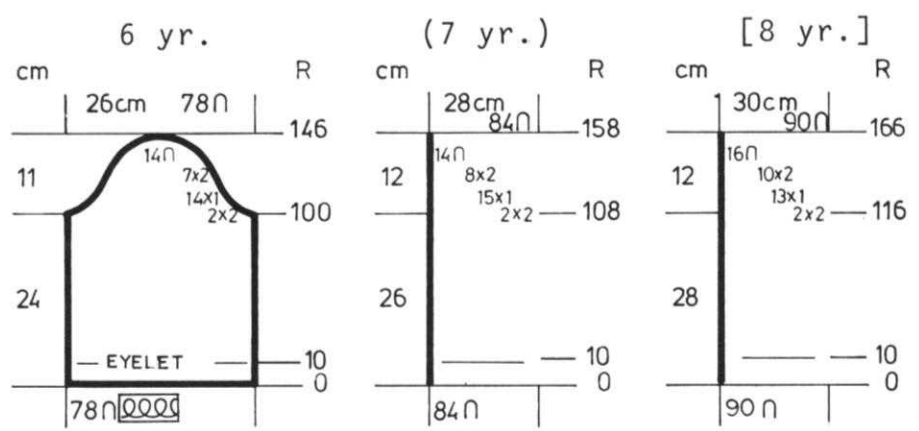

SLEEVES:

Cast on 78 (84) [90] sts. with color 1 and work Stockinette stitch. After Row 10, make eyelets across by transferring every 3rd st. to neighboring needle and leave the empty needles in work. Knit to Row 100 (108) [116]. SHAPE CAP: ON EACH SIDE, bind off 2 sts. 2x, 1 st. 14x, 2 sts. 7x. (2 sts. 2x, 1 st. 15x, 2 sts. 8x). [2 sts. 2x, 1 st. 13x, 2 sts. 10x]. After Row 146 (158) [166], bind off the remaining sts.



KK 657

GIRL'S CARDIGAN

SIZES: 10 yr. (11 yr.) [12 yr.]
 YARN: Amore
 GRAMS:
 color 1 200 250 300
 color 2 100 100 100
 TENSION: 5 to 7
 GAUGE: 14 sts. 19 rows = 5 cm (2")

Norwegian Technique with elongated Pattern. KH 830 machine owners, set your machine to elongate the rows. AM 3 machine owners, knit 2 rows for every Pattern Row. Bands are K1, P1 Ribbing.

FINISHING: See General Instructions. Make a twisted cord using 6 strands of yarn - 60" long and pull through eyelets at waistline.



BACK: II

Cast on 110 (118) [124] sts. with color 1 and work 24 rows K1, P1 Ribbing. Continue in the Norwegian Design. Knit to Row 32.
 MAKE EYELETS across by transferring the 3rd stitch on each side of center to the 4th stitch then every 9th to the 10th stitch. Leave empty needles in work and continue the Norwegian Design. Knit to Row 124 (130) [136].
 SHAPE ARMHOLE: ON EACH SIDE BIND OFF
 3 sts. 1x, 2 sts. 2x, 1 st. 3x. (3 sts. 1x, 2 sts. 2x, 1 st. 4x). [3 sts. 1x, 2 sts. 2x, 1 st. 4x]. After Row 144, continue in Stockinette stitch.
 Knit to Row 180 (188) [192].
 SHAPE SHOULDER and WATCH FOR NECK SHAPING.
 FOR SHOULDER: ON EACH SIDE, bind off
 7 sts. 4x,
 (6 sts. 4x, 7 sts. 1x),
 [7 sts. 4x, 5 sts. 1x],
 FOR NECK: After Row 184 (192) [198], put half the sts. on the left into holding position and complete the right side first.
 *Bind off 9 (9) [10] sts. 1x, 4 sts. 2x for all sizes.
 Bring the needles on the left into working position, knit 1 row to the left side, turn the Row Counter back to 184 (192) [198] and complete the left half. Follow the instructions from * but don't forget to complete the shoulder shaping.

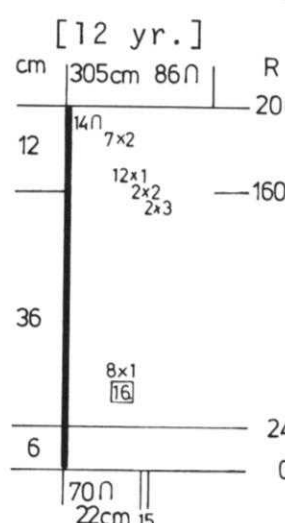
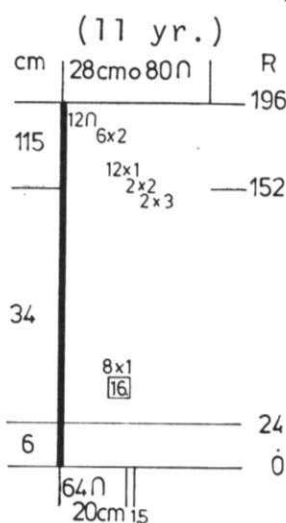
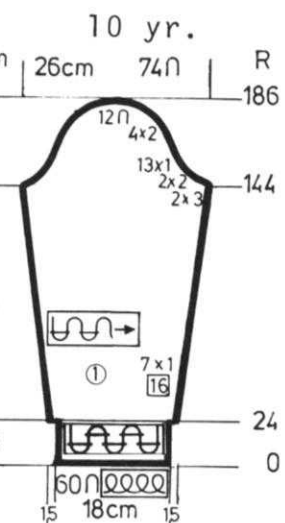
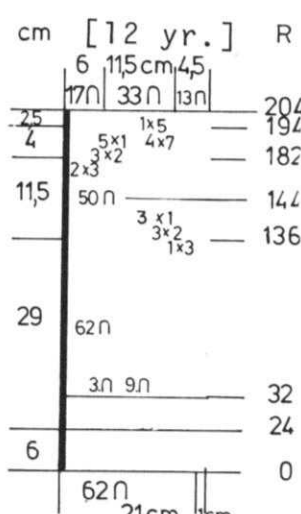
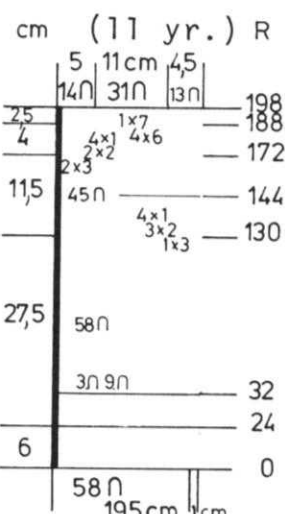
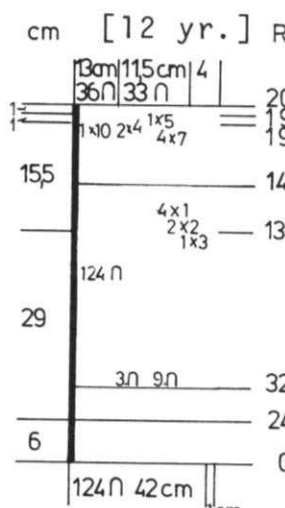
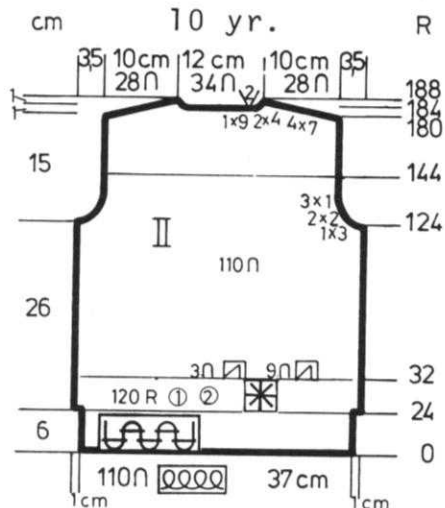

FRONT: I Make 1, reverse 1.

Cast on 54 (58) [62] sts. with color 1 and work 24 rows K1, P1 Ribbing. Continue in the Norwegian Design. After Row 32, MAKE EYELETS same as you did for the back, counting from the front edge.
 Knit to Row 124 (130) [136].
 SHAPE ARMHOLE: Bind off
 3 sts. 1x, 2 sts. 3x, 1 st. 3x. (3 sts. 1x, 2 sts. 3x, 1 st. 4x). [3 sts. 1x, 2 sts. 3x, 1 st. 3x]. After Row 144, continue in Stockinette stitch.
 Knit to Row 163 (171) [181].
 SHAPE NECK: Bind off
 3 sts. 2x, 2 sts. 2x, 1 st. 4x, (Same as first size),
 [3 sts. 2x, 2 sts. 3x, 1 st. 5x],
 and After Row 180 (188) [194],
 SHAPE SHOULDER same as the back.
 WORK THE 2ND SECTION WITH REVERSE SHAPING AND REVERSE THE PUNCH CARD. (See picture).

SLEEVES:

Cast on 60 (64) [70] sts. with color 1 and work 24 rows K1, P1 Ribbing. Continue in Stockinette stitch.
 ON EACH SIDE, increase 1 st. every 16th row 7x (8x) [8x].
 After Row 144 (152) [160], SHAPE CAP:
 ON EACH SIDE, bind off
 3 sts. 2x, 2 sts. 2x, 1 st. 13x, 2 sts. 4x.
 (3 sts. 2x, 2 sts. 2x, 1 st. 12x, 2 sts. 6x).
 [3 sts. 2x, 2 sts. 2x, 1 st. 12x, 2 sts. 7x].
 After Row 186 (196) [206], bind off the remaining sts.

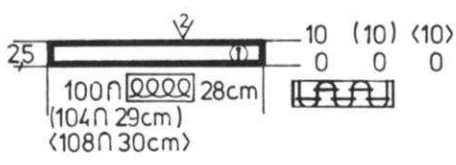
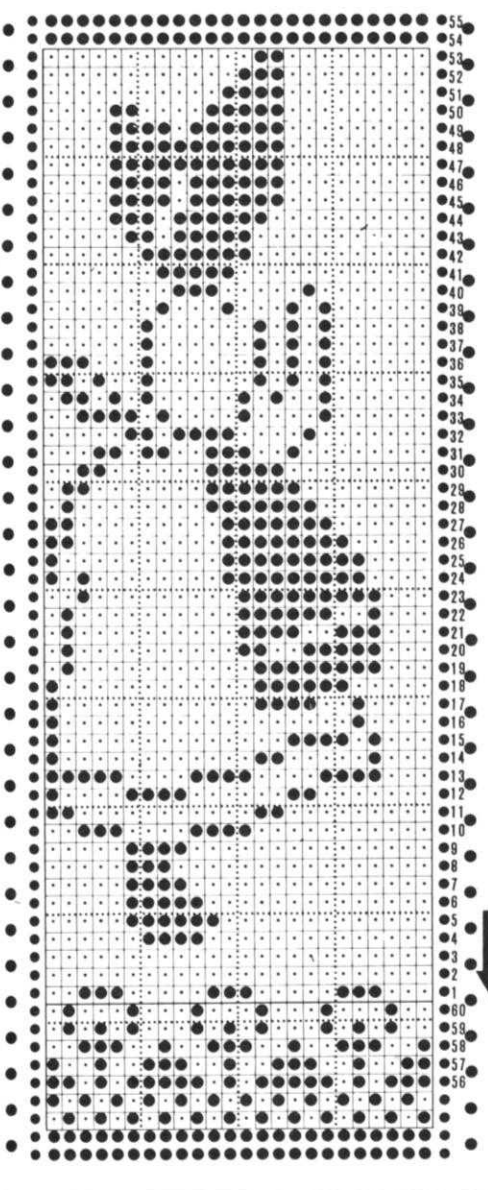

NECKBAND:
Cast on 100 (104) [108] sts. with color 1 and work 10 rows K1, P1 Ribbing. Bind off the crochet method for Ribbing.

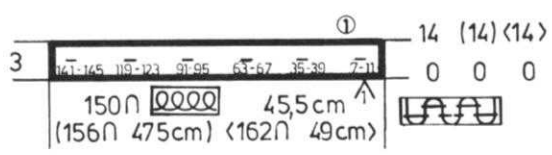

FRONT BANDS: Make 2 and omit the Buttonholes in 2nd piece.
Cast on 150 (156) [162] sts. with color 1 and work K1, P1 Ribbing. After Row 7, make BUTTONHOLES over the needles as shown on the Chart. After Row 14, bind off the crochet method for Ribbing.

KK 658

GIRL'S PULLOVER, JUMPER & BOLERO

SIZES: 9 yr. (10 yr.) [11 yr.]
YARN: Amore
GRAMS:
color 1 450 500 550
color 2 350 400 450
TENSION: 6 to 8
GAUGE:
Stock: 15 sts. 20 rows = 5 cm (2")
Pat: 15 sts. 18 rows = 5 cm (2")



Stockinette stitch with a Norwegian Design. Punch your own Card.

FINISHING: See General Instructions.
Skirt: Sew side seams of skirt. Run elastic thread around top at waist then pull up to fit and sew to bodice. Work 1 row single crochet around zipper opening then sew in zipper. Work 1 row single crochet, 1 row double crochet around neck and armholes. Work the same edging around Bolero. Using 4 strands of color 2, weave under 2 and over 2 through the double crochet edgings (see picture).
PULLOVER: With right side of collar against wrong side of neckline, sew the short row edge to neck. Flip the collar over to the right side and pin so that half of the 9 sts. of edge are on wrong side and half on right side to form a casing for cord. Sew in place, then pull cord through and tie (see picture).

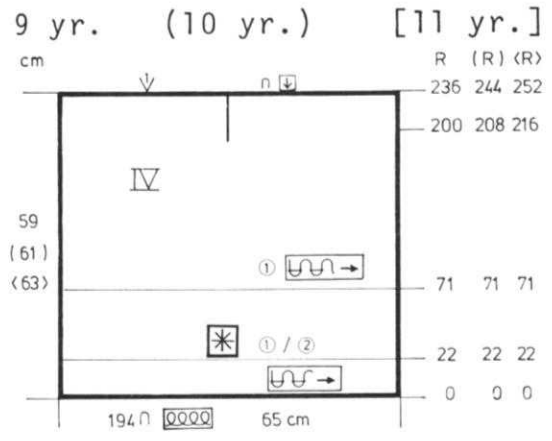
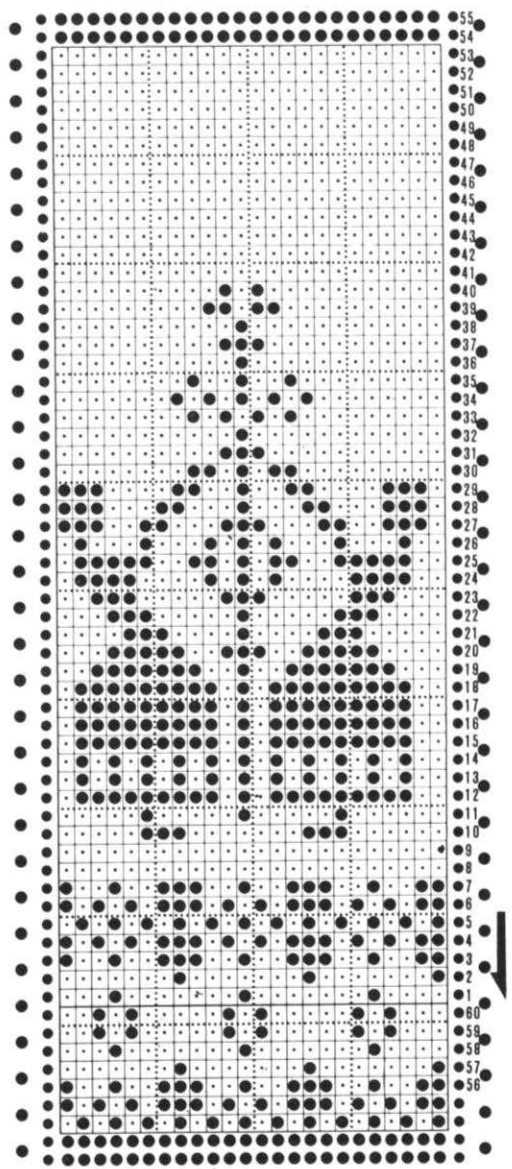

SKIRT: Make 2. Omit slit in back section.
Cast on 194 sts. with color 1 and work 22 rows Stockinette stitch.
Work the Norwegian Design to Row 71 then continue in Stockinette stitch to Row 200 (208) [216].
Divide in the center and work 1 section at a time (slit for zipper). *Knit to Row 236 (244) [252]. Bind off.
Bring the remaining needles into working position, knit 1 row to the left side, turn the Row Counter back to 200 (208) [216] and complete the left half. Follow the instructions from *.
Work the back section the same but omit the slit opening.

KK 658

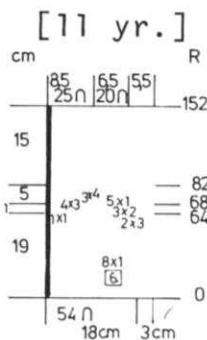
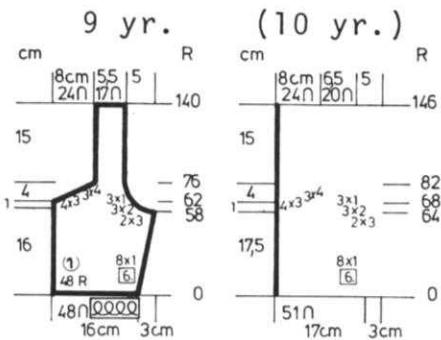
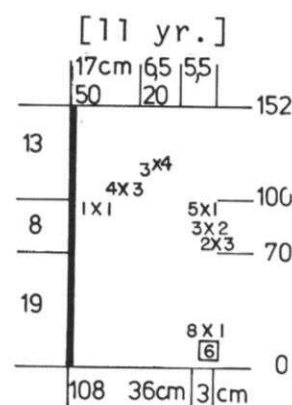
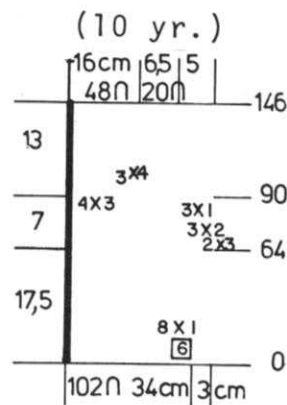
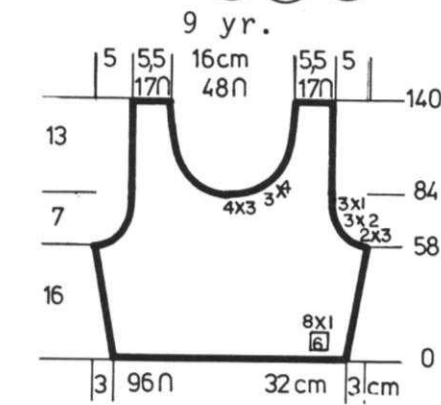

BODICE FRONT: Make 1, reverse 1.

Cast on 48 (51) [54] sts. with color 1 and work Stockinette stitch. ON SIDE EDGE, increase 1 st. every 6th row 8x. After Row 58 (64) [64], SHAPE ARM-HOLE same as the back and after Row 61 (67) [67], SHAPE NECK: Make Bind offs the same as the back. Knit to Row 140 (146) [152] then bind off the remaining sts. Reverse shaping for 2nd section.

PULLOVER BACK: II

Cast on 108 (114) [120] sts. with color 2 and work 20 rows K1, P1 Ribbing. Continue in Stockinette stitch. Knit to Row 110 (118) [126]. SHAPE ARMHOLE: ON EACH SIDE, bind off 3 sts. 1x, 2 sts. 2x, 1 st. 2x. (3 sts. 1x, 2 sts. 3x, 1 st. 2x). [3 sts. 1x, 2 sts. 3x, 1 st. 2x]. Knit to Row 170 (178) [190]. Put half the sts. on the left into holding position and complete the right side first. *SHAPE SHOULDER AND NECK AT THE SAME TIME. FOR SHOULDER, bind off 5 sts. 4x, 4 sts. 1x. (5 sts. 5x) [5 sts. 4x, 7 sts. 1x] FOR NECK, bind off 6 sts. 1x, 5 sts. 3x. (6 sts. 1x, 5 sts. 3x). [7 sts. 1x, 5 sts. 3x]. Bring the needles on the left into working position, knit 1 row to the left side, turn the Row Counter back to 170 (178) [190] and complete the left half. Follow the instructions from *

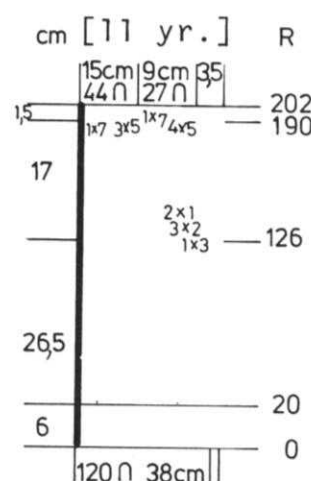
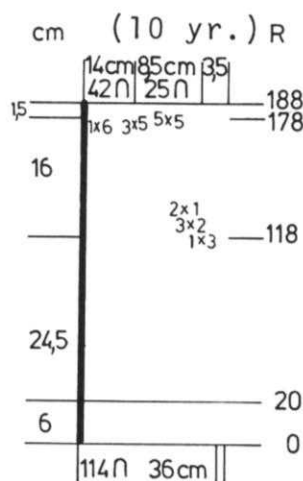
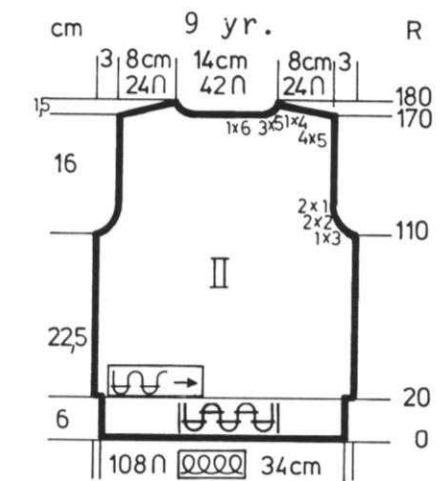

RUFFLED COLLAR:

Cast on 28 sts. *Knit 2 rows. ON OPPOSITE SIDE OF CAM BOX, put into holding position 9 sts. 1x, 2 sts. 9x (each time knitting 2 rows between - short rows are on the left side only). All needles in work, REPEAT FROM * until long enough to go around neckline (short edge).



PULLOVER FRONT: I

Work the front the same as the back to Row 110 (118) [126]. SHAPE ARMHOLES same as the back and after Row 128 (136) [148], remove 45 (46) [49] sts. on the left onto contrast waste yarn and work the right side first. *ON NECK SIDE, cast on 4 sts. After Row 155 (163) [175], SHAPE NECK: Bind off 4 sts. 2x, 3 sts. 3x, 2 sts. 2x, 1 st. 4x. (Same as first size). [4 sts. 2x, 3 sts. 3x, 2 sts. 2x, 1 st. 5x]. After Row 170 (178) [190], SHAPE SHOULDER same as the back. Bring the needles on the left into working position, turn Row Counter to 155 (163) [175] and follow the instructions from *.

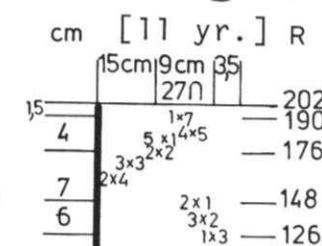
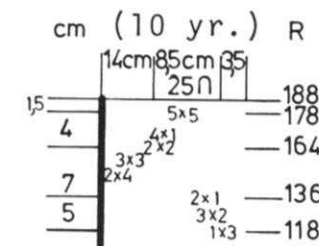
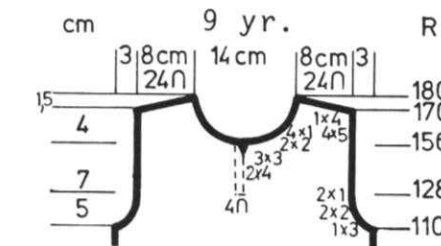

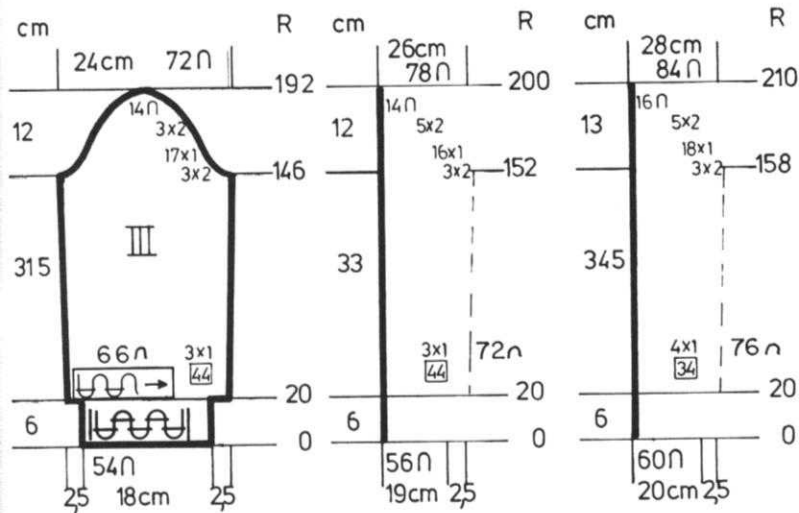

SLEEVES: III
 With contrast waste yarn, cast on 66 (72) [76] sts. Knit 8 to 10 rows then change to garment yarn and PUT COUNTER AT 20. Work Stock.st. ON EACH SIDE, increase 1 st. every 44th row 3x (3x) [4x]. After Row 146 (152) [158], SHAPE CAP: ON EACH SIDE, bind off 2 sts. 3x, 1 st. 17x, 2 sts. 3x. (2 sts. 3x, 1 st. 16x, 2 sts. 5x). [2 sts. 3x, 1 st. 18x, 2 sts. 5x]. After Row 192 (200) [210], bind off the remaining sts. Hang the sts. held on waste yarn back onto the machine decreasing to 54 (56) [60] sts. Transfer every other stitch to the Ribber and work 20 rows K1, P1 Ribbing then bind off the crochet method for Ribbing.



BOLERO BACK:

Cast on 120 (126) [132] sts. with color 1 and work 10 rows Stockinette stitch. Work the 49 rows of the Norwegian Design then continue with color 1 and Stockinette stitch. Knit to Row 96 (102) [106]. ON EACH SIDE, increase 1 st. every 4th row 9x. After Row 146 (154) [174], SHAPE SHOULDER: ON EACH SIDE, bind off 9 sts. 1x, 10 sts. 4x. (6 sts. 2x, 10 sts. 4x). [6 sts. 1x, 7 sts. 1x, 10 sts. 4x]. After Row 156 (166) [174], bind off the remaining sts.

BOLERO FRONT: Make 1 reverse 1.

Cast on 60 (64) [64] sts. with color 1 and work 10 rows Stockinette stitch. Work the 49 rows of the Norwegian Design same as the back then continue in Stockinette stitch with color 1. After Row 96 (102) [106], ON ARM SIDE, increase 1 st. every 4th row 9x. After Row 134 (140) [144], SHAPE NECK: Bind off 5 sts. 1x, 3 sts. 2x, 2 sts. 3x, 1 st. 3x. (6 sts. 1x, 3 sts. 2x, 2 sts. 3x, 1 st. 3x). [5 sts. 1x, 3 sts. 2x, 2 sts. 3x, 1 st. 3x]. After Row 147 (155) [163], SHAPE SHOULDER same as the back.

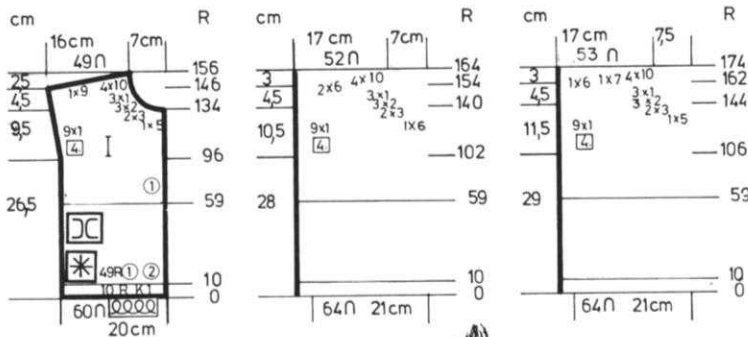
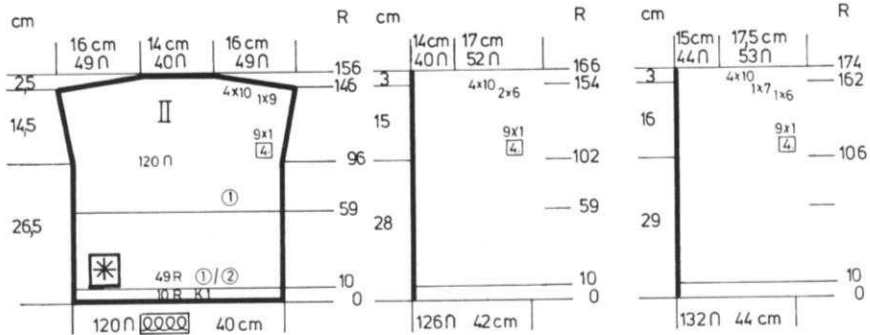

KK 659

CHILD'S COVERALLS & JACKET

SIZES: 6 yr. (7 yr.) [8 yr.]
 YARN: Binia
 GRAMS: color 1 550 600 650
 color 2 100 100 150
 color 3 100 100 150
 TENSION: 8 to 10
 GAUGE: 13 sts. - 19 rows = 5 cm (2")

Stockinette stitch with a Norwegian Design. Punch your own card.

FINISHING: See General Instructions. With color 1, work 1 row single crochet and 1 row reverse single crochet around neck and arm edge of Coveralls. Finish Buttonhole and sew on Button.

Work 1 row single crochet down front edges then sew in zipper.

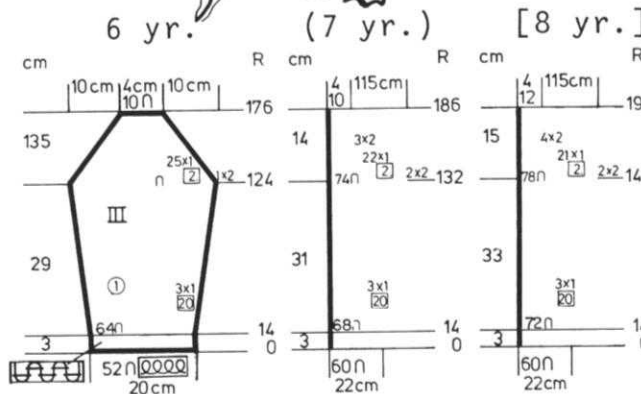
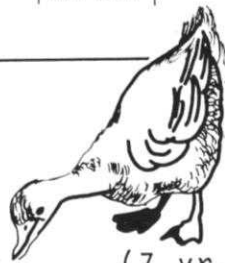

SLEEVES: III

With contrast waste yarn, cast on 58 (68) [72] sts. and knit 8 to 10 rows, change to garment yarn and put COUNTER AT 14. Work Stock.st. ON EACH SIDE, increase 1 st. every 20th row 3x. After Row 124 (132) [140], SHAPE RAGLAN: ON EACH SIDE, bind off 2 sts. 1x (2x) [2x], then every 2nd row decrease 1 st. 25x (22x) [21x] and for 2nd and 3rd sizes only bind off 2 sts. 3x [4x]. After Row 176 (186) [196], bind off the remaining sts. Hang the stitches held on waste yarn back onto the machine, decreasing to 52 (60) [60] sts. Transfer every other stitch to the Ribber and work 14 rows K1, P1 Ribbing. Bind off the crochet method for Ribbing.

KK 659

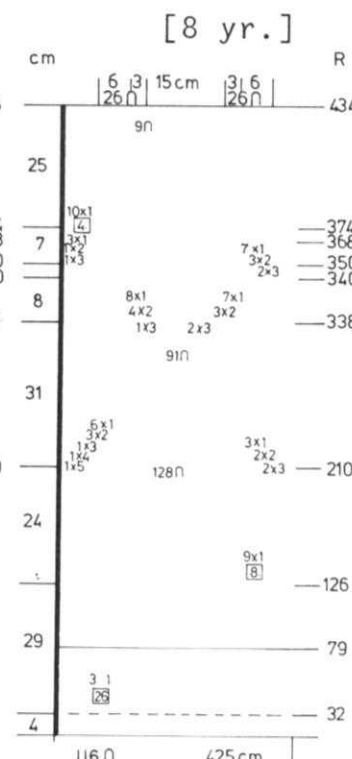
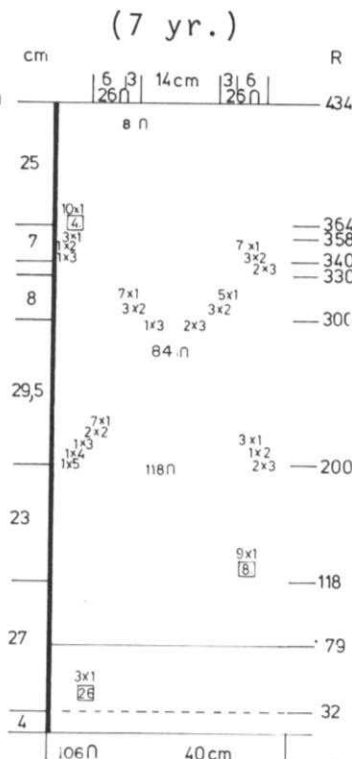
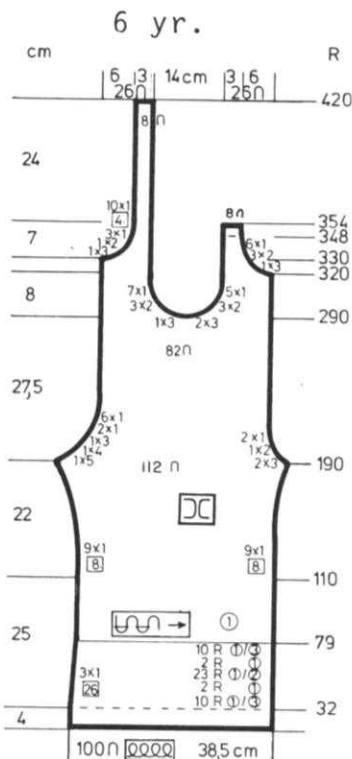
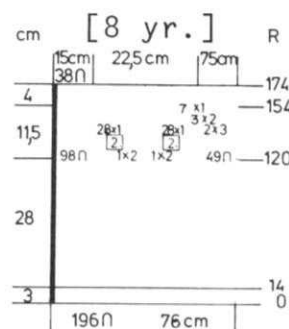
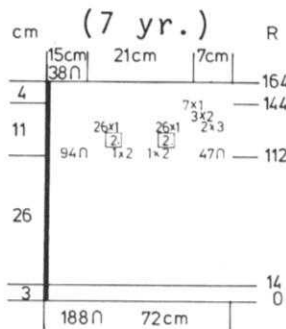
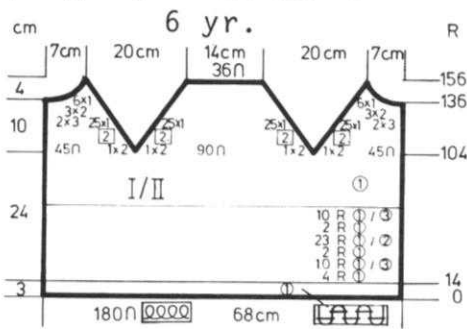

JACKET FRONT & BACK - Knitted in one piece.

Cast on 180 (188) [196] sts. with color 1 and work 14 rows K1, P1 Ribbing. Transfer the Ribber sts to the main machine and continue the Norwegian Design following the Chart for the Color Changes. After Row 104 (112) [120], continue in Stockinette stitch with color 1. ON EACH SIDE, remove 45 (47) [49] sts. onto contrast waste yarn and complete the back section first. ON EACH SIDE, bind off 2 sts. 1x then every 2nd row, decrease 1 st. 25x (26x) [28x]. After Row 156 (164) [174], bind off the remaining sts. Hang one side held on waste yarn back onto the machine, put Row Counter to 104 (112) [120] and complete this section, following the Chart for the armhole shaping then the neck shaping. Repeat for other half of front.

COVERALLS: Make 1, reverse 1.

With color 1, cast on 100 (106) [116] sts. and work Stockinette stitch to Row 32. Continue in the Norwegian Design, changing the colors as shown on the Chart AND AT THE SAME TIME, ON EACH SIDE, decrease 1 st. every 26th row 3x on all sizes. After Row 79, continue in Stockinette stitch with color 1. After Row 110 (118) [126], ON EACH SIDE, increase 1 st. every 8th row 9x for all sizes. After Row 190 (200) [210], PLEASE FOLLOW THE CHART IN YOUR SIZE for the DIFFERENT BIND-OFFS ON EACH SIDE. After Row 290 (300) [338], Divide in the center and work one side at a time, following the Chart for the different shapings and work a BUTTONHOLE by hanging stitch 4 and 5 onto adjacent needle after Row 348 (358) [368] on the front section. Continue to follow the chart for completion. Work the second section with reverse shaping



KK 660

CHILD'S HOODED JACKET & LEGGINGS

SIZES: 1 yr. (2 yr.)

YARN: Vienna

GRAMS: 300 350

TENSION: 6 to 8

GAUGE:

Stock: 14 sts. 20 rows = 5 cm (2")

Pat: 11 sts. 32 rows = 5 cm (2")

Leggings are in Stockinette stitch. The JACKET is a Tuck Stitch. Punch your own card or match design to one in your set or original (2D) Cards. AM 3 machine owners, use Wheel No. 6 (tweed stitch).

FINISHING: See General Instructions.

JACKET: Sew back seam of Hood then sew to Jacket- Work 1 row single crochet then 1 row reverse single crochet around all edges. Finish Buttonholes and sew on Buttons.

Leggings: Sew seams, turn hem at top of leggings. Work 1 row single crochet, 1 row reverse single crochet around arm edges. For STRAPS, cast on 16 sts. and work circular knitting 20 cm long. Decrease to a point, making 1 stitch decrease - both beds on every row.

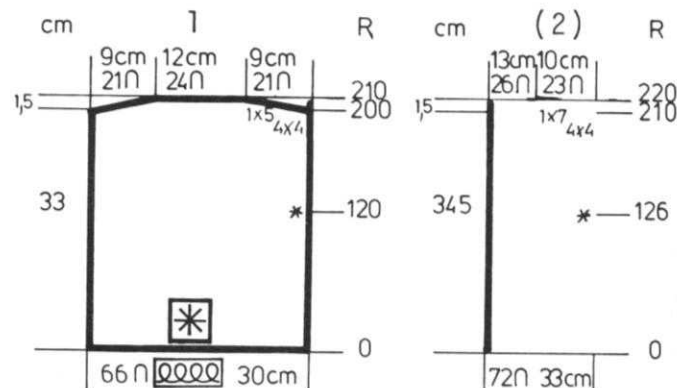

JACKET BACK:

Cast on 66 (72) sts. and work in Pattern. Mark each side for setting in Sleeves after Row 120 (126). Knit to Row 200 (210) SHAPE SHOULDERS: ON EACH SIDE bind off 4 sts. 4x, 5 sts. 1x, (4 sts. 4x, 7 sts. 1x). After Row 210 (220), bind off the remaining sts.



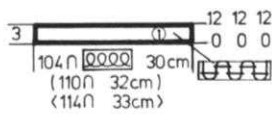
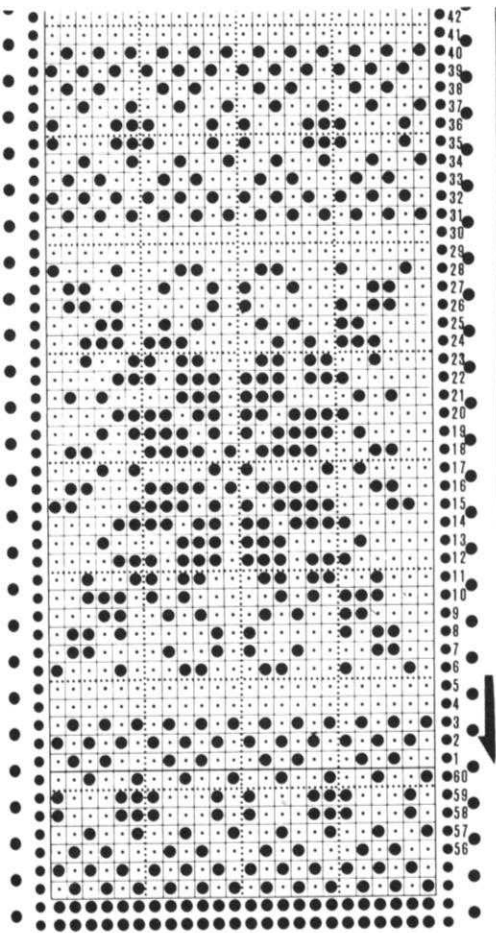

NECKBAND:
Cast on 104 (110) [114] sts. with color 1 and work 12 rows K1, P1 Ribbing. Bind off the crochet method for Ribbing.

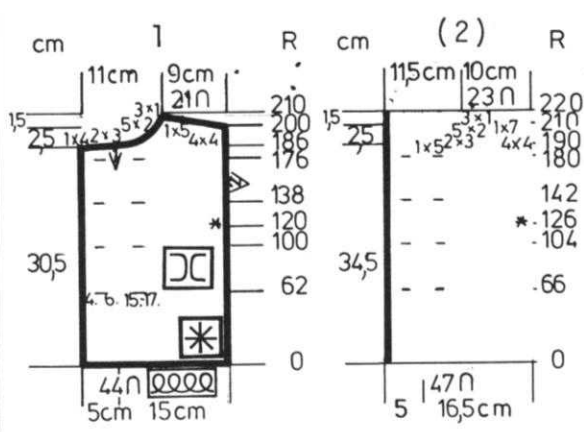

JACKET LEFT FRONT: Reverse right Front.

For a Girl, do NOT make BUTTONHOLES in this section as purl side is right side. For a Boy, make the BUTTONHOLES.

Cast on 44 (47) sts. and work in Pattern.
Mark Row 120 (126) for setting in sleeves.
After Row 185 (189), SHAPE NECK: Bind off
4 sts. 1x, 3 sts. 2x, 2 sts. 5x, 1 st. 3x - watch for shoulder shaping, (5 sts. 1x, 3 sts. 2x, 2 sts. 5x, 1 st. 3x) - watch for shoulder shaping, AT THE SAME TIME, after Row 200 (210) SHAPE SHOULDER same as the back. Work the RIGHT front with reverse shaping, and make BUTTONHOLES over needles 4 to 6 and 15 to 17 after Rows shown on the Chart for size you are knitting.

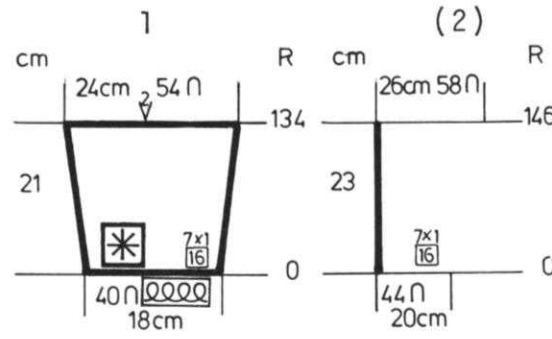

SLEEVES:

Cast on 40 (44) sts. and work in Pattern.
ON EACH SIDE, increase 1 st. every 16th row 7x.
After Row 134 (146), bind off.

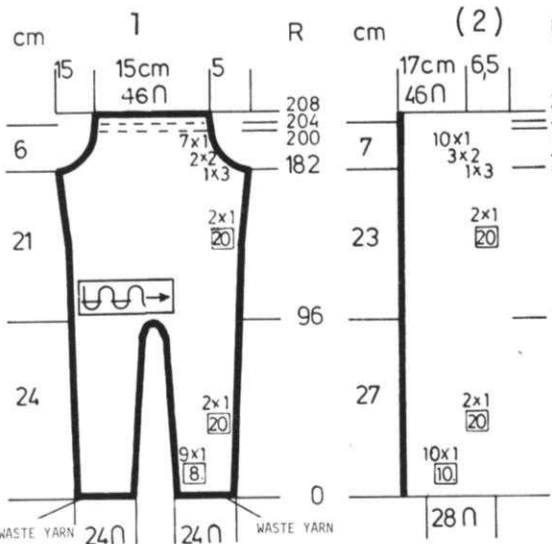

LEGGINGS: Make 2 sections.

With contrast waste yarn, cast on 24 (28) sts. Knit 8 to 10 rows, change to garment yarn and put Counter at 0.
ON INSIDE LEG edge, increase 1 st. every 8th row 9x (1 st. every 10th row 10x) and on OUTSIDE leg edge increase 1 st. every 20th row 2x for both sizes.
After Row 96 (108), remove the sts. onto contrast waste yarn. REPEAT THE INSTRUCTIONS from the beginning to Row 96, changing the sides for the inner and outer leg edges. After Row 96, hang the first leg back onto the machine with center legs facing and continue to knit over all the stitches.
ON EACH SIDE, increase 1 st. every 20th row 2x.
After Row 182 (200), SHAPE ARM-HOLES: ON EACH SIDE, bind off 3 sts. 1x, 2 sts. 2x, 1 st. 7x. (3 sts. 1x, 2 sts. 3x, 1 st. 10x). Mark Row 200 (224) for hemline then knit to Row 208 (232). Bind off.

HOOD:

With contrast waste yarn, cast on 38 (42) sts. and work 8 to 10 rows Stockinette stitch. Change to garment yarn, put Counter at 0 and work in Pattern.
ON THE RIGHT, increase 1 st. every 10th row 12x.
After Row 160 (166), mark each side for center of hood.
ON THE RIGHT, DECREASE 1 st. every 10th row 12x.
After Row 320 (332) remove the sts. onto contrast waste yarn.

HEEL - for Leggings

Hang 24 sts. from one back leg held on waste yarn, back onto the machine and work SHORT ROWS: ON OPPOSITE SIDE OF CAM BOX, put into holding position 1 st. 4x ON EACH SIDE. Return the sts. in the same way. Leave them on the machine, then for FOOT & TOE, hang the 24 sts. of the front onto the Ribber. Work 26 (34) rows CIRCULAR. SHAPE TOE: Decrease 1 st. on EACH BED 5x ON EACH SIDE. Remove the sts. onto end of yarn and pull up.

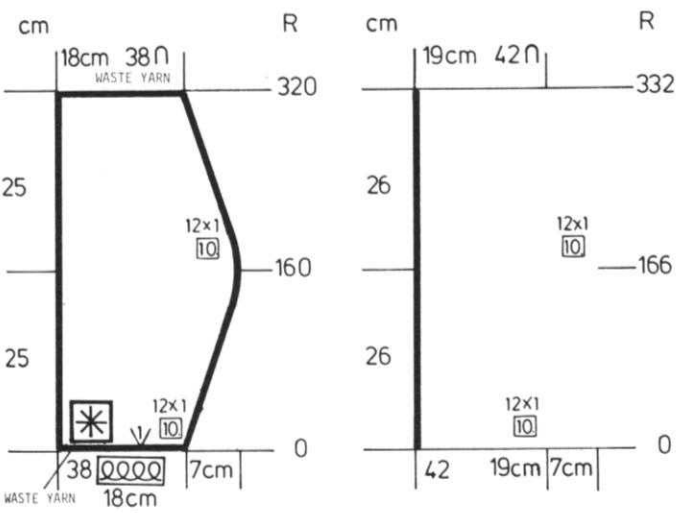

KK 661

PONCHO

SIZE: TEEN
 YARN: Binia & Allegro
 GRAMS:
 color 1 200 - Binia
 color 2 100 - Binia
 color 3 100 - Binia
 color 4 100 - Allegro
 color 5 100 - Binia
 color 6 100 - Allegro
 TENSION: 10
 GAUGE: 12 sts. 17 rows = 5 cm (2")

A Norwegian Design with color stripes. Punch your own Card and follow the Chart for the color changes, REPEATING from X marked row.
 AM 3 machine owners, use your Adjustable Needle Selector for the Norwegian Design. The Yoke is K1, P1 Ribbing.

FINISHING: Weave seams, leaving an opening for arms then sew on facing. Make twisted cord for tie.

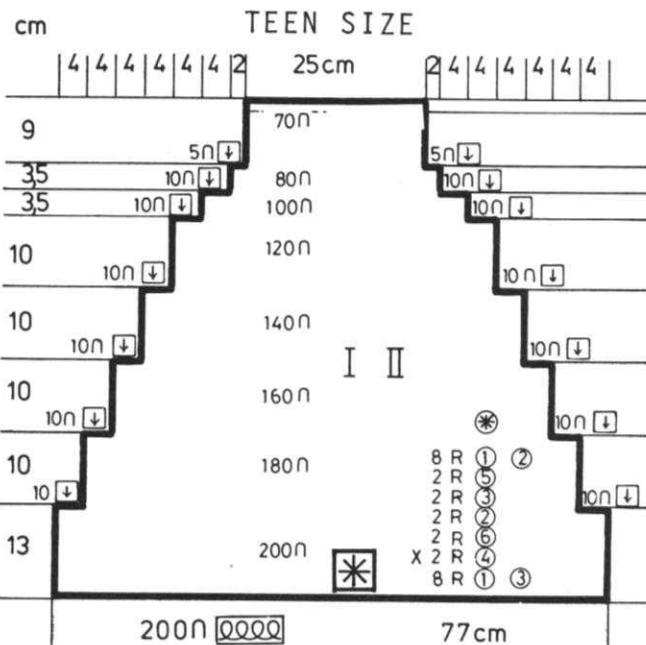

R MAKE 2 SECTIONS.

206 Cast on 200 sts. with color 1 and work in the Norwegian Design following the Chart for the Color changes.
 200 After Row 40, remove the sts. onto contrast waste yarn and hang them back onto the machine, decreasing 20 sts. evenly across.
 180 After Rows 70, 100, 130, 160, 170, 180, remove the sts. as you did before and rehang them onto the machine decreasing 20 sts. evenly across. After Row 180, remove the sts. once again onto waste yarn and hang them back, this time decreasing 10 sts. evenly across.
 160 Transfer every other stitch to the Ribber and work K1, P1 Ribbing to Row 200. Make EYELETS by transferring every 12th st. to the 13th st. and leave empty needles in work. Knit to Row 206. Bind off loosely the crochet method for Ribbing.

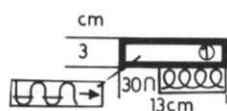

R ARMHOLE FACING: Make 4.
 Cast on 30 sts. with color 1 and work 14 rows Stockinette stitch then bind off.

KK 662

PONCHO

SIZE Adult
 YARN: Binia & Allegro
 GRAMS:
 color 1 300 - Binia
 color 2 150 - Binia
 color 3 150 - Binia
 color 4 150 - Allegro
 color 5 150 - Binia
 color 6 150 - Allegro
 TENSION: 10
 GAUGE: 12 sts. 17 rows = 5 cm (2")

A Norwegian Design with color stripes. Punch your own Card and follow the Chart for the color changes, REPEATING from X marked row.

AM 3 machine owners, use your Adjustable Needle Selector for the Norwegian Design. The Yoke is K1, P1 Ribbing.

FINISHING: Weave seams, leaving an opening for arms then sew on facing. Make twisted cord for tie and pull through eyelets at neckline.

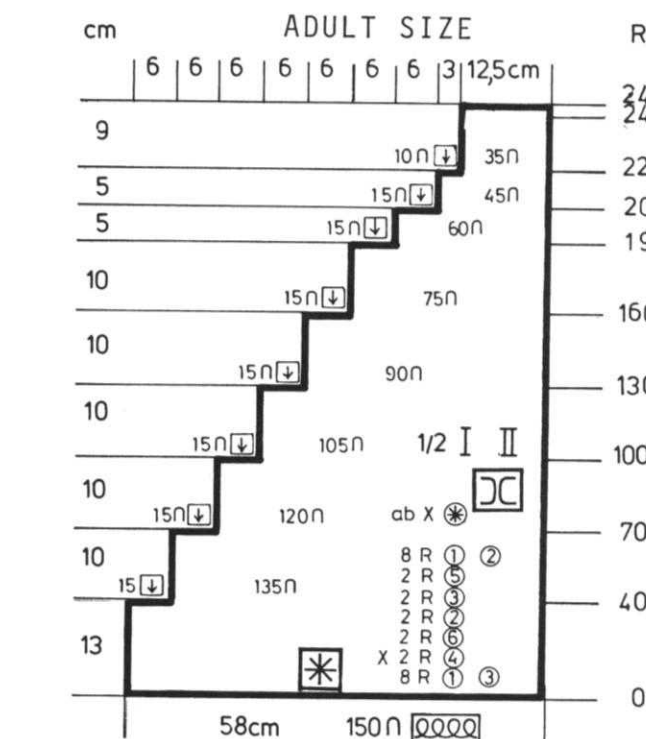

R MAKE 4 SECTIONS - but BE SURE THAT CENTER FRONTS & BACKS MATCH in Pattern

248 Cast on 150 sts. with color 1 and work the Norwegian Design with color changes as shown on the Chart.
 240 Remove the sts. onto contrast waste yarn after Rows 40, 70, 100, 130, 160, 190, 205 then hang them back onto the machine decreasing 15 sts. evenly across each time.
 205 After Row 220, remove the sts. once again onto contrast waste yarn then hang them back, decreasing 10 sts. evenly across.
 190 Transfer every other stitch to the Ribber and work 20 Rows K1, P1 Ribbing. MAKE EYELETS across by transferring every 12th st. to 13th st. and leave empty needles in work. Knit 6 more rows then bind off loosely the crochet method for Ribbing.

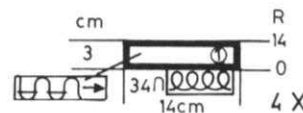
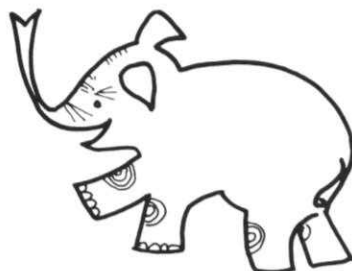

ARM SLIT FACINGS: Make 4.
 Cast on 34 sts. with color 1 and work 14 rows Stockinette stitch then bind off.

KK 663

CHILD'S PULLOVER

SIZES: 10 years.
 YARN: Allegro
 GRAMS: 350
 TENSION: 5 to 7
 GAUGE:
 Stock: 17 sts. 24 rows = 5 cm (2")
 Pat: 15 sts. 26 rows = 5 cm (2")



A Tuck Stitch Pattern with Ribbed Collar and Bands. Punch your own Card.

FINISHING: See General Instructions.

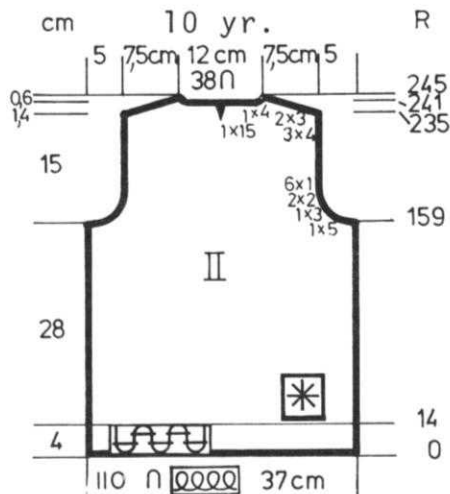
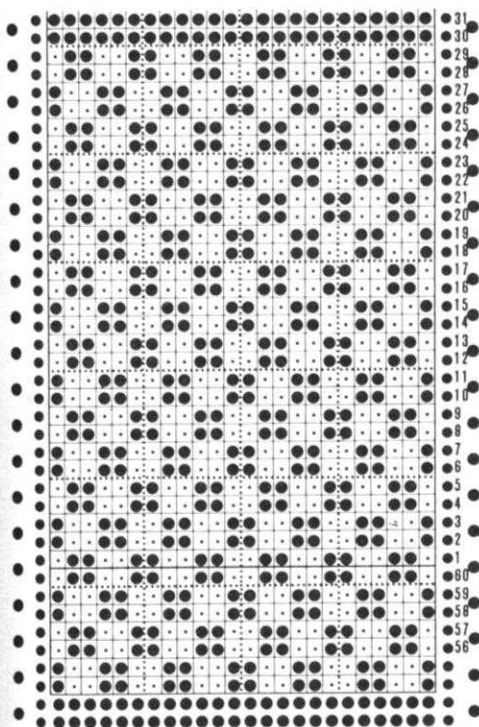

BACK: II

Cast on 110 sts. and work 14 rows K1, P1 Ribbing. Continue in Pattern. Knit to Row 159. SHAPE ARMHOLE: ON EACH SIDE, bind off 5 sts. 1x, 3 sts. 1x, 2 sts. 2x, 1 st. 6x. Knit to Row 235. SHAPE SHOULDER and watch for NECK SHAPING: ON EACH SIDE, bind off 4 sts. 3x, 3 sts. 2x, and AFTER ROW 241, put half the sts. on the right into holding position and complete the left side first. *ON NECK SIDE, bind off 15 sts. 1x, 4 sts. 1x. Bring the needles on the right into working position, knit 1 row in Pattern to the right side, turn the Row Counter back to 241 and complete the right half. Follow the instructions from * and don't forget to complete the shoulder shaping.

FRONT: I

Work the front the same as the back to Row 159. SHAPE ARMHOLES same as the back then knit to Row 215. Put half the sts. on the right into holding position and complete the left side first. *ON NECK SIDE, bind off 10 sts. 1x, 3 sts. 1x, 2 sts. 2x, 1 st. 2x and SHAPE SHOULDER same as the back. Bring the needles on the right into working position, knit 1 row in pattern to the right side, turn the Row Counter back to 215 and complete the right half. Follow the instructions from *.

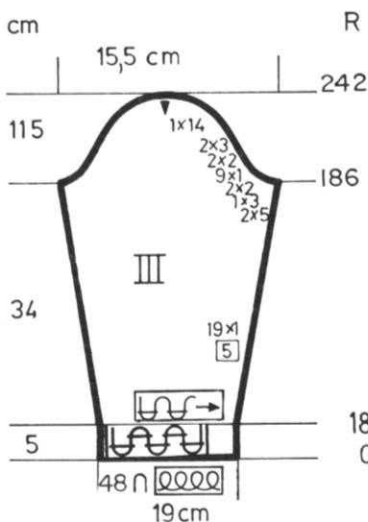
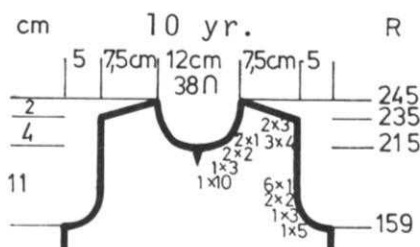

SLEEVES: III

Cast on 48 sts. and work 18 rows K1, P1 Ribbing. Continue in Stockinette stitch. ON EACH SIDE, increase 1 st. every 5th row 19x. After Row 186, SHAPE CAP: ON EACH SIDE, bind off. 5 sts. 2x, 3 sts. 1x, 2 sts. 2x, 1 st. 9x, 2 sts. 2x, 3 sts. 2x. After Row 242, bind off the remaining sts.

COLLAR:

Cast on 128 sts. and work 56 rows K1, P1 Ribbing then bind off the crochet method for Ribbing (loosely).

664

WALL HANGING WITH POCKETS

YARN: Amore
 GRAMS: 150 (should be sufficient for background color. Use left over yarn for the other colors. You will also need a piece of stiff fabric to mount the pockets 90 cm x 65 cm 35 1/2" x 25 1/2"). Punch your own cards. Put the Cards into the machine upside down so you can form hems. Use Norwegian Technique and begin on Row 60. TENSION 5 to 7
 GAUGE: 14 sts. 19 rows = 5 cm (2")



FINISHING: Hem edges of background fabric. Sew pockets in place after blocking carefully on the wrong side. Make 6 straps from the fabric and sew in place for hangers - see picture.

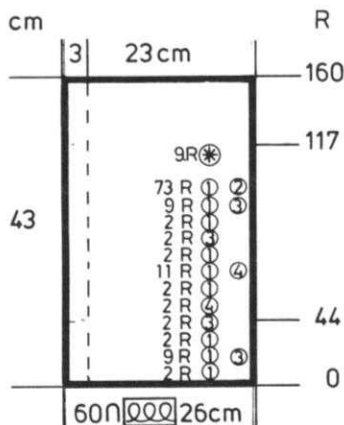

CAR: Make 1.

Cast on 60 sts. with color 1 and work the Norwegian design following the color changes as shown on the Chart. After Row 160, bind off. Make hem along edge as shown by broken line on chart.



664

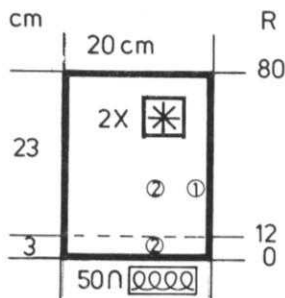
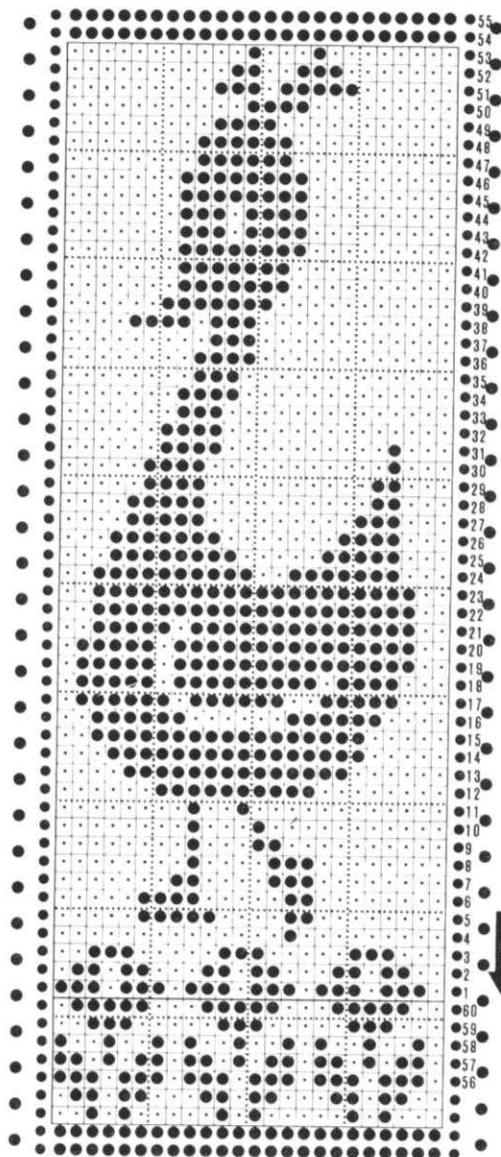

Make 2 of each.
 Cast on 50 sts. with color 3 and work 12 rows Stockinette Stitch. Form the hem then continue with Kitty Pattern in the Norwegian technique with color 1 and 3 to Row 80. Bind off (make 2 the same).
 Make 2 more with same number of stitches and rows, using color 1 and 4 and the DUCK PATTERN.

Besides these two Punch Cards, you can use any of the other Motifs that you will find throughout the Magazine....

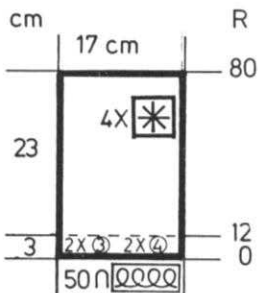
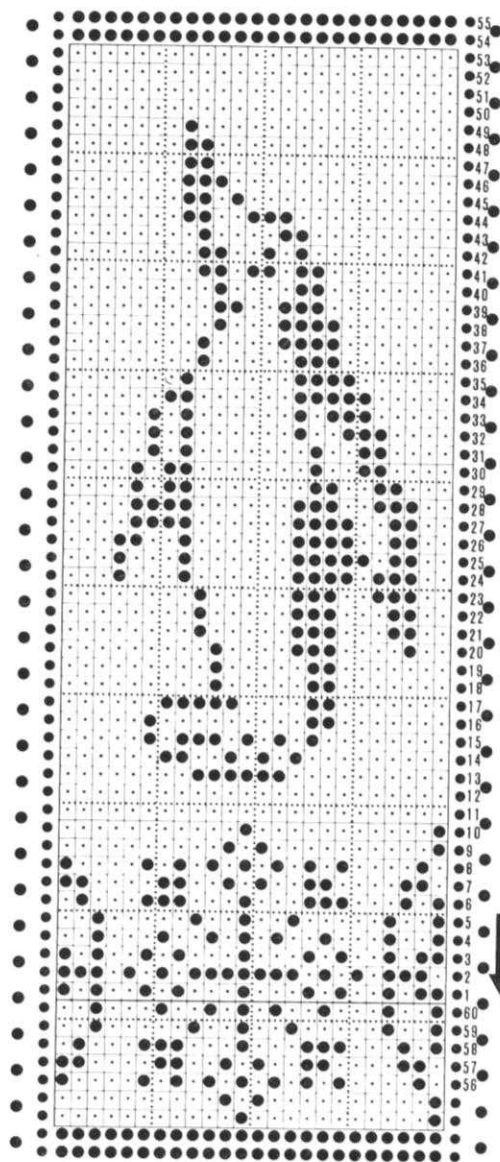

CHURCH: Make 2.
 Cast on 50 sts. with color 2 and work 12 rows Stockinette stitch. Form the hem then continue in the Norwegian Design. After Row 80, bind off.

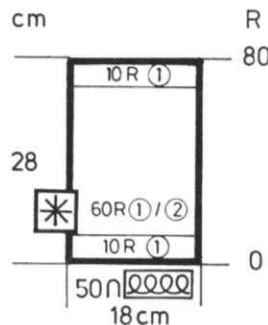

PICTURES
 Use LEFT OVER YARNS in colors of your choice.
 TENSION 5 to 7
 GAUGE: 14 sts. 19 rows = 5 cm (2")
 Suggested colors - Red, Black, Brown, Green & Blue.

FINISHING: Block carefully on the wrong side. Hide ends of yarn. Spray with stiffening then put into frames. See Pictures throughout magazine.

BACKGROUND:
 Cast on 50 sts. with color 1. Knit 10 rows Stockinette stitch then 60 rows of Pattern with color 1 and 2, 10 rows stockinette stitch with color 1. Bind off.



KNITKING NEWS

THIS 'NEW' NEWS is GOOD NEWS

During the more than 25 years that KNITKING has been importing, distributing and selling Knitting Machines, we have received many thousands of requests for a knitting machine made for knitting 4-ply worsted weight yarn and heavier... We have also received innumerable requests for a machine made primarily for knitting fine yarns... We in turn have asked our suppliers many many times to consider designing and making such machines.

Approximately two years ago we introduced into the U.S.A. the first JUMBO Knitter - the knitting machine with large needles made for knitting heavy yarns. It was an instant success and the demand during the first year was so great we had difficulty keeping it in stock. A new Model with some design improvements was introduced early this year and it too has been selling extremely well.

A few years ago, one of our suppliers designed and marketed (mainly in the Orient) a knitting machine with fine needles for knitting fine and light weight yarns. We tested its efficiency and found it to be good but decided we would wait for some design improvements before considering it as suitable for KNITKING to market it in the U.S.A... A few months ago, we received a sample of the new KH 120... It passed our tests with flying colors (we in fact flipped over it) and this fine machine now proudly carries the KNITKING name... We are offering it nationally for the very first time in this issue of KNITKING MAGAZINE.

The KNITKING KH 120 is a Push Button knitter with the new design Lacemaker (like the 830 Lacemaker) for making fine lace as well as standard lace. It has the same width of needle bed but with 3.5mm needle spacing as compared with the KNITKING KH 830 spacing of 4.5mm. The KH 120 has 258 needles and, using lovely KNITKING YARNS such as Crocus, Capriccio, Micaela, Amore, Venetia etc., at a tension to produce 8 sts. per inch, the new KNITKING KH 120 will knit 32 inches wide compared with 25 inches on a 200 needle machine. This of course makes it an obvious choice for the larger than average person.

The KNITKING KH 120 knits yarns from fine crochet thread to sport yarn and it makes absolutely exquisite lace designs... A two color plating finger is standard and weaving wheels are built in... There is a 258 needle Ribbing Attachment available and during our tests, we ribbed with a fine yarn using the entire 516 needles. It produced an excellent Fisherman's Rib, more than 6 inches wider than the 36 inch needle bed!! We knitted tubular using all of the needles... we knitted some fancy ribbed designs and some racking designs... Everything ran smoothly and all stitches were well formed.

KNITKING now has a knitter for all reasons!!! The KH 120 for fine yarns... the remarkable computerized KH 830 for all around knitting with yarns from light weight to 4-ply worsted... and the JUMBO CN 9 for knitting 4-ply worsted and heavier.

As is our practice, KNITKING is introducing and offering the KH 120 to Magazine Subscribers at a special inflation fighting discount price... The offer can only be made to U.S. readers which is why an insert with the special prices is included only in magazines sent to U.S. subscribers. We suggest that you place your order while stocks are good, and be one of the first to own an all new KNITKING KH 120.

PRACTICAL KNITTING HINTS

KK 639 - MAKE SOME CAST ON STRIPS

An OPEN CAST ON for the Sleeves on this Baby Pull-over can be easier for you if you make the cast on pieces separately and then just hang them onto the machine at the underarm where you need to cast on 40 sts. In fact, this method can be used in many other places and is especially great when you are working in a Pattern. Since you will need 4 strips for this little garment, why not make up the 4 separate strips and SAVE THEM for future use - and you WILL use them.

It is important that you use a similar weight yarn for your strips. Some people make strips in various weights and you can do the same. If you have a few strips made from a light weight yarn, a medium weight yarn and a heavier weight yarn, you are ready for open cast on's for use with any weight garment.

If you have some AMORE left overs in different colors, use this yarn for your strips as it is an excellent twisted yarn which can be washed and will not split because of its twist.

Now you are ready to make 4 strips. USE CLOSED CAST ON for cast on strips. With a light color Amore, cast on 50 sts. (We will use 50 sts. although you really only need 40) because we want to use the strips for other garments and 50 is a good number. Use Tension 7 or 8. Knit 6 rows then mark the tension by transferring 7 or 8 sts. to the next needle and leave the empty needles in work. Knit 6 more rows. With a bright contrast color yarn, knit 1 row. Change back to the original yarn and knit 12 rows. Bind off. Press the strip and secure all ends. Make 3 more strips the same.

You can now knit the little Pullover and when you reach Row 78 for the back, bring 40 needles ON EACH SIDE into working position for the sleeves and hang a cast on strip onto each side. Fold the strip with the purl side out so you can see the row of contrast sts. and hang 40 of them onto the machine needles. Knit 1 row over the newly cast on sts. using a piece of Ravel Cord (you can always use some rayon crochet thread if you do not have odd pieces of Ravel Cord). You are now ready to continue knitting but remember it is always a good idea to knit the first row over the newly cast on sts. in Stockinette stitch. This makes it easier for you to weave the open sts. together later on. When you have completed the garment and have woven the underarm seam, release the Ravel Cords at each end then pull them out... You still have your cast on strips for future use and they can be used ANYWHERE on a garment that calls for an OPEN CAST ON...

SPECIAL DISCOUNTS on YARN KITS for garments in this issue of KNITTING MAGAZINE are listed below and are available to our subscribers. Please remember that the special prices are only good until the next issue of the magazine.

DISCOUNTED KITS FOR THIS ISSUE

HP 636 - Yarn: Euro Sport			
SIZES:	36	(38/40)	
Regular Price	\$19.35	\$20.64	
Sale Price	14.51	15.48	
Shipping Costs	1.85	1.85	
DK 637 - Yarn: Euro Sport			
SIZES:	10/12	(14/16)	
Regular Price	\$19.35	\$20.64	
Sale Price	14.51	15.48	
Shipping Costs	1.85	1.85	
638 - Yarn: Amore & 1 spool Thread			
Pillow - Regular Price	\$ 4.23		
Sale Price	3.17		
Shipping Costs	.75		
Lampshade Cover - Regular Price 4.23			
Sale Price	3.17		
Shipping Costs	.75		
KK 639 - Yarn: Amore			
SIZES:	12 to 18 mo.	(2 years)	
Regular Price	\$8.94	\$8.94	
Sale Price	6.72	6.72	
Shipping Costs	1.50	1.50	
KK 640 - Yarn: Euro Sport			
SIZES:	12	(14)	
Regular Price	\$15.48	\$18.06	
Sale Price	11.64	13.58	
Shipping Costs	1.85	1.85	
KK 641 - Yarn: Micaela			
SIZES:	Infant 6 to 9 months		
Regular Price	\$ 5.97		
Sale Price	4.48		
Shipping Costs	1.25		
KK 642 - Yarn: Amore			
SIZES:	9 to 12 mo.	(13 to 16 mo.)	
Regular Price	\$ 7.45	\$ 8.74	
Sale Price	5.60	6.72	
Shipping Costs	1.50	1.50	
DK 643 - Yarn: Vienna			
SIZES:	10	(12)	[14]
Regular Price	\$35.80	\$39.38	\$42.96
Sale Price	26.85	29.54	32.22
Shipping Costs	1.85	2.50	2.50
KK 644 - Yarn: Vienna			
SIZES:	6 yr.	(7 yr.)	[8 yr.]
Regular Price	\$14.32	\$16.11	\$17.90
Sale Price	10.74	12.08	13.40
Shipping Costs	1.85	1.85	1.85
DK 645 - Yarn: Venetia			
SIZES:	8/10	(12)	[14]
Regular Price	\$47.51	\$47.51	\$47.51
Sale Price	35.63	35.63	35.63
Shipping Costs	2.25	2.25	2.25
DK 646 - Yarn: Vienna			
SIZE:	Adult		
Regular Price	\$14.32		
Sale Price	10.74		
Shipping Costs	1.65		
KK 647 - Yarn: Euro Sport			
SIZES:	4/5	(6)	[7]
Regular Price	\$ 3.87	\$ 3.87	\$ 3.87
Sale Price	2.90	2.90	2.90
Shipping Costs	1.25	1.25	1.25
KK 648 - Yarn: Vienna			
SIZES:	Pre-Teen	Small	Medium
Regular Price	\$16.11	\$16.11	\$16.11
Sale Price	12.08	12.08	12.08
Shipping Costs	1.85	1.85	1.85

KK 649 - Yarn: Amore			
SIZES:	2	(4)	[6]
Regular Price	\$11.92	\$13.41	\$13.41
Sale Price	8.96	10.06	10.06
Shipping Costs	1.85	1.85	1.85

HP 650 - Yarn: Fortissima			
SIZES:	38	(40)	[42]
Regular Price	\$15.90	\$17.49	\$19.08
Sale Price	11.90	13.09	14.28
Shipping Costs	1.85	1.85	1.85

DK 651 - Yarn: Cheri			
SIZES:	12	(14)	[16]
Regular Price	\$21.33	\$21.33	\$21.33
Sale Price	16.00	16.00	16.00
Shipping Costs	1.50	1.50	1.50

KK 652 - Yarn: Binia			
SIZES:	8	(10)	[12]
Regular Price	\$11.12	\$11.12	\$12.51
Sale Price	8.32	8.32	9.36
Shipping Costs	1.85	1.85	1.85

KK 653 - Yarn: Binia			
SIZES:	1	(2)	[3]
Regular Price	\$15.29	\$16.68	\$18.07
Sale Price	11.44	12.48	13.52
Shipping Costs	1.85	1.85	1.85

654 - NO KIT for Hassock

KK 655 - Yarn: Binia			
SIZES:	9 yr.	(10 yr.)	[11 yr.]
Regular Price	\$18.07	\$19.46	\$20.85
Sale Price	13.52	14.56	15.60
Shipping Costs	1.85	1.85	1.85

KK 656 - Yarn: Amore			
SIZES:	6 yr.	(7 yr.)	[8 yr.]
Regular Price	\$26.82	\$28.31	\$29.80
Sale Price	20.12	21.23	22.35
Shipping Costs	1.85	1.85	1.85

KK 657 - Yarn: Amore			
SIZES:	10 yr.	(11 yr.)	[12 yr.]
Regular Price	\$ 8.94	\$10.43	\$11.92
Sale Price	6.72	7.84	8.96
Shipping Costs	1.85	1.85	1.85

KK 658 - Yarn: Amore			
SIZES:	9 yr.	(10 yr.)	[11 yr.]
Regular Price	\$23.84	\$26.82	\$29.80
Sale Price	17.88	20.12	22.35
Shipping Costs	1.85	1.85	1.85

KK 659 - Yarn: Binia			
SIZES:	6 yr.	(7 yr.)	[8 yr.]
Regular Price	\$20.85	\$22.24	\$26.41
Sale Price	15.60	16.64	19.72
Shipping Costs	1.85	1.85	1.85

KK 660 - Yarn: Vienna			
SIZES:	1	(2)	
Regular Price	\$10.74	\$12.53	
Sale Price	8.06	9.40	
Shipping Costs	1.50	1.50	

KK 661 - Yarn: Binia & Allegro			
SIZES:	Teen Size		
Regular Price	\$20.26		
Sale Price	15.20		
Shipping Costs	1.85		

DK 662 - Yarn: Binia & Allegro			
SIZES:	Adult		
Regular Price	\$30.39		
Sale Price	22.79		
Shipping Costs	2.50		

KK 663 - Yarn: Allegro			
SIZES:	10 yr.		
Regular Price	\$11.13		
Sale Price	8.33		
Shipping Costs	1.50		

664 - 664a - NO KITS for Pictures & Wall Pockets.



647





KK 656

KK 657



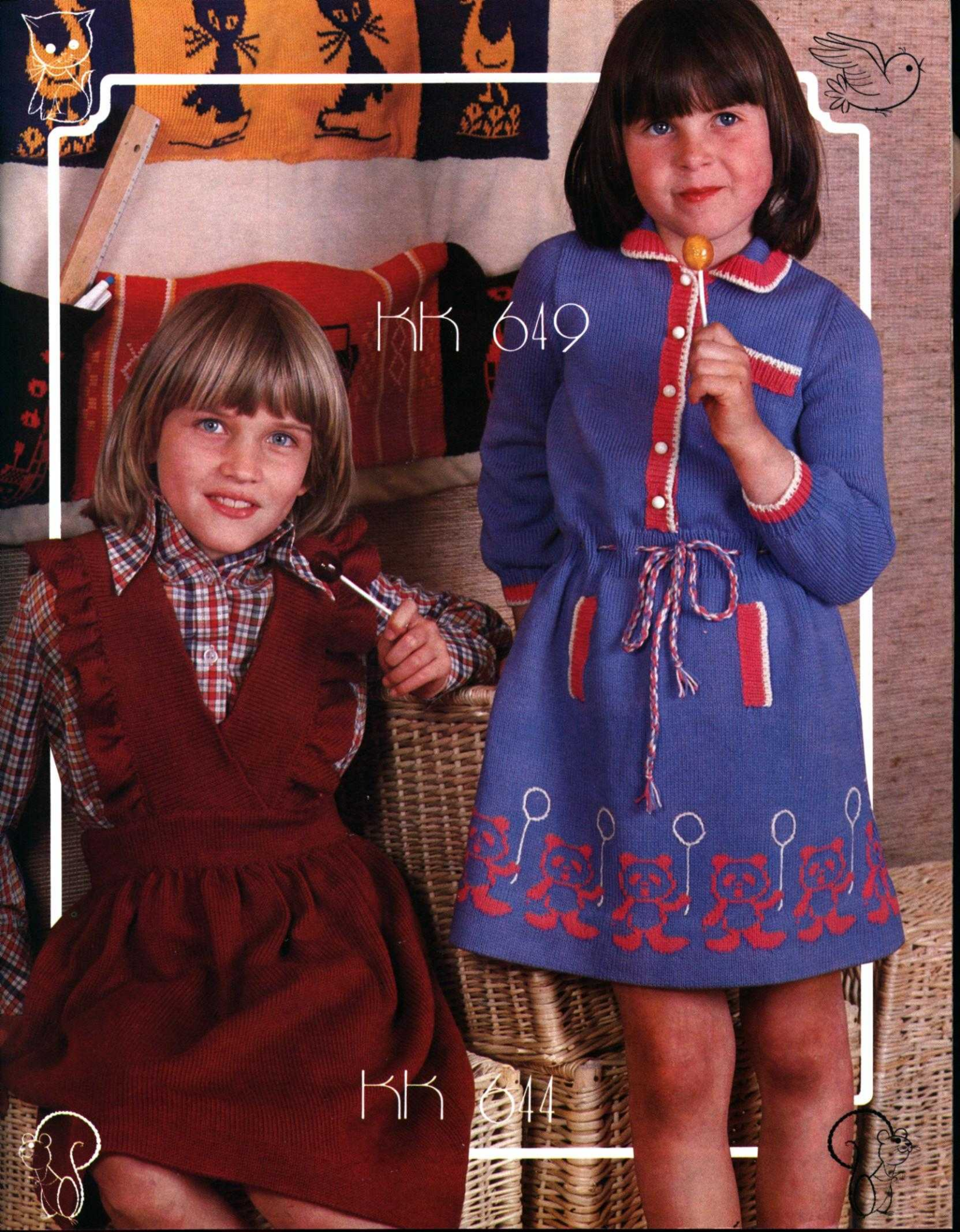

KK 649

KK 644



KK 663





КН 660





KK 640

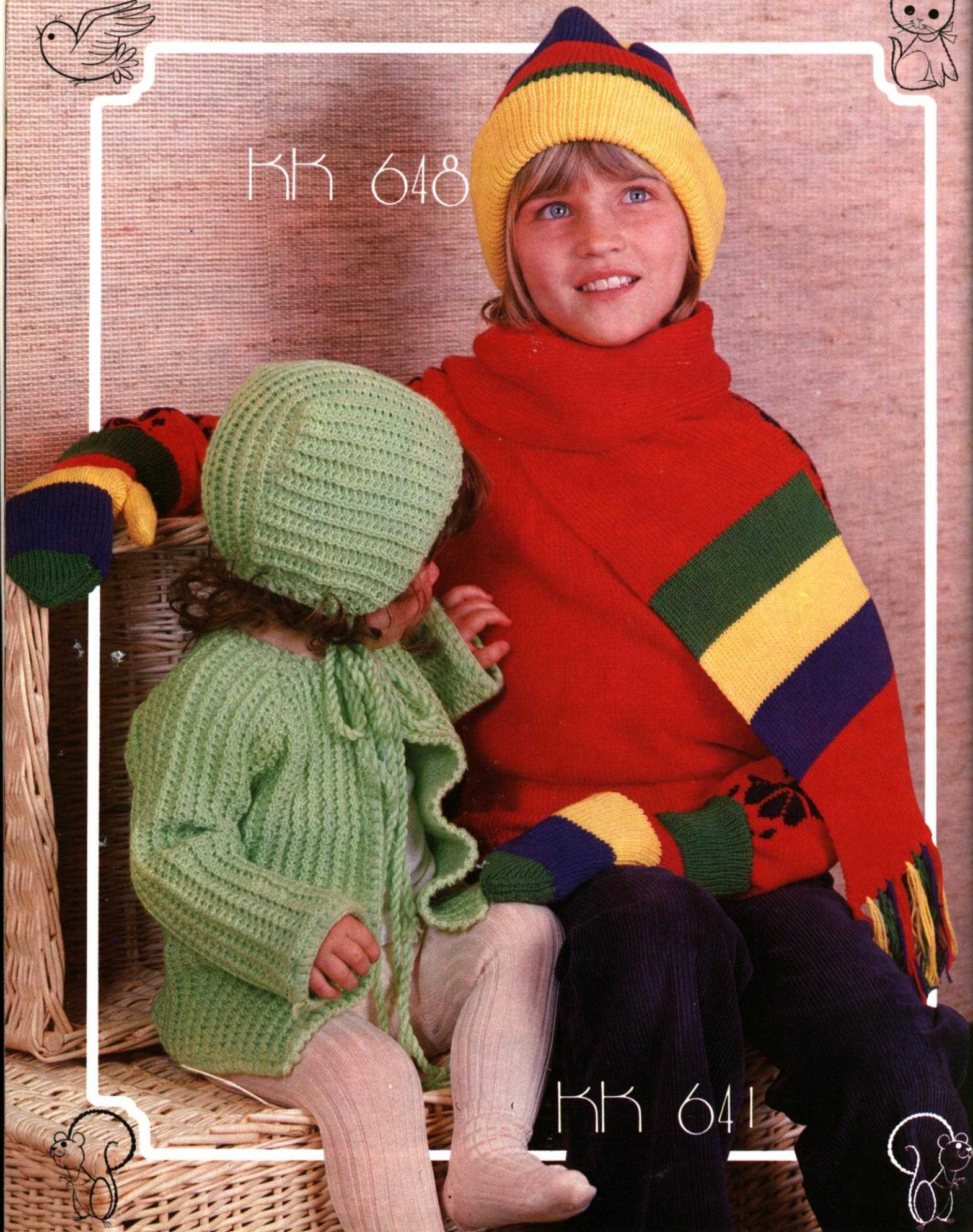

KK 641





KK 653

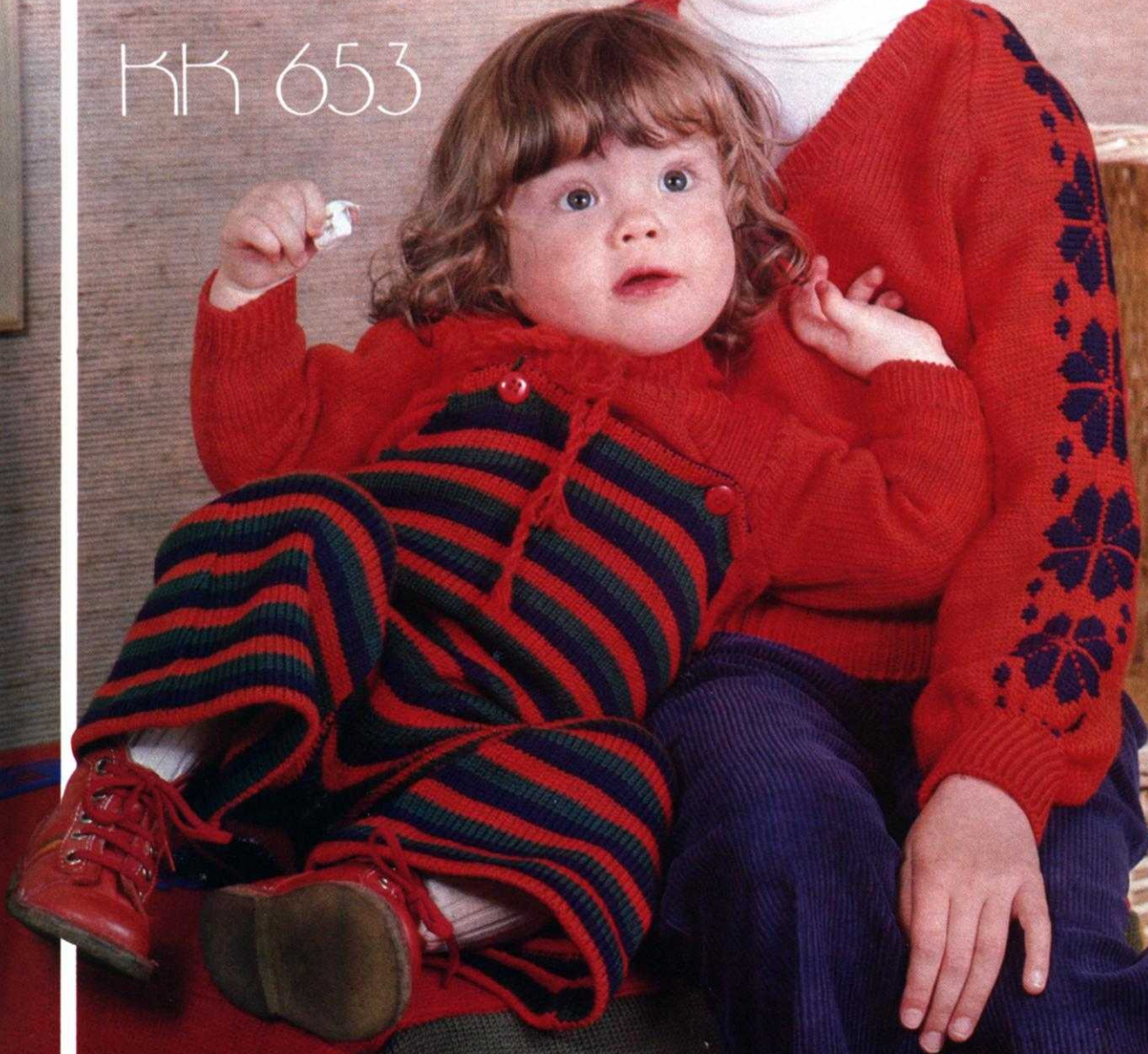

654

KK 652





KK 640





KK 655



654





KK 661



DK 662

