

knitking

magazine

nov/dec '73



Another first from Knitking!!!

THE ~~WHIZ KING~~ PATTERN READER with complete Charting Service

- With **WHIZ KING** you know exactly what to do without reference to written instructions.
- With **WHIZ KING** you no longer have to count rows . . . Your Pattern Chart turns automatically as you knit.
- With **WHIZ KING** you can knit even the most intricate patterns easily and speedily.
- With a **WHIZ KING** Pattern Reader, even the complete newcomer to machine knitting can immediately knit garments.
- With **WHIZ KING**, Charts are available from **KNITKING MAGAZINE** Patterns in the size of your choice.

PRICE: 59.50 Complete with instructions, practice Charts and illustrations of 50 complete Patterns for the entire family. (California residents add Sales Tax)
Shipping costs \$2.50.

ORDER DIRECT FROM **KNITKING** 1128 CRENSHAW BLVD. • LOS ANGELES, CALIFORNIA 90019

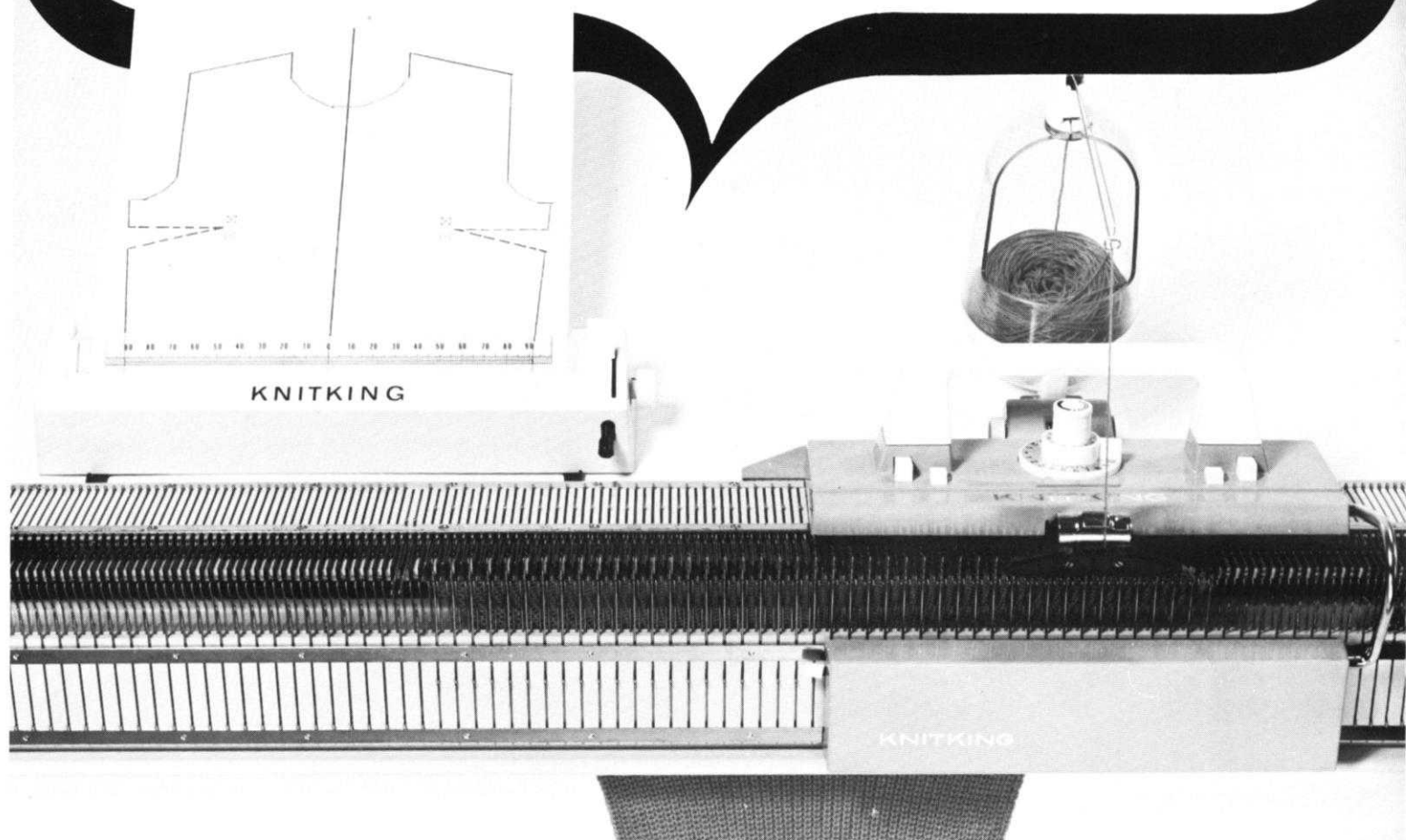

CHRISTMAS SALE

special

We had a multitude of problems with our Christmas Sale mailing last year...Despite the fact that the mailing went out early in November, large numbers of our readers never received it until January and February of 1973...!! We hope to avoid similar problems this year by including (for U.S. readers only) an order form listing Special Christmas Sale prices and an addressed envelope with this Christmas Edition of KNITKING MAGAZINE ...In order to accomodate illustrations of our products, we have increased the number of pages in this issue...You will not be receiving a separate Christmas Sale mailing, so please order as soon as possible in order to be sure of taking delivery before Christmas.

OUTSTANDING TRADE IN OFFER

Study page 32 and note the exceptional trade in deals..We are, at last, caught up on stocks of the sensational WHIZ KING Pattern Reader (illustrated on the inside front cover) and as we are confident that it will soon be indispensable to KNITKING owners, we are including one FREE with every KNITKING bought by KNITKING MAGAZINE subscribers during our Special Christmas Sale. This, of course, includes all readers who trade up to a new KNITKING and if you are trading a 197 needle KNITKING, the trade in offer is increased to \$125.00...This is a truly sensational offer...Don't miss it.

KNITKING DESKS

Due to a very substantial increase in price to us, we have been unable to offer handsome KNITKING DESKS to our customers during most of 1973 without feeling bad about the retail price...But, we have found another European manufacturer who is now making a superior desk at a more reasonable price..The retail price is \$189.50 (just \$20.00 more than our old price) and our Christmas Sale Price is only \$159.50..a saving to you of \$30.00. What a magnificent Christmas gift and suitable for most brands of knitting machines.

KNITKING ELECTRIC TABLES

We are caught up on back orders and have plenty of ELECTRIC TABLES in stock, so if you are ready for one, order now and save \$40.00.

KNITKING YARNS

There is a big discount on gorgeous top quality KNITKING YARNS during the Christmas Sale...Nowhere else in the U.S.A. will you get such magnificent quality yarns at our low prices...Be sure to order now while the prices are right.

BABY LOCK - MODELS 405 and 605

Model 405 BABY LOCK is especially designed for sewing knitted fabrics. It uses three threads in overlocking and is known as the BABY LOCK for professionals.. It also cuts (if you wish) as you overlock and makes perfect seams with as much stretch as you need... Order a 405 during the Christmas Sale and save \$40.00.

The 605 BABY LOCK uses four threads and is the one that cuts, sews and overlocks all at the same time, or separately... An absolute gem for any woman who likes to make her own clothes and it sews anything from fine georgettes and voiles to suiting materials... You save \$50.00 during the Christmas Sale.

ACCESSORIES SALE

Check the Order Form for big savings on KNITKING ACCESSORIES... Magnifying lights, JAC 40 accessories (when present stocks are exhausted, JAC 40 accessories will no longer be available for Japanese machines) Pattern Readers, Carrying Bags, Yarn Winders, (our new 110 volt Electric Winder is a beauty) Tables, etc., etc., etc.

Don't put off filling in your Order Form, do it now and avoid disappointment.

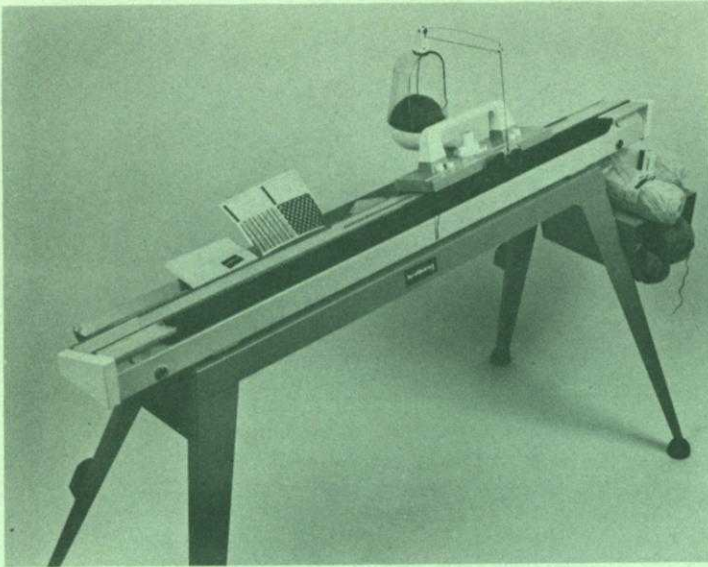

knitking table

Special Designed Table for KNITKING machines only. Sturdy All Steel construction with Tray in the rear for Tools, Books, etc., and Slots for inserting Pattern Cards. Storage box for yarns . . . Special spot welded brackets on the back legs for storing Ribbing Attachment . . . Heavy duty Rubber Feet to prevent Table from moving around.

List Price: **\$39.50**
(California residents add Sales Tax)
 Shipping — F.O.B. Los Angeles
 (Shipping weight approximately 25 pounds)

all purpose table

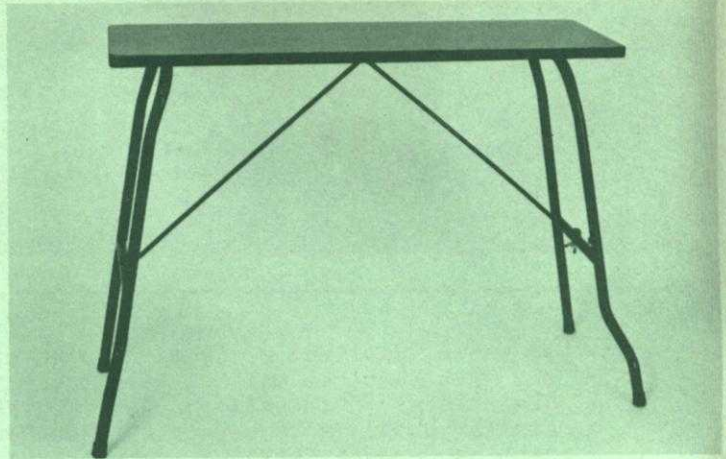

New design Knitting Machine Table for all types of machines (for Sewing Machines, too). Actual Table 48" long, 14" deep. Special Design legs to take heavy double beds or machines with Ribbing Attachments. Strong and sturdy. Walnut finish mar-proof top. Steel legs.

List Price: **\$42.50**
(California residents add Sales Tax)
 Shipping charges: F.O.B. Los Angeles



Handsome KNITKING DESKS are made by West German Craftsmen. The come in three different finishes —natural Walnut, natural Fruitwood and natural Oak . . . A spring loaded platform lifts your machine into position when you want to knit. When closed, the Desk is a useful piece of furniture.

List Price: **\$189.50**
(California residents add Sales Tax)
 Shipping charges: F.O.B. Los Angeles

knitking desk



knitking

magazine

INDEX

PAGE NO.

DV 8237	Hat and Scarf	9
DP 8225	Woman's Sweater and Hat	9
DP 8229	Woman's Pullover and Vest	10
DK 8232	Woman's Jumper and Pullover	12
DP 8231	Woman's Blouse	14
MK 5441	Girl's Skirt, Hat and Stockings	14
KK 5437	Child's Poncho and Hat	16
KG 1964	Baby Blanket	17
KG 1967	Afghan	18
KG 1973	Pillow or Pajama Bag	18
KG 1969	Shoulder Bag	19
KG 1970	Woman's Shawl	20
KG 1974	Baby Jacket and Bonnet	20
KG 1971	Lamp Shade Cover	21
KG 1966	Hanger Cover	21
KG 1975	Baby Carriage Cover	22
KG 1972	Slippers	22
KG 1968	Woman's Shrug	22
KG 1965	Baby Booties	22
HP 3704	Man's Sleeveless Pullover	23
HP 3703	Man's House Jacket	23
KK 5440	Child's Pullover, Pants and Tights	25
MK 5439	Girl's Pullover and Pants	26
KK 5438	Boy's Pullover, Pants and Hat	27
HP 3705	Man's Sleeveless Pullover	28
DP 8235	Woman's Vest	29
DP 8236	Woman's Pullover	30

knitking
magazine
nov/dec 73



A lively assortment of winter knits to make our KNITKING MAGAZINE friends happy. Gifts galore . . . to keep you busy right up to the coming Holidays . . . to save you a bundle . . . to avoid the rush and the crowds and make your shopping easy. Top your list with our Cover Model Scarf and Hat DV 8237 . . . knit it for a lucky member of your family or for a friend. Use KNITKING Beatrice Crepe.

BACK COVER

Make Sweater News . . . DP 8225. Wide stripes on the long sleeves simulate the layered fashion. A Tuck Stitch is the Pattern with Mock Ribbing for the Bands. Knit Sizes 10 and 14 with KNITKING Amore.

Publisher: KNITKING CORPORATION, 1128 Crenshaw Blvd., Los Angeles, Calif. 90019. Telephone: 213-938-2079. Published bi-monthly. Subscriptions: USA — \$7.00 annually, single copies \$1.50; Canada — \$8.00; other parts of the world — \$10.00. The entire contents of KNITKING MAGAZINE are copyright and must not be reproduced in any shape or form without the express permission, in writing of the publisher. COPYRIGHT © by KNITKING CORPORATION 1973.

Printed by William B. Wemyss Printing Associates, Los Angeles, Ca.

editorial

It is the festive season once more . . . The season of giving and receiving and despite all of the problems of the world, Christmas will once more see the greatest outpouring of Love and Joy and dollars and cents of the entire year . . . There are few greater pleasures than seeing loved ones open gifts that you have chosen for them and of sharing their happiness . . . There is a rather special pleasure in receiving a gift that somebody made with their own hands especially for you . . . This special Christmas edition of KNITKING MAGAZINE was prepared so that you, dear reader, can make something for each and everyone of your friends and relatives . . . We feature many things . . . from TV Slippers to luscious Dresses for women and handsome Pullovers and Sweaters for men . . . not forgetting, of course, charming gifts for children and grandchildren . . . If you have a special friend who also owns a knitting machine, what nicer gift could you give than an excellent KNITKING product . . . from simple Transfer Tools to Electric Yarn Winders, JAC 40 accessories, etc., or even a kilo of lovely KNITKING YARN.

Watch out for the January/February issue of KNITKING MAGAZINE, it will be chock full of lovely things in a luscious assortment of colors . . . There will be something for everybody . . . women, men, boys, girls . . . gift items, etc., etc . . . and our pages will retain the festive spirit displayed in this issue . . .

The entire staff of KNITKING take this opportunity to wish all our friends everywhere a happy holiday season and much success in 1974.





DP 8229 – A classic Pullover has extra dash when topped with a colorful striped Vest. Both are knitted in Stockinette Stitch with a 1 x 1 Rib for the Bands. Use Beatrice for Size 10, Crocus Crepe for Size 12, Dolly Dralon for Size 16.

DK 8232 – Always smart . . . a Jumper can have many faces . . . Wear it with its own bright Pullover or with a Blouse. The Jumper is knitted in a Norwegian design using 4 colors . . . the Pullover is in Stockinette Stitch. Knit Size 10 with Subita Crepe, Sizes 12 and 14 with Beatrice.

Chic and Misty

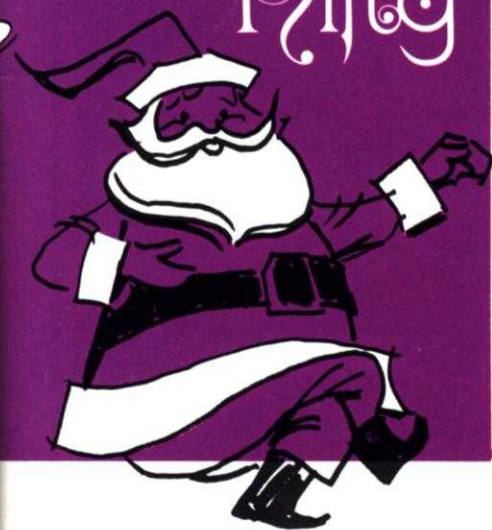



DP 8231. — A dressy Pullover has a place in any fashionable wardrobe. This one has a lovely Eyelet Design down the front section and on the sleeves. You can use jeweled buttons for sparkle. Size 16 is made with Crocus Crepe, Size 18 with Melodie, Size 20 with Allegro Dralon.





MK 5441 — From top to toe . . . a beautiful four piece outfit for a young girl. Knit the Hat, Skirt and Socks in a two-color Holding Position Design. Follow the Line Drawing or use JAC 40 and Pattern No. 75. The Pullover is in Stockinette Stitch with Ribbed Bands. Knit Size 6 with Beatrice; Sizes 8 and 10 with Allegro.





CHRISTMAS



GIFTS for everyone . . . are such fun to make and to give. We've really outdone ourselves in both quality and quantity of Gifts for you and your family. Check the INDEX PAGE in the front of this issue for the Instruction page numbers.

KK 5437 — For Boy or Girl . . . Easy on . . . easy off . . . Poncho, has a matching Hat. Designed for Sizes 4 and 6, you will need five colors of Allegro Dralon (machine wash and dry) for the Norwegian Design.



KG 1967



KG 1968

BAZAAR



- KG 1964 – Baby Blanket
- KG 1965 – Baby Booties
- KG 1966 – Hangers
- KG 1967 – Afghan
- KG 1968 – Shrug
- KG 1969 – Shoulder Bag
- KG 1970 – Shawl
- KG 1971 – Lamp Shade Cover
- KG 1972 – Slippers
- KG 1973 – Pillow -
Pajama Bag



KG 1964
KG 1965



KG 1966

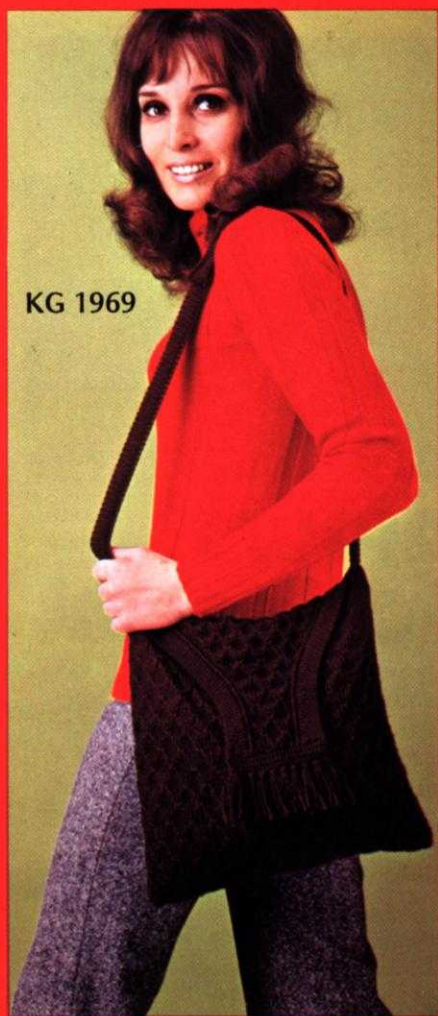

KG 1969



KG 1970

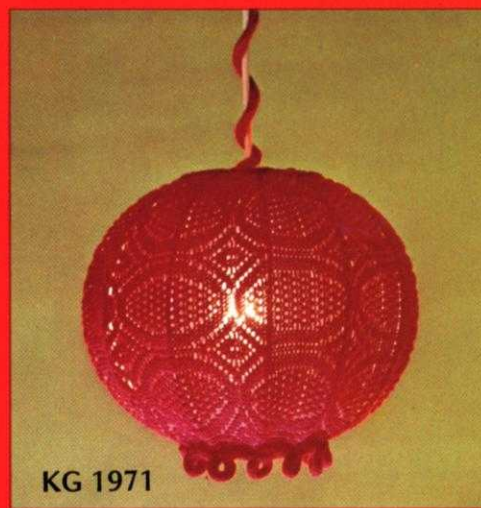

KG 1971



KG 1972

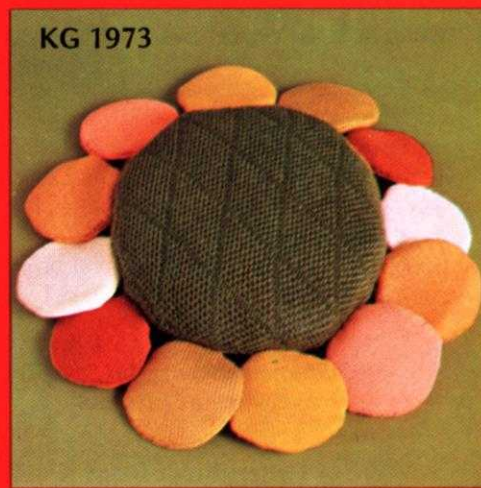

KG 1973

New products from KNITKING

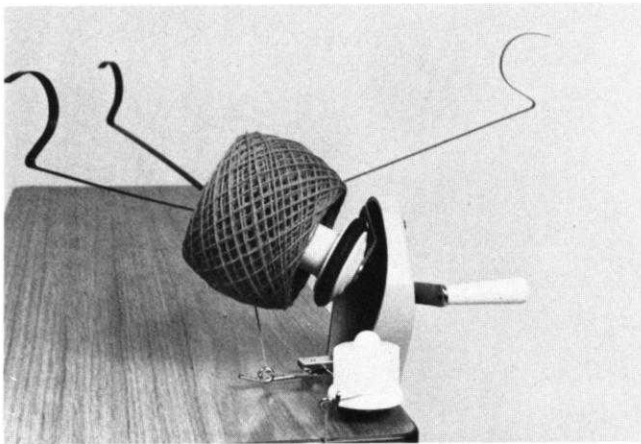

New design Yarn Winder with 'Waxamajig' and Skein Holder. As you can see from the illustration, this clever New Winder with Nylon Helical Gears winds a perfectly symmetrical ball. . . ! If you like to wax yarn (for easier knitting) you use the 'Waxamajig'. If waxing is not necessary, you bypass it . . . The Skein Holder is self adjusting. You will not find a better Hand Winder anywhere.

Complete price **\$23.95**
(California residents add Sales Tax)
 Shipping charges: \$1.75

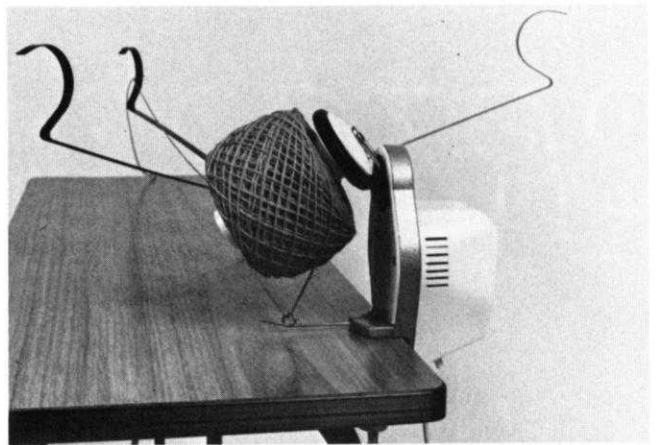

New design electric winder

Self-contained Motorized Winder (110/120 Volts) with Push Button on and off Switch . . . Special Clutch device to stop Winder if yarn bunches up or jams in the guide eye . . . Another excellent easy to use KNITKING product.

Price: Complete with Skein Holder **\$44.95**
(California residents add Sales Tax).
 Shipping Charges: \$2.50

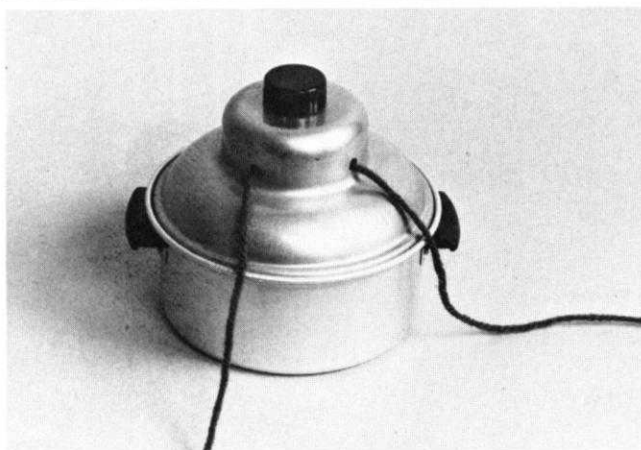

Yarn straightener

This Clever Steaming Device takes the wrinkles out of used Yarn and makes it like new again . . . The Yarn goes in one Hole, then around a Rotating Drum and out the other Hole . . . You fill the Lower Dish with water and heat it until it steams . . . It's the steam that does the straightening as you pull the Yarn through . . . You can wind by hand or directly onto your Yarn Winder.

List Price **\$ 5.95**
(California residents add Sales Tax)
 Shipping Costs: 80¢

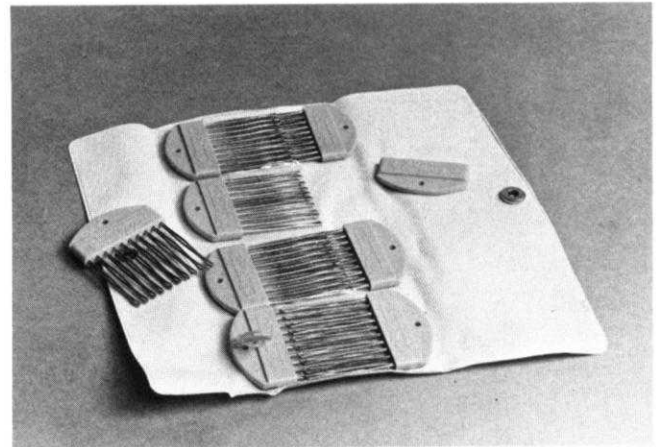

Carousel transfer tool set

With this Ingenious Set of 8 Transfer Tools, you can remove as few or as many stitches as you wish from your Knitter . . . The 8 Separate Units of 8 Stitch Tools are easy to handle . . . Use them instead of a contrasting color yarn to remove Knitting from your Machine . . . Use them as Transfer Tools . . . for Decreasing in the middle of rows, etc. . . . Suitable for all types of machines.

List Price **\$ 5.95**
(California residents add Sales Tax)
 Shipping Costs: 50¢

Order direct from KNITKING — 1128 Crenshaw Blvd., Los Angeles, California 90019



DP8237

MATERIAL: 50 gr. Balls Knitting Beatrice Crepe; 13 color 1, 1 color 2, 1 color 3, 1 color 4.
TENSION: 8 to 10. **GAUGE:** 13 sts., 28 rows = 2". **PATTERN:** Holding Position Design according to the Line Drawing, using Wheel No. 6. The purl side is the right side. **CAP TOP:** K1, P1, Ribbing.

FINISHING: **CAP:** Join the section at center back. Pull up the cast-on sts. and the open sts. held on the 2 strands of yarn, tie and sew the ends in. Double the cap and fold the lower edge to the outside. **SCARF:** Block to the measurements given, then attach fringe to the short ends.

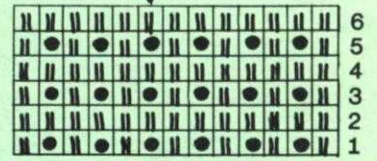
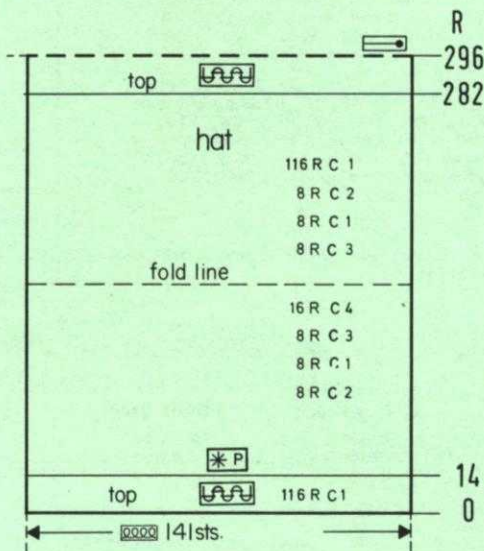
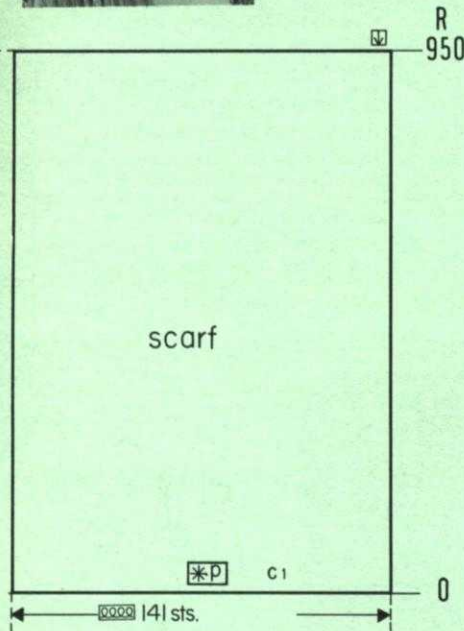

Using the automatic cast-on for Ribbing, (see Practical Knitting Hints Book, Page 78) cast on 141 sts. with color 1 and work K1, P1, Ribbing. Knit to Row 14, then transfer the ribber sts. to the main machine and work the Holding Position Design. Change color after Rows 116, 124, 132, 140, 156, 164, 172, 180. After Row 282 transfer every other st. to the ribber and work 14 rows K1, P1, Ribbing. After Row 296 transfer the ribber sts. back to the main machine, then transfer the 1st, 3rd, 5th, 7th, etc. sts. onto a length of yarn, then the 2nd, 4th, 6th, etc. sts. onto a length of yarn.

Cast on 141 sts. with color 1 and work the Holding Position Design. After Row 950 bind off all sts.

DP8225

- SIZE:** 10 (Bust 32½") 14 (Bust 35"-36")
- YARN:** Amore Amore
- 50 gr. BALLS:** 9 color 1 10 color 1
 3 color 2 4 color 2
 1 color 3 1 color 3
 1 color 4 1 color 4
- TENSION:**
- Stock:** 6 to 8 7 to 9
- Pattern:** 7 to 9 8 to 10
- GAUGE:** 2"
- Stock:** 15 sts. 23 rows 14 sts. 22 rows
- Pattern:** 13 sts. 35 rows 12 sts. 33 rows

Cast on 120 sts. with color 1, work stockinette st. and Short Rows. ON OPPOSITE SIDE of CAM BOX put into holding position 40 needles after Rows 0, 1. ON OPPOSITE SIDE of CAM BOX bring back into working position 10 needles after Rows 2, 3, 4, 5, 6, 7, 8, 9. ON EACH SIDE, increase 1 st. after Rows 16, 22, 28, 34, 40, 46, 52. ON EACH SIDE, decrease 1 st. after Rows 60, 66, 72, 78, 84, 90, 96, then knit to Row 102 and bind off all 120 sts.

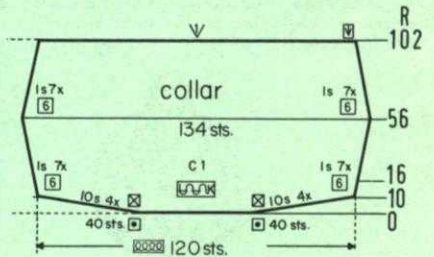

The instructions are the same for both sizes. **PATTERN:** Sleeves, Collar, Front Bands and Top of Cap: Stockinette Stitch worn on the knit side: Fronts, Back and Main Section of the Cap: Holding Position Design worn on the purl side. Use Wheel No. 6 and place the Gate Cam Release Lever to the needle heels, bring the 2nd, 4th, 6th, etc. needles into holding position, knit 1 row. Bring the needles back into working position, knit 1 row. Repeat the 2 rows for the Pattern Stitch. Push in the right Retractor Button to bring the needles back into working position. Edges: Mock Ribbing. (3 needles in working position, 1 needle in the non-working position). **DECREASES:** Hang the 3rd st. onto the 2nd st., then move the end sts. inward to fill the empty needle. **INCREASES:** Move the 2 end sts. 1 needle outward, then place the 3rd st. from the row below onto the empty needle. To form the hem on the Mock Ribbing, see practical hint in the news letter.

FINISHING: Block all sections. **SWEATER:** Join back and front sections at sides and shoulders. Sew the sleeves together and set in. Turn under 18 rows on the sleeve edges and hem in place. Sew 1 edge of the buttonhole band to inside and 1 edge to outside of the right front edge. Sew the button band to the left front edge in the same manner. Fold the collar in half and sew the front edges together. Sew 1 edge of the collar to inside and 1 edge to outside of the neckline. Finish the buttonholes, sew on buttons. **CAP:** Join the section at center back. Pull up the sts. held on the length of yarn, tie and sew in the ends. Fold the ribbed edge to the outside.



Bring 47 needles into working position, hang 2 sts. onto each needle, remove the contrast waste yarn and turn the Row Counter back to 156. Work stockinette st. to Row 170, then transfer all 47 sts. onto a length of yarn.

Bring 94 needles into working position, with knit side facing you, hang 1 st. onto one needle and 2 sts. onto the following needle all the way across, remove the contrast waste yarn and turn the Row Counter back to 142. Work stockinette st. to Row 156, knit several rows with contrast waste yarn and remove the knitting from the machine.

ROWS 37 to 142: Knit even, then replace the Gate Cam Release Lever, knit several rows with contrast waste yarn and remove the knitting from the machine.

ROWS 0 to 36: Knit even, then form the hem, place the Gate Cam Release Lever to the needle heels and work the Pattern Stitch over ALL 141 needles.

Bring 141 needles into working position, put every 4th needle into the non-working position and with color 2 cast on for the Mock Ribbing.

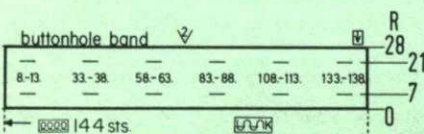

Cast on 144 sts. with color 1 and work stockinette st. Make buttonholes after Rows 7 and 21 over the 8th-12th, 33rd-38th, 58th-63rd, 83rd-88th, 108th-113th, 133rd-138th sts. counting from the left side. After Row 28 bind off all sts. Work the button band the same, but omit the buttonholes.

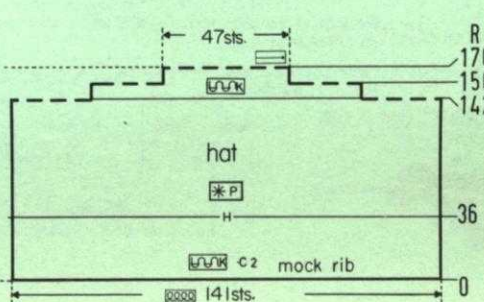

DP 8225

Continued from page 9

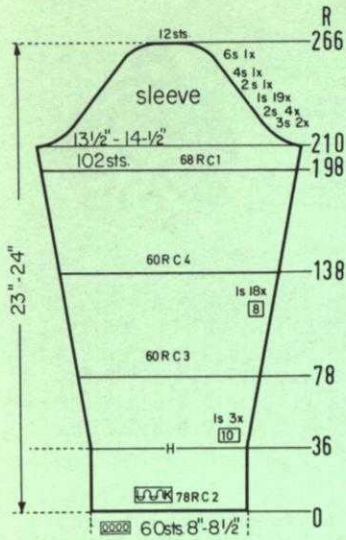

ON CAM BOX SIDE, bind off 3 sts. after Rows 210, 211, 212, 213; 2 sts. after Rows 214, 215, 216, 217, 218, 219, 220, 221. ON EACH SIDE, hang the 1st st. onto the 2nd st. after Rows 222, 224, 226, 228, 230, 232, 234, 236, 238, 240, 242, 244, 246, 248, 250, 252, 254, 256, 258. ON CAM BOX SIDE, bind off 2 sts. after Rows 260, 261; 4 sts. after Rows 262, 263; 6 sts. after Rows 264, 265; 12 sts. after Row 266.

ON EACH SIDE, increase 1 st. after Rows 36, 46, 56, 66, 74, (change color after Row 78), 82, 90, 98, 106, 114, 122, 130, 138, (change color after Row 138), 146, 154, 162, 170, 178, 186, 194, (change color after Row 198), 202, then knit to Row 210.

ROWS 0 to 36: Knit even.

Cast on 60 sts. with color 2 and work stockinette st.

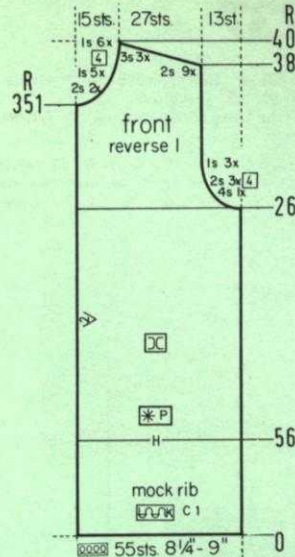

Work the second front section with reverse shapings. Cast on the same way as for the first front section, knit the band, form the hem, knit 1 row in PATTERN to the left side, turn the Row Counter back to 56. (The Cam Box will be on the LEFT side at even numbered rows).

ON CAM BOX SIDE, bind off 2 sts. after Rows 351, 353; 1 st. after Rows 355, 357, 359, 361, 363, 365, 369, 373, 377, 381, 385. For SHOULDER bind off 2 sts. after Rows 386, 388, 390, 392, 394, 396, 398, 400, 402; 3 sts. after Rows 404, 406, 408.

ON CAM BOX SIDE, bind off 4 sts. after Row 260; 2 sts. after Rows 264, 268, 272; 1 st. after Rows 276, 280, 284, then knit to Row 351.

ROWS 57 to 260: Knit even.

ROWS 0 to 56: Knit even, then form the hem, place the Gate Cam Release Lever to the needle heels and work the Pattern Stitch over ALL 55 needles.

Bring 55 needles into working position, put every 4th needle into the non-working position and with color 1 cast on for the Mock Ribbing.

DP 8229

SIZE:	10 (Bust 32 1/2")	12 (Bust 34")	16 (Bust 37"-38")
YARN:	Beatrice Crepe	Crocus Crepe	Dolly Crepe
50 gr. BALLS:	10 color 1 2 color 2	13 color 1 3 color 2	12 color 1 3 color 2
TENSION:	5 to 7	7 to 9	8 to 10
GAUGE:	2" 16 sts. 22 rows	15 sts. 21 rows	14 sts. 20 rows

The instructions are the same for all sizes. PATTERN: Pullover: Stockinette Stitch. Vest: Stockinette Stitch with repeated color stripes as marked in the Diagrams. ALL Edges: K1, P1, Ribbing. INCREASES: Move the 2 end sts. 1 needle outward, then place the 3rd st. from the row below onto the empty needle.

FINISHING: Block all sections. PULLOVER: Join the front and back section at sides and shoulders. Sew the sleeves together and set in. Join the short ends of the collar, then sew 1 edge of the collar to inside and 1 edge to the outside of the neckline. VEST: Join the back and front sections at sides. Sew the front bands in place. Join the neckband sections at center back and the armhole bands at short ends. Sew the back portion of the neckband to the back neckline. Beginning on the back shoulders, join about 4 1/2" of the armhole bands to 4 1/2" of the front portion of the neckband. (See picture). Sew the remainder of the bands in place.

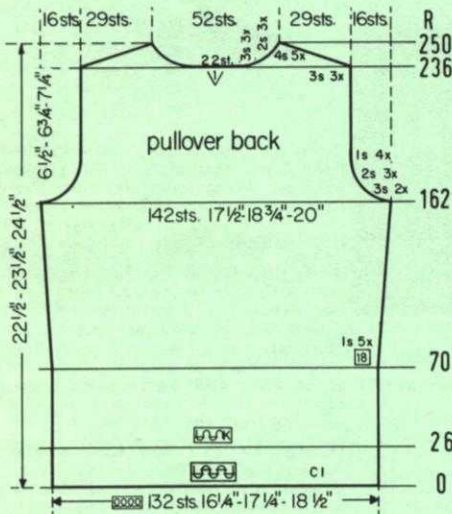

Move the Cam Box to the left side, turn the Row Counter back to 236 and complete the left half. Follow the instructions from*.

*ON CAM BOX SIDE, bind off 3 sts. after Rows 236 (EVEN ROWS = SHOULDER SHAPING), 237 (ODD ROWS = NECK SHAPING), 238, 239, 240, 241; 4 sts. after Row 242; 2 sts. after Row 243; 4 sts. after Row 244; 2 sts. after Row 245; 4 sts. after Row 246; 2 sts. after Row 247; 4 sts. after Rows 248, 250.

ON CAM BOX SIDE, bind off 3 sts. after Rows 162, 163, 164, 165; 2 sts. after Rows 166, 167, 168, 169, 170, 171; 1 st. after Rows 172, 173, 174, 175, 176, 177, 178, 179, then knit to Row 236, bind off the center 22 sts., put the needles on the left side into holding position and complete the right half first. (For the Front Section knit to ROW 210).

ON EACH SIDE, increase 1 st. after Rows 70, 88, 106, 124, 142, then knit to Row 162.

ROWS 27 to 70: Knit even.

ROWS 0 to 26: Knit even, then change to stockinette st.

Cast on 132 sts. with color 1 and work K1, P1, Ribbing.

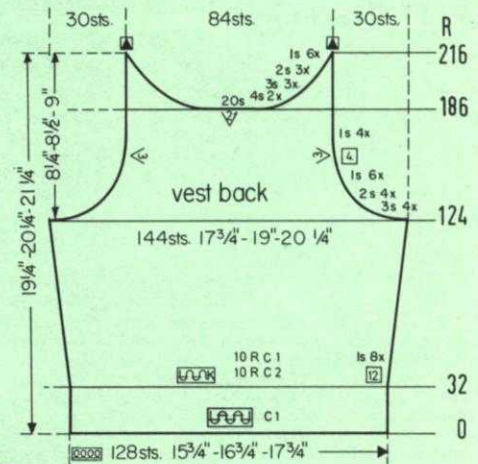

Move the Cam Box to the left side, turn the Row Counter back to 210 and complete the left half. Follow the instructions from*.

*ON CAM BOX SIDE, bind off 3 sts. after Rows 211, 213; 2 sts. after Rows 215, 217; 1 st. after Rows 219, 221, 223, 225, 227. For SHOULDER bind off 3 sts. after Rows 236, 238, 240; 5 sts. after Rows 242, 244, 246, 248, 250.

Work the front section the same as the back section to ROW 210, then bind off the center 22 sts., put the needles on the left side into holding position and complete the right half first.

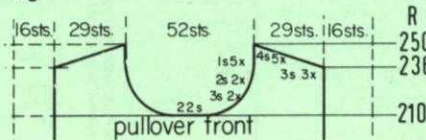

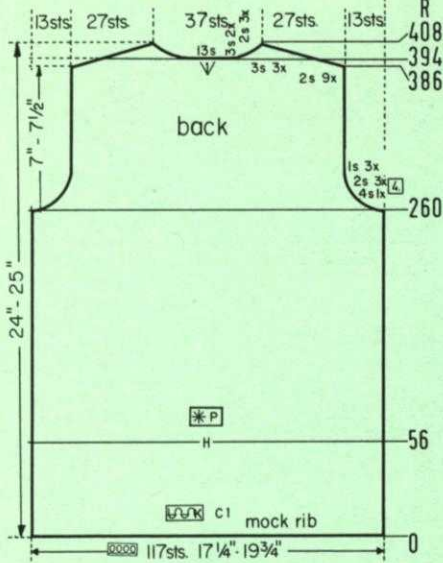

Bring the needles on the left side into working position, knit 1 row in PATTERN to the left side, turn the Row Counter back to 394 and complete the left half. Follow the instructions from*.

*ON CAM BOX SIDE, bind off 2 sts. after Row 394 (EVEN ROWS = SHOULDER SHAPING); 3 sts. after Row 395 (ODD ROWS = NECK SHAPING); 2 sts. after Row 396; 3 sts. after Row 397; 2 sts. after Rows 398, 399, 400, 401, 402, 403; 3 sts. after Rows 404, 406, 408.

ON CAM BOX SIDE, bind off 2 sts. after Rows 386, 387, 388, 389, 390, 391, 392, 393, then knit to Row 394, bind off the center 13 sts., put the needles on the left side into holding position and complete the right half first.

ON CAM BOX SIDE, bind off 4 sts. after Rows 260, 261; 2 sts. after Rows 264, 265, 268, 269, 272, 273; 1 st. after Rows 276, 277, 280, 281, 284, 285, then knit to Row 386.

ROWS 57 to 260: Knit even.

ROWS 0 to 56: Knit even, then form the hem, place the Gate Cam Release Lever to the needle heels and work the Pattern Stitch over ALL 117 needles.

Bring 117 needles into working position, put every 4th needle into the non-working position and with color 1 cast on for the Mock Ribbing.

Move the Cam Box to the left side, turn the Row Counter back to 186 and complete the left half. Follow the instructions from*.

*ON CAM BOX SIDE, bind off 4 sts. after Rows 187, 189; 3 sts. after Rows 191, 193, 195; 2 sts. after Rows 197, 199, 201; 1 st. after Rows 203, 205, 207, 209, 211, 213. After Row 216 hang the remaining 3 sts. together, then bind off.

ON CAM BOX SIDE, bind off 3 sts. after Rows 124, 125, 126, 127, 128, 129, 130, 131; 2 sts. after Rows 132, 133, 134, 135, 136, 137, 138, 139; 1 st. after Rows 140, 141, 142, 143, 144, 145, 146, 147, 148, 149, 150, 151, 152, 153, 156, 157, 160, 161, 164, 165, then knit to Row 186, bind off the center 20 sts., put the needles on the left side into holding position and complete the right half first.

ON EACH SIDE, increase 1 st. after Rows 32, 44, 56, 68, 80, 92, 104, 116, then knit to Row 124.

ROWS 0 to 32: Knit even, then change to stockinette st. and work the repeated color stripes as marked in the Diagram.

Cast on 128 sts. with color 1 and work K1, P1, Ribbing.

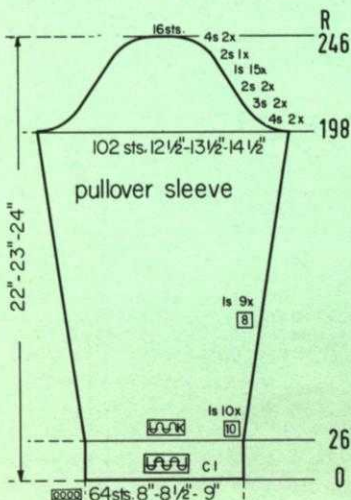

ON CAM BOX SIDE, bind off 4 sts. after Rows 198, 199, 200, 201; 3 sts. after Rows 202, 203, 204, 205; 2 sts. after Rows 206, 207, 208, 209. ON EACH SIDE, hang the 1st st. onto the 2nd st. after Rows 210, 212, 214, 216, 218, 220, 222, 224, 226, 228, 230, 232, 234, 236, 238. ON CAM BOX SIDE, bind off 2 sts. after Rows 240, 241; 4 sts. after Rows 242, 243, 244, 245; 16 sts. after Row 246.

ON EACH SIDE, increase 1 st. after Rows 26, 36, 46, 56, 66, 76, 86, 96, 106, 116, 126, 134, 142, 150, 158, 166, 174, 182, 190, then knit to Row 198.

ROWS 0 to 26: Knit even, then change to stockinette st.

Cast on 64 sts. with color 1 and work K1, P1, Ribbing.

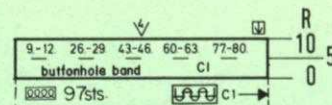

Cast on 97 sts. with color 1 and work K1, P1, Ribbing. Make buttonholes after Row 5 over the 9th-12th, 26th-29th, 43rd-46th, 60th-63rd, 77th-80th sts. counting from the left side. After Row 10 bind off all sts. Work the button band the same, but omit the buttonholes.

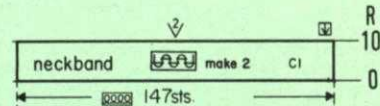

Cast on 147 sts. with color 1 and work 10 rows K1, P1, Ribbing, then bind off all sts.

Work the second front section with reverse shapings, casting on from right to left. (Cam Box will be on the LEFT side at Row 0).

ON CAM BOX SIDE, bind off 3 sts. after Row 124 (EVEN ROWS = ARM-HOLE SHAPING); 4 sts. after Row 125 (ODD ROWS = NECK SHAPING); 3 sts. after Row 126; 4 sts. after Row 127; 3 sts. after Rows 128, 129, 130, 131; 2 sts. after Row 132; 3 sts. after Row 133; 2 sts. after Row 134; 3 sts. after Row 135; 2 sts. after Rows 136, 137, 138, 139; 1 st. after Row 140; 2 sts. after Row 141; 1 st. after Rows 142, 143, 144, 145, 146, 147, 148, 149, 150, 151, 152, 153, 155, 156, 157, 160, 161, 164, 165. After Row 168 hang the 3 remaining sts. together, then bind off.

ON CAM BOX SIDE, increase 1 st. after Rows 32, 44, 56, 68, 80, 92, 104, 116, then knit to Row 124.

ROWS 0 to 32: Knit even, then change to stockinette st. and work the repeated color stripes as marked in the Diagram.

Cast on 61 sts. with color 1 and work K1, P1, Ribbing.

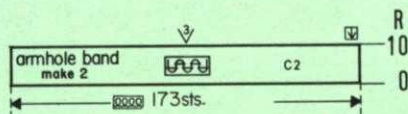
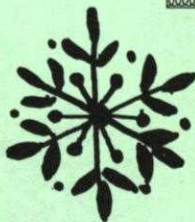
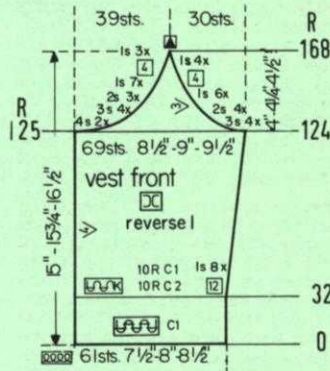

Cast on 173 sts. with color 2 and work 10 rows K1, P1, Ribbing, then bind off all sts.

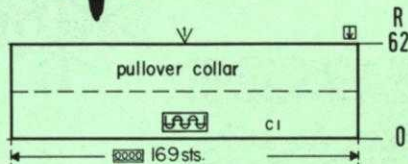

Cast on 169 sts. with color 1 and work 62 rows K1, P1, Ribbing, then bind off all sts.



BE SURE TO NOTIFY US IMMEDIATELY OF ANY CHANGE OF ADDRESS. THE POST OFFICE WILL NOT FORWARD YOUR MAGAZINE TO YOU.

DK 8232

SIZE:	10 (Bust 31"-32")	12 (Bust 33"-34")	14 (Bust 35"-36")
YARN:	Subita Crepe 2 x 3	Beatrice Crepe	Beatrice Crepe
50 gr. BALLS:			
JUMPER:	6 color 1 1 color 2 1 color 3 1 color 4 6 color 2	7 color 1 1 color 2 1 color 3 1 color 4 7 color 2	8 color 1 1 color 2 1 color 3 1 color 4 8 color 2
PULLOVER:			
TENSION:	5 to 7	5 to 7	6 to 8
GAUGE: 2"			
Stock:	17 sts. 23 rows	16 sts. 22 rows	15 sts. 21 rows
Pattern:	17 sts. 22 rows	16 sts. 21 rows	15 sts. 20 rows

The instructions are the same for all sizes. **PATTERN:** Stockinette Stitch with a Norwegian Design on the Skirt section. Follow the Line Drawing, or use JAC 40 and Pattern No. 576. In the instructions, each row in the Norwegian Design is counted as 1 row, but several movements of the Cam Box are needed to complete 1 row. **PULLOVER EDGES:** K1, P1, Ribbing. **DECREASES:** Hang the 1st st. onto the 2nd st. **INCREASES:** Move the 2 end sts. 1 needle outward, then place the 3rd st. from the row below onto the empty needle.

FINISHING: JUMPER: Join the sections at sides and shoulders. Work 1 row of single crochet and 1 row of backward single crochet around the armhole edges and the neckline. Turn under 18 rows on lower edge and hem in place. **PULLOVER:** Join the front and the back section at sides and shoulders. Sew the sleeves together and set in. Join the short ends of the collar, then sew the collar to neckline and fold over to the outside.



Move the Cam Box to the left side, turn the Row Counter back to 382 and complete the left half. Follow the instructions from *.

*ON CAM BOX SIDE, bind off 4 sts. after Row 382 (EVEN ROWS = ARM-HOLE SHAPING); 3 sts. after Rows 383 (ODD ROWS = NECK SHAPING), 384, 385, 386; 2 sts. after Row 387; 3 sts. after Row 388; 2 sts. after Rows 389, 390, 391, 392; 1 st. after Row 393; 2 sts. after Row 394; 1 st. after Rows 395, 396, 397, 398, 399, 400, 401, 402, 404, 405, 408, 409, 412, 413, 416, 417, then knit to Row 480 and bind off the 16 SHOULDER sts.

Work the front section the same as the back section to ROW 358, then work Short Rows for the Bust Darts. ON OPPOSITE SIDE of CAM BOX put into holding position 7 needles after Rows 358, 359, 360, 361, 362, 363, 364, 365, 366, 367. ON OPPOSITE SIDE of CAM BOX bring back into working position all needles after Rows 368, 369, then knit to Row 382, bind off the center 23 sts., put the needles on the left side into holding position and complete the right half first.

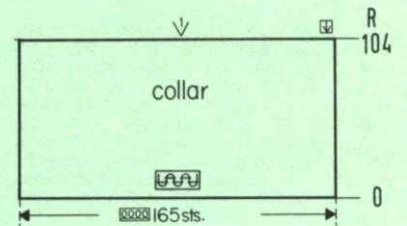
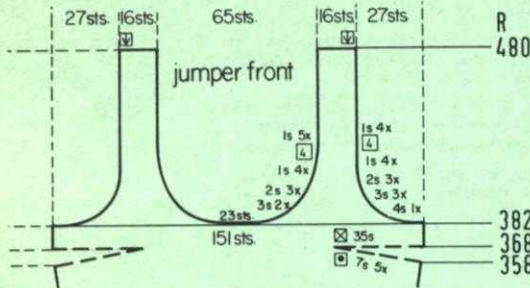
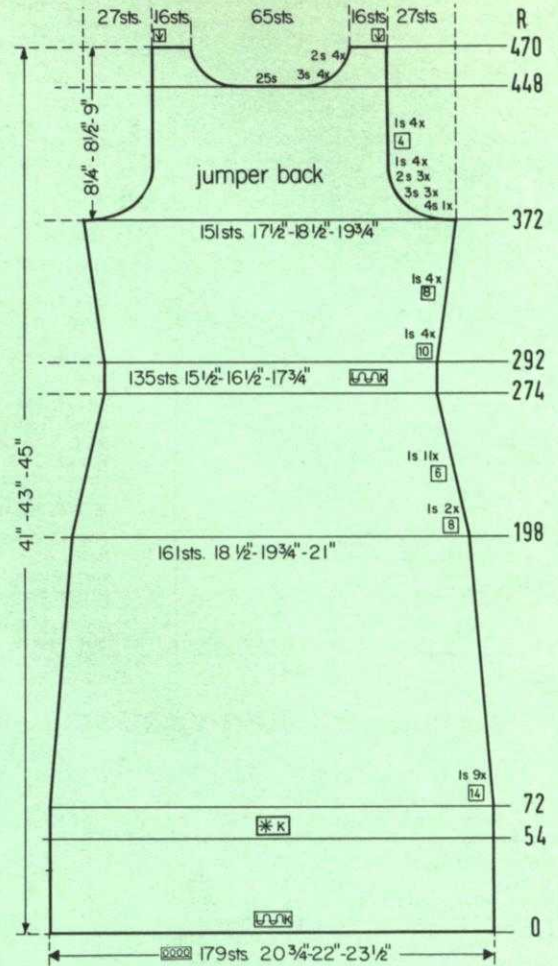

Move the Cam Box to the left side, turn the Row Counter back to 214 and complete the left half. Follow the instructions from *.

*ON CAM BOX SIDE, bind off 3 sts. after Rows 215, 217; 2 sts. after Rows 219, 221, 223; 1 st. after Rows 225, 227, 229, 233, 237. For SHOULDER bind off 5 sts. after Rows 246, 248, 250; 6 sts. after Rows 252, 254.

ON CAM BOX SIDE, bind off 4 sts. after Rows 166, 167; 3 sts. after Rows 168, 169; 2 sts. after Rows 170, 171, 172, 173; 1 st. after Rows 174, 175, 176, 177, 178, 179, 180, 181, 182, 183, then knit to Row 214, bind off the center 24 sts., put the needles on the left side into holding position and complete the right half first.

Work the front section the same as the back section to ROW 140, then work Short Rows for the Bust Darts. ON OPPOSITE SIDE of CAM BOX put into holding position 8 needles after Rows 140, 141, 142, 143, 144, 145, 146, 147. ON OPPOSITE SIDE of CAM BOX bring back into working position all needles after Rows 148, 149, then knit to Row 166.

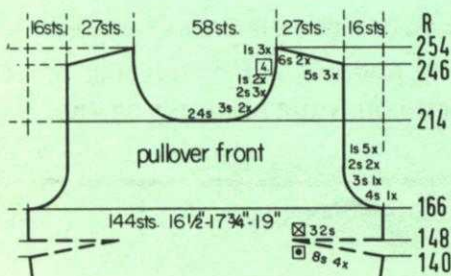
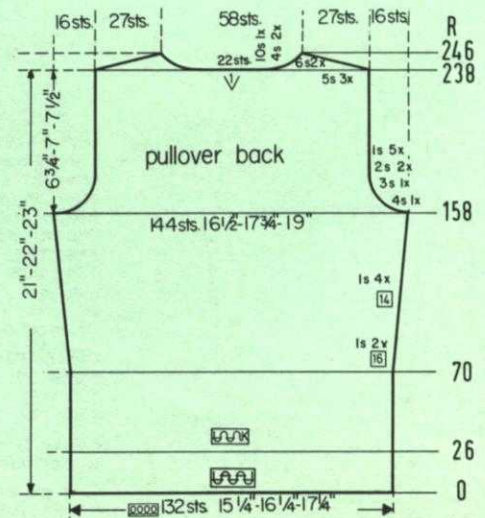
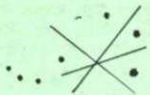

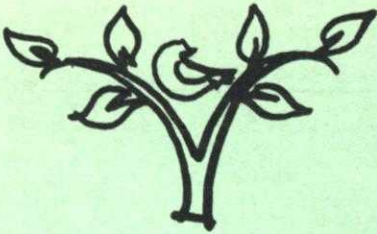

Move the Cam Box to the left side, turn the Row Counter back to 448 and complete the left half. Follow the instructions from*.

*ON CAM BOX SIDE, bind off 3 sts. after Rows 449, 451, 453, 455; 2 sts. after Rows 457, 459, 461, 463. After Row 470 bind off the 16 SHOULDER sts.

ON CAM BOX SIDE, bind off 4 sts. after Rows 372, 373; 3 sts. after Rows 374, 375, 376, 377, 378, 379; 2 sts. after Rows 380, 381, 382, 383, 384, 385; 1 st. after Rows 386, 387, 388, 389, 390, 391, 392, 393, 394, 395, 398, 399, 402, 403, 406, 407, then knit to Row 448, bind off the center 25 sts., put the needles on the left side into holding position and complete the right half first.

ON EACH SIDE, increase 1 st. after Rows 292, 302, 312, 322, 332, 340, 348, 356, then knit to Row 372. (For the Front Section knit to ROW 358).

ON EACH SIDE, decrease 1 st. after Rows 72, 86, 100, 114, 128, 142, 156, 170, 184, 198, 206, 214, 220, 226, 232, 238, 244, 250, 256, 262, 268, 274, AND at the same time, change to color 1 and work stockinette st. after Row 274. Knit to Row 292.

ROWS 55 to 72: Knit even.

ROWS 0 to 54: Knit even, then begin the Norwegian Design.

Cast on 179 sts. with color 1 and work stockinette st.

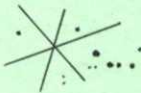

Cast on 165 sts. with color 2 and work 104 rows K1, P1, Ribbing, then bind off all sts.

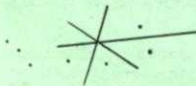

Move the Cam Box to the left side, turn the Row Counter back to 238 and complete the left half. Follow the instructions from*.

*ON CAM BOX SIDE, bind off 5 sts. after Row 238 (EVEN ROWS = SHOULDER SHAPING); 10 sts. after Row 239 (ODD ROWS = NECK SHAPING); 5 sts. after Row 240; 4 sts. after Row 241; 5 sts. after Row 242; 4 sts. after Row 243; 6 sts. after Rows 244, 246.

ON CAM BOX SIDE, bind off 4 sts. after Rows 158, 159; 3 sts. after Rows 160, 161; 2 sts. after Rows 162, 163, 164, 165; 1 st. after Rows 166, 167, 168, 169, 170, 171, 172, 173, 174, 175, then knit to Row 238, bind off the center 22 sts., put the needles on the left side into holding position and complete the right half first.

ON EACH SIDE, increase 1 st. after Rows 70, 84, 98, 112, 126, 140, then knit to Row 158. (For the Front Section knit to ROW 140 and make the increases).

ROWS 27 to 70: Knit even.

ROWS 0 to 26: Knit even, then change to stockinette st.

Cast on 132 sts. with color 2 and work K1, P1, Ribbing.

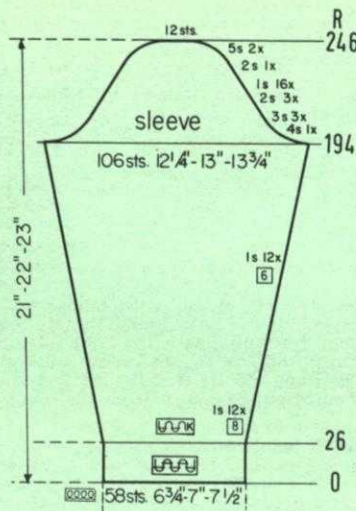
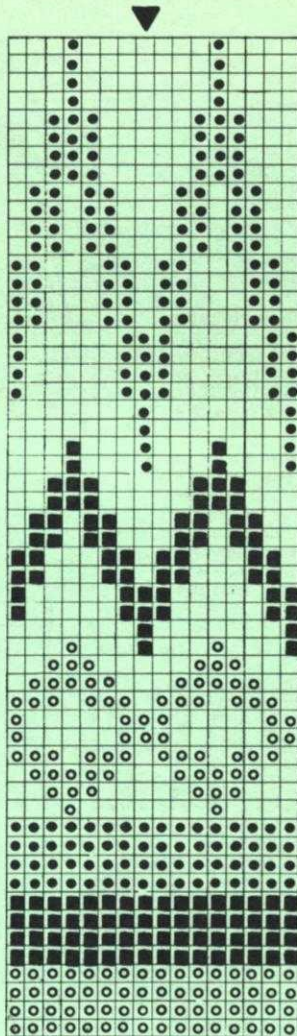

ON CAM BOX SIDE, bind off 4 sts. after Rows 194, 195; 3 sts. after Rows 196, 197, 198, 199, 200, 201; 2 sts. after Rows 202, 203, 204, 205, 206, 207. ON EACH SIDE, decrease 1 st. after Rows 208, 210, 212, 214, 216, 218, 220, 222, 224, 226, 228, 230, 232, 234, 236, 238. ON CAM BOX SIDE, bind off 2 sts. after Rows 240, 241; 5 sts. after Rows 242, 243, 244, 245; 12 sts. after Row 246.

ON EACH SIDE, increase 1 st. after Rows 26, 34, 42, 50, 58, 66, 74, 82, 90, 98, 106, 114, 122, 128, 134, 140, 146, 152, 158, 164, 170, 176, 182, 188, then knit to Row 194.

ROWS 0 to 26: Knit even, then change to stockinette st.

Cast on 58 sts. with color 2 and work K1, P1, Ribbing.



Jac 40

- ◻ COLOR 2 P
- ◼ COLOR 4 E
- ◻ COLOR 3 U
- ◻ COLOR 1 A

(Jac40 is a must)

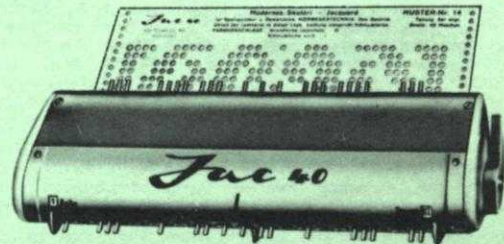

for fast easy knitting of
Jaquard and Ski-sweater
designs

Jac 40's are made for most brands of machines. When ordering be sure to specify your brand of knitter as needle spacings vary. Simple to use and an essential tool for the modern knitter, Jac 40's are \$29.50 complete with 3 cards for practicing the 3 techniques, plus complete instructions.



Order from your dealer or direct from

KNITKING

1128 Crenshaw Boulevard, Los Angeles, Calif. 90019

Shipping Cost \$1.50 - California residents add sales tax.

MK 5441

SIZE:	6 (Chest 24")	8 (Chest 26")	10 (Chest 28")
YARN:	Beatrice Crepe	Allegro Dralon	Allegro Dralon
50 gr. BALLS:	8 color 1 3 color 2	10 color 1 4 color 2	11 color 1 5 color 2
TENSION:			
Stock:	5 to 7	6 to 8	7 to 9
Pattern:	3 to 5	5 to 7	6 to 8
GAUGE:	2"		
Stock:	16 sts. 22 rows	15 sts. 21 rows	14 sts. 20 rows
Pattern:	16 sts. 30 rows	15 sts. 29 rows	14 sts. 28 rows

The instructions are the same for all sizes. PATTERN: Skirt, Stockings and Cap: Holding Position Design according to the Line Drawing, or use JAC 40 and Pattern No. 75. Pullover: Stockinette Stitch. Edges: K1, P1, Ribbing. The knit side is the right side on all garments. DECREASES: Pullover: Hang the 3rd st. onto the 2nd st., then move the end sts. inward to fill the empty needle. Skirt and Stockings: Hang the 1st st. onto the 2nd st. INCREASES: Move the 2 end sts. 1 needle outward, then place the 3rd st. from the row below onto the empty needle.

FINISHING: Block all sections. PULLOVER: Join front and back section at sides. Sew the sleeves together, then weave in place. Sew the short ends of the collar together, then sew the collar to the neckline and fold over to outside. SKIRT: Join the sections at sides. Turn under 11 rows on the upper edge and 24 rows on the lower edge and hem in place. Insert an elastic band into the upper hem. CAP: Sew the center back seam together. Pull the sts. held on the lengths of yarn together, tie and sew the ends in. Turn under 15 rows on the lower edge and hem in place. Make a Pom-Pom with color 1, (see Practical Knitting Hints Book, page 61) then sew the Pom-Pom in place. STOCKINGS: Sew the center back seam together. Weave the open sts. together to form the heel. Join the instep to the sole at sides.

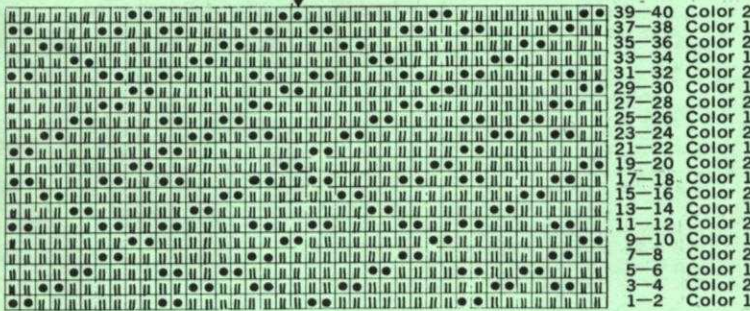
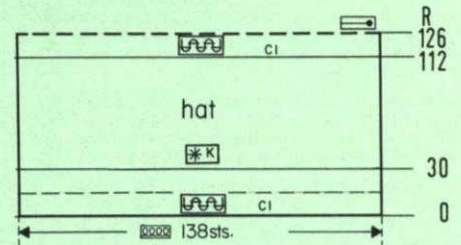
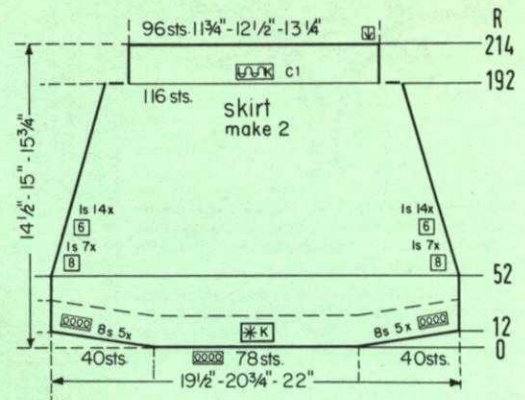

DP 8231

SIZE:	16 (Bust 37"-38")	18 (Bust 39"-40")	20 (Bust 42"-43")
YARN:	Crocus Crepe	Melodie	Allegro Dralon
50 gr. BALLS:	8	9	8
TENSION:	6 to 8	7 to 9	7 to 9
GAUGE:	2"	16 sts. 21 rows	15 sts. 20 rows
			14 sts. 20 rows

DP 8231

The instructions are the same for all sizes. PATTERN: Stockinette Stitch and an Eyelet Design on the front section and on the sleeves. Follow the Line Drawing for the Design. The sleeves are worked from the top down. INCREASES: Move the 2 end sts. 1 needle outward, then place the 3rd st. from the row below onto the empty needle. DECREASES: Hang the 3rd st. onto the 2nd st., then move the end sts. inward to fill the empty needle. To form the hem, hang the cast-on sts. back onto the machine behind the latches, then knit the following row with 1 to 2 tension settings higher.

FINISHING: Block all sections. Join the front and the back section at sides and shoulders. Sew the sleeves together and set in. Turn under 16 rows on the sleeve edges and hem in place. Join the short ends of the neckband, then sew 1 edge of the band to inside and 1 edge to the outside of the neckline. Sew buttons to the center of the Eyelet Designs. (See picture).

EYELET DESIGN: Use triple Transfer Tool to move 3 sts. over to the right or to the left as shown.

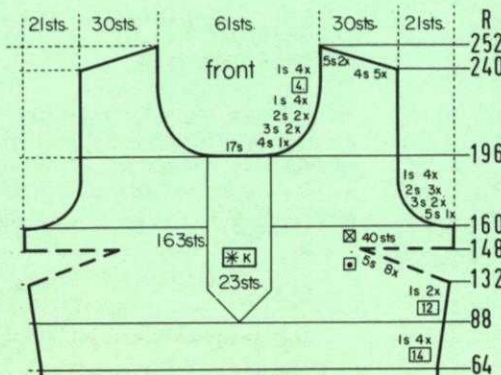

Move the Cam Box to the left side, turn the Row Counter back to 196 and complete the left half. Follow the instructions from*.

*ON CAM BOX SIDE, bind off 4 sts. after Row 197; 3 sts. after Rows 199, 201; 2 sts. after Rows 203, 205; 1 st. after Rows 207, 209, 211, 213, 215, 219, 223, 227. For SHOULDER bind off 4 sts. after Rows 240, 242, 244, 246, 248; 5 sts. after Rows 250, 252.

ON CAM BOX SIDE, bind off 5 sts. after Rows 160, 161; 3 sts. after Rows 162, 163, 164, 165; 2 sts. after Rows 166, 167, 168, 169, 170, 171; 1 st. after Rows 172, 173, 174, 175, 176, 177, 178, 179, then knit to Row 196, bind off the center 17 sts., put the needles on the left side into holding position and complete the right half first.

ON EACH SIDE, increase 1 st. after Rows 64, 78, (Begin the Eyelet Design over the center 23 sts. after Row 88) 92, 106, 120, 132, but do not knit after the last increases. Work Short Rows for the Darts. ON OPPOSITE SIDE of CAM BOX put into holding position 5 needles after Rows 132, 133, 134, 135, 136, 137, 138, 139, 140, 141, 142, 143, 144, 145, 146, 147. ON OPPOSITE SIDE of CAM BOX bring back into working position all needles after Rows 148, 149, then knit to Row 160.

Work the front section the same as the back section to ROW 64.

ON EACH SIDE, decrease 1 st. after Rows 52, 60, 68, 76, 84, 92, 100, 108, 114, 120, 126, 132, 138, 144, 150, 156, 162, 168, 174, 180, 186. Knit to Row 191, change to color 1 and working stockinette st. Knit to Row 192. Knit several rows with contrast waste yarn, then remove the knitting from the machine. Bring 96 needles into working position. With purl side facing you, hang the garment st. back onto the machine decreasing 20 sts. evenly across. Remove the contrast waste yarn, turn the Row Counter back to 192 and with color 1 work stockinette st. to Row 214, then bind off all 96 sts. Work the second skirt section the same.

ON CAM BOX SIDE, cast on 8 sts. after Rows 2, 3, 4, 5, 6, 7, 8, 9, 10, 11, then knit to Row 52.

Cast on 78 sts. with color 1, work the Holding Position Design and knit 2 rows.

ROWS 31 to 112: Knit even, then transfer every other st. to the ribber and with color 1 work K1, P1, Ribbing to Row 126. Transfer the ribber sts. to the main machine then take the sts. from the machine. Use the ribber transfer needle and transfer first the 1st, 3rd, 5th 7th etc. sts. onto a length of yarn, then the 2nd, 4th, 6th, 8th etc. sts. onto a second length of yarn.

ROWS 0 to 30: Knit even, then transfer the ribber sts. to the main machine and work the Holding Position Design.

Cast on 138 sts. with color 1 and work K1, P1, Ribbing.

Move the Cam Box to the left side, turn the Row Counter back to 168 and complete the left half. Follow the instructions from*.

*Continue to decrease 1 st. for RAGLAN after Rows in (). ON CAM BOX SIDE, bind off 3 sts. after Rows 169, (169), 171; (171), 2 sts. after Rows 173, (173), 175; (175), 1 st. after Rows 177, (177), 179, (179), 181, (181), 183, (183), (185). After Row 186 hang the remaining 3 sts. together, then bind off.

Work the front section the same as the back section to ROW 168, then bind off the center 12 sts., put the needles on the left side into holding position and complete the right half first.

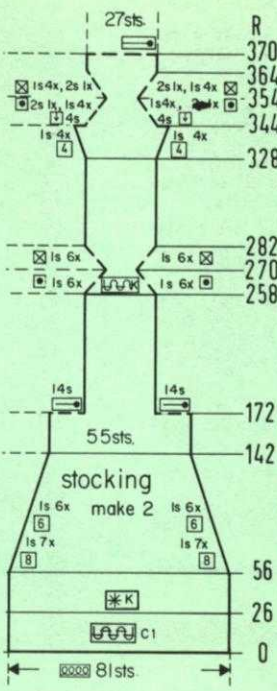

ON EACH SIDE, increase 1 st. after Rows 328, 332, 336, 340, then knit to Row 344, bind off 4 sts. ON EACH SIDE, (use a separate length of yarn for the left side) then work Short Rows. ON OPPOSITE SIDE of CAM BOX put into holding position 1 needle after Rows 344, 345, 346, 347, 348, 349, 350, 351; 2 needles after Rows 352, 353. ON OPPOSITE SIDE of CAM BOX bring back into working position 2 needles after Rows 354, 355; 1 needle after Rows 356, 357, 358, 359, 360, 361, 362, 363, then knit to Row 370 and put the 27 sts. onto a stitch holder.

ON EACH SIDE, decrease 1 st. after Rows 56, 64, 72, 80, 88, 96, 104, 112, 118, 124, 130, 136, 142, then knit to Row 172 and put 14 sts. ON EACH SIDE onto a stitch holder. Knit over the remaining 27 sts. to Row 258, then change to color 1, work stockinette st. and Short Rows. ON OPPOSITE SIDE of CAM BOX put into holding position 1 needle after Rows 258, 259, 260, 261, 262, 263, 264, 265, 266, 267, 268, 269. ON OPPOSITE SIDE of CAM BOX bring back into working position 1 needle after Rows 270, 271, 272, 273, 274, 275, 276, 277, 278, 279, 280, 281, then knit to Row 328.

ROWS 27 to 56: Knit even.

ROWS 0 to 26: Knit even, then transfer the ribber sts. to the main machine and begin the Holding Position Design.

Cast on 81 sts. with color 1 and work K1, P1, Ribbing.



Move the Cam Box to the left side, turn the Row Counter back to 182 and complete the left half. Follow the instructions from*.

*Continue to decrease 1 st. for RAGLAN after Rows in (). ON CAM BOX SIDE, bind off 4 sts. after Row 183; (183), 3 sts. after Rows 185, (185), 187, (187), 189.

ON EACH SIDE, decrease 1 st. for RAGLAN SHAPING after Rows 118, 121, 124, 127, 130, 133, 136, 139, 141, 143, 145, 147, 149, 151, 153, 155, 157, 159, 161, 163, 165, 167, 169, 171, 173, 175, 177, 179, 179, 181, then knit to Row 182, bind off the center 16 sts., put the needles on the left side into holding position and complete the right half first. (For the Front Section knit to ROW 168).

ROWS 27 to 118: Knit even.

ROWS 0 to 26: Knit even, then change to stockinette st.

Cast on 108 sts. with color 1 and work K1, P1, Ribbing.

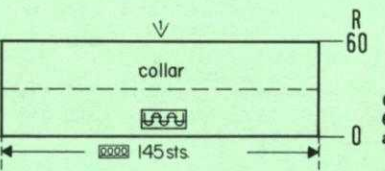
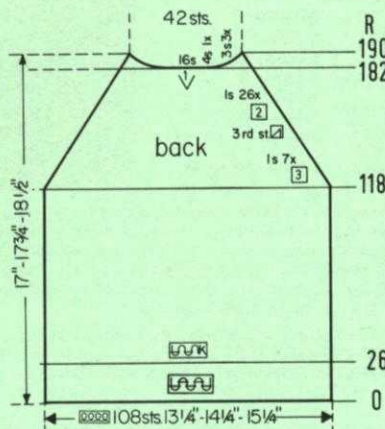

Cast on 145 sts. with color 1 and work 60 rows K1, P1, Ribbing, then bind off all sts.

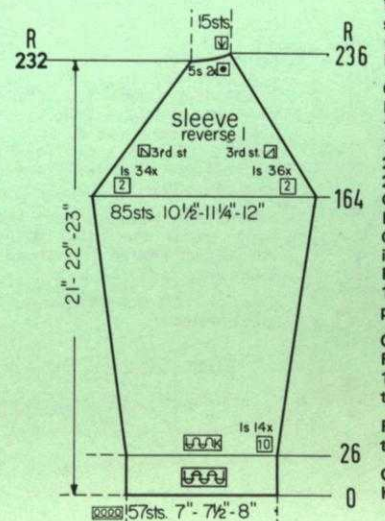

Work the second sleeve with reverse shaping, casting on from right to left. (Cam Box will be on the LEFT side at Row 0).

ON EACH SIDE, decrease 1 st. after Rows 164, 166, 168, 170, 172, 174, 176, 178, 180, 182, 184, 186, 188, 190, 192, 194, 196, 198, 200, 202, 204, 206, 208, 210, 212, 214, 216, 218, 220, 222, 224, 226, 228, 230, then 2 more times ON CAM BOX SIDE after Rows in (). Knit to Row 232 and work Short Rows. ON OPPOSITE SIDE of CAM BOX put into holding position 5 needles after Rows 232, (232), 234, (234). After Row 136 bring the needles back into working position, then bind off all 15 sts.

ON EACH SIDE, increase 1 st. after Rows 26, 36, 46, 56, 66, 76, 86, 96, 106, 116, 126, 136, 146, 156, then knit to Row 164.

ROWS 0 to 26: Knit even, then change to stockinette st.

Cast on 57 sts. with color 1 and work K1, P1, Ribbing.

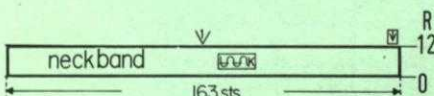
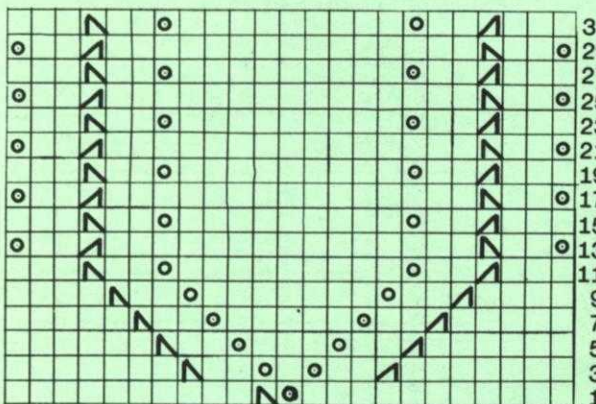

Cast on 163 sts. and work 12 rows stockinette st., then bind off all sts.



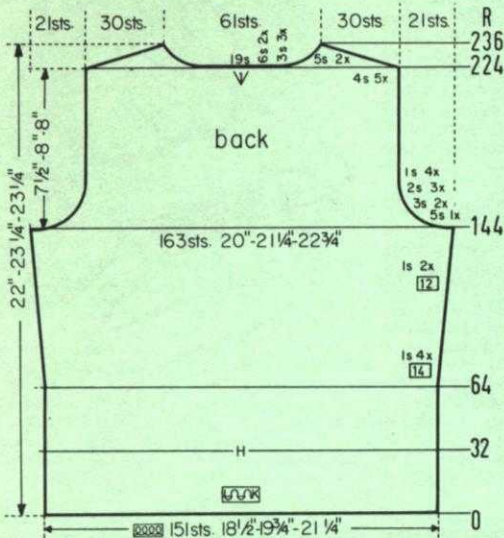

Move the Cam Box to the left side, turn the Row Counter back to 224 and complete the left half. Follow the instructions from*

*ON CAM BOX SIDE, bind off 4 sts. after Row 224 (EVEN ROWS = SHOULDER SHAPING); 6 sts. after Row 225 (ODD ROWS = NECK SHAPING); 4 sts. after Row 226; 6 sts. after Row 227; 4 sts. after Row 228; 3 sts. after Row 229; 4 sts. after Row 230; 3 sts. after Row 231; 4 sts. after Row 232; 3 sts. after Row 233; 5 sts. after Rows 234, 236.

ON CAM BOX SIDE, bind off 5 sts. after Rows 144, 145; 3 sts. after Rows 146, 147, 148, 149; 2 sts. after Rows 150, 151, 152, 153, 154, 155; 1 st. after Rows 156, 157, 158, 159, 160, 161, 162, 163, then knit to Row 224, bind off the center 19 sts., put the needles on the left side into holding position and complete the right half first.

ON EACH SIDE, increase 1 st. after Rows 64, 78, 92, 106, 120, 132, then knit to Row 144.

ROWS 33 to 64: Knit even. (For the Front Section knit to ROW 64).

ROWS 0 to 32: Knit even, then form the hem.

Cast on 151 sts. and work stockinette st.

ON EACH SIDE, decrease 1 st. after Rows 66, 72, 78, 84, 90, 96, 102, 108, 114, 120, 126, 132, 138, 144, (Begin the Eyelet Design over the center 23 sts. after Row 144), 150, 156, 162, 168, 174, 180, 186, 192, 198, 204. Work stockinette st. over the remaining 63 sts. to Row 236, then bind off all sts.

ON CAM BOX SIDE, cast on 3 sts. after Rows 2, 3, 4, 5, 6, 7; 2 sts. after Rows 8, 9; 1 st. after Rows 10, 11, 12, 13, 14, 15, 16, 17, 18, 19, 20, 21, 22, 23, 24, 25, 26, 27, 28, 29, 30, 31, 32, 33, 34, 35, 36, 37, 38, 39, 40, 41; 2 sts. after Rows 42, 43, 44, 45; 3 sts. after Rows 46, 47, 48, 49, 50, 51; 4 sts. after Rows 52, 53, 54, 55, then knit to Row 66. (You can work the Cap with Short Rows. Cast on all 111 sts., then put all but the center 15 sts. into holding position. After Row 2 and beginning on the OPPOSITE SIDE of the CAM BOX, bring the needles back into working position in the same order as the cast-on sts. given above).

Cast on 15 sts. and work stockinette st.

KK 5437

SIZE:	4 (Chest 23")	6 (Chest 24")
YARN:	Allegro	Allegro
50 gr. BALLS:	2 color 1 1 color 2 1 color 3 1 color 4 1 color 5	3 color 1 1 color 2 1 color 3 1 color 4 1 color 5
TENSION:	6 to 8	7 to 9
GAUGE:	2" 15 sts. 21 rows	14 sts. 20 rows



The instructions are the same for both sizes. PATTERN: Stockinette Stitch, color stripes and a Norwegian Design. Follow the Line Drawing. In the instructions, each row in the Norwegian Design is counted as 1 row, but several movements of the Cam Box are needed to complete 1 row. DECREASES: Hang the 4th st. onto the 3rd st., then move the end sts. inward to fill the empty needles. To form the hem, hang the cast-on sts. back onto the machine behind the latches, then knit the following row with 1 or 2 tension settings higher.

FINISHING: Block all sections. PONCHO: Weave the sections together, 1 st. in on each edge. Join the short ends of the collar, then sew 1 edge of the collar to the inside and 1 edge to the outside of the neckline. CAP: Pull the open sts. together, tie and sew in the ends. Weave the section together at center back.

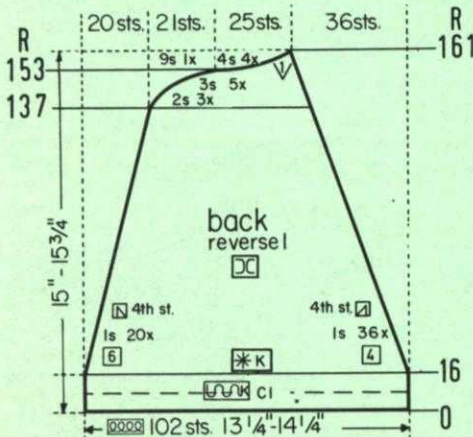

Work the second back section with reverse shapings, casting on from right to left. (The Cam Box will be on the LEFT side at Row 0).

ON CAM BOX SIDE, bind off 2 sts. after Rows 137, 139, (140), 141; 3 sts. after Rows 143, (144), 145, 147, (148), 149, 151; (152), 9 sts. after Row 153; 4 sts. after Rows 155, (156), 157, 159, 161.

Decrease 1 st. ON OPPOSITE SIDE of CAM BOX after Rows in (). ON CAM BOX SIDE, decrease 1 st. after Rows 16, (16), 20, (22), 24, 28, (28), 32, (34), 36, 40, (40), 44, (46), 48, 52, (52), 56, (58), 60, 64, (64), 68, (70), 72, 76, (76), 80, (82), 84, 88, (88), 92, (94), 96, 100, (100), 104, (106), 108, 112, (112), 116, (118), 120, 124, (124), 128, (130), 132, 136, then continue to decrease 1 st. ON CENTER BACK after Rows in (). Knit to Row 137. (For the Front Section knit to ROW 137).

ROWS 0 to 16: Knit even, then form the hem. Begin the color stripes and the Norwegian Design as marked in the Line Drawing.

Cast on 102 sts. with color 1 and work stockinette st.

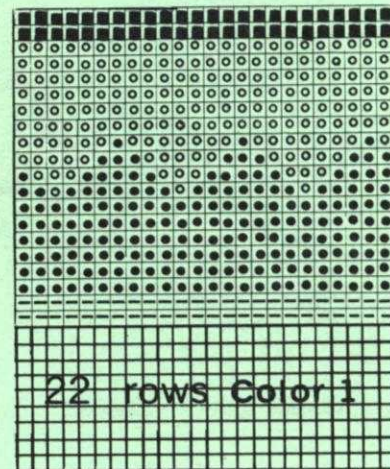

22 rows Color 1

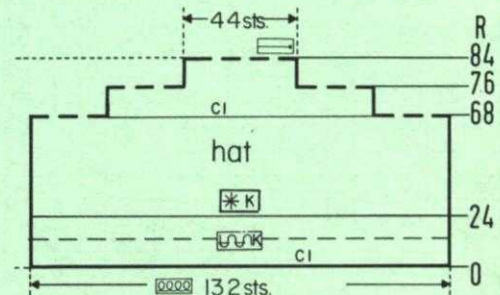

Work the second front section with reverse shapings, casting on from right to left. (The Cam Box will be on the LEFT side at Row 0).

Decrease 1 more st. ON CENTER FRONT after Row in (). ON CAM BOX SIDE, bind off 2 sts. after Rows 137, 139, (140), 141 (ODD ROWS = SHOULDER SHAPING); 3 sts. after Row 143; 20 sts. after Row 144 (EVEN ROWS = NECK SHAPING); 3 sts. after Rows 145, 146, 147, 148, 149, 150, 151.

Work the first front section the same as the first back section to ROW 137.

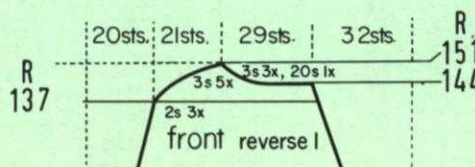

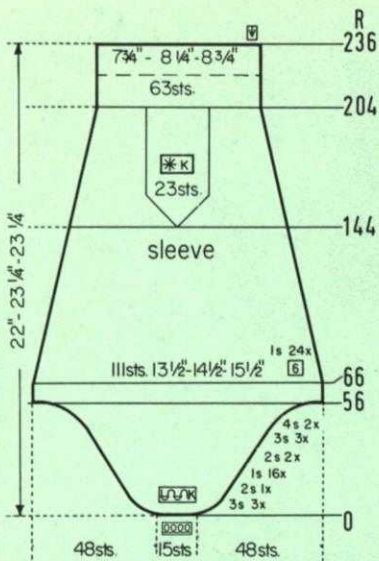

KG 1964

MATERIAL: 50 gr. balls Knitking Allegro; 2 color 1, 3 color 2, 2 color 3.

TENSION: 7 to 9

GAUGE: Pattern St. 12 sts. 38 rows = 2"; Stockinette St. 15 sts. 21 rows = 2"

PATTERN: Holding Position Design using Wheel No. 6. The purl side is the right side. Place the Gate Cam Release Lever to the Needle heels. Put the 1st, 3rd, 5th, 7th, etc. needles into holding position, knit 1 row. Bring the needles back into working position, knit 1 row. Repeat the 2 rows for PATTERN. Knitking Machine Owners, to bring the needles back into working position, push in the right Retractor Button and leave it there for pattern. BINDING: Stockinette Stitch. The knit side is the right side.

FINISHING: Block the sections. Join the binding sections at the corners. Sew 1 edge of the binding to the inside and 1 edge to the outside of the blanket edges.

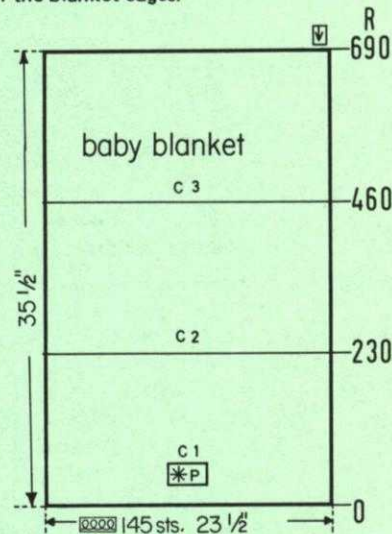
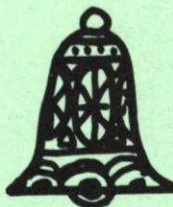

Cast on 145 sts. with color 1, place the Gate Cam Release Lever to the needle heels and work the Holding Position Design. Change colors after Rows 230 and 460. After Row 690 bind off all sts.

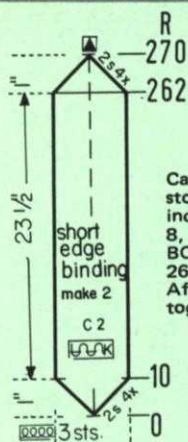

Cast on 3 sts. with color 2 and work stockinette st. ON CAM BOX SIDE, increase 2 sts. after Rows 2, 3, 4, 5, 6, 7, 8, 9, then knit to Row 262. ON CAM BOX SIDE, bind off 2 sts. after Rows 262, 263, 264, 265, 266, 267, 268, 269. After Row 270 hang the 3 remaining sts. together, then bind off.

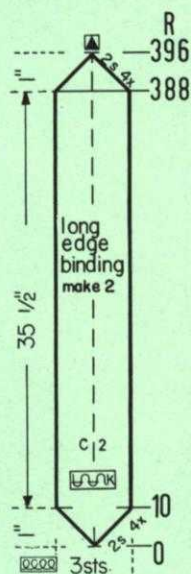

Cast on 3 sts. with color 2 and work stockinette st. ON CAM BOX SIDE, increase 2 sts. after Rows 2, 3, 4, 5, 6, 7, 8, 9, then knit to Row 388. ON CAM BOX SIDE, bind off 2 sts. after Rows 388, 389, 390, 391, 392, 393, 394, 395. After Row 396 hang the 3 remaining sts. together, then bind off.



Knit even to Row 68, then knit several rows with contrast waste yarn and remove the knitting from the machine. Bring 88 needles into working position, hang 1 st. onto one needle and 2 sts. onto the next needle all the way across. Continue to work stockinette st. over 88 needles to Row 76, again knit several rows with contrast waste yarn and remove the knitting from the machine. Bring 44 needles into working position, hang 2 sts. onto each needle, then knit to Row 84 and transfer all sts. onto a double strand of yarn. (Always remove the contrast waste yarn and set the Row Counter back to the proper row).

ROWS 0 to 24: Knit even, then form the hem. Now continue with the color stripes and the Norwegian Design. Follow the Line Drawing, but at first, knit only 18 rows with color 1 instead of 22 rows.

Cast on 132 sts. with color 1 and work stockinette st.

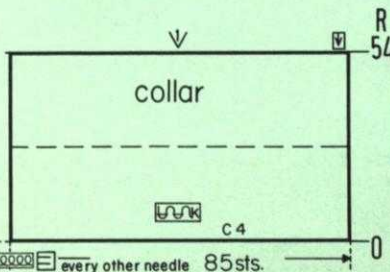

With color 4 cast on 85 sts. over every other needle and work 54 rows stockinette st., then bind off all sts.

(Jac 40 is a must)

Patterns are selected — row by row — through a pre-stamped card that is fed into the Jac.

There are over 300 cards available and illustrations of them are included with each Jac.

Jac 40's are made for most brands of machines. When ordering be sure to specify your brand of knitter as needle spacings vary. Simple to use and an essential tool for the modern knitter, Jac 40's are \$26.95 complete with 3 cards for practicing the 3 techniques, plus complete instructions.



for fast easy knitting of Jaquard and Ski-sweater designs



Order from your dealer or direct from
KNITKING

1128 Crenshaw Boulevard, Los Angeles, Calif. 90019

Shipping Cost \$1.25 — California residents add 5% sales tax.

KG 1967 AFGHAN

MATERIAL: 50 gr. Balls Knitking Beatrice; 22 color 1, 22 color 2, 10 color 3
TENSION: 5 to 7
GAUGE: 16 sts. 22 rows = 2"

PATTERN: Stockinette Stitch and a Norwegian Design. Follow the Line Drawing, or use JAC 40 and Pattern No. 2a. In the instructions, each row in the Norwegian Design is counted as 1 row, but several movements of the Cam Box are needed to complete 1 row.

FINISHING: Block the sections, Weave the strips together, 1 st. in from each edge, beginning and ending with strip 1. Join the binding sections at the corners, then sew 1 edge of the binding to the inside and 1 edge to the outside of afghan edges. Line the afghan with a light weight knitted material.

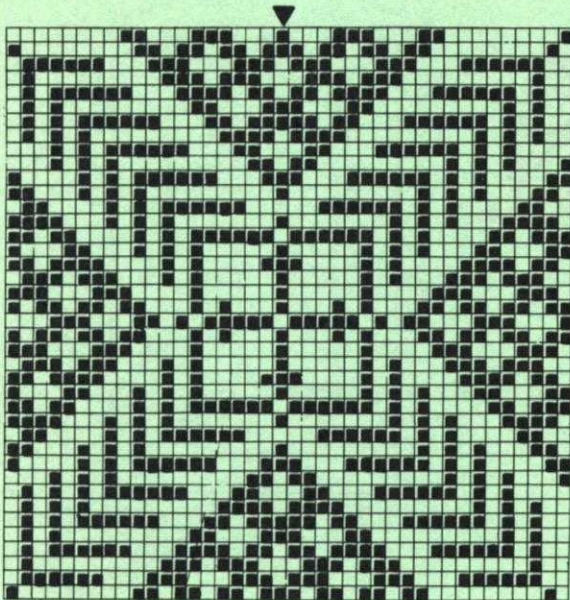

□ - COLOR 1 ■ - COLOR 2

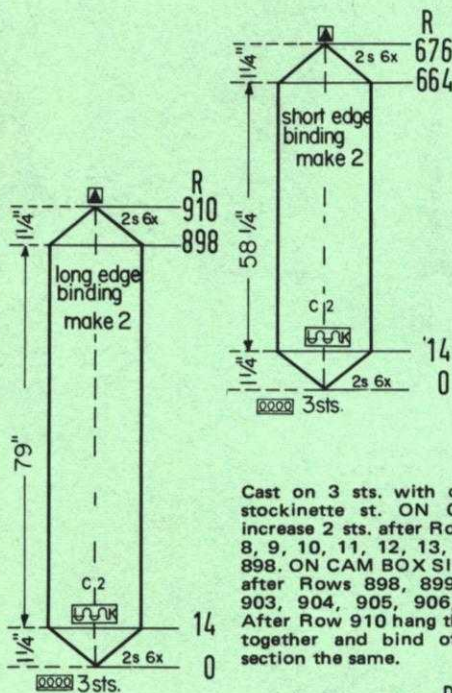

Cast on 3 sts. with color 2 and work stockinette st. ON CAM BOX SIDE, increase 1 st. after Rows 2, 3, 4, 5, 6, 7, 8, 9, 10, 11, 12, 13, then knit to Row 664. ON CAM BOX SIDE, bind off 2 sts. after Rows 664, 665, 666, 667, 668, 669, 670, 671, 672, 673, 674, 675. After Row 676 hang the remaining 3 sts. together, then bind off. Make 1 more section the same.

Cast on 3 sts. with color 2 and work stockinette st. ON CAM BOX SIDE, increase 2 sts. after Rows 2, 3, 4, 5, 6, 7, 8, 9, 10, 11, 12, 13, then knit to Row 898. ON CAM BOX SIDE, bind off 2 sts. after Rows 898, 899, 900, 901, 902, 903, 904, 905, 906, 907, 908, 909. After Row 910 hang the 3 remaining sts. together and bind off. Make 1 more section the same.

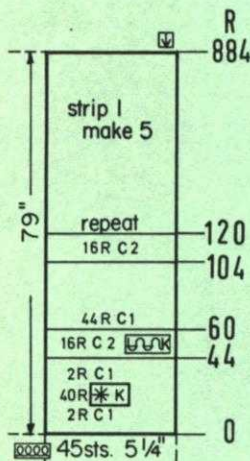

Cast on 45 sts. with color 1 and work stockinette st. After Row 2 work the Norwegian Design. After Row 42 change to stockinette st. and color 1. After Row 44 change to color 2. After Row 60 change to color 1. After Row 104 change to color 2. After Row 120 change to color 1 and repeat. After Row 884 bind off all sts. Make 4 more sections the same.

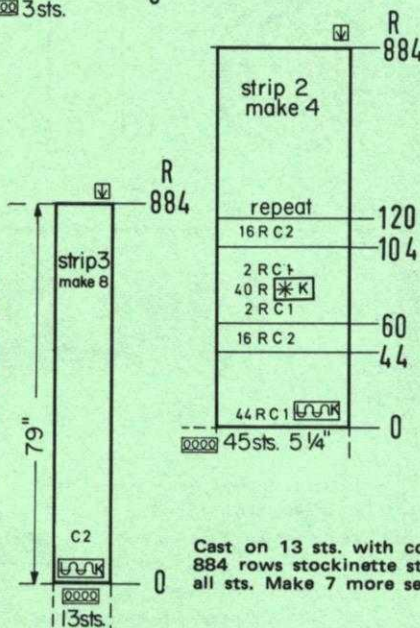

Cast on 45 sts. with color 1 and work stockinette st. After Row 44 change to color 2. After Row 60 change to color 1. After Row 62 work the Norwegian Design. After Row 102 change to stockinette st. and color 1. After Row 104 change to color 2. After Row 120 change to color 1 and repeat. After Row 884 bind off all sts. Make 3 more sections the same.

Cast on 13 sts. with color 2 and work 884 rows stockinette st., then bind off all sts. Make 7 more sections the same.



KG 1973 PILLOW or PAJAMA BAG

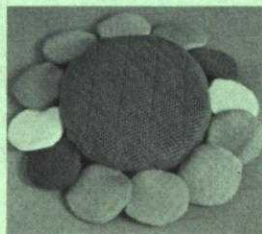

MATERIAL: 2 50 gr. Balls Knitking Allegro for the Pillow and small amounts of yarn (assorted colors) for the 12 small double circles. **TENSION:** 7 to 9. **GAUGE:** Pattern Stitch: 11 sts. 27 rows = 2"; Stockinette Stitch: 16 sts. 21 rows = 2". **PATTERN:** PILLOW: Purl side Holding Position Design according to the Line Drawing. **SMALL CIRCLES:** Knit side Stockinette Stitch.

FINISHING: Block the sections. Join the pillow sections half way around. Sew a zipper to the other half. Insert a thin layer of foam rubber into the small circles, then sew them together. Sew the circles evenly spaced around the pillow.

KG 1969 SHOULDER BAG

MATERIAL: 4 50 gr. Balls Knitting Sport Prima. **TENSION:** 7 to 9. **GAUGE:** Pattern Stitch: 13 sts, 23 rows = 2"; Stockinette Stitch: 14 sts, 19 rows = 2". **PATTERN:** Purl side Holding Position Design. **BINDING:** Knit side Stockinette Stitch. To form the hem, hang the cast-on sts. back onto the machine behind the latches, then knit the following row with a larger tension setting.

FINISHING: Block the sections. Fold the bag section in half and close the side edges. Sew 1 edge of the binding to the inside and 1 edge to the outside of the shaped flap edges. Work 8 rows of single crochet on the lower edge of the flap, then attach fringes. Sew the long edges of the strap together, then fasten the strap to the side edges of the bag. (See picture). Line the bag with sturdy material.

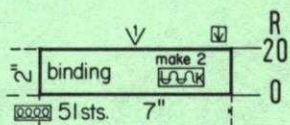
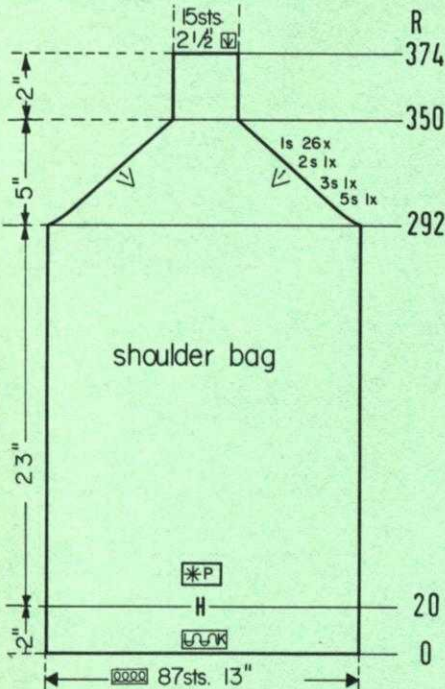
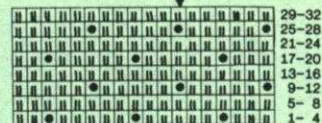

Cast on 51 sts. and work 20 rows stockinette st., then bind off all sts.

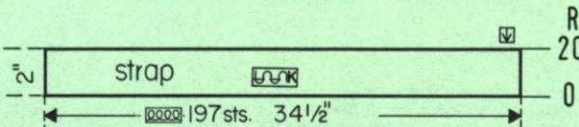

Cast on 197 sts. and work 20 rows stockinette st., then bind off all sts.

Cast on 87 sts. Work stockinette st. to Row 20, then form the hem and begin the Holding Position Design. Knit to Row 292. ON CAM BOX SIDE, bind off 5 sts. after Rows 292, 293; 3 sts. after Rows 294, 295; 2 sts. after Rows 296, 297. ON EACH SIDE, decrease 1 st. after Row 298, then again after every 2nd row 25 times more. After Row 350 knit even to Row 374, then bind off the remaining 15 sts.

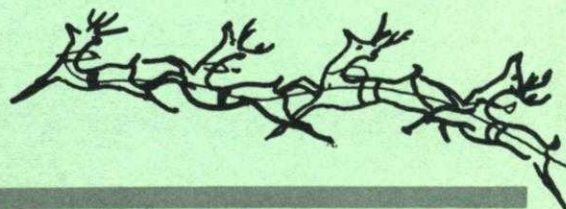

Cast on 39 sts. and work Short Rows. Put 16 needles ON EACH SIDE of the center 7 needles into holding position. Knit 2 rows. ON OPPOSITE SIDE of CAM BOX bring back into working position 3 needles after Rows 2, 3, 4, 5; 2 needles after Rows 6, 7, 8, 9, 10, 11; 1 needle after Rows 12, 13, 14, 15, 16, 17, 18, 19, then knit to Row 32. ON OPPOSITE SIDE of CAM BOX put into holding position 1 needle after Rows 32, 33, 34, 35, 36, 37, 38, 39; 2 needles after Rows 40, 41, 42, 43, 44, 45; 3 needles after Rows 46, 47, 48, 49; 7 needles remain in working position. ON OPPOSITE SIDE of CAM BOX bring back into working position 3 needles after Rows 50, 51, 52, 53; 2 needles after Rows 54, 55, 56, 57, 58, 59; 1 needle after Rows 60, 61, 62, 63, 64, 65, 66, 67, then knit to Row 82. ON OPPOSITE SIDE of CAM BOX put into holding position 1 needle after Rows 82, 83, 84, 85, 86, 87, 88, 89; 2 needles after Rows 90, 91, 92, 93, 94, 95; 3 needles after Rows 96, 97, 98, 99, then knit to Row 100, bring all needles back into working position and bind off all 39 sts. Work 11 more sections the same.

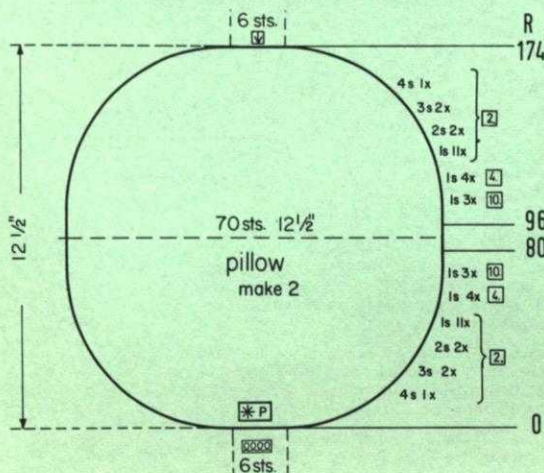
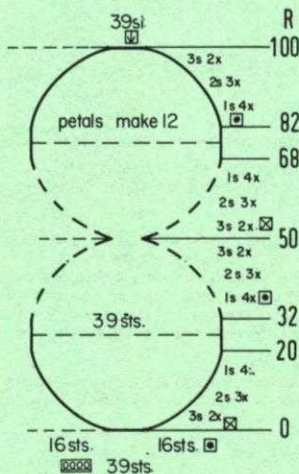
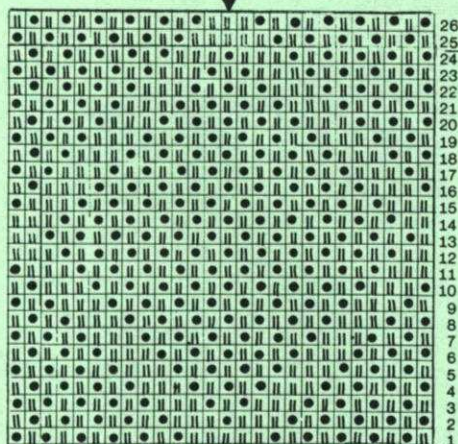

ON EACH SIDE, decrease 1 st. after Rows 96, 106, 116, 126, 130, 134, 138, 142, 144, 146, 148, 150, 152, 154, 156, 158, 160, 162. ON CAM BOX SIDE, bind off 2 sts. after Rows 164, 165, 166, 167; 3 sts. after Rows 168, 169, 170, 171; 4 sts. after Rows 172, 173; 6 sts. after Row 174. Work 1 more section the same.

ON CAM BOX SIDE, cast on 4 sts. after Rows 2, 3; 3 sts. after Rows 4, 5, 6, 7; 2 sts. after Rows 8, 9, 10, 11. ON EACH SIDE, increase 1 st. after Rows 12, 14, 16, 18, 20, 22, 24, 26, 28, 30, 32, 34, 38, 42, 46, 50, 60, 70, then knit to Row 96.

Cast on 6 sts. with color 1 and work the Holding Position Design.



KG 1970 SHAWL

MATERIAL: 50 gr. Balls Knitking Dolly Crepe; 5 color 1 and 1 color 2.
TENSION: 7 to 9
GAUGE: 13 sts., 20 rows = 2".

PATTERN: Stockinette Stitch, having 3 needles in working position and 3 needles in non-working position all the way across. The omitted needles do count as stitches in the gauge and instructions. Stay in Pattern while increasing 3 sts. For the first increase, leave 2 needles in the non-working position, then cast on 1 st. on the next needle = 3 sts. For the second 3 st. increases, move the 1st st. 1 needle outward, then cast on 2 sts. next to it = 3 sts. Repeat.

FINISHING: Block the sections. Join the sections at center back. Easing in to 43", work 17 rows of single crochet on the straight long edge of the scarf, alternating 2 rows with color 1 and 2 rows with color 2. Finish with 1 row of backward single crochet. Attach fringe to the shaped long edge.

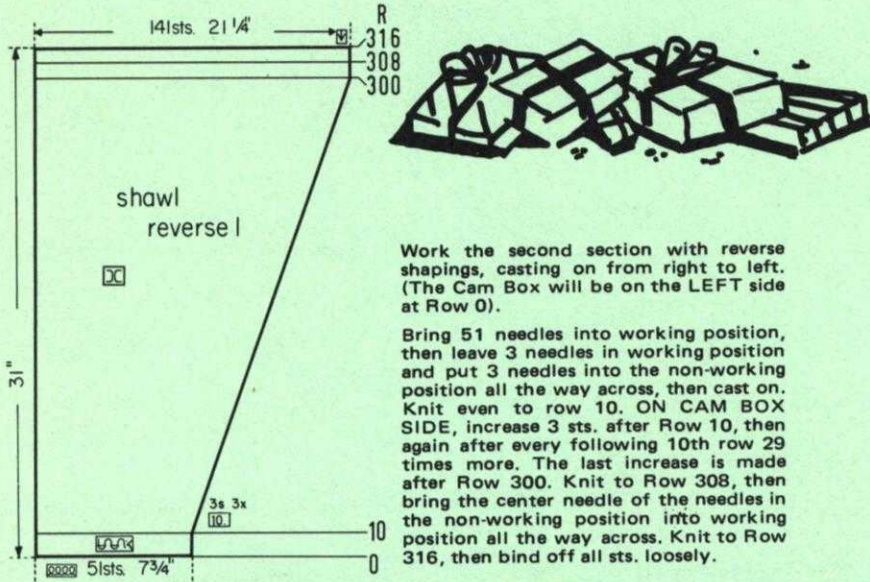
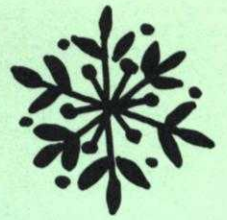

KG 1974 BABY JACKET and BONNET

SIZE: 3 to 6 months.
YARN: Allegro Dralon. 50 gr. Balls. 2 Color 1; 1 Color 2; 1 Color 3.
TENSION: 8 to 10
GAUGE: 8 sts., 36 Rows = 2"
 out of work needles are NOT counted in the stitch gauge or instructions.

PATTERN: Use EVERY OTHER NEEDLE for all Cast-on stitches. KNITTING machine owners can set up the pattern for first Row then use Needle Shifter after Every 4 rows. See line drawing for color change.

FINISHING: JACKET: Join fronts to back at sides and shoulders, leaving 4" open at top for the armholes. Sew sleeve seams and set in. With No. 2 or 3 Crochet Hook work 1 row single crochet around all edges with Color 1. Work the second row as follows: 5 double crochet into first single crochet, skip 1 sc, 1 sc into next sc; *skip 1, 5 dc into next sc; Skip 1, 1 sc into next sc. Repeat from * around. Pull a twisted cord through the row of double crochet around neck then sew Pom-Poms to the ends of cord. (See KNITTING Practical Knitting Hint Book - Pages 58 and 61).

BONNET: Join the back of the Bonnet to the sides. Crochet around edges in the same way as on the Jacket. Pull a twisted cord through the double crochet row for ties. (See Picture).

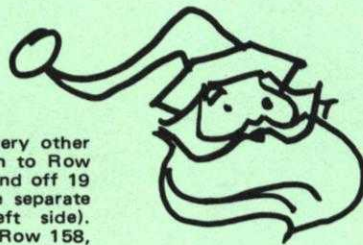
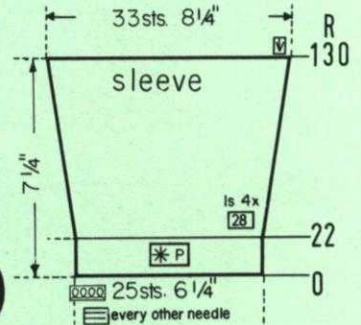
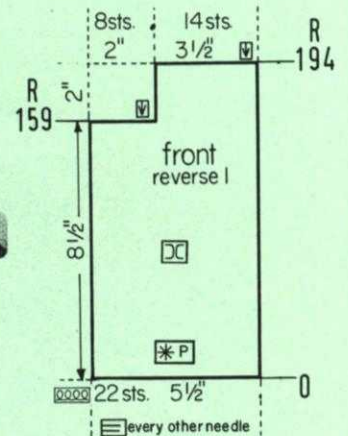
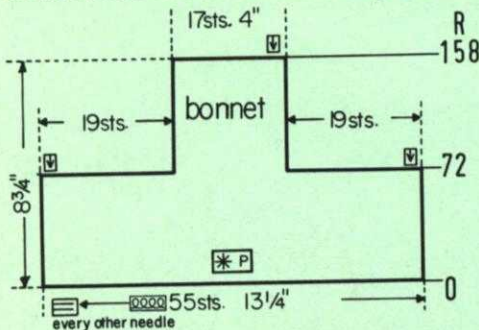

PATTERN

Rows 1 to 4: Put the 2nd, then every 2nd needle into holding position, knit 4 rows. Bring the needles back into working position.

Rows 5 to 8: Put the 1st, then every 2nd needle into holding position, knit 4 rows. Bring the needles back into working position.

REPEAT ROWS 1 to 8 for Pattern. The Purl side is the right side.

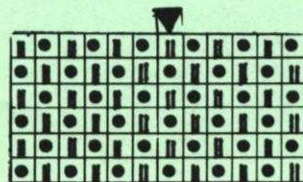

KG 1971 LAMP SHADE COVER

MATERIAL: 3 50gr. balls Knitning Sport Prima = color 1 and 1 spool Monofil = color 2. Lamp Shade approximately 10" diameter. **TENSION:** 8 to 10. **GAUGE:** 13 sts. 14 rows = 2". **PATTERN:** Norwegian Design according to the Line Drawing or use JAC 40 and Pattern No. 472. In the instructions, each row in the Norwegian Design is counted as 1 row, but several movements of the Cam Box are needed to complete 1 row.

FINISHING: Block the section and steam. Weave the open sts. together, using Monofil. Remove the contrast waste yarn. Pull the cover over the shade, then gather the upper edge and the lower edge together and sew in place. Work a knitted cord about 55" long, then sew the cord to the lower edge of the cover, forming loops. (See picture). (For the knitted cord, see Practical Hint Book, Page 58).

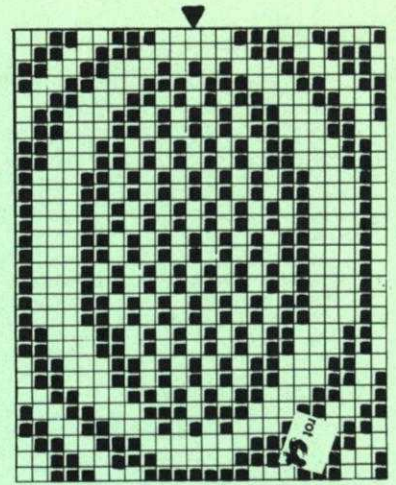
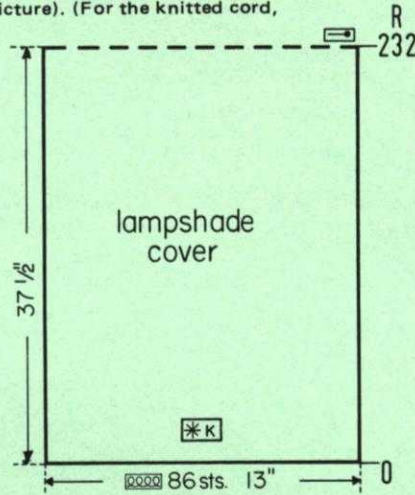

□ - COLOR 1 ■ - COLOR 2

Using contrast waste yarn, cast on 86 sts. Knit several rows, ending with the Cam Box on the right side. Turn the Row Counter back to 0 and begin the Norwegian Design. Knit 232 rows, then knit several rows with contrast waste yarn and remove the knitting from the machine.

BACK: Cast on 45 sts. over every other needle. Knit even in Pattern to Row 180. Bind off the center 17 sts. Put the needles on the left side into holding position and complete the right half first. Continue in Pattern to Row 194, then bind off. Bring the needles on the left side into working position, turn the Row Counter back to 180 and complete the left half.

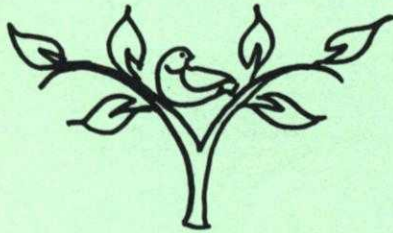

FRONT: Cast on 22 sts. over every other needle. Work in Pattern to Row 159. Bind off 8 sts. Continue in pattern to Row 194, then bind off all sts. Work the second front section with reverse shaping (cast on in the same way because of working pattern) and bind off for the armhole after Row 158 (on the right side) then knit in Pattern to Row 194 and bind off all sts.



SLEEVES: Make 2. Cast on 25 sts. over EVERY OTHER NEEDLE. Work in Pattern. ON EACH SIDE, increase 1 st. after Rows 22, 50, 78, 106, then knit even in Pattern to Row 130 and bind off all sts.

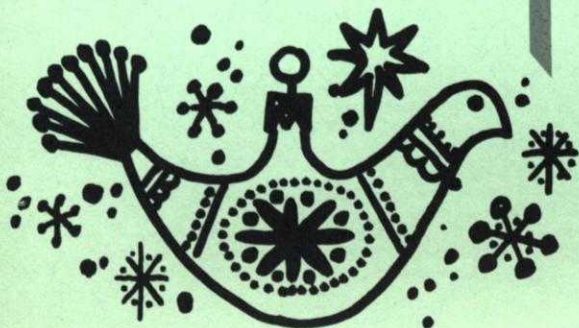

KG 1966 HANGER COVER

MATERIAL: Small amounts of assorted colors of yarn (Knitning Allegro, Melodie, Crocus Crepe, etc.). **TENSION:** 6 to 8. **GAUGE:** 15 sts. 21 rows = 2". **PATTERN:** Stockinette Stitch.

FINISHING: Remove the hook from the hanger. Sew the long edge of the cover together, slip over the hanger and close the short ends. Sew the head together at sides and fill with yarn remnants. Sew the short ends of the hat together. Gather the bound-off sts. together tightly. Sew the hat to the head. Embroider a face to the head. (See picture). For the collar, cut strips of bias from material, sew the short ends together, gather 1 long edge and sew to the lower part of the head. Push the hanger hook through the hat and head then into the hanger.

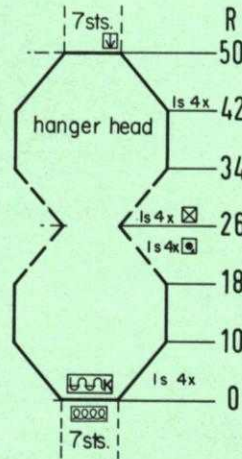
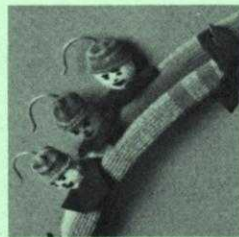

Cast on 7 sts. and work stockinette st. ON EACH SIDE, increase 1 st. after Rows 2, 4, 6, 8, then knit to Row 18 and work Short Rows. ON OPPOSITE SIDE of CAM BOX put into holding position 1 needle beginning the next 8 rows. ON OPPOSITE SIDE of CAM BOX bring back into working position 1 needle beginning the next 8 rows, then knit to Row 42. ON EACH SIDE, decrease 1 st. after Rows 42, 44, 46, 48. After Row 50 bind off the remaining 7 sts.

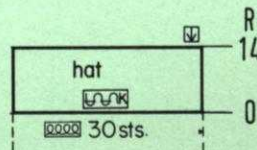
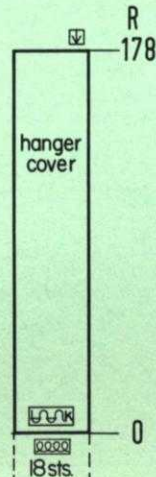

Cast on 30 sts. and work 14 rows stockinette st., then bind off all sts.

Cast on 18 sts. and work 178 rows stockinette st., then bind off all sts.



KG 1965 BABY BOOTIES

MATERIAL: One 50 gr. Ball Knitkng Beatrice (Makes 2 Pair)
TENSION: 7 to 9
GAUGE: 16 sts. 36 rows = 2"
PATTERN: Fisherman's Rib, worn on the purl side.

FINISHING: Pull the cast-on sts. together, tie and sew in the ends. Join the instep seam. Make a knitted or knotted cord and pull through cuff of bootie.

Cast on 35 sts. using the automatic cast-on for ribbing (see Practical Knitting Hint Book, Page 78). Work 4 rows K1, P1, Ribbing, then place the Gate Cam Release Lever of the main machine to the needle heels and work Fisherman's Rib. Knit to Row 32, then cast on 8 sts. ON EACH SIDE. (Use a separate strand of yarn for the left side). Knit to Row 72 over 51 sts. Transfer the ribber sts. to the main machine, then put the first 25 sts. onto a double pointed needle. Now put these sts. onto the remaining 26 sts., beginning with the 2nd occupied needle, then bind off all sts.

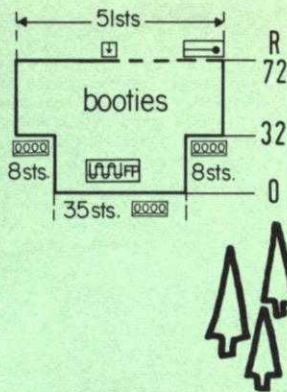

KG 1972 SLIPPERS KG 1968 SHRUG

MATERIAL: 50 gr. Balls Knitkng Mohana. Slippers, 2 balls; Scarf, 5 balls.
TENSION: 9 to 10
GAUGE: Fisherman's Rib 14 sts. 26 rows = 2"; K1, P1, Rib. 14 sts. 18 rows = 2"
PATTERN: Fisherman's Rib. EDGES: K1, P1, Rib.

FINISHING: SHAWL: Fold and join the long edges for 10" on each end. **SLIPPERS:** Pull the cast-on sts. together, tie and sew in the ends. Join the instep seam. Using 2 strands of yarn, crochet a chain stitch cord, then pull the cord through the cuff section.

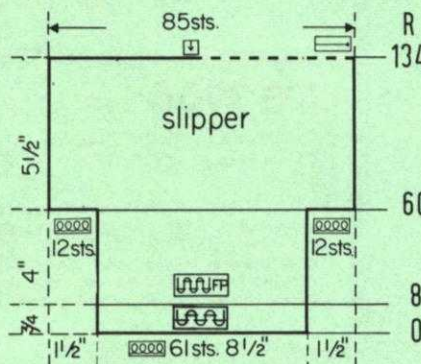
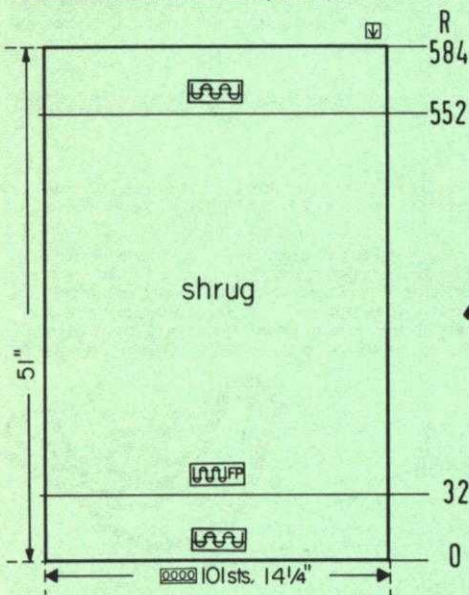
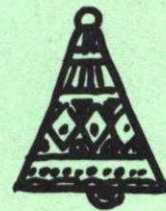

Cast on 101 sts. and work 32 rows K1, P1, Ribbing, then place the Gate Cam Release Lever of the main machine to the needle heels and work Fisherman's Rib to Row 552. Replace the Gate Cam Release Lever and work K1, P1, Ribbing to Row 584, then bind off all sts.

Cast on 61 sts., using the automatic cast-on for Ribbing (see Practical Knitting Hint Book, Page 78) and work 8 rows K1, P1, Ribbing. Place the Gate Cam Release Lever of the main machine to the needle heels and work Fisherman's Rib. Knit to Row 60, then cast on 12 sts. ON EACH SIDE. (Use a separate strand of yarn for the left side). Knit to Row 134, then transfer the ribber sts. to the main machine. (Replace the Gate Cam Release Lever). Put the first 42 sts. onto a double pointed needle, hang the sts. back onto the machine onto the occupied needles beginning with the 2nd needle. Now bind off all sts.



KG 1975 BABY CARRIAGE COVER

SIZE: Approximately 19" x 23"
MATERIAL: 4 - 50 gr. Balls Knitkng Allegro Dralon
TENSION: 7 to 9.
GAUGE: 14 sts., 34 Rows = 2".

PATTERN: ROWS 1 to 4: Put the 1st, then every 4th needle into holding position, knit 4 rows. Bring the needles back into working position.
ROWS 5 to 8: Put the 3rd, then every 4th needle into holding position, knit 4 rows. Bring the needles back into working position.
REPEAT Rows 1 to 8 for Pattern.
KNITTING MACHINE OWNERS, use Wheel No. 3 and push in the LEFT RETRACTOR BUTTON BEFORE knitting each 4th row, then release the button AFTER knitting each 4th row.

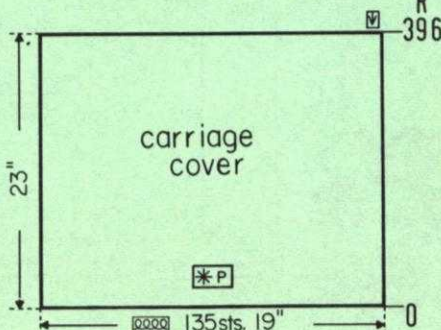

Cast on 135 sts. Knit 2 rows stockinette stitch, then put the Counter at 0. Knit in Pattern to Row 396. Bring all the needles back into working position and knit 2 rows stockinette stitch, then bind off all sts.

FINISHING: Use No. 0 or 1 Crochet Hook. With a double strand of yarn, work 1 row single crochet around all edges. **ROW 2:** 3 treble crochet into 1st single crochet picking up only the back thread of the single crochet stitch. Chain 1, skip 2 sc, 3 treble crochet into next st. *Ch 1, skip 2, 3 treble crochet into next stitch. **REPEAT** from * around. **ROW 3:** Single crochet into each st. Pull a velvet ribbon through the treble crochet row. (See picture).

HP 3704

SIZE:	38 (Chest 38"-39")	42 (Chest 41"-42")
YARN:	Regia = color 1 Alanda = color 2	Regia = color 1 Alanda = color 2
50 gr. BALLS:	4 color 1 4 color 2	4 color 1 4 color 2
TENSION:		
Pattern:	3 to 5	4 to 6
Ribbing:	7 to 9	8 to 10
GAUGE:	2"	
Pattern:	13 sts. 42 rows	12 sts. 40 rows
Ribbing:	13 sts. 25 rows	12 sts. 24 rows



The instructions are the same for both sizes. PATTERN: Weaving Pattern using the Weaving Attachment. Follow the Line Drawing, or use JAC 40 and Pattern No. 473. Regia (color 1) is the Foundation Yarn, Alanda (color 2) is the Weaving yarn. EDGES: K1, P1, Ribbing with color 2. To increase, place the end st. from the row below onto the next empty needle.

FINISHING: Block the sections. Join the front and back section at sides and shoulders. Sew the short ends of the neckband and the short ends of the armhole bands together, then sew the bands in place.

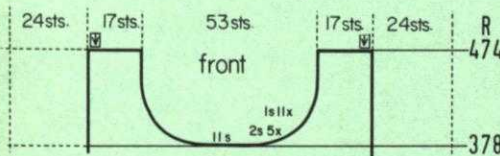
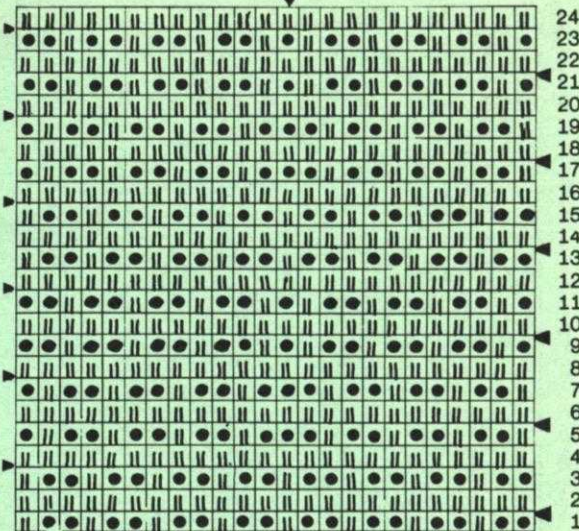

Bring the needles on the left side into working position, knit 1 row in PATTERN to the left side, turn the Row Counter back to 378 and complete the left half. Follow the instructions from*.

*ON CAM BOX SIDE, bind off 2 sts. after Rows 379, 381, 383, 385, 387; 1 st. after Rows 389, 391, 393, 395, 397, 399, 401, 403, 405, 407, 409. After Row 474 bind off the remaining 17 sts. (Shoulder sts.)

Work the front section the same as the back section to ROW 378, then bind off the center 11 sts., put the needles on the left side into holding position and complete the right half first.

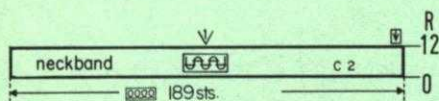

Cast on 189 sts. with color 2 and work 12 rows K1, P1, Ribbing, then bind off all sts.

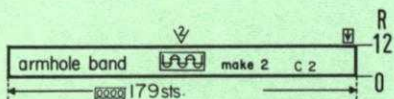

Cast on 179 sts. with color 2 and work 12 rows K1, P1, Ribbing, then bind off all sts.

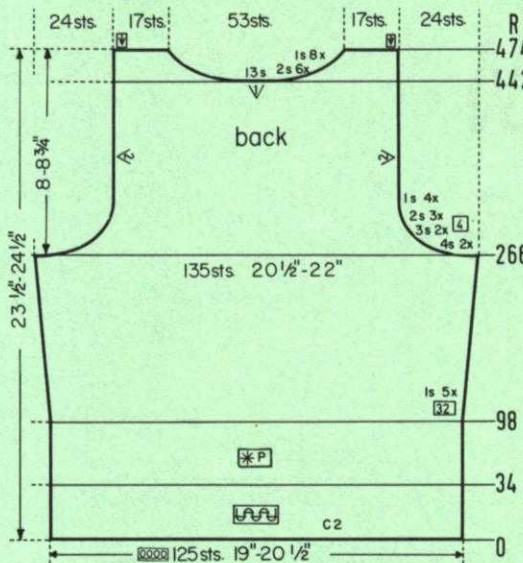

Bring the needles on the left side into working position, knit 1 row in PATTERN to the left side, turn the Row Counter back to 442 and complete the left half. Follow the instructions from*.

*ON CAM BOX SIDE, bind off 2 sts. after Rows 443, 445, 447, 449, 451, 453; 1 st. after Rows 455, 457, 459, 461, 463, 465, 467, 469. After Row 474 bind off the remaining 17 sts. (Shoulder sts.)

ON CAM BOX SIDE, bind off 4 sts. after Rows 266, 267, 270, 271; 3 sts. after Rows 274, 275, 278, 279; 2 sts. after Rows 282, 283, 286, 287, 290, 291; 1 st. after Rows 294, 295, 298, 299, 302, 303, 306, 307, then knit to Row 442, bind off the center 13 sts., put the needles on the left side into holding position and complete the right half first. (For the Front Section knit to Row 378).

ON EACH SIDE, increase 1 st. after Rows 98, 130, 162, 194, 226, then knit to Row 266.

ROWS 35 to 98: Knit even.

ROWS 0 to 34: Knit even, then transfer the ribber sts. to the main machine and work the Weaving Pattern.

Cast on 125 sts. with color 2 and work K1, P1, Ribbing.

HP 3703

SIZE:	40 (Chest 40"-41")	44 (Chest 43"-44")	46 (Chest 46"-47")
YARN:	Sport Prima	Dolly Dralon	Dolly Dralon
50 gr. BALLS:	17 color 1 2 color 2	14 color 1 2 color 2	15 color 1 2 color 2
TENSION:	7 to 9	8 to 10	9 to 10
GAUGE:	2" 15 sts. 20 rows	14 sts. 20 rows	13 sts. 19 rows

The instructions are the same for all sizes. PATTERN: Stockinette Stitch. DECREASES: Hang the 3rd st. onto the 2nd st., then move the end sts. inward to fill the empty needle. INCREASES: Move the 2 end sts. 1 needle outward, then place the 3rd st. from the row below onto the empty needle. To form the hem, hang the cast-on sts. back onto the machine behind the latches, then knit the following row with 1 or 2 tension settings higher.

FINISHING: Block all sections. Join the back and the front sections at sides and shoulders. Sew the sleeves together and set in. Join the collar sections at center back. Turn under 8 rows on the upper edges of the pockets and hem. Sew the pockets in place. Join the facing sections at center back, then sew the facing in place. Cast on 11 sts. with color 2 for the binding. Knit 690 rows stockinette st., then bind off the sts. Sew 1 edge of the binding to inside and 1 edge to the outside of the front edges and the collar. Join the long edges of the belt and close the open short ends.



Continued on page 24

HP3703

Continued from page 23

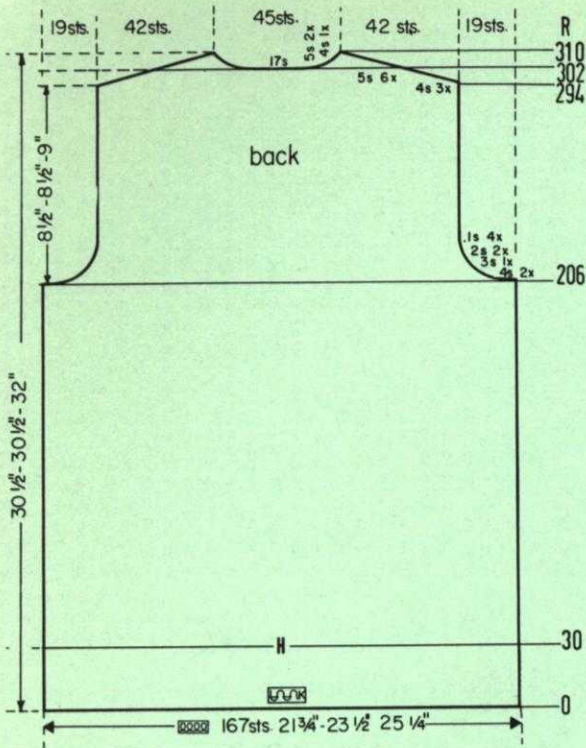

Move the Cam Box to the left side, turn the Row Counter back to 302 and complete the left half. Follow the instructions from*.

*ON CAM BOX SIDE, bind off 5 sts. after Rows 302 (EVEN ROWS = SHOULDER SHAPING), 303 (ODD ROWS = NECK SHAPING), 304, 305, 306; 4 sts. after Row 307; 5 sts. after Rows 308, 310.

ON CAM BOX SIDE, bind off 4 sts. after Rows 294, 295, 296, 297, 298, 299; 5 sts. after Rows 300, 301, then knit to Row 302, bind off the center 17 sts., put the needles on the left side into holding position and complete the right half first.

ON CAM BOX SIDE, bind off 4 sts. after Rows 206, 207, 208, 209; 3 sts. after Rows 210, 211; 2 sts. after Rows 212, 213, 214, 215; 1 st. after Rows 216, 217, 218, 219, 220, 221, 222, 223, then knit to Row 294.

ROWS 31 to 206: Knit even.

ROWS 0 to 30: Knit even, then form the hem.

Cast on 167 sts. with color 1 and work stockinette st.

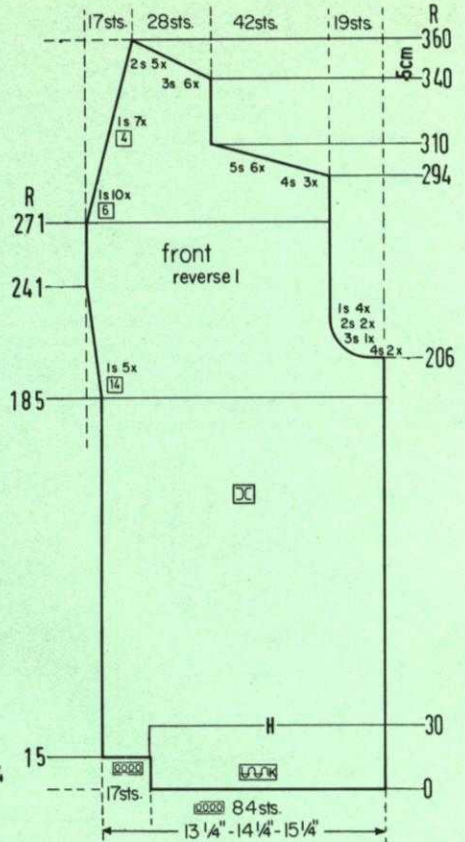

ON CAM BOX SIDE, bind off 4 sts. after Rows 190, 191, 192, 193; 3 sts. after Rows 194, 195, 196, 197, 198, 199; 2 sts. after Rows 200, 201, 202, 203, 204, 205. ON EACH SIDE, hang the 1st st. onto the 2nd st. after Rows 206, 208, 210, 212, 214, 216, 218, 220, 222, 224, 226, 228, 230, 232, 234, 236. ON CAM BOX SIDE, bind off 2 sts. after Rows 238, 239; 4 sts. after Rows 240, 241; 6 sts. after Rows 242, 243; 13 sts. after Row 244.

ON EACH SIDE, increase 1 st. after Rows 30, 38, 46, 54, 62, 70, 78, 86, 94, 102, 110, 118, 126, 134, 142, 150, 158, 166, 174, 182, then knit to Row 190.

ROWS 0 to 30: Knit even, then form the hem.

Cast on 75 sts. with color 1 and work stockinette st.

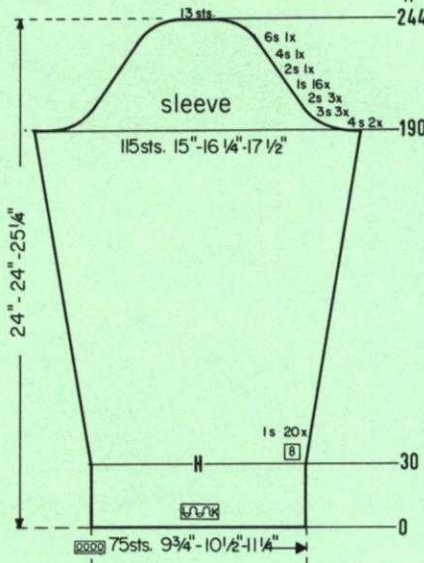

Work the second facing with reverse shapings, casting on from right to left. (Cam Box will be on the LEFT side at Row 0).

ON FRONT EDGE (EVEN NUMBERED ROWS) decrease 1 st. and on SIDE EDGE (ODD NUMBERED ROWS) increase 1 st. after Rows 256, 259, 262, 263, 267, 268, 271, 274, 275, 279, 280, 283, 286, 287, 291, 292, then knit to Row 295 and bind off 8 sts. ON CAM BOX SIDE. Continue to decrease 1 st. ON CAM BOX SIDE (FRONT EDGE) after Rows 298, 304, 310, 316, 320, 324, then again after Rows in (). ON CAM BOX SIDE, bind off 3 sts. after Rows 325, 327, (328), 329, 331, (332), 333, 335; (336), 2 sts. after Rows 337, 339, (340), 341, 343, 345.

ON CAM BOX SIDE, increase 1 st. after Rows 170 (EVEN ROWS = FRONT EDGE), 171 (ODD ROWS = SIDE EDGE), 175, 179, 183, 184, 187, 191, 195, 198, 199, 203, 207, 211, 212, 215, 219, 223, 226, 227, 231, 235, 239, 243, 247, 251, 255, then knit to Row 256.

ROWS 0 to 70: Knit even.

Cast on 17 sts. with color 1 and work stockinette st.

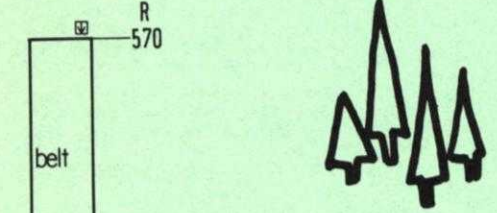

Cast on 22 sts. with color 1. Work stockinette st. and the repeated color stripes as marked in the Diagram. After Row 570 bind off all sts.

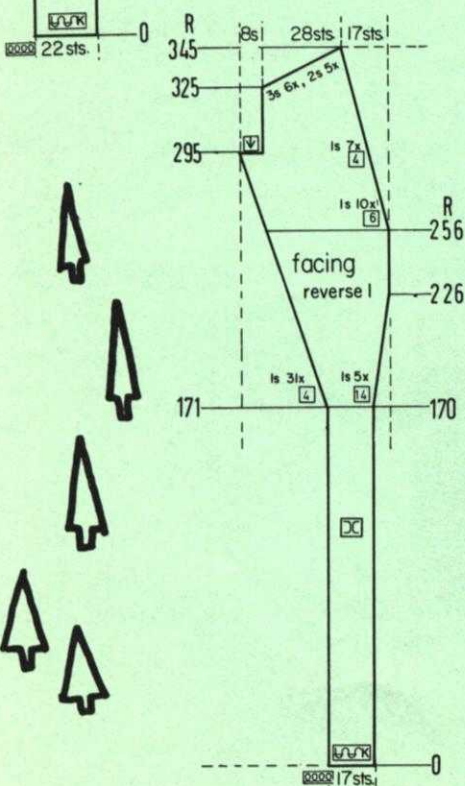

Work the second facing with reverse shapings, casting on from right to left. (Cam Box will be on the LEFT side at Row 0).

ON FRONT EDGE (EVEN NUMBERED ROWS) decrease 1 st. and on SIDE EDGE (ODD NUMBERED ROWS) increase 1 st. after Rows 256, 259, 262, 263, 267, 268, 271, 274, 275, 279, 280, 283, 286, 287, 291, 292, then knit to Row 295 and bind off 8 sts. ON CAM BOX SIDE. Continue to decrease 1 st. ON CAM BOX SIDE (FRONT EDGE) after Rows 298, 304, 310, 316, 320, 324, then again after Rows in (). ON CAM BOX SIDE, bind off 3 sts. after Rows 325, 327, (328), 329, 331, (332), 333, 335; (336), 2 sts. after Rows 337, 339, (340), 341, 343, 345.

ON CAM BOX SIDE, increase 1 st. after Rows 170 (EVEN ROWS = FRONT EDGE), 171 (ODD ROWS = SIDE EDGE), 175, 179, 183, 184, 187, 191, 195, 198, 199, 203, 207, 211, 212, 215, 219, 223, 226, 227, 231, 235, 239, 243, 247, 251, 255, then knit to Row 256.

ROWS 0 to 70: Knit even.

Cast on 17 sts. with color 1 and work stockinette st.

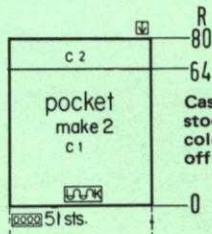

Cast on 51 sts. with color 1 and work stockinette st. After Row 64 change to color 2 and work to Row 80, then bind off all sts.

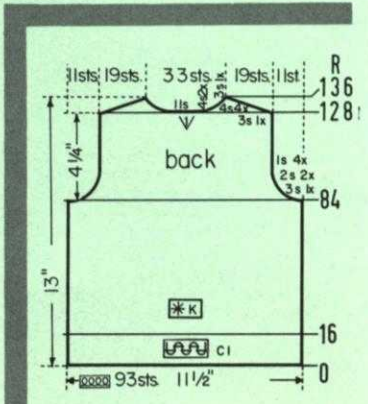
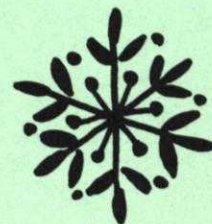

Work the second front section with reverse shapings, casting on from right to left. (Cam Box will be on the LEFT side at ROW 0).

ON CAM BOX SIDE, bind off 3 sts. after Rows 340, 342, (343), 344, 346, (347), 348, 350; (351), 2 sts. after Rows 352, 354, (355), 356, 358, 360.

ON CAM BOX SIDE, (SHOULDER), bind off 4 sts. after Rows 294, (295), 296, 298; 5 sts. after Rows 300, (301), 302, 304, 306, (307), 308, 310. The Shoulder Shaping is now completed. Continue to decrease 1 st. on FRONT EDGE after Rows 313, 319, 325, 331, 335, 339, then again after Rows in (). Knit to Row 340.

ON CAM BOX SIDE, (FRONT EDGE) decrease 1 st. after Rows 271, 277, 283, 289, then again after Rows in (). Knit to Row 294.

ON CAM BOX SIDE, bind off 4 sts. after Rows 206, 208; 3 sts. after Row 210; 2 sts. after Rows 212, (213), 214; 1 st. after Rows 216, 218, 220, 222, (227), (241), then knit to Row 271.

ON CAM BOX SIDE, (FRONT EDGE) increase 1 st. after Rows 185, 199, then again after Rows in (). Knit to Row 206.

ROWS 31 to 185: Knit even.

ROWS 16 to 30: Knit even, then form the hem. (First 84 cast-on sts. only).

ROWS 0 to 15: Knit even, then cast on 17 sts. ON CAM BOX SIDE.

Cast on 84 sts. with color 1 and work stockinette st.



KK 5440

SIZE: 1 to 2 years
 YARN: Regia
 50 gr. BALLS:
 Pullover: 2 color 1, 1 color 2, 1 color 3
 Pants: 3 color 3
 Tites: 3 color 2
 TENSION: 4 to 6
 GAUGE: 2"
 Stock: 17 sts. 22 rows
 Pattern: 16 sts. 20 rows

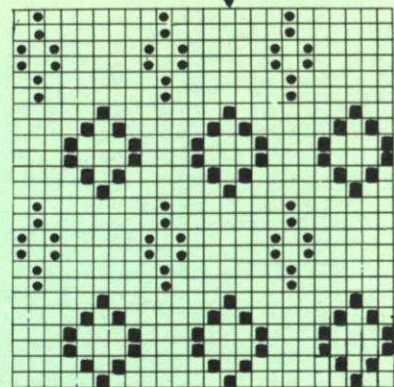

□ = COLOR 1 ■ = COLOR 2 ◻ = COLOR 3

PATTERN: Pants and Tites: Stockinette Stitch. Pullover: Norwegian Design according to the Line Drawing. In the instructions, each row in the Norwegian Design is counted as 1 row, but several movements of the Cam Box are needed to complete 1 row. Edges: K1, P1, Ribbing. DECREASES: Hang the 3rd st. onto the 2nd st., then move the end sts. inward to fill the empty needle. INCREASES: Move the 2 end sts. 1 needle outward, then place the 3rd st. from the row below onto the empty needle. Begin the Pants Dart by hanging the sts. together as marked on the Diagram, then move the sts. together to fill the empty needles. The following decreases, then increases lie directly above.

FINISHING: Block all sections. PULLOVER: Join the front and back section at sides and shoulders, leaving 2" open on the left shoulder. Turn under a small amount around the opening and hem in place. Sew the sleeves together and set in. Sew 1 edge of the neckband to inside and 1 edge to outside of the neckline. Work 3 loops and sew 3 buttons on the shoulder opening. PANTS: Sew the inner leg seams together. Join the sections at center back and front. Turn under 11 rows on the upper edge and 18 rows on the leg edges and hem in place. Insert an elastic band into the upper hem. TITES: Sew the inner leg seams together. Join the sections at center back and front. Weave the open sts. together to form the heels. Join the sole to the instep at sides. Turn under 9 rows on the upper edge, hem in place and insert an elastic band.

Bring the needles on the left side into working position, knit 1 row in PATTERN to the left side, turn the Row Counter back to 116 and complete the left half. Follow the instructions from*.

*ON CAM BOX SIDE, bind off 3 sts. after Row 117 (ODD ROWS = NECK SHAPING); 2 sts. after Rows 119, 121, 123; 1 st. after Rows 125, 127; 3 sts. after Row 128 (EVEN ROWS = SHOULDER SHAPING); 1 st. after Row 129; 4 sts. after Rows 130, 132, 134, 136.

Work the front section the same as the back section to ROW 116, then bind off the center 9 sts., put the needles on the left side into holding position and complete the right half first.

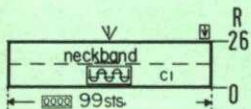
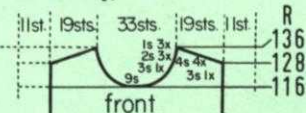
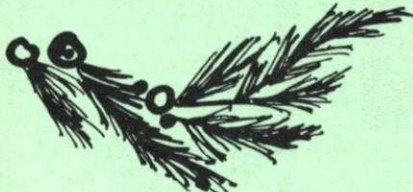

Cast on 99 sts. with color 1 and work 26 rows K1, P1, Ribbing, then bind off all sts.

Bring the needles on the left side into working position, knit 1 row in PATTERN to the left side, turn the Row Counter back to 128 and complete the left half. Follow the instructions from*.

*ON CAM BOX SIDE, bind off 3 sts. after Row 128 (EVEN ROWS = SHOULDER SHAPING); 4 sts. after Rows 129 (ODD ROWS = NECK SHAPING), 130, 131, 132; 3 sts. after Row 133; 4 sts. after Rows 134, 136.

ON CAM BOX SIDE, bind off 3 sts. after Rows 84, 85; 2 sts. after Rows 86, 87, 88, 89; 1 st. after Rows 90, 91, 92, 93, 94, 95, 96, 97, then knit to Row 128, bind off the center 11 sts., put the needles on the left side into holding position and complete the right half first. (For the Front Section knit to ROW 116).

ROWS 17 to 84: Knit even.

ROWS 0 to 16: Knit even, then transfer the ribber sts. to the main machine and begin the Norwegian Design.

Cast on 93 sts. with color 1 and work K1, P1, Ribbing.

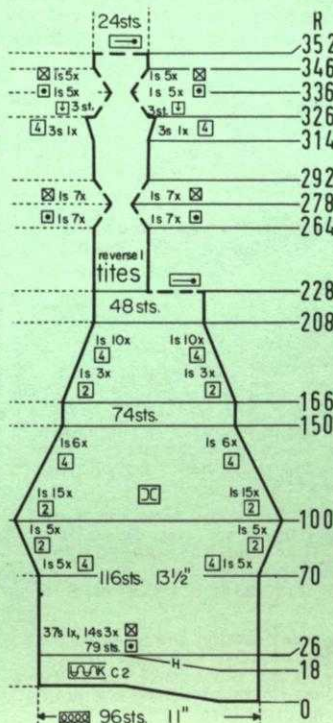

Work the second section with reverse shapings, casting on from right to left. (Cam Box will be on the LEFT side at Row 0).

ON EACH SIDE, increase 1 st. after Rows 314, 318, 322, then knit to Row 326 and bind off 3 sts. ON EACH SIDE. (Use a separate length of yarn for the left side). Work Short Rows for the HEEL. ON OPPOSITE SIDE of CAM BOX put into holding position 1 needle after Rows 326, 327, 328, 329, 330, 331, 332, 333, 334, 335. ON OPPOSITE SIDE of CAM BOX bring back into working position 1 needle after Rows 336, 337, 338, 339, 340, 341, 342, 343, 344, 345, then knit to Row 352 and put the sts. onto a stitch holder.

Knit to Row 264, then work Short Rows. ON OPPOSITE SIDE of CAM BOX put into holding position 1 needle after Rows 264, 265, 266, 267, 268, 269, 270, 271, 272, 273, 274, 275, 276, 277. ON OPPOSITE SIDE of CAM BOX bring back into working position 1 needle after Rows 278, 279, 280, 281, 282, 283, 284, 285, 286, 287, 288, 289, 290, 291, then knit to Row 314.

ON EACH SIDE, decrease 1 st. after Rows 100, 102, 104, 106, 108, 110, 112, 114, 116, 118, 120, 122, 124, 126, 128, 130, 134, 138, 142, 146, 150, 166, 168, 170, 172, 176, 180, 184, 188, 192, 196, 200, 204, 208, then knit to Row 228, put the first 24 sts. onto a stitch holder and continue working over the remaining 24 sts. for the instep, toes, sole and heel.

ON EACH SIDE, increase 1 st. after Rows 70, 74, 78, 82, 86, 90, 92, 94, 96, 98, then knit to Row 100.

Knit even to Row 18, then work Short Rows. ON OPPOSITE SIDE of CAM BOX put into holding position 79 needles after Row 18. ON OPPOSITE SIDE of CAM BOX bring back into working position 37 needles after Row 20; 14 needles after Rows 22, 24, 26, then knit to Row 70.

Cast on 96 sts. with color 2 and work stockinette st.

Continued on page 26

KK5440

Continued from page 25

Work the second section with reverse shapings, casting on from right to left. (Cam Box will be on the LEFT side at Row 0).

ON CAM BOX SIDE, bind off 4 sts. after Row 170 (EVEN ROWS = CENTER BACK); 3 sts. after Row 171 (ODD ROWS = CENTER FRONT); 4 sts. after Row 172; 2 sts. after Rows 173, 174, 175, 176, 177; 1 st. after Rows 178, 179, 180, 181, 182, 183, 184, 185, 188, 189, 192, 196, 204, 212, 220, 228, 236, but do not knit after the last decrease. Work Short Rows. ON OPPOSITE SIDE of CAM BOX put into holding position 31 needles after Row 236; 14 needles after Rows 238, 240, 242. After Row 244 bring all needles back into working position, then knit to Row 266 and bind off the remaining 92 sts.

Increase 1 st. ON OPPOSITE SIDE of CAM BOX after Rows in (). Increase 2 sts. for the DART after (DART). ON CAM BOX SIDE, increase 1 st. after Rows 108, (108), (DART 108), 112, (114), 116, 120, (120), (DART 122), 124, (126), 128, 132, (132), 136, (DART 136), (138), 140, 144, (144), 148, (150), (DART 150), 152, 156, (156), 160, (162), 164, (DART 164), 166, 168, then knit to Row 170.

Decrease 2 sts. for the DART and 1 st. ON EACH SIDE after Rows 34, 48, 62, 76, 90, then knit to Row 108.

ROWS 0 to 34: Knit even.

Cast on 113 sts. with color 3 and work stockinette st.

ON CAM BOX SIDE, bind off 3 sts. after Rows 92, 93, 94, 95, 96, 97; 2 sts. after Rows 98, 99, 100, 101; 1 st. after Rows 102, 103, 104, 105, 106, 107, 108, 109, 110, 111, 112, 113; 2 sts. after Rows 114, 115, 116, 117; 4 sts. after Rows 118, 119; 13 sts. after Row 120.

ON EACH SIDE, increase 1 st. after Rows 16, 26, 36, 46, 56, 66, 76, 84, then knit to Row 92.

ROWS 0 to 16: Knit even, then transfer the ribber sts. to the main machine and begin the Norwegian Design.

Cast on 51 sts. with color 1 and work K1, P1, Ribbing.

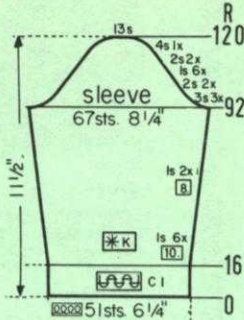
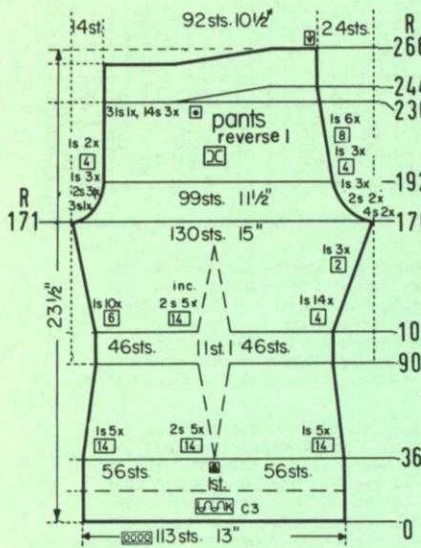

MK 5439

SIZE:	4 (Chest 23")	6 (Chest 24")	8 (Chest 26")
YARN:	Regia	Amore	Amore
50 gr. BALLS:	7 color 1 3 color 2	8 color 1 4 color 2	9 color 1 4 color 2
TENSION:	5 to 7	7 to 9	8 to 10
GAUGE:	2" 16 sts. 23 rows	15 sts. 23 rows	14 sts. 21 rows

The instructions are the same for all sizes. PATTERN: Stockinette Stitch with color stripes on the sleeves. EDGES: K1, P1, Ribbing. DECREASES: Hang the 3rd st. onto the 2nd st., then move the end sts. inward to fill the empty needle. Begin the DARTS by hanging the sts. together as marked on the Diagram, then move the sts. together to fill the empty needles. The following decreases (and increases on the center DART) lie directly above. INCREASES: Move the 2 end sts. 1 needle outward, then place the 3rd st. from the row below onto the empty needle.

FINISHING: Block all sections. PANTS: Sew the inner leg seams together, then join the sections at center back and front. Turn under 18 rows on the leg edges and 14 rows on the upper edge and hem in place. Insert an elastic band into the upper hem. PULLOVER: Join the front and back section at sides and shoulders, leaving 2" open on the left shoulder. Turn under a small amount around the opening and hem in place. Sew the sleeves together and set in. Sew 1 edge of the collar to inside and 1 edge to the outside of the neckline. Work 4 loops on the shoulder opening and sew on 4 buttons.

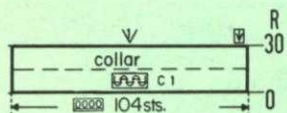

Cast on 104 sts. with color 1 and work 30 rows K1, P1, Ribbing, then bind off all sts.



Move the Cam Box to the left side, turn the Row Counter back to 190 and complete the left half. Follow the instructions from*.

*ON CAM BOX SIDE, bind off 3 sts. after Row 191; 2 sts. after Rows 193, 195; 1 st. after Rows 197, 199, 201. For SHOULDER bind off 4 sts. after Rows 208, 210, 212, 214; 5 sts. after Row 216.

Work the front section the same as the back section to ROW 190, then bind off the center 17 sts., put the needles on the left side into holding position and complete the right half first.

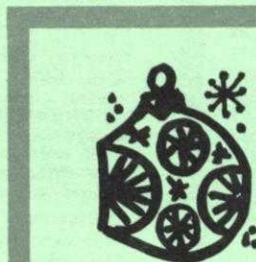
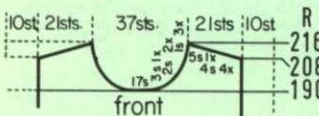

Sleeve		
4R		C-3
4R		C-4
4R		C-2
4R		C-1
4R		C-3
10R		C-2
4R		C-3
8R		C-1
4R		C-2
20R		C-1
4R		C-2
8R		C-1

REPEAT

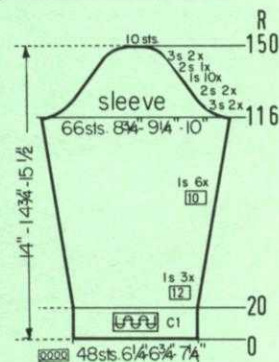

Move the Cam Box to the left side, turn the Row Counter back to 208 and complete the left half. Follow the instructions from*.

*ON CAM BOX SIDE, bind off 4 sts. after Row 208 (EVEN ROWS = SHOULDER SHAPING); 3 sts. after Row 209 (ODD ROWS = NECK SHAPING); 4 sts. after Row 210; 3 sts. after Row 211; 4 sts. after Row 212; 3 sts. after Row 213; 4 sts. after Row 214; 5 sts. after Row 216.

ON CAM BOX SIDE, bind off 3 sts. after Rows 148, 149; 2 sts. after Rows 150, 151, 152, 153; 1 st. after Rows 154, 155, 156, 157, 158, 159, then knit to Row 208, bind off the center 19 sts., put the needles on the left side into holding position and complete the right half first. (For the Front Section knit to Row 190).

ROWS 0 to 148: Knit even.

Cast on 99 sts. with color 2 and work stockinette st.

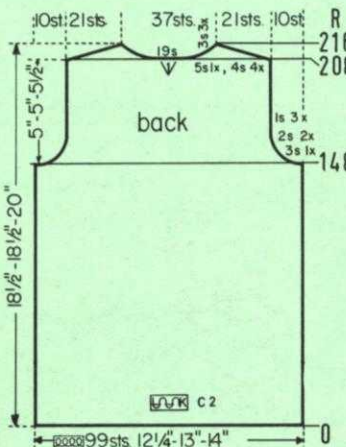

Continued on page 28

MK 5438

SIZE:	4 (Chest 23")	6 (Chest 24")	8 (Chest 26")
YARN:	Allegro	Allegro	Dolly Crepe
50 gr. BALLS:	4 color 1 2 color 2 1 color 3 1 color 4	4 color 1 2 color 2 1 color 3 1 color 4	5 color 1 3 color 2 2 color 3 1 color 4
TENSION:	6 to 8	7 to 9	9 to 10
GAUGE:	2" 15 sts. 21 rows	14 sts. 20 rows	13 sts. 19 rows

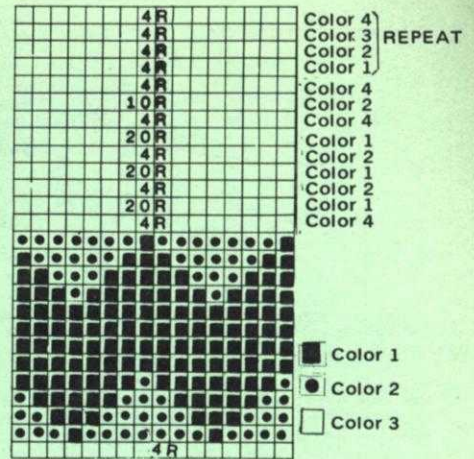

The instructions are the same for all sizes. **PATTERN:** Stockinette Stitch, color stripes and a Norwegian Design Border. In the instructions, each row in the Norwegian Design is counted as 1 row, but several movements of the Cam Box are needed to complete 1 row. **CAP:** Fisherman's Rib. **EDGES:** K1, P1, Ribbing. **DECREASES:** Hang the 3rd st. onto the 2nd st., then move the end sts. inward to fill the empty needle. **INCREASES:** Move the 2 and sts. 1 needle outward, then place the 3rd st. from the row below onto the empty needle. Begin the **DART** by hanging the sts. together as marked in the Diagram, then move the sts. inward to fill the empty needles. The following decreases, then increases for the **DART** lie directly above.

FINISHING: Block all sections. **PULLOVER:** Join the front and back section at sides and shoulders, leaving 2" open on the left shoulder. Turn under a small amount around the opening and hem. Sew the sleeves together and set in. Sew 1 edge of the collar to inside and 1 edge to outside of the neckline. Sew a zipper to the shoulder opening. **PANTS:** Join the inner leg seams. Join the sections at center back and center front, leaving about 6"-7" open on the front. Turn under a small amount around the opening and hem in place. Turn under 19 rows on the leg edges and 11 rows on the upper edge and hem in place. Insert an elastic band into the upper hem. Sew in a zipper. **CAP:** Join the section at center back. Pull the sts. held on contrast yarn, together, tie and sew in. Make a Pom-Pom (See Practical Knitting Hints Book, page 61) and sew to the top of the Cap.

ON CAM BOX SIDE, bind off 3 sts. after Rows 116, 117, 118, 119; 2 sts. after Rows 120, 121, 122, 123. **ON EACH SIDE,** hang the 1st st. onto the 2nd st. after Rows 124, 126, 128, 130, 132, 134, 136, 138, 140, 142. **ON CAM BOX SIDE,** bind off 2 sts. after Rows 144, 145; 3 sts. after Rows 146, 147, 148, 149; 10 sts. after Row 150.

ON EACH SIDE, increase 1 st. after Rows 20, 32, 44, 56, 66, 76, 86, 96, 106, then knit to Row 116.

ROWS 0 to 20: Knit even, then change to stockinette st. and work the color stripes as marked in the separate Line Drawing.

Cast on 48 sts. with color 1 and work K1, P1, Ribbing.

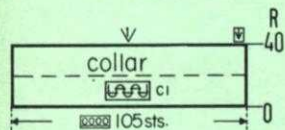

Cast on 105 sts. with color 1 and work 40 rows K1, P1, Ribbing, then bind off all sts.

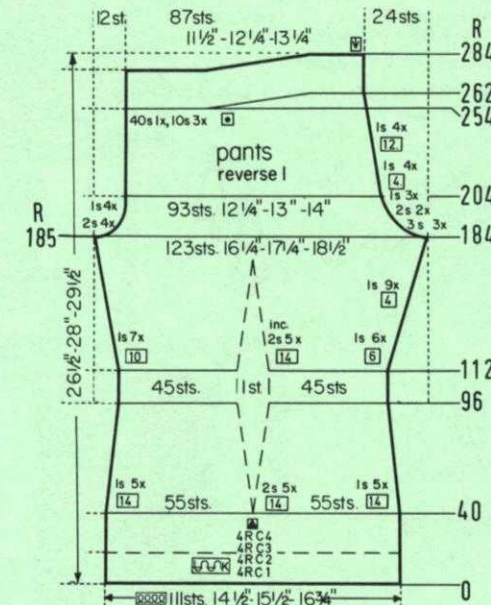
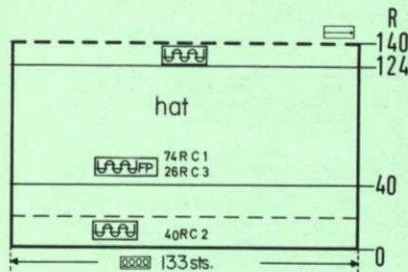

Cast on 133 sts. with color 2 and work 40 rows K1, P1, Ribbing, then change to color 3, place the Gate Cam Release Lever of the main machine to the needle heels and work Fisherman's Rib. Change to color 1 after Row 66, then knit to Row 124. Replace the Gate Cam Release Lever, then work K1, P1, Ribbing to Row 140. Transfer the Ribber sts. to the main machine, then transfer first the 1st, 3rd, 5th, etc. sts. onto a strand of yarn and then the 2nd, 4th, 6th, etc. sts. onto a second strand of yarn.



Move the Cam Box to the left side, turn the Row Counter back to 166 and complete the left half. Follow the instructions from*.

***ON CAM BOX SIDE,** bind off 4 sts. after Rows 166 (EVEN ROWS = SHOULDER SHAPING), 167 (ODD ROWS = NECK SHAPING), 168; 3 sts. after Row 169; 4 sts. after Row 170; 3 sts. after Row 171; 4 sts. after Rows 172, 174.

ON CAM BOX SIDE, bind off 3 sts. after Rows 116, 117; 2 sts. after Rows 118, 119, 120, 121; 1 st. after Rows 122, 123, 124, 125, 126, 127, then knit to Row 126, bind off the center 13 sts., put the needles on the left side into holding position and complete the right half first. (For the Front Section knit to Row 150).

ROWS 17 to 116: Knit even.

ROWS 0 to 16: Knit even, then transfer the ribber sts. to the main machine, work stockinette st., the Norwegian Border and the color stripes as marked in the separate Line Drawing.

Cast on 93 sts. with color 1 and work K1, P1, Ribbing.

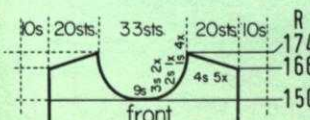
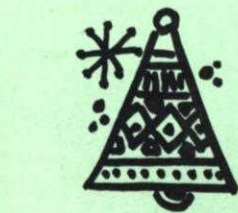

Move the Cam Box to the left side, turn the Row Counter back to 150 and complete the left half. Follow the instructions from*.

***ON CAM BOX SIDE,** bind off 3 sts. after Rows 151, 153; 2 sts. after Row 155; 1 st. after Rows 157, 159, 161, 163. For **SHOULDER** bind off 4 sts. after Rows 166, 168, 170, 172, 174.

Work the front section the same as the back section to **ROW 150,** then bind off the center 9 sts., put the needles on the left side into holding position and complete the right half first.

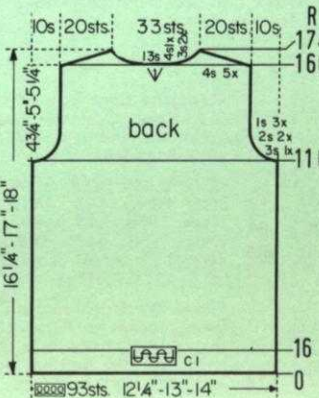

Work the second section with reverse shapings, casting on from right to left. (Cam Box will be on the LEFT side at Row 0).

ON CAM BOX SIDE, bind off 3 sts. after Rows 220 (EVEN ROWS = CENTER BACK), 221 (ODD ROWS = CENTER FRONT), 222; 2 sts. after Row 223; 3 sts. after Row 224; 2 sts. after Rows 225, 226, 227, 228; 1 st. after Rows 229, 230, 231, 232, 233, 234, 238, 242, 246, 258, 270, 282, 294, then 1 more time after Row in (). Knit to Row 302, then work Short Rows. ON OPPOSITE SIDE of CAM BOX put into holding position 38 needles after Row 302; 10 needles after Rows 304, 306, (306), 308, 310. After Row 312 bring all needles back into working position, then knit to Row 340 and bind off all 95 sts.

ON OPPOSITE SIDE of CAM BOX, increase 1 st. after Rows in (). For the DART, increase 2 sts. after (DART). ON CAM BOX SIDE, increase 1 st. after Rows 138, (138), (DART 138), 144, (148), 150, 156, (158), (DART 158), 162, 168, (168), 174, (178), (DART 178), 180, 186, (188), 192, (196), 198, (DART 198), 204, (204), 208, 212, (212), 216, (DART 218), then knit to Row 220.

Decrease 1 st. ON EACH SIDE and 2 sts. for EACH DART after Rows 40, 60, 80, 100, 120, then knit to Row 138.

ROWS 0 to 40: Knit even.

Cast on 137 sts. with color 1 and work stockinette st.

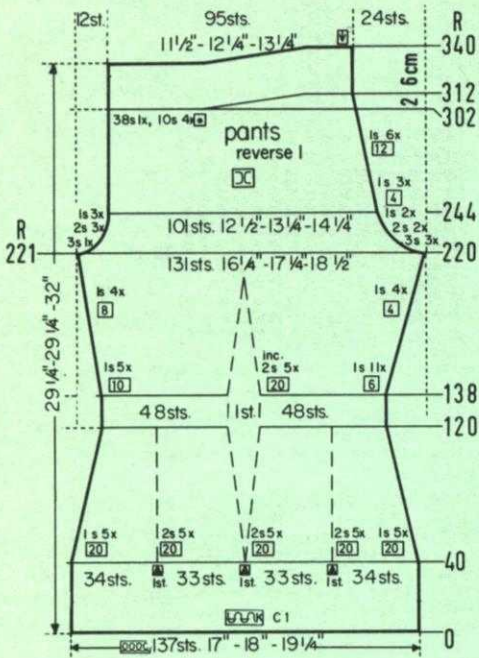

ON CAM BOX SIDE, bind off 3 sts. after Rows 154, 155, 156, 157; 2 sts. after Rows 158, 159, 160, 161, 162, 163. ON EACH SIDE, hang the 1st st. onto the 2nd st. after Rows 164, 166, 168, 170, 172, 174, 176, 178, 180. ON CAM BOX SIDE, bind off 2 sts. after Rows 182, 183, 184, 185; 3 sts. after Rows 186, 187, 188, 189; 9 sts. after Row 190.

ON EACH SIDE, increase 1 st. after Rows 26, 40, 54, 68, 82, 94, 106, 118, 130, 142, then knit to Row 154.

ROWS 0 to 26: Knit even, then change to stockinette st. and work the repeated color stripes as marked in the Diagram.

Cast on 51 sts. with color 1 and work K1, P1, Ribbing.

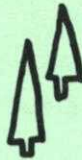
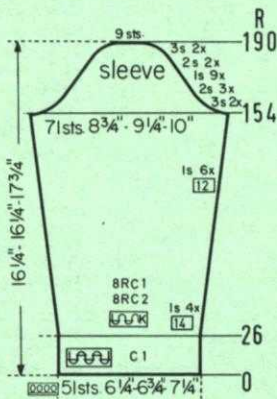

HP 3705

SIZE:	36 (Chest 35"-36")	38 (Chest 37"-38")	40 (Chest 40"-41")
YARN:	Melodie	Melodie	Dolly Crepe
50 gr. BALLS:	5	6	6
TENSION:	7 to 9	8 to 10	9 to 10
GAUGE:	2" 15 sts. 20 rows	14 sts. 19 rows	13 sts. 19 rows

The instructions are the same for all sizes. PATTERN: Stockinette Stitch. EDGES: K1, P1, Ribbing. INCREASES: Move the 2 end sts. 1 needle outward, then place the 3rd st. from the row below onto the empty needle.

FINISHING: Block the sections. Join front and back sections at sides and shoulders. Sew the neckband sections together, then sew to neckline. Sew the armhole bands together, then sew to armhole edges. Sew the shoulder bands in place and sew 3 buttons to each shoulder. Double crochet a monogram and sew in place.

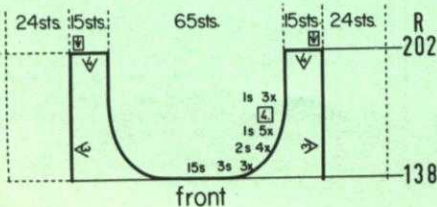

Move the Cam Box to the left side, turn the Row Counter back to 138 and complete the left half. Follow the instructions from*.

*ON CAM BOX SIDE, bind off 3 sts. after Rows 139, 141, 143; 2 sts. after Rows 145, 147, 149, 151; 1 st. after Rows 153, 155, 157, 159, 161, 163, 167, 171. After Row 202 bind off the 15 SHOULDER sts.

Work the front section the same as the back section to ROW 138, then bind off the center 15 sts., put the needles on the left side into holding position and complete the right half first.

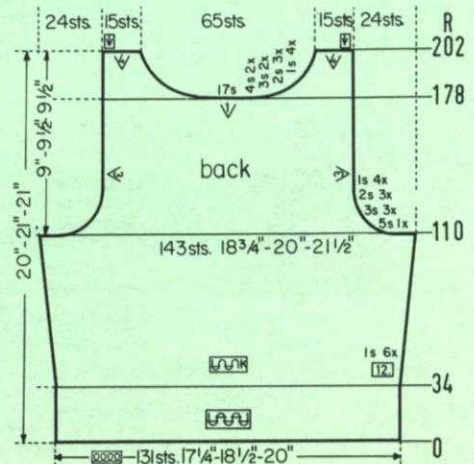
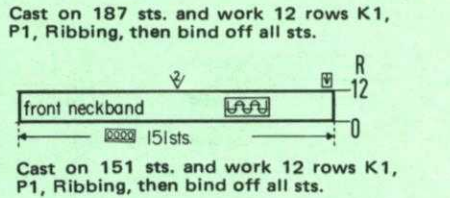
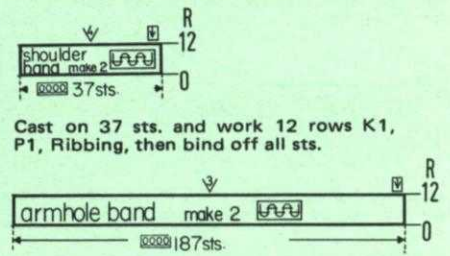
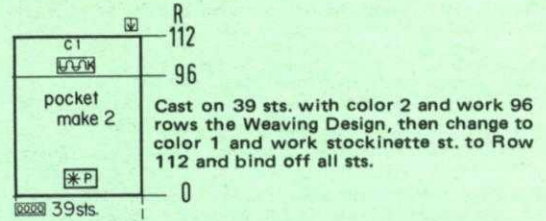
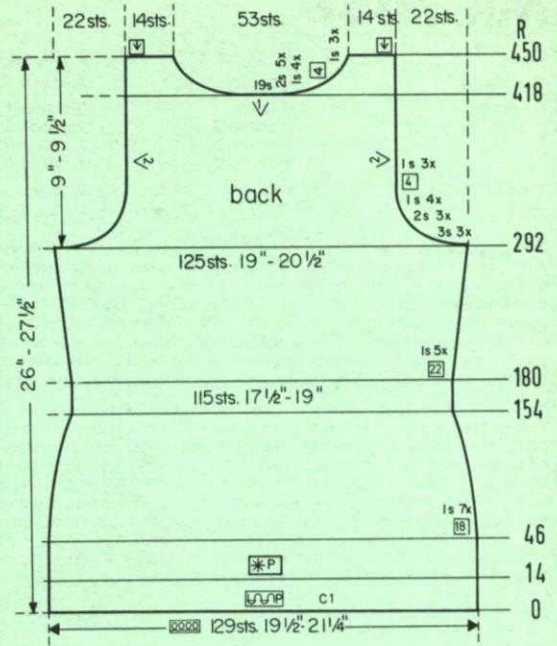

DP 8235

Bring the needles on the left side into working position, knit 1 row in PATTERN to the left side, turn the Row Counter back to 418 and complete the left half. Follow the instructions from*.

*ON CAM BOX SIDE, bind off 2 sts. after Rows 419, 421, 423, 425, 427; 1 st. after Rows 429, 431, 433, 435, 437, 441, 445. After Row 450 bind off the 14 Shoulder sts.

ON CAM BOX SIDE, bind off 3 sts. after Rows 292, 293, 294, 295, 296, 297; 2 sts. after Rows 298, 299, 300, 301, 302, 303; 1 st. after Rows 304, 305, 306, 307, 308, 309, 310, 311, 312, 313, 316, 317, 320, 321, then knit to Row 418, bind off the center 19 sts., put the needles on the left side into holding position and complete the right half first.

ON EACH SIDE, increase 1 st. after Rows 180, 202, 224, 246, 268, then knit to Row 292.

ON EACH SIDE, decrease 1 st. after Rows 46, 64, 82, 100, 118, 136, 154, then knit to Row 180.

ROWS 15 to 46: Knit even.

ROWS 0 to 14: Knit even, then begin the Weaving Design.

Cast on 129 sts. with color 1 and work stockinette st.

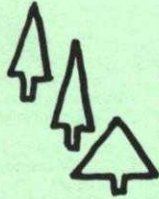

SIZE:	12 (Bust 34"-35")	16 (Bust 37"-38")
YARN:	Alanda = color 1 (Weaving) Beatrice = color 2 (Base)	Alanda = color 1 (Weaving) Beatrice = color 2 (Base)
50 gr. BALLS:	6 color 1 7 color 2	7 color 1 7 color 2
TENSION:		
Stock:	8 to 9	9 to 10
Pattern:	5 to 7	6 to 8
GAUGE:	2"	
Stock:	13 sts. 18 rows	12 sts. 17 rows
Pattern:	13 sts. 35 rows	12 sts. 33 rows

The instructions are the same for both sizes. PATTERN: Weaving Design, using the Weaving Attachment. Follow the Line Drawing, or use Pattern No. 474. EDGES: Stockinette Stitch using color 1. Color 2 is the base yarn while Weaving. Make all shapings of 1 st. on the outer edge.

FINISHING: Block all sections. Join the back and the front sections at sides and shoulders, easing in the fullness at the bustline of the front sections. Turn under 14 rows on the lower edges and hem in place. Turn under 8 rows on the upper edges of the pockets, then sew the pockets in place. Join the short ends of the armhole bands, then sew 1 edge of the bands to inside and 1 edge to outside of the armhole edges. Sew the front band to the front edges and the neckline in the same manner. Finish the buttonholes, sew on buttons.

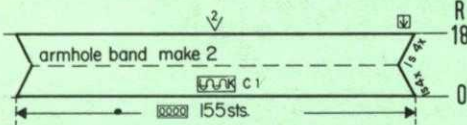

Cast on 155 sts. with color 1 and work stockinette st. ON EACH SIDE, decrease 1 st. after Rows 2, 4, 6, 8, then increase 1 st. ON EACH SIDE after Rows 10, 12, 14, 16. After Row 18 bind off all sts.

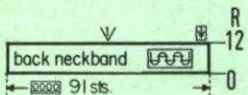

Cast on 91 sts. and work 12 rows K1, P1, Ribbing, then bind off all sts.

Move the Cam Box to the left side, turn the Row Counter back to 178 and complete the left half. Follow the instructions from*.

*ON CAM BOX SIDE, bind off 4 sts. after Rows 179, 181; 3 sts. after Rows 183, 185; 2 sts. after Rows 187, 189, 191; 1 st. after Rows 193, 195, 197, 199. After Row 202 bind off the 15 SHOULDER sts.

ON CAM BOX SIDE, bind off 5 sts. after Rows 110, 111; 3 sts. after Rows 112, 113, 114, 115, 116, 117; 2 sts. after Rows 118, 119, 120, 121, 122, 123; 1 st. after Rows 124, 125, 126, 127, 128, 129, 130, 131, then knit to Row 178, bind off the center 17 sts., put the needles on the left side into holding position and complete the right half first. (For the Front Section knit to Row 138).

ON EACH SIDE, increase 1 st. after Rows 34, 46, 58, 70, 82, 94, then knit to Row 110.

ROWS 0 to 34: Knit even, then change to stockinette st.

Cast on 131 sts. and work K1, P1, Ribbing.

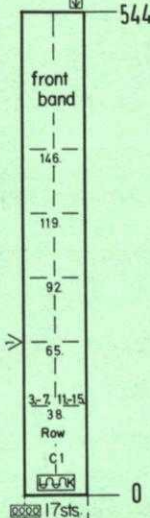

Cast on 17 sts. with color 1 and work stockinette st. Make buttonholes over the 3rd-7th and 11th-15th sts. after Rows 38, 65, 92, 119, 146, then knit to Row 544 and bind off all sts.

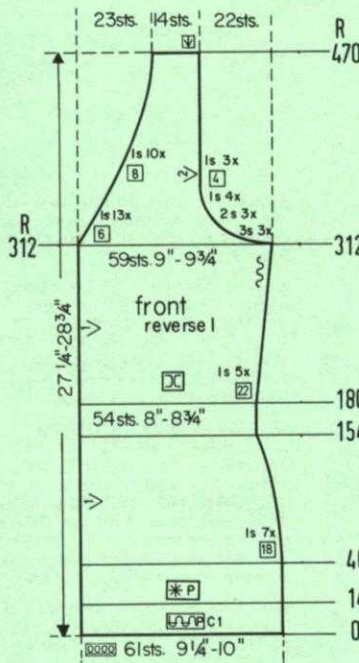

Work the second front section with reverse shapings. Cast on the regular way, knit 14 rows stockinette st. with color 1, then knit 1 row in PATTERN to the left side, turn the Row Counter back to 14. The Cam Box will be on the LEFT side at even numbered rows.

Decrease 1 st. ON OPPOSITE SIDE of CAM BOX after Rows in (). ON CAM BOX SIDE, bind off 3 sts. after Rows 312, (312), 314, 316; 2 sts. after Rows 318, (318), 320, 322; 1 st. after Rows 324, (324), 326, 328, 330, (330), 332, 336, (336), 340. The Armhole Shaping is now completed. Continue to decrease 1 st. ON NECK SIDE after Rows 342, 348, 354, 360, 366, 372, 378, 384, 390, 398, 406, 414, 422, 430, 438, 446, 454, 462, then knit to Row 470 and bind off the 14 SHOULDER sts.

ON CAM BOX SIDE, increase 1 st. after Rows 180, 202, 224, 246, 268, then knit to Row 312.

ON CAM BOX SIDE, decrease 1 st. after Rows 46, 64, 82, 100, 118, 136, 154, then knit to Row 180.

ROWS 15 to 46: Knit even.

ROWS 0 to 14: Knit even, then begin the Weaving Design.

Cast on 61 sts. with color 1 and work stockinette st.

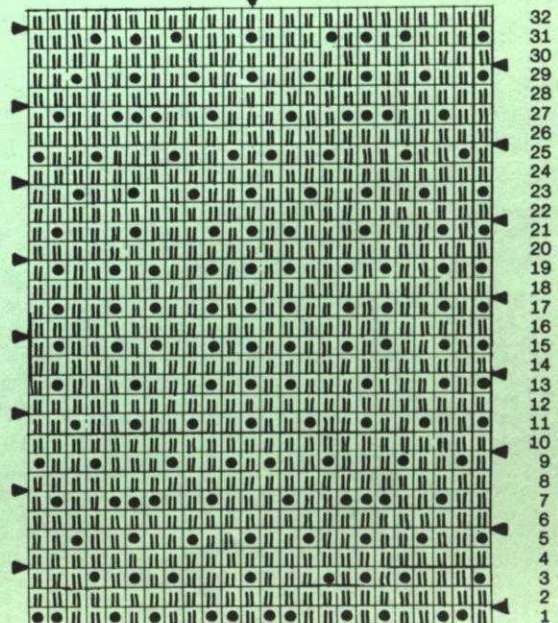

DP 8236

SIZE:	12 (Bust 33"-34")	14 (Bust 35"-36")	16 (Bust 38"-39")
YARN:	Subita Crepe 2 x 3	Beatrice	Beatrice
50 gr. BALLS:	7	8	9
TENSION:	5 to 7	5 to 7	6 to 8
GAUGE:	2" 17 sts. 23 rows	16 sts. 22 rows	15 sts. 21 rows

The instructions are the same for all sizes. PATTERN: Stockinette Stitch. EDGES: K1, P1, Ribbing. INCREASES: Move the 2 end sts. 1 needle outward, then place the 3rd st. from the row below onto the empty needle.

FINISHING: Block all sections. Join the front and the back section at sides and shoulders. Sew the sleeves together and set in. Join the short ends of the collar, then sew the collar to the neckline and fold over to the outside.

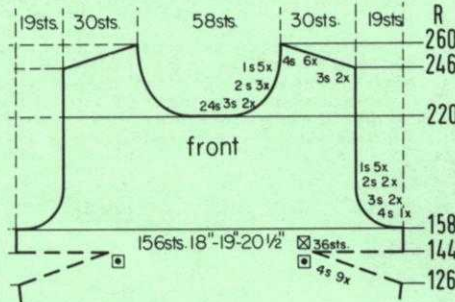

Move the Cam Box to the left side, turn the Row Counter back to 220 and complete the left half. Follow the instructions from*.

*ON CAM BOX SIDE, bind off 3 sts. after Rows 221, 223; 2 sts. after Rows 225, 227, 229; 1 st. after Rows 231, 233, 235, 237, 239. For SHOULDER bind off 3 sts. after Rows 246, 248; 4 sts. after Rows 250, 252, 254, 256, 258, 260.

ON CAM BOX SIDE, bind off 4 sts. after Rows 158, 159; 3 sts. after Rows 160, 161, 162, 163; 2 sts. after Rows 164, 165, 166, 167; 1 st. after Rows 168, 169, 170, 171, 172, 173, 174, 175, 176, 177, then knit to Row 220, bind off the center 24 sts., put the needles on the left side into holding position and complete the right half first.

Work the front section the same as the back section to ROW 126, then work Short Rows for the Bust Darts. ON OPPOSITE SIDE of CAM BOX put into holding position 4 needles after Rows 126, 127, 128, 129, 130, 131, 132, 133, 134, 135, 136, 137, 138, 139, 140, 141, 142, 143. ON OPPOSITE SIDE of CAM BOX bring back into working position all needles after Rows 144, 145, then knit to Row 158.

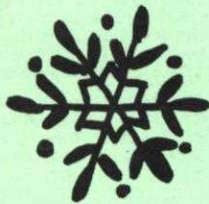

Move the Cam Box to the left side, turn the Row Counter back to 228 and complete the left half. Follow the instructions from*.

*ON CAM BOX SIDE, bind off 3 sts. after Row 228 (EVEN ROWS = SHOULDER SHAPING); 5 sts. after Row 229 (ODD ROWS = NECK SHAPING); 3 sts. after Row 230; 5 sts. after Row 231; 4 sts. after Rows 232, 233, 234, 235, 236, 238, 240, 242.

ON CAM BOX SIDE, bind off 4 sts. after Rows 140, 141; 3 sts. after Rows 142, 143, 144, 145; 2 sts. after Rows 146, 147, 148, 149; 1 st. after Rows 150, 151, 152, 153, 154, 155, 156, 157, 158, 159, then knit to Row 228, bind off the center 22 sts., put the needles on the left side into holding position and complete the right half first.

ON EACH SIDE, increase 1 st. after Rows 60, 72, 84, 96, 108, 120, then knit to Row 140. (For the Front Section knit to ROW 126).

ROWS 43 to 60: Knit even.

ROWS 0 to 42: Knit even, then change to stockinette st.

Cast on 144 sts. and work K1, P1, Ribbing.

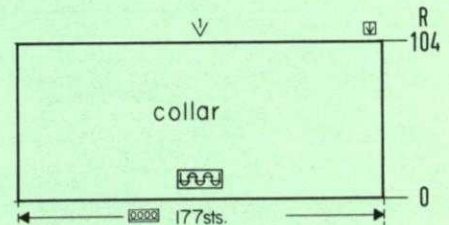
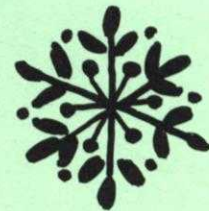

Cast on 177 sts. and work 104 rows K1, P1, Ribbing, then bind off all sts.

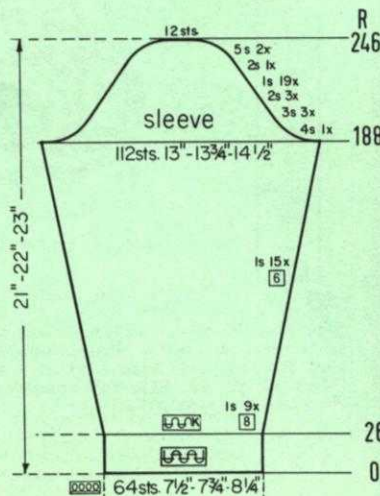
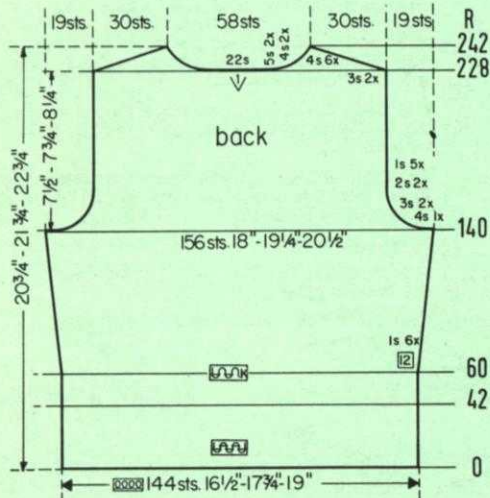

ON CAM BOX SIDE, bind off 4 sts. after Rows 188, 189; 3 sts. after Rows 190, 191, 192, 193, 194, 195; 2 sts. after Rows 196, 197, 198, 199, 200, 201. ON EACH SIDE, hang the 1st st. onto the 2nd st. after Rows 202, 204, 206, 208, 210, 212, 214, 216, 218, 220, 222, 224, 226, 228, 230, 232, 234, 236, 238. ON CAM BOX SIDE, bind off 2 sts. after Rows 240, 241; 5 sts. after Rows 242, 243, 244, 245; 12 sts. after Row 246.

ON EACH SIDE, increase 1 st. after Rows 26, 34, 42, 50, 58, 66, 74, 82, 90, 98, 104, 110, 116, 122, 128, 134, 140, 146, 152, 158, 164, 170, 176, 182, then knit to Row 188.

ROWS 0 to 26: Knit even, then change to stockinette st.

Cast on 64 sts. and work K1, P1, Ribbing.

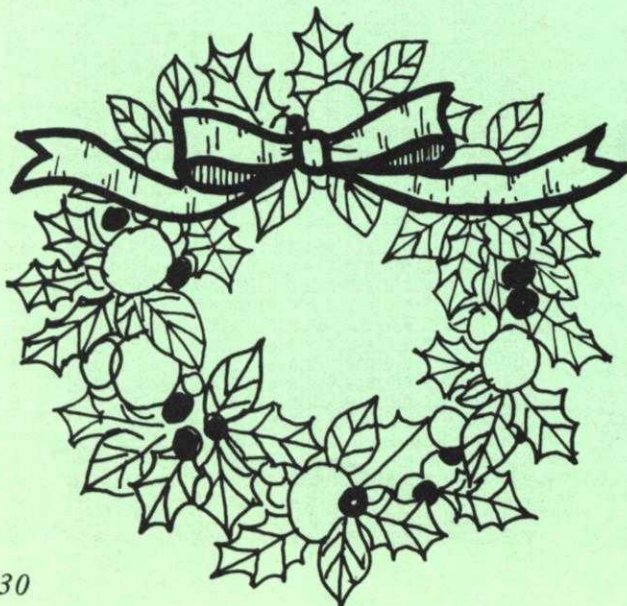

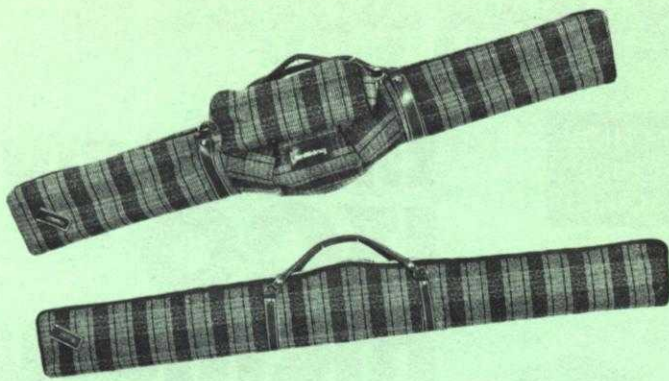

knitking carrying bags

Completely new design in heavy duty canvas with waterproof interior. For AM 3 Knitter and Yarn Container.

List Price: \$29.50
 For Ribber only: \$15.50
(California residents add Sales Tax)
 Shipping Costs: \$1.75 and \$1.00

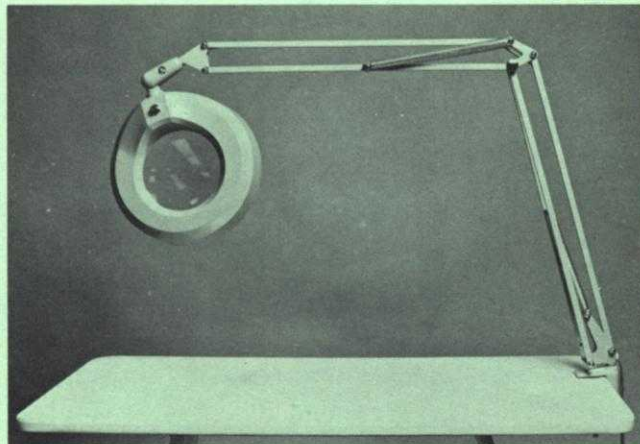

knitking magnifier lamp

A perfect gift item for any knitter. It has a large (5") magnifying lens and a cool fluorescent tube light. It stays in any position and is wonderful for general illumination for you to work under when joining seams, etc. Color: light grey.

List Price: \$49.50
(California residents add Sales Tax)
 Shipping Costs: \$3.00

baby lock

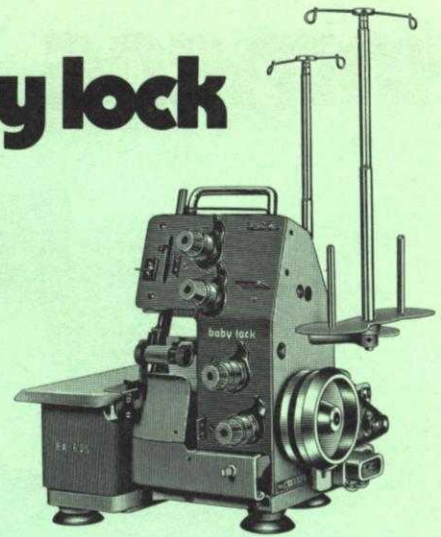

MODEL NO. 605. Fabulous Cut, Sew and Overlock machine. Perfect for the entire Family.

List Price \$329.00

MODEL NO. 405. New Style Cut and Overlock Machine. Specially for knit materials.

List Price: \$299.00
(California residents add Sales Tax)

Shipping charges: F.O.B. Los Angeles

Jac 40 is a must

for fast easy knitting of
 Jaquard and Ski-sweater
 designs

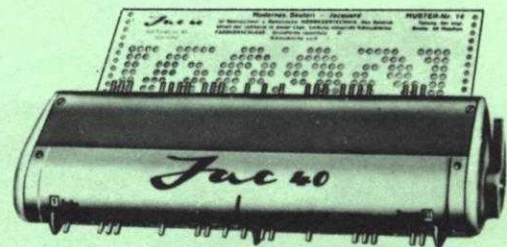

Jac 40's are made for most brands of machines. When ordering be sure to specify your brand of knitter as needle spacings vary. Simple to use and an essential tool for the modern knitter, Jac 40's are \$29.50 complete with 3 cards for practicing the 3 techniques, plus complete instructions.

Order from your dealer or direct from
KNITKING

1128 Crenshaw Boulevard, Los Angeles, Calif. 90019
 Shipping Cost \$1.50 — California residents add sales tax.

Order direct from KNITKING — 1128 Crenshaw Blvd., Los Angeles, California 90019

KNITKING OUTSTANDING TRADE IN OFFERS

- (a) A LACEMAKING MACHINE
- (b) A PUNCH CARD MACHINE
- (c) A PUSH BUTTON MACHINE

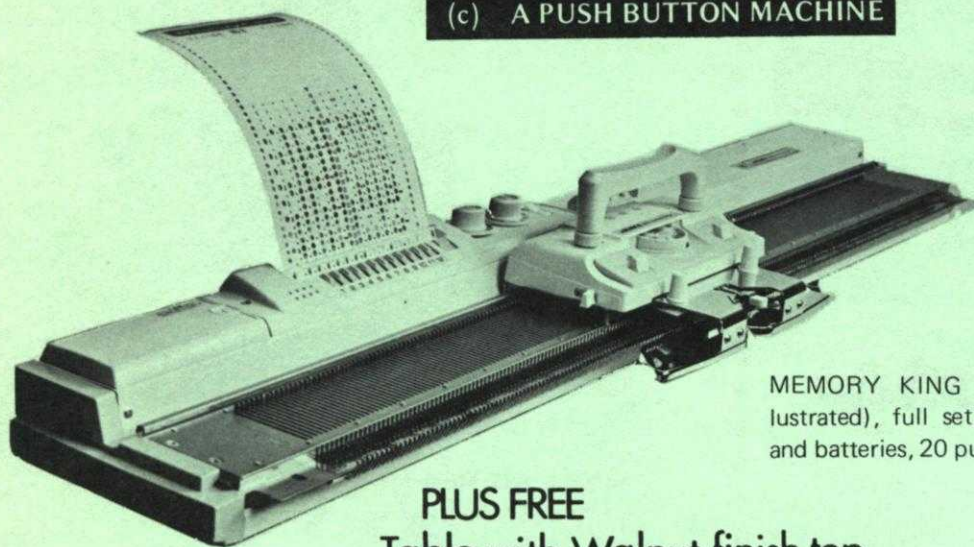

the all new 1300 memory king

MEMORY KING 1300 complete with Lacemaker (not illustrated), full set of tools including weaving attachment and batteries, 20 punched Memory Cards.

PLUS FREE
Table with Walnut finish top
List Price: \$42.50

List Price **\$329.00**
Special Trade-in allowance **50.00**
Balance **\$279.00**

(California residents add Sales Tax)

The Hand Knitting Machine with the most advanced automatic pattern selector

- 1 Lace designs
- 2 Weaving designs
- 3 Holding Position designs
- 4 Multi-color designs
- 5 Raised designs
- 6 Eyelet designs
- 7 Jacquard designs

Knit - Purl
and fancy
ribbed patterns

All knitted automatically without combs or weights. A multitude of fancy ribbed designs can be obtained with the cam operated push button controls.

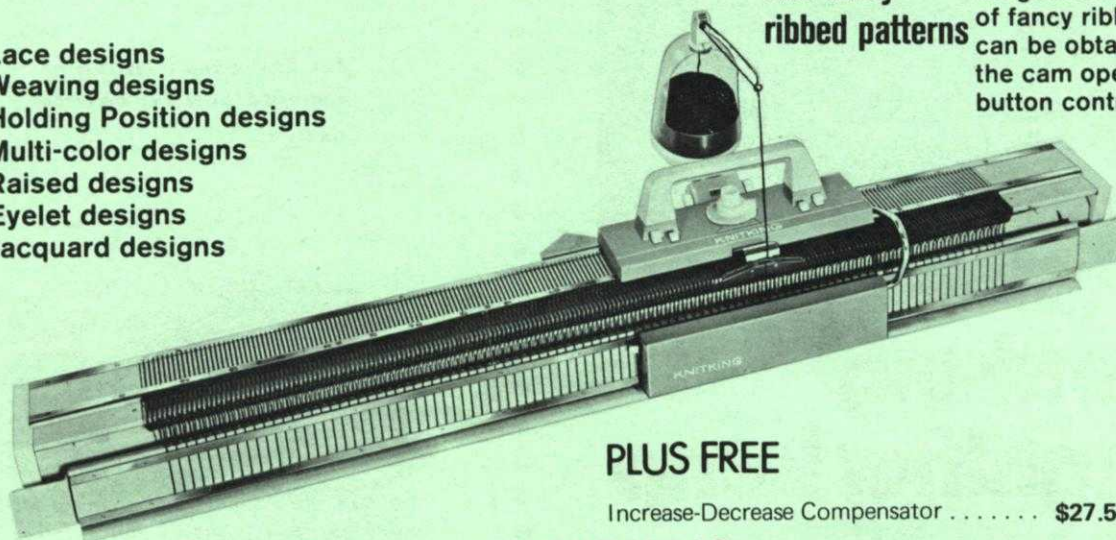

PLUS FREE

Increase-Decrease Compensator **\$27.50**

WHIZ KING Pattern Reader **59.50**

Total Value **\$87.00**

AM 3 Knitter - List Price: **\$329.50**
P 3 Coordinated Ribber - List Price: **\$159.50**
Total **\$489.00**

SPECIAL COMBINATION PRICE: **\$449.00**
Less Trade of \$100.00 **100.00**
TOTAL **\$349.00**

(California residents add Sales Tax)

ORDER DIRECT FROM KNITKING 1128 CRENSHAW BLVD.
LOS ANGELES, CALIFORNIA 90019

Another first from KNITKING

Completely Self-Contained Motorized Table for KNITKING

machines (wired for 110 volts) . . . Just locate

your KNITKING on the Table, no clamps

or fixing necessary . . .

Simple to operate . . .

Foot and Fingertip controls.

Built in Safety Device stops

machine if knitting jams . . .

Can be used with Ball or

Cone Yarn.



Price: \$349.00

(California residents add Sales Tax).

Freight charges — F.O.B. Los Angeles.

(Crated Table weighs approximately 150 pounds)

Order direct from KNITKING — 1128 Crenshaw Blvd., Los Angeles, California 90019



Make it for Christmas

HP 3704 — Woven materials are great . . . and in fashion today . . . Weave this handsome sleeveless Pullover for your man in less time than you think. Be sure to use KNITKING'S Regia for the knitting and Alanda for the weaving. Follow the line drawing or you can use JAC 40 and Pattern No. 473. Sizes 38 and 42.

KK 5440 — Time for a change! Any toddler will be warm and comfortable in a Norwegian Design Pullover with Stockinette Stitch Pants. Make a quick change into tights (shown on the right). For the 1 to 2 year old. Use KNITKING Regia.

HP 3703 — Let him relax at home in a leisure time House Jacket. It's easy to knit in Stockinette Stitch using two colors of Sport Prima for a Size 40, Dolly Dralon for Sizes 44 and 46.







KK 5438 — A Boys Pullover, Pants and Hat . . . Mix em or match em . . . All Stripey Stockinette Stitch with a Norwegian Design Border. Sizes 4 and 6 are made with Allegro; Size 8 with Dolly Dralon.

MK 5439 — Girls of any age will love this easy to knit Pantsuit. Make it in Stockinette Stitch with color stripes on the sleeves of the Pullover. Sizes 4 and 6 are in Regia; Size 8 in Amore.







Get Ready for Christmas

HP 3705 — Present him with a Sleeveless Pullover mono-grammed with a crochet initial. If you can't crochet, knit a cord then form it into his initial and sew it on. Use Melodie for Sizes 36 and 38, Dolly Dralon for Size 40.

DP 8235 — A slightly shaped Vest will fit beautifully into your Winter wardrobe . . . The Pattern is a Weaving Design with Stockinette Stitch for the bands. Beatrice is the knitting yarn, Alanda is for the Weaving. Sizes 12 and 16.

DP 8236 — Be sure to knit the Pullover in a contrasting color to wear under the Vest DP 8235. Knitted in Stockinette Stitch with a 1 x 1 Rib for the Bands. Use Subita Crepe for Size 12, Beatrice for Sizes 14 and 16.



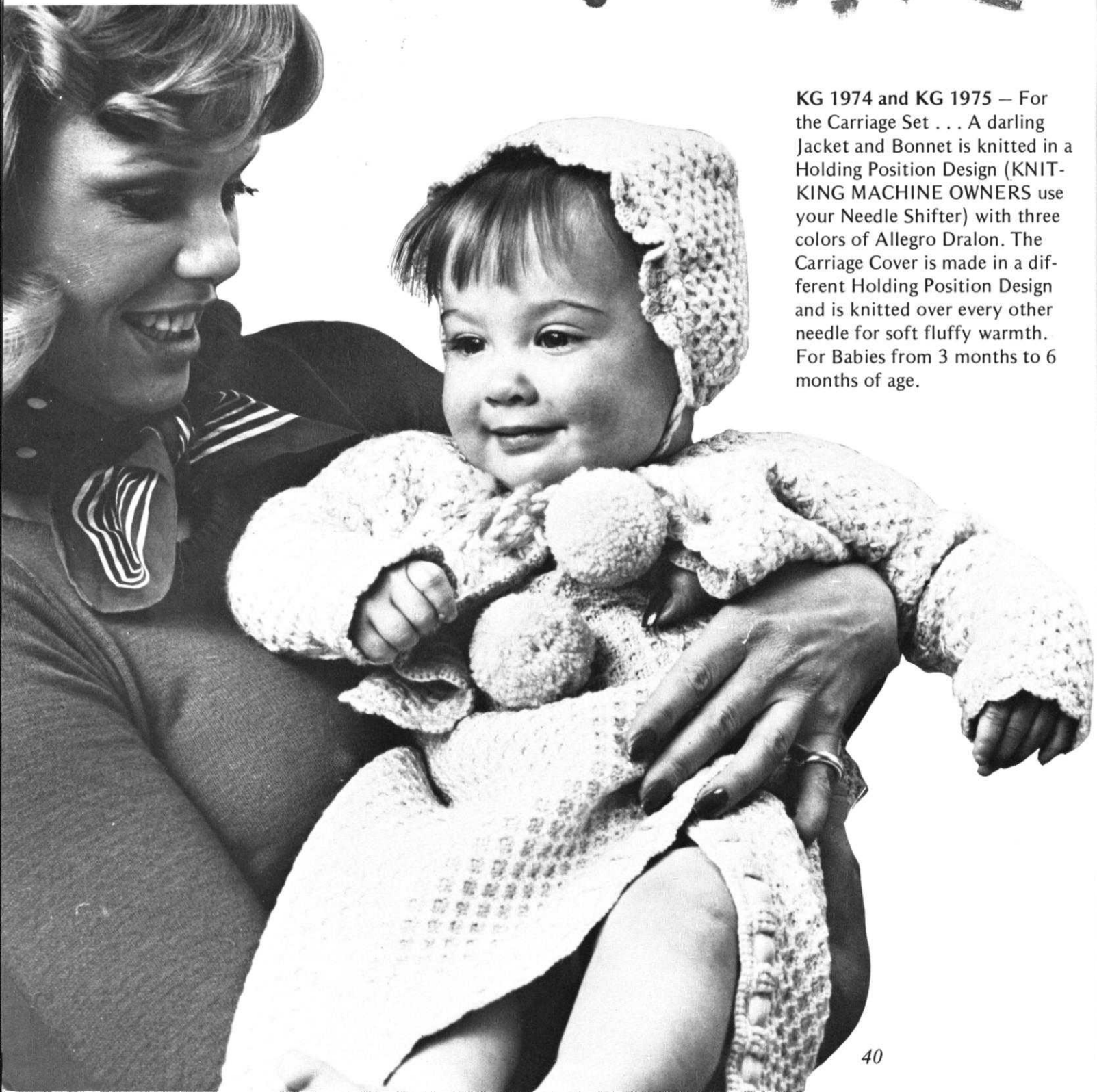

KG 1974 and KG 1975 – For the Carriage Set . . . A darling Jacket and Bonnet is knitted in a Holding Position Design (KNIT-KING MACHINE OWNERS use your Needle Shifter) with three colors of Allegro Dralon. The Carriage Cover is made in a different Holding Position Design and is knitted over every other needle for soft fluffy warmth. For Babies from 3 months to 6 months of age.



Knitking News

We recently took part in Los Angeles County Fair.. our 20th successive and successful year... Our exhibit is always acknowledged as one of the finest in the entire Fair - which incidentally, with an attendance annually in excess of 1.25 million is the largest County Fair in the world... We had a fantastic display of gorgeous garments, many of which have appeared in KNITKING MAGAZINE plus several that had never been seen before... Our display was so impressive that many fair goers refused to believe that such lavish garments were made on KNITKING home knitting machines... Not one of the garments displayed cost more than \$25.00 to produce, and yet, we could have sold some of them a hundred times over at more than ten times their production cost... A pink pantsuit designed by Betty Atkin created great desire in the hearts of many women visitors and one husband visited our booth several times, offering up to \$300.00 for the suit... His wife apparently had talked about it so much, he wanted to buy it for her... Unfortunately, it, like all our display garments, was not for sale.

Your Editor, Henry Atkin and his wife Betty take time out from their busy schedule each year to spend time (average 14 hours daily) meeting old and new friends... The fund of knowledge gained each time is invaluable in future plans to satisfy the likes and demands of our readers. We get to meet several hundred readers at the Fair and it is always a pleasure to talk with them.

We continue to be amazed at the number of people who buy knitting machines from catalogues at a wide range of prices... Sight unseen and without the slightest knowledge of what to do with them when they take delivery... Many never even get the first row cast on... they cannot understand the very poor translations into English, of some of the Instructions Manuals (and having studied many of these manuals, we can understand why)... It is unfortunate that as a result of one bad experience, many would be knitting machine owners are permanently turned off... This is one of the reasons why we always make exceptional trade-in offers to such people... knowing once they own a KNITKING product, we stand an excellent chance of keeping them as customers and of satisfying their continuing needs.

OUR READERS WRITE

We are no longer surprised at requests for subscriptions to KNITKING MAGAZINE received from HAND KNITTERS... They do not own a machine (don't know what they are missing) but they tell us they adore our Patterns and knit them by hand... But... we are surprised at requests from our Machine Knitters to change hand knit patterns into machine knits. If you are a hand knitter as well as a machine knitter, you will know that many hand knit patterns can be adapted to machine knitting. However... we wonder why you would want to do this. We think we give you a fantastic choice of patterns to knit by machine. Many times when you see a hand knit pattern, you can find a similar one in our magazine and with a small amount of adjustment you can produce a garment almost exactly like the hand knit one. If you are determined to change a hand knit into a machine knit...

you will note that there is always a stitch gauge given and you must get this stitch gauge regardless of what machine tension you use (keep trying different tensions) - but very rarely is a row gauge given because when you are hand knitting, you can use a ruler to measure off the length needed. So... about the only thing you need to do in order to make a hand knit by machine is to get the stitch gauge and find the row gauge. When the pattern says to knit 10" up to the armhole, you will multiply the number of rows to 1" by 10. You will need to work this out for the length of the armhole, the depth for the neck and shoulder shaping and the length of sleeve and sleeve cap. Some hand knitters keep track of the rows anyway.. they put a hand knit Row Counter on the end of their needles and keep track by turning the numbers after each two rows. This way they are sure the rows will match when they put the garment together. You can always substitute an easy to knit machine Pattern Stitch for a complicated hand knit pattern, but you still have to get the correct stitch gauge given, and know the row gauge.

FINISHING INSTRUCTIONS

We occasionally receive letters from readers complaining that we do not give adequate finishing instructions. Actually, we think we give more than enough instructions... We do not have the space in the magazine to cover every little detail such as the exact spot of where to sew a pocket on, the exact size of button or zipper to use. We tell you the size of zipper we use on a garment and if you block your garment and finish it as we say, this is the size you will need. Buttonholes can be finished in different ways and each person should use the button size that fits their finished buttonhole and that looks good to them. You must use your own judgement for some things. The placement of a pocket is a personal thing and you can always see the photograph of garment on the model in our magazine. Explicit instructions for knitting... finishing... sewing on collars and bands... plus all kinds of hints and helps... is given in our "Practical Knitting Hints" book. The cost is \$2.95 plus 40¢ shipping. If you do not have one, it is worth every penny of its cost. You will want to read it through from cover to cover, then you can always find special information by checking the Index.

PRACTICAL KNITTING HINTS

MOCK RIBBING

When we need a band for the lower edge of a sweater or a jacket... for sleeve edges and necklines etc... most of the time a true ribbed band is called for. A true rib is always made by using the Ribber in combination with the main Machine. There are times however, when a pattern calls for a MOCK RIB and this is made using the main machine only. A Mock Rib is always knitted with certain needles out of work and a hem must be formed by hanging the cast-on stitches back onto the machine to form a double hem. Those of you who do not own a KNITKING machine with the Coordinated Ribber can in most cases, use the Mock Rib in place of the true rib bands on any garment. When making a garment in stockinette stitch, a Mock Rib should be made using one or two tension settings tighter than the tension used for the

main section of a garment. If a Pattern stitch is used for the main section as for the Sweater and Hat DP 8225 in this issue, you need not use a different tension for the Mock Ribbing. The most important part of a Mock Rib is in hanging the hem. If you do not do this properly, you will end up with holes that will spoil the look of your garment.

In Pattern No. DP 8225, the Sweater Instructions tell you to hang the hem after Row 56. To do this first hang each of the group of 3 cast-on stitches onto the machine, being sure to leave these stitches in front of the latches of the needles. (If you have a machine other than a KNITKING machine, you must place the stitches that are already on the machine behind the latches before hanging the cast-on stitches).

Now you must fill the empty needles by taking the loop formed by each 3rd stitch (even though it is already hung onto the 3rd stitch) and with the eye end of a tool, pick up the loop, give it a twist and hang the newly formed stitch onto the empty needle. It does not matter which way you twist the stitch just so that you twist all of them in the same direction. Leave the newly formed stitch IN FRONT of the latches. Now knit these stitches through the stitches which are behind the latches. KNITKING machine owners knit the stitches through in the following manner... Take the yarn out of the feed finger and hang it to the side, push back the right Cam Control Button (the

Cam Box is at the right) and knit two rows without yarn. Return the Cam Control Button, turn the Row Counter back to 56 and continue with your pattern.

When you have completed the garment section and removed it from the machine, take a ruler and push it through the formed hem, then pull downward - hard - so that the stitches form a rib look. When you block a Mock Rib such as this one where 3 needles are on the main machine then a needles out of work, etc. stretch the hem downward and push the rib together, pin, then with iron held high (DO NOT PRESS) allow the steam to penetrate. Leave the section on the board until it is thoroughly dry. Remember when working with synthetic yarns, be very careful to use steam only, as the iron will ruin the yarn. (An Iron-All sold by KNITKING will save you many headaches).

If you have any doubts, you can place a wet cloth over the ribbing, allow it to stand for several hours then remove the cloth and allow the section to dry. You would use this same method for any Mock Ribbing except a one and one Mock Rib. When you have one needle on the main machine and one out of work for a 1 x 1 rib, if you pulled down hard on the hem, the stitches could easily go together so that you lose the ribbed look... In this case, you must use 2 or 3 tensions tighter for your knitting, then block the hem by stretching the knitting in width instead of length so it looks like a rib.

SALE OF USED KNITTING MACHINES

How about a good used Knitting Machine or a Baby Lock for Christmas...? As usual, we have some fabulous bargains.... Send payment with your order... If the Model you order is sold out, we will return your money. Master Charge and BankAmericard accepted.

<u>SINGLE BED MACHINES</u>		<u>Selling Price</u>	<u>Sale Price</u>
<u>Brother</u>	588 Lacemaker (like new) - sold new for	\$239.00	\$150.00
	585 Lacemaker (excellent) - sold new for	239.00	100.00
	500 (like new) - sold new for	89.50	30.00
	531 (good) - sold new for	99.50	30.00
	530 (very good) - sold new for	99.50	30.00
	551 With Ribber - (very good) sold for	229.00	90.00
	551 (good) - sold for	129.50	40.00
<u>Empisal</u>	(same as Studio)		
	305 with Ribber - (like new) sold for	300.00	150.00
	305 (like new) - sold for	200.00	100.00
	305 (excellent) - sold for	200.00	95.00
	100 (excellent) - 164 needles - sold for	99.50	30.00
<u>Genie</u>	1500 with Ribber (like new) - sold for	180.00	95.00
	1500 (like new) - sold for	99.50	59.50
	1800 (like new) - sold for	129.50	79.50
	1800 with Ribber - (like new) - sold for	199.50	125.00
<u>MEMORY KING</u>	Lacemaker - Punch Card (brand new) - freight damage to cases only. sells for	329.00	279.00
<u>Studio</u>	321 Cardmatic - complete with Ribber and Radar (like new) sells for	583.00	450.00
	303 with Ribber - (very good) - sold for	379.00	125.00
	303 (good) - sold for	279.00	75.00
	301 (good) - sold for	279.00	55.00
	103 (good) - sold for	149.00	35.00
	102 (good) - sold for	139.00	30.00
<u>Toyota</u>	727 Punch Card Knitter (like new) - sold for	329.00	125.00
<u>DOUBLE BED MACHINES</u>			
<u>Duomatic</u>	(excellent) - sold for	449.00	200.00
<u>Orion</u>	440 needles Electric (excellent) - sold for	779.00	350.00
	440 needles (excellent) - sold for	429.00	150.00
	360 needles (excellent) - sold for	329.00	100.00
	360 needles (very good) - sold for	329.00	75.00
<u>Swiftomatic</u>	400 needles (Strigo) (like new) - sells for	399.00	125.00
	(excellent) - sells for	399.00	75.00
<u>Turmix</u>	400 needles (excellent) - sells for	399.00	75.00
<u>BABY LOCK SEWING MACHINES</u>			
	Model #305 - Cut, Sew, Overlock - brand new - sold for	279.00	179.00
	Model #305 - Cut, Sew, Overlock - excellent - sold for	279.00	150.00
	Model #605 - Cut, Sew, Overlock - excellent - sold for	329.00	190.00

NOTES TO KNIT BY . . .

STITCH AND ROW GAUGE

KNIT A SAMPLE SWATCH . . . before you begin to knit any garment . . . for this is the MOST IMPORTANT STEP toward the correct size and the proper fit of any garment you wish to make. You MUST use the SAME YARN for your sample swatch that you will use to knit your garment and your sample swatch must be knitted large enough and using several different tension numbers on your machine. When you have done this, then you can determine the number of stitches and the number of rows in a two-inch measure. KNITTING MAGAZINE PATTERNS give you 3 tensions to try and one of them should give you the correct stitch and row gauge if you are using the yarn we recommend or a similar weight yarn. Here is the way to make your sample swatch.

Cast on over a sufficient number of needles to produce a swatch at least 4 inches wide. (If the pattern calls for 16 stitches to 2", then 16 x 2 = 32 stitches to cast on). Now knit 4 inches of rows at the first suggested tension number. (If the pattern calls for 22 rows to 2", 22 x 2 = 44 rows to knit). Knit 2 rows using a contrast color, change to the next higher tension and with garment yarn knit another 4", knit 2 rows with contrast color, change to the 3rd higher tension and knit another 4" and then bind off.



Roll the swatch into a cylinder over its length and pull on both ends, unroll it and stretch it diagonally by pulling on the four corners. Allow the swatch to rest and settle (preferably overnight) and then using a stitch gauge or a ruler, count the number of stitches over a 2" width, then the number of rows over a 2" length in EACH of the 3 tensions. Select the tension number that produces the stitches and rows called for in the pattern. If none of them are correct, you are most likely using the wrong weight of yarn.



READING OF CHARTS

You will notice the instructions start at the bottom of the Chart, and work UP. Follow the charts exactly as written and providing your sample stitch and row gauge is correct, your garment will come out the right size. Please remember that the section of garment as it is knitted on the machine, faces the same way as the Charts are in this magazine. Where two front pieces are needed, (or any other part of a garment that needs two sections) only one section is normally shown and the second section is usually made with reverse shaping. Set in sleeves are usually identical, but raglan sleeves have to be knitted with reverse shaping for the second sleeve.

READING OF SYMBOLS

To simplify Pattern Knitting, we use Symbols in the Line Drawings and the Chart Diagrams. In the Line Drawings the symbols are shown and are to be read as you look at them while knitting a garment. For instance, if

a Purl stitch faces you, the Purl stitch Symbol  is shown; if a knit stitch faces you (as when using the Ribber) then this Symbol  is shown. The Symbol  at the top of the Line Drawing is the center of the garment section and you use this as a guide for setting up the needles.

The following Symbols    are used for Eyelet Designs in the Line Drawings and also for Full Fashion shaping on the Charts. The Line Drawings have row numbers on the right side. Missing Row numbers are always knitted straight or plain.

In Holding Position Designs  selected needles are pushed into holding position for the stated number of rows. The numbers of rows appear at the right of the Line Drawings; Example: 1-4 means knit Rows 1 to 4; 5 to 7 means knit Rows 5 to 7, etc. This same Symbol is also shown on the Charts and is used for putting needles into holding position for Short Rows. The

Symbol  on the Charts is used to put needles back into working position when knitting Short Rows.

A number in a box stands for the number of rows to be knitted between shapings. Make shaping first, then knit the necessary number of rows. If for instance it reads:

1 st. 8 x



1 st. 10 x



As you will be reading the instructions from the bottom up, here is the way you will follow them: . . . Decrease or increase (depending on the direction of the garment outline) 1 st. at the row where the shaping begins, then knit 8 rows, make the next decrease, then knit 8 rows, until you have decreased (or increased) 1 st. 10 x and you have knitted 8 rows after each decrease (or increase) (1 st. 10 x + 8 rows 10 x). Now begin the first decrease (or increase) for the shaping (which has to be made 8 x) in every 6th row. Decrease (or increase) 1 st. first, then knit 6 rows until you have decreased 1 st. 6 x and after each decrease (or increase) have knitted 6 rows (1 st. 8 x + 6 rows 8 x).

Where shapings are given without a boxed number as on most armholes, necklines, etc., make the shapings on every second row (on each side of course).

(See below for more Pattern Stitch Symbols.)

KNITTING PATTERN SYMBOLS

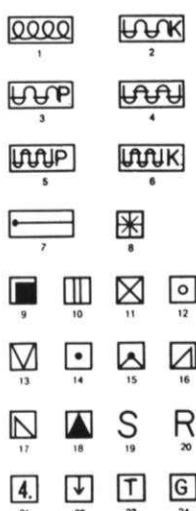

1. Cast on
2. Stockinette stitch - worn on the Knit side
3. Stockinette stitch - worn on the Purl side
4. Knit 1, Purl 1, Ribbing
5. Ribbing Pattern - worn on the Purl side
6. Ribbing Pattern - worn on the Knit side
7. Put on a stitch holder
8. Pattern Stitch
9. Knit Stitch
10. Purl Stitch
11. Needles back into working position
12. Empty needle (leave in working position)
13. Needle not used (in the out of work position)
14. Needle in holding position
15. Two stitches on 1 needle - either transferred from the right side or the left side, then put into holding position
16. Needle holding 2 stitches. Stitch has been transferred from the LEFT
17. Needle holding 2 stitches. Stitch has been transferred from the RIGHT
18. 3 stitches on 1 needle. The 1st and 3rd stitch in a group of 3 needles has been hung on the 2nd or center needle
19. Stitch
20. Row
21. Number of rows to be knitted between shapings
22. Bind off
23. Tension

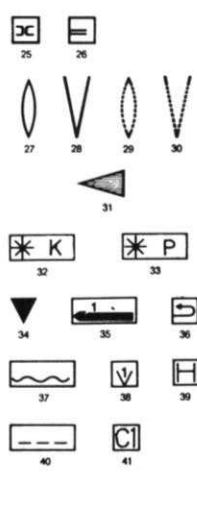

24. Gauge
25. Reverse one section
26. On every other needle
27. & 28. Open Dart
29. & 30. Closed Dart
31. Short Row increase or decrease, for instance on flared skirt knitted sideways
32. Pattern stitch - worn on the Knit side
33. Pattern stitch - worn on the Purl side
34. Center of garment section
35. Work 1 (2 etc.) rows single crochet around edges
36. Turn to the wrong side and hem
37. Ease
38. Match numbers on sections for assembling
39. Hem
40. Fold line
41. Color number (example - C1 = Color 1)

The Roman numeral numbers shown on each garment section are as follows:

I	=	Front
II	=	Back
III	=	Sleeve
IV	=	Skirt Front
V	=	Skirt Back
VI	=	Collar
VII	=	Pocket
VIII	=	Band
IX	=	Belt
X	=	Cuff

