

knitking

magazine

nov./dec. '74





knitking

magazine

editorial

We are being squeezed into a small space this issue... You were promised a new magazine twice as large as previously, but we just couldn't get everything into 64 pages, so this issue has 76 pages plus the cover... 12 more than we planned for and more than twice the usual amount of work in planning and preparing... We believe that you will like our new method of pattern presentation giving three sizes for each garment, using the identical type and weight of yarn and we think you will soon become accustomed to the new style of written instructions... They are abbreviated, but still easy to follow... We would need over 100 pages using the old instruction method.

This is a glamour issue with many high style fashions and the emphasis on metallics and lacy designs... Yet, we have several enlarged sizes for readers with fuller figures... Watch out for future issues, we aim to cater to all tastes, so please don't hesitate in telling us of your likes and dislikes... KNITKING MAGAZINE is your magazine.

Cover Model

DK16

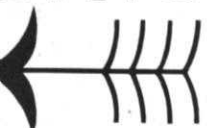

DK 8

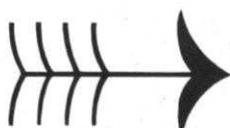

DK10

Publisher: KNITKING CORPORATION, 1128 Crenshaw Blvd., Los Angeles, Calif. 90019. Telephone: (213) 938-2079. Published bi-monthly. Subscriptions: USA — \$10.00 annually, single copies \$3.00; Canada \$12.00; other parts of the world — \$15.00. The entire contents of KNITKING MAGAZINE are copyright and must not be reproduced in any shape or form without the express permission, in writing of the publisher. © COPYRIGHT 1974 by KNITKING CORPORATION.

Printed in West Germany.

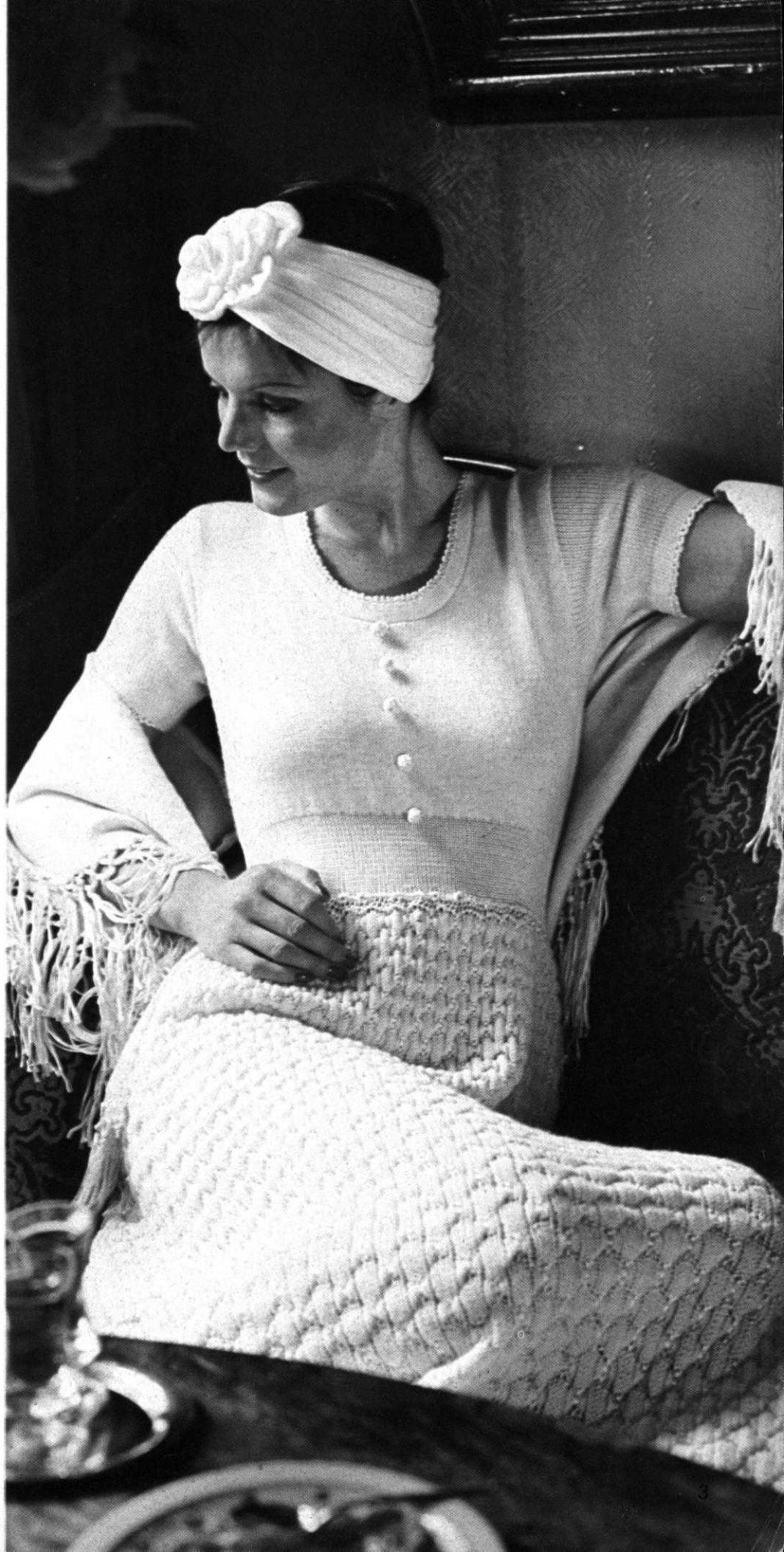

DK12

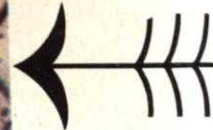

Another first from Knitking!!!

THE ~~WHIZ KING~~ PATTERN READER with complete Charting Service

- With **WHIZ KING** you know exactly what to do without reference to written instructions.
- With **WHIZ KING** you no longer have to count rows . . . Your Pattern Chart turns automatically as you knit.
- With **WHIZ KING** you can knit even the most intricate patterns easily and speedily.
- With a **WHIZ KING** Pattern Reader, even the complete newcomer to machine knitting can immediately knit garments.
- With **WHIZ KING**, Charts are available from **KNITKING MAGAZINE** Patterns in the size of your choice.

PRICE: 59.50 Complete with instructions, practice Charts and illustrations of 50 complete Patterns for the entire family. (California residents add Sales Tax)
Shipping costs \$2.50.

ORDER DIRECT FROM **KNITKING** 1128 CRENSHAW BLVD. • LOS ANGELES, CALIFORNIA 90019

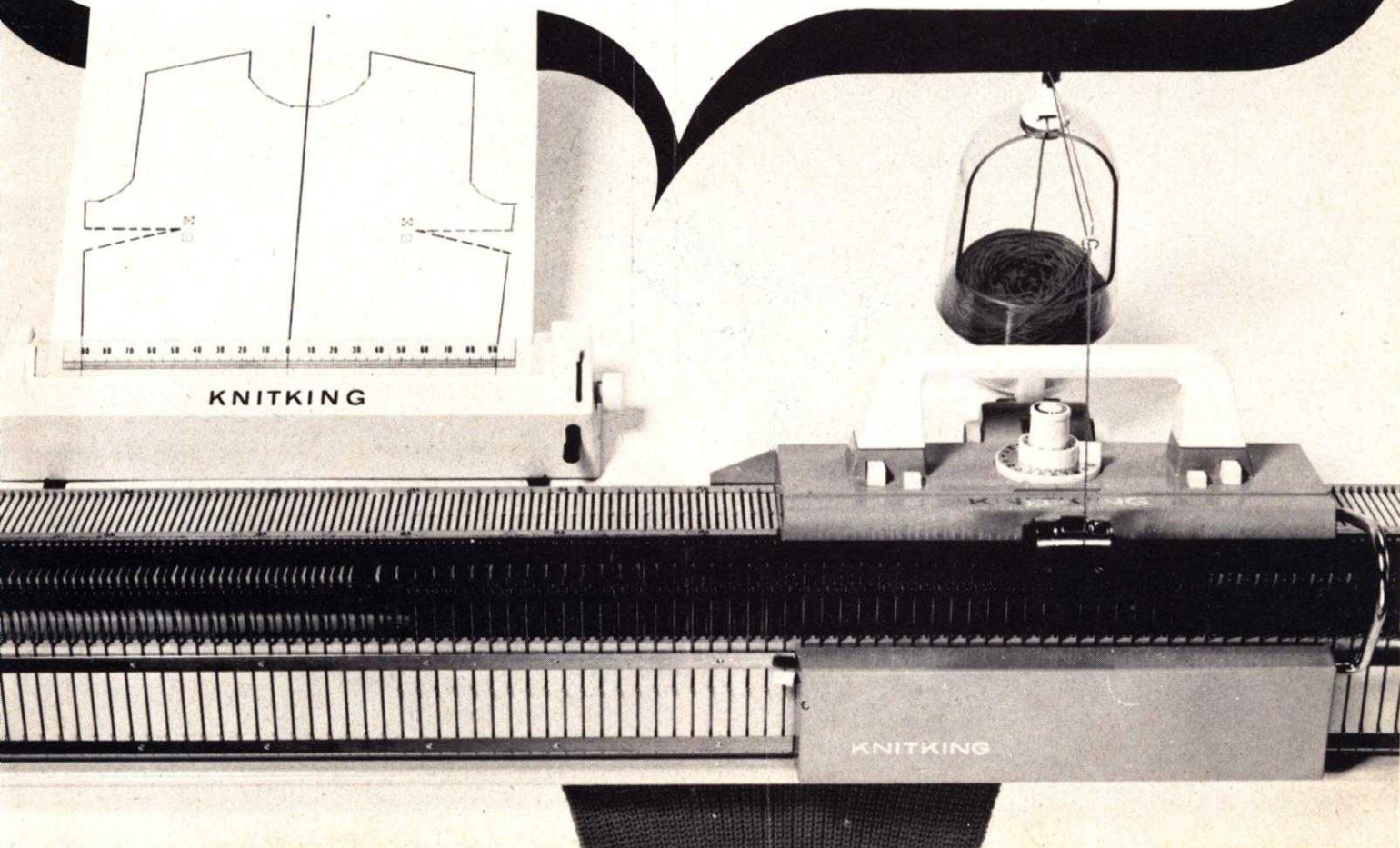

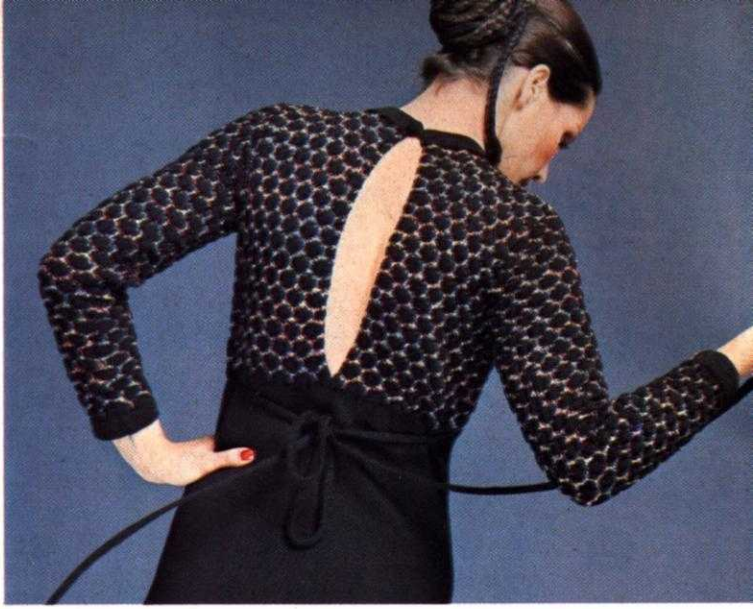

DK 3

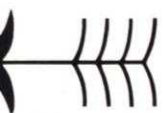
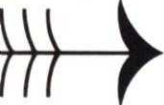

DK 1

DK 4

DK 5



DK C
←

DK1
DK1









DK18

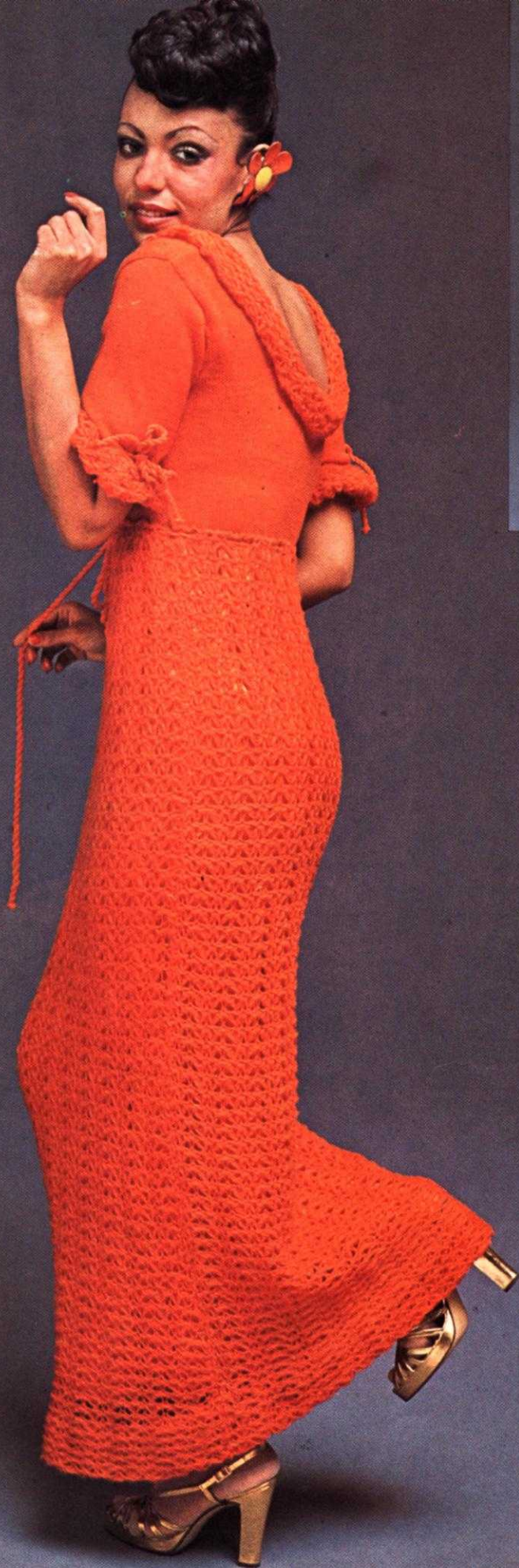
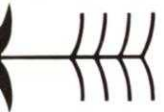

DK 7



DK 9



←
DK1



Knitking News

THIS IS IT...! The first of our NEW FORMAT, increased size magazines and you would never believe the problems we encountered in putting it together. At times it seemed that we would never have it ready for distribution this year, but as this is being written we know that most problems have been overcome and printing is underway.

because of tremendous increases in printing and paper costs, KNITKING MAGAZINE is now a joint effort by our Parent Company in Germany and us, the U.S. Distributors. At the present time, printing and paper costs are much lower in Germany than in the U.S.A. so this issue is being printed in Germany and shipped in bulk to California for distribution.

Language problems are the most difficult to overcome, so it was necessary to revise and add to the knitting symbols... more modifications will be made in the future so that everything is easily understood by our readers.

Many readers have asked for high fashion designs and they should be well satisfied with the styles appearing in this and those forthcoming in the January/February edition. The women's clothes in both issues are designed by the famous European Designer, Milena Strasova who managed to make things even more difficult for us by using completely new and somewhat expensive yarns in several of the garments. The gold and silver garments appear to be all metallic when, in fact, they are 75% wool and very expensive. Garments DK 3 and DK6, for example, will cost approximately \$80.00 each to make, but obviously, they would cost five or six times that price to buy. We displayed DK6 at the Los Angeles County Fair and dozens of people wanted to buy the garment from the display case. We also displayed several other garments from this issue and they were all very well received with DK 11 proving the most popular.

We thank all our friends who took the time to visit with us at the County Fair. Their enthusiasm for the KNITKING organization and KNITKING MAGAZINE helps to inspire us to go on to even bigger and better things.

PRACTICAL KNITTING HINTS PATTERNS IN 3 SIZES

The 3 sizes given for our Patterns are now designed to be knitted with the SAME YARNS and at the SAME TENSIONS. The difference in sizes usually begins with the number of cast-on stitches and where necessary, for the shaping, a different number of stitches as well as rows are given between the shapings. It is important that you follow the increases and decreases and bind-offs for your size.

Please note that a complete shaped Chart is for the smallest size garment. If you use one of the other two sizes, follow the same general shaping, but use the numbers under your size for the number of stitches to cast on, the increases and the

decreases and bind-offs. No numbers under a section of the Chart simply means that you use the same numbers as in the smallest sizes which is the shaped Chart.

Always remember that when a Pattern tells you to increase or decrease 1 stitch every 8th row 4x, make the first increase (or decrease) immediately and then knit 8 rows, etc. etc.

The x means times... for instance: On the Chart for a back section, the bind offs for the armhole shapings in this issue might show: 1 x 4, 1 x 3, 2 x 2, 4 x 1; Make your bind offs as follows:
4 sts. 1 time (at the beginning of next 2 rows)
3 sts. 1 time (at the beginning of next 2 rows)
2 sts. 2 times (at the beginning of next 4 rows)
1 st. 4 times (at the beginning of next 8 rows)

You are shaping the armhole on EACH SIDE of the BACK section.

READ FROM THE TOP DOWN

You will now follow KNITKING MAGAZINE printed Pattern Instructions reading from the top, down. If you are following the written instructions, you will find the shapings in the smallest size given first, with the second size in () and the third size in . Where there is no difference in the shapings, only 1 set of instructions will be given and you should follow them as written.

CENTIMETERS FOR MEASUREMENTS

All measurements on the KNITKING MAGAZINE CHARTS are now in Centimeters. The garment industry and the school systems are changing to the Metric system. There are Measuring Tapes with both the Centimeters and Inches printed and you can purchase one at any Department or Yard Goods Store. Some of the tapes have the Centimeters and the Inches marked on the same side while other tapes have the Centimeters on one side and the inches on the other. To find the number of inches, place your finger on the number of Centimeters (GIVEN ON A PATTERN SECTION) on the Tape, look directly above (or the other side of Tape) and the number of inches will be given.

HOLDING POSITION DESIGNS FOR MACHINES OTHER THAN KNITKING

Owners of machines other than KNITKING, be sure you understand the symbols on the Line Drawings for the Pattern Designs. Knit a sample so that you know what controls to use for your particular machine. Write the instructions down and put them with your sample swatch. Usually if there are no plain knit rows between the change in holding needles (as in Pattern I for DK 8) you must put the holding needles back and place the stitches back into the hooks of the needles before changing the Pattern to the alternate needles.





THE SAMPLE SWATCH

Before you begin to knit any garment, you will need to knit a sample piece using the yarn you have chosen for your garment, so that you can check the stitch and row gauge which must measure the correct number of stitches and rows in 2 inches (5 cm).

For each Pattern in KNITKING MAGAZINE, we give you 3 Tension Numbers to work from and if you use the specified yarn for the garment, you should be able to get the correct stitch and row gauge using one of these numbers. Here is a very easy way to make your sample swatch and count the stitches and rows WITHOUT actually counting by using our KNITKING CONVERTA TAPE.

Supposing the Tension Numbers for the Stitch and Row Gauge are given as 5 to 7. Set the Tension Dial to the first number which is 5. With contrast waste yarn, and using the quick cast-on method, cast on 60 stitches and knit 10 rows. Change to garment yarn and turn the Row Counter to 0. Knit 30 rows. Counting from each end, knit the 10th stitch on each side by hand with a small piece of contrast yarn. Leave the needles in working position and knit 30 rows (Row 60), then knit 4 rows with contrast waste yarn. Turn the Row Counter to 0 and the Tension Dial to 6 and with garment yarn, knit 30 rows. Mark the 10th stitch on each side as you did before, knit 30 rows, then 4 rows with contrast waste yarn. Turn the Row Counter to 0 and with Tension 7, repeat the above once more ending with 10 rows of contrast waste yarn, then remove the work from the machine by passing the Slide across the needles without yarn (sometimes called 'dropping').

Pull and stretch the sample piece both lengthwise and diagonally from corner to corner, then length-

wise again. Do not count the stitches and rows immediately, but allow the sample to rest for several hours or even over night. This will allow the stitches and rows to return to their basic form.

When your sample has rested and you are ready to count the stitches and rows, the KNITKING CONVERTA TAPE will do the figuring for you without any counting on your part. Use the Tape as follows...

converta tape

Price \$9.50

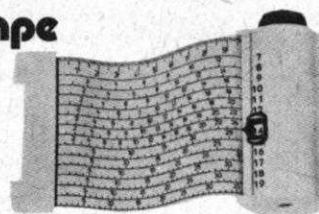

To measure the stitches, pull out the Tape to measure BETWEEN the 40 stitches in the center that you marked by hand knitting with contrast yarn. Push the red marker on the Tape so that it points to 40 stitches on the tape. Your stitch gauge to 2 inches will show in the red window on the tape. To find the number of rows in 2 inches, place the tape to measure over 60 rows, push the red marker to 60 on the tape and your row gauge for two inches will show in the red window.... Easy...? If you do not get the correct stitch and row gauge in the first part of your sample, then try the other two.

If you do not own a KNITKING CONVERTA TAPE, you must mark a 2 inch square in the center of the knitting, then count the number of stitches and rows within the square.

ARE YOU UNHAPPY WITH YOUR PRESENT KNITTING MACHINE ?

- DOES IT REFUSE TO KNIT FANCY DRESS YARNS?
- DOES IT JAM UP WHEN YOU TRY TO KNIT LOOPED MOHAIR OR THICK AND THIN YARNS?
- DOES IT DROP STITCHES ALL OVER THE PLACE?
- ARE YOU CONTINUALLY HAVING TROUBLE WITH AWKWARD, CUMBERSOME WEIGHTS?
- ARE YOU UNABLE TO MAKE A LARGE GARMENT WITH BULKY YARNS?
- DO YOU HAVE TO SELECT PATTERN STITCHES MANUALLY?
- DO YOU HAVE TO LATCH YOUR RIBBING BY HAND?
- IF YOU ARE HAVING ANY OF THESE PROBLEMS YOU SHOULD TRADE UP TO A NEW FANTASTIC PUSH BUTTON KNITKING WITH COORDINATED RIBBER AND ENJOY KNITTING WITH THE WORLD'S FINEST, MOST VERSATILE AND MOST AUTOMATIC KNITTER.
- YOU WILL BE SURPRISED AT OUR GENEROUS TRADE-IN ALLOWANCE AND YOU CAN, IF YOU WISH, USE YOUR PRESENT MACHINE AS A DOWN-PAYMENT AND PURCHASE A COMPLETE KNITKING FOR JUST PENNIES A DAY. WRITE TODAY FOR FULL INFORMATION AND TELL US WHAT MACHINE YOU NOW OWN. THE ADDRESS IS:

KNITKING, Dept. T-1, 1128 Crenshaw Blvd., Los Angeles, Calif. - 90019





General Instructions

Full Fashion decreasing and increasing

For Stockinette stitch, always use the Full Fashion method for decreasing or increasing.

TO DECREASE: Hang the 3rd stitch onto the 2nd stitch then move the stitches in to fill the empty needle.

TO INCREASE: Move the 2 end stitches 1 needle outward then pick up the 3rd stitch from the row below and hang it onto the empty needle.

Norwegian Designs

In the instructions, each row of the Norwegian Design is counted as 1 row but several movements of the Cam Box are needed to complete 1 row.

To make fringe

Cut yarn **DOUBLE** the length of fringe desired (wind around a cardboard or book). Using 2 or more strands of yarn (depending on weight of yarn), fold in half and with a crochet hook, draw folded loop through knitting from the wrong side. Pull strands through loop and tighten.

To make an additional row of knots on fringe, take half the strands from 1

group and half from the next group then knot together approximately 1" to 2" below and continue across.

Finishing



























Block all sections.

For Pullovers, Jackets and Dresses: Join front to back at sides and shoulders. Sew sleeves together and set in. Hem lower edge and sleeve edges if needed. For a double neckband or armhole band, sew 1 edge to the inside and 1 to the outside of neck or armhole. For a single ribbed band, sew 1 edge to the outside of neck or armhole edge. For a Cardigan or Jacket with buttonholes, finish buttonholes and sew on buttons.

PANTS: Join front to back at sides. Sew inside leg seams then join center front and back. Make hem at waistline and insert elastic. Hem lower edge of pants legs.





PATTERN SYMBOLS

-  1 Cast on
-  2 Stockinette stitch - worn on the Knit side
-  3 Stockinette stitch - worn on the purl side
-  4 Knit 1, Purl 1, Ribbing
-  5 Ribbing Pattern - worn on the Purl side
-  6 Ribbing Pattern - worn on the Knit side
-  7 Put on a stitch holder
-  8 Pattern Stitch
-  9 Knit Stitch
-  10 Purl Stitch
-  11 Needles back into working position
-  12 Empty needle (leave in working position)
-  13 Needle not used (in the out of work position)
-  14 Needle in holding position
-  15 Two stitches on 1 needle - either transferred from the right side or the left side, then put into holding position
-  16 Needle holding 2 stitches. Stitch has been transferred from the LEFT
-  17 Needle holding 2 stitches. Stitch has been transferred from the RIGHT
-  18 3 stitches on 1 needle. The 1st and 3rd stitch in a group of 3 needles has been hung on the 2nd or center needle
-  19 Stitch
-  20 Row
-  21 Number of rows to be knitted between shapings
-  22 Bind off
-  23 Tension
-  24 Gauge
-  25 Reverse one section
-  26 On every other needle

 27 & 28. Open Dart

 29 3 stitches on 3 needles. For increasing hang the 3 stitches with transfer tool on to the next exterior needles and put 3 additional needles into working position at the outside.

 30 Increase

 31 Short Row increase or decrease, for instance on flared skirt knitted sideways

 32 Pattern stitch - worn on the Knit side

 33 Pattern stitch - worn on the Purl side

 34 Center of garment section

Gr. 35 2nd size (Gr. 16/18)
3rd size (Gr. 20/22)

 36 Turn to the wrong side and hem

 37 Ease

 38 Match numbers on sections for assembling

H 39 Hem

 40 Fold line

F 1 41 Color number (1st color = example)

 42 Model for beginners

 43 Pattern Reader

 44 Repeat

 45 After the first knitting phase of Norwegian Pattern please release the lever of the Pattern Reader and turn it on again after having finished the following different phases in one row.

4.

First please do the required number of decreases and increases and afterwards knit the corresponding number of rows; e.g. 3 x 1 S 4 = decrease 1 S, knit 4R, decrease 1S, then knit again 4R and so on. All decreasing and increasing without numbering of rows (e.g. 4) has to be done on every 2nd R.

I = Front
II = Back
III = Sleeve
IV = Skirt Front
V = Skirt Back
VI = Collar
VII = Pocket
VIII = Band
IX = Belt
X = Cuff
XI = Trousers Front
XII = Trousers Back

DK 1

Long Dress and Cape

SIZE: 8/10 (12/14) [16/18]

YARN: Beatrice grams 2400 2450 2500

YARN: Capriccio grams 600 625 650

Pattern: 9 to 10

Stock: 4 to 6

Pattern: 13 sts., 26 rows = 2"

Stock: 18 sts., 24 rows = 2"

Buttons

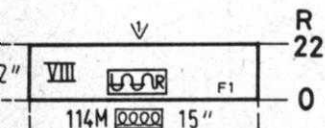

Neckband: VIII

All Sizes. Cast on 114 sts. with color 1 and knit 22 rows Stockinette stitch, then bind off all sts.

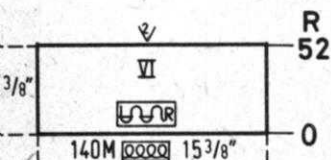

Cape Collar: VI

All Sizes. Cast on 142 sts. and knit 52 rows Stockinette stitch, then bind off all sts.

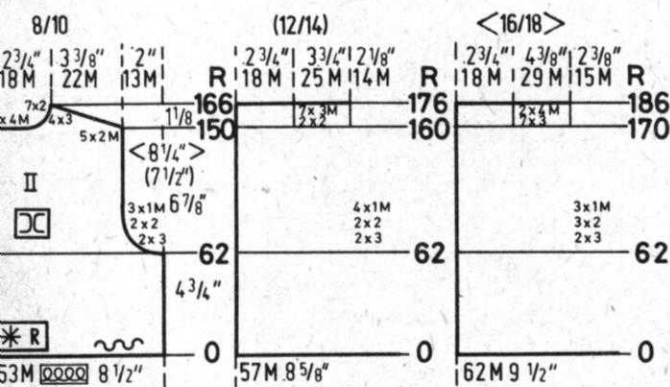

DK 1 (Dress)

Neck: I

Make 1, reverse 1)

Bring 53 (57) [62] needles into working position then set up into Pattern and cast on. Knit to Row 62. Shape Armhole: ON EACH SIDE, bind off 2 sts. 2x, 2 sts. 2x, 1 st. 3x (2 sts. 2x, 2 sts. 2x, 1 st. 4x) [3 sts. 2x, 2 sts. 3x, 1 st. 3x] Knit even to Row 150. (160), [170] Shape neck and shoulder at the same time.

Bind off on shoulder side 2 sts. 5x, 3 sts. 4x (2 sts. 2x, 3 sts. 7x) [3 sts. 7x, 4 sts. 2x] Bind off remaining 13 (14) [15] sts. Bind off on neck side 4 sts. 1x, 2 sts. 7x same as above same as above

For Skirt section, Stockinette stitch; for Bodice, Sleeves and Cape, Holding Position Design using the Adjustable Needle Selector. Follow the Line Drawing. The empty needles for Pattern DO COUNT in the stitch gauge and instructions. The knit side is the right side.

FINISHING:

See General Instructions. Gather bodice and sew to skirt section. Single crochet around back opening and make loop on 1 side and sew button to other side of neckline. CORD: Set your machine for knitting a cord. Cast on 5 sts. and with Tension 1, work 1650 rows (empty rows do count). CAPE: Join sections, leaving an opening to put arms through. Sew on bands. Finish buttonholes and sew on buttons. Put fringe on lower edge of Cape (See General Instructions).

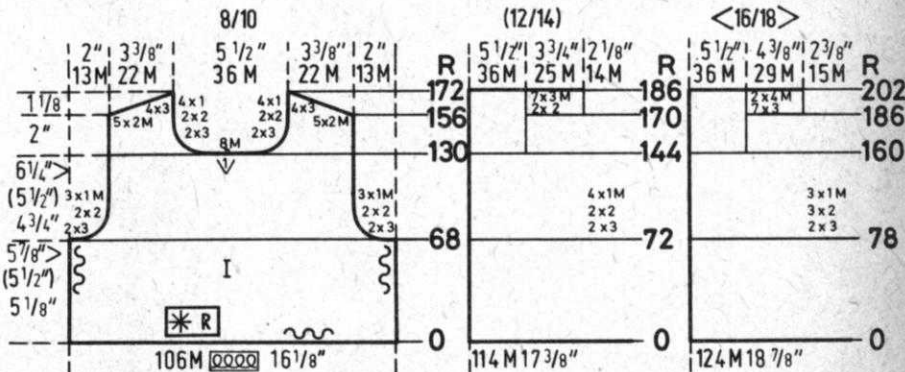

FRONT: I

Bring 106 (114) [124] needles into working position, set up into Pattern then cast on Knit to Row 68 (72) [78] Shape Armhole: ON EACH SIDE, bind off 3 sts. 2x, 2 sts. 2x, 1 st. 3x (2 sts. 2x, 2 sts. 2x, 1 st. 4x) [3 sts. 2x, 2 sts. 3x, 1 st. 3x] Shape Neck - All Sizes: After Row 130 (144) [160] Bind off the center 8 sts. Put the needles on the left side into holding position and complete the right half first.

* ON NECK SIDE, bind off 3 sts. 2x, 2 sts. 2x, 1 st. 4x. Shape shoulder after Row 156 (170) [186] On shoulder bind off 2 sts. 5x, 3 sts. 4x (2 sts. 2x, 3 sts. 2x) [3 sts. 7x, 4 sts. 2x] Bind off the remaining 13 (14) [15] sts. Bring the needles on the left side into working position, knit 1 row in Pattern to the left, turn the Row Counter back to 130 (144) [160] and complete the left half. Follow the instructions from *

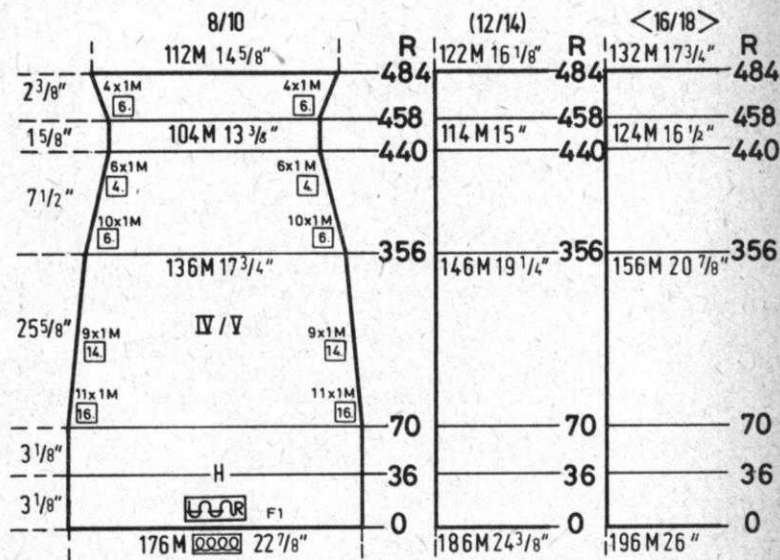

SKIRT:

Front and Back IV/V

Cast on 176 (186) [196] sts. with color 1 and work Stockinette stitch. All Sizes: Knit to Row 36, then form the hem. Knit to Row 70. ON EACH SIDE, decrease 1 st. after Row 70 then every 16th row 10x more, then every 14th row 9x, every 6th row 10x, every 4th row 6x. Knit to Row 458 and ON EACH SIDE decrease 1 st. every 6th row 4x. Bind off the remaining 176 (186) [196] sts.

DK 1

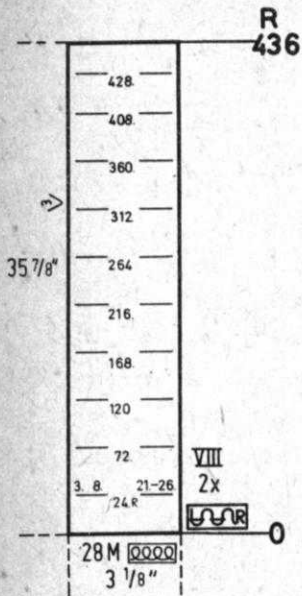

CAPE BUTTONHOLE BAND: VII

All Sizes: Cast on 28 sts. and work Stockinette stitch. Make Buttonholes over stitches 3 to 8 and 21 to 26 after Rows 24, 72, 120, 168, 216, 264, 312, 360, 408, 428. Knit to Row 436 and bind off.
Work the Button Band the same but omit the buttonholes.



CAPE BACK: II (Make 1, reverse 1)

Bring 52 (58) [64] needles into working position, set up into Pattern then cast on. Work the back section the same as the front (omit the neck shaping) to Row 498. SHAPE SHOULDER as you did on the front and AT THE SAME TIME, SHAPE NECK after Row 499. Bind off 7 sts. 1x, 2 sts. 7x.

DRESS SLEEVE: III

Cast on 52 (56) [60] sts.
All Sizes: Knit in Stockinette stitch to Row 28, form the hem then change to Pattern.
ON EACH SIDE, increase 1 st. every 12th row 15x, every 10th row 2x.
After Row 226 shape cap.
All Sizes: ON EACH SIDE, bind off 3 sts. 3x 2 sts. 2x
ON EACH SIDE *decrease 1 st. every 4th row 1x, every 2nd row 1x and REPEAT from *6x (7x) [8x] more.
All Sizes: ON EACH SIDE, bind off 1 st. 2x, 2 sts. 1x, 4 sts. 2x then bind off the remaining 8 sts.

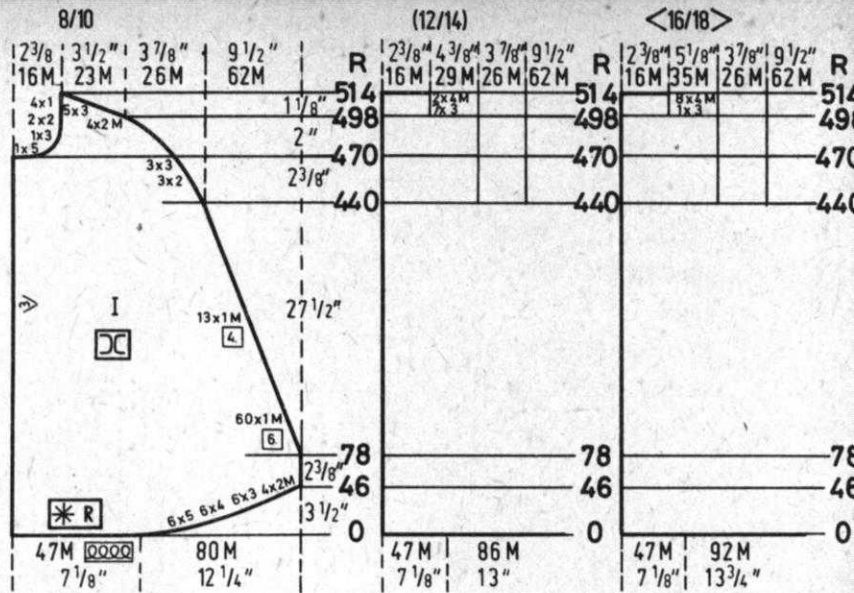

CAPE FRONT: I (Make 1, reverse 1)

Bring 47 (53) [59] needles into working position, set up into Pattern, then cast on.

All Sizes: ON CAM BOX SIDE, ON EVERY OTHER ROW

cast on 5 sts. 6x, 4 sts. 6x, 3 sts. 6x, 2 sts. 4x.

After Row 78, decrease 1 st. every 6th row 60x, every 4th row 13x. After Row 440, bind off 2 sts. 3x, 3 sts. 3x.
SHAPE NECK: All Sizes: After Row 471, bind off 5 sts. 1x, 3 sts. 1x, 2 sts. 2x, 1 st. 4x.
SHAPE SHOULDER after Row 498, bind off 2 sts. 4x, 3 sts. 5x (3 sts. 7x, 4 sts. 2x) [3 sts. 1x, 4 sts. 8x]

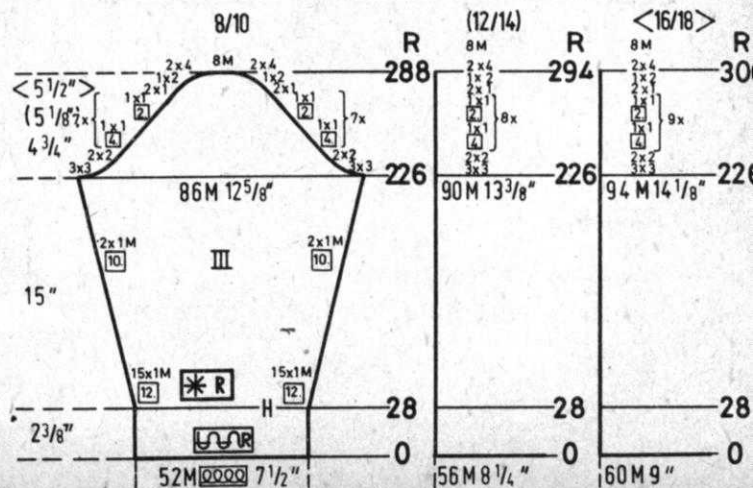
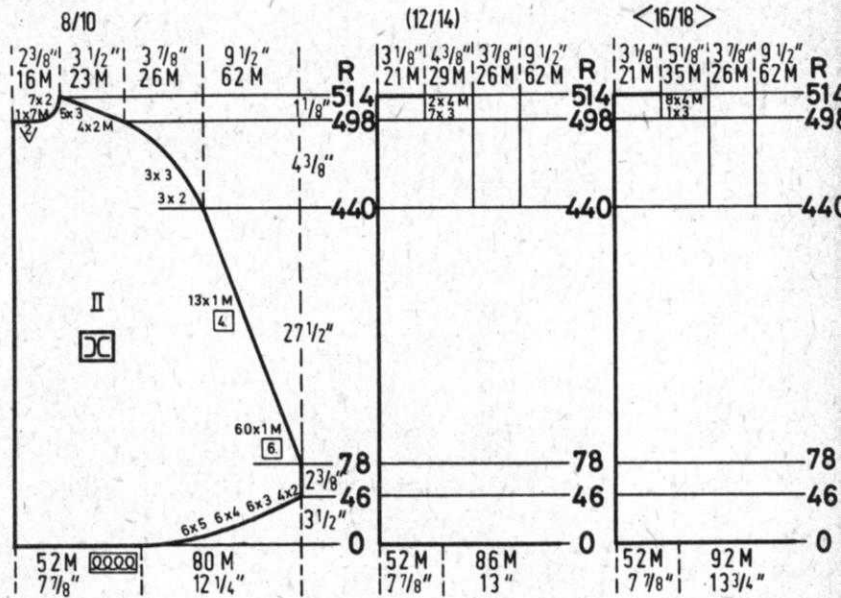

BOOK 2

ong Dress

SIZE: 14/16 (18/20) [42/44]
 YARN: Illustra grams 1100 1140 1200
 Gauge: 8 to 10
 Pattern: 10 sts., 24 rows = 2"
 Stock: 11 sts., 22 rows = 2"

Stockinette stitch with a Holding Position Design using the Special Wheel 4. Follow the Line Drawing. The empty needles DO COUNT in the stitch gauge and instructions. Worn on the knit side.

FINISHING:

See General Instructions. Gather top of Skirt and sew to bodice. Make Fringe (see General Instructions) for sleeve edges and lower edge of dress.

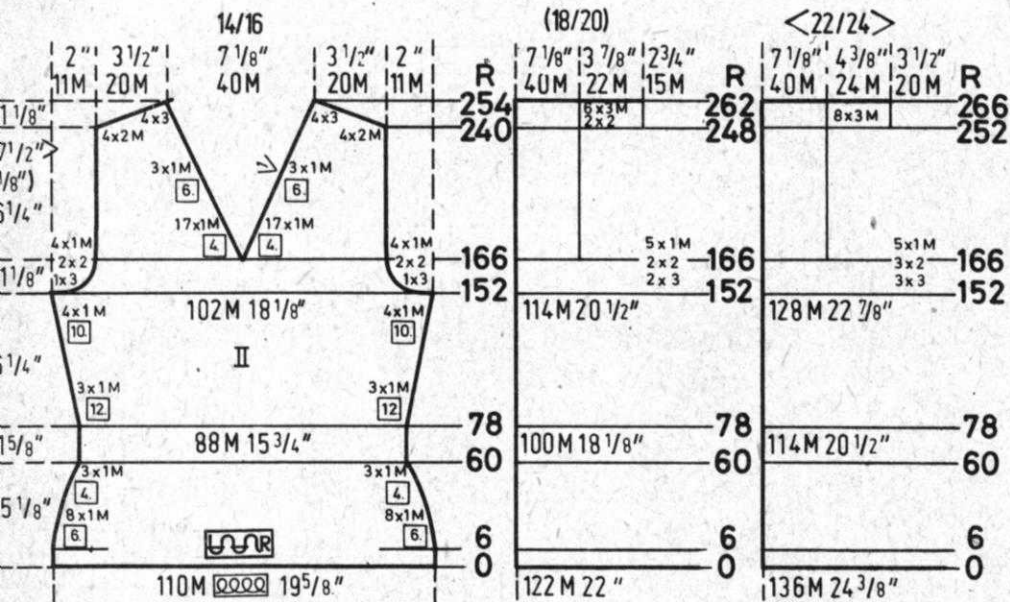

BACK II

Cast on 110 (122) [136] sts. Work in Stockinette stitch.
 ALL SIZES: ON EACH SIDE after Row 6, decrease 1 st. every 6th row 8x, every 4th row 3x. Knit to Row 78.
 ON EACH SIDE, increase 1 st. every 12th row 3x, every 10th row 4x. Knit to Row 152.
 SHAPE ARMHOLES: ON EACH SIDE bind off 3 sts. 1x, 2 sts. 2x, 1 st. 4x
 SHAPE NECK AFTER ROW 166 (3 sts. 2x, 2 sts. 2x, 1 st. 5x)
 (SHAPE NECK AFTER ROW 166) [3 sts. 3x, 2 sts. 3x, 1 st. 5x]
 [SHAPE NECK AFTER ROW 166]
 To start the neck shaping, hang each of the 2 center stitches 1 to the right and 1 to the left. Bring all the needles on the left side into holding position and complete the right half first. *ALL SIZES: ON NECK SIDE, decrease 1 st. every 4th row 16x more, then every 6th row 3x AND AT THE SAME TIME SHAPE SHOULDER after Row 240 (248) [252]. Bind off
 2 sts. 4x, 3 sts. 4x
 (2 sts. 2x, 3 sts. 6x)
 [3 sts. 8x].
 Bring the needles on the left side into working position, turn the Row Counter back to 166 and complete the left half. Follow the instructions from *.

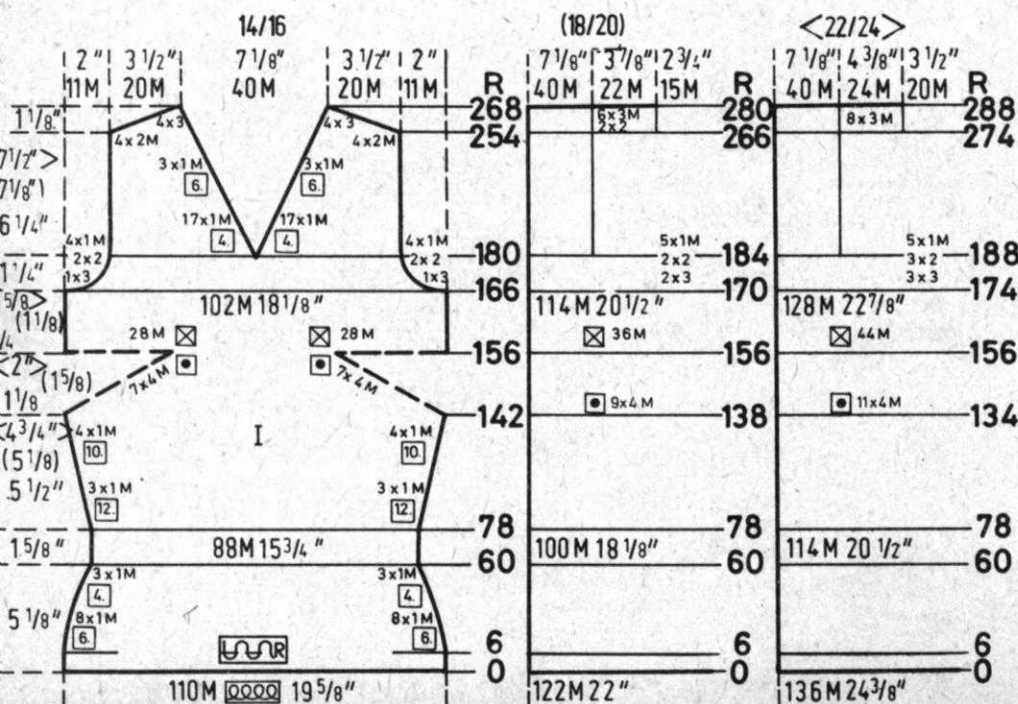

FRONT: I

Work the front the same as the back to Row 142 (138) [134].
 SHAPE BUST DART: Work Short Rows.
 ON OPPOSITE SIDE OF CAM BOX, put into holding position
 4 sts. 7x ON EACH SIDE
 (4 sts. 9x ON EACH SIDE)
 [4 sts. 11x ON EACH SIDE]
 Bring all the needles OPPOSITE CAM BOX back into working position before knitting the next 2 rows.
 Knit to Row 166 (170) [174]
 SHAPE ARMHOLE: ON EACH SIDE bind off 3 sts. 1x, 2 sts. 2x, 1 st. 4x
 SHAPE NECK AFTER ROW 180 (3 sts. 3x, 2 sts. 2x, 1 st. 5x)
 (AT THE SAME TIME SHAPE NECK AFTER ROW 184) [3 sts. 3x, 2 sts. 3x, 1 st. 5x]
 [AT THE SAME TIME SHAPE NECK AFTER ROW 188].
 To start the neck shaping, hang each of the 2 center stitches 1 to the right and 1 to the left. Bring all the needles on the left side into holding position and complete the right half first.
 *ALL SIZES: ON NECK SIDE, decrease 1 st. every 4th row 16x more, then every 6th row 3x AND AT THE SAME TIME SHAPE SHOULDER after Row 254 (266) [274] bind off
 2 sts. 4x, 3 sts. 4x
 (2 sts. 2x, 3 sts. 6x)
 [3 sts. 8x].
 Bring the needles on the left side into working position, turn the Row Counter back to 180 (184) [188] and complete the left half. Follow the instructions from *.

DK 2

SLEEVE III

ALL SIZES
Bring 40 needles into working position then set up in Pattern.
Work in Pattern
ON EACH SIDE, increase 1 st. every 12 rows 9x, every 10th row 6x. Knit to Row 178
ON EACH SIDE, bind off
3 sts. 2x (3 sts. 2x) [3 sts. 3x]
2 sts. 2x (2 sts. 2x) [2 sts. 1x]
1 st. 1x (1st. 1x) [1 st. 1x]
then ON EVERY 4th ROW ON EACH SIDE decrease 1 st. 12x (13x) [14x].
ALL SIZES: ON EACH SIDE bind off 2 sts. 1x, 3 sts. 2x
After Row 240 (244) [248] bind off the remaining 8 (10) [12] sts.

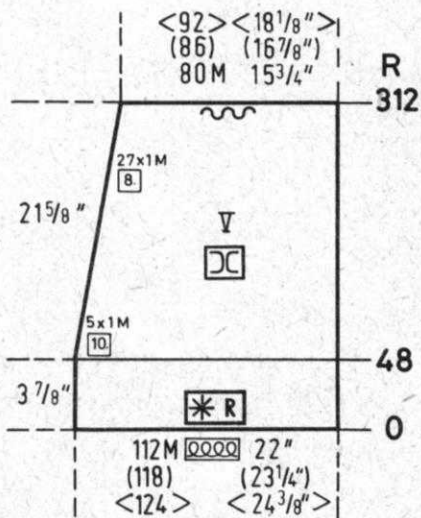
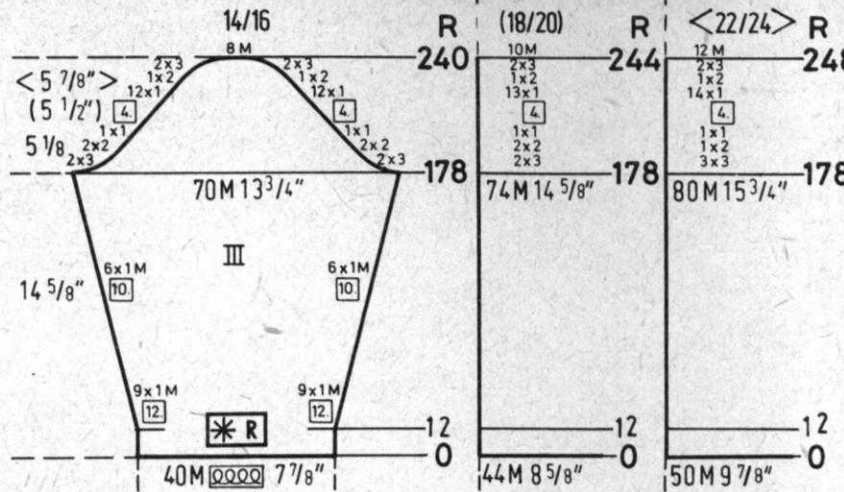

SKIRT SECTIONS IV and V

MAKE 2 and REVERSE 2
Bring 112 (118) [124] sts. into working position, then set up into Pattern and cast on.
Work in Pattern.
ALL SIZES: Knit even to Row 48.
ON OPPOSITE SIDE OF CAM BOX, decrease 1 st. every 10th row 5x, every 8th row 27x.
After Row 312, bind off the remaining 80 (86) [92] sts.



SKIRT BUTTON and BUTTONHOLE BAND VIII

ALL SIZES: Cast on 20 sts. and work Stockinette stitch. Make Buttonholes over needles 3 to 6 and 15 to 18 after Rows 26, 62, 98, 134, 170, 206, 242, 278. After Row 300, bind off.
Make the Button band the same but omit the buttonholes.

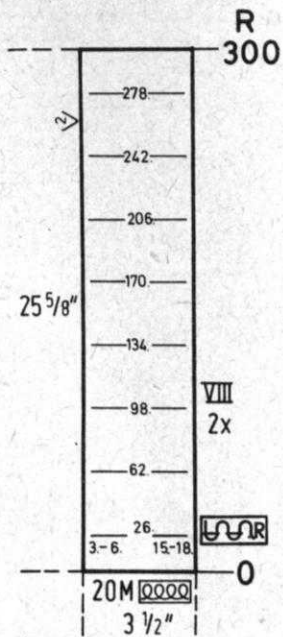

ADJUSTABLE NEEDLE SELECTOR

Suitable for KNITTING Machines only. The Adjustable Needle Selector can be set to any needle spacing and is the perfect Tool to use with many of the Patterns in this issue of KNITTING MAGAZINE.

Price: \$ 4.25 Shipping: \$.60
California residents add Sales Tax.

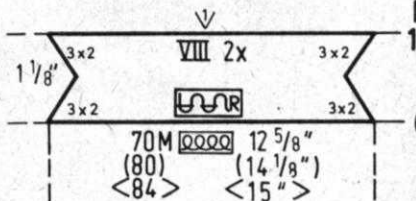
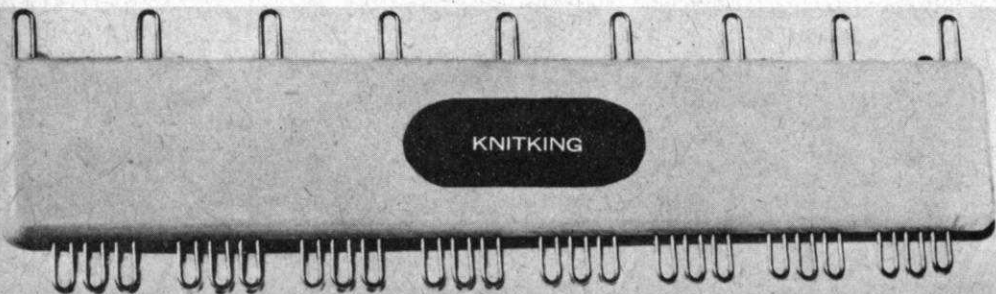

BAND 1 VIII

Cast on 70 (80) [84] sts. and work Stockinette stitch ON EACH SIDE, decrease 2 sts. 3x, then increase 2 sts. 3x.
Bind off all sts. after Row 14. Make another band the same.

DK 3

Press and Stole

SIZE: 10/12 (14/16) [18/20]
 YARN: Capriccio grams 600 650 700
 Stock: 4 to 6
 Pattern: 8 to 10
 Stock: 14 sts., 21 rows = 2"
 Pattern: 10 sts., 23 rows = 2"

Skirt section and Stole in a Holding Position Design using Wheel 2 and worn on the Purl side. Follow the Line Drawing. Bodice in Stockinette stitch worn on the Purl side; bands in Stockinette stitch worn on the knit side.

FINISHING:
 See General Instructions. Attach Fringe to Stole (See General Instructions and picture). To sew neckband in place for the deep V, see picture.

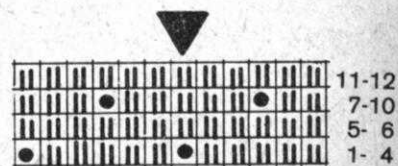

PRESS AND STOLE BACK II

Start on 128 (140) [156] sts. and work stockinette stitch.
SIZE: After Row 6 ON EACH SIDE, increase 1 st. every 6th row 14x, then knit on to Row 102 ON EACH SIDE, increase 1 st. every 8th row 9x then knit to Row 190.
SHAPE ARMHOLE: ON EACH SIDE bind off 1 st. 1x, 2 sts. 2x, 1 st. 4x
 2 sts. 2x, 2 sts. 2x, 1 st. 4x
 2 sts. 2x, 2 sts. 4x, 1 st. 4x
 knit to Row 254 (262) [266]
SHAPE NECK and SHOULDER AT THE SAME TIME. Bind off the center 12 sts. put the needles on the left side into holding position and complete the right half first.
FOR SHOULDER bind off
 6 sts. 6x, 4 sts. 1x
 3 sts. 4 sts. 4x
 6 sts. 5 sts. 1x
FOR NECK bind off
 4 sts. 4x
 same as above
 same as above
 Move the Cam Box to the left side, bring the needles into working position, turn the Row Counter back to 254 (262) [266] and complete the left half.
 Follow the instructions from *.

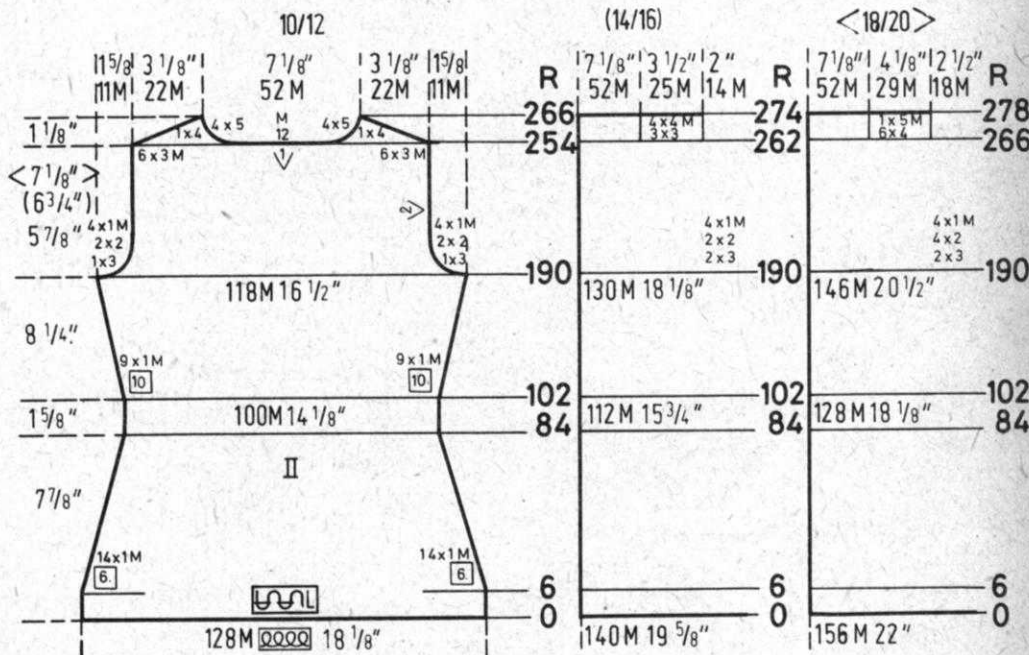

FRONT: I

Work the front section the same as the back Row 178 (174) [170] then work BUST PARTS.
ON OPPOSITE SIDE OF CAM BOX, put into holding position
 4 sts. 4x ON EACH SIDE
 6 sts. 6x ON EACH SIDE
 8 sts. 8x ON EACH SIDE
 Bring all the needles back into working position before knitting the next 2 rows.
 After Row 198 (202) [206] with a separate ball of yarn work over the center 34 sts. to Row 210 (214) [218] then bind off these sts. Leave the left side stitches in holding position while you complete the right half.
 Put the Row Counter back to 198 (202) [206] and SHAPE ARMHOLE AND NECK AT THE SAME TIME.
FOR SHOULDER bind off
 6 sts. 6x, 4 sts. 1x
 3 sts. 4 sts. 4x
 6 sts. 5 sts. 1x
FOR NECK
 4 sts. 4x
 1 st. every 6th row 4x, every 8th row 5x
 same as above
 same as above
SHAPE SHOULDER after Row 262 (274) [282]
 bind off
 6 sts. 6x, 4 sts. 1x
 3 sts. 4 sts. 4x
 6 sts. 5 sts. 1x
 Move the Cam Box to the left side, turn the Row Counter back to 198 (202) [206] and complete the left half. Follow the instructions from *.

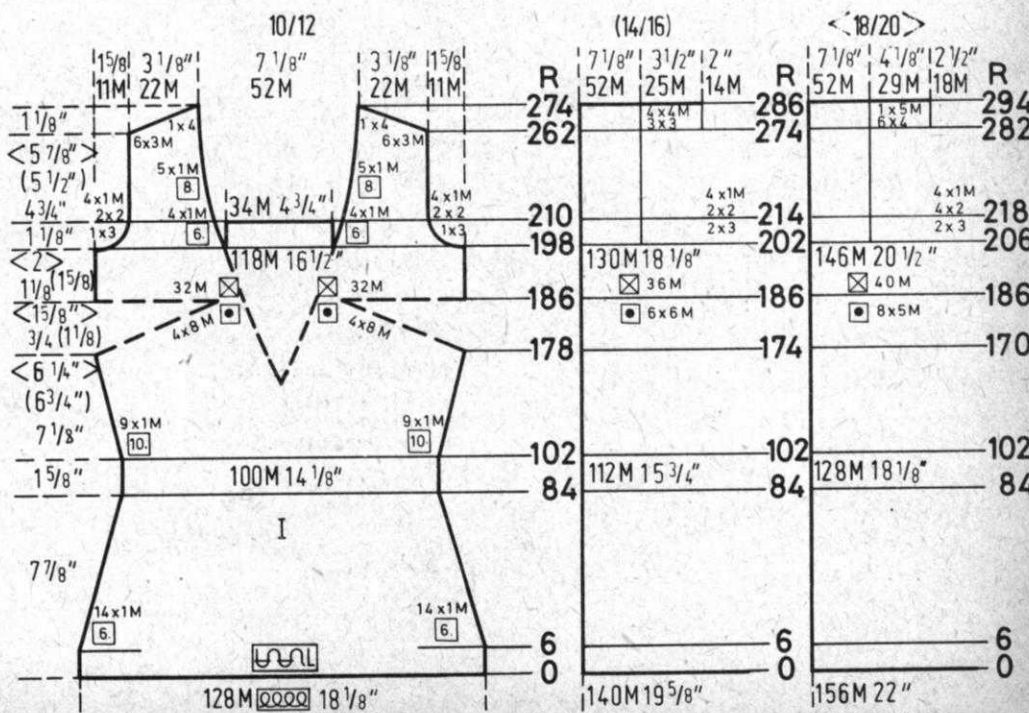

DK 3

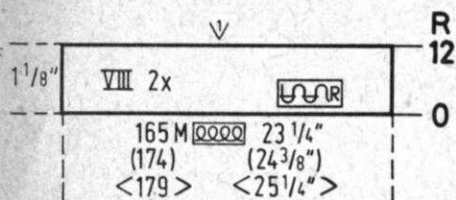

BAND 1: VIII Make 2

Cast on 165 (174) [179] sts. and work 12 rows Stockinette stitch then bind off

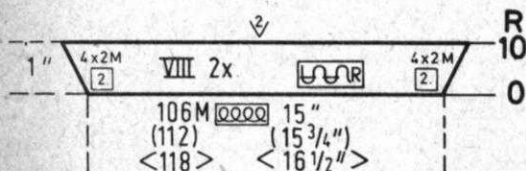

BAND 2: VIII Make 2

Cast on 106 (112) [118] sts. and work Stockinette stitch. On every other row increase 2 sts. 4x. After Row 10, bind off all sts.

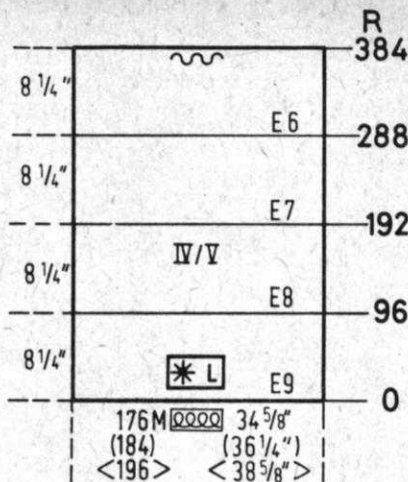

Skirt section IV/V Make 2.

Cast on 176 (184) [196] sts. Work in Pattern. With Tension 9, knit to Row 96 With Tension 8, knit to Row 192 With Tension 7, knit to Row 288 With Tension 6, knit to Row 384 Bind off all sts.

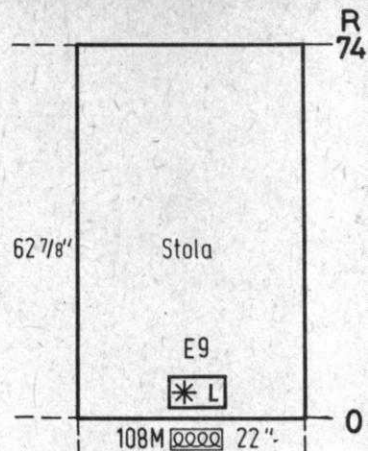

STOLE: All Sizes

Cast on 108 sts. and knit in Pattern to Row 740, then bind off all sts.

DK 4

Long Dress and Shawl

SIZE: 7/8 (10/12) [14/16]

YARN: Capriccio C1 grams 600 650 700

C2 grams 25 25 25

E 7 to 9

P 14 sts., 21 rows = 2"

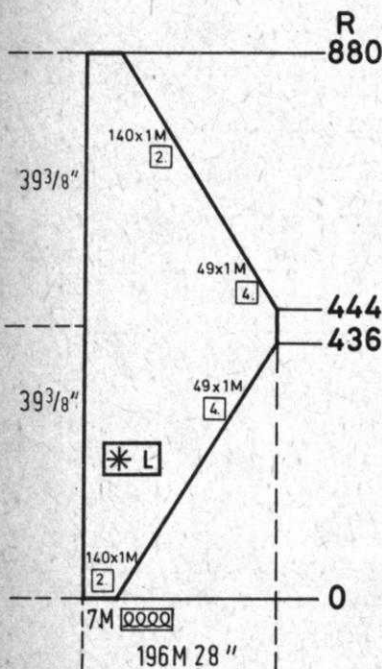

TRIANGLE SHAWL: All Sizes

Cast on 7 sts. and work in Pattern. ON CAM BOX SIDE, increase 1 st. every 2nd row 140x, every 4th row 49x After Row 444, decrease 1 st. every 4th row 49x, every 2nd row 140x. After Row 880, bind off.

Bodice, Sleeves and Shawl in a Holding Position Design using Wheel W2. Follow the Line Drawing. Worn on the Purl side. Skirt and Band in Stockinette stitch worn on the Knit side.

FINISHING:

See General Instructions. Work 1 row single crochet around back neck opening, then make loop on one side and sew button to other side at neckline. SHAWL: Single crochet around edges then attach fringe (see General Instructions).

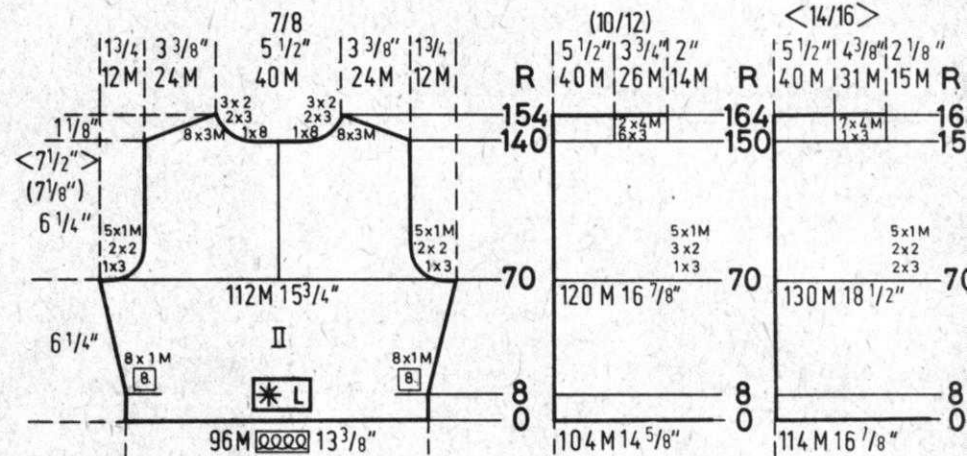

DRESS and TRIANGLE SHAWL BACK: II

Cast on 96 (104) [114] sts. and work in Pattern. BOTH SIZES: ON EACH SIDE after Row 8, increase 1 st. every 8th row 8x. After Row 70, divide in center for Back Opening, put the needles on the left into holding position and complete the right half.

*SHAPE ARMHOLE: Bind off

3 sts. 1x, 2 sts. 2x, 1 st. 5x

(3 sts. 1x, 2 sts. 2x, 1 st. 5x)

[3 sts. 2x, 2 sts. 2x, 1 st. 5x]

Knit to Row 140 (150) [154] SHAPE SHOULDER AND NECK.

Bind off

For Shoulder

3 sts. 8x

(3 sts. 6x, 4 sts. 2x)

[3 sts. 1x, 4 sts. 7x]

For Neck

8 sts. 1x, 3 sts. 2x, 2 sts. 3x

Same as above

Same as above

Bring the needles on the left into working position, knit 1 row in Pattern to the left side, turn the Row Counter back to 70 and complete the left half. Follow the instructions from *.

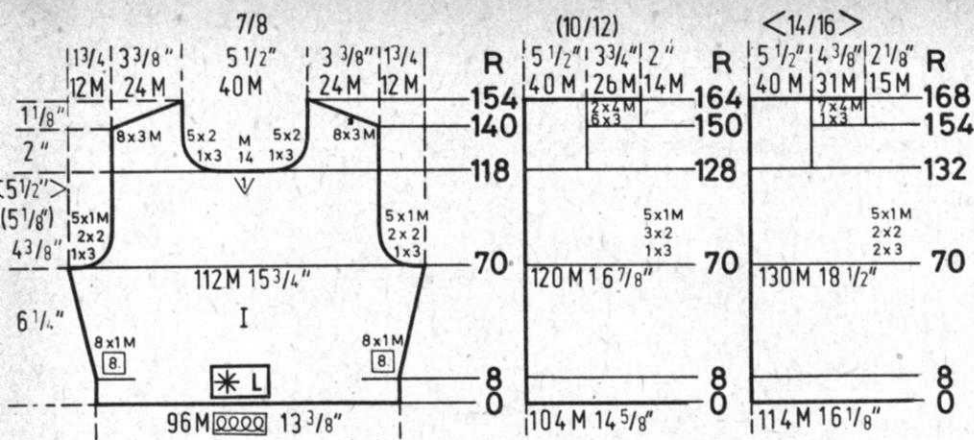

FRONT: I
 Work the front the same as the back to Row 140. SHAPE ARMHOLE:
 ON EACH SIDE bind off
 3 sts. 1x, 2 sts. 2x, 1 st. 5x
 3 sts. 1x, 2 sts. 3x, 1 st. 5x
 3 sts. 2x, 2 sts. 2x, 1 st. 5x
 knit to Row 118 (128) [132] bind off the
 center 14 sts. put the needles on the left into
 holding position and complete the right half.
 ON NECK SIDE, bind off

3 sts. 1x, 2 sts. 5x and SHAPE SHOULDER
 after Row 140 (150) [154]
 Bind off
 3 sts. 8x
 (3 sts. 6x, 4 sts. 2x)
 [3 sts. 1x, 4 sts. 7x]
 Bring the needles on the left into working
 position, knit 1 row in pattern to the left,
 turn the Row Counter back to 118 (128) [132]
 and complete the left half.
 Follow the instructions from *.

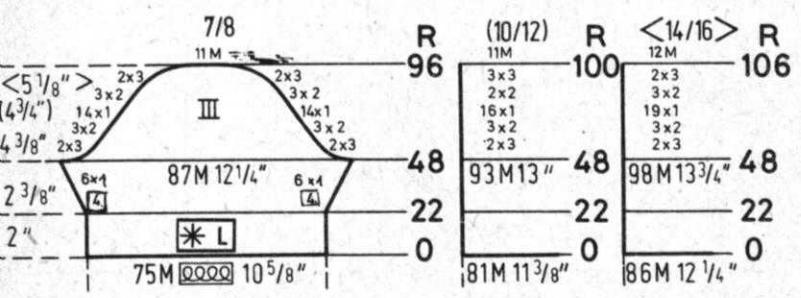
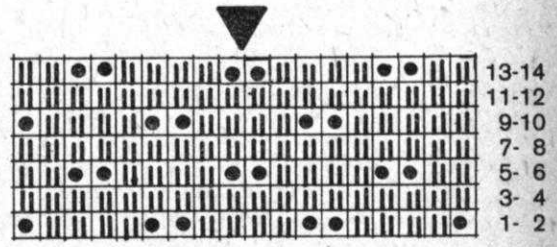

SLEEVE: III
 Cast on 75 (81) [86] sts. Work in Pattern.
 All Sizes: ON EACH SIDE after Row 22 incre-
 ase 1 st. every 4th row 6x.
 SHAPE CAP after Row 48.
 ON EACH SIDE bind off
 3 sts. 2x, 2 sts. 3x, 1 st. 14x, 2 sts. 3x,
 3 sts. 2x
 (3 sts. 2x, 2 sts. 3x, 1 st. 16x, 2 sts. 2x,
 3 sts. 3x)
 [3 sts. 2x, 2 sts. 3x, 1 st. 19x, 2 sts. 3x,
 3 sts. 2x]
 Bind off 11 (11) [12] sts.

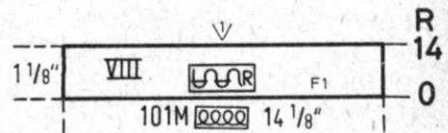
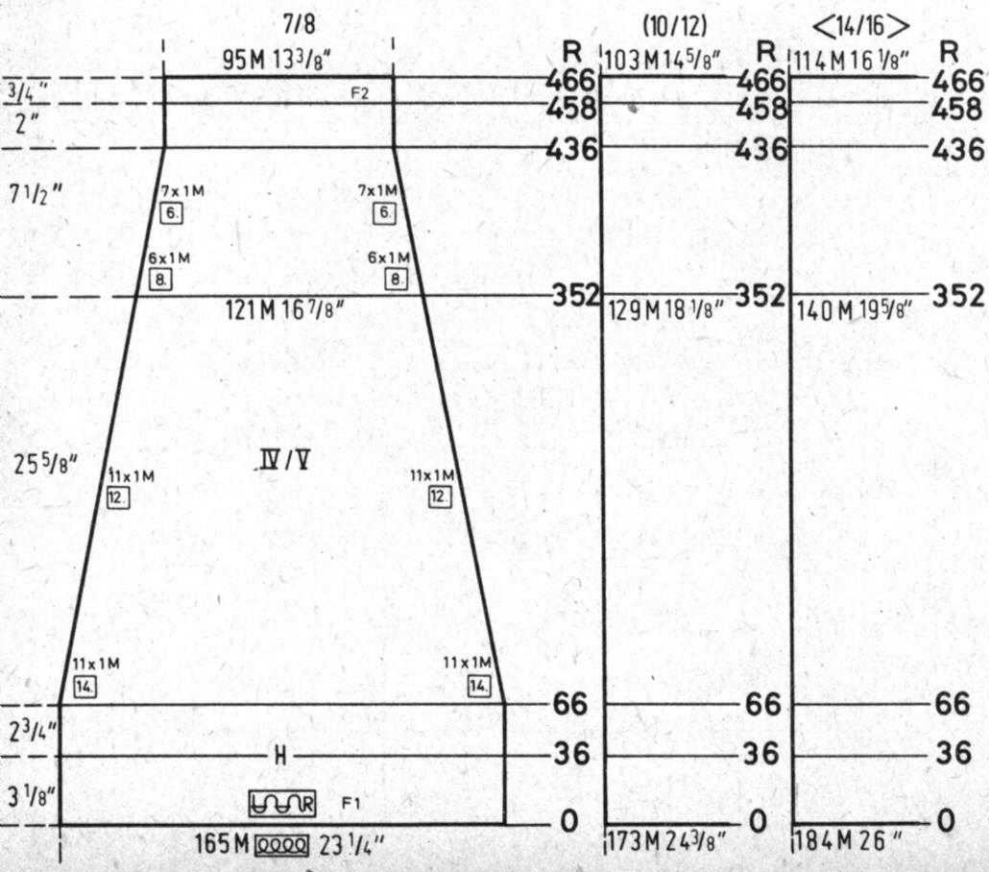

BAND: VIII
 All Sizes: Cast on 101 sts: with color 1 and
 work 14 rows Stockinette stitch then bind
 off all sts.

SKIRT: IV/V Make 2
 Cast on 165 (173) [184] sts. with color 1 and
 work in Stockinette stitch.
 ALL SIZES: After Row 66 ON EACH SIDE,
 decrease 1 st. every 14th row 11x, every
 12th row 11x
 After Row 352 ON EACH SIDE decrease 1 st.
 every 8th row 6x, every 6th row 7x then knit
 to Row 458, change to color 2 and knit to
 Row 466 then bind off.

DK 5

Long Dress and Triangle Shawl

SIZE: 10/12 (14/16) [18/20]

YARN: Illustra grams 740 800 840

E 6 to 8

P 14 sts., 22 rows = 2"

DRESS and TRIANGLE SHAWL

BACK: II

Bring 184 (190) [196] needles into working position then set up into Pattern and cast on. After Row 66 ON EACH SIDE, decrease 1 st. every 12th row 3x, every 10th row 25x (every 12th row 28x, every 10th row 7x) [every 16th row 3x, every 14th row 17x]

All Sizes:

After Row 352 ON EACH SIDE, decrease 1 st. every 8th row 3x, every 6th row 11x Knit to Row 454

All Sizes: ON EACH SIDE, increase 1 st. every 8th row 9x

Knit to Row 538, divide in the center and put the needles on the left side into holding position and knit the right side first.

SHAPE ARMHOLE:

*ON CAM BOX SIDE, bind off

3 sts. 1x, 2 sts. 2x, 1 st. 4x

(3 sts. 1x, 2 sts. 3x, 1 st. 5x)

[3 sts. 2x, 2 sts. 3x, 1 st. 6x]

Knit to Row 614 (622) [626] SHAPE SHOULDER AND NECK

Bind off

ON SHOULDER SIDE

2 sts. 1x, 3 sts. 7x

(3 sts. 6x, 4 sts. 2x)

[3 sts. 2x, 4 sts. 6x]

ON NECK SIDE

8 sts. 1x, 4 sts. 2x, 3 sts. 3x

Same as above

Same as above

Bring the needles on the left into working position, knit 1 row in pattern to the left, turn the Row Counter back to 538 and complete the left half. Follow the instructions from *.

FRONT: I

Work the front section the same as the back to Row 524 (520) [516] then work Bust Dart using Short Rows ON OPPOSITE SIDE OF CAM BOX put into holding position

8 sts. 4x ON EACH SIDE

(5 sts. 7x ON EACH SIDE)

[4 sts. 9x ON EACH SIDE]

ON OPPOSITE SIDE OF CAM BOX bring all the needles back into working position before knitting the next 2 rows.

Knit to Row 546 (552) [556] then SHAPE

ARMHOLES ON EACH SIDE, bind off

3 sts. 1x, 2 sts. 2x, 1 st. 4x

(3 sts. 1x, 2 sts. 3x, 1 st. 5x)

[3 sts. 2x, 2 sts. 3x, 1 st. 6x]

Knit to Row 598 (614) [622] then SHAPE

NECK

Bind off the center 14 sts., put the needles on the left side into holding position and complete the right half.

*ON NECK SIDE, bind off 3 sts. 2x, 2 sts. 6x and SHAPE SHOULDER after Row 620 (636) [644] bind off

2 sts. 1x, 3 sts. 7x

(3 sts. 6x, 4 sts. 2x)

[3 sts. 2x, 4 sts. 6x]

Bring the needles on the left into working position, knit 1 row in Pattern to the left side, turn the Row Counter back to 598 (614) [622] and complete the left half. Follow the instructions from *.

Pattern I for Dress is a Mock Rib with empty needles that ARE COUNTED in the stitch gauge and instructions. Use Pattern stitch given for DK 4 to knit the Shawl. Follow the Line Drawings. Worn on the Knit side.

FINISHING:

DRESS: See General Instructions

SHAWL: Same as DK 4

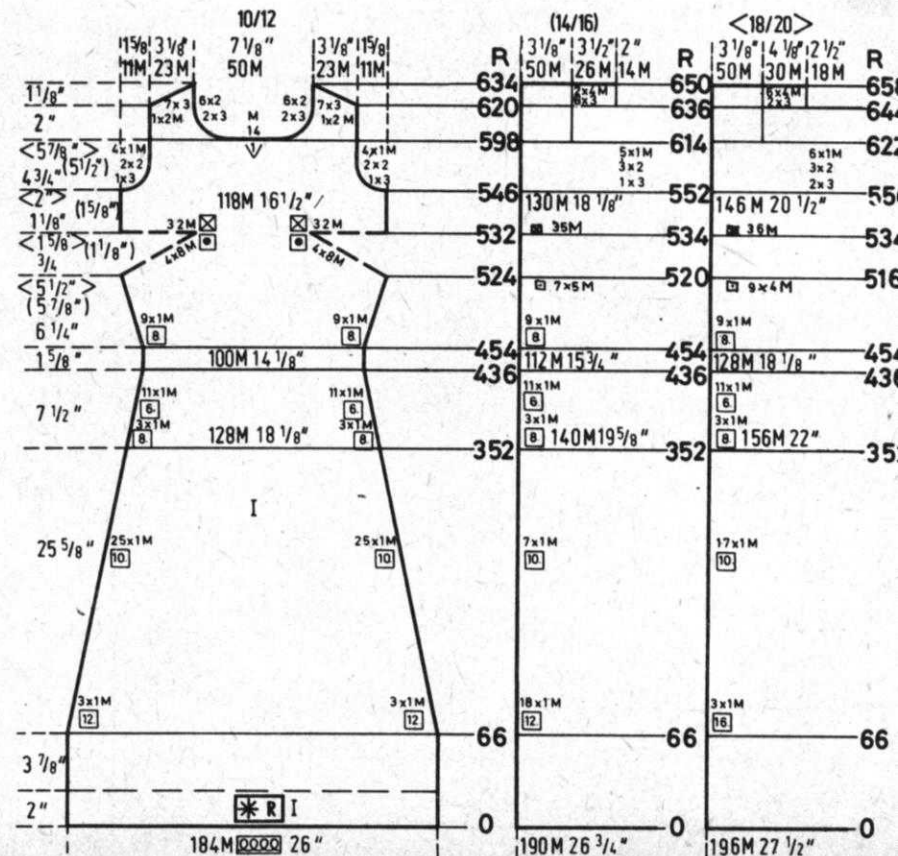
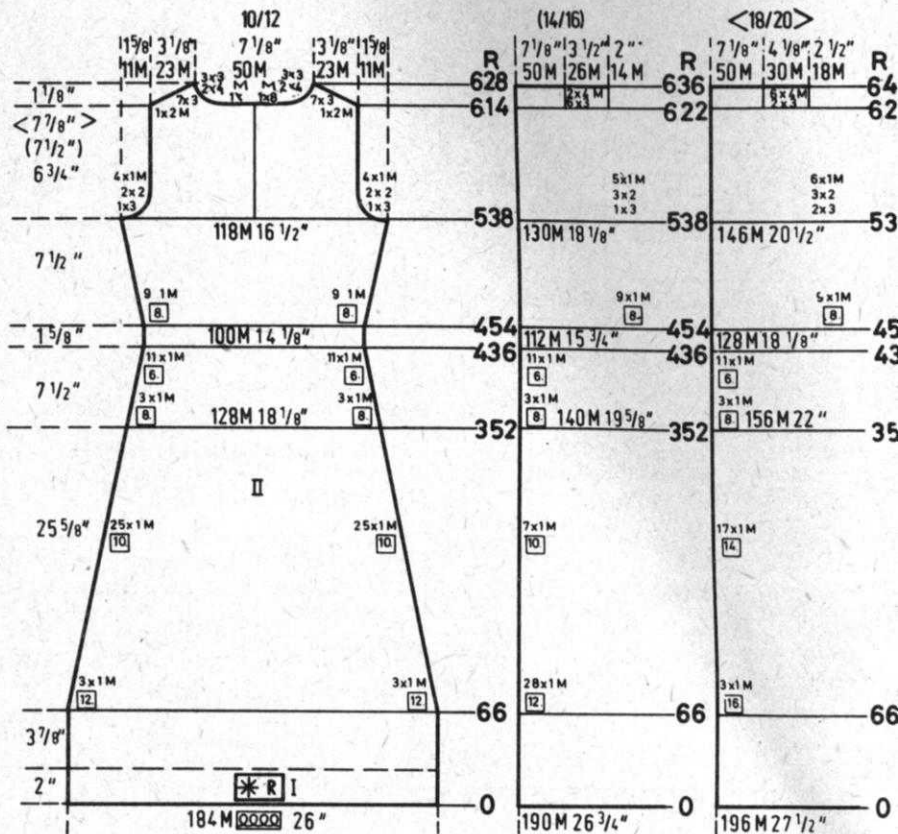

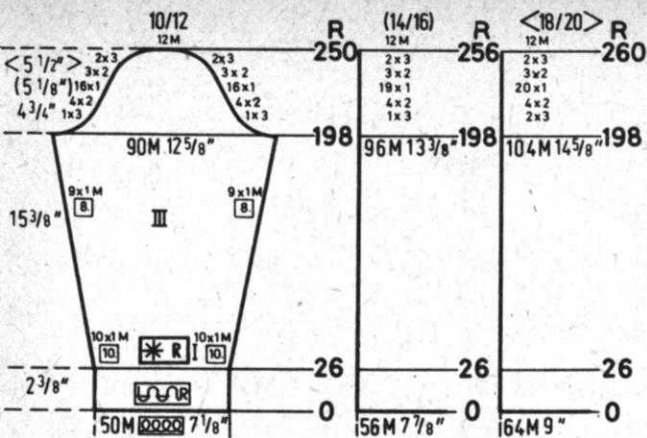

SLEEVE: III

Cast on 50 (56) [64] sts. and knit Stockinette stitch to Row 26

All Sizes: Change to Pattern and increase 1 st. ON EACH SIDE every 10th row 10x, every 8th row 9x. SHAPE CAP after Row 198. ON EACH SIDE bind off

3 sts. 1x, 2 sts. 4x, 1 st. 16x, 2 sts. 3x, 3 sts. 2x

3 sts. 1x, 2 sts. 4x, 1 st. 19x, 2 sts. 3x, 3 sts. 2x

3 sts. 2x, 2 sts. 4x, 1 st. 20x, 2 sts. 3x, 3 sts. 2x

Bind off the remaining 12 sts.

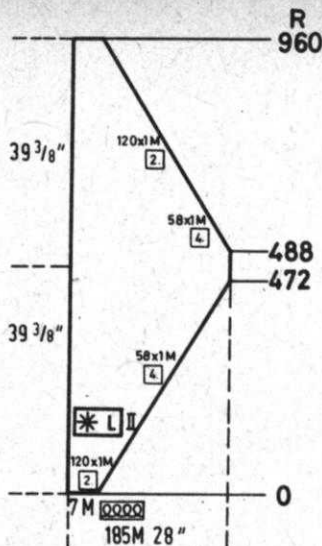

TRIANGLE SHAWL: II

ALL SIZES: Bring 7 needles into working position, set up in Pattern then cast on. ON CAM BOX SIDE, increase 1 st. every 2nd row 120x, every 4th row 58x. After Row 488, decrease 1 st. every 4th row 58x, every 2nd row 120x. After Row 960, bind off.

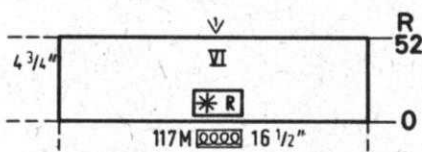

BAND: VI

ALL SIZES: Bring 117 needles into working position, set up in Pattern then cast on. Knit 52 rows then bind off.

DK 6

Evening Dress and Coat

SIZE: 10/12 (14/16) [18/20]

YARN: Capriccio grams 950 1000 1050

8 to 10

Stock: 11 sts., 33 rows = 2"

Pattern: 10 sts., 24 rows = 2"

DRESS: Stockinette stitch worn on the Purl side. COAT: Holding Position Design using Special Wheel 4. Follow the Line Drawing. The empty needles ARE COUNTED in the stitch gauge and instructions. The Purl side is the right side.

FINISHING:

See General Instructions. Sew velvet ribbon streamers on front of Dress (See picture). Ease the fullness at bustline of front section on Coat. Work 2 rows single crochet around all edges of Coat.

DRESS and COAT DRESS BACK: II

Cast on 146 (150) [154] sts. and work Stockinette stitch to Row 36 then hang the hem. Knit to Row 82.

ON EACH SIDE decrease 1 st. every 14th row 18x, every 12th row 5x (every 16th row 17x, every 14th row 3x) [every 20th row 16x]

Knit to Row 380 and ON EACH SIDE decrease 1 st. every 8th row 11x. Knit to Row 486. ON EACH SIDE, increase 1 st. every 14th row 7x

Knit to Row 582 then SHAPE ARMHOLE. ON EACH SIDE bind off

3 sts. 1x, 2 sts. 2x, 1 st. 2x

(3 sts. 1x, 2 sts. 2x, 1 st. 4x)

[3 sts. 2x, 2 sts. 2x, 1 st. 4x]

Knit to Row 614 (624) [628] SHAPE NECK. Bind off the center 14 sts. put the needles on the left side into holding position and complete the right half first.

*ON NECK SIDE, bind off

3 sts. 2x, 2 sts. 2x, 1 st. 5x and SHAPE SHOULDER after Row 650 (660) [664]

bind off

2 sts. 3x, 3 sts. 3x

(3 sts. 6x)

[3 sts. 3x, 4 sts. 3x]

Move the Cam Box to the left side, bring the needles into working position, turn the Row Counter back to 614 (624) [628] and complete the left half. Follow the instructions from *

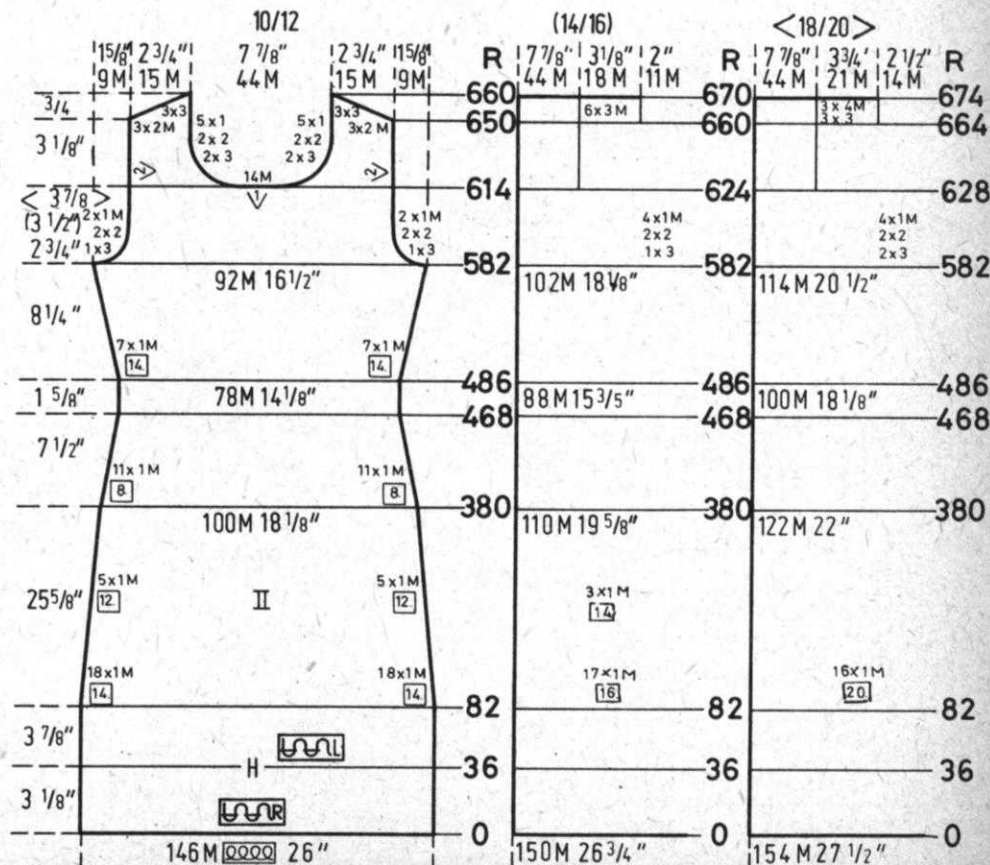

DK 6

DRESS FRONT: I

Work the front the same as the back to Row 568 (564) [560]
 Divide in the center for neck, put the needles on the left side in holding position and complete the right half first.
 *SHAPE NECK - All Sizes: ON NECK SIDE, decrease 1 st. every 4th row 16x, every 6th row 6x
 AT THE SAME TIME begin Short Rows for Bust Dart after Row 569 (565) [561]
 Put into holding position
 5 sts. 5x (5 sts. 7x) [4 sts. 9x]
 Return all needles to working position
 SHAPE ARMHOLE after Row 592 (596) [600]
 Bind off
 3 sts. 1x, 2 sts. 2x, 1 st. 2x
 (3 sts. 1x, 2 sts. 2x, 1 st. 4x)
 [3 sts. 2x, 2 sts. 2x, 1 st. 4x]
 SHAPE SHOULDER after Row 660 (674) [682]
 Bind off
 2 sts. 3x, 3 sts. 3x
 (3 sts. 6x)
 [3 sts. 3x, 4 sts. 3x]
 Move the Can Box to the left side, bring the needles into working position, turn the Row Counter back to 568 (564) [560] and complete the left half. Follow the instructions from *.

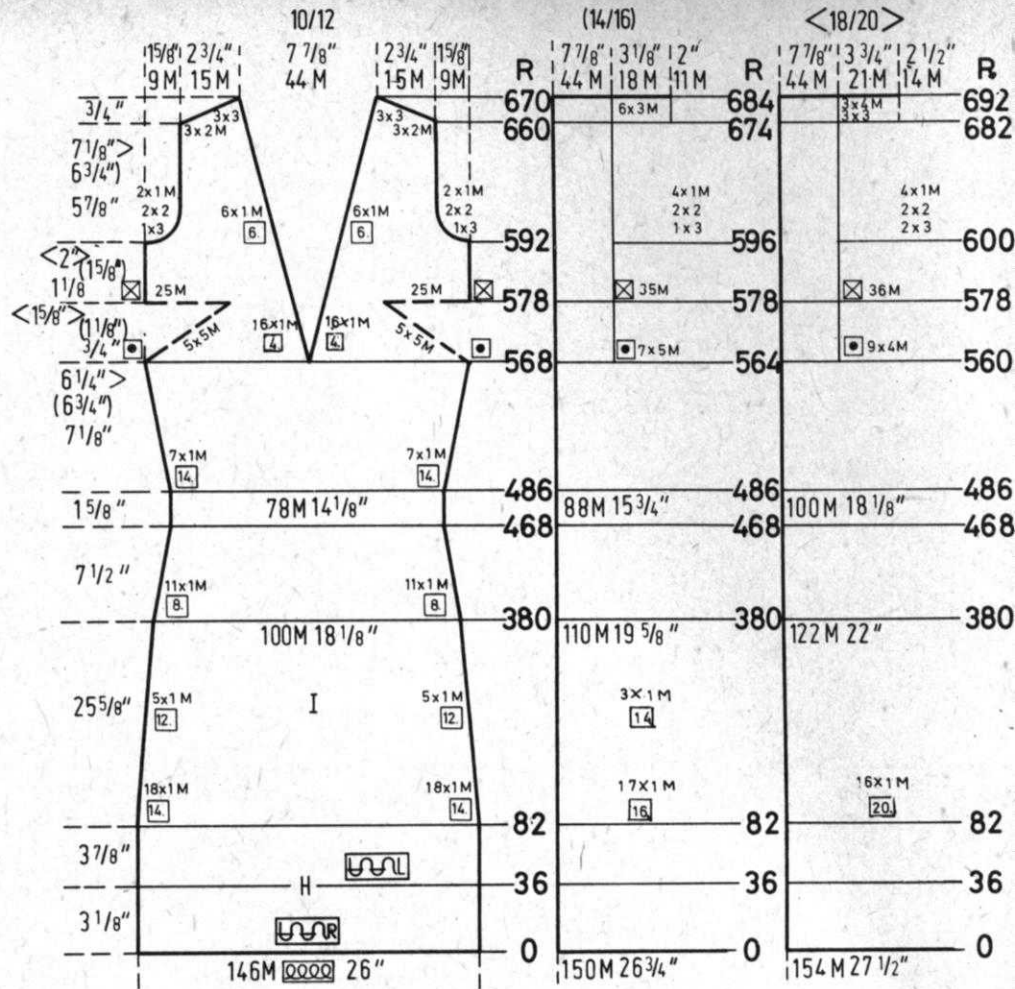

COAT BACK: II

Bring 132 (136) [140] needles into working position, set up in Pattern then cast on.
 ON EACH SIDE, after Row 48 decrease 1 st. every 16 rows 18x
 (every 20 rows 3x, every 18th row 13x)
 [every 26th row 6x, every 24th row 6x]
 ALL SIZES: ON EACH SIDE after Row 322 decrease 1 st. every 14th row 5x, every 12th row 3x then knit to Row 434
 ALL SIZES: ON EACH SIDE after Row 434, increase 1 st. every 20th row 4x.
 Knit to Row 516 SHAPE ARMHOLE:
 ON EACH SIDE, bind off
 3 sts. 1x, 2 sts. 2x, 1 st. 2x
 (3 sts. 1x, 2 sts. 2x, 1 st. 4x)
 (3 sts. 2x, 2 sts. 2x, 1 st. 4x)
 Knit to Row 602 (612) [616] Bind off the center 10 sts. put the needles on the left side into holding position and complete the right half first.
 *SHAPE NECK AND SHOULDER AT THE SAME TIME
 Bind off
 SHOULDER
 2 sts. 6x, 3 sts. 2x
 (2 sts. 4x, 3 sts. 4x)
 [2 sts. 1x, 3 sts. 7x]
 NECK
 2 sts. 6x
 Same as above
 Same as above
 Bring the needles on the left into working position, knit 1 row in Pattern to the left, turn the Row Counter back to 602 (612) [616] and complete the left half. Follow the instructions from *.

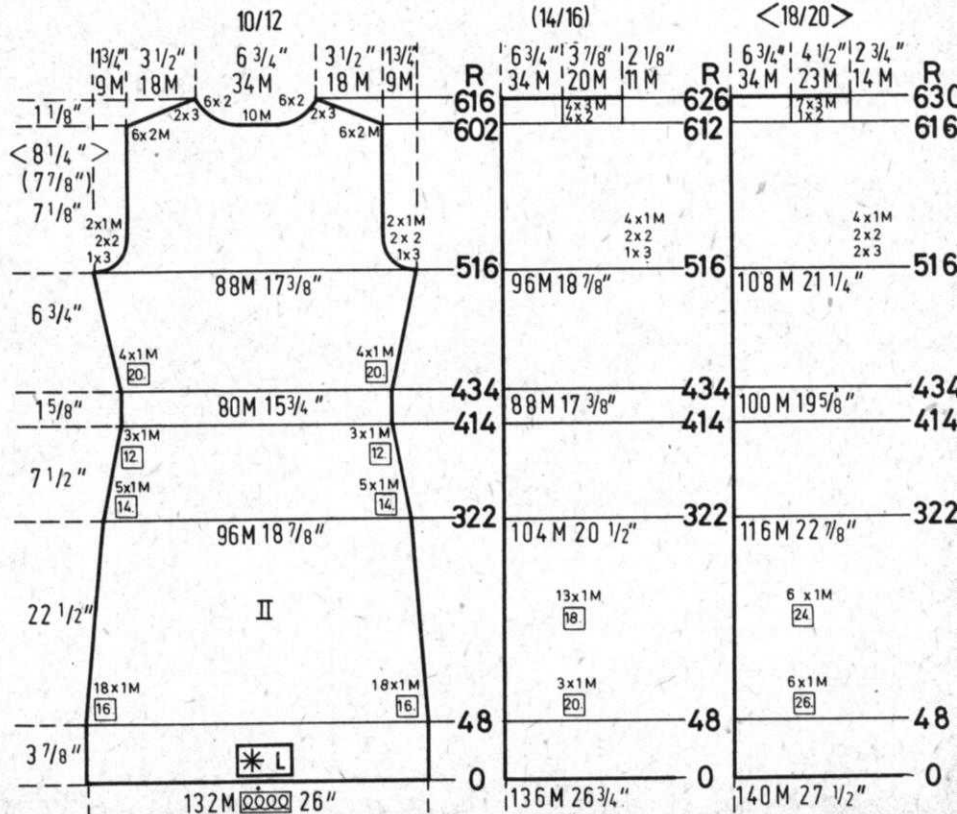

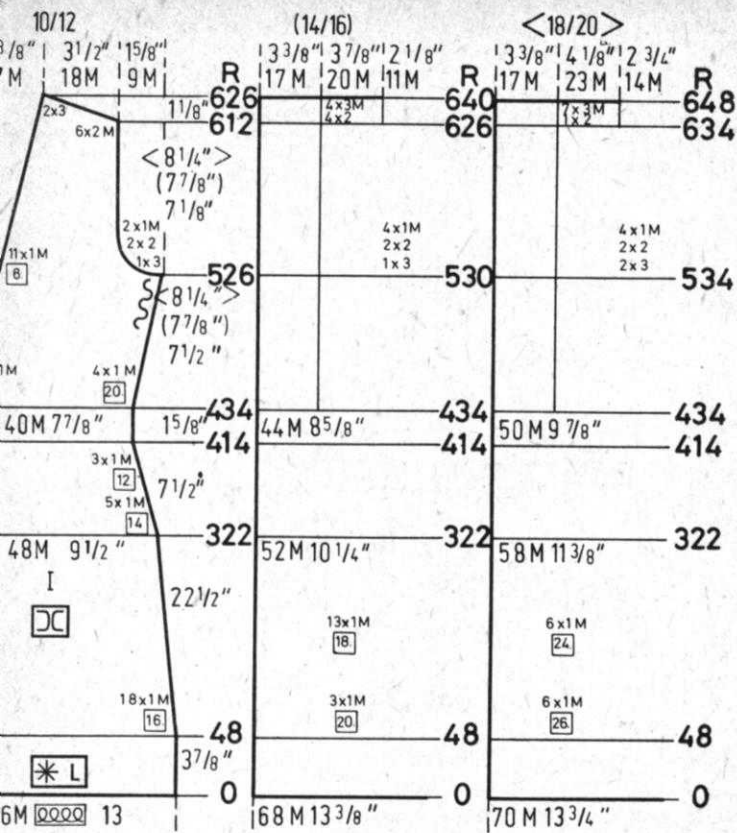

COAT FRONT: I (Make 1, reverse 1)

Bring 66 (68) [70] needles into working position, set up in Pattern then cast on. ON CAM BOX SIDE, decrease 1 st. every 16th row 18x (every 20th row 3x, every 18th row 13x) [every 26th row 6x, every 24th row 6x]. ALL SIZES: After Row 322, decrease 1 st. every 14th row 5x, every 12th row 3x. Knit to Row 434. ALL SIZES: ON CAM BOX SIDE increase 1 st. every 20th row 4x and SHAPE NECK AT THE SAME TIME ON NECK SIDE, decrease 1 st. every 4th row 6x, every 6th row 11x and AT THE SAME TIME SHAPE ARMHOLE after Row 526 (530) [534]. Bind off 3 sts. 1x, 2 sts. 2x, 1 st. 2x (3 sts. 1x, 2 sts. 2x, 1 st. 4x) [3 sts. 2x, 2 sts. 2x, 1 st. 4x]. SHAPE SHOULDER after Row 612 (626) [634]. Bind off 2 sts. 6x, 3 sts. 2x (2 sts. 4x, 3 sts. 4x) [2 sts. 1x, 3 sts. 7x].

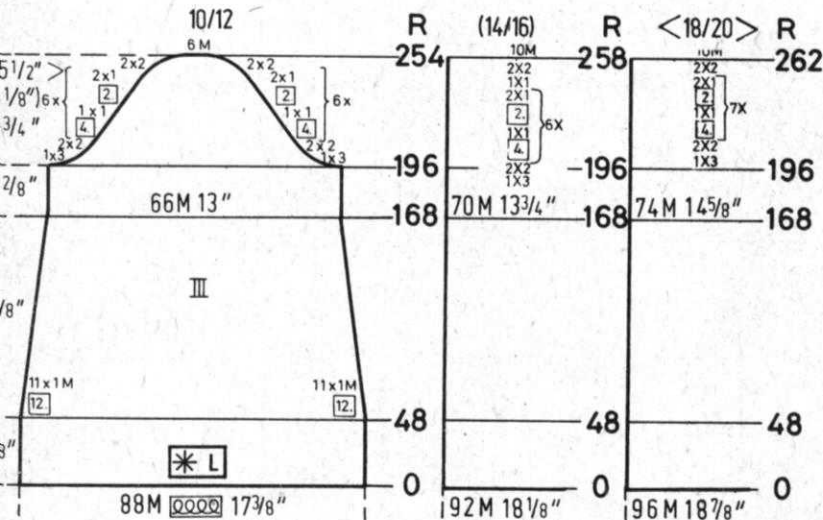

COAT SLEEVE: III

Bring 88 (92) [96] needles into working position, set up in Pattern then cast on. ALL SIZES: Knit to Row 48 then decrease 1 st. ON EACH SIDE every 12th row 11x. Knit to Row 168. SHAPE CAP: ON EACH SIDE bind off 3 sts. 1x, 2 sts. 2x then *every 4th row 1 st. 1x, every 2nd row 1 st. 2x* and REPEAT FROM * to * 5x more, then bind off 2 sts. 2x. Bind off the remaining 6 sts. (3 sts. 1x, 2 sts. 2x *every 4th row 1 st. 1x, every 2nd row 1 st. 2x* and REPEAT FROM * to * 5x more, then bind off 1 st. 1x, 2 sts. 2x. Bind off the remaining 10 sts.) [3 sts. 1x, 2 sts. 2x *every 4th row 1 st. 1x, every 2nd row 1 st. 2x* and REPEAT FROM * to * 6x more, then bind off 2 sts. 2x. Bind off the remaining 10 sts.]

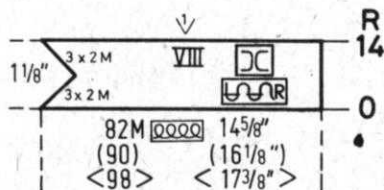

DRESS NECKBAND VIII (Make 1, reverse 1)

Cast on 82 (90) [98] sts. and work Stockinette stitch. ALL SIZES: ON THE LEFT (right for second section) decrease 2 sts. 3x, then increase 2 sts. 3x. After Row 14, bind off.

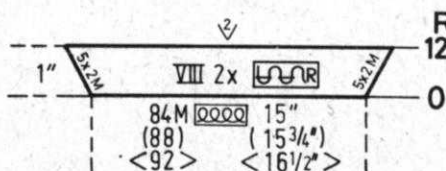

DRESS ARMHOLE BAND VIII (Make 2)

Cast on 84 (88) [92] sts. and work Stockinette stitch. ALL SIZES: ON EACH SIDE, increase 2 sts. 5x. After Row 12, bind off.

DK 7

LONG DRESS AND CAPE

SIZE: 7/8 (10/12) [14/16]

YARN: Beatrice grams 2400 2450 2500

E 8 to 10

P Pattern: 10 sts., 18 rows = 2"

Stock: 15 sts., 22 rows = 2"

Cape, bodice of Dress and Sleeves are a Holding Position Design with out of work needles that ARE COUNTED in the stitch gauge and instructions. Follow the Line Drawing and use the Adjustable Needle Selector. Skirt section and bands: Stockinette stitch. The Cape, sleeve and bodice of dress worn on the Purl side; the skirt section on the knit side.

FINISHING:

See General Instructions. Attach Fringe to lower edge of Cape (see General Instructions and picture). Work crochet edge around neckline and sleeves of Dress as

follows:

ROW 1: Single crochet
ROW 2: Double crochet in 1st st. ch 1; skip 2, dc in next st., *ch 1, skip 2, dc in next st., REPEAT from *
ROW 3: *Yarn over hook, go into 1st dc pull up a loop, yarn over hook, into same space, pull up loop, yarn over, pull through all sts. c hook.

REPEAT from * going into same stitch 3 times more. Skip 1 dc and REPEAT from * around.

LONG DRESS and CAPE

CAPE BACK: II (Make 1, reverse 1)

Bring 40 needles into working position then set up in Pattern and cast on ON THE RIGHT (left for second section) increase

6 sts, 5x, 4 sts. 6x, 3 sts. 4x

(6 sts. 7x, 4 sts. 4x, 3 sts. 4x)

[6 sts. 7x, 4 sts. 8x]

After Row 54 decrease 1 st. every 6th row

39x, every 4th row 19x. Knit to Row 342,

bind off 1 st. 6x, 2 sts. 2x, 3 sts. 2x

After Row 382 SHAPE SHOULDER AND

NECK AT THE SAME TIME

SHOULDER

2 sts. 2x, 3 sts. 4x

(3 sts. 4x, 4 sts. 2x)

[4 sts. 6x]

NECK

8 sts. 1x, 2 sts. 4x

Same as above

Same as above

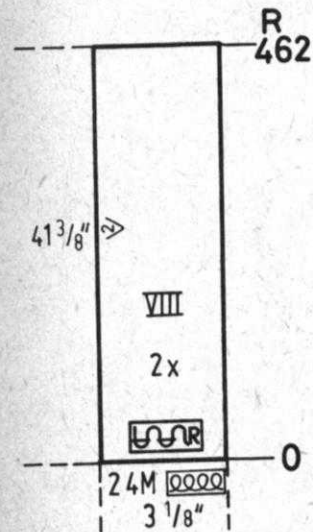
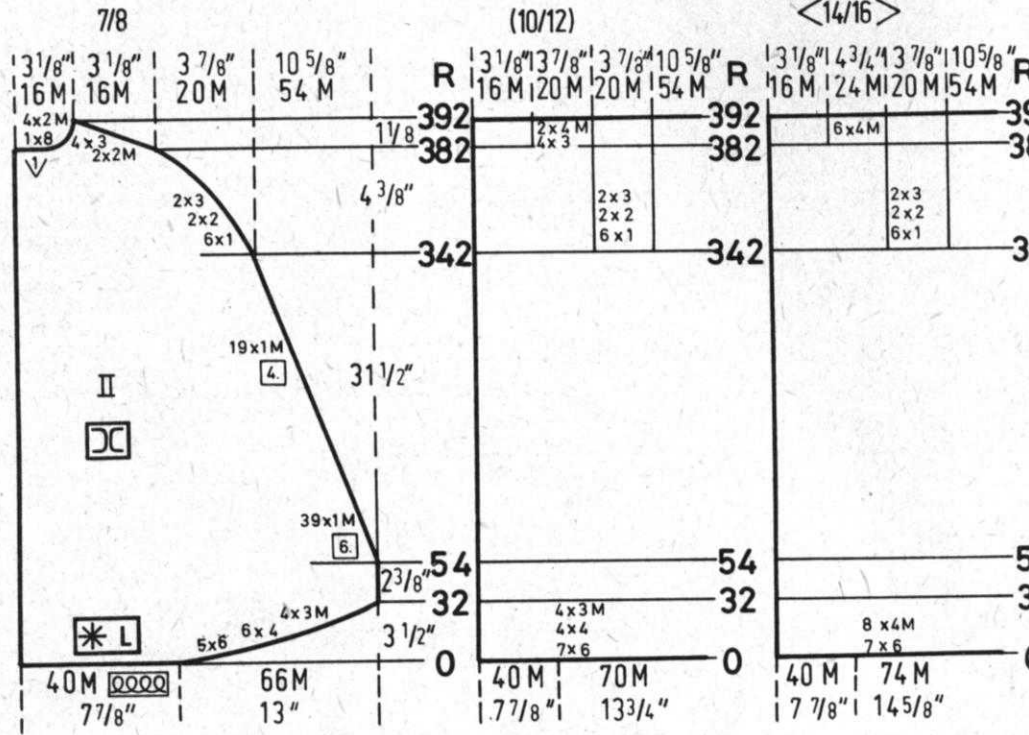

CAPE FRONT BAND: VIII (Make 2)

Cast on 24 sts. and work 462 rows Stockinette stitch then bind off.

CAPE FRONT: I (Make 1, reverse 1)

Work the front section the same as the back to Row 365. For NECK bind off

3 sts. 2x, 2 sts. 1x, 1 st. 4x AND SHAPE

SHOULDER after Row 382. Bind off

(2 sts. 2x, 3 sts. 4x

(3 sts. 4x, 4 sts. 2x)

[4 sts. 6x]

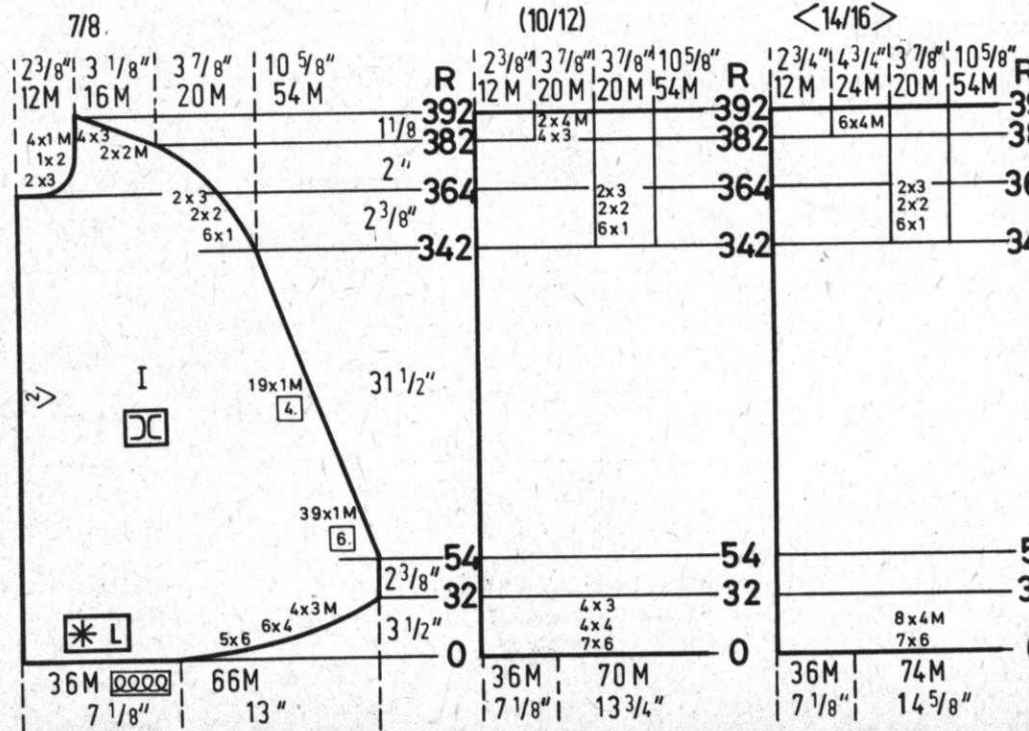

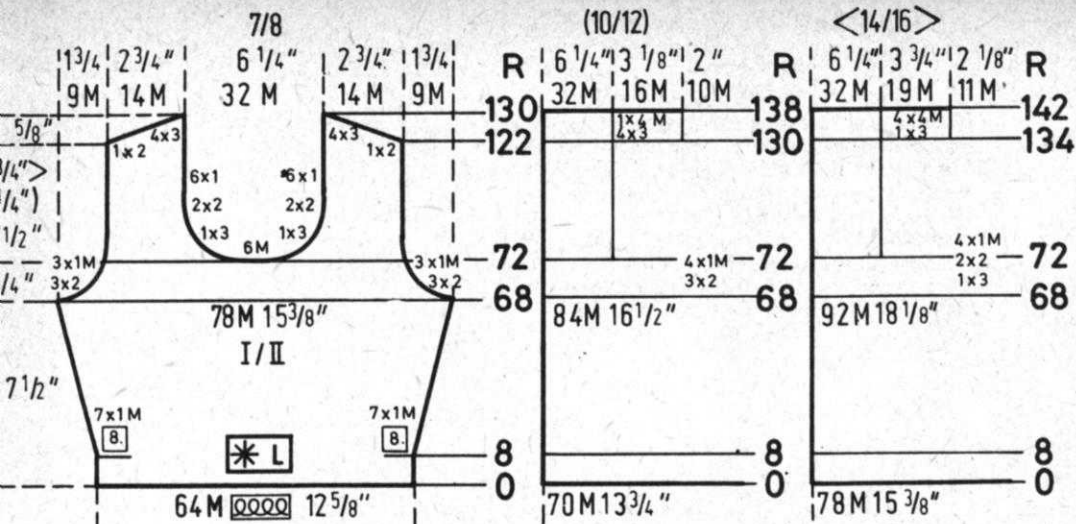

Bodice FRONT and BACK I/II

Bring 64 (70) [78] needles into working position then set up into Pattern. Cast on. ALL SIZES: ON EACH SIDE after Row 8, increase 1 st. every 8th row 7x. SHAPE ARMHOLE after Row 68 and NECK after Row 72. For Armhole, bind off 2 sts. 3x, 1 st. 3x (2 sts. 3x, 1 st. 4x) [3 sts. 1x, 2 sts. 2x, 1 st. 4x] FOR NECK, bind off the center 6 sts. Put the needles on the left into holding position and complete the right half first. *ON NECK SIDE, bind off 3 sts. 1x, 2 sts. 2x, 1 st. 6x and SHAPE SHOULDER after Row 122 (130) [134] bind off 2 sts. 1x, 3 sts. 4x (3 sts. 4x, 4 sts. 1x) [3 sts. 1x, 4 sts. 4x] Bring the needles on the left into working position, knit 1 row in Pattern to the left, turn the Row Counter back to 72 and complete the left half. Follow the instructions from *.

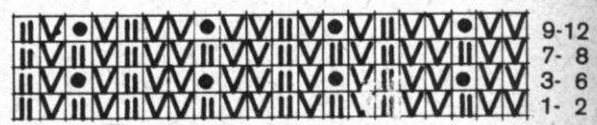
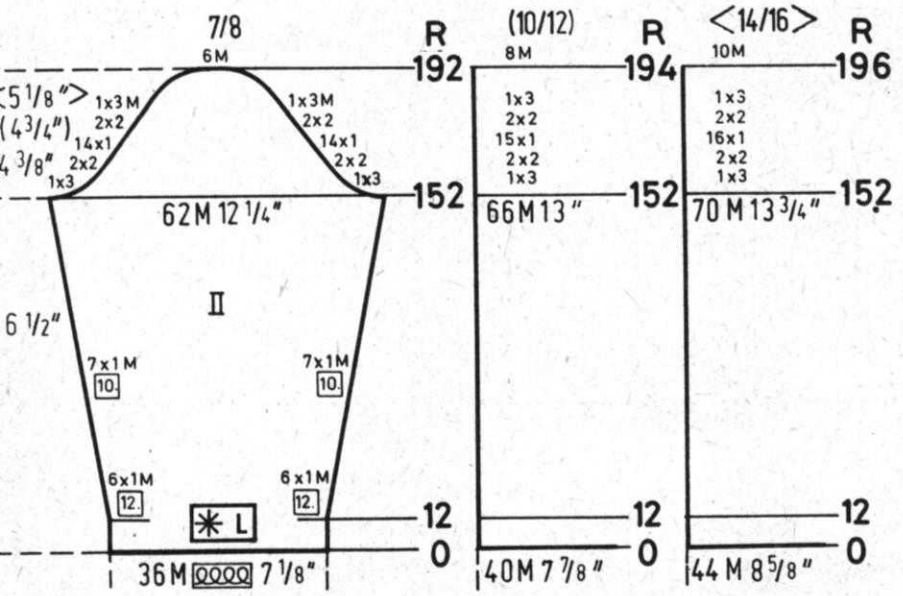

DRESS SLEEVE: II

Bring 36 (40) [44] needles into working position and set up into pattern then cast on. ALL SIZES: ON EACH SIDE after Row 12 increase 1 st. every 12th row 6x, every 10th row 7x. Knit to Row 152. SHAPE ARMHOLE: Bind off 3 sts. 1x, 2 sts. 2x, 1 st. 14x, 2 sts. 2x, 3 sts. 1x (3 sts. 1x, 2 sts. 2x, 1 st. 15x, 2 sts. 2x, 3 sts. 1x) [3 sts. 1x, 2 sts. 2x, 1 st. 16x, 2 sts. 2x, 3 sts. 1x] After Row 192 (194) [196] bind off the remaining 6 (8) [10] sts.

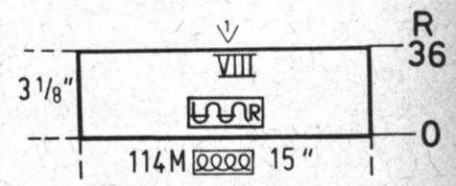
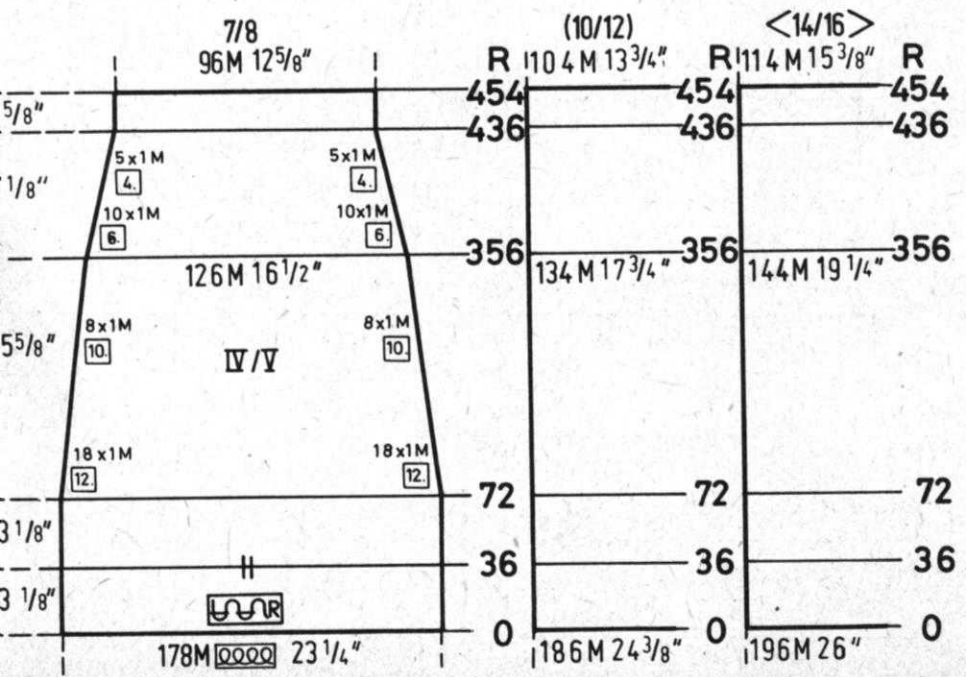

CAPE NECKBAND: VIII

ALL SIZES: Cast on 114 sts. and knit 36 rows Stockinette stitch then bind off.

SKIRT FRONT and BACK: IV/V

Cast on 178 (186) [196] sts. Work in Stockinette stitch. After Row 36, form the hem then knit to Row 72. ALL SIZES: ON EACH SIDE, decrease 1 st. every 12th row 18x, every 10th row 8x. After Row 356, ON EACH SIDE, decrease 1 st. every 6th row 10x, every 4th row 5x. Knit to Row 454 then bind off the remaining 96 (104) [114] sts.

DK 8

PULLOVER, SKIRT AND STOLE

SIZE: 7/8 (10/12) [14/16]

YARN:

Pullover: Subita grams 250 300 350

Skirt & Stole: Melodie

grams 1000 1050 1100

E Skirt: 7 to 9

Pullover & Stole: 10

PULLOVER BACK: II

Cast on 104 (112) [122] sts. and work in Pattern I.

ALL SIZES: Knit to Row 162.

SHAPE ARMHOLE: ON EACH SIDE, bind off

3 sts. 2x, 2 sts. 2x, 1 st. 2x

(3 sts. 2x, 2 sts. 2x, 1 st. 3x)

[3 sts. 2x, 2 sts. 2x, 1 st. 4x]

Knit to Row 258 (270) [276] bind off the center 10 sts. put the needles on the left into holding position and complete the right half first.

*SHAPE SHOULDER and NECK AT THE SAME TIME

Bind off

FOR SHOULDER

2 sts. 8x, 3 sts. 2x

(2 sts. 5x, 3 sts. 5x)

[2 sts. 1x, 3 sts. 9x]

FOR NECK

2 sts. 4x, 1 st. 5x

Same as above

Same as above

Bring the needles on the left into working position, knit 1 row in Pattern to the left, turn the Row Counter back to 258 (270) [276] and complete the left half. Follow the instructions from *.

PULLOVER FRONT: I

Work the Front section the same as the back to Row 228 (240) [246] Bind off the center 8 sts. put the needles on the left into holding position and complete the right half first.

*FOR NECK, bind off 3 sts. 2x, 2 sts. 2x, 1 st. 4x and SHAPE SHOULDER after Row 258 (270) [276]

Bind off

2 sts. 8x, 3 sts. 2x

(2 sts. 5x, 3 sts. 5x)

[2 sts. 3x, 3 sts. 9x]

Bring the needles on the left into working position, knit 1 row in Pattern to the left, turn the Row Counter back to 228 (240) [246] and complete the left half. Follow the instructions from *.

UPPER SLEEVE: III

Cast on 20 (26) [32] sts. and work Pattern I.

ALL SIZES: ON EACH SIDE, cast on 2 sts. 3x,

3 sts. 5x, 4 sts. 6x. Knit to Row 66.

SHAPE CAP ON EACH SIDE. Bind off

3 sts. 2x, 2 sts. 2x, 1 st. 24x, 2 sts. 1x,

3 sts. 4x

(3 sts. 2x, 2 sts. 2x, 1 st. 27x, 2 sts. 1x,

3 sts. 4x)

[3 sts. 2x, 2 sts. 2x, 1 st. 30x, 2 sts. 1x,

3 sts. 4x]

After Row 132 (138) [144] bind off the remaining 14 sts.

P Stock: 15 sts., 21 rows = 2"

Pattern I: 13 sts., 30 rows = 2"

Pattern II: 12 sts., 20 rows = 2"

Skirt, lower Sleeve and Bands are Stockinette stitch worn on the knit side. Pullover back, front and upper Sleeve are Pattern I worn on the purl side. Follow the Line Drawing and use Wheel 3. Stole: Pattern II with needles out of work that ARE COUNTED in the stitch gauge and instructions. Follow the Line Drawing and use the Adjustable Needle Selector. The Purl side is the right side.

FINISHING:

See General Instructions. Gather lower edge of Pullover then sew on waistband. Gather lower edge of sleeve cap and sew to upper edge of lower sleeve. Gather upper edge of cap and sew sleeve into armhole. Skirt: Make hem at waistline then insert elastic. Stole: Attach fringe at each end (see General Instructions and picture).

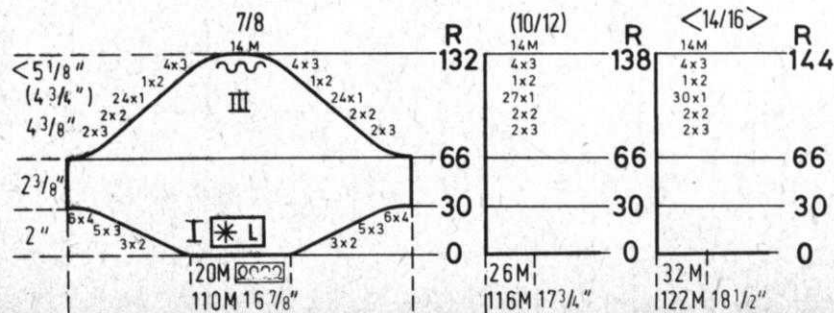
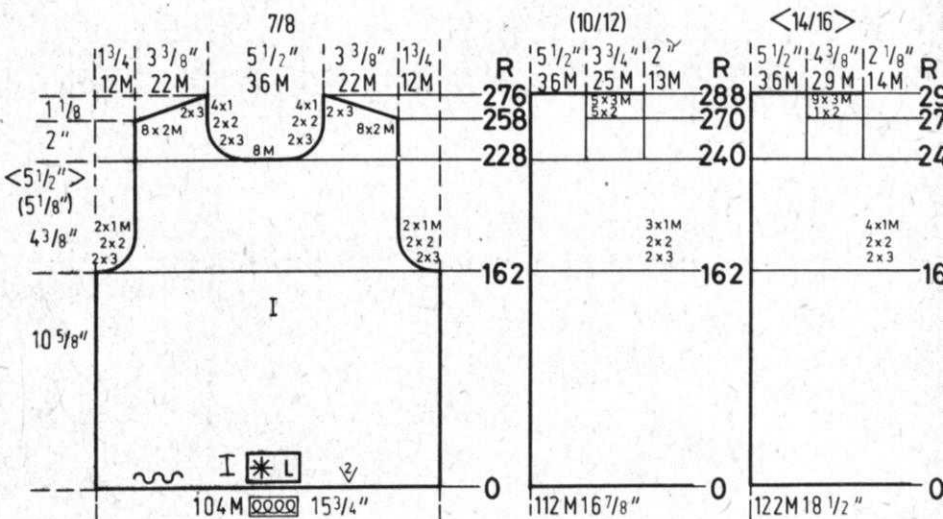
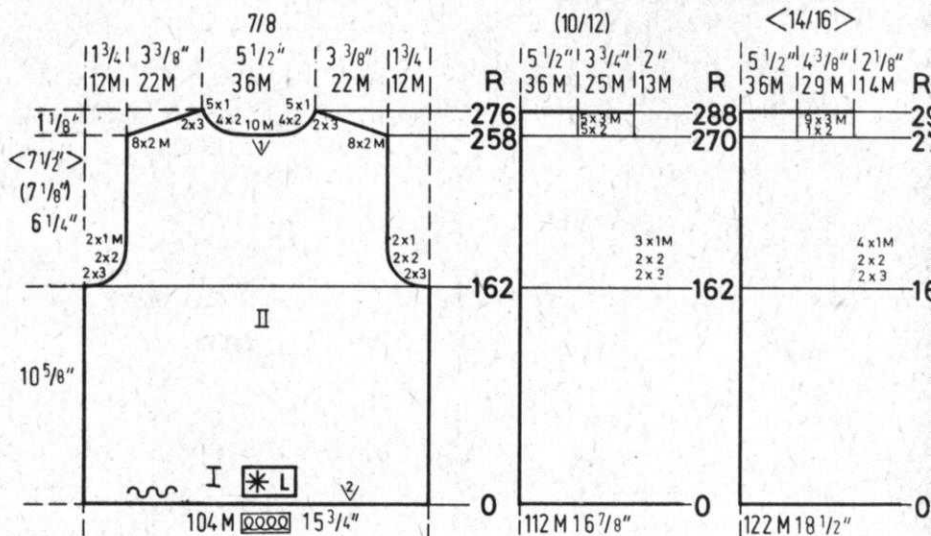

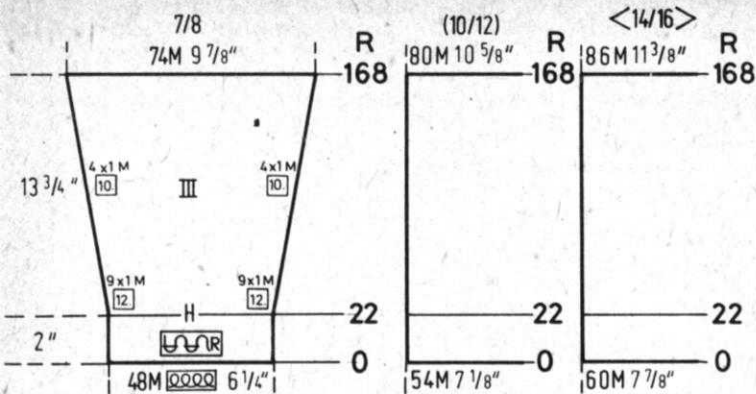

LOWER SLEEVE: III

Cast on 48 (54) [60] sts. and work Stockinette stitch.

ALL SIZES: Knit to Row 22, form the hem then ON EACH SIDE, increase 1 st. every 12th row 9x, every 10th row 4x. After Row 168, bind off 74 (80) [86] sts.

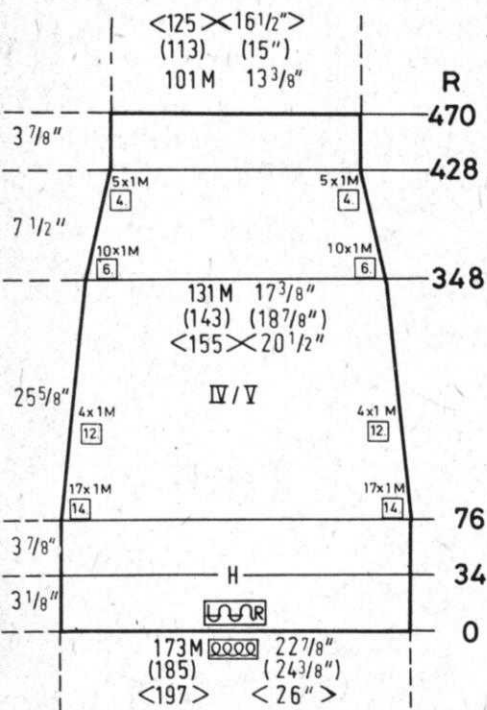

SKIRT FRONT AND BACK: IV/V

Cast on 173 (185) [197] sts. and work Stockinette stitch.

ALL SIZES: Knit to Row 34, form the hem then knit to Row 76. ON EACH SIDE, decrease 1 st. every 14 rows 17x, every 12th row 4x. Knit to Row 348. ON EACH SIDE decrease 1 st. every 6th row 10x, every 4th row 5x. Knit to Row 470 then bind off 101 (113) [125] sts.

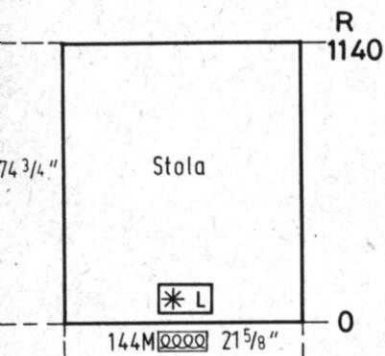

STOLE: ALL SIZES:

Bring 144 needles into working position, set up into Pattern II, cast on. Knit to Row 1140 then bind off.

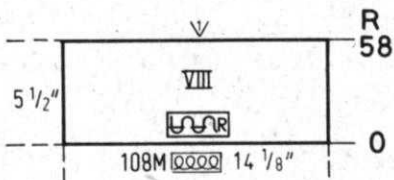

NECKBAND: VIII

Cast on 108 sts. and work 58 rows Stockinette stitch, then bind off.

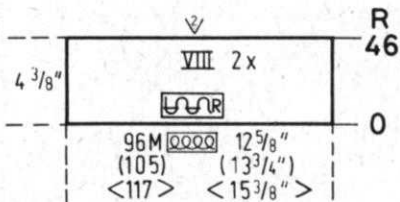

PULLOVER WAISTBAND: VIII

Make 2

Cast on 96 (105) [117] sts. and work 46 rows Stockinette stitch, then bond off.

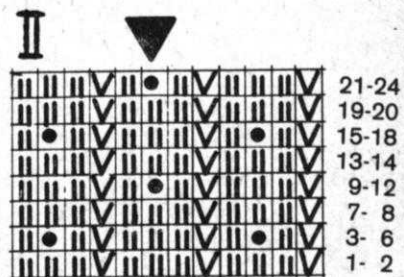
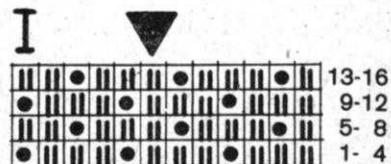

ADJUSTABLE NEEDLE SELECTOR

Suitable for KNITTING Machines only. The Adjustable Needle Selector can be set to any needle spacing and is the perfect Tool to use with many of the Patterns in this issue of KNITTING MAGAZINE.

Price: \$ 4.25 Shipping: \$.60
California residents add Sales Tax.

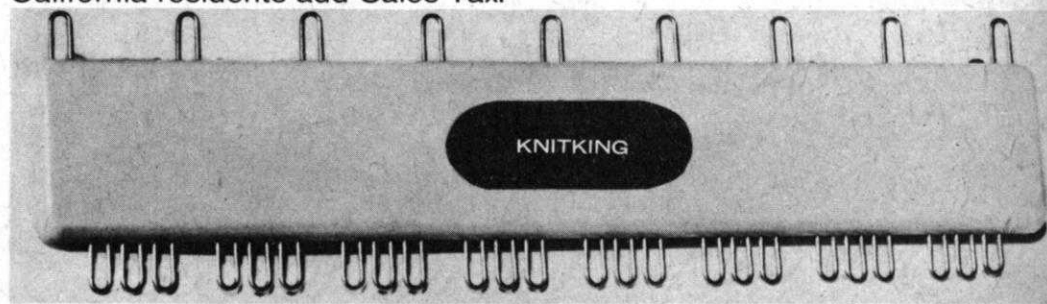

DK 9

LONG DRESS

SIZE: 7/8 (10/12) [14/16]

YARN: Beatrice grams 900 950 1000

E Stock: 5 to 7

P Pattern: 8 to 10

Stock: 16 sts., 22 rows = 2"

Pattern: 13 sts., 19 rows = 2"

The skirt section, Sleeve Ruffle and Collar are in Pattern with out of work needles that ARE COUNTED in the stitch gauge and instructions. Worn on the Purl side. Follow the Line Drawing and use the Adjustable Needle Selector. The Bodice and Sleeves are in Stockinette stitch worn on the Knit side.

FINISHING:

See General Instructions. Gather top edge of Skirt then sew to bodice. Gather Sleeve Ruffle then sew to edge of Sleeve. Line the skirt section with Taffeta. Make a twisted Cord (See Practical Knitting Hints Book) using 10 strands of yarn.

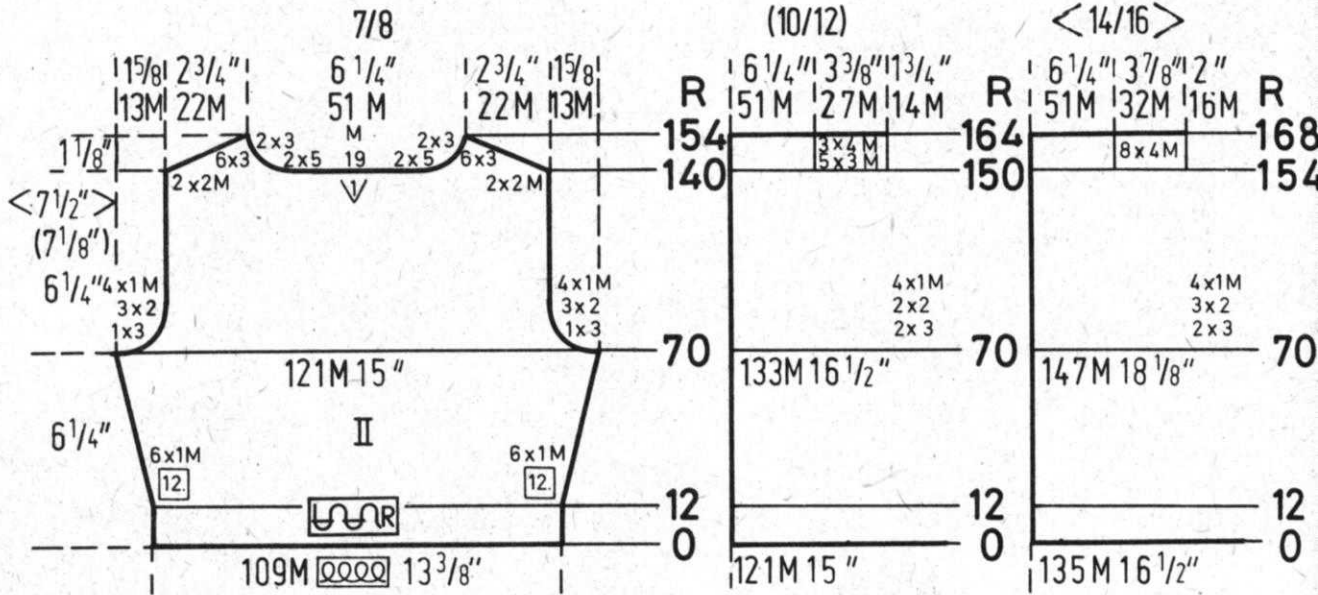

BACK BODICE: II

Cast on 109 (121) [135] sts. and work Stockinette stitch. After Row 12, ON EACH SIDE, decrease 1 st. every 12th row 6x SHAPE ARMHOLE after Row 70. ON EACH SIDE, bind off 3 sts. 1x, 2 sts. 3x, 1 st. 4x (3 sts. 2x, 2 sts. 2x, 1 st. 4x) [3 sts. 2x, 2 sts. 3x, 1 st. 4x] Knit to Row 140 (150) [154] Bind off the center 19 sts., put the needles on the left into holding position and complete the right half first. *SHAPE SHOULDER and NECK AT THE

SAME TIME

Bind off FOR SHOULDER 2 sts. 2x, 3 sts. 6x 3 sts. 5x, 4 sts. 3x [4 sts. 8x] FOR NECK 5 sts. 2x, 3 sts. 2x Same as above Same as above Bring the Cam Box to the left side, turn the Row Counter back to 140 (150) [154] and complete the left half. Follow the instructions from *.

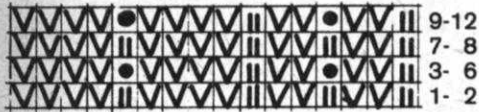

FRONT BODICE: I

(Make 1, reverse 1 and omit buttonholes)

Cast on 69 (75) [82] sts. and work Stockinette stitch. ON SIDE EDGE after Row 12, increase 1 st. every 12th row 6x AND AT THE SAME TIME, make buttonholes on the FRONT EDGE over needles 3 to 6 and 15 to 18 (counting from the left) after Rows 20, 46, 72 and SHAPE ARMHOLE after Row 70 and BEGIN NECK SHAPING after Row 81. FOR ARMHOLE bind off

3 sts. 1x, 2 sts. 3x, 1 st. 4x (3 sts. 2x, 2 sts. 3x, 1 st. 4x) [3 sts. 2x, 2 sts. 3x, 1 st. 4x] Bind off for NECK 20 sts. 1x, 3 sts. 2x, 2 sts. 3x, 1 st. 5x then every 4th row 1 st. 3x AND AT THE SAME TIME SHAPE SHOULDER after Row 140 (150) [154] bind off 2 sts. 2x, 3 sts. 6x (3 sts. 5x, 4 sts. 3x) [4 sts. 8x]

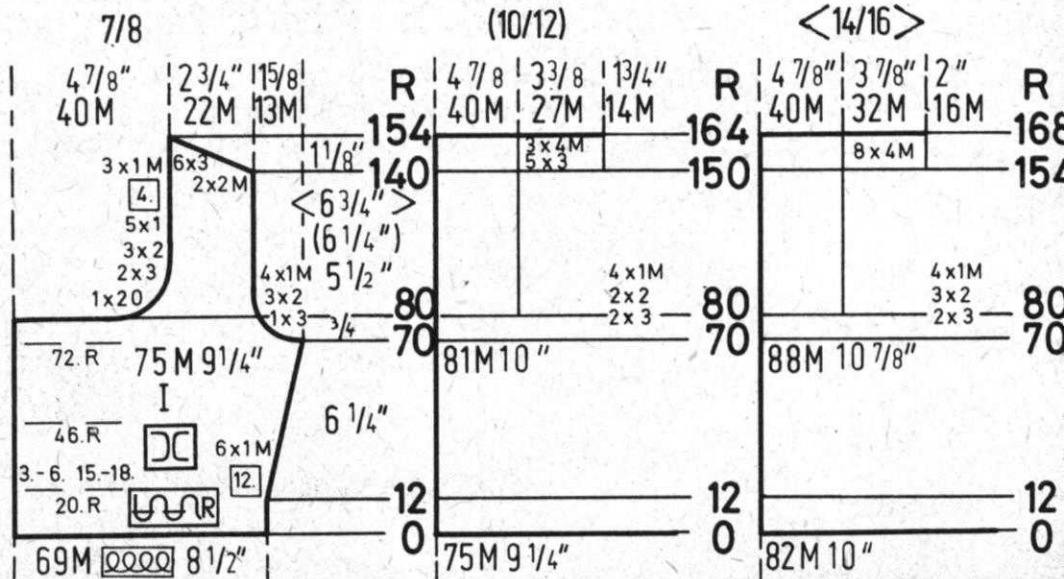

**LONG DRESS
SLEEVE: III**

Cast on 80 (86) [92] sts. and work in Stockinette stitch. ON EACH SIDE, after Row 4, increase 1 st. every 4th row 10x.
Knit to Row 44, then SHAPE CAP ON EACH SIDE, bind off
3 sts. 3x, 2 sts. 2x, *1 st. 2x, 2 sts. 2x* and REPEAT FROM * to * 4x more, then ON EACH SIDE bind off 2 sts. 2x, 4 sts. 2x.
After Row 92 bind off the remaining 10 sts. (3 sts. 3x, 2 sts. 2x, *1 st. 2x, 2 sts. 1x* and REPEAT FROM * to * 4x more, then ON EACH SIDE bind off 2 sts. 1x, 2 sts. 2x, 4 sts. 2x. After Row 96 bind off the remaining 12 sts.)
[3 sts. 2x, 2 sts. 4x, *1 st. 2x, 2 sts. 1x* and REPEAT FROM * to * 5x more, then ON EACH SIDE bind off 2 sts. 2x, 4 sts. 2x. After Row 100 bind off the remaining 12 sts.]

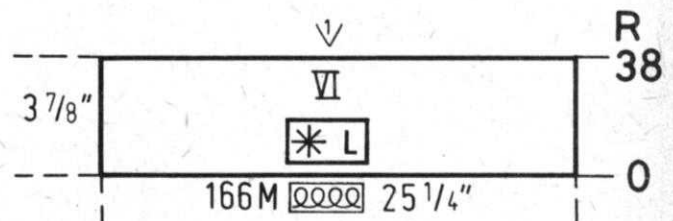
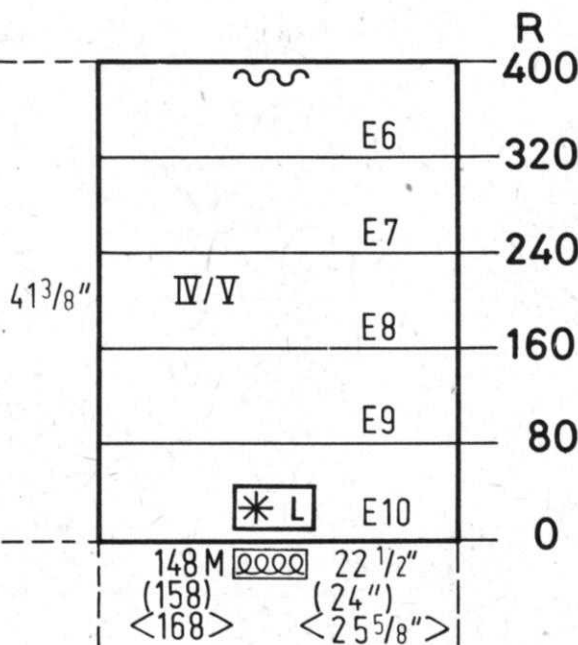
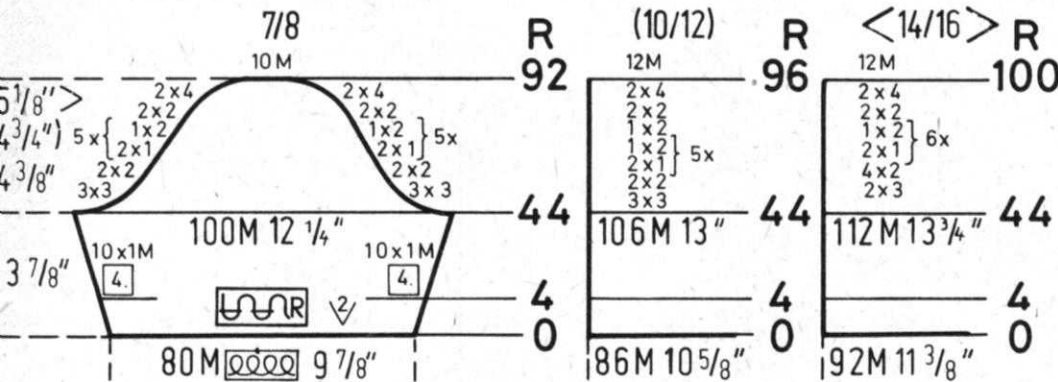

COLLAR: VI ALL SIZES:

Bring 166 needles into working position, set up in Pattern then knit 38 rows and bind off.

SKIRT FRONT AND BACK: IV/V

Bring 148 (158) [168] needles into working position then set up in Pattern.
ALL SIZES: With Tension 10, knit to Row 80.
With Tension 9, knit to Row 160.
With Tension 8, knit to Row 240.
With Tension 7, knit to Row 320.
With Tension 6, knit to Row 400 then bind off.

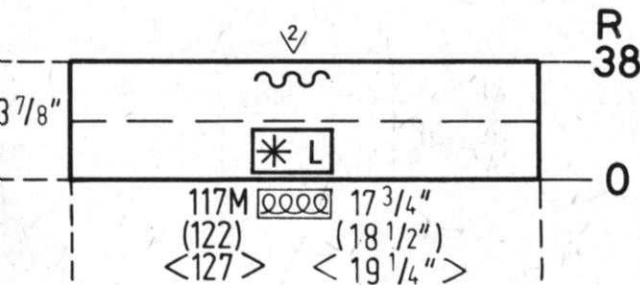

SLEEVE RUFFLE:

Bring 117 (122) [127] needles into working position then set up in Pattern and knit to Row 38 and bind off.

ADJUSTABLE NEEDLE SELECTOR

Suitable for KNITKING Machines only. The Adjustable Needle Selector can be set to any needle spacing and is the perfect Tool to use with many of the Patterns in this issue of KNITKING MAGAZINE.

Price: \$ 4.25 Shipping: \$.60
California residents add Sales Tax.

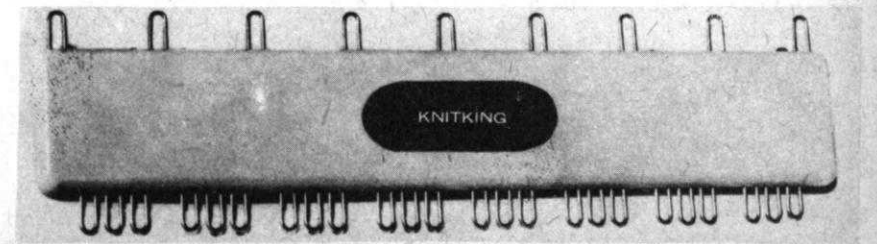

DK 10

LONG DRESS AND TRIANGLE SHAWL

SIZE: 8/10 (12/14) [16/18]

YARN: subita grams 900 950 1000

Melodie grams 400 450 500

E 8 to 10

P Stock: 16 sts., 21 rows = 2"

Pattern: 14 sts., 26 rows = 2"

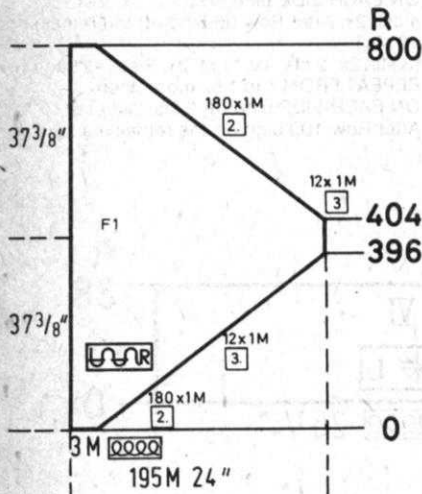

SHAWL

ALL SIZES: Cast on 3 sts. to the far left of machine and knit in Stockinette stitch.
ON THE RIGHT SIDE, increase 1 st. every 2nd row 180 x, every 3rd row 12x. Knit to Row 404
ON THE RIGHT SIDE, decrease 1 st. every 3rd row 12x, every 2nd row 180x. After Row 800 bind off.

BODICE FRONT: I

Work the front section the same as the back to Row 76 (72) [68] then work Short Rows for Bust Darts.
ON OPPOSITE SIDE OF CAM BOX put into holding position
9 sts. 4x ON EACH SIDE
(7 sts. 6x ON EACH SIDE)
(6 sts. 8x ON EACH SIDE)
Bring the needles back into knitting position before knitting the next 2 rows.
Knit to Row 96 (100) [104].
SHAPE ARMHOLE AND NECK
For Armhole, bind off 3 sts. 2x, 2 sts. 2x, 1 st. 3x
(3 sts. 3x, 2 sts. 2x, 1 st. 3x)
[3 sts. 3x, 2 sts. 3x, 1 st. 4x]
AND AT THE SAME TIME SHAPE NECK after Row 96 (100) [104]
Bind off the center 12 sts. put the needles on the left side into holding position and complete the right half first.
*ON NECK SIDE, bind off
3 sts. 3x, 2 sts. 3x, 1 st. 6x
SHAPE SHOULDER after Row 164 (172) [180] bind off
3 sts. 2x, 4 sts. 5x
(4 sts. 6x, 5 sts. 1x)
[4 sts. 1x, 5 sts. 6x]
Move the Cam Box to the left side, turn the Row Counter back to 96 (100) [104] and complete the left half. Follow the instructions from *.

Shawl, Dress bodice, Sleeves and neckband are Stockinette stitch worn on the knit side.
Skirt: Holding position Design using Wheel 2, worn on the knit side. Follow the Line Drawing.

FINISHING:

See General Instructions. Gather skirt at waist then sew to bodice. Work 1 row single crochet then 1 row picot around sleeve edges. Attach Fringe to Shawl (see picture). Sew small buttons to front of dress.

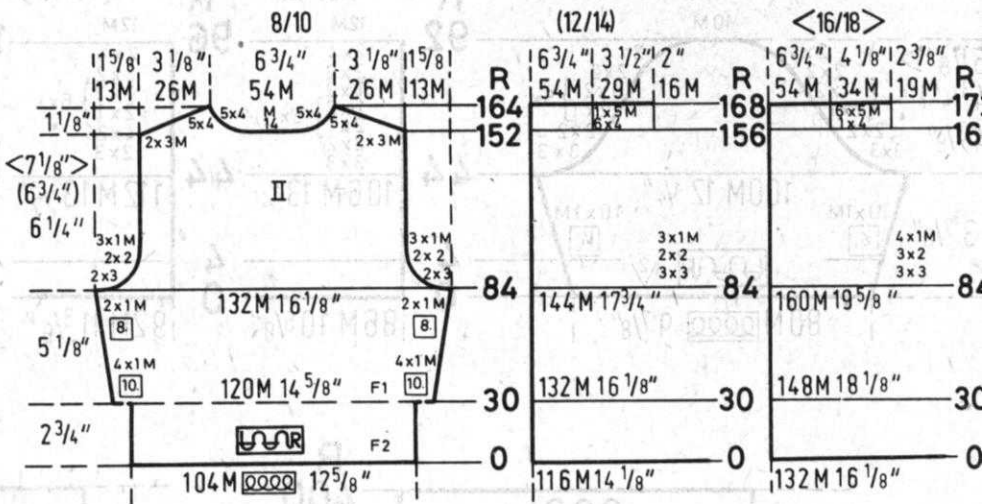

BODICE BACK: II

Cast on 104 (116) [132] sts. with color 2 and work Stockinette stitch.
ALL SIZES: Knit to Row 30 then remove the stitches onto a stitch holder and hang them back onto the machine increasing 16 sts. evenly across. Change to color 1 and ON EACH SIDE increase 1 st. every 10th row 4x, every 8th row 2x.
After Row 84 SHAPE ARMHOLE: Bind off
3 sts. 2x, 2 sts. 2x, 1 st. 3x
(3 sts. 3x, 2 sts. 2x, 1 st. 3x)
[3 sts. 3x, 2 sts. 3x, 1 st. 4x]
Knit to Row 152 (156) [160]
Bind off the center 14 sts. put the needles on the left into holding position and complete the

right half first.
*SHAPE NECK AND SHOULDER AT THE SAME TIME.
Bind off
FOR SHOULDER
3 sts. 2x, 4 sts. 5x
(4 sts. 6x, 5 sts. 1x)
[4 sts. 1x, 5 sts. 6x]
FOR NECK
4 sts. 5x
Same as above
Same as above
Move the Cam Box to the left, turn the Row Counter back to 152 (156) [160] and complete the left half. Follow the instructions from *.

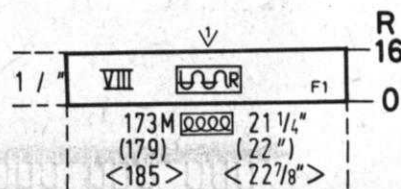
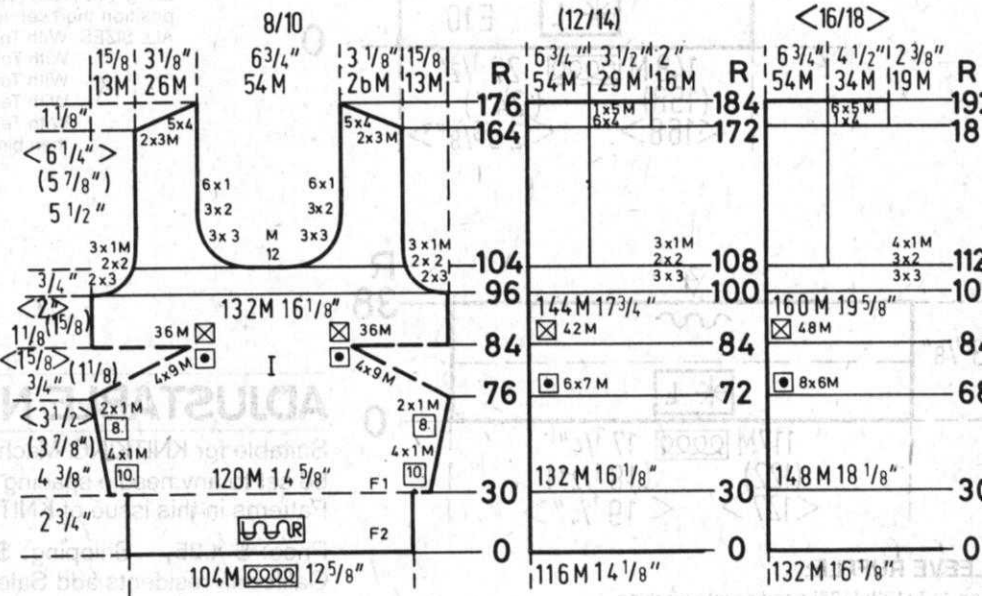

NECKBAND: VIII

Cast on 173 (179) [185] sts. with color 1 and work 16 rows Stockinette stitch then bind off.

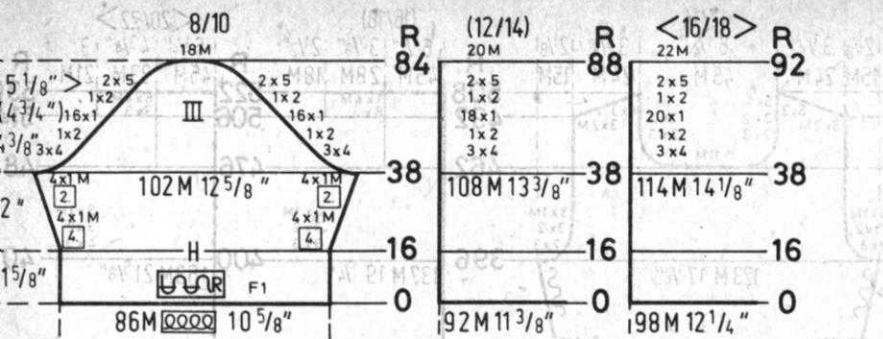

SLEEVE: III

Cast on 86 (92) [98] sts. and work Stockinette stitch. After Row 16 increase 1 st. ON EACH SIDE every 4th row 4x, every 6th row 4x.
After Row 38 SHAPE CAP.
ON EACH SIDE bind off
1 st. 3x, 2 sts. 1x, 1 st. 16x, 2 sts. 1x, 2 sts. 2x
1 st. 3x, 2 sts. 1x, 1 st. 18x, 2 sts. 1x, 2 sts. 2x
1 st. 3x, 2 sts. 1x, 1 st. 20x, 2 sts. 1x, 2 sts. 2x
After Row 84 (88) [92] bind off the remaining (20) [22] sts.

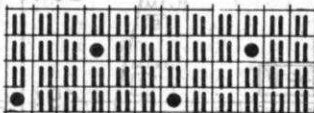

11-12 Garn
7-10 Wolle
5- 6 Garn
1- 4 Wolle

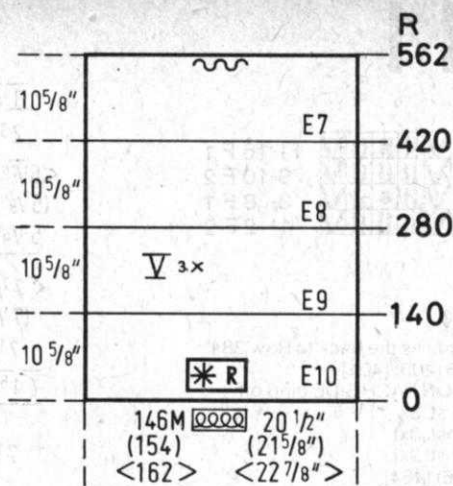

SKIRT: V Make 3 sections

Cast on 146 (154) [162] sts. and knit in Pattern.

Knit with Tension 10 to Row 140
with Tension 9 to Row 280
with Tension 8 to Row 420
with Tension 7 to Row 562 then bind off

BOOK 11

DRESS AND COAT

SIZE: <12/14 (16/18) [20/22]>

YARN: Beatrice grams 1650 1700 1750

Capriccio gram 375 375 375

6 to 8

Stock: 14 sts., 20 rows = 2"

Pattern: 14 sts., 25 rows = 2"

Dress is in a Holding Position Design and Stockinette stitch. Coat in same Holding Position Design with out of work needles that ARE COUNTED in the stitch gauge and instructions. Follow the Line Drawing and use the Adjustable Needle Selector. All worn on the Knit side.

FINISHING :

See General Instructions. Ease the fullness at bustline of front sections of dress and coat.

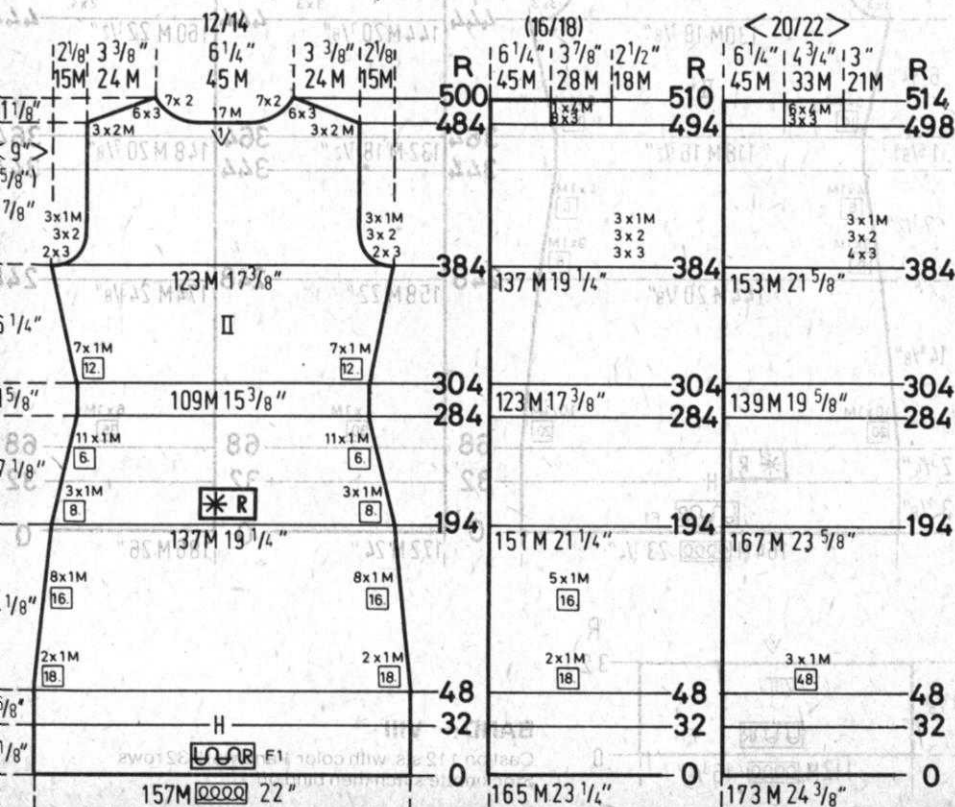

DRESS AND COAT DRESS BACK : II

Cast on 157 (165) [173] sts. with color 1 and work in Stockinette stitch. Knit to Row 32 then form the hem and knit to Row 48.

ON EACH SIDE decrease 1 st. every 18th row 2x, every 16th row 8x (every 18th row 2x, every 16th row 5x) [every 48th row 3x]

ALL SIZES: SET UP INTO PATTERN after Row 194 ON EACH SIDE decrease 1 st. every 8th row 3x, every 6th row 11x Knit to Row 304 ON EACH SIDE increase 1 st. every 12th row 17x Knit to Row 384 then SHAPE ARMHOLE ON EACH SIDE bind off

3 sts. 2x, 2 sts. 3x, 1 st. 3x (3 sts. 3x, 2 sts. 3x, 1 st. 3x) [3 sts. 4x, 2 sts. 3x, 1 st. 3x]

Knit to Row 484 (494) [498] Bind off the center 17 sts., put the needles on the left into holding position and complete the right half first. *SHAPE NECK AND SHOULDER AT THE SAME TIME

Bind off FOR SHOULDER

2 sts. 3x, 3 sts. 6x (3 sts. 8x, 4 sts. 1x) [3 sts. 3x, 4 sts. 6x]

FOR NECK

2 sts. 7x

Same as above Same as above

Bring the needles on the left into working position, knit 1 row in Pattern to the left side, turn the Row Counter back to 484 (494) [498] and complete the left half. Follow the instructions from *.

DK 11

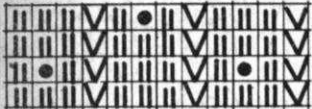

11-16 F1
9-10 F2
3-8 F1
1-2 F2

DRESS FRONT I

Knit the front the same as the back to Row 384 then knit to Row 396 (400) [404]
SHAPE ARMHOLE: ON EACH SIDE bind off 3 sts. 2x, 2 sts. 3x, 1 st. 3x (3 sts. 3x, 2 sts. 3x, 1 st. 3x) [3 sts. 4x, 2 sts. 3x, 1 st. 3x]
Knit to Row 462 (476) [484]
Bind off the center 11 sts. put the needles on the left side into holding position and complete the right half first.
*FOR NECK, bind off 3 sts. 2x, 2 sts. 3x, 1 st. 5x SHAPE SHOULDER after Row 492 (506) [514]
Bind off
2 sts. 3x, 3 sts. 6x (3 sts. 8x, 4 sts. 1x) [3 sts. 3x, 4 sts. 6x]
Bring the needles on the left into working position, knit 1 row in pattern to the left side, turn the Row Counter back to 462, (476) [484] and complete the left side. Follow the instructions from *.

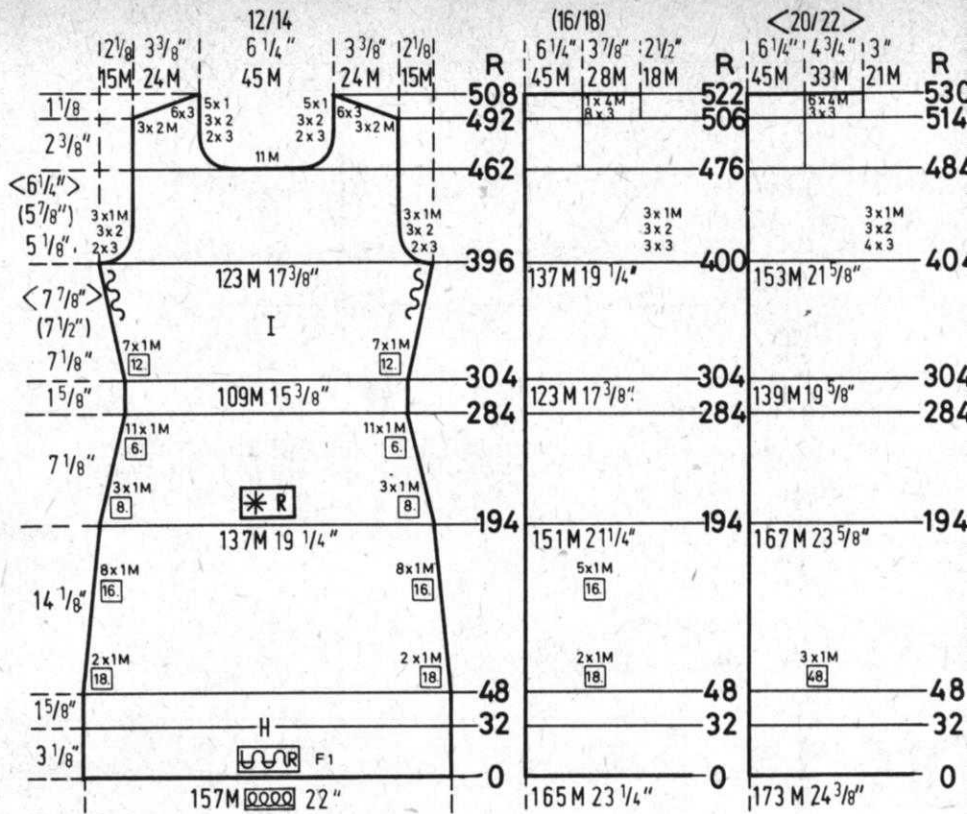

COAT BACK: II

Cast on 164 (172) [186] sts. with color 1 and work Stockinette stitch to Row 32, form the hem then set up into Pattern and knit to Row 68.
ON EACH SIDE decrease 1 st. every 20th row 10x (every 30th row 7x) [every 36th row 6x]
Knit to Row 248
ALL SIZES: ON EACH SIDE decrease 1 st. every 8th row 9x, every 6th row 4x. Knit to Row 364 then increase 1 st. ON EACH SIDE every 14th row 6x.
Knit to Row 444. SHAPE ARMHOLE ON EACH SIDE, bind off 3 sts. 3x, 2 sts. 2x, 1 st. 4x (3 sts. 3x, 2 sts. 4x, 1 st. 3x) [4 sts. 2x, 3 sts. 2x, 2 sts. 3x, 1 st. 3x]
Knit to Row 544 (554) [558]
Bind off the center 14 sts. put the needles on the left side into holding position and complete the right half first.
*SHAPE SHOULDER AND NECK AT THE SAME TIME
bind off
FOR SHOULDER
2 sts. 3x, 3 sts. 6x (3 sts. 8x, 4 sts. 1x) [3 sts. 3x, 4 sts. 6x]
FOR NECK
3 sts. 3x, 2 sts. 4x
Same as above
Bring the needles on the left into working position, knit 1 row in Pattern to the left side, turn the Row Counter back to 544 (554) [558] and complete the left half. Follow the instructions from *.

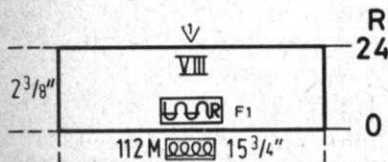
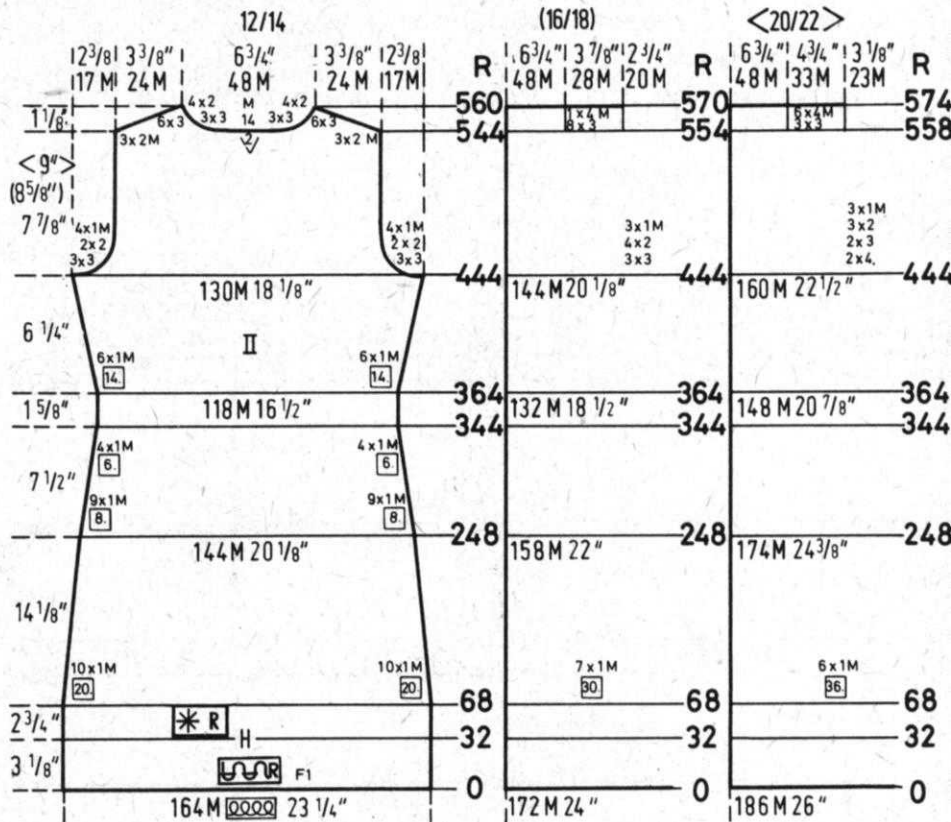

BAND: 1 VIII

Cast on 112 sts. with color 1 and work 24 rows Stockinette stitch then bind off.

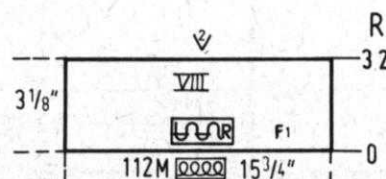

BAND: VIII

Cast on 112 sts. with color 1 and work 32 rows Stockinette stitch then bind off.

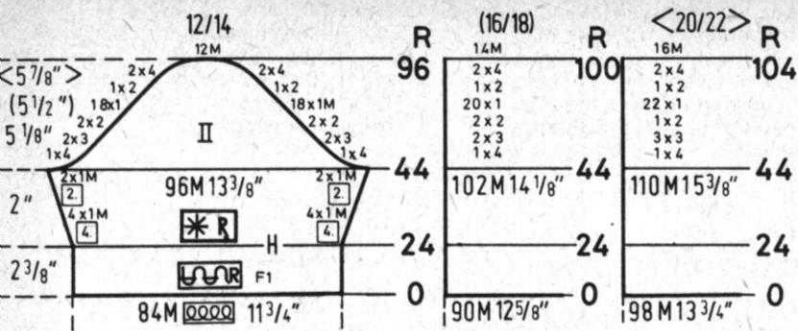

DRESS SLEEVE: II

Cast on 84 (90) [98] sts. with color 1 and work Stockinette stitch to Row 24, form the hem then set up into Pattern.
 ALL SIZES: ON EACH SIDE, increase 1 st. every 4th row 4x, every 2nd row 2x. After Row 44 SHAPE CAP.
 ON EACH SIDE bind off
 4 sts. 1x, 3 sts. 2x, 2 sts. 2x, 1 st. 18x, 2 sts. 1x, 4 sts. 2x
 (4 sts. 1x, 3 sts. 2x, 2 sts. 2x, 1 st. 20x, 2 sts. 1x, 4 sts. 2x)
 [4 sts. 1x, 3 sts. 2x, 2 sts. 2x, 1 st. 20x, 2 sts. 1x, 4 sts. 2x]
 After Row 96 (100) [104] bind off the remaining 12 (14) [16] sts.

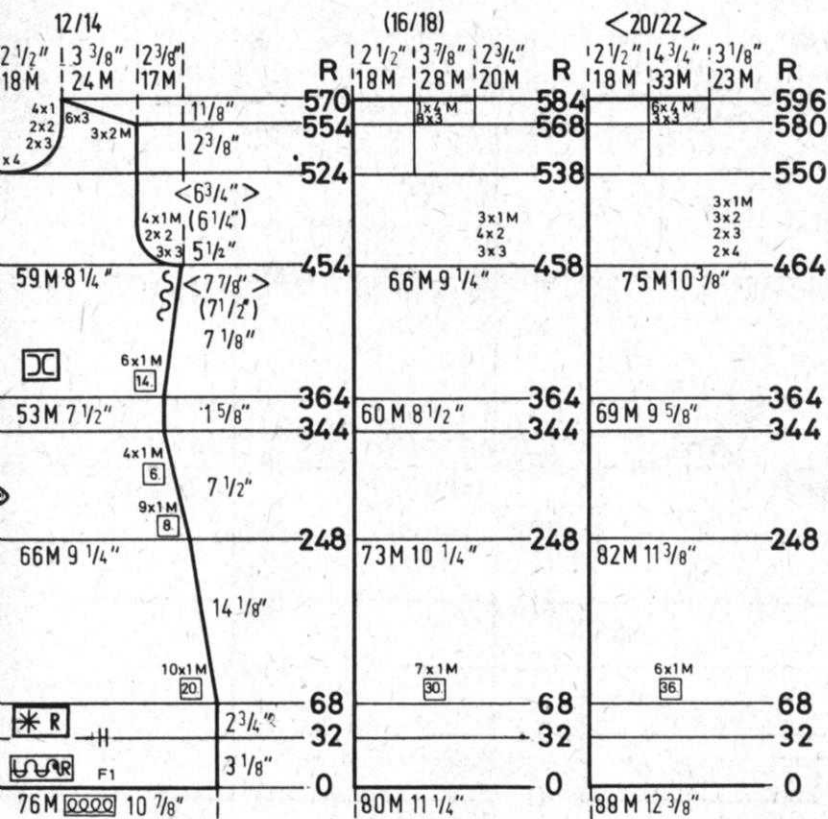

**COAT FRONT: I
(Make 1, reverse 1)**

Cast on 76 (80) [88] sts. with color 1 and work Stockinette stitch to row 32. Form the hem then set up into Pattern and knit to Row 68. ON SIDE EDGE decrease 1 st. every 20th row 10x (every 30th row 7x) [every 36th row 6x]
 Knit to Row 248
 ON SIDE EDGE decrease 1 st. every 8th row 9x, every 6th row 4x
 Knit to Row 364 then increase 1 st. every 14th row 6x.
 Knit to Row 454 (458) [464] SHAPE ARM-HOLE Bind off
 3 sts. 3x, 2 sts. 2x, 1 st. 4x
 (3 sts. 3x, 2 sts. 4x, 1 st. 3x)
 [4 sts. 2x, 3 sts. 2x, 2 sts. 3x, 1 st. 3x]
 Knit to Row 525 (539) [551]
 ON NECK SIDE, bind off
 4 sts. 1x, 3 sts. 2x, 2 sts. 2x, 1 st. 4x and SHAPE SHOULDER after Row 554 (568) [580] Bind off
 2 sts. 3x, 3 sts. 6x
 (3 sts. 8x, 4 sts. 1x)
 [3 sts. 3x, 4 sts. 6x]

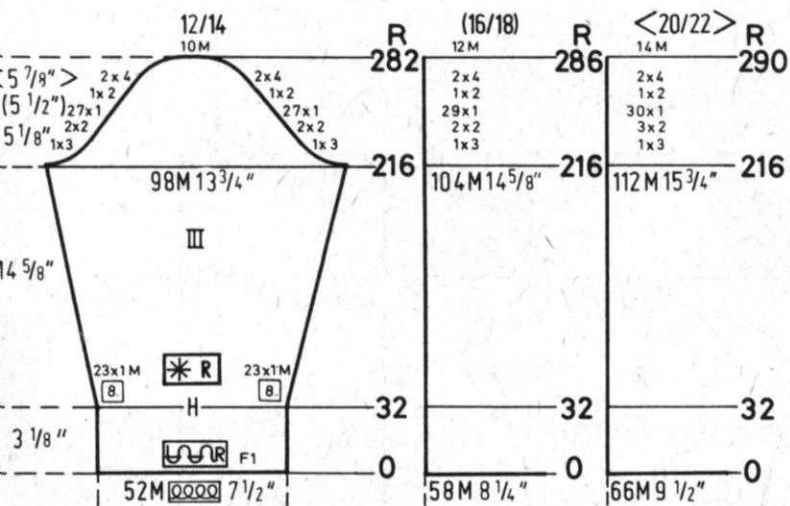

COAT SLEEVE: III

Cast on 52 (58) [66] sts. with color 1 and work Stockinette stitch to Row 32, form the hem then set up into Pattern.
 ALL SIZES: ON EACH SIDE increase 1 st. every 8th row 32x, knit to Row 216.
 SHAPE CAP: ON EACH SIDE, bind off 4 sts. 1x, 2 sts. 2x, 1 st. 27x, 2 sts. 1x,

4 sts. 2x
 (3 sts. 1x, 2 sts. 2x, 1 st. 29x, 2 sts. 1x, 4 sts. 2x)
 [3 sts. 1x, 2 sts. 3x, 1 st. 30x, 2 sts. 1x, 4 sts. 2x
 After Row 282 (286) [290] bind off the remaining 10 (12) [14] sts.

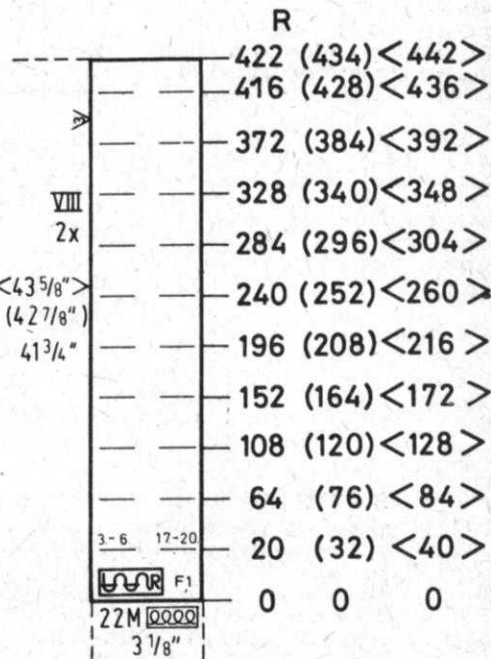

BAND: II VIII

Cast on 22 sts. with color 1 and work Stockinette stitch. Make Buttonholes over needles 3 to 6 and 17 to 20 following the Row numbers on the Chart for your size. Make the Button Band, omitting the Buttonholes.

DK 12

LONG DRESS AND TRIANGLE SHAWL

SIZE: 8/10 (12/14) [16/18]

YARN: C1 Amore grams 1000 1050 1100

C2 Melodie grams 400 450 500

E 7 to 9

P Stock: 15 sts., 23 rows = 2"

Pattern: 13 sts., 18 rows = 2"

DRESS BACK

Bring 156 (168) [184] needles into working position then set into Pattern. Cast on. With Tension 10, knit to Row 72, change to Tension 9 and ON EACH SIDE decrease 1 st. every 28th Row 10x and change to Tension 8 after Row 144, change to Tension 7 after Row 216, change to Tension 6 after Row 288. After Row 360 remove the sts. onto a stitch holder and hang them back onto the machine decrease 9 to 102 (112) [124] sts. Continue with color 2 in Stockinette stitch to Row 398. After Row 378, change to color 1 and ON EACH SIDE, increase 1 st. every 8th row 9x, knit to Row 460

SHAPE ARMHOLE: ON EACH SIDE bind off 2 sts. 3x, 1 st. 6x (3 sts. 1x, 2 sts. 3x) [3 sts. 2x, 2 sts. 2x, 1 st. 5x] Knit to Row 534 (542) [552] Bind off the center 22 sts. put the needles on the left into holding position and complete the right half first.

***SHAPE SHOULDER AND NECK AT THE SAME TIME** bind off FOR SHOULDER

3 sts. 3x, 4 sts. 3x (4 sts. 6x) [4 sts. 1x, 5 sts. 5x] FOR NECK

4 sts. 4x Same as above Same as above

Move the Cam Box to the left, turn the Row Counter back to 534 (542) [552] and complete the left half. Follow the instruction from *.

Dress: Stockinette stitch and a Holding Position Design with needles out of work that ARE COUNTED in the stitch gauge and the instructions. The knit side is the right side. Follow the Line Drawing and use the Adjustable Needle Selector. Shawl: Stockinette stitch on the knit side.

FINISHING:

See General Instructions. Single crochet around neck and edge of sleeves using color 2. Single crochet around edges of Shawl then attach fringe (see General Instructions) using color 2.

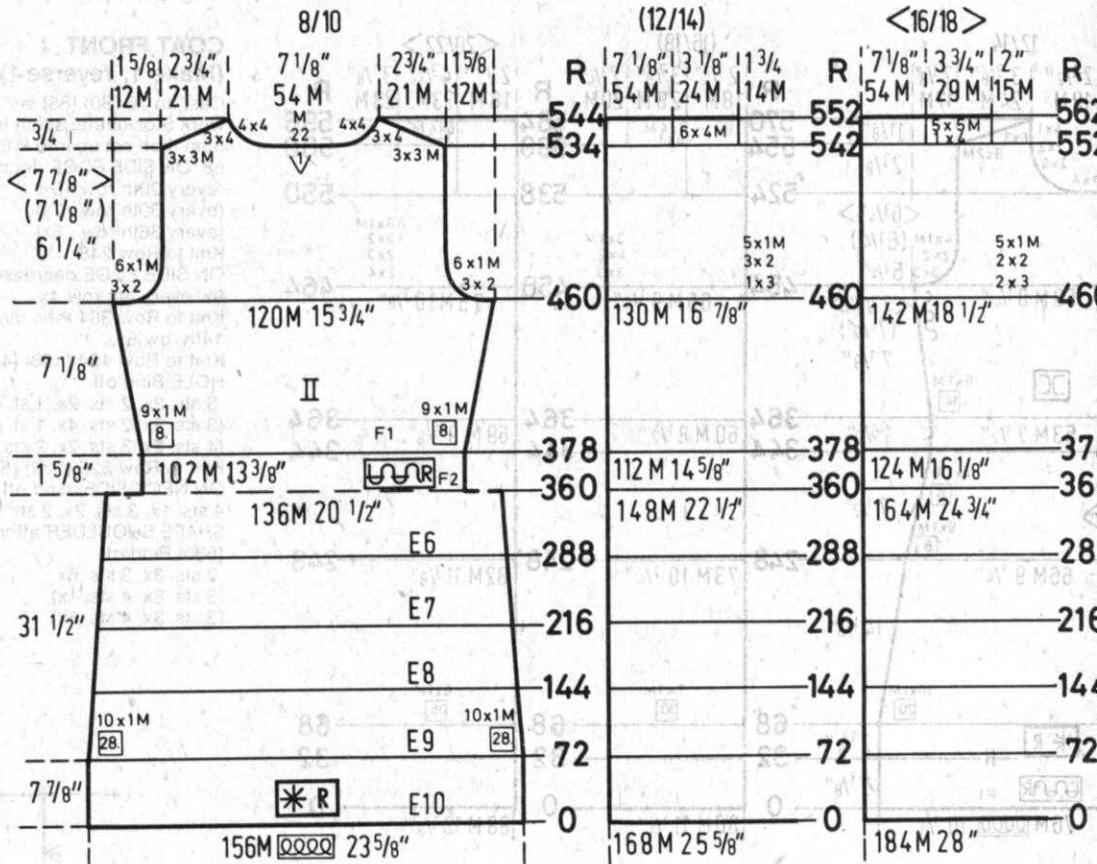

SLEEVE: III

Cast on 52 (58) [66] sts. with color 1 and work Stockinette stitch to Row 28 then form the hem.

ON EACH SIDE increase 1 st. every 8th row 22x, knit to Row 208

SHAPE CAP: ON EACH SIDE bind off 3 sts. 2x, 2 sts. 5x, 1 st. 15x, 2 sts. 2x, 4 sts. 2x

(3 sts. 2x, 2 sts. 5x, 1 st. 17x, 2 sts. 2x, 4 sts. 2x)

[3 sts. 2x, 2 sts. 5x, 1 st. 21x, 2 sts. 2x, 4 sts. 2x]

After Row 260 (264) [272] bind off the remaining 10 (12) [12] sts.

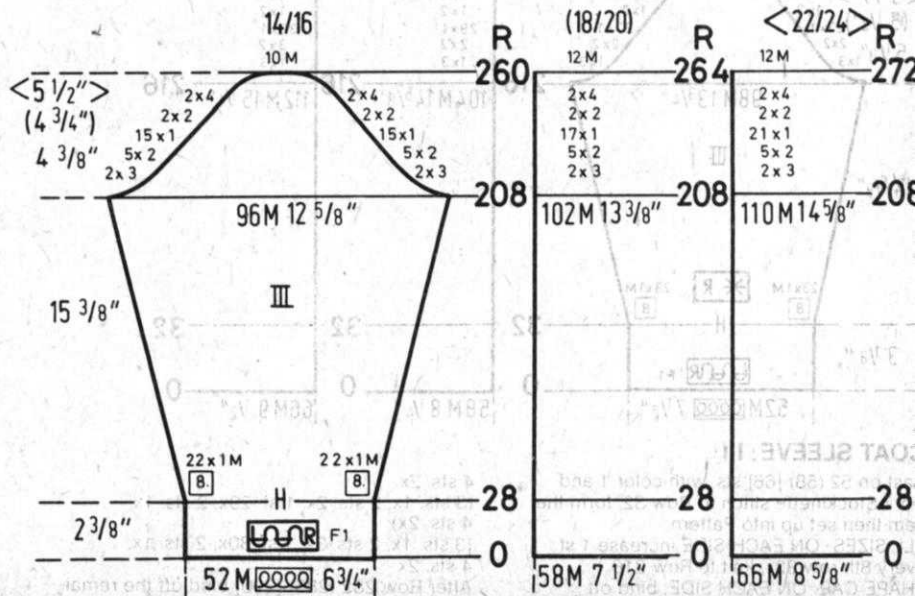

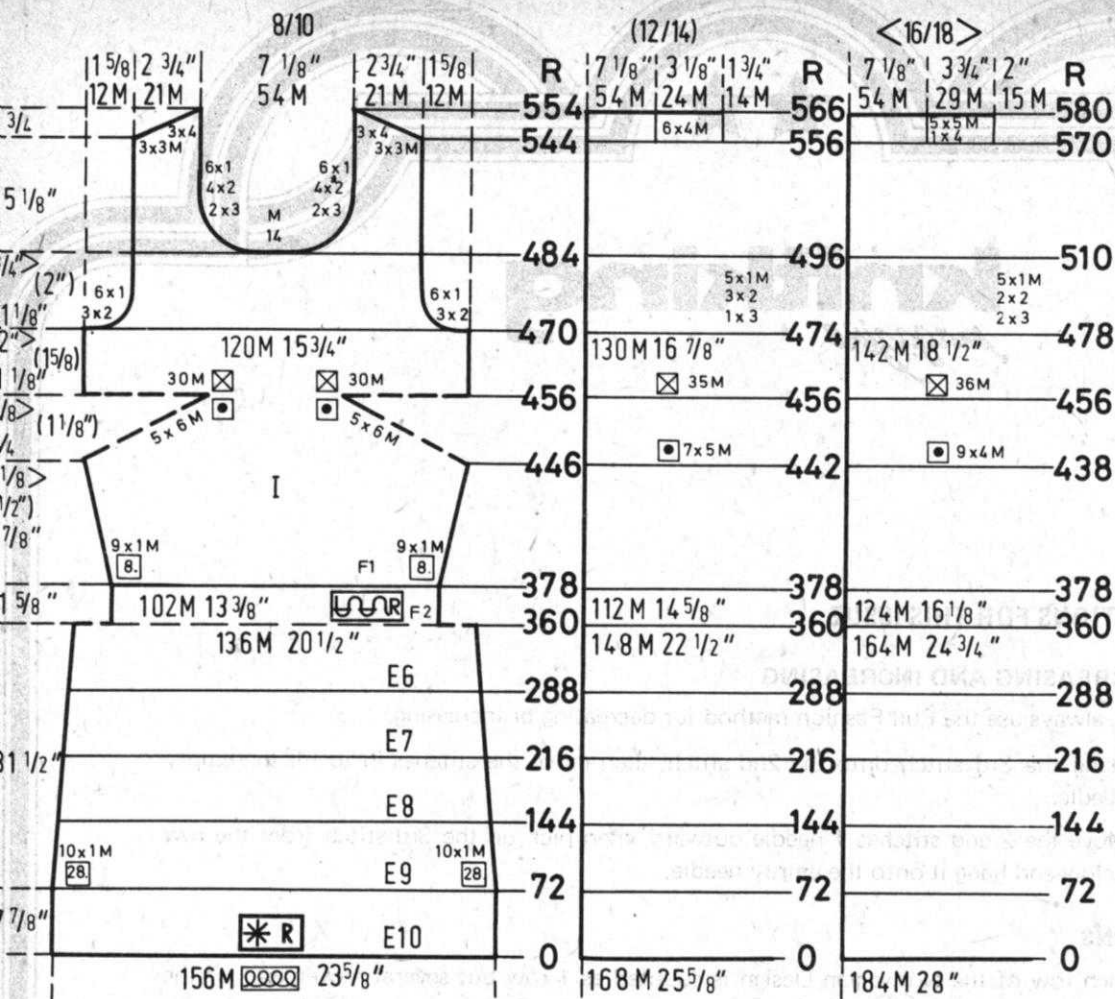

RESS FRONT: I

Work the front the same as the back to Row 360 then work Bust Darts using Short Rows. **OPPOSITE SIDE OF CAM BOX**, put into holding position
 sts. 5x ON EACH SIDE
 sts. 7x ON EACH SIDE)
 sts. 9x ON EACH SIDE)
 Bring all the needles back into working position before knitting the next 2 rows then move to Row 470 (474) [478]
SHAPE ARMHOLE: ON EACH SIDE bind off
 sts. 3x, 1 st. 6x
 sts. 1x, 2 sts. 3x, 1 st. 5x)
 sts. 2x, 2 sts. 2x, 1 st. 5x)
 After Row 484 (496) [510] **SHAPE NECK**

Bind off the center 14 sts. put the needles on the left into holding position and complete the right half first.
 *ON NECK SIDE bind off 3 sts. 2x, 2 sts. 4x, 1 st. 6x and **SHAPE SHOULDER** after Row 544 (556) [570] bind off
 3 sts. 3x, 4 sts. 3x
 (4 sts. 6x)
 [4 sts. 1x, 5 sts. 5x]
 Move the Cam Box to the left, turn the Row Counter back to 484 (496) [510] and complete the left half. Follow the instructions from *.

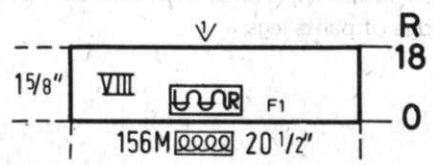
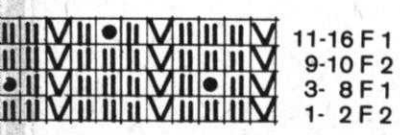

BAND: VIII
 Cast on 156 sts. with color 1 and work 18 rows Stockinette stitch then bind off.

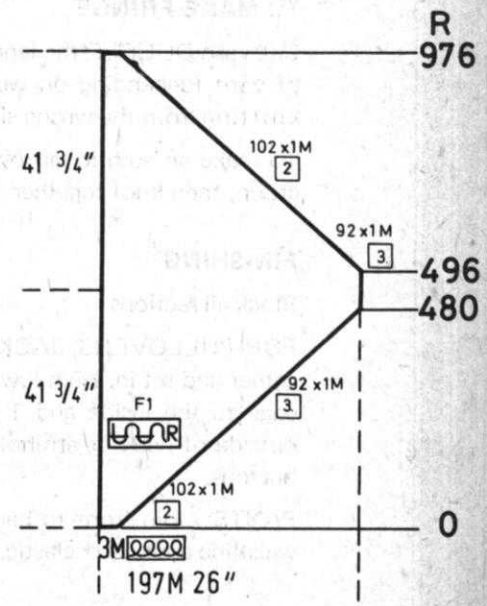

SHAWL:
 Cast on 3 sts. with color 1 and work in Stockinette stitch. Increase 1 st. every 2nd row 102x, then every 3rd row 9x
 After Row 496, decrease 1 st. every 3rd row 92x, every 2nd row 102x. After Row 976, bind off 3 sts.



knitking

magazine

GENERAL INSTRUCTIONS FOR THIS ISSUE

FULL FASHION DECREASING AND INCREASING

For Stockinette stitch, always use the Full Fashion method for decreasing or increasing.

TO DECREASE: Hang the 3rd stitch onto the 2nd stitch, then move the stitches in to fill the empty needle.

TO INCREASE: Move the 2 end stitches 1 needle outward, then pick up the 3rd stitch from the row below and hang it onto the empty needle.

NORWEGIAN DESIGNS

In the instructions, each row of the Norwegian Design is counted as 1 row but several movements of the Cam Box are needed to complete 1 row.

TO MAKE FRINGE

Cut yarn **DOUBLE** the length of fringe desired (wind around a cardboard or book). Using 2 or more strands of yarn (depending on weight of yarn), fold in half and with a crochet hook, draw folded loop through knitting from the wrong side. Pull strands through loop and tighten.

To make an additional row of knots on fringe, take half the strands from 1 group and half from the next group, then knot together approximately 1" to 2" below and continue across.

FINISHING

Block all sections.

FOR PULLOVERS, JACKETS AND DRESSES: Join front to back at sides and shoulders. Sew sleeves together and set in. Hem lower edge and sleeve edges if needed. For a double neckband or armhole band, sew 1 edge to the inside and 1 to the outside of neck or armhole. For a single ribbed band, sew 1 edge to the outside of neck or armhole edge. For a Cardigan or Jacket with buttonholes, finish buttonholes and sew on buttons.

PANTS: Join front to back at sides. Sew inside leg seams, then join center, front and back. Make hem at waistline and insert elastic. Hem lower edge of pants legs.





knitking

ACCESSORY PRICE LIST

	PRICE	SHIPPING		PRICE	SHIPPING
WHIZ KING PATTERN READER	\$59.50	\$ 2.50	Reversing Bar (197 Needle KNIT-		
Increase-Decrease Compensator ..	27.50	2.00	KING Machine only	\$ 27.50	\$ 1.75
3-Color Yarn Feeder	22.50	1.50	Converta Tape (for Charting Pat-		
Pattern Stitch Cards for AM 3			terns to size)	9.50	.60
KNITKING Machine only -			Fluorescent Magnifying Lamp with		
#17 to #48	9.50	1.25	5 inch lens and adjustable 45		
Weaving Accessory for AM 3			inch extension arm (specify		
KNITKING only	8.95	.80	table clamp or wall Fitting) . . .	57.95	3.00
Adjustable Needle Selector			JAC 40 (KNITKING Machine only)	29.50	1.50
(33 Needle)	4.25	.60	JAC 40 Punch Cards, Please give		
Cam Wheels for AM 3 KNITKING			alternate numbers . . . Each	.95	.15
Machine only	1.00	.10	Strap for JAC 40	2.00	.30
Knitting Table (suitable for all			KNITKING Instruction Book		
machines	44.95	F.O.B.	(specify machine)	4.00	.50
KNITKING Metal Table	39.50	F.O.B.	1 Year Subscription to KNITKING		
Treble Transfer Tool (pair)	2.00	.50	MAGAZINE (6 issues)	10.00 (no tax)	
Multiple Transfer Tool (33 needle)	3.95	.60	Canada	12.00	
Double Transfer Tool (pair)	1.80	.50	Back Issues of KNITKING MAGAZINE		
Transfer Tools (1 each - 4 needle			SINGLE COPY (thru Vol. 10) Ea.	1.50	Postpaid
and 6 needle)	2.95	.50	After Vol. 11 No. 1 . . . Each	3.00	Postpaid
Combined Latch Needle & Transfer			Complete 6th or 7th or 8th or 9th		
Tool	1.50	.25	or 10th Bound Volume of		
Combined Work Hook & Transfer			KNITKING MAGAZINE (6		
Tool	1.50	.25	issues bound in Plastic Cover) Ea.	7.95	1.15
Knitting Machine Needles for			KNITKING Yarn Catalogue	1.00	Postpaid
KNITKING Machines only . .	.35	.10	KNITKING Carrying Bags (2-piece)		
Ribbing Attachment Needles for			AM 3 and Cam Box	29.50	1.75
KNITKING Ribbers only45	.10	KNITKING Carrying Bag (for		
Ribber Transfer Needles35	.10	Ribber only)	15.50	1.00
Strippers for KNITKING Ribber (pr)	.95	.25			
KNITKING Sinker & Spring (specify					
Machine No.)20	.15			
Shipping for 2035			
Yarn Winder with 'Waxamajig' and					
Skein Holder	23.95	1.75			
Wax Spools30	.20			
OR 4 for	1.00	.40			

Sorry, No C.O.D.'s or Billings, Please send money with your order. California Residents please add Sales Tax.

Price Lists prior to this date are obsolete.

KNITKING, INC.

1128 Crenshaw Blvd., Los Angeles, California 90019



DK 13

EVENING DRESS AND TRIANGLE SHAWL

SIZE: 12/14 (16/18) [20/22]

YARN: C1 Amore grams 1050 1100 1150

C2 Melodie grams 400 450 500

E Stock: 7 to 9

Pattern: 10

P Stock: 15 sts., 23 rows = 2"

Pattern: 13 sts., 18 rows = 2"

DRESS BACK: II

Bring 172 (188) [196] needles into working position then set in Pattern and cast on. With Tension 10 knit to Row 68, change to Tension 9 and ON EACH SIDE, decrease 1 st. every 26th row 10x and change to Tension 8 after Row 136; change to Tension 7 after Row 204, change to Tension 6 after Row 272. After Row 340, take the sts. off onto a stitch holder then hang them back onto the machine decreasing to 114 (126) [144] sts. Continue in Stockinette stitch with color 2 to Row 364, change to color 1 and ON EACH SIDE increase 1 st. every 8th row 9x then knit to Row 442 and SHAPE ARM-HOLE ON EACH SIDE bind off
 3 sts. 2x, 2 sts. 3x, 1 st. 3x
 (4 sts. 2x, 2 sts. 3x, 1 st. 4x)
 [4 sts. 2x, 3 sts. 2x, 2 sts. 2x, 1 st. 5x]
 Knit to Row 498 (506) [512] then divide in center for neck opening

Put the needles on the left into holding position and complete the right half first.

*Knit to Row 526 (534) [540] then SHAPE SHOULDER AND NECK AT THE SAME TIME.

Bind off

FOR SHOULDER

3 sts. 5x, 4 sts. 3x

(3 sts. 2x, 4 sts. 6x)

[4 sts. 6x, 5 sts. 2x]

FOR NECK

8 sts. 1x, 5 sts. 2x, 3 sts. 2x

Same as above

Same as above

Move the Cam Box to the left, turn the Row Counter back to 498 (506) [512] and complete the left half. Follow the instructions from *.

Dress sleeves and Shawl Stockinette stitch. Dress front and back a Holding Position Design with needles out of work that ARE COUNTED in the stitch gauge and instructions. The Knit side is the right side. Follow the Line Drawing and use the Adjustable Needle Selector.

FINISHING:

See General Instructions. Single crochet around the edges of Shawl then attach trim (see General Instructions) with color 2.

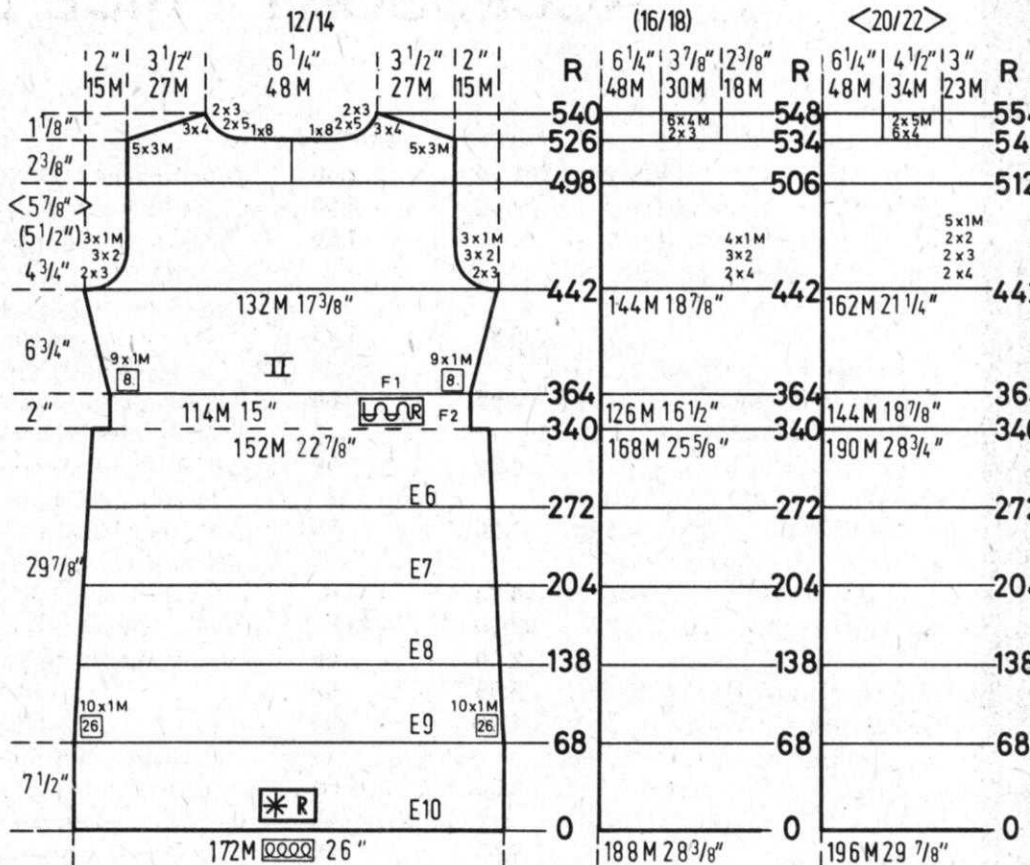

SLEEVE: III

Cast on 54 (60) [69] sts. with color 1 and work Stockinette stitch to Row 28. Form the hem.

ON EACH SIDE increase 1 st. every 8th row 16x, every 6th row 8x

After Row 204 SHAPE CAP

ON EACH SIDE bind off

3 sts. 3x, 2 sts. 4x, 1st. 19x, 2 sts. 2x,

3 sts. 2x

(3 sts. 4x, 2 sts. 3x, 1 st. 21x, 2 sts. 2x,

3 sts. 2x)

[4 sts. 2x, 3 sts. 2x, 2 sts. 3x, 1 st. 23x,

2 sts. 2x, 3 sts. 2x]

After Row 264 (268) [272] bind off the remaining 10 (10) [11] sts.

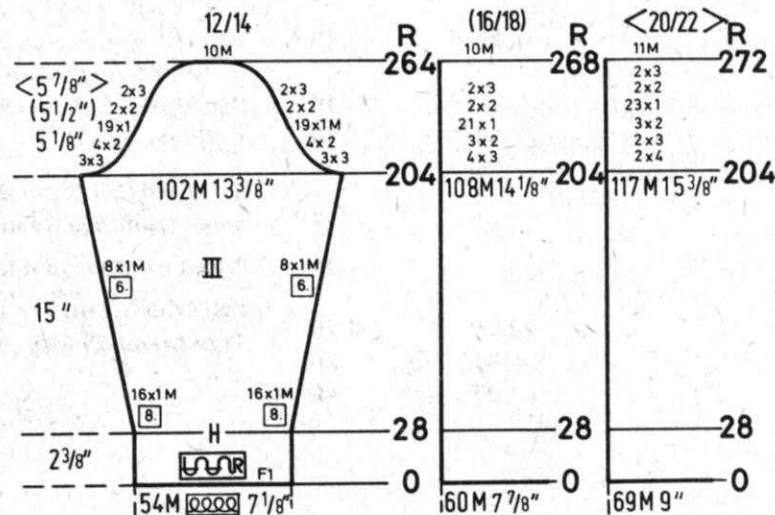

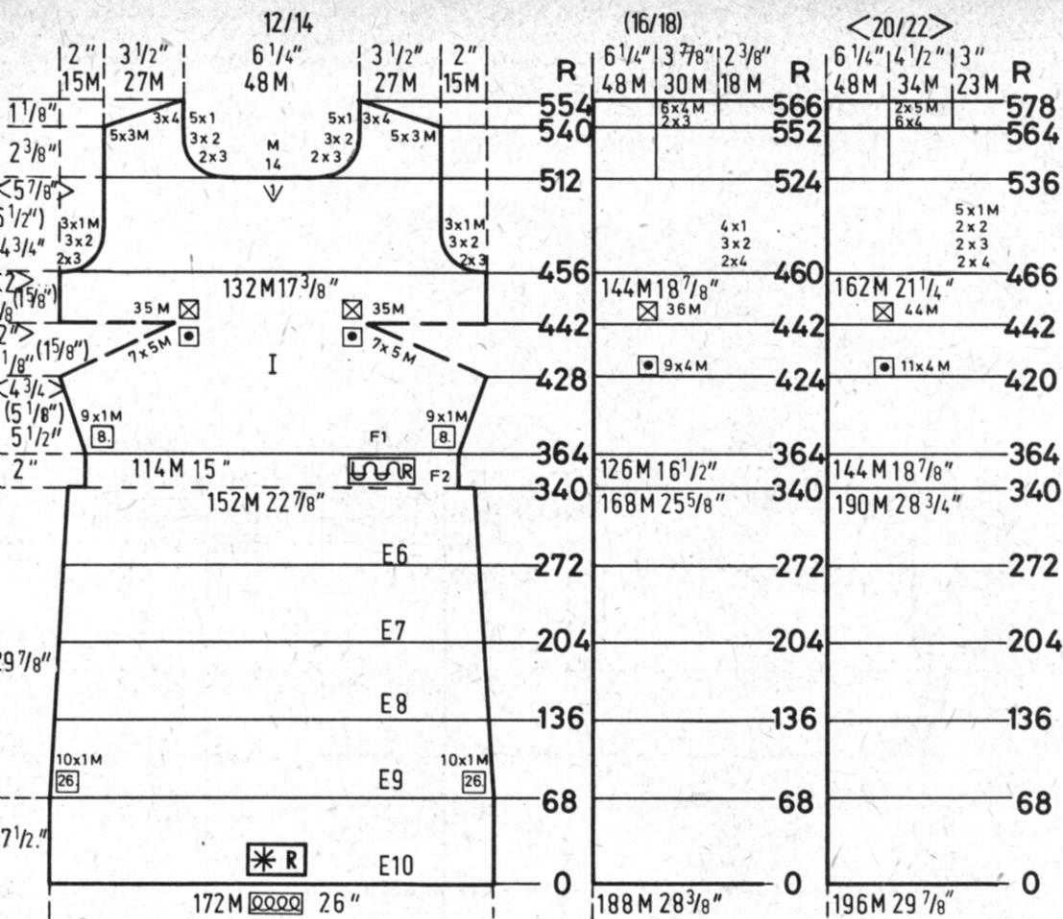

11-16 F 1
9-10 F 2
3- 8 F 1
1- 2 F 2

FRONT: I

Knit the front section the same as the back to Row 428 (424) [420] then work Short Rows for the Bust Dart.
ON OPPOSITE SIDE OF CAM BOX put into holding position
5 sts. 7x ON EACH SIDE
(4 sts. 9x ON EACH SIDE)
[4 sts. 11x ON EACH SIDE]
Bring all the needles back into working position before knitting the next 2 rows.
Knit to Row 456 (460) [466] then SHAPE ARMHOLE ON EACH SIDE bind off
(3 sts. 2x, 2 sts. 3x, 1 st. 3x)
(4 sts. 2x, 2 sts. 3x, 1 st. 4x)
[4 sts. 2x, 3 sts. 2x, 2 sts. 2x, 1 st. 5x]
Knit to Row 512 (524) [536] SHAPE NECK Bind off the center 14 sts. put the needles on the left side into holding position and complete the right half first.
ON NECK SIDE bind off 3 sts. 2x, 2 sts. 3x, 1 st. 5x and
*SHAPE SHOULDER after Row 540 (552) [564] bind off
3 sts. 5x, 4 sts. 3x
(3 sts. 2x, 4 sts. 6x)
[4 sts. 6x, 5 sts. 2x]
Move the Cam Box to the left, turn the Row Counter back to 540 (552) [564] and complete the right half. Follow the instructions from *.

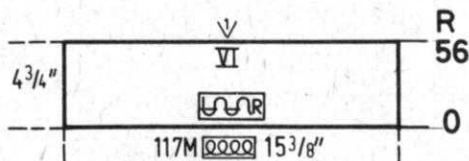
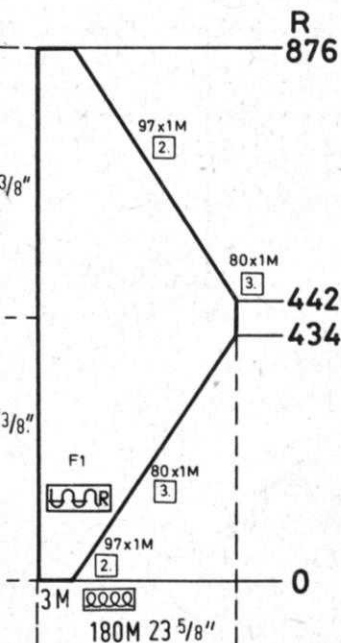

COLLAR:

Cast on 117 sts. and work 56 rows Stockinette stitch then bind off.

ADJUSTABLE NEEDLE SELECTOR

Suitable for KNITTING Machines only. The Adjustable Needle Selector can be set to any needle spacing and is the perfect Tool to use with many of the Patterns in this issue of KNITTING MAGAZINE.

Price: \$ 4.25 Shipping: \$.60
California residents add Sales Tax.

HAWL

Cast on 3 sts. with color 1 and work Stockinette stitch. Increase 1 st. every 2nd row, every 3rd row 80x. After Row 442, decrease 1 st. every 3rd row 80x, every 2nd row 97x. After Row 876 bind off 3 sts.

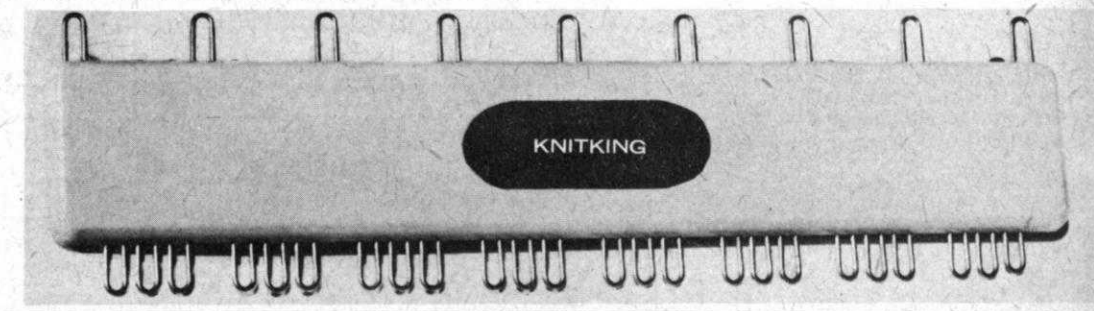

DK 14

EVENING DRESS AND TRIANGLE SHAWL

SIZE: 10/12 (14/16) [18/20]

YARN: C1 Amore grams 1000 1050 1100

C2 Melodie grams 400 450 500

E Stock: 7 to 9

Pattern: 10

P Stock: 15 sts., 23 rows = 2"

Pattern: 13 sts., 18 rows = 2"

BACK: II

Bring 164 (180) [192] needles into working position then set into Pattern. Cast on. With Tension 10, knit to Row 72 then change to Tension 9 and ON EACH SIDE decrease 1 st. every 28th row 10x and change to Tension 8 after Row 144, change to Tension 7 after Row 216, change to Tension 6 after Row 288. After Row 360 remove the sts. onto a stitch holder then hang them back decreasing to 108 (120) [138] sts. Change to Stockinette stitch and color 2. Knit to Row 392 and change to color 1. ON EACH SIDE increase 1 st. every 8th row 6x, every 6th row 3x. After Row 456 SHAPE ARMHOLE: ON EACH SIDE bind off
3 sts. 2x, 2 sts. 2x, 1 st. 4x
(4 sts. 2x, 2 sts. 3x, 1 st. 3x)
[4 sts. 2x, 3 sts. 2x, 2 sts. 1x, 1 st. 5x]
Knit to Row 526 (530) [538]
SHAPE NECK: Bind off the center 26 sts. put the needles on the left into holding position and complete the right half first.
*ON NECK SIDE bind off 3 sts. 3x, 2 sts. 4x and AT THE SAME TIME SHAPE SHOULDER after Row 536 (540) [548] bind off
3 sts. 5x, 4 sts. 1x
(3 sts. 2x, 4 sts. 4x)
[4 sts. 3x, 5 sts. 3x]
Move the Cam Box to the left, turn the Row Counter back to 536 (540) [548] and complete the left half. Follow the instructions from *.

SLEEVE: III

Cast on 78 (83) [91] sts. with color 1 and work Stockinette stitch to Row 18 then set up in Pattern.
BOTH SIZES: ON EACH SIDE increase 1 st. every 6th row 4x.
After Row 44 SHAPE CAP
ON EACH SIDE bind off
4 sts. 1x, 3 sts. 2x, 2 sts. 2x, 1 st. 14x,
2 sts. 1x, 4 sts. 2x
(4 sts. 1x, 3 sts. 2x, 2 sts. 2x, 1 st. 16x,
2 sts. 1x, 4 sts. 2x)
[4 sts. 2x, 3 sts. 1x, 2 sts. 2x, 1 st. 18x,
2 sts. 1x, 4 sts. 2x]
After Row 88 (92) [96] bind off the remaining 10 (11) [13] sts.

Dress: Stockinette stitch and a Holding Position Design with out of work needles that ARE COUNTED in the stitch gauge and instructions. Shawl: Stockinette stitch. Follow the Line Drawing and use the Adjustable Needle Selector. All worn on the Knit side.

FINISHING:

See General Instructions. Single crochet around edges of Shawl then attach Fringe (see General Instructions) with color 2.

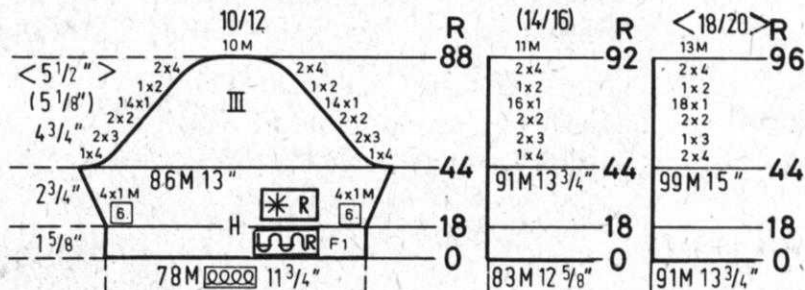
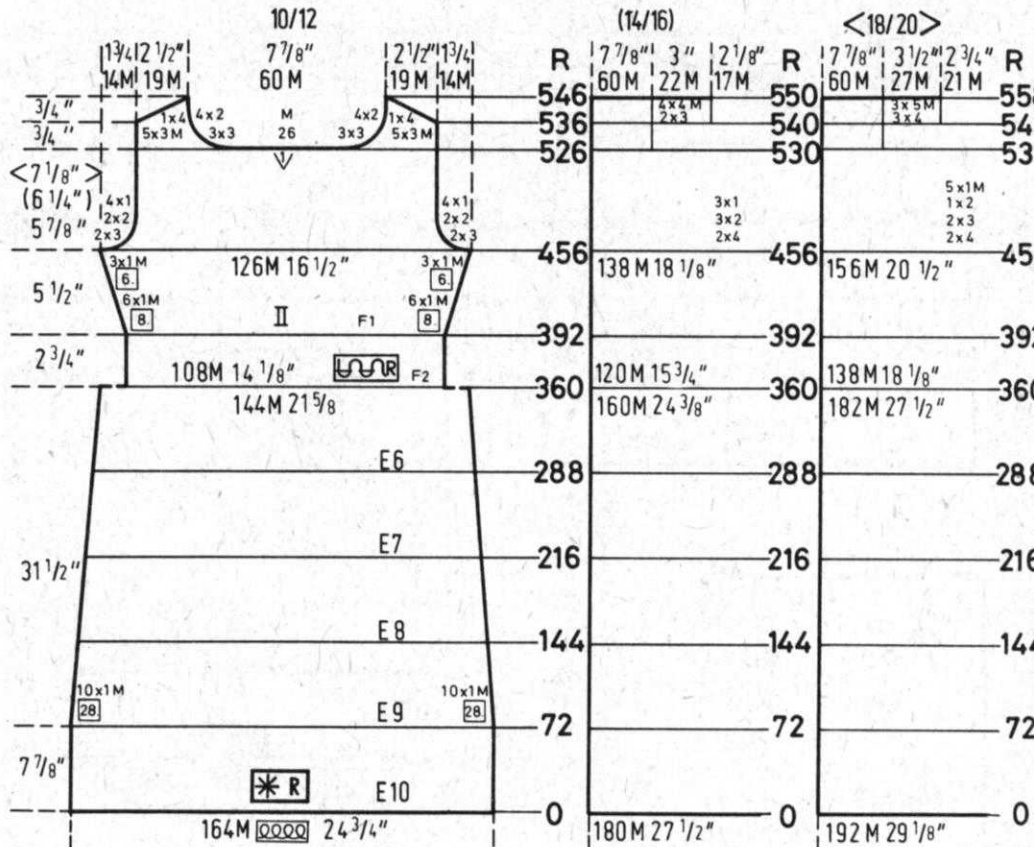

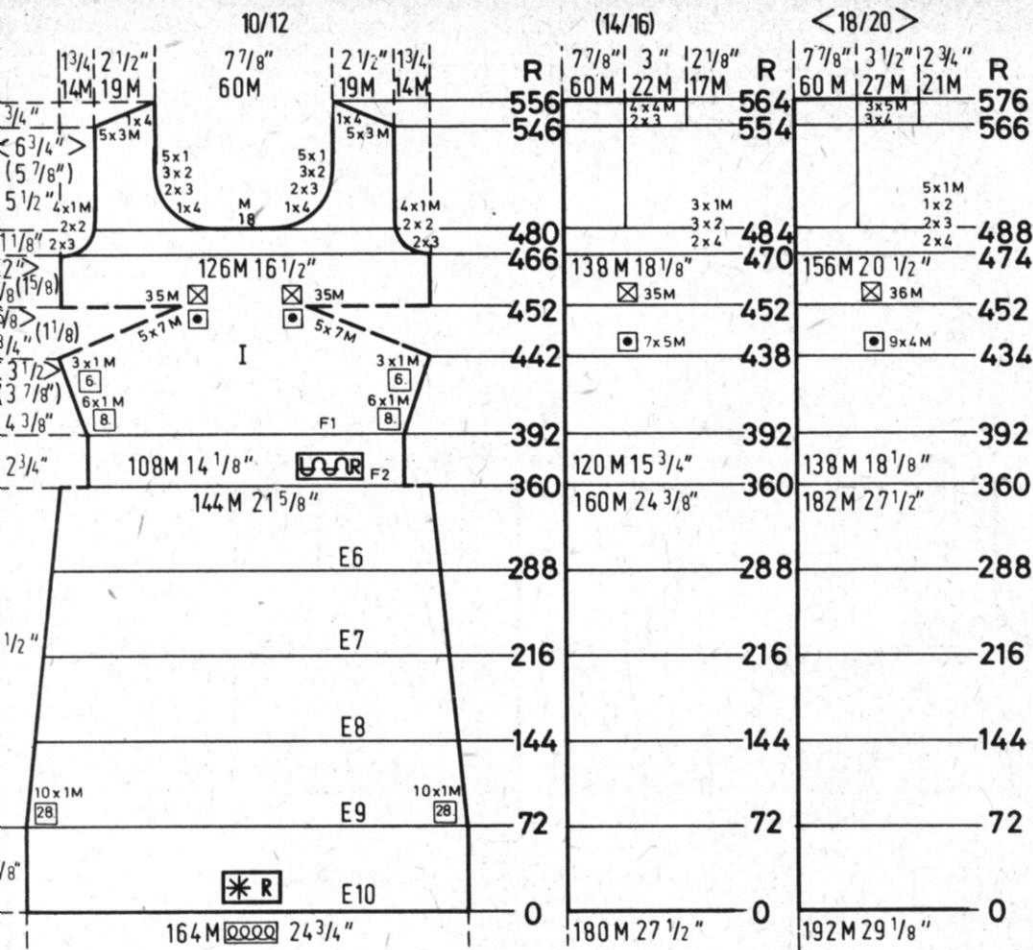

FRONT: I

Work the front the same as the back to Row 442 (438) [434] then work Short Rows for the Bust Darts.
 ON OPPOSITE SIDE OF CAM BOX put into holding position
 7 sts. 5x
 (5 sts. 7x)
 (4 sts. 9x)
 Bring all the needles back into working position before knitting the next 2 rows.
 Knit to Row 466 (470) [474]
 ON EACH SIDE bind off
 3 sts. 2x, 2 sts. 2x, 1 st. 4x
 SHAPE NECK AT 480
 (4 sts. 2x, 2 sts. 3x, 1 st. 3x)
 SHAPE NECK AT 484
 (4 sts. 2x, 3 sts. 2x, 2 sts. 1x, 1 st. 5x)
 SHAPE NECK AT 488
 For NECK SHAPING bind off the center 18 sts. put the needles on the left into holding position and complete the right half first.
 *ON NECK SIDE bind off 4 sts. 1x, 3 sts. 2x, 2 sts. 3x, 1 st. 5x and SHAPE SHOULDER after Row 546 (554) [566] bind off
 3 sts. 5x, 4 sts. 1x
 (3 sts. 2x, 4 sts. 4x)
 (4 sts. 3x, 5 sts. 3x)
 Move the Cam Box to the left side, turn the Row Counter back to 480 (484) [488] and complete the left half. Follow the instructions from *.

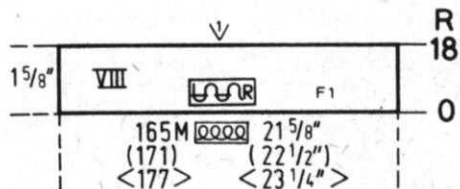
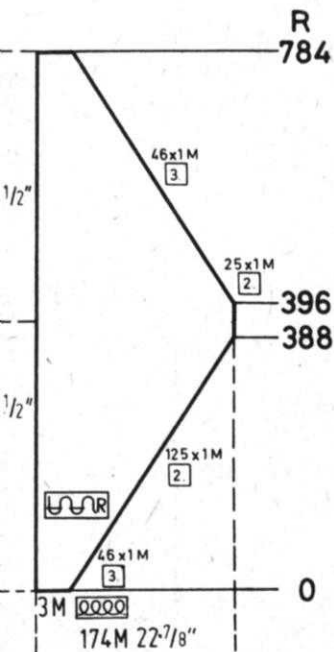

BAND: VIII

Cast on 165 (171) [177] sts. with color 1 and work 18 rows Stockinette stitch then bind off.

ADJUSTABLE NEEDLE SELECTOR

Suitable for KNITTING Machines only. The Adjustable Needle Selector can be set to any needle spacing and is the perfect Tool to use with many of the Patterns in this issue of KNITTING MAGAZINE.

Price: \$ 4.25 Shipping: \$.60
 California residents add Sales Tax.

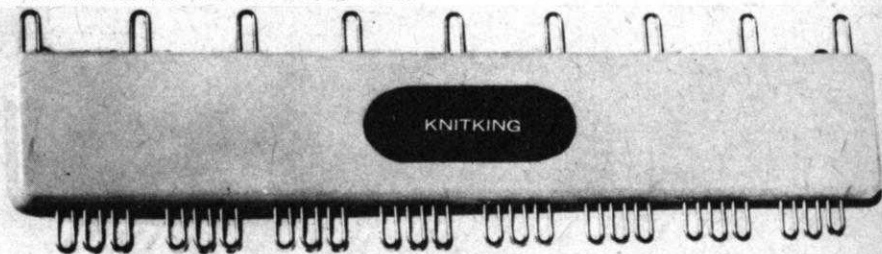

RAWL:

Cast on 3 sts. Work Stockinette sttitch.
 Increase 1 st. every 3rd row 46x then every 4th row 125x
 After Row 396 decrease 1 st. every 2nd row 5x, every 3rd row 46x. After Row 784 bind off 3 sts.

DK 15

EVENING DRESS AND TRIANGLE SHAWL

SIZE: 7/8 (10/12) [14/16]

YARN: Melodie grams 1350 1400 1450

E Stock: 5 to 7

Pattern: 8 to 9

P Stock: 16 sts., 24 rows = 2"

Pattern: 14 sts., 22 rows = 2"

Stockinette stitch and a Holding Position Design with out of work needles that ARE COUNTED in the stitch gauge and instructions. Follow the Line Drawing and use the Adjustable Needle Selector. The purl side is the right side for all Pattern sections, the knit side for all Stockinette stitch.

FINISHING:

See General Instructions. Gather Skirt at waist then sew to bodice. Gather lower edge of sleeve cap then sew to top of lower sleeve Single crochet around edges of Shawl then attach Fringe (See General Instructions and picture). Make loops of chain 5, sc into edge around neckline and sleeves.

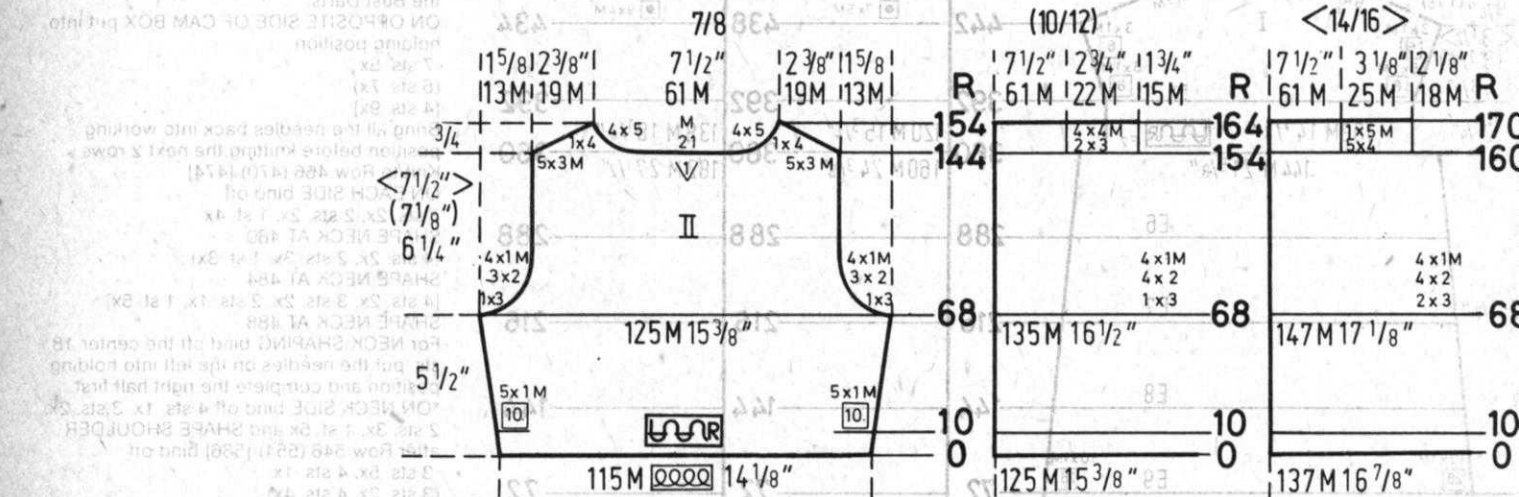

BODICE BACK: II

Cast on 115 (125) [137] sts. and work Stockinette stitch. After Row 10 ON EACH SIDE increase 1 st. every 10th row 5x After Row 68 SHAPE ARMHOLE ON EACH SIDE bind off 3 sts. 1x, 2 sts. 3x, 1 st. 4x (3 sts. 1x, 2 sts. 4x, 1 st. 4x) [3 sts. 2x, 2 sts. 4x, 1 st. 4x] Knit to Row 144 (154) [160]. Bind off the center 21 sts. put the needles on the left into holding position and complete the right half first.

*SHAPE SHOULDER AND NECK AT THE SAME TIME bind off FOR SHOULDER 3 sts. 5x, 4 sts. 1x (3 sts. 2x, 4 sts. 4x) [4 sts. 5x, 5 sts. 1x] FOR NECK 5 sts. 4x Same as above Same as above

Move the Cam Box to the left side, turn the Row Counter back to 144 (154) [160] and complete the left half. Follow the instructions from *.

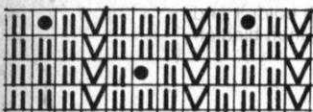

11-16
9-10
3-8
1-2

UPPER SLEEVE: III

Bring 28 (34) [40] needles into working position then set into Pattern. Cast on. ON EACH SIDE cast on 5 sts. 5x, 4 sts. 5x then knit to Row 58. SHAPE CAP: ON EACH SIDE bind off 3 sts. 3x, 2 sts. 19x, 3 sts. 2x (3 sts. 3x, 2 sts. 21x, 3 sts. 2x) [3 sts. 3x, 2 sts. 23x, 3 sts. 2x] After Row 106 (110) [114] bind off the remaining 12 (10)-[8] sts.

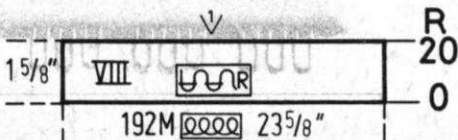
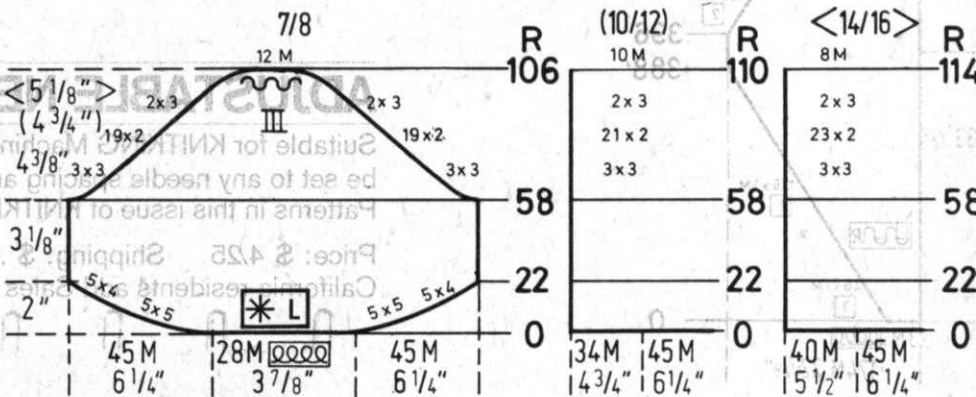

BAND: VIII

Cast on 192 sts. and work 20 rows Stockinette stitch then bind off.

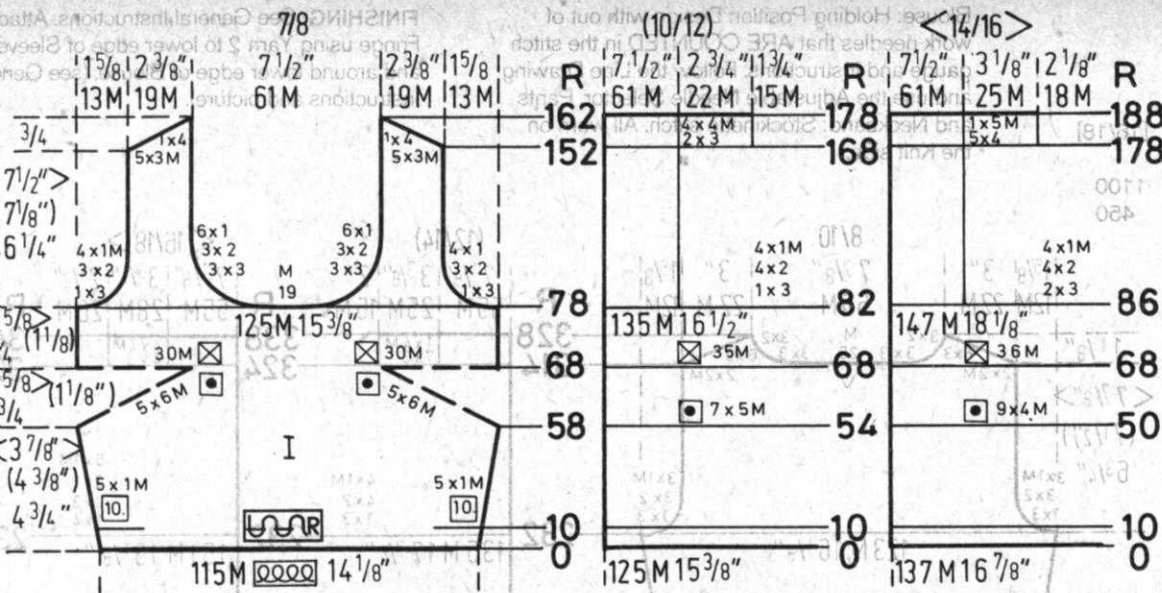

FINISHING: Hold the garment with out...
 1. 1000 1050
 2. 350 400
 3. 1500 1550
 4. 450 500

DICE FRONT: I

Work the front the same as the back to Row 54 [50] then work Short Rows for the Darts
 OPPOSITE SIDE OF CAM BOX put into working position
 5 sts. 5x ON EACH SIDE
 7 sts. 7x ON EACH SIDE
 9 sts. 9x ON EACH SIDE
 Bring all the needles back into working position before knitting the next 2 rows.
 Move to Row 78 (82) [86] bind off the center sts. put the needles on the left into working position and complete the right half
 *SHAPE ARMHOLE AND NECK AT THE SAME TIME bind off
 *R ARMHOLE

3 sts. 1x, 2 sts. 3x, 1 st. 4x
 (3 sts. 1x, 2 sts. 4x, 1 st. 4x)
 [3 sts. 2x, 2 sts. 4x, 1 st. 4x]
FOR NECK
 3 sts. 3x, 2 sts. 3x, 1 st. 6x
 Same as above
 Same as above
At Row 152 (168) [178] SHAPE SHOULDER
 bind off
 3 sts. 5x, 4 sts. 1x
 (3 sts. 2x, 4 sts. 4x)
 [4 sts. 5x, 5 sts. 1x]
 Move the Cam Box to the left side, turn the Row Counter back to 78 (82) [86] and complete the left half. Follow the instructions from *

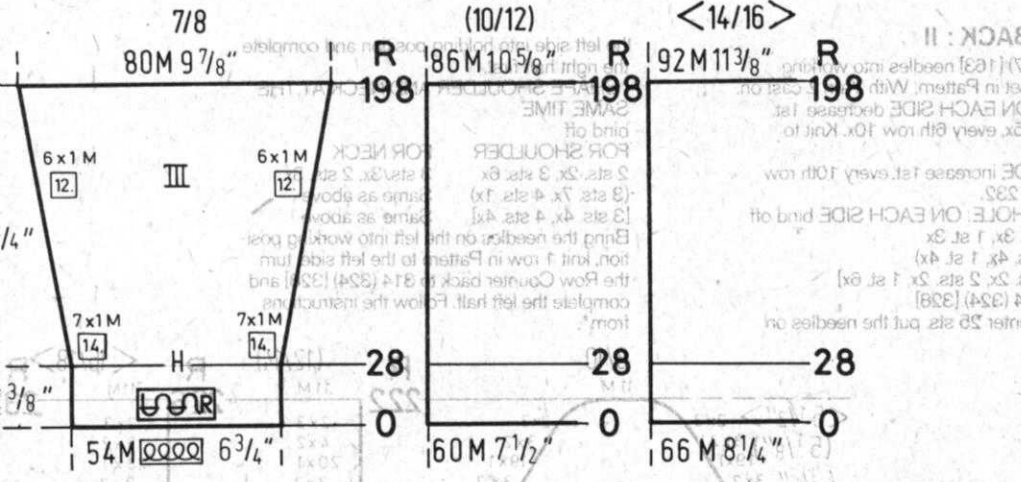
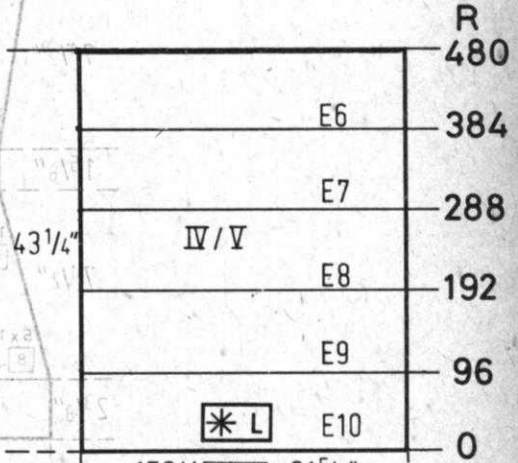

SKIRT FRONT AND BACK IV/V

Bring 153 (167) [183] needles into working position then set into Pattern. Cast on.
 With Tension 10 knit to Row 96
 With Tension 9 knit to Row 192
 With Tension 8 knit to Row 288
 With Tension 7 knit to Row 384
 With Tension 6 knit to Row 480
 then bind off.

POWER SLEEVE: III
 Cast on 54 (60) [66] sts. and work in Stockinette stitch. Knit to Row 28 then form the sleeve and ON EACH SIDE increase 1 st. every 14 rows 7x, every 12th row 6x. Knit to Row 198 and bind off 80 (86) [92] sts.

SHAWL:

Cast on 3 sts. and work in Pattern
 Increase 1 st every 2nd row 170x every 3rd row 10x
 After Row 378 decrease 1 st. every 3rd row 10x, every 2nd row 170x
 After Row 748 bind off 3 sts.

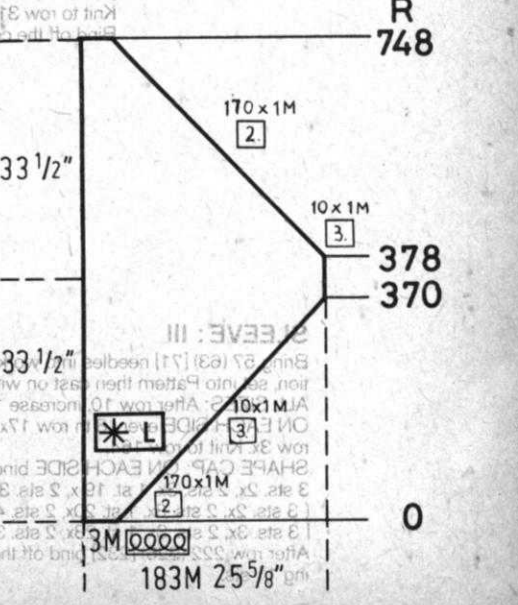

DK 16

PANTSUIT

SIZE: 8/10 (12/14) [16/18]

YARN:

1 Beatrice grams 1000 1050 1100
2 Melodie grams 350 400 450

E 7 to 9

P Stock 15 sts., 20 rows = 2"

Pattern 15 sts., 20 rows = 2"

Blouse: Holding Position Design with out of work needles that ARE COUNTED in the stitch gauge and instructions. Follow the Line Drawing and use the Adjustable Needle Selector. Pants and Neckband: Stockinette stitch. All worn on the Knit side.

FINISHING: See General Instructions. Att. Fringe using Yarn 2 to lower edge of Sleeve and around lower edge of Blouse. (see General Instructions and picture).

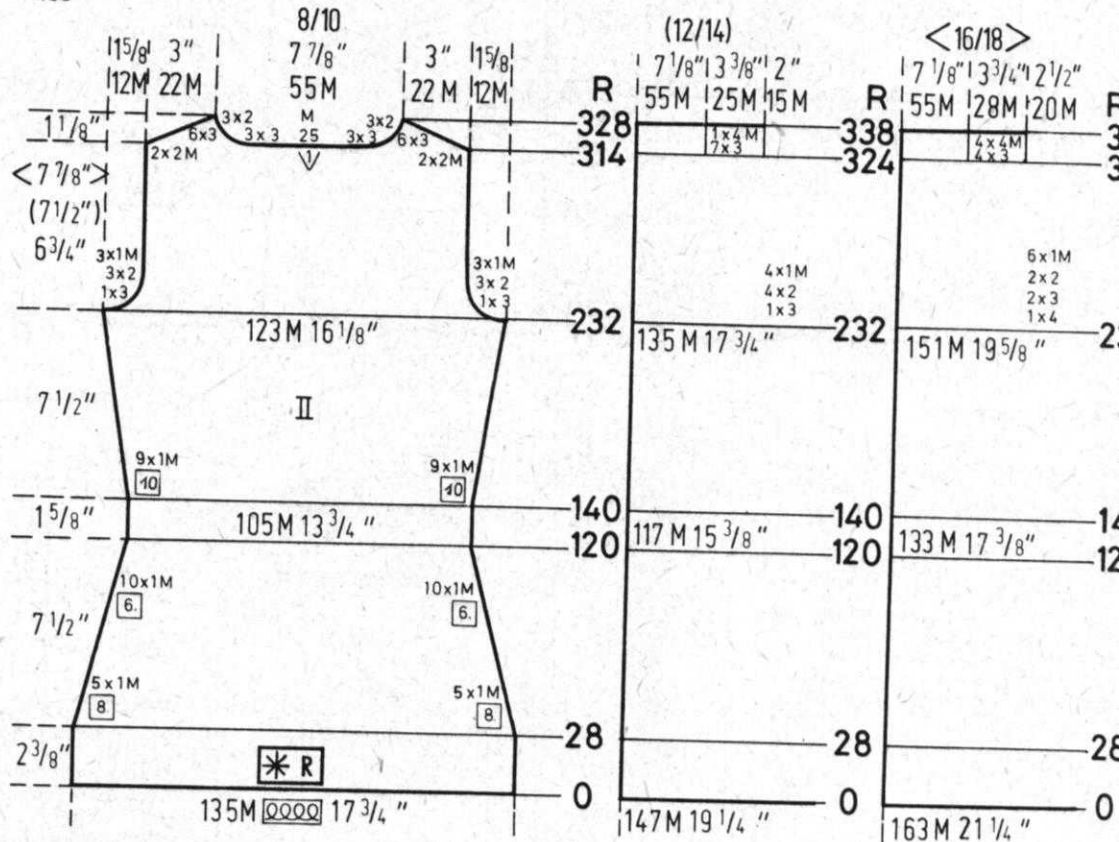

BLOUSE BACK : II

Bring 135 (147) [163] needles into working position then set in Pattern. With Yarn 2, cast on. After row 28 ON EACH SIDE decrease 1st. every 8th row 5x, every 6th row 10x. Knit to row 140.
ON EACH SIDE increase 1st. every 10th row 9x. Knit to row 232.
SHAPE ARMHOLE: ON EACH SIDE bind off 3 sts. 1x, 2 sts. 3x, 1 st. 3x (3 sts. 1x, 2 sts. 4x, 1 st. 4x) [4 sts. 1x, 3 sts. 2x, 2 sts. 2x, 1 st. 6x] Knit to row 314 (324) [328].
Bind off the center 25 sts. put the needles on

the left side into holding position and complete the right half first.
* SHAPE SHOULDER AND NECK AT THE SAME TIME
bind off
FOR SHOULDER FOR NECK
2 sts. 2x, 3 sts. 6x 3 sts. 3x, 2 sts. 3x
(3 sts. 7x, 4 sts. 1x) Same as above
(3 sts. 4x, 4 sts. 4x) Same as above
Bring the needles on the left into working position, knit 1 row in Pattern to the left side, turn the Row Counter back to 314 (324) [328] and complete the left half. Follow the instructions from*.

SLEEVE : III

Bring 57 (63) [71] needles into working position, set into Pattern then cast on with yarn 2.
ALL SIZES: After row 10, increase 1st.
ON EACH SIDE every 8th row 17x, every 6th row 3x. Knit to row 164.
SHAPE CAP: ON EACH SIDE bind off 3 sts. 2x, 2 sts. 3x, 1 st. 19x, 2 sts. 3x, 3 sts. 2x (3 sts. 2x, 2 sts. 3x, 1 st. 20x, 2 sts. 4x, 3 sts. 2x) [3 sts. 3x, 2 sts. 3x, 1 st. 23x, 2 sts. 3x, 3 sts. 2x] After row 222 (226) [232] bind off the remaining 11 sts.

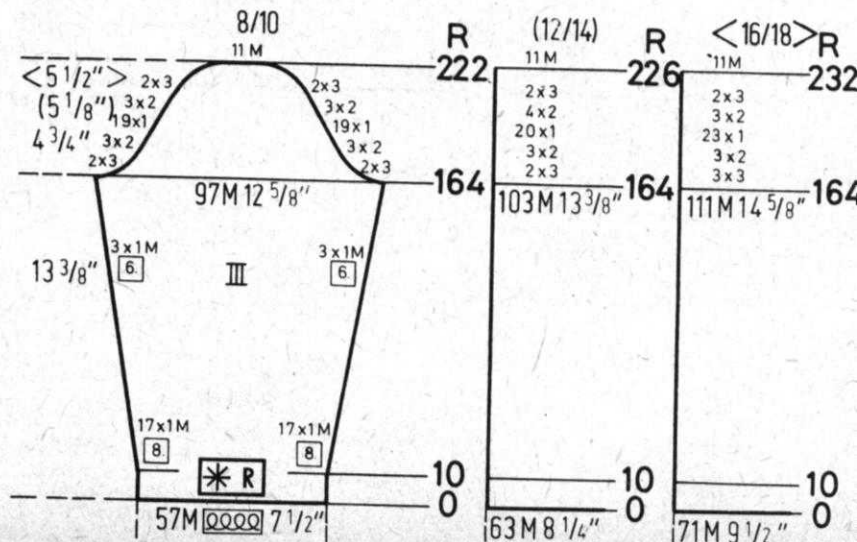

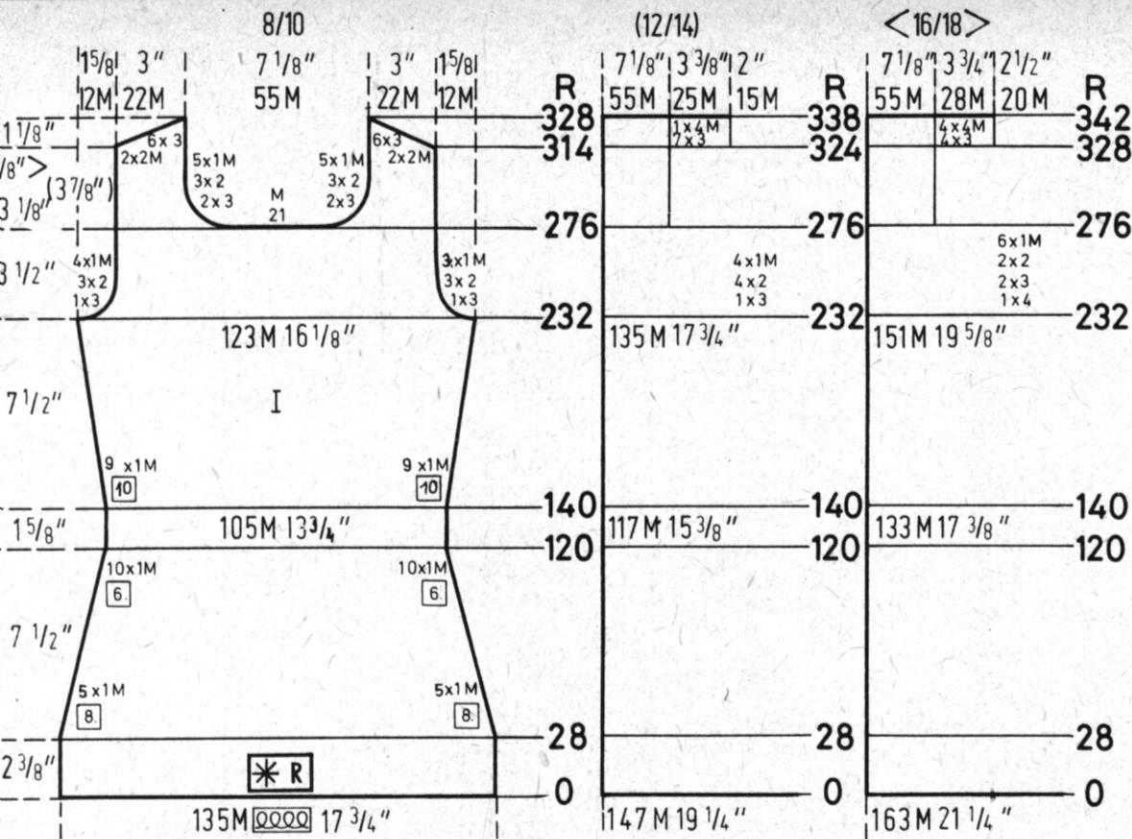

COUSE FRONT : I

knit the front section the same as the back section to row 276, bind off the center 21 sts. then reinsert the needles on the left into holding position and complete the right half first.

NECK SIDE bind off

2 sts. 2 sts. 3x, 1 st. 5x

SHAPE SHOULDER after row 314 (324) [328]

bind off

2 sts. 2x, 3 sts. 6x

(3 sts. 7x, 4 sts. 1x)

[3 sts. 4x, 4 sts. 4x]

Bring the needles on the left into working position, turn the Row Bouncer back to 276 and complete the left half. Follow the instructions from *.

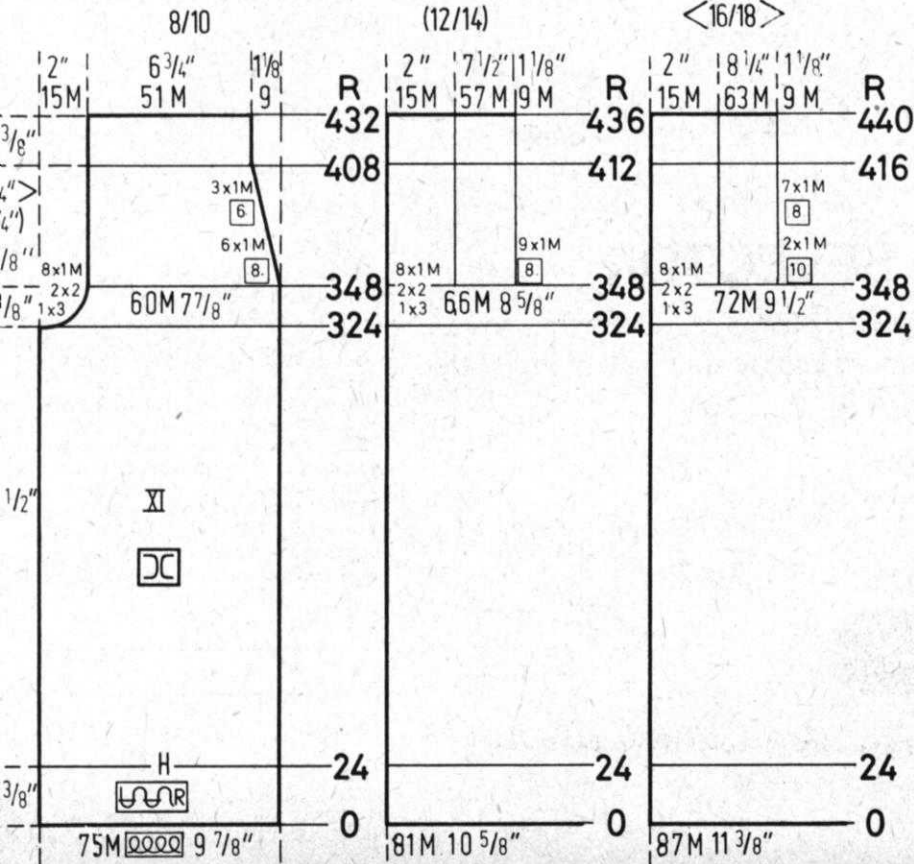
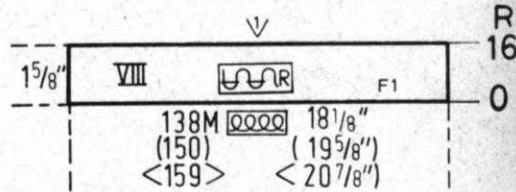

**PANTS FRONT : XI
(Make 1, reverse 1)**

Cast on 96 (102) [108] sts. and work

Stockinette stitch.

After row 24 form the hem, then knit to row 325.

SHAPE CROTCH ON ODD ROWS after row 325.

SHAPE SIDE EDGE ON EVEN ROWS after row 348.

BIND OFF FOR CROTCH

3 sts. 1x, 2 sts. 2x, 1 st. 8x

(3 sts. 1x, 2 sts. 2x, 1 st. 8x)

[3 sts. 1x, 2 sts. 2x, 1 st. 8x]

BIND OFF AT SIDE

1st. every 8th row 6x, every 6th row 3x

(1st. every 8th row 9x)

[1st. every 10th row 2x, every 8th row 7x]

Knit to row 432 then bind off all sts.

DK 16

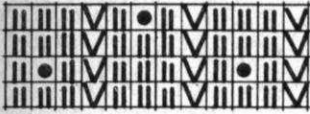

11-16 F1
9-10 F2
3- 8 F1
1- 2 F2

PANTS BACK : XII (Make 1, reverse 1)

Knit the back the same as the front to row 324, then SHAPE CROTCH ON EVEN ROWS and SHAPE SIDE EDGE ON ODD ROWS after row 341.

BIND OFF FOR CROTCH

4 sts. 1x, 3 sts. 2x, 2 sts. 5x, 1 st. 5x,
1 st. every 6th row 11x
(4 sts. 1x, 3 sts. 2x, 2 sts. 5x, 1 st. 5x,
1 st. every 6th row 11x)
[4 sts. 1x, 3 sts. 2x, 2 sts. 5x, 1 st. 5x,
1 st. every 6th row 11x]

BIND OFF AT SIDE

1 st. every 8th row 6x, every 6th row 3x
(1 st. every 8th row 9x)

[1 st. every 10th row 2x, every 8th row 7x]

After row 408 (412) [416] work Short Rows.

ON OPPOSITE SIDE OF CAM BOX put into holding position

11 sts. 4x (9 sts. 6x) [7 sts. 8x]

Bring all the needles back into working position before knitting the next 2 rows.

Knit to row 440 (448) [456] then bind off.

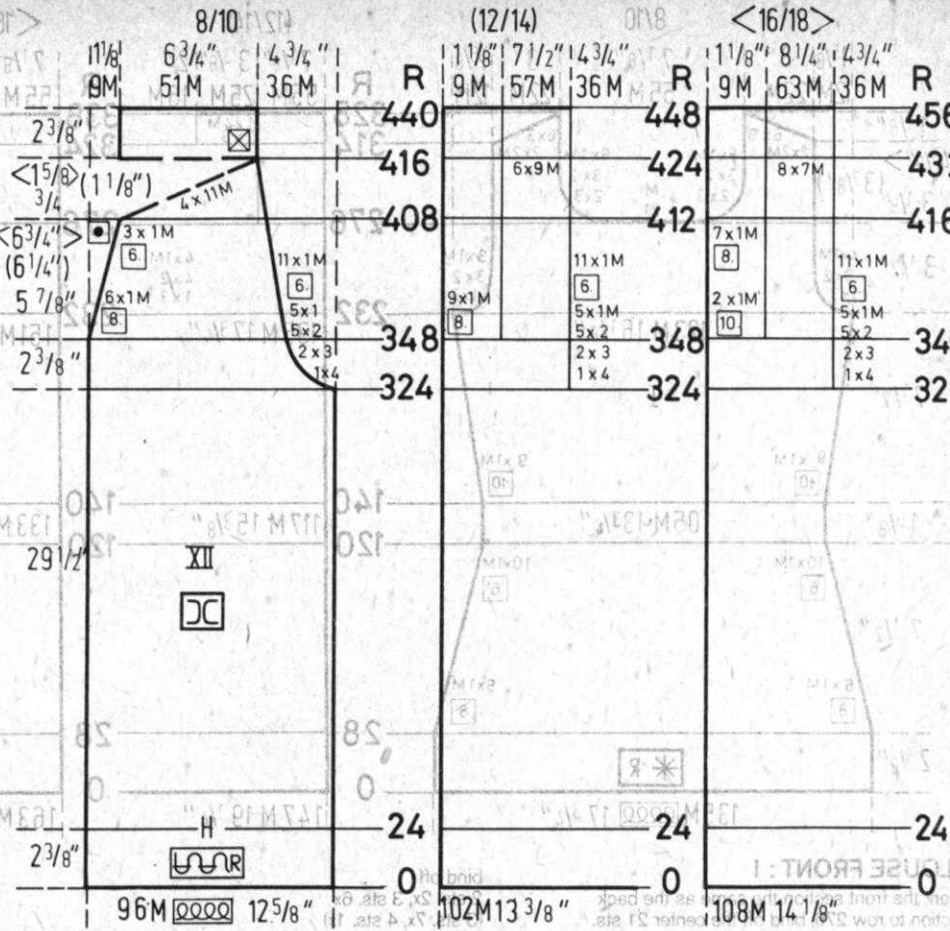

DK 17

COAT
SIZE: 7/8 (10/12) [14/16]
YARN: Subita grams 1000 1050 1100

- [E] 6 to 8
- [P] 15 sts., 20 rows = 2"

The Coat is a Mock Rib with needles out of work that ARE COUNTED in the stitch gauge and instructions. Follow the Line Drawing to set up

the needles then knit Stockinette stitch. The Collar and Cuffs are in crochet loops.
FINISHING: See General Instructions. Sew on Collar and Cuffs as shown in picture.

ADJUSTABLE NEEDLE SELECTOR

Suitable for KNITTING Machines only. The Adjustable Needle Selector can be set to any needle spacing and is the perfect Tool to use with many of the Patterns in this issue of KNITTING MAGAZINE.

Price: \$ 4.25 Shipping: \$.60
California residents add Sales Tax.

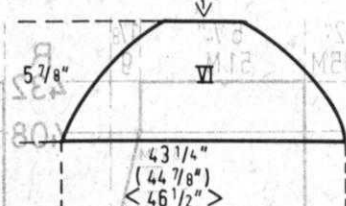
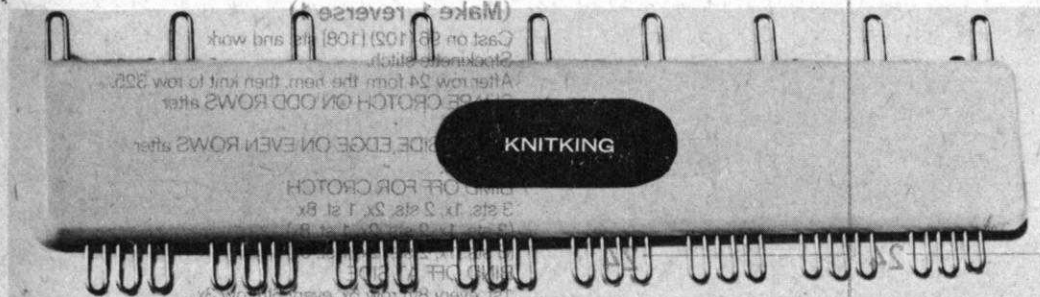

COLLAR: Crochet Hook No. 2 or 3
Make a chain 110 cm (114 cm) [118 cm] long (43 1/4" - 44 3/4" - 46 1/2"). Insert hook into 2nd ch, wrap yarn around 2 fingers, yarn over hook, pull loop through, yarn over, pull through 1 st. on hook, insert hook into same st. wrap yarn around 2 fingers, yarn over, pull through, yarn over hook, pull through all 3 sts. on hook. Make 2 loops into each ch stitch across * ch 1, turn, single crochet into each stitch, ch 1, turn. Make 2 loops into each st. across and REPEAT from * until center section measures 15 cm (6") and AT THE SAME TIME, shape each end after the 4th row by decreasing 1 st. at beginning and end of each row (see picture).

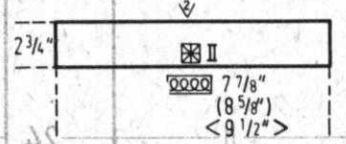

CUFF: Make a chain 20 cm (22 cm) [24 cm] (8" - 8 3/4" - 9 1/2") long. Work same as Collar for 3", but do not decrease at ends.

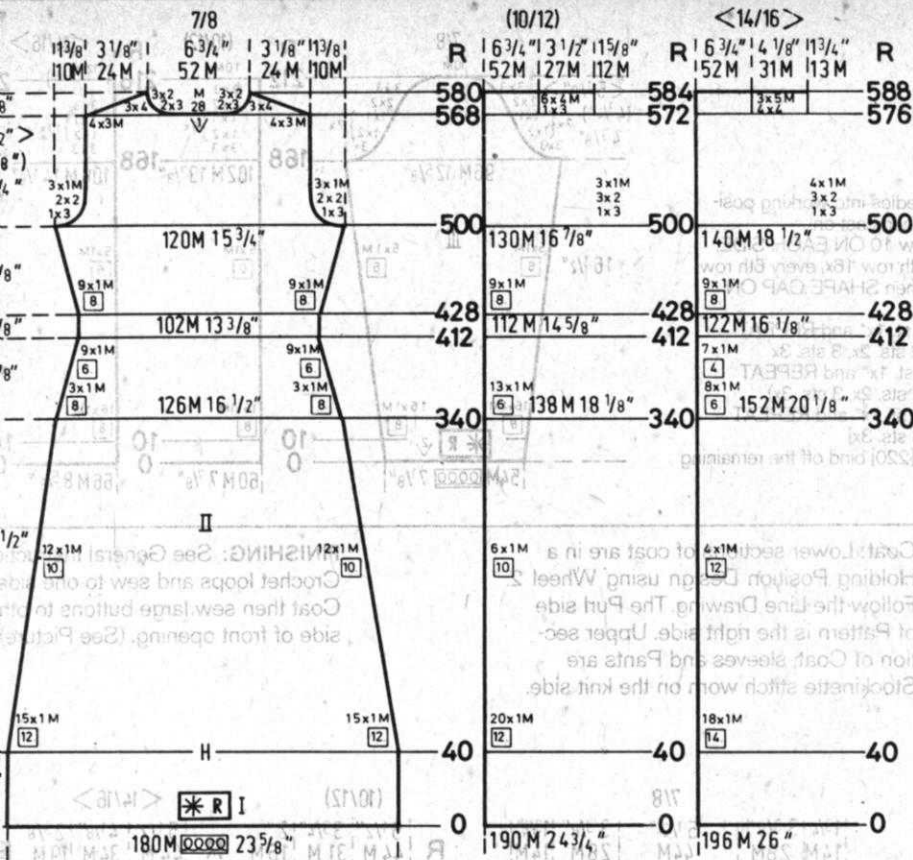

COAT BACK : II

Bring 180 (190) [196] needles into working position then set into Pattern. Cast on. After row 40 form the hem. ON EACH SIDE decrease 1 st. every 12th row 15x, every 10th row 12x (every 12th row 20x, every 10th row 6x) [every 14th row 18x, every 12th row 4x] ON EACH SIDE after row 340 decrease 1 st. every 8th row 3x, every 6th row 9x (every 6th row 13x) [every 6th row 8x, every 4th row 7x] Knit to row 428 ON EACH SIDE increase 1 st. every 8th row 9x. Knit to row 500 then SHAPE ARMHOLE: ON EACH SIDE bind off 3 sts. 1x, 2 sts. 2x, 1 st. 3x (3 sts. 1x, 2 sts. 3x, 1 st. 3x) [3 sts. 1x, 2 sts. 3x, 1 st. 4x] Knit to row 568 (572) [576]. Bind off the center 28 sts. put the needles on the left into holding position and complete the right half first. *SHAPE NECK AND SHOULDER AT THE SAME TIME, bind off FOR SHOULDER 3 sts. 4x, 4 sts. 3x (3 sts. 1x, 4 sts. 6x) [4 sts. 4x, 5 sts. 3x] FOR NECK 3 sts. 2x, 2 sts. 3x Same as above Same as above Bring the needles on the left into working position, knit 1 row in Pattern to the left side, turn the Row Counter back to 568 (572) [576] and complete the left half. Follow the instructions from *.

COAT FRONT : (Make 1 reverse 1 and omit the buttonholes)

Bring 90 (96) [103] needles into working position, set into Pattern. Cast on. After row 21, bring 30 more needles into working position, set into Pattern, then cast on. After row 40, form the hem. Decrease 1 st. at side edge every 12th row 11x, every 10th row 18x (every 12th row 10x, every 10th row 18x) [every 12th row 10x, every 18th row 18x] AND AT THE SAME TIME MAKE BUTTONHOLES over needles 3 to 7 and 24 to 28 counting from the left after rows 180, 228, 276, 324. After row 340, decrease 1 st. ON SIDE EDGE every 8th row 4x, every 6th row 8x (every 6th row 10x, every 4th row 4x) [every 6th row 8x, every 4th row 7x] AND AT THE SAME TIME MAKE BUTTONHOLE after row 372 Make BUTTONHOLE after row 420 and knit to row 428 ON FRONT EDGE, bind off 15 sts. (use separate strand of yarn to bind off), then SHAPE SIDE AND FRONT AT THE SAME TIME. Decrease 1 st. AT FRONT EDGE every 4th row 22x, every 6th row 11x (every 4th row 18x, every 6th row 15x) [every 4th row 14x, every 6th row 15x] ALL SIZES: increase 1 st. at SIDE EDGE every 8th row 3x, every 6th row 6x. AND AT THE SAME TIME, WORK SHORT ROWS FOR BUST DART after row 489 (485) [481] ON OPPOSITE SIDE OF CAM BOX, put into holding position Bring all the needles back into knitting position and knit to row 508 (512) [516] SHAPE ARMHOLE: Bind off 3 sts. 2x, 2 sts. 3x, 1 st. 4x (3 sts. 2x, 2 sts. 3x, 1 st. 6x) [3 sts. 2x, 2 sts. 4x, 1 st. 5x] SHAPE SHOULDER after row 576 (584) [592] Bind off 3 sts. 4x, 4 sts. 3x (3 sts. 1x, 4 sts. 6x) [4 sts. 3x, 5 sts. 4x]

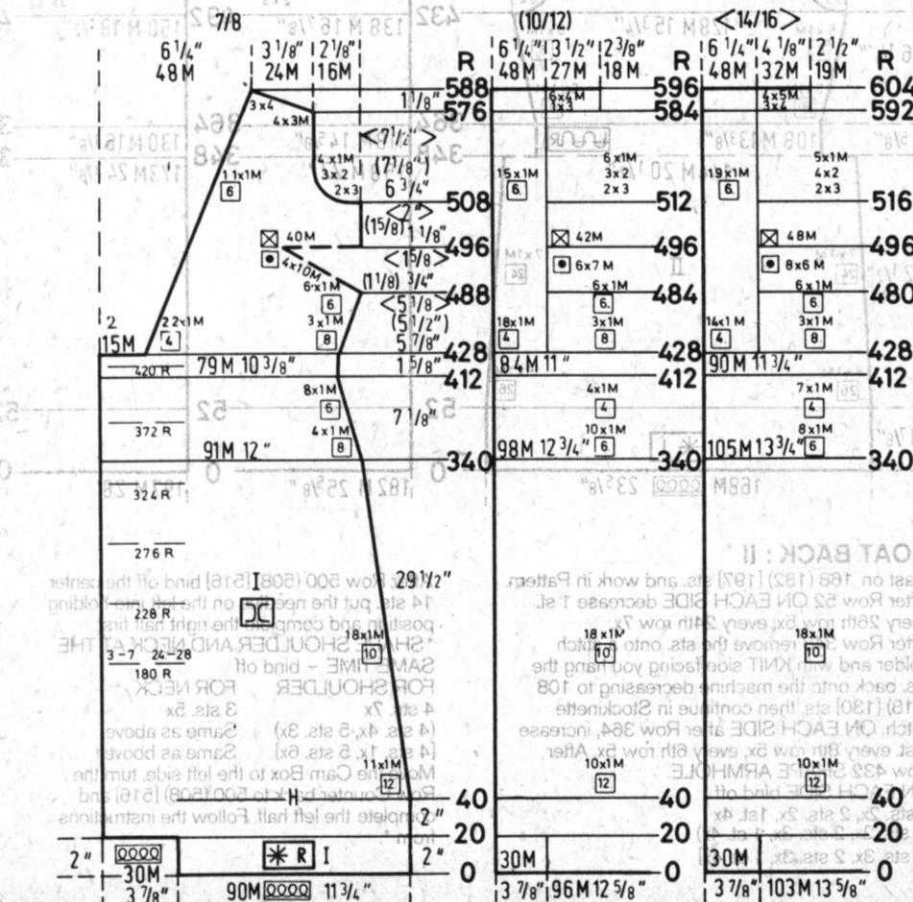

DK 17

SLEEVE : III

Bring 54 (60) [66] needles into working position, set into Pattern then cast on.
ALL SIZES: After Row 10 ON EACH SIDE, increase 1 st. every 8th row 16x, every 6th row 5x. Knit to Row 168 then **SHAPE CAP ON EACH SIDE** bind off
 3 sts. 3x, *2 sts. 1x, 1 st. 1x* and REPEAT from * to * 6x more; 2 sts. 2x, 3 sts. 3x (3 sts. 3x, *2 sts. 1x, 1 st. 1x* and REPEAT from * to * 7x more; 2 sts. 2x, 3 sts. 3x) [3 sts. 3x, *2 sts. 1x, 1 st. 1x* and REPEAT from * to * 9x more; 3 sts. 3x]
 After Row 212 (216) [220] bind off the remaining 10 sts.

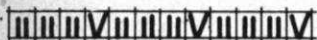
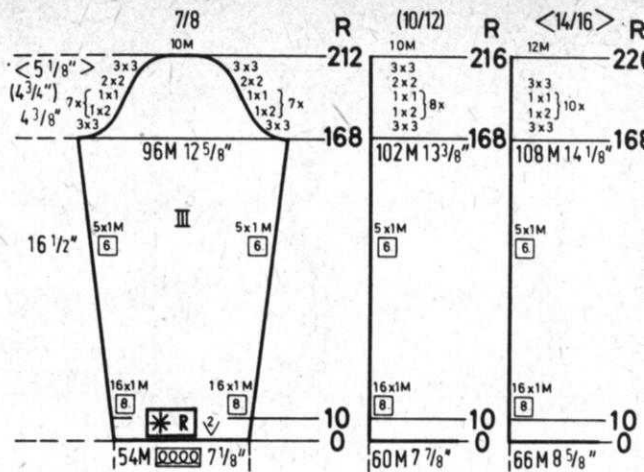

DK 18

COAT AND PANTS

SIZE: 7/8 (10/12) [14/16]
 YARN: Subita grams 2400 2450 2500

E Stock. 6 to 8
 Pattern 8 to 10

P Stock. 16 sts., 21 rows = 2"
 Pattern 14 sts., 26 rows = 2"

4 large buttons

Coat: Lower sections of coat are in a Holding Position Design using Wheel 2. Follow the Line Drawing. The Purl side of Pattern is the right side. Upper section of Coat, sleeves and Pants are Stockinette stitch worn on the knit side.

FINISHING: See General Instruction Crochet loops and sew to one side of Coat then sew large buttons to other side of front opening. (See Picture).

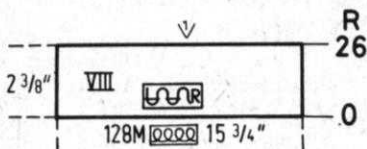
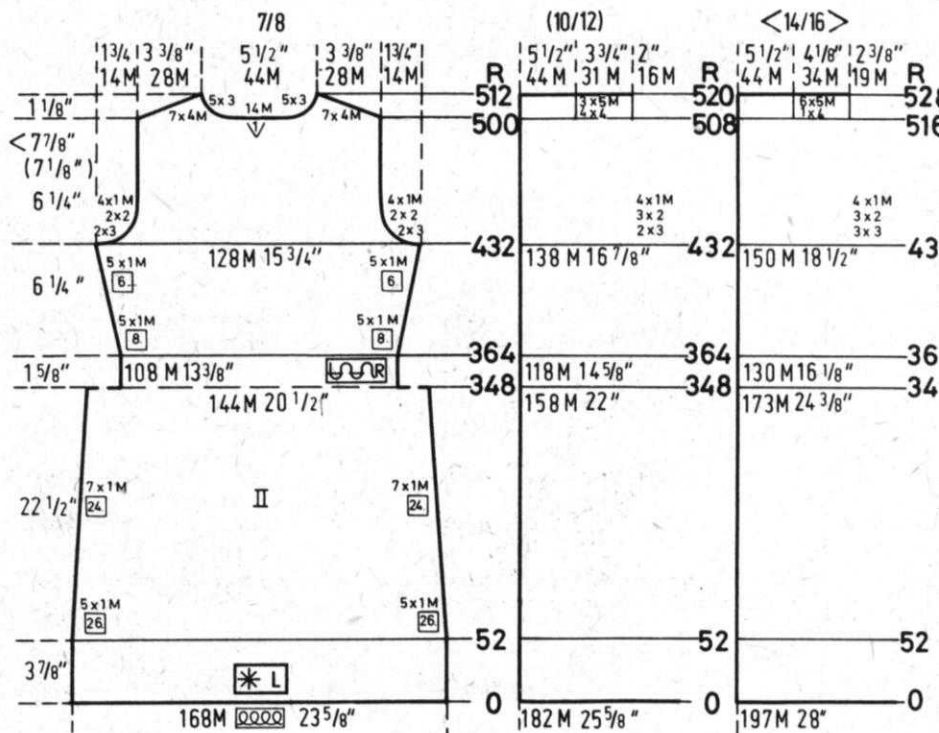

NECKBAND : VIII

ALL SIZES: Cast on 128 sts. and work 26 rows Stockinette stitch then bind off.

COAT BACK : II

Cast on 168 (182) [197] sts. and work in Pattern.
 After Row 52 ON EACH SIDE decrease 1 st. every 26th row 5x, every 24th row 7x.
 After Row 348 remove the sts. onto a stitch holder and with KNIT side facing you hang the sts. back onto the machine decreasing to 108 (118) [130] sts. then continue in Stockinette stitch. ON EACH SIDE after Row 364, increase 1 st. every 8th row 5x, every 6th row 5x. After Row 432 **SHAPE ARMHOLE.**
 ON EACH SIDE bind off
 3 sts. 2x, 2 sts. 2x, 1st. 4x (3 sts. 2x, 2 sts. 3x, 1 st. 4x)
 [3 sts. 3x, 2 sts. 3x, 1 st. 4x]

After Row 500 (508) [516] bind off the center 14 sts. put the needles on the left into holding position and complete the right half first.
*** SHAPE SHOULDER AND NECK AT THE SAME TIME - bind off**
FOR SHOULDER FOR NECK
 4 sts. 7x 3 sts. 5x
 (4 sts. 4x, 5 sts. 3x) Same as above
 [4 sts. 1x, 5 sts. 6x] Same as above
 Move the Cam Box to the left side, turn the Row Counter back to 500 (508) [516] and complete the left half. Follow the instructions from *.

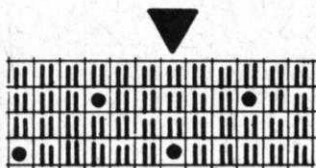

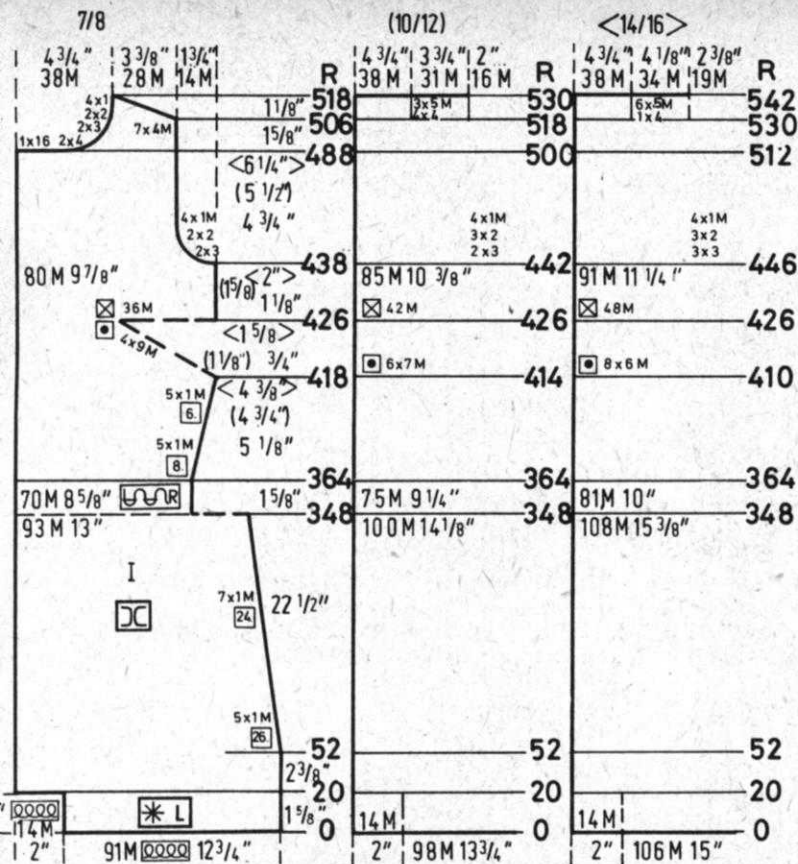

COAT FRONT : I (Make 1, reverse 1)

Cast on 91 (98) [106] sts. and work in Pattern.
After Row 20, cast on 14 sts. on the left (right for second section). ON EACH SIDE, after Row 52, decrease 1 st. every 26th row 5x. every 24th row 7x. After Row 348, remove the sts. onto a stitch holder, turn the knitting over so the knit side faces you and hang the sts. back onto the machine decreasing to 70 (75) [81] sts. Change to Stockinette stitch and knit to Row 364. ON EACH SIDE increase 1 st. every 8th row 5x. every 6th row 5x.

Work Short Rows for Bust Dart after Row 419 (415) [411].

ON OPPOSITE SIDE OF CAM BOX put into holding position

9 sts. 4x

(7 sts. 6x)

[6 sts. 8x]

Bring the needles back into working position

before knitting the next row.

Knit to Row 438 (442) [446]

SHAPE ARMHOLE: Bind off

3 sts. 2x, 2 sts. 2x, 1 st. 4x

(3 sts. 2x, 2 sts. 3x, 1 st. 4x)

[3 sts. 3x, 2 sts. 3x, 1 st. 4x]

Knit to Row 489 (501) [513] then SHAPE NECK

Bind off 16 sts. 1x, 4 sts. 2x, 3 sts. 2x, 2 sts. 2x,

1 st. 4x AND AT THE SAME TIME SHAPE

SHOULDER after Row 506 (518) [530] by binding off

4 sts. 7x

(4 sts. 4x, 5 sts. 3x)

[4 sts. 1x, 5 sts. 6x]

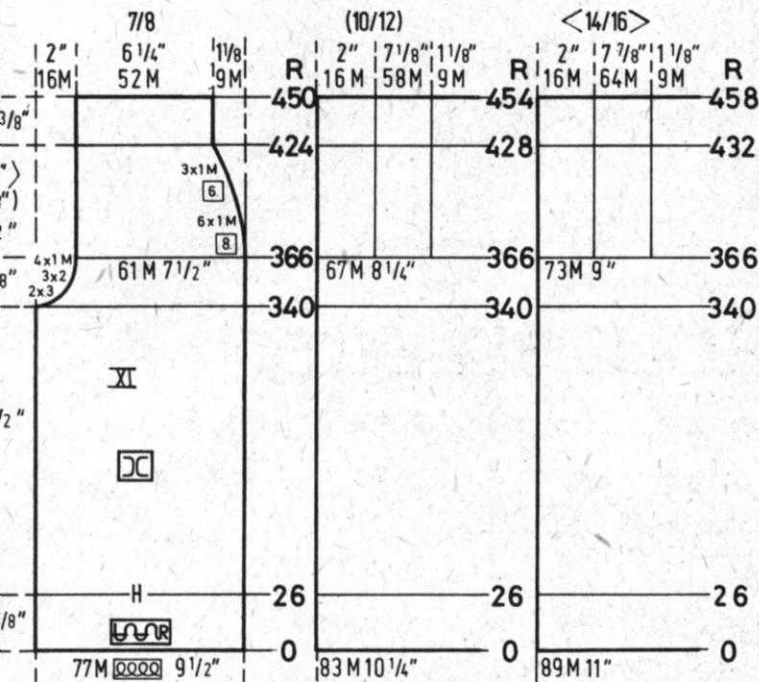

COAT FRONT : XI

(Make 1, reverse 1)

Cast on 77 (83) [89] sts. and work Stockinette

After Row 26, form the hem and knit

to Row 341.

SHAPE CROTCH: Bind off 3 sts. 2x, 2 sts. 3x,

1x.

After Row 366 SHAPE SIDE SEAM: Decrease

every 8th row 6x, every 6th row 3x then

to Row 450 (454) [458] and bind off.

DK 18

PANTS BACK : XII (Make 1, reverse 1)

Cast on 100 (106) [112] sts. and work Stockinette stitch.

After Row 26, form the hem and knit even to Row 340.

SHAPE CROTCH AND AFTER ROW 366
SHAPE SIDE: Bind off
FOR CROTCH

4 sts. 2x, 3 sts. 2x, 2 sts. 3x,
1 st. 6x, 1 st. every 6th row 9x,
1 st. every 4th row 4x

DECREASE FOR SIDE -After Row 366

1 st. every 8th row 6x,

1 st. every 6th row 6x

AFTER ROW 424 (428) [432] WORK SHORT ROWS

ON OPPOSITE SIDE OF CAM BOX, put into holding position 10 sts. 4x then bring back all the needles into working position before knitting the next row. Knit to Row 458 (466) [474] and bind off.

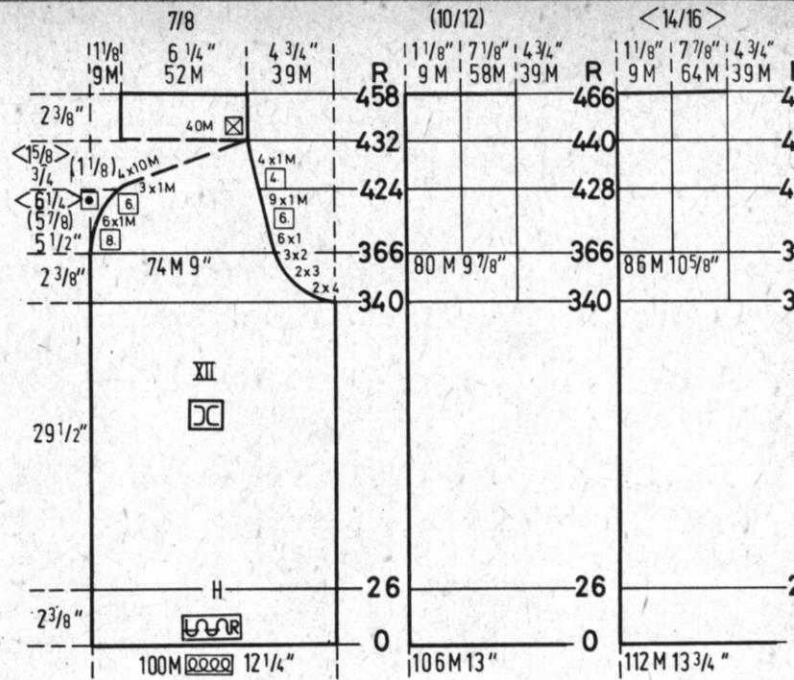

SLEEVE : III

Cast on 58 (64) [70] sts. and work Stockinette stitch.

After Row 26 form the hem.

ON EACH SIDE increase 1 st. every 8th row 21x then knit to Row 190.

SHAPE CAP: ON EACH SIDE bind off

4 sts. 1x, 3 sts. 3x, 2 sts. 1x, 1 st. 15x, 2 sts. 1x,
5 sts. 2x

(4 sts. 1x, 3 sts. 3x, 2 sts. 1x, 1 st. 17x, 2 sts. 1x,
5 sts. 2x)

[4 sts. 1x, 3 sts. 3x, 2 sts. 1x, 1 st. 19x, 2 sts. 1x,
5 sts. 2x]

After Row 236 bind off the remaining
16 (18) [20] sts.

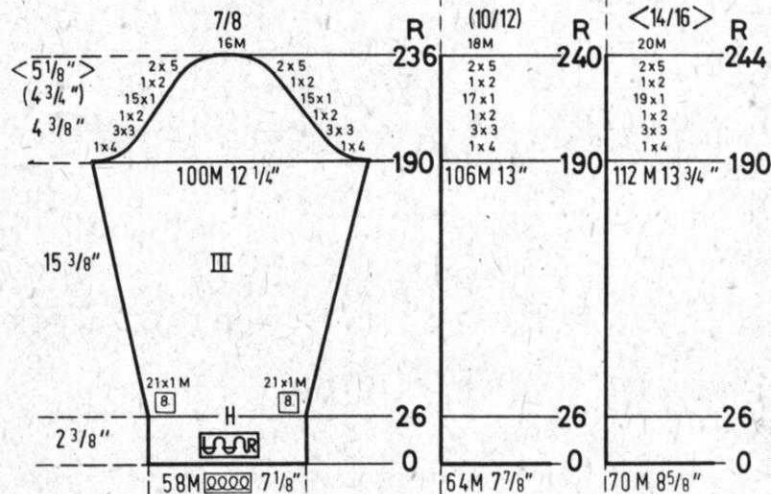

ADJUSTABLE NEEDLE SELECTOR

Suitable for KNITTING Machines only. The Adjustable Needle Selector can be set to any needle spacing and is the perfect Tool to use with many of the Patterns in this issue of KNITTING MAGAZINE.

Price: \$ 4.25 Shipping: \$.60
California residents add Sales Tax.

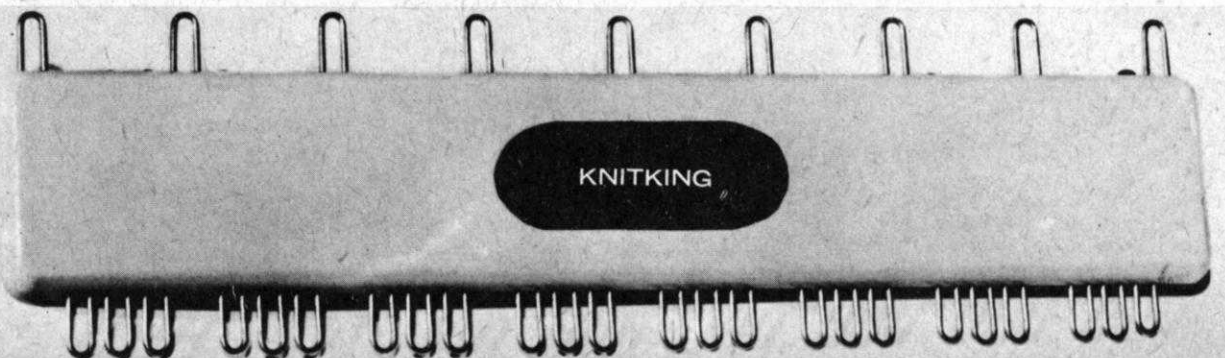

DK 19

VENING DRESS

SIZE: 12/14 (16/18) [20/22]
 YARN:
 Alanda grams 600 650 700
 Melodie grams 300 350 400

9 to 10
 Stock 13 sts., 19 rows = 2"
 Pattern 10 sts., 19 rows = 2"
 Zipper for side opening (optional)

Skirt section and Sleeves are a Holding Position Design with needles out of work that ARE COUNTED in the stitch gauge and instructions. Follow the Line Drawing and use the Adjustable Needle Selector. Bodice and neckband are Stockinette stitch. All worn on the Knit side.

FINISHING: See General Instructions. Attach Fringe to lower edge of dress and sleeves (See General Instructions and picture). Crochet around neckband as follows: Row 1: single crochet. Row 2: 5 dc in first st., skip 2, 1 sc in next st.; * skip 2, 5 dc in next st.; skip 2, 1 sc in next st. REPEAT from * around. Sew in side zipper (optional).

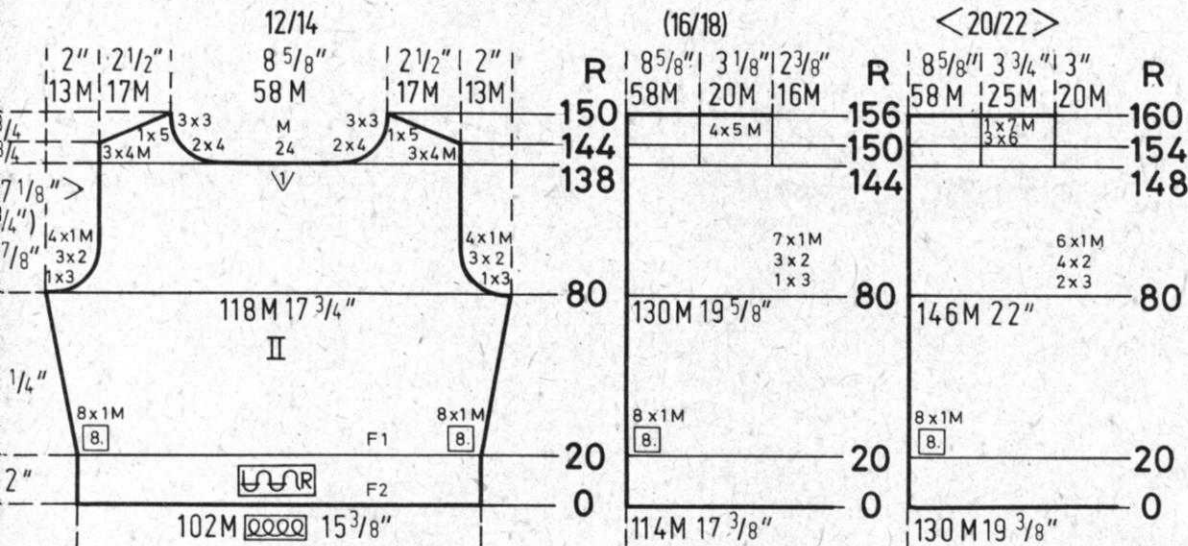

BODICE BACK : II

Cast on 102 (114) [130] sts. with Yarn 2 and knit Stockinette stitch.
 After Row 20 change to Yarn 1 and increase every 8th row 8x.
 Knit to Row 80.
SHAPE ARMHOLE: ON EACH SIDE bind off 1 st., 2 sts. 3x, 1 st. 4x (5 sts. 1x, 2 sts. 3x, 1 st. 7x) (6 sts. 2x, 2 sts. 4x, 1 st. 6x) (7 sts. 1x, 2 sts. 4x, 1 st. 6x) to Row 138 (144) [148]. Bind off the center

24 sts. put the needles on the left side into holding position and complete the right half first.
 * SHAPE SHOULDER AND NECK AT THE SAME TIME, bind off
FOR SHOULDER 4 sts. 3x, 5 sts. 1x (5 sts. 4x) [6 sts. 3x, 7 sts. 1x]
FOR NECK 4 sts. 2x, 3 sts. 3x (Same as above) [Same as above]
 Move the Cam Box to the left side, turn the Row Counter back to 138 (144) [148] and complete the left half. Follow the instructions from *.

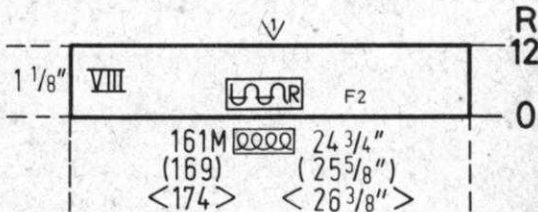
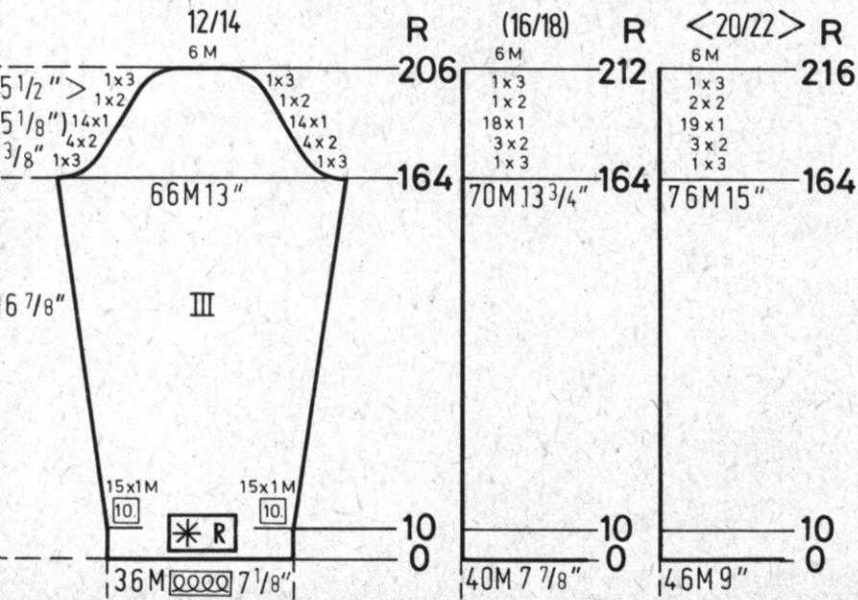
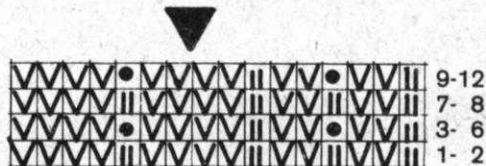

Neckband : VIII

Cast on 161 (169) [174] sts. with yarn 2 and work 12 rows Stockinette stitch then bind off.

SLEEVE : III

Bring 36 (40) [46] needles into working position then set into Pattern. Cast on and knit to Row 10. ON EACH SIDE, increase 1 st. every 10th row 15x. Knit to Row 164, then
SHAPE CAP: ON EACH SIDE bind off 3 sts. 1x, 2 sts. 4x, 1 st. 14x, 2 sts. 1x, 3 sts. 1x (3 sts. 1x, 2 sts. 3x, 1 st. 18x, 2 sts. 1x, 3 sts. 1x) [3 sts. 1x, 2 sts. 3x, 1 st. 19x, 2 sts. 2x, 3 sts. 1x] After Row 206 (212) [216] bind off the remaining 6 sts.

DK 19

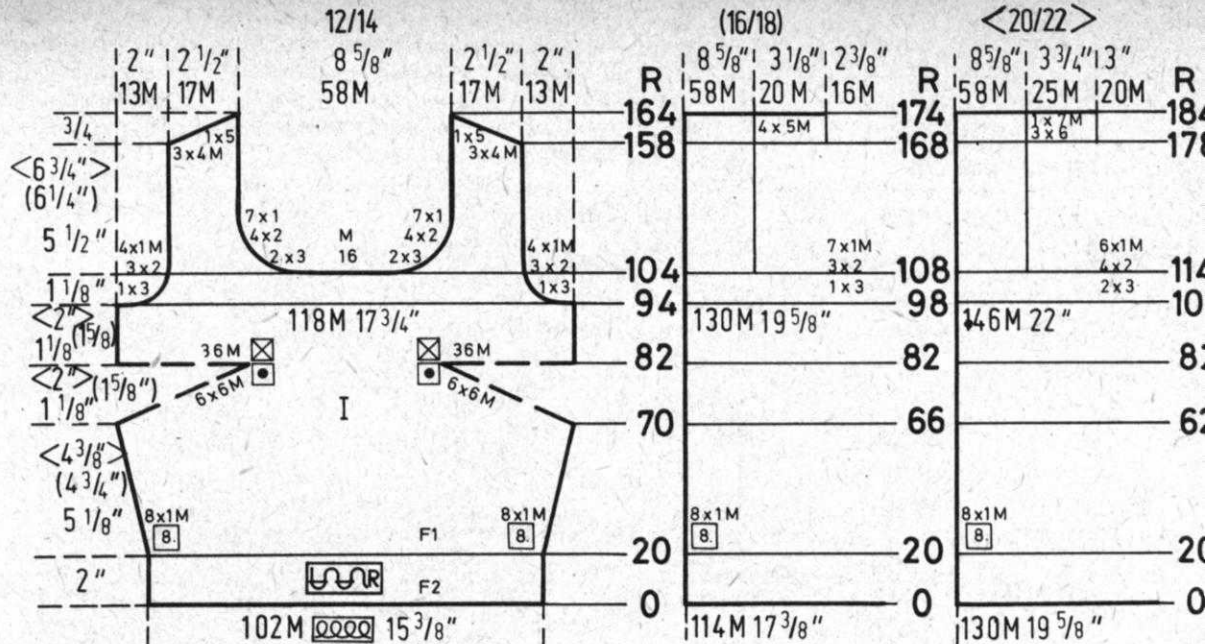

BODICE FRONT : I

Work the front the same as the back to Row 70 (66) [62] then work Short rows for the Bust Darts.
ON OPPOSITE SIDE OF CAM BOX, put into holding position 6 sts. 6x ON EACH SIDE. Bring all the needles back into working position before knitting the next 2 rows.
 Knit to Row 94 (98) [102]
SHAPE ARMHOLE AND AT THE SAME TIME SHAPE NECK AFTER Row 104 (108) [114] by binding off the center 16 sts. put the needles on the left into holding position and complete the right half first.

BIND OFF

* FOR ARMHOLE
 3 sts. 1x, 2 sts. 3x
 (3 sts. 1x, 2 sts. 3x, 1 st. 7x)
 [3 sts. 2x, 2 sts. 4x, 1 st. 6x]
FOR NECK
 3 sts. 2x, 2sts. 4x, 1 st. 7x
 Same as above
 Same as above
 Move the Cam Box to the left side, turn the Row Counter back to 104 (108) [114] and complete the left half. Follow the instructions from *.

ADJUSTABLE NEEDLE SELECTOR

Suitable for KNITTING Machines only. The Adjustable Needle Selector can be set to any needle spacing and is the perfect Tool to use with many of the Patterns in this issue of KNITTING MAGAZINE.

Price: \$ 4.25 Shipping: \$.60
 California residents add Sales Tax.

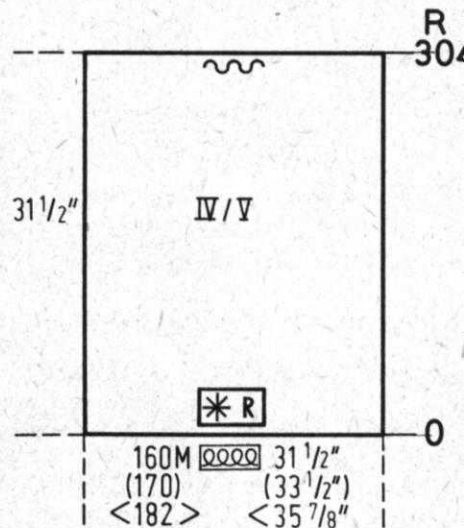
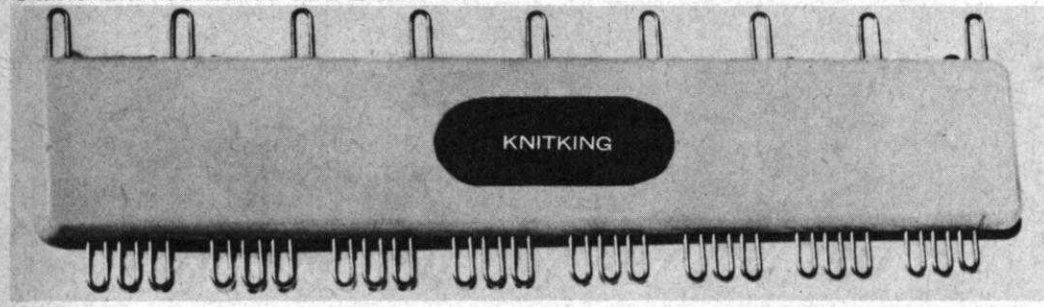

SKIRT SECTION : IV/V

Front and Back

Bring 160 (170) [182] needles into working position then set into Pattern. Cast on and knit to Row 304 then bind off all sts.

DK 20

ESS
 E: 8/10 (12/14) [16/18]
 RN: Beatrice grams 650 700 750
 5 to 7
 Stock 16 sts, 22 rows = 2"
 Pattern 14 sts, 25 rows = 2"

The Skirt section of Dress is a Holding Position Design with out of work needles that ARE COUN-
 TED in the stitch gauge and instructions. Follow the Line Drawing and use the Adjustable Needle
 Selector. The skirt section when completed is turned so the knit side faces you then hung back
 onto the machine and the bodice is in Stockinette stitch. The Purl side of skirt and the knit side of
 bodice is the right side.

FINISHING: See General Instructions. Work 2 rows single crochet around armholes. After sewing band to neckline, trim with Pearls or Sequins (see picture).

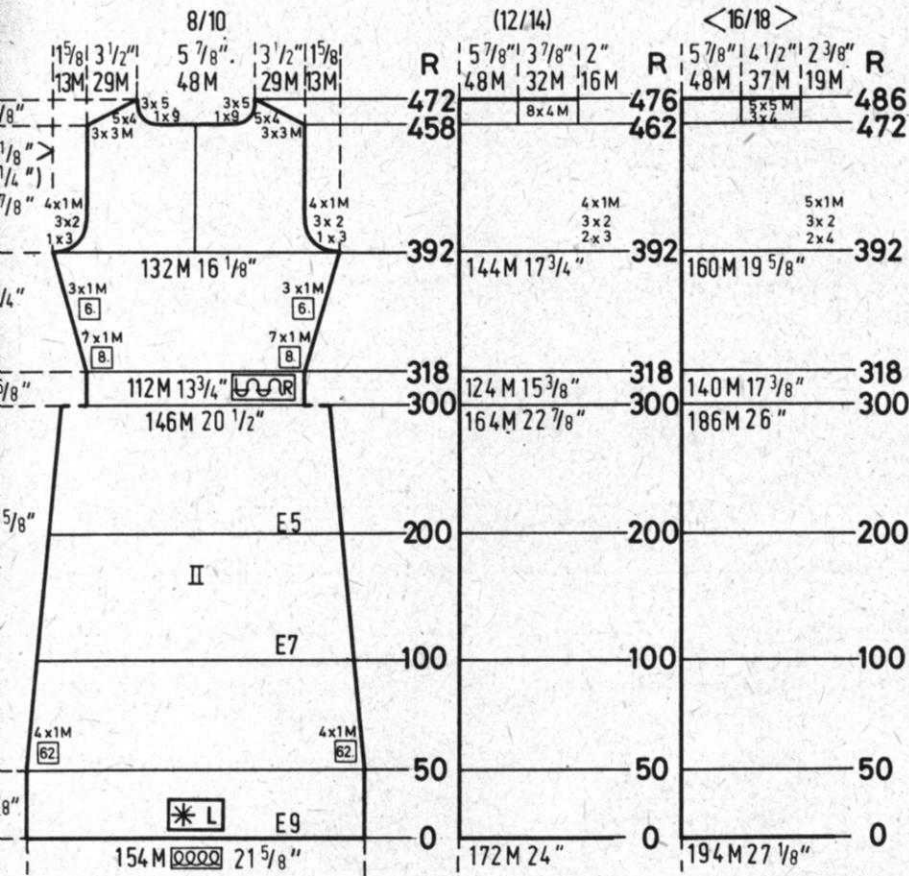

BACK : II

Bring 154 (172) [194] needles into working position then set into Pattern and cast on.
 ON EACH SIDE decrease 1 st. every 62 rows 4x and change to Tension 7 after Row 100, change to Tension 5 after Row 200. After Row 300 remove the stitches onto a stitch holder.
 With the KNIT side facing you, hang the stitches back onto the machine decreasing to 112 (124) [140] sts. then continue in Stockinette stitch. Knit to Row 318.
 ON EACH SIDE increase 1 st. every 8th row 7x, every 6th row 6x. After Row 392, divide in the center for back opening, put the needles on the left side into holding position and complete the right half first.
 * SHAPE ARMHOLE: Bind off 3 sts. 1x, 2 sts. 3x, 1 st. 4x (3 sts. 2x, 2 sts. 3x, 1 st. 4x) [4 sts. 2x, 2 sts. 3x, 1 st. 5x]
 Knit to Row 458 (462) [472]
 SHAPE NECK AND SHOULDER AT THE SAME TIME
 Bind off
 FOR SHOULDER FOR NECK
 3 sts. 3x, 4 sts. 5x 9 sts. 1x, 5 sts. 3x
 (4 sts. 6x) Same as above
 [4 sts. 3x, 5 sts. 5x] Same as above
 Move the Cam Box to the left side, turn the Row Counter back to 392 and complete the left half. Follow the instructions from *.

ADJUSTABLE NEEDLE SELECTOR

uitable for KNITTING Machines only. The Adjustable Needle Selector can be set to any needle spacing and is the perfect Tool to use with many of the patterns in this issue of KNITTING MAGAZINE.

Price: \$ 4.25 Shipping: \$.60
 California residents add Sales Tax.

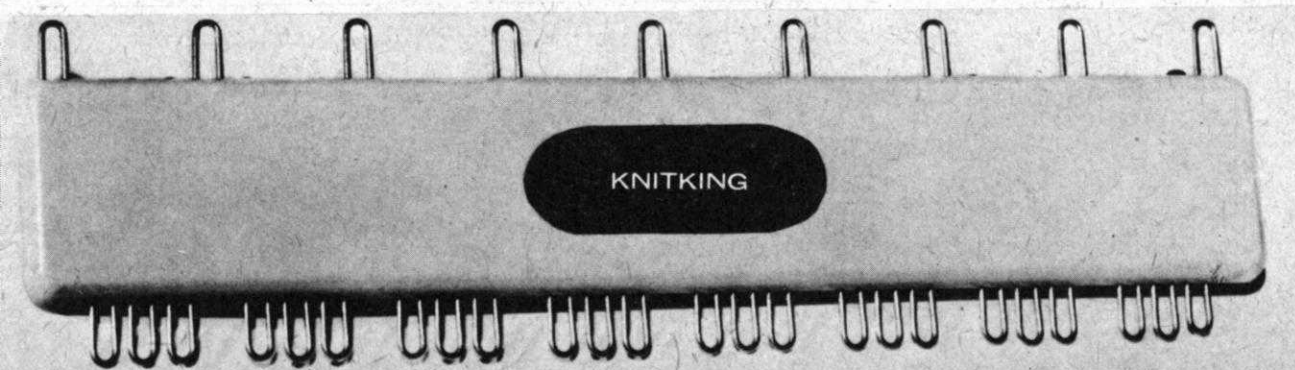

DK 20

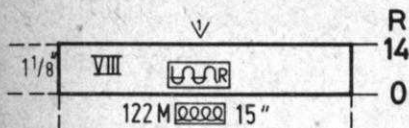

NECKBAND : VIII

Cast on 122 sts. and work 14 rows Stockinette stitch then bind off.

FRONT : I

Work the front the same as the back to Row 380 (376) [372] the work Short Rows for the Bust Darts.

ON EACH SIDE put into holding position

6 sts. 5x ON EACH SIDE

(5 sts. 7x) ON EACH SIDE

[4 sts. 9x] ON EACH SIDE

Bring all the needles back into working position before knitting the next 2 rows.

Knit to Row 404 (408) [412]

SHAPE ARMHOLE: ON EACH SIDE bind off

3 sts. 1x, 2 sts. 3x, 1 st. 4x

(3 sts. 2x, 2 sts. 3x, 1 st. 4x)

[4 sts. 2x, 2 sts. 3x, 1 st. 5x]

Knit to Row 448 (456) [470] bind off the center 12 sts. put the needles on the left into holding position and complete the right half first.

*ON NECK SIDE, bind off 4 sts. 1x, 3 sts. 2x, 2 sts. 2x, 1 st. 4x

SHAPE SHOULDER after Row 470, (478) [492] bind off

3 sts. 3x, 4 sts. 5x

(4 sts. 8x)

[4 sts. 3x, 5 sts. 5x]

Move the Cam Box to the left side, turn the Row Counter back to 448 (456) [470] and complete the left half. Follow the instructions from *.

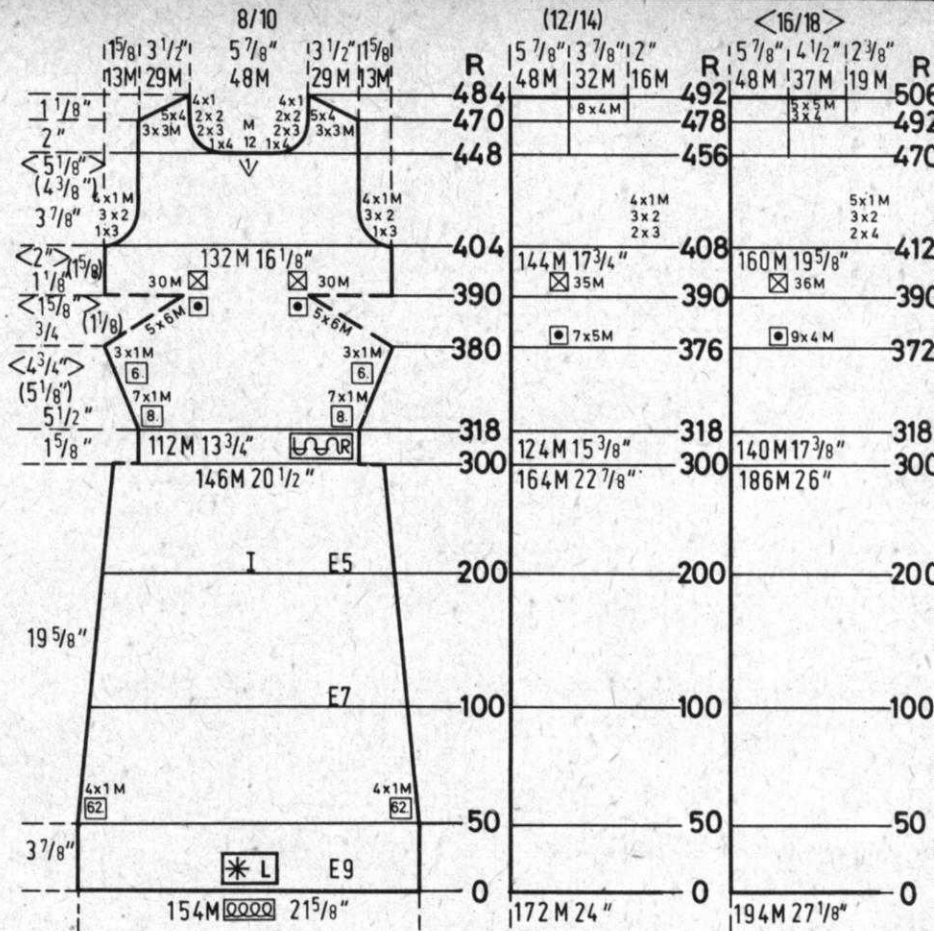

HP 21

MAN'S PULLOVER

SIZE: 32/34 (36/38) [40/42]

YARN: Amore grams 300 350 400

E 7 to 9

P Pattern 14 sts., 33 rows = 2"

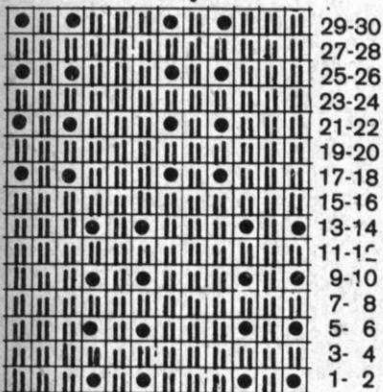

Front and back of Pullover has K1, P1 Ribbing for bands then a Holding Position using Wheel 4B. Follow the Line Drawing.

FINISHING: See General Instructions. Work 1 row single crochet then 1 row reverse single crochet around neckline and armholes.

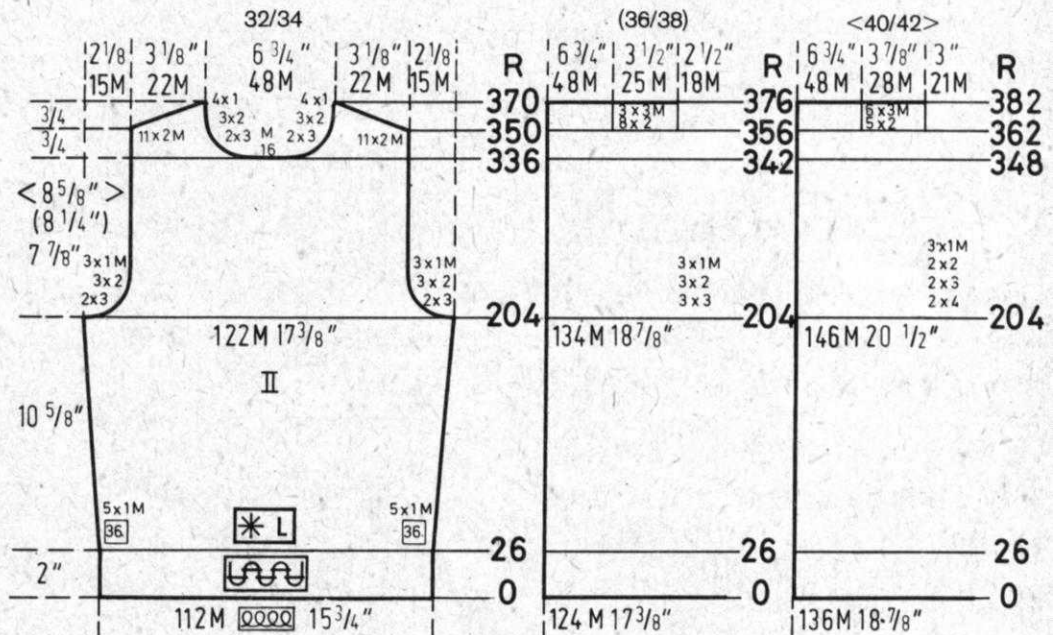

BACK : II

Cast on 112 (124) [136] sts. and work in Stockinette stitch to Row 26. Change to Pattern.

ON EACH SIDE increase 1 st. every 36 rows 5x.

Knit to Row 204. SHAPE ARMHOLE.

ON EACH SIDE bind off

3 sts. 2x, 2 sts. 3x, 1 st. 3x

(3 sts. 3x, 2 sts. 3x, 1 st. 3x)

[4 sts. 2x, 3 sts. 2x, 2 sts. 2x, 1 st. 3x]

Knit to Row 336 (342) [348]

Bind off the center 16 sts. put the needles on the left side into holding position and complete the right half first.

*ON NECK SIDE bind off 3 sts. 2x, 2 sts. 3x, 1 st. 4x

AND AT THE SAME TIME SHAPE SHOULDER

after Row 350 (356) [362] bind off

2 sts. 11x

(2 sts. 8x, 3 sts. 3x)

[2 sts. 5x, 3 sts. 6x]

Bring the needles on the left into working position, knit 1 row in Pattern to the left side, turn the Row Counter back to 336 (342) [348] and complete the left half. Follow the instructions from *.

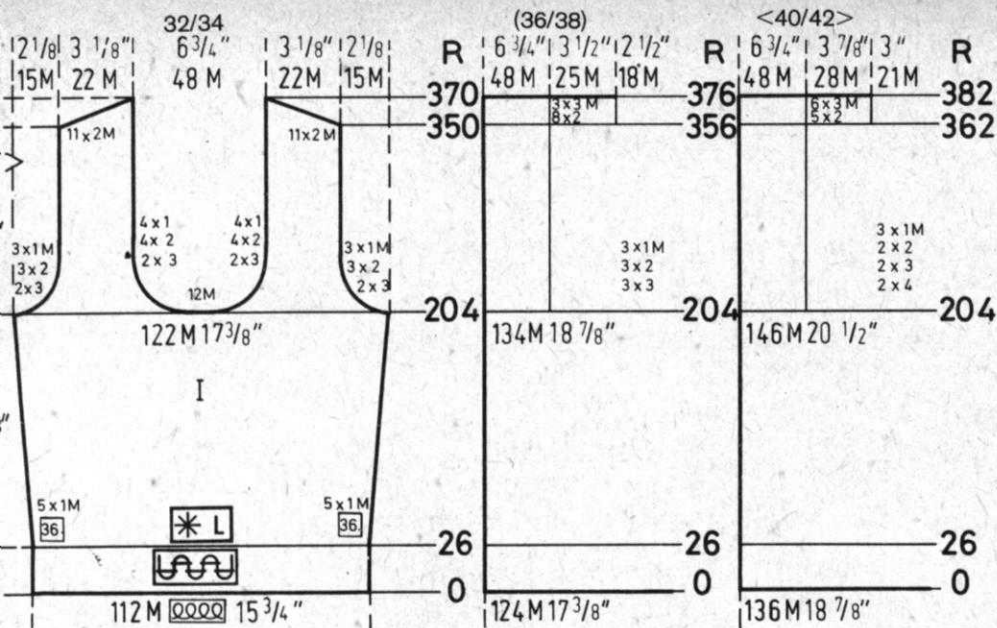

FRONT : I

Work the front the same as the back to Row 204, bind off the center 12 sts. put the needles on the left into holding position and complete the right half first.
 *SHAPE ARMHOLE AND NECK AT THE SAME TIME. Bind off
FOR ARMHOLE
 3 sts. 2x, 2 sts. 3x, 1 st. 3x
 (3 sts. 3x, 2 sts. 3x, 1 st. 3x)
 [4 sts. 2x, 3 sts. 2x, 2 sts. 2x, 1 st. 3x]
FOR NECK
 3 sts. 2x, 2 sts. 4x, 1 st. 4x
 Same as above
 Same as above
SHAPE SHOULDER after Row 350 (356) [362]
 bind off
 2 sts. 11x
 (2 sts. 8x, 3 sts. 3x)
 [2 sts. 5x, 3 sts. 6x]
 Bring the needles on the left side into working position, knit 1 row in Pattern to the left, turn the Row Counter back to 204 and complete the left half. Follow the instructions from *.

P 22

S PULLOVER

34/36 (38/40) [42/44]

Silver grams 450 500 550

to 9
 6 sts., 21 rows = 2"

Stockinette stitch with K1, P1 Ribbing for bands.
 The knit side is the right side.

FINISHING: See General Instructions.

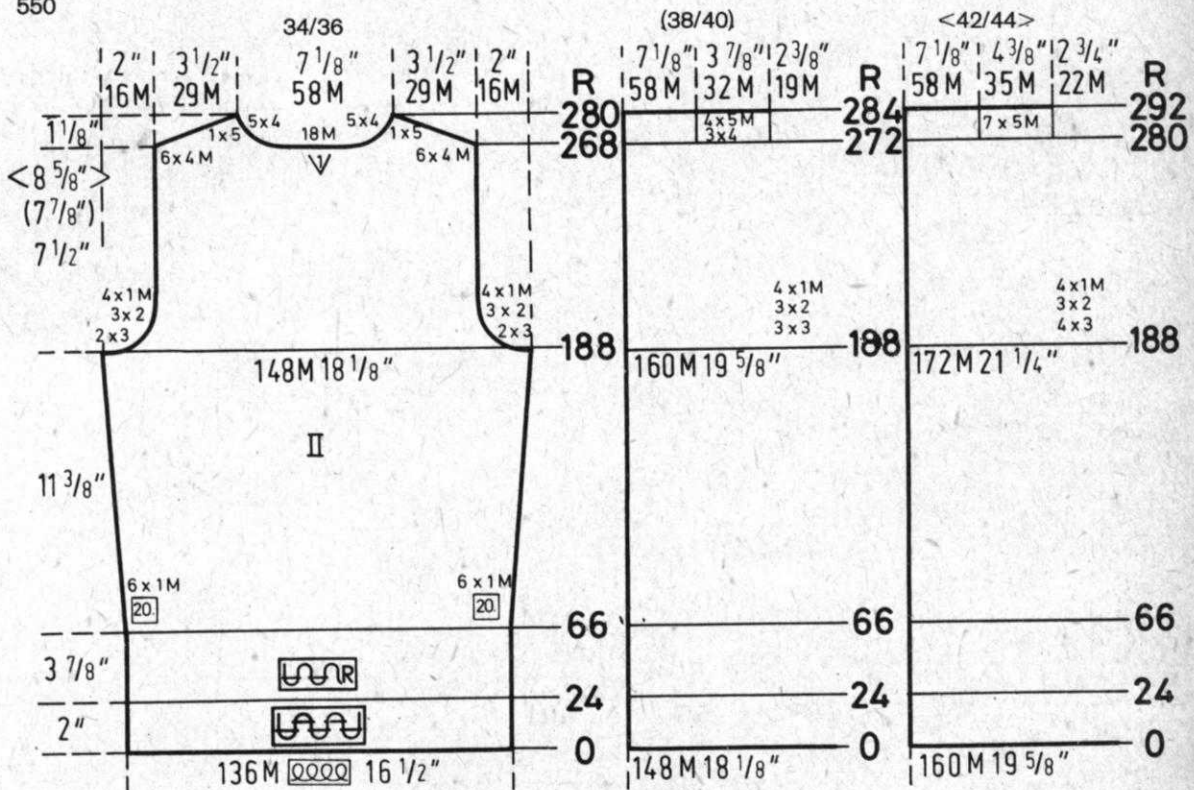

BACK : II

Cast on 136 (148) [160] sts. and work 24 rows K1, P1 Ribbing then change to Stockinette stitch and knit to Row 66.
ON EACH SIDE increase 1 st. every 20 rows 6x, knit to Row 188.
SHAPE ARMHOLE: **ON EACH SIDE** bind off 3 sts. 2x, 2 sts. 3x, 1 st. 4x
 (3 sts. 3x, 2 sts. 3x, 1 st. 4x)
 [3 sts. 4x, 2 sts. 3x, 1 st. 4x]
 Knit to Row 268 (272) [280] bind off the center 18 sts. put the needles on the left side into

holding position and complete the right half first.
 *SHAPE SHOULDER AND NECK AT THE SAME TIME bind off
FOR SHOULDER
 4 sts. 6x, 5 sts. 1x
 (4 sts. 4x, 5 sts. 4x)
 [5 sts. 7x]
FOR NECK
 4 sts. 5x
 Same as above
 Same as above
 Move the Cam Box to the left side, turn the Row Counter back to 268 (272) [280] and complete the left half. Follow the instructions from *.

HP 23

MAN'S PULLOVER

SIZE: 34/36 (38/40) [42/44]
 YARN: Regia grams 300 300 350

E 7 to 9

P 15 sts., 20 rows = 2"

Stockinette stitch with K1, P1 Ribbing for bands.
 The knit side is the right side.

FINISHING: See General Instructions.

BACK : II

Cast on 126 (138) [150] sts. and work 26 rows K1, P1 Ribbing then change to Stockinette stitch. ON EACH SIDE increase 1 st. every 20th row 6x. Knit to Row 142.

SHAPE ARMHOLE: ON EACH SIDE bind off

4 sts. 1x, 3 sts. 2x, 2 sts. 3x, 1 st. 5x

(5 sts. 1x, 3 sts. 2x, 2 sts. 4x, 1 st. 5x)

[6 sts. 1x, 3 sts. 3x, 2 sts. 4x, 1 st. 4x]

Knit to Row 226 (234) [238] bind off the center

22 sts. put the needles on the left side into holding

position and complete the right half first.

*SHAPE SHOULDER AND NECK AT THE

SAME TIME bind off

FOR SHOULDER

3 sts. 5x

(3 sts. 2x, 4 sts. 3x)

[4 sts. 4x, 5 sts. 1x]

FOR NECK

4 sts. 3x, 3 sts. 2x, 2 sts. 2x

Same as above

Same as above

Move the Cam Box to the left side, turn the Row

Counter back to 226 (234) [238] and complete

the left half. Follow the instructions from *.

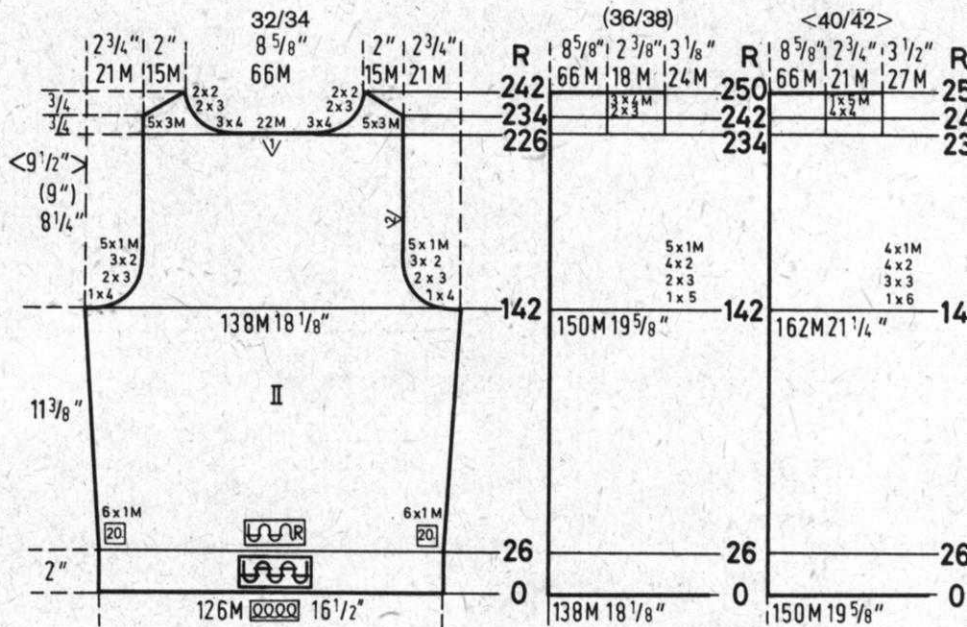

FRONT : I

Work the front the same as the back to Row 198 (206) [210]. Bind off the center 26 sts. put the needles on the left into holding position and complete the right half first.

*ON NECK SIDE bind off 3 sts. 2x, 2 sts. 4x, 1 st. 6x.

SHAPE SHOULDER after Row 234 (242) [246] bind off

3 sts. 6x

(3 sts. 2x, 4 sts. 3x)

[4 sts. 4x, 5 sts. 1x]

Move the Cam Box to the left side, turn the Row

Counter back to 198 (206) [210] and complete

the left half. Follow the instructions from *.

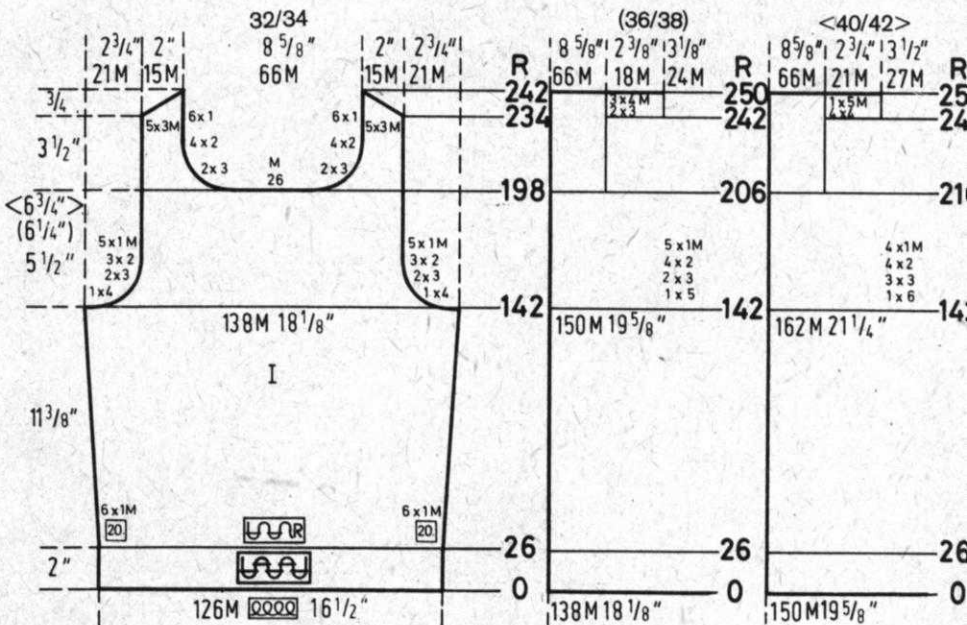

NECKBAND : 1 VIII

Cast on 173 sts. and work 10 rows K1, P1 Ribbing then bind off.

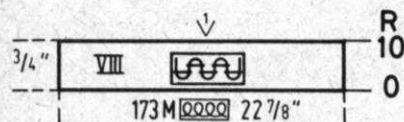

ARMHOLE BAND : 2 VIII (Make 2)

Cast on 153 (159) [165] sts. and work 10 rows K1, P1 Ribbing then bind off.

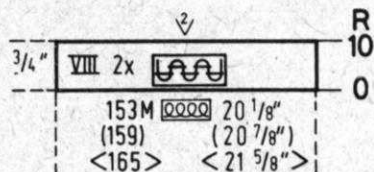

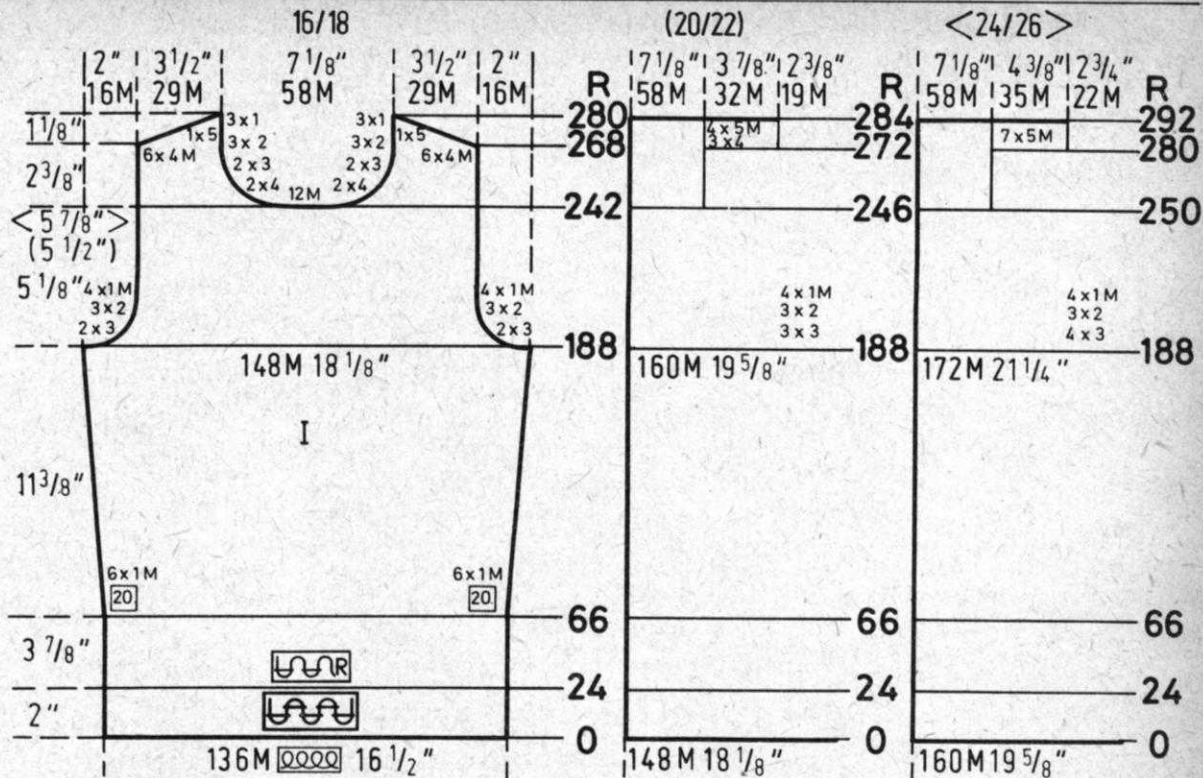

FRONT : I

Work the front the same as the back to Row 242 (246) [250] bind off the center 12 sts, put the needles on the left side into holding position and complete the right half first.

*ON NECK SIDE, bind off 4 sts. 2x, 3 sts. 2x, 2 sts. 3x, 1 st. 3x.

SHAPE SHOULDER after Row 268 (272) [280]

bind off

4 sts. 6x, 5 sts. 1x
(4 sts. 3x, 5 sts. 4x)
[5 sts. 7x]

Move the Cam Box to the left side, turn the Row Counter back to 242 (246) [250] and complete the left half. Follow the instruction from *.

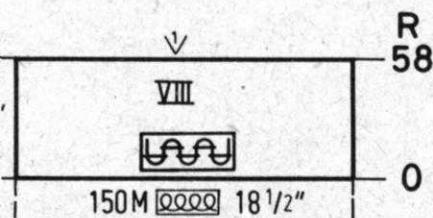

LAR : VIII

Cast on 150 sts. and work 58 rows K1, P1 then bind off.

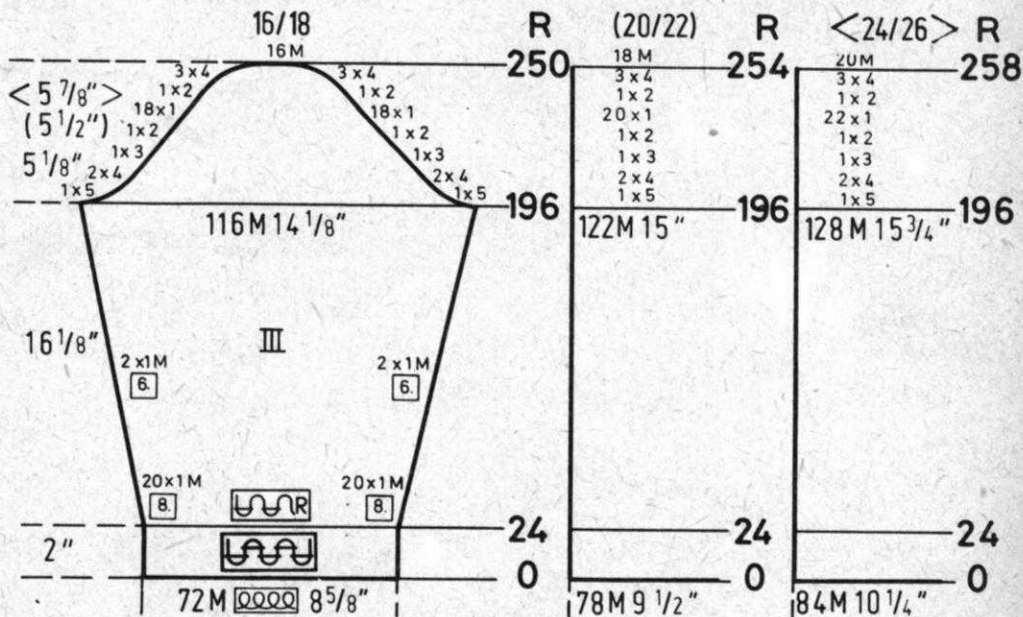

SLEEVE : III

Cast on 72 (78) [84] sts. and work 24 rows K1, P1 Kibbing then change to Stockinette stitch. ON EACH SIDE increase 1 st. every 8th row 20x, every 6th row 2x. Knit to Row 196.

SHAPE CAP: ON EACH SIDE, bind off 5 sts. 1x, 4 sts. 2x, 3 sts. 1x, 2 sts. 1x, 1 st. 18x

2 sts. 1x, 4 sts. 3x

(5 sts. 1x, 4 sts. 1x, 3 sts. 1x, 2 sts. 1x, 1 st. 20x, 2 sts. 1x, 4 sts. 3x)

[5 sts. 1x, 4 sts. 2x, 3 sts. 1x, 2 sts. 1x, 1 st. 22x, 2 sts. 1x, 4 sts. 3x]

After Row 250 (254) [258] bind off the remaining 16 (18) [20] sts.

KK 24

GIRL'S DRESS

SIZE: 6 (8) [10]
 YARN: Melodie grams 250 300 350

E 7 to 9

P 14 sts., 24 rows = 2"

Holding Position Design with needles out of work that ARE COUNTED in the stitch gauge and instructions. Follow the Line Drawing and use the Adjustable Needle Selector. The Purl side is the right side.
 Neckband is Stockinette stitch on the knit side.

FINISHING: See General Instructions. Single crochet around back neck opening then make loops on one side and sew buttons to other side of opening.

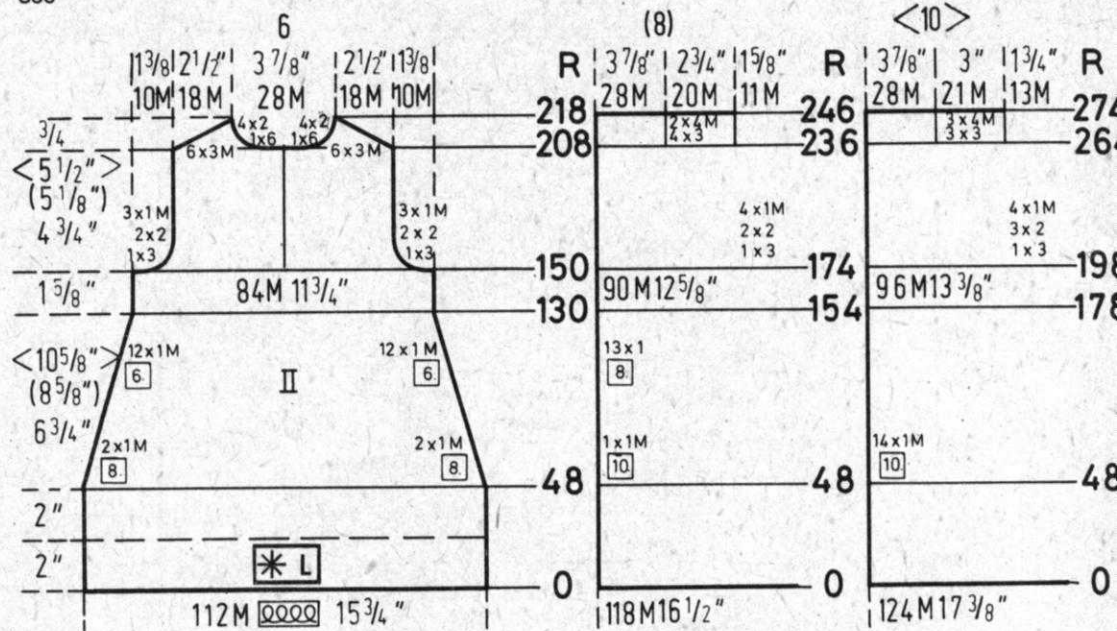

Back: II

Bring 112 (118) [124] needles into working position then set in Pattern. Knit to Row 48.
ON EACH SIDE decrease 1 st.
 every 8th row 2x, every 6th row 12x
 (every 10th row 1x, every 8th row 13x)
 [every 10th row 14x]
 Knit to Row 150 (174) [198]
 Divide in center for back opening, put the needles on the left into holding position and complete the right half first.
 *SHAPE ARMHOLE: Bind off
 3 sts. 1x, 2 sts. 2x, 1 st. 3x
 (3 sts. 1x, 2 sts. 2x, 1 st. 4x)

[3 sts. 1x, 2 sts. 3x, 1 st. 4x]
 Knit to Row 208 (236) [264]
SHAPE SHOULDER AND NECK AT THE SAME TIME. Bind off
FOR SHOULDER FOR NECK
 3 sts. 6x 6 sts. 1x, 2 sts. 4x
 (3 sts. 4x, 4 sts. 2x) Same as above
 [3 sts. 3x, 4 sts. 3x] Same as above
 Bring the needles on the left into working position, knit 1 row in Pattern to the left side, turn the Row Counter back to 150 (154) [198] and complete the left half. Follow the instructions from *.

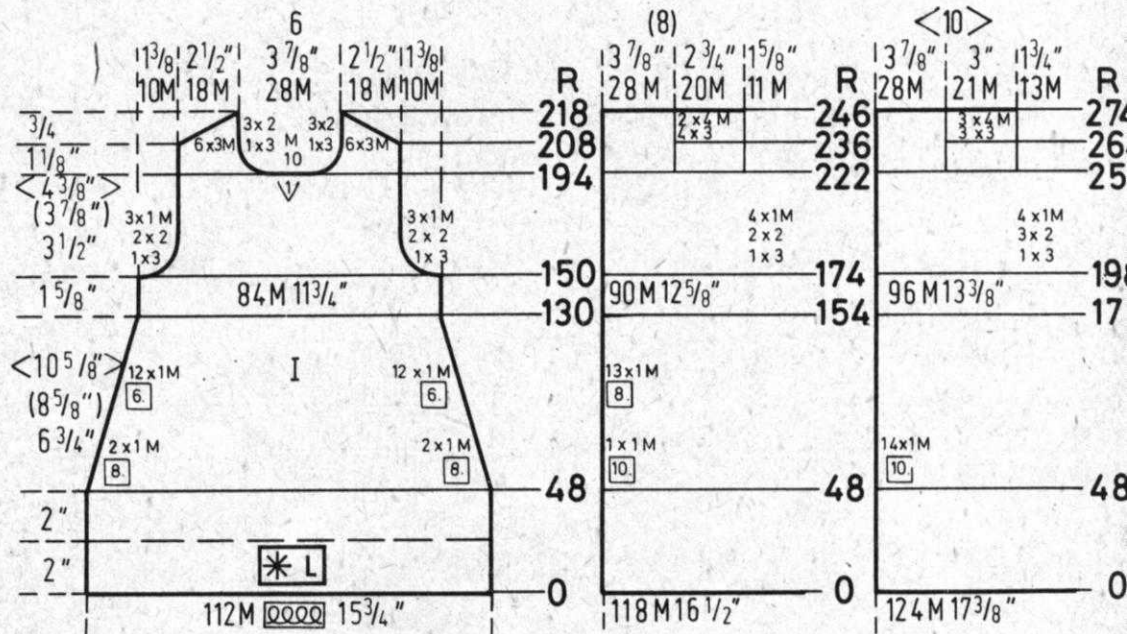

FRONT: I

Work the front the same as the back, (omitting the neck opening and working the armhole shaping **ON EACH SIDE**) to Row 194 (222) [250] then bind off the center 10 sts. put the needles on the left side into holding position and complete the right half first.
 *ON NECK SIDE bind off 3 sts. 1x, 2 sts. 3x
SHAPE SHOULDER AFTER ROW 208

(236) [264] Bind off
 3 sts. 6x
 (3 sts. 4x, 4 sts. 2x)
 [3 sts. 3x, 4 sts. 3x]
 Bring the needles on the left into working position, knit 1 row in Pattern to the left side, turn the Row Counter back to 194 (222) [250] and complete the left half. Follow the instructions from *.

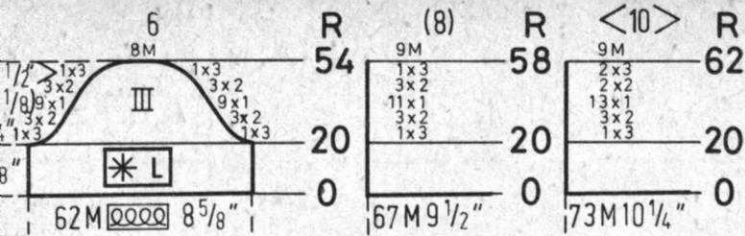

SLEEVE : III

Bring 62 (67) [73] needles into working position then set into Pattern and knit to Row 20.
SHAPE CAP: ON EACH SIDE bind off
 3 sts. 1x, 2 sts. 3x, 1 st. 9x, 2 sts. 3x, 3 sts. 1x
 (3 sts. 1x, 2 sts. 3x, 1 st. 11x, 2 sts. 3x, 3 sts. 1x)
 [3 sts. 1x, 2 sts. 3x, 1 st. 13x, 2 sts. 2x, 3 sts. 2x]
 After Row 54 (58) [62] bind off the remaining
 8 (9) [9] sts.

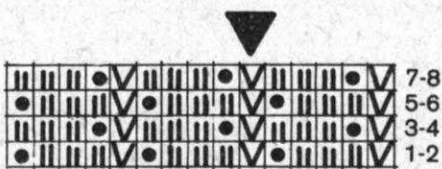

NECKBAND : VIII

Cast on 79 sts. and work 18 rows Stockinette stitch then bind off.

SK 25

L'S DRESS

Yarn: Allegro grams 250 (300) [350]

E 7 to 9
P 14 sts., 20 rows = 2"

Stockinette stitch with an eyelet design at Yoke.
 Follow the Line Drawing. The knit side is the right side.

FINISHING: See General Instructions. Crochet around neck and armholes as follows: 1 row single crochet. **ROW 2:** 3 double crochet in 1st st. *skip 1, 1 sc in next st., skip 1, 3 dc in next st. **REPEAT** from *.

CK : II

on 129 (135) [141] sts. and work Stockinette stitch.
 Row 40 ON EACH SIDE decrease 1 st.
 6th row 4x, every 4th row 16x
 8th row 14x, every 4th row 6x
 10th row 5x, every 6th row 15x
 to Row 140 (160) [180] then divide in 2 for front opening and **CHANGE TO STOCKINETTE STITCH.** Put the needles on the left holding position.
ARM-HOLE bind off
 1x, 2 sts. 2x, 1 st. 6x
 3x, 1x, 2 sts. 3x, 1 st. 5x
 5x, 1x, 2 sts. 3x, 1 st. 6x
 to Row 184 (208) [232]
SHAPE NECK AND SHOULDER AT THE SAME TIME. Bind off
SHOULDER FOR NECK
 3x, 4 sts. 2x
 2x, 4 sts. 3x
 5x
 Put the needles on the left into working position knit 1 row in Pattern to the left side, turn and knit 1 row Counter back to 140 (160) [180] and complete the left half. Follow the instructions

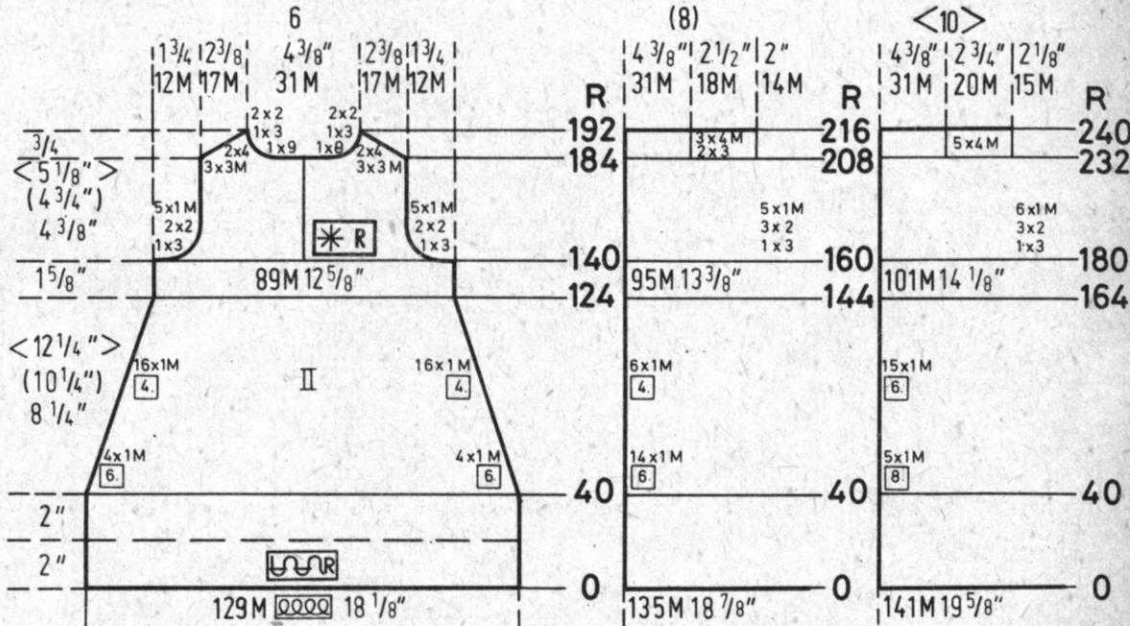

ADJUSTABLE NEEDLE SELECTOR

Adjustable for KNITTING Machines only. The Adjustable Needle Selector can be set to any needle spacing and is the perfect Tool to use with many of the patterns in this issue of KNITTING MAGAZINE.

Price: \$ 4.25 Shipping: \$.60
 California residents add Sales Tax.

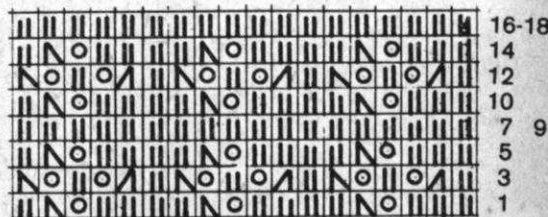
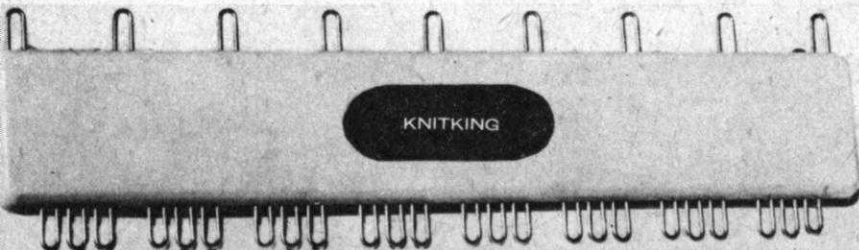

KK 25

FRONT : I

Work the front the same as the back (omit the opening and shape the armholes on each side) to Row 168 (192) [216]

Bind off the center 11 sts. put the needles on the left side into holding position and complete the right half first.

*ON NECK SIDE bind off 3 sts. 2x, 2 sts. 2x SHAPE SHOULDER after Row 184 (208) [232]

Bind off

3 sts. 3x, 4 sts. 2x
(3 sts. 2x, 4 sts. 3x)

[4 sts. 5x]

Bring the needles on the left into working position, knit 1 row in Pattern to the left side, turn the Row Counter back to 168 (192) [216] and complete the left half. Follow the instructions from *.

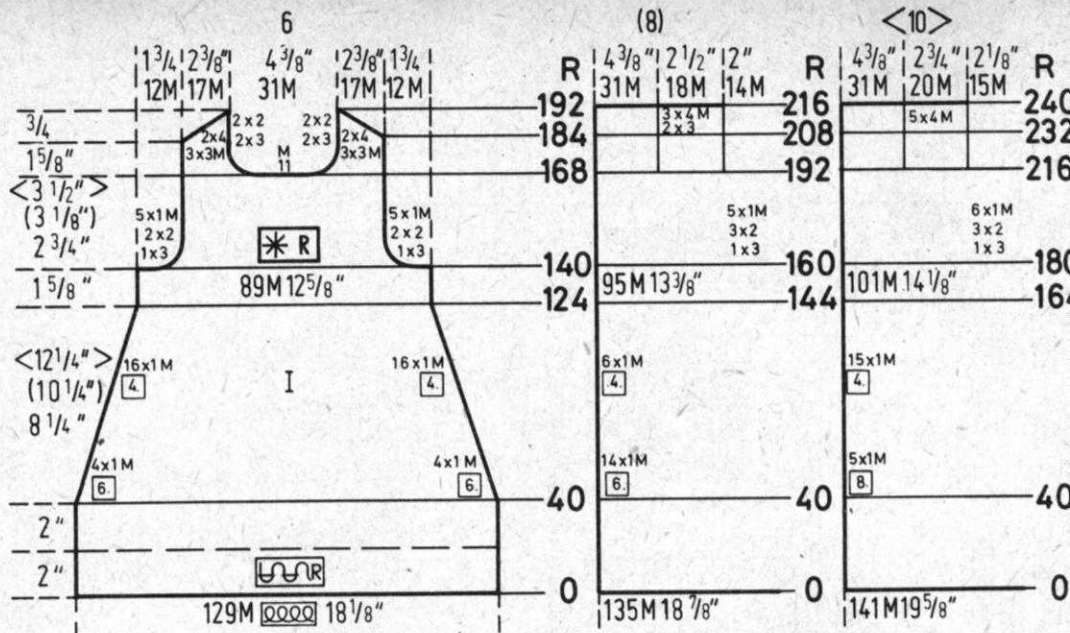

KK 26

CHILD'S VEST AND PANTS

SIZE:	4	(6)	[8]
YARN: C1 Regia grams	250	300	350
C2 Regia grams	150	200	200

[E] 6 to 8

[P] 16 sts., 23 rows = 2"

10 Buttons.

Vest back : II

Cast on 92 (99) [106] sts. and work 16 rows

K1, P1 Ribbing then change to Stockinette

stitch and knit even to Row 90 (100) [110]

SHAPE ARMHOLE: ON EACH SIDE bind off

3 sts. 1x, 2 sts. 2x, 1 st. 4x

(3 sts. 2x, 2 sts. 2x, 1 st. 3x)

[3 sts. 2x, 2 sts. 3x, 1 st. 3x]

Knit to Row 150 (164) [178]

Bind off the center 8 sts. put the needles on the left into holding position and complete the right half first.

* SHAPE SHOULDER AND NECK AT THE SAME TIME. Bind off

FOR SHOULDER FOR NECK

4 sts. 1x, 3 sts. 5x 3 sts. 4x

Move the Cam Box to the left side, turn the

Row Counter back to 150 (164) [178] and complete the left half. Follow the instructions from *.

Stockinette stitch worn on the knit side with K1, P1 Ribbing for bands.

FINISHING: See General Instructions. Turn under and hem half of front and neck facings. Work 2 rows single crochet around armholes. Sew on Buttons as shown in picture.

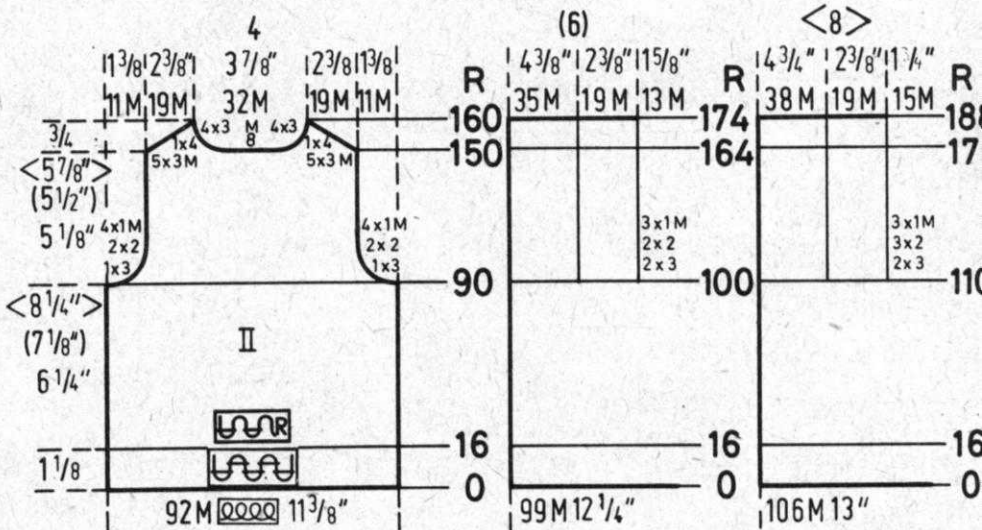

ADJUSTABLE NEEDLE SELECTOR

Suitable for KNITTING Machines only. The Adjustable Needle Selector can be set to any needle spacing and is the perfect Tool to use with many of the Patterns in this issue of KNITTING MAGAZINE.

Price: \$ 4.25 Shipping: \$.60
California residents add Sales Tax.

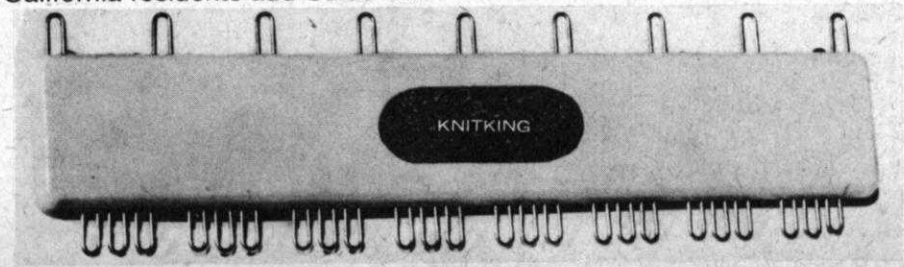

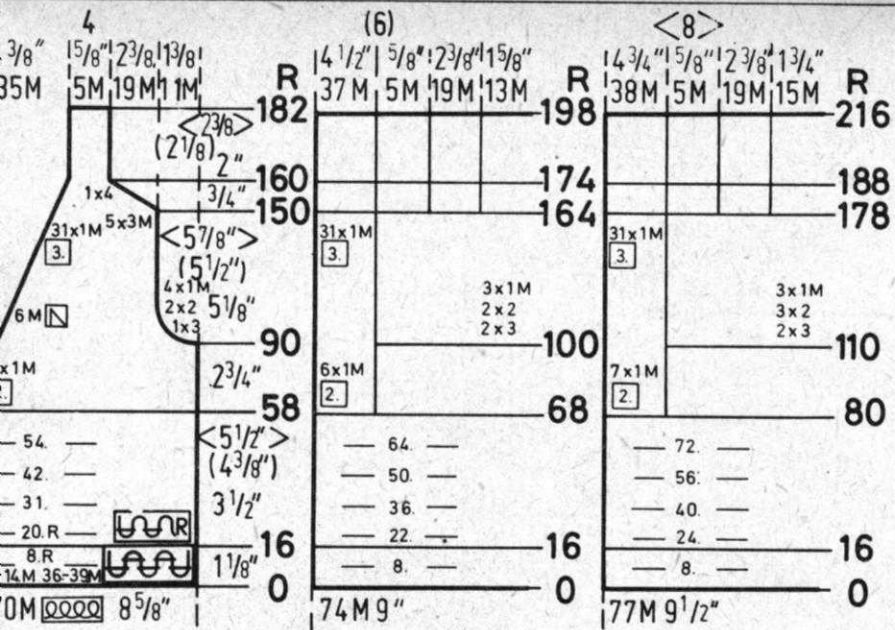

FRONT : I (Make 1, reverse 1)
 Cast on 70 (74) [77] sts. and work 16 rows K1, P1 Ribbing and make **BUTTONHOLES** after Row 8 over needles 11 to 14 and 36 to 39 counting from the left (for a boy, make the buttonholes on the second front on opposite side). Change to Stockinette stitch and knit to Row 58 (68) [80] **AND AT THE SAME TIME**, make **BUTTONHOLES** as before after Rows 20, 31, 42, 54 (22, 36, 50, 64) [24, 40, 56, 72]
SHAPE FRONT NECK by always hanging the 6th st. onto the 5th needle and move the sts. over to fill the empty needle.
 Decrease 1 st. **AT NECK EDGE** every 2nd row 4x, every 3rd row 31x (every 2nd row 6x, every 3rd row 31x) [every 2nd row 7x, every 3rd row 31x]
AND AT THE SAME TIME SHAPE ARMHOLE after Row 90 (100) [110] bind off 3 sts. 1x, 2 sts. 2x, 1 st. 4x (3 sts. 2x, 2 sts. 2x, 1 st. 3x) [3 sts. 2x, 2 sts. 3x, 1 st. 3x]
SHAPE SHOULDER after Row 150 (164) [178] bind off 3 sts. 5x, 4 sts. 1x then knit to Row 182 (198) [216] and bind off the remaining 5 sts.

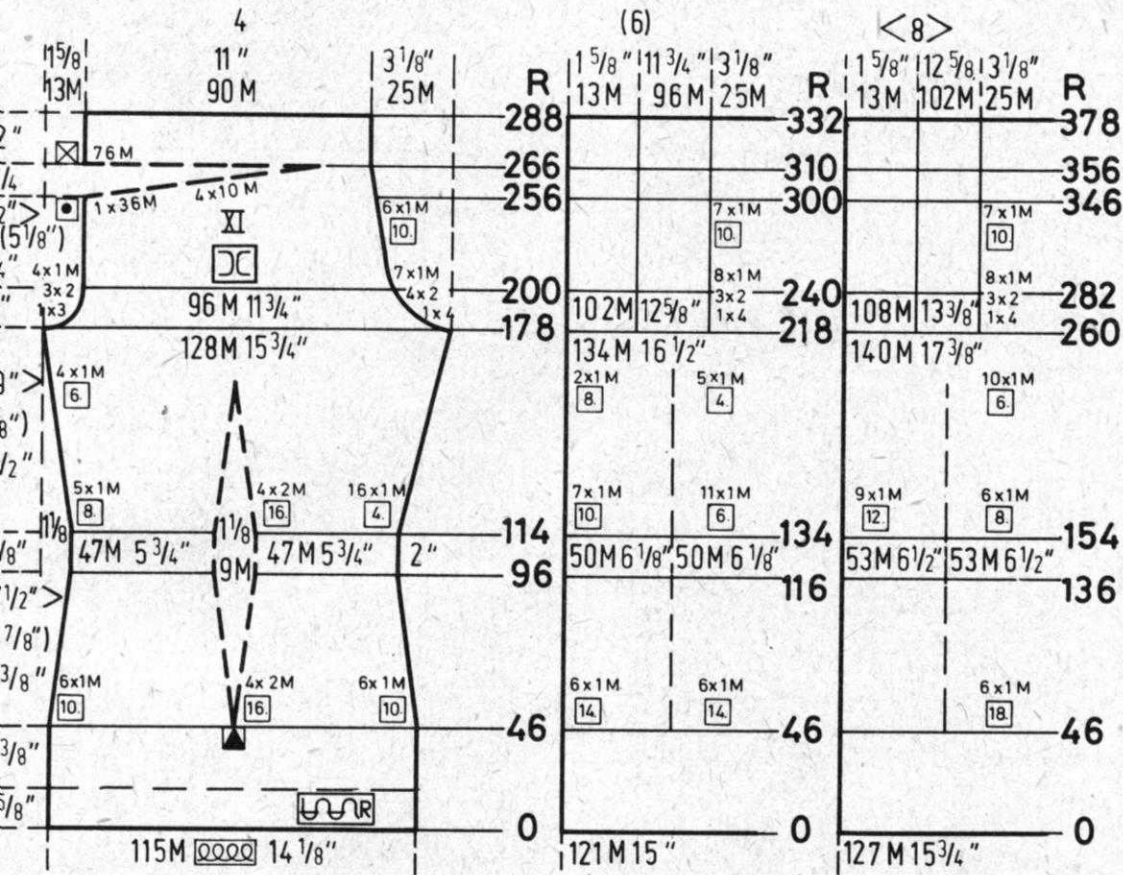

BACK FRONT AND BACK : IX
(Make 1, reverse 1)
 Cast on 115 (121) [127] sts. and work Stockinette stitch. Knit to Row 46 then for **ALL SIZES**, decrease 2 sts. for **DART** in the center every 4th row 4x. **AT THE SAME TIME ON EACH SIDE** decrease 1 st. every 2nd row 6x (14th row 6x) [16th row 6x]
 Knit to Row 114 (134) [154] then decrease 2 sts. for **DART** every 16th row 2x **AND AT THE SAME TIME** increase 1 st. every 2nd row 4x
FRONT SIDE
 Knit to Row 114 (134) [154] then decrease 2 sts. every 6th row 4x (10th row 7x, every 8th row 2x) [12th row 9x]
BACK SIDE
 Knit to Row 16x

(every 6th row 11x, every 4th row 5x)
 [every 8th row 6x, every 6th row 10x]
 Knit to Row 178 (218) [282] **SHAPE CROTCH**:
 Bind off
ON FRONT SIDE
 3 sts. 1x, 2 sts. 3x, 1 st. 4x (Same as above)
 [Same as above]
ON BACK SIDE
 4 sts. 1x, 2 sts. 3x, 1 st. 7x, 1 st. every 10th row 6x (4 sts. 1x, 2 sts. 3x, 1 st. 8x, 1st. every 10th row 7x)
 [Same as above]
 After Row 256 (300) [346] **Work Short Rows**.
ON OPPOSITE SIDE OF CAM BOX put into holding position 36 sts. 1x, 10 sts. 4x. Bring all the needles back into holding position before knitting the next row.
 Knit to Row 288 (332) [387] then bind off.

KK 27

GIRL'S DRESS

SIZE: 4 (6) [8]
 YARN: Amore grams 200 200 250

E 7 to 9

P 14 sts., 31 rows = 2"

A Holding Position Design with needles out of work that ARE COUNTED in the stitch gauge and instructions. Follow the Line Drawing and use Wheel 4B. The Purl side is the right side of Pattern.

FINISHING: See General Instructions. Work 1 row single crochet and 1 row double crochet around neckline and armholes.

BACK : II

Bring 117 (123) [129] needles into working position then set into Pattern and knit to Row 50. ON EACH SIDE decrease 1 st. every 8th row 3x, every 6th row 15x (every 10th row 7x, every 8th row 11x) [every 12th row 5x, every 10th row 13x] Knit to Row 188 (230) [260] SHAPE ARMHOLE: ON EACH SIDE bind off 3 sts. 1x, 2 sts. 3x, 1 st. 4x (3 sts. 1x, 2 sts. 3x, 1 st. 5x) [3 sts. 1x, 2 sts. 3x, 1 st. 7x] Knit to Row 252 (300) [336]. Bind off the center 17 sts. put the needles on the left side into holding position and complete the right half first. *ON NECK SIDE bind off 2 sts. 4x (2 sts. 5x) [2 sts. 5x] After Row 270 (318) [354] bind off the remaining 11 sts. Bring the needles on the left into working position, knit 1 row in Pattern to the left side, turn the Row Counter back to 252 (300) [336] and complete the left half. Follow the instructions from *.

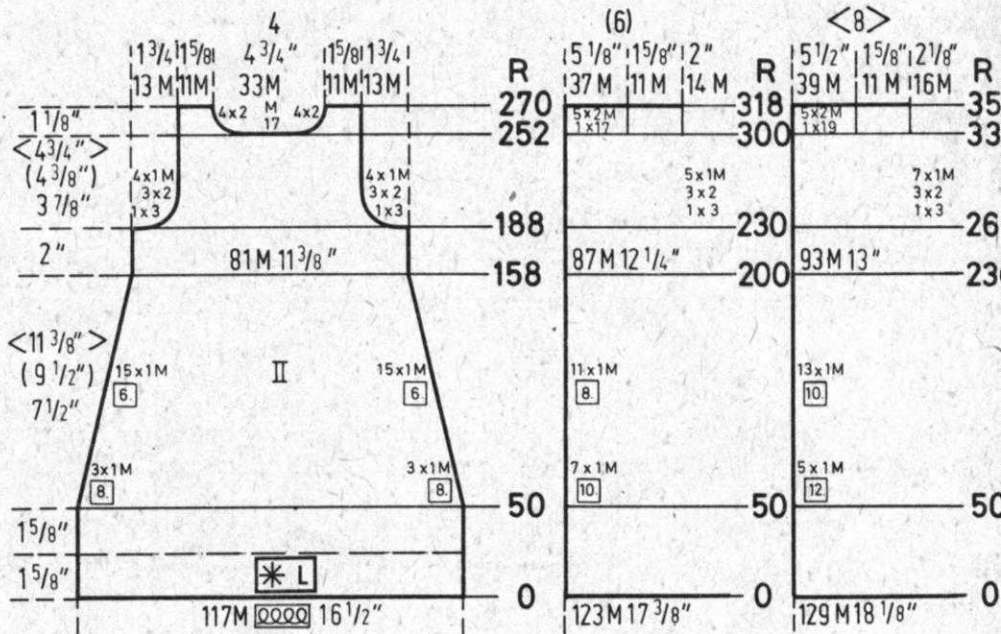

FRONT : I

Work the front the same as the back to Row 214 (256) [286] then bind off the center 15 sts. put the needles on the left into holding position and complete the right half first. *ON NECK SIDE bind off 2 sts. 3x, 1 st. 3x (3 sts. 1x, 2 sts. 2x, 1 st. 4x) [3 sts. 1x, 2 sts. 2x, 1 st. 5x] After Row 270 (318) [354] bind off the remaining 11 sts. Bring the needles on the left into working position, knit 1 row in Pattern to the left side, turn the Row Counter back to 214 (256) [286] and complete the left half. Follow the instructions from *.

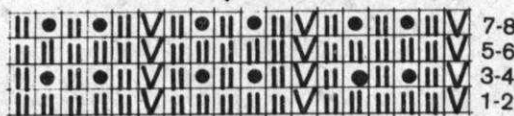
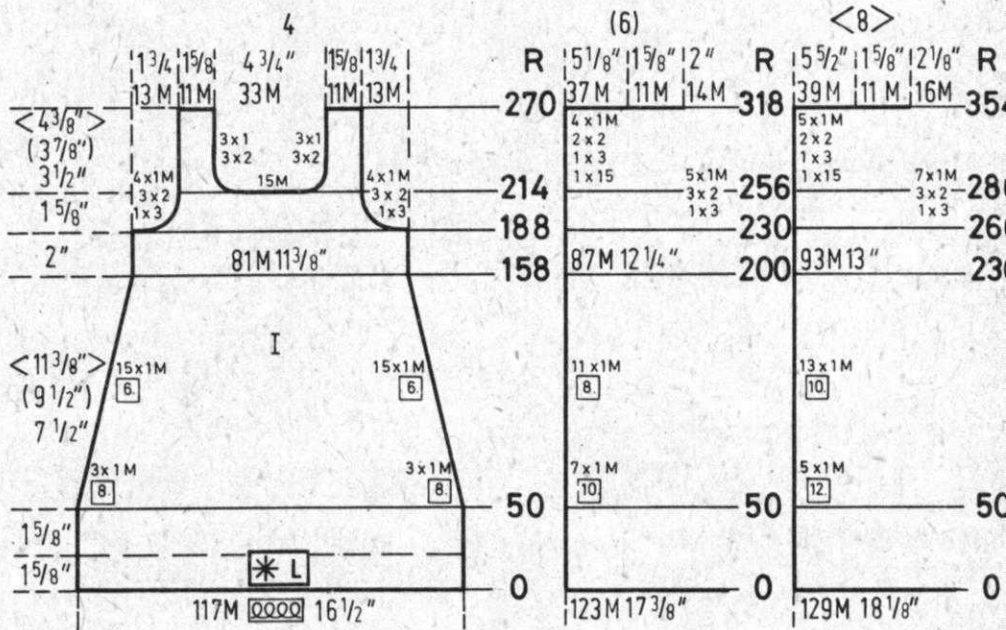

KK 28

L'S DRESS

8 (10) (12)
 N: Allegro grams 300 350 400

7 to 9
 16 sts., 21 rows = 2"

An Eyelet and Holding Position Design worn on the Purl side. Follow the Line Drawing.

FINISHING: See General Instructions. Work 1 row single crochet around sleeves and neckline and opening. Attach Cloth collar and cuffs. Close opening with snaps and attach bow with streamers (see picture).

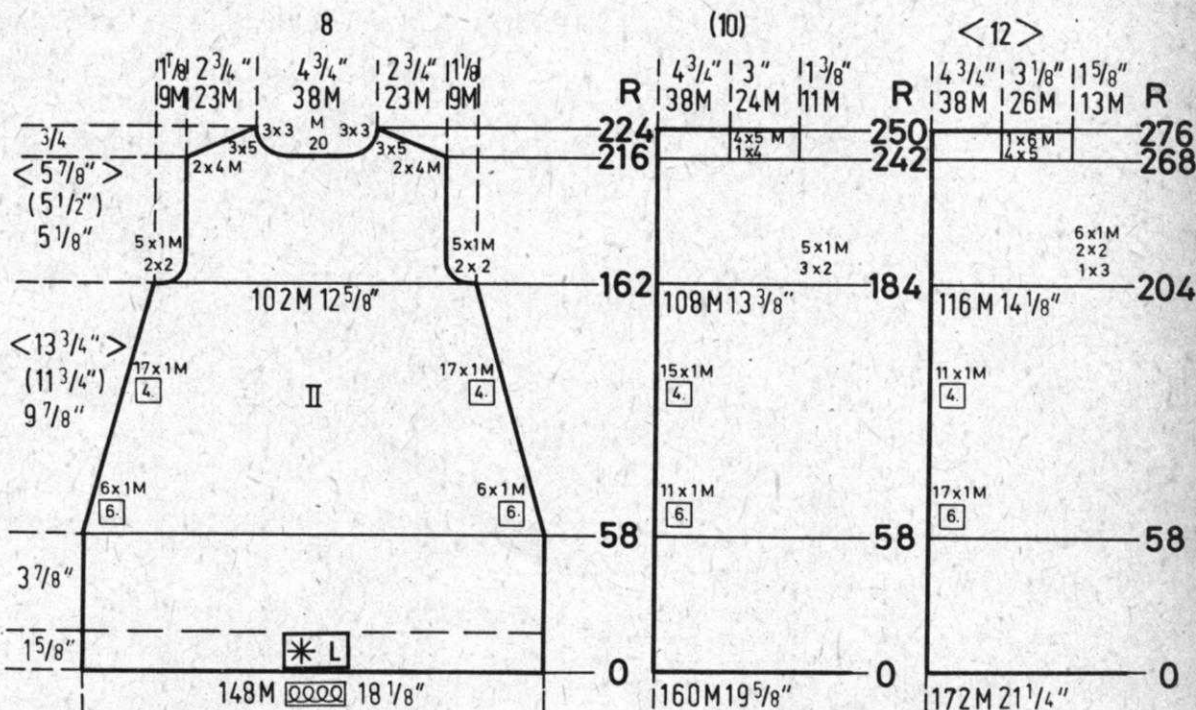

BACK: II

Cast on 148 (160) [172] sts. and knit in Pattern. After Row 58, ON EACH SIDE decrease 1 st. every 6th row 6x, every 4th row 17x (every 6th row 11x, every 4th row 15x) [every 6th row 17x, every 4th row 11x] Knit to row 162 (184) [204] SHAPE ARMHOLE: ON EACH SIDE bind off 2 sts. 2x, 1 st. 5x [2 sts. 3x, 1 st. 5x] [3 sts. 1x, 2 sts. 2x, 1 st. 6x] Knit to Row 216 (242) [268]. Bind off the center 20 sts. put the needles on the left into holding

position and complete the right half first. *SHAPE SHOULDER AND NECK AT THE SAME TIME. Bind off FOR SHOULDER FOR NECK 4 sts. 2x, 5 st. 3x 3 sts. 3x (4 sts. 1x, 5 sts. 4x) Same as above [5 sts. 4x, 6 sts. 1x] Same as above Bring the needles on the left into working position, knit 1 row in Pattern to the left side, turn the Row Counter back to 216 (242) [268] and complete the left half. Follow the instructions from *.

ADJUSTABLE NEEDLE SELECTOR

Adjustable for KNITTING Machines only. The Adjustable Needle Selector can be set to any needle spacing and is the perfect Tool to use with many of the patterns in this issue of KNITTING MAGAZINE.

Price: \$ 4.25 Shipping: \$.60
 California residents add Sales Tax.

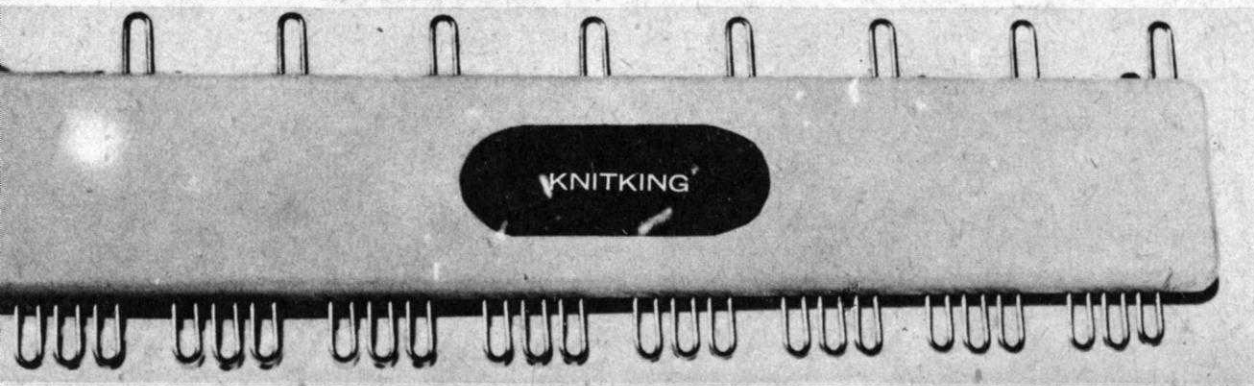

KK 28

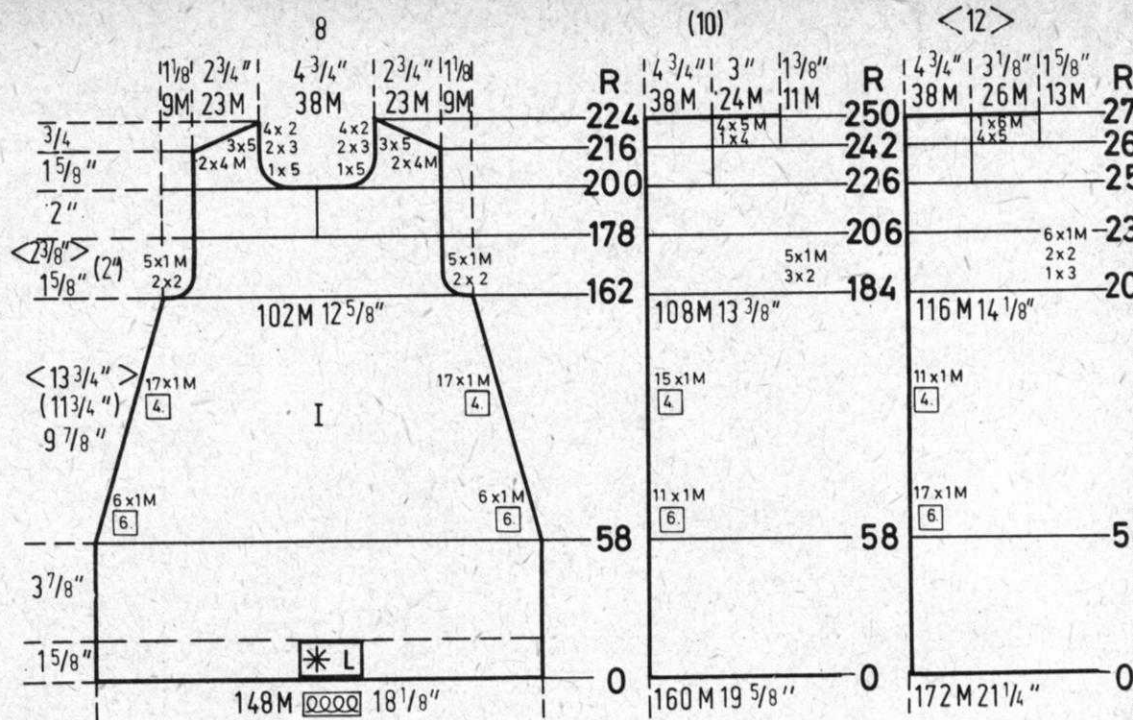

FRONT : I

Work the front the same as the back to Row 178 (206) [230]
 Divide in the center and put the needles on the left into holding position and complete the right half first.
 * Knit to Row 200 (226) [252]
 SHAPE NECK: Bind off 5 sts. 1x, 3 sts. 2x, 2 sts. 4x
 SHAPE SHOULDER after Row 216 (242) [268]

Bind off
 4 sts. 2x, 5 sts. 3x
 (4 sts. 1x, 5 sts. 4x)
 [5 sts. 4x, 6 sts. 1x]
 Bring the needles on the left into working position, knit 1 row in Pattern to the left side, turn the Row Counter back to 178 (206) [230] and complete the left half. Follow the instructions from *.

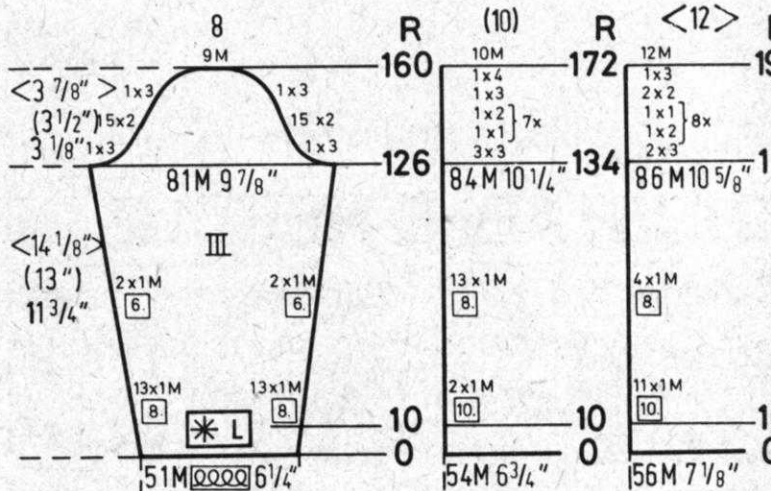
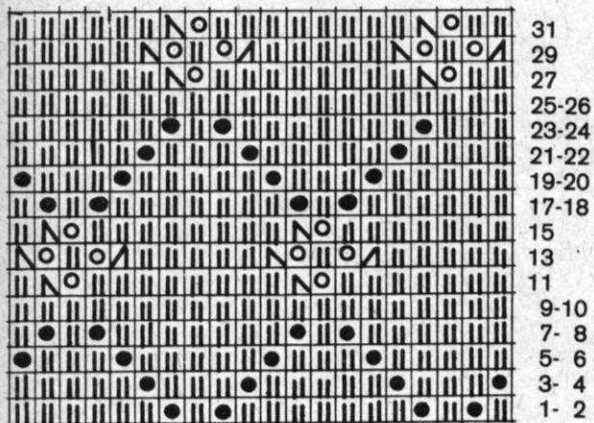

SLEEVE : III

Cast on 51 (54) [56] sts. and work in Pattern.
 ON EACH SIDE after Row 10, increase
 1 st. every 8th row 13x, every 6th row 2x
 (1 st. every 10th row 2x, every 6th row 13x)
 [1 st. every 10th row 11x, every 8th row 4x]
 Knit to Row 126 (134) [152]
 SHAPE CAP: ON EACH SIDE bind off
 3 sts. 1x, 2 sts. 15x, 3 sts. 1x
 (3 sts. 3x, *1 st. 1x, 2 sts. 1x and REPEAT
 FROM * 6x more, 3 sts. 1x, 4 sts. 1x)
 [3 sts. 2x, *2 sts. 1x, 1 st. 1x and REPEAT
 FROM * 7x more, 2 sts. 2x, 3 sts. 1x]
 After Row 160 (172) [194] bind off the remain-
 ing 9 (10) [12] sts.

KK 29

L'S DRESS

Size: 6, (8), [10]
 Yarn: Subita grams C1 250 300 350
 grams C2 50 50 50

16 sts., 24 rows = 2"

5 to 7

Stockinette stitch worn on the knit side with Pattern worked in Duplicate stitch on the front section.

FINISHING: See General Instructions, Single crochet around front opening. Make loops on 1 side, sew buttons to other side of opening. Follow the Line Drawing and work duplicate stitch following the Line Drawing. (See picture)

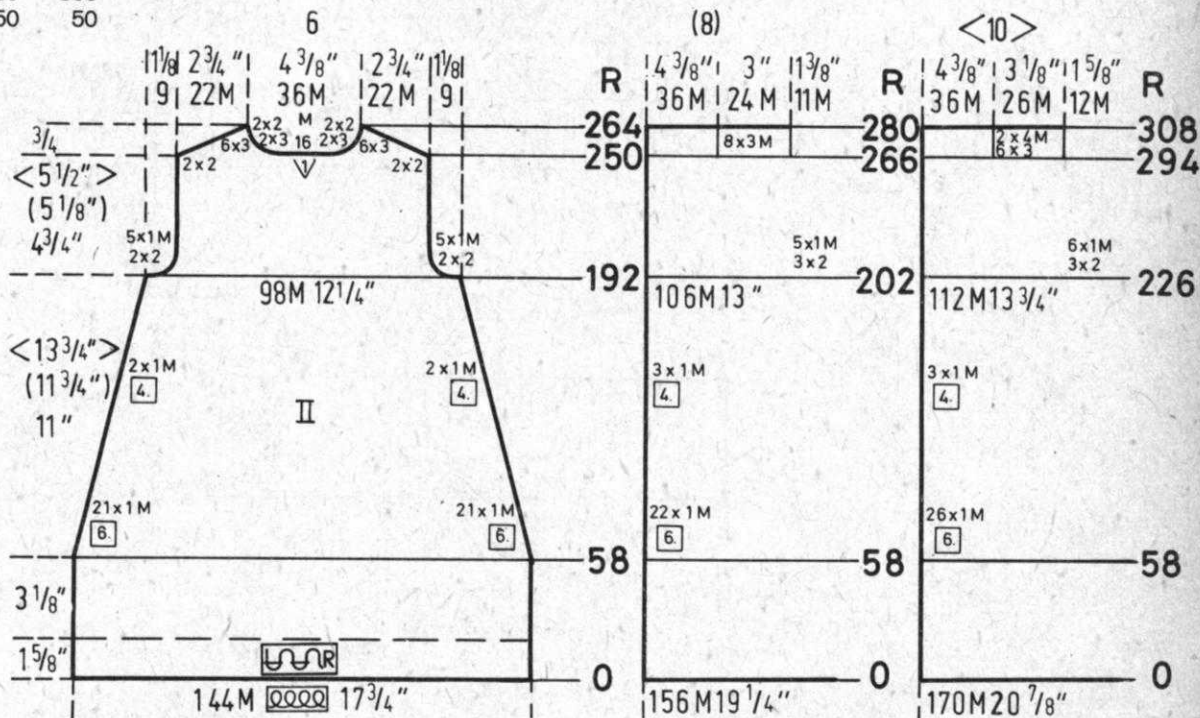

BACK : II

Cast on 144 (156) [170] sts. and work Stockinette stitch to Row 58.
 ON EACH SIDE decrease 1 st.
 every 6th row 21x, every 4th row 2x
 (every 6th row 22x, every 4th row 3x)
 [every 6th row 26x, every 4th row 3x]
 Knit to Row 192 (202) [226]
 SHAPE ARMHOLE: ON EACH SIDE bind off
 2 sts. 2x, 1 st. 5x
 [2 sts. 3x, 1 st. 5x]
 [2 sts. 3x, 1 st. 6x]
 Knit to Row, 250 (266) [294]. Bind off the center

16 sts. put the needles on the left side into holding position and complete the right half first.
 *SHAPE SHOULDER AND NECK AT THE SAME TIME. Bind off
 FOR SHOULDER FOR NECK
 2 sts. 2x, 3 sts. 6x 3 sts. 2x, 2 sts. 2x
 (3 sts. 8x) Same as above
 [3 sts. 6x, 4 sts. 2x] Same as above
 Move the Cam Box to the left side, turn the Row Counter back to 250 (266) [294] and complete the left half. Follow the instructions from *.

NECK : III

Cast on 51 (55) [57] sts. and work 20 rows K1, Ribbing then change to Stockinette stitch
 ON EACH SIDE increase 1 st, every 10th row 1x, every 8th row 7x
 [10th row 13x]
 12th row 7x, every 10th row 6x]
 Row 136 (150) [164]
 PE CAP: ON EACH SIDE bind off
 2x, *2 sts. 1x, 1 st. 1x and REPEAT from *
 re; 2 sts. 3x
 2x, *2 sts. 1x, 1 st. 2x and REPEAT from *
 re; 3 sts. 2x
 3x, *2 sts. 1x, 1 st. 2x and REPEAT from *
 re; 2 sts. 3x]
 Row 174 (194) [212] bind off the remain-
 ing (9) [11] sts.

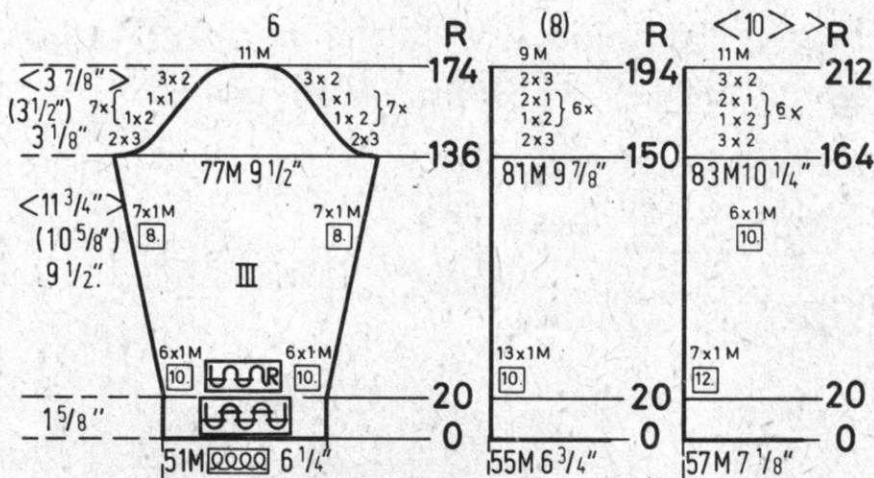

NECKBAND : III

Cast on 103 sts. and work 24 rows K1, P1 Ribbing then bind off.

KK 29

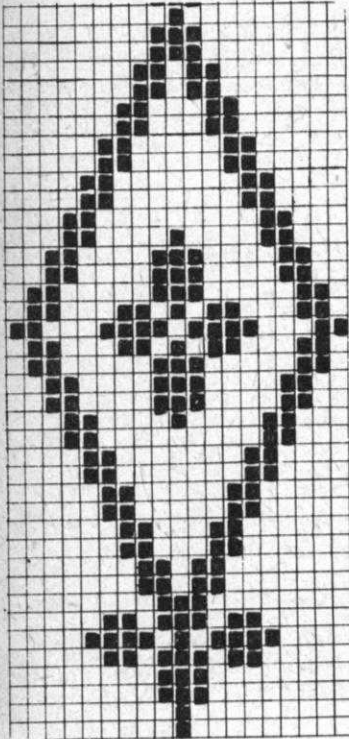

■ = weiß
□ = türkis

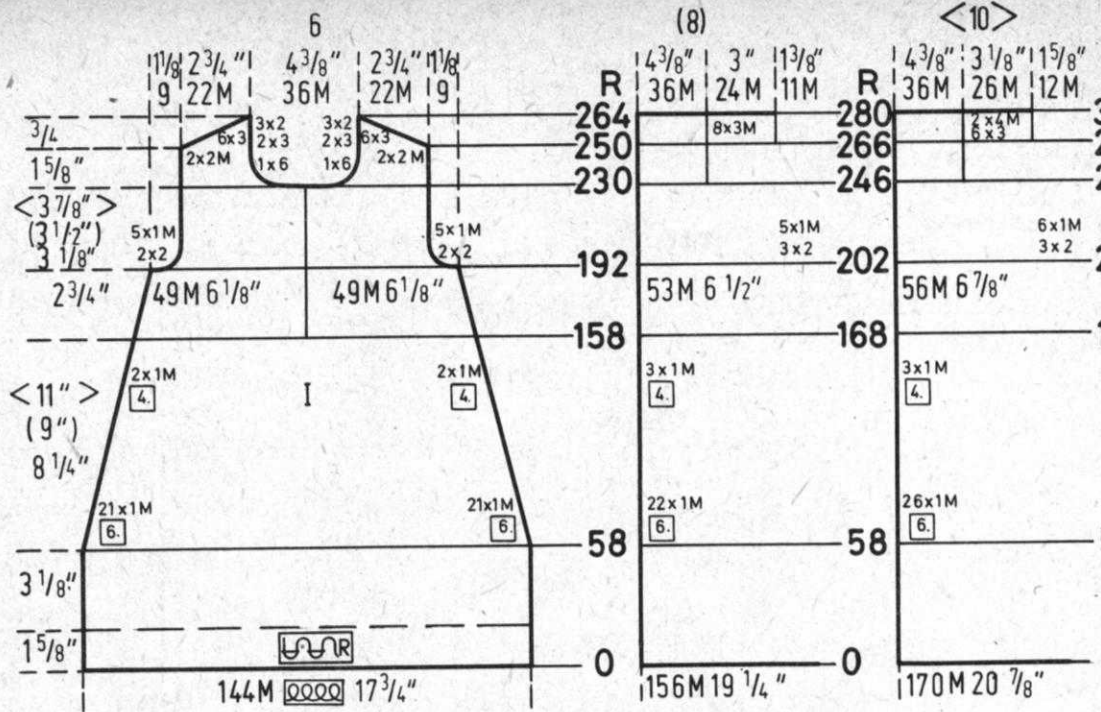

Front: I

Work the front the same as the back, but divide in center after Row 158 (168) [192] then * continue working the right half to Row 192 (202) [226] SHAPE ARMHOLE: Bind off 2 sts. 2x, 1 st. 5x (2 sts. 3x, 1 st. 5x) [2 sts. 3x, 1 st. 6x] Knit to Row 230 (246) [274]

ON NECK SIDE, bind off 6 sts. 1x, 3 sts. 2x, 2 sts. 3x and SHAPE SHOULDER after Row 250 (266) [294] bind off 2 sts. 2x, 3 sts. 6x (3 sts. 8x) [3 sts. 6x, 4 sts. 2x] Move the Cam Box to the left side, turn the Row Counter back to 158 (168) [192] and complete the left half. Follow the instructions from *.

ADJUSTABLE NEEDLE SELECTOR

Suitable for KNITTING Machines only. The Adjustable Needle Selector can be set to any needle spacing and is the perfect Tool to use with many of Patterns in this issue of KNITTING MAGAZINE.

Price: \$ 4.25 Shipping: \$.60
California residents add Sales Tax.

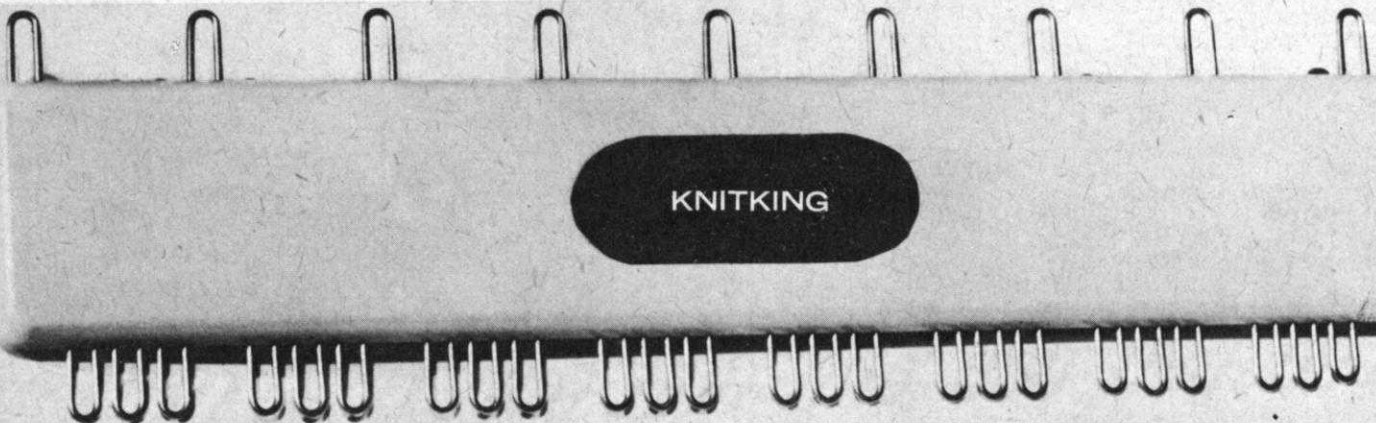

KK 30

WOMEN'S DRESS

SIZE:	4	(6)	[8]
Yarn: Allegro C1 grams	150	200	250
Allegro C2 grams	50	50	50

7 to 9

15 sts., 20 rows = 2"

Cable Design on the Front, back and Sleeves.
K1, P1 Ribbing with color stripes on the neckband and cuffs of sleeves.
The knit side is the right side.

FINISHING: See General Instructions. Work 1 row single crochet around neck opening then sew loop to 1 edge and button to other edge of neckline.

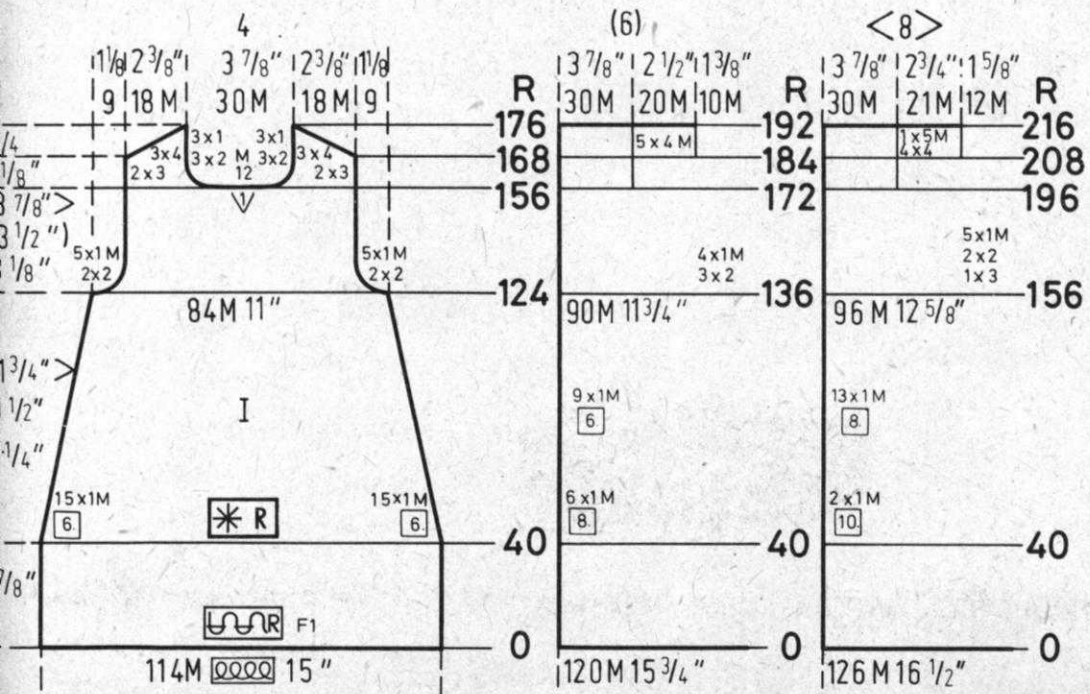
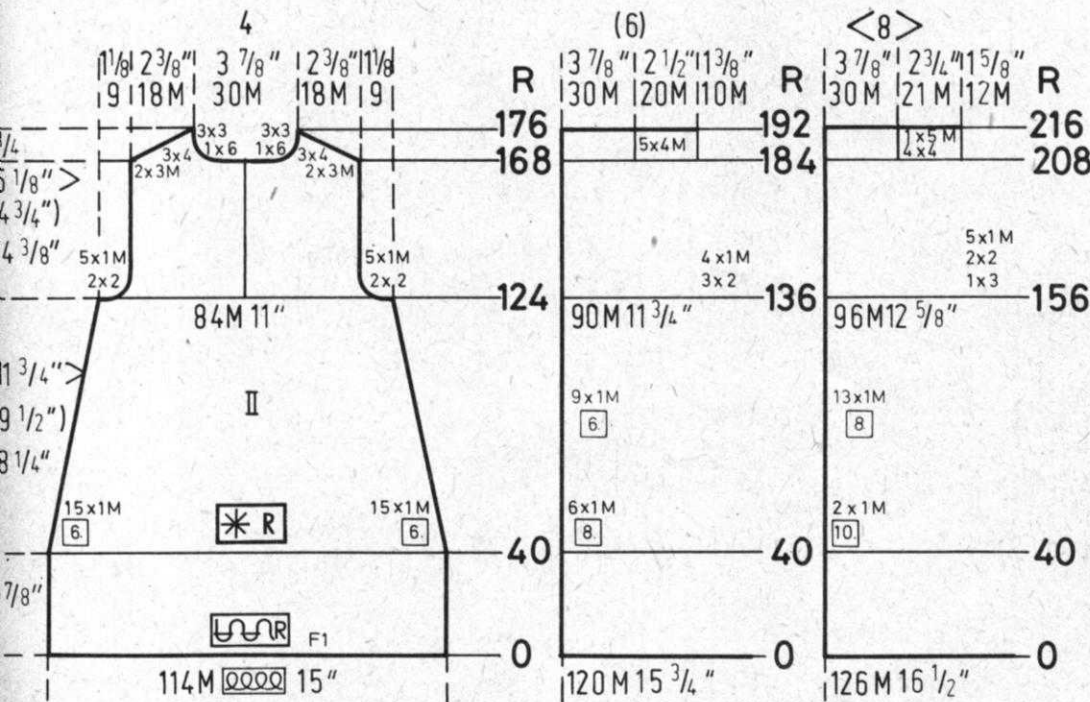

KK 30

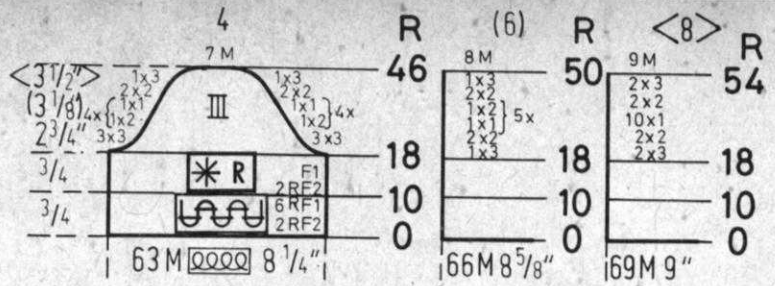

SLEEVE: III

Cast on 63 (66) [69] sts. with color 2 and work K1, P1 Ribbing of 2 rows color 2, 6 rows color 1, 2 rows color 2 then change to Pattern and continue with color 1.
Knit to Row 18.
SHAPE CAP: ON EACH SIDE, bind off

3 sts. 3x, *2 sts. 1x, 1 st. 1x and REPEAT from * 3x more; 2 sts. 2x, 3 sts. 3x (3 sts. 1x, 2 sts. 2x, *1 st. 1x, 2 sts. 1x and REPEAT from * 4x more; 2 sts. 2x, 3 sts. 1x) [3 sts. 2x, 2 sts. 2x, 1 st. 1x, 2 sts. 2x, 3 sts. 2x] After Row 46 (50) [54] bind off the remaining 7 (8) [9] sts.

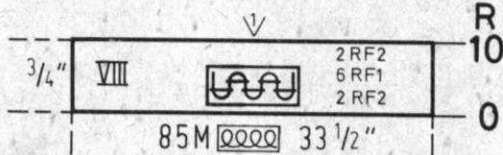
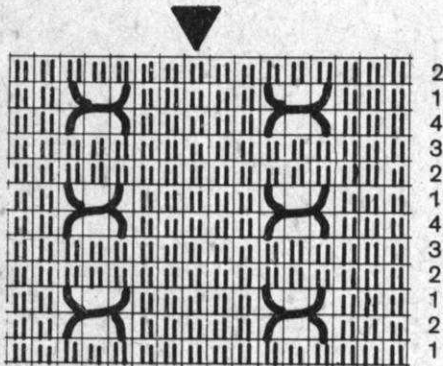

NECKBAND: VIII

Cast on 85 sts. with color 2 and work K1, P1 Ribbing 2 rows color 2, 6 rows color 1, 2 rows color 2 then bind off the crochet method for Ribbing.

ADJUSTABLE NEEDLE SELECTOR

Suitable for KNITTING Machines only. The Adjustable Needle Selector can be set to any needle spacing and is the perfect Tool to use with many of the Patterns in this issue of KNITTING MAGAZINE.

Price: \$ 4.25 Shipping: \$.60
California residents add Sales Tax.

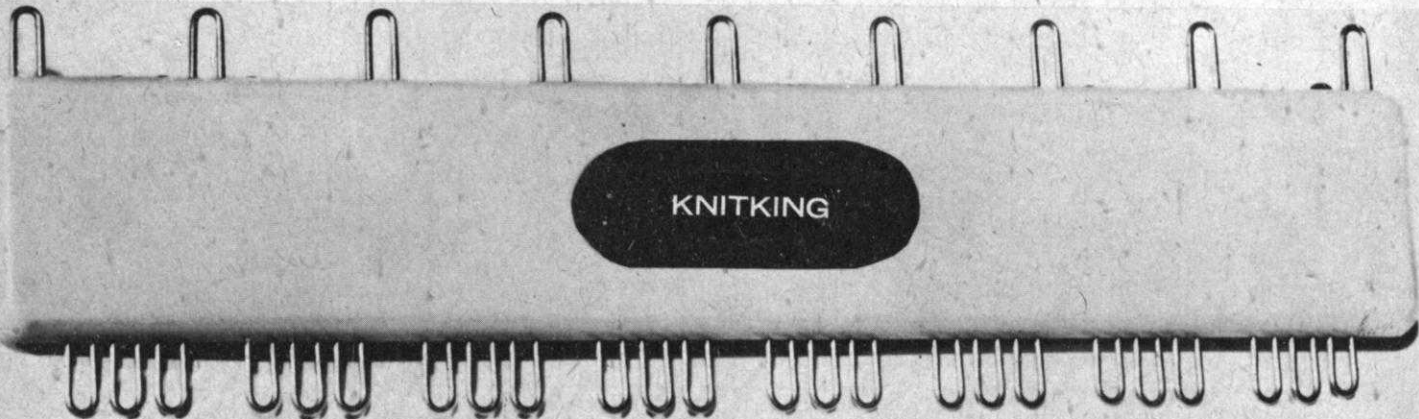

→
K17



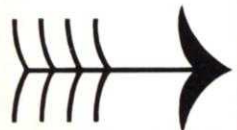

DK19





DK 20

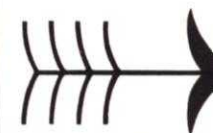

DK 1





HP23
K 27

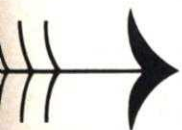
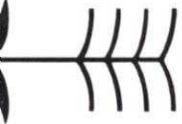

K25





← 
HP22
KK24



KK2

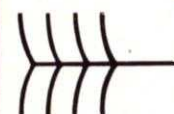
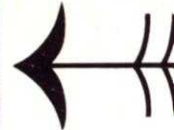

KK3
HP2





OK 2

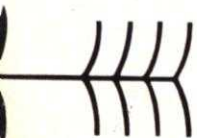
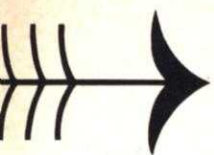

OK 29

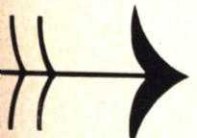

OK 26

