

knitking

magazine

NOV/DEC '75



HE 224



DK 221

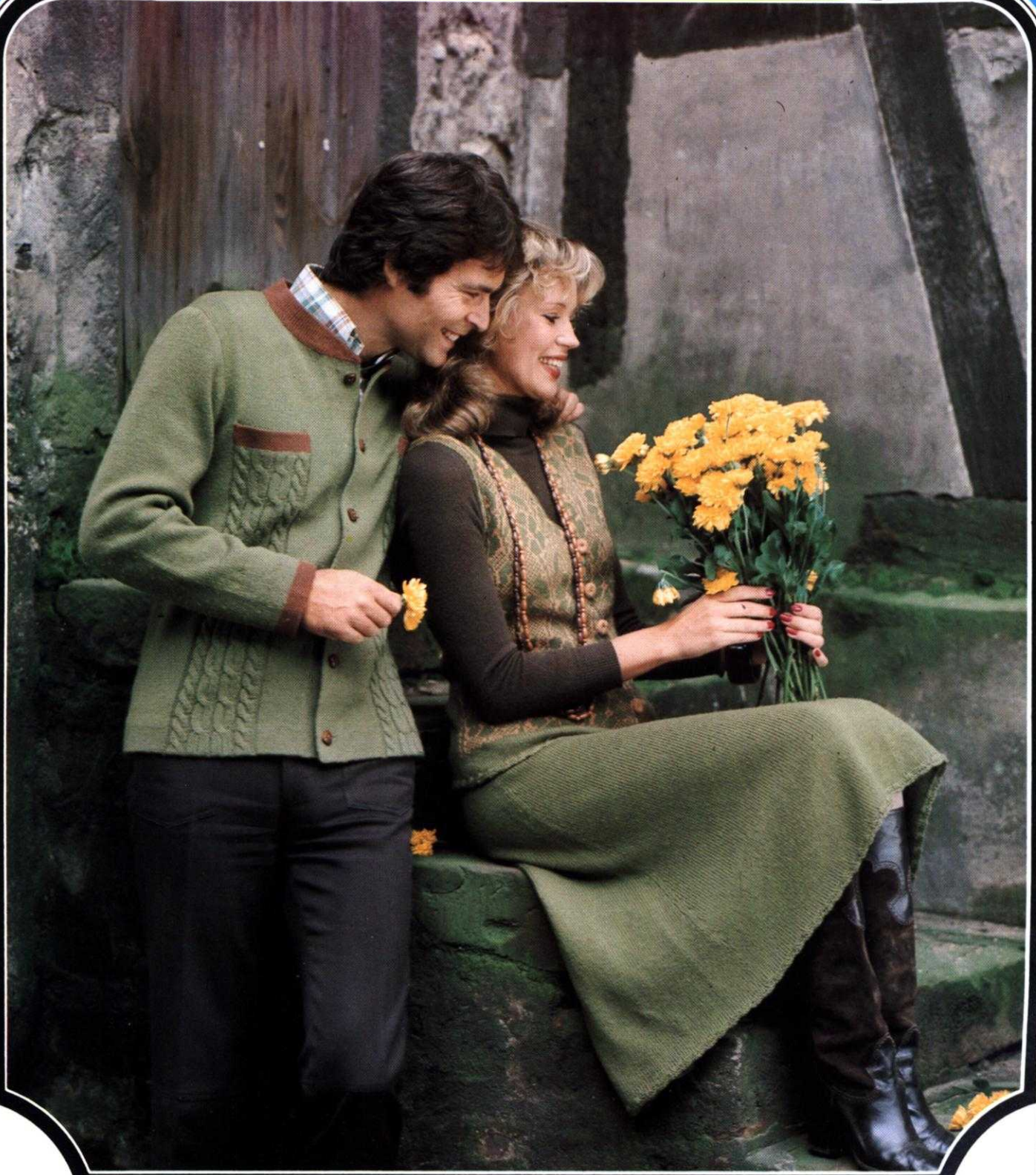

HE 225



DK 222



DK215



DK216





DK 217

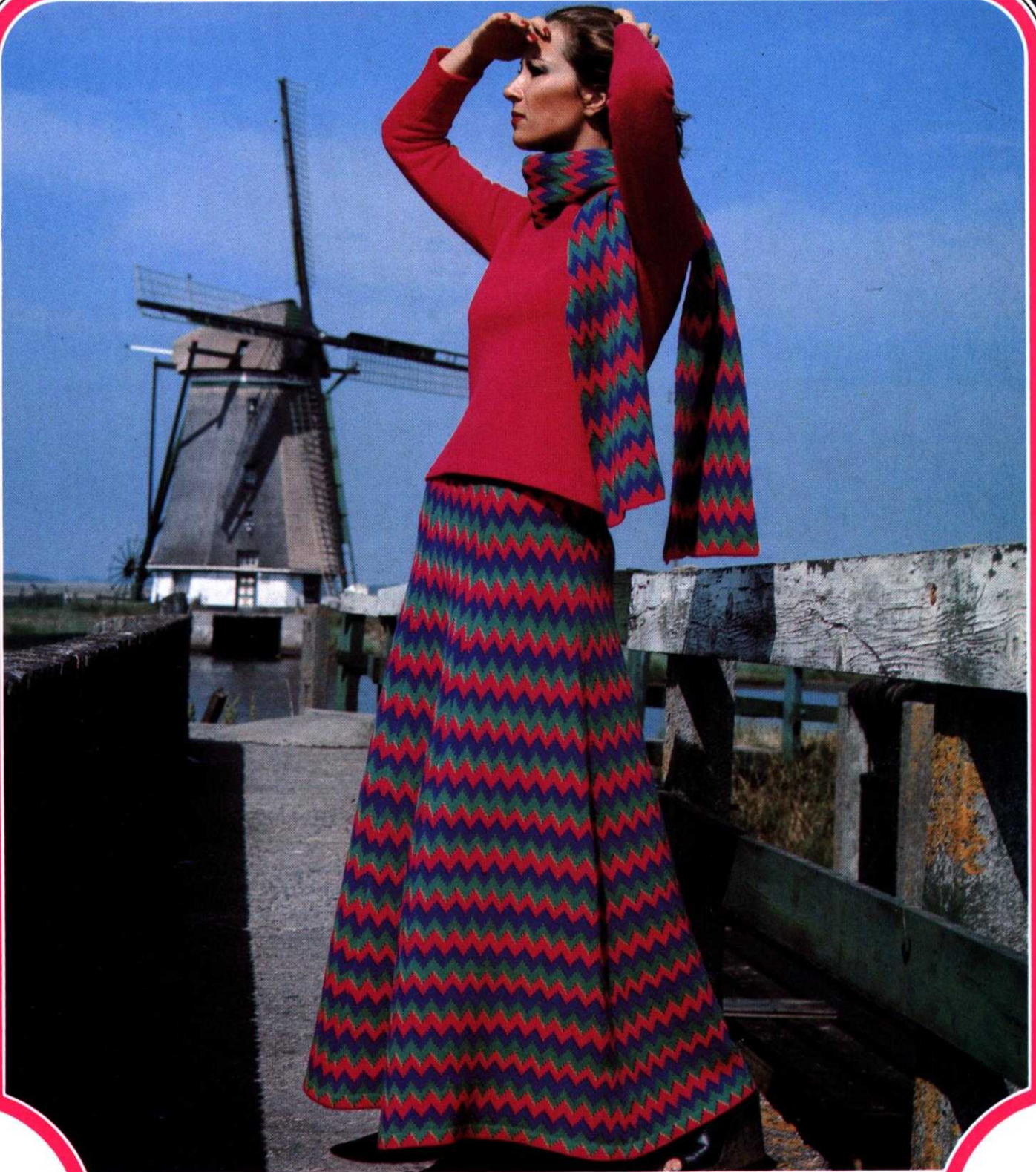

DK211



HE 226



DK 207





DK 235





DK 223



DK 214



DK 213



knitking

magazine

editorial

| TABLE OF CONTENTS | | PAGE NO. |
|-------------------|---|----------|
| DK 207 | Woman's Cardigan | 14 |
| DK 208 | Woman's Pullover | 15 |
| DK 209 | Woman's Pullover | 16 |
| DK 210 | Woman's Sleeveless Pullover | 17 |
| DK 211 | Woman's Sleeveless Pullover | 18 |
| DK 212 | Woman's Dress | 19 |
| DK 213 | Woman's Skirt | 20 |
| DK 214 | Woman's Jumper & Blouse . . | 22 |
| DK 215 | Woman's Skirt | 23 |
| DK 216 | Woman's Blouse | 24 |
| DK 217 | Woman's Skirt, Pullover & Scarf | 26 |
| DK 218 | Woman's Skirt, Top and Sleeveless Pullover | 28 |
| DK 219 | Woman's two-piece Dress . . | 30 |
| DK 220 | Woman's Dress | 31 |
| DK 221 | Woman's Skirt & Vest | 32 |
| DK 222 | Woman's Pullover | 34 |
| HP 223 | Man's Cardigan | 35 |
| HP 224 | Man's Jacket | 36 |
| HP 225 | Man's Jacket | 38 |
| HP 226 | Man's Pullover | 39 |
| KK 227 | Child's Sleeveless Pullover | 40 |
| KK 228 | Girl's Dress | 42 |
| KK 229 | Girl's Skirt & Pullover . . | 44 |
| KK 230 | Child's Pullover | 46 |
| PK 231 | Doll Ensemble | 47 |
| KK 232 | Infant Saque with Hood and Booties | 48 |
| KK 233 | Infant Blanket | 48 |
| RS 234 | Pillow | 49 |
| DK 235 | Scarf | 49 |

We really pulled out all the stops for this issue... and we caught up a bit more on time... Tony, our art and layout man certainly displayed his considerable talent in the preparation of the color pages... our photographer did a marvelous job with the excellent garments provided by our design studio and our new printer proved himself to be a master of his trade in completing the beautiful issue you have in your hand..

It is wonderful to be able to write an Editorial without apologizing for problems of publication... We are back in the groove and in control again...

Thanks for all the nice letters telling us how you liked the SEPTEMBER/OCTOBER edition... We are already planning the layout for the JANUARY/FEBRUARY issue and we promise some lovely garments in its pages... If your subscription is due for renewal, please be sure to place it now... Don't miss any of the exciting issues we are preparing for 1976.

Because of the many problems we had in 1975 and because our addressing machine sometimes does not kick out all renewal notices in the correct order, you may have missed an issue... Editions for the last year were SEPT/OCT 1974, NOV/DEC 1974, MARCH/APRIL 1975, MAY/JUNE 1975, JULY 1975, and SEPT/OCT 1975... If you are missing any of these issues, please write and tell us so that we can send them to you.



Publisher: KNITKING CORPORATION, 1128 Crenshaw Blvd., Los Angeles, Calif. 90019. Telephone: (213) 938-2079. Published bi-monthly. Subscriptions: USA — \$10.00 annually, single copies \$3.00; Canada — \$12.00; other parts of the world — \$15.00. The entire contents of KNITKING MAGAZINE are copyright and must not be reproduced in any shape or form without the express permission, in writing of the publisher. © COPYRIGHT 1975 by KNITKING CORPORATION.

Pattern Symbols

Knitting — Chart Symbols

- Size Symbols
() 2nd Size
< > 3rd Size
- B** Beginners Pattern
T Tension
G Gauge
① Color Number
- Cast on
N Stitch
R Row
H Hem
 Bind off
- Stockinette stitch — worn on the Knit side.
 Stockinette stitch — worn on the Purl side.
 Knit 1, Purl 1 Ribbing
 Ribbing Pattern — worn on the Knit side.
 Ribbing Pattern — worn on the Purl side.
- Closed Dart
 Open Dart
 Put on a stitch holder
 Reverse 1 section
 On every other needle
 Number of Rows between Shapings. Make increase (or decrease) FIRST, then knit 4 rows. For example: 3 x 1 means decrease (or increase) 1 st., knit 4 rows; decrease 1 st., knit 4 rows; decrease 1 st., knit 4 rows; decrease 1 st., knit 4 rows. All decreasing (or increasing) without row numbers as shown must be shaped on every 2nd row.

- Increase
 Increase 2 sts. With a transfer tool, move the sts. over the left (or right) leaving 2 empty needles at the point of increase. At the increase point, move 1 st. to the left, (or right) so that there is an empty needles on each side of a stitch. On each side of the center stitch, pick up a stitch from the row below and hang it onto the empty needle.
- 3 stitches on 1 needle. The 1st and 3rd stitch in a group of 3 has been hung on the 2nd or center needle.
- Short Row increase or decrease; for instance on a flared skirt knitted sideways.
- Pattern Stitch
 Pattern Stitch — worn on the Knit side.
 Pattern Stitch — worn on the Purl side.
 Norwegian Design using the Pattern Reader. Only 1 row must be registered on the Pattern Reader, so when knitting two or more colors in 1 row, knit the first color with the LEVER of Pattern Reader UP (working), then push the LEVER DOWN (non-working) for the additional colors.
REPEAT the above for each complete row.
- Repeat
- I = Front
II = Back
III = Sleeve
IV = Skirt Front
V = Skirt Back
VI = Collar
VII = Pocket
VIII = Band
IX = Belt
X = Cuff
XI = Pants Front
XII = Pants Back

Finishing — Chart Symbols

- Match numbers on section for assembling.
 Ease
 Fold Line
 Turn to the wrong side and hem.

Stitch Symbols

- Knit Stitch
 Purl Stitch
 Needles in holding position
 Needles back into working position.
 Empty needle (leave in working position)
 Needle not used (in the out of work position).
 Two stitches on 1 needle, either transferred from the right side or the left side, then put into holding position.
 Needle holding 2 stitches. Stitch has been transferred from the RIGHT.
 Needle holding 2 stitches. Stitch has been transferred from the LEFT.
 Center of garment section
 Pattern Reader
 JAC 40
 Adjustable Needle Selector
 Pattern Wheel
 Weaver
 Needle Shifter

General Instructions

GENERAL INSTRUCTIONS FOR THIS ISSUE

FULL FASHION DECREASING AND INCREASING

For Stockinette stitch, always use the Full Fashion method for decreasing or increasing.

TO DECREASE: Hang the 3rd stitch onto the 2nd stitch, then move the stitches in to fill the empty needle.

TO INCREASE: Move the 2 end stitches 1 needle outward, then pick up the 3rd stitch from the row below and hang it onto the empty needle.

NORWEGIAN DESIGNS

In the instructions, each row of the Norwegian Design is counted as 1 row but several movements of the Cam Box are needed to complete 1 row.

NORWEGIAN DESIGN WHEN USING THE PATTERN READER

When you use the Pattern Reader and knit a Norwegian Design using several colors, it is necessary to move the trip control lever so that only 1 row registers.

TO MAKE FRINGE

Cut yarn DOUBLE the length of fringe desired (wind around a cardboard or book). Using 2 or more strands of yarn (depending on weight of yarn) fold in half and with a crochet hook, draw folded loop through knitting from the wrong side. Pull strands through loop and tighten.

To make an additional row of knots on fringe, take half the strands from 1 group and half from the next group, then knot together approximately 1" to 2" below and continue across.

FINISHING: Block all sections. For PULLOVERS, JACKETS and DRESSES: Join front to back at sides and shoulders. Sew sleeves together and set in. Hem lower edge and sleeve edges if needed. For a double neckband or armhole band, sew 1 edge to the inside and 1 to the outside of neck or armhole. For a single ribbed band, sew 1 edge to the outside of neck or armhole edge. For a Cardigan or Jacket with buttonholes, finish buttonholes and sew on buttons.

PANTS: Join front to back at sides. Sew inside leg seams, then join center front and back. Make hem at waistline and insert elastic. Hem lower edge of pants legs.

THE SAMPLE SWATCH

Before you begin to knit any garment, you will need to knit a sample piece using the yarn you have chosen for your garment, so that you can check the stitch and row gauge which must measure the correct number of stitches and rows in 5 cm (2 inches).

For each Pattern in KNITTING MAGAZINE, we give you 3 Tension Numbers to work from and if you use the specified yarn for the garment, you should be able to get the correct stitch and row gauge using one of these numbers. Here is a very easy way to make your sample swatch and count the stitches and rows WITHOUT actually counting, by using our KNITTING CONVERTA TAPE.

Supposing the Tension Numbers for the Stitch and Row Gauge are given as 5 to 7. Set the Tension Dial to the first number which is 5. With contrast waste yarn, and using the quick cast-on method, cast on 60 stitches and knit 10 rows. Change to garment yarn and turn the Row Counter to 0. Knit 30 rows. Counting from each end, knit the 10th stitch on each side by hand with a small piece of contrast yarn. Leave the needles in working position and knit 30 rows (Row 60), then knit 4 rows with contrast waste yarn. Turn the Row Counter to 0 and the Tension Dial to 6 and with garment yarn, knit 30 rows. Mark the 10th stitch on each side as you did before, knit 30 rows, then 4 rows with contrast waste yarn. Turn the Row Counter to 0 and with Tension 7, repeat the above once more ending with 10 rows of contrast waste yarn, then remove the work from the machine by passing the Slide across the needles without yarn (sometimes called 'dropping').

Pull and stretch the sample piece both lengthwise and diagonally from corner to corner, then lengthwise again. Do not count the stitches and rows immediately, but allow the sample to rest for several hours or even over night. This will allow the stitches and rows to return to their basic form.

When your sample has rested and you are ready to count the stitches and rows, the KNITTING CONVERTA TAPE will do the figuring for you without any counting on your part. Use the Tape as follows:

To measure the stitches, pull out the Tape to measure BETWEEN the 40 stitches in the center that you marked by hand knitting with contrast waste yarn. Push the red marker on the Tape so that it points to 40 stitches on the Tape. Your stitch gauge to 5 cm (2 inches) will show in the red window on the tape. To find the number of rows in 5 cm (2 inches), place the tape to measure over 60 rows, push the red marker to 60 on the tape and your row gauge for 5 cm (2 inches) will show in the red window... Easy..? If you do not get the correct stitch and row gauge in the first part of your sample, then try the other two.

If you do not own a KNITTING CONVERTA TAPE, you must mark a 5 cm (2 inch) square in the center of the knitting, then count the number of stitches and rows within the square.



DK 207



WOMAN'S CARDIGAN

SIZE: 8/10 (12/14) [16/18]

YARN: Color 1 Summertime
Color 2 Allegro

GRAMS:

Color 1 400 450 500
Color 2 150 150 150

TENSION 5 to 7

GAUGE: 15 sts. 22 rows = 5 cm (2")

Stockinette stitch with color
Stripes on the Sleeves. The
Purl side is the right side.
Bands are K1, P1 Ribbing.

FINISHING: See General Instructions.

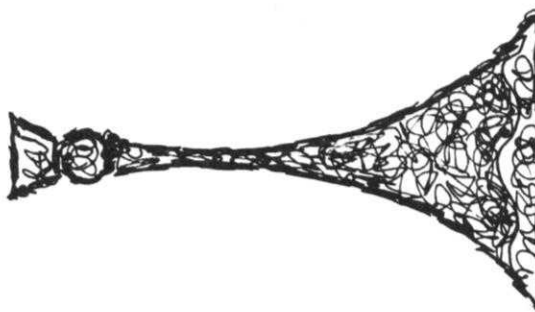

BACK: II

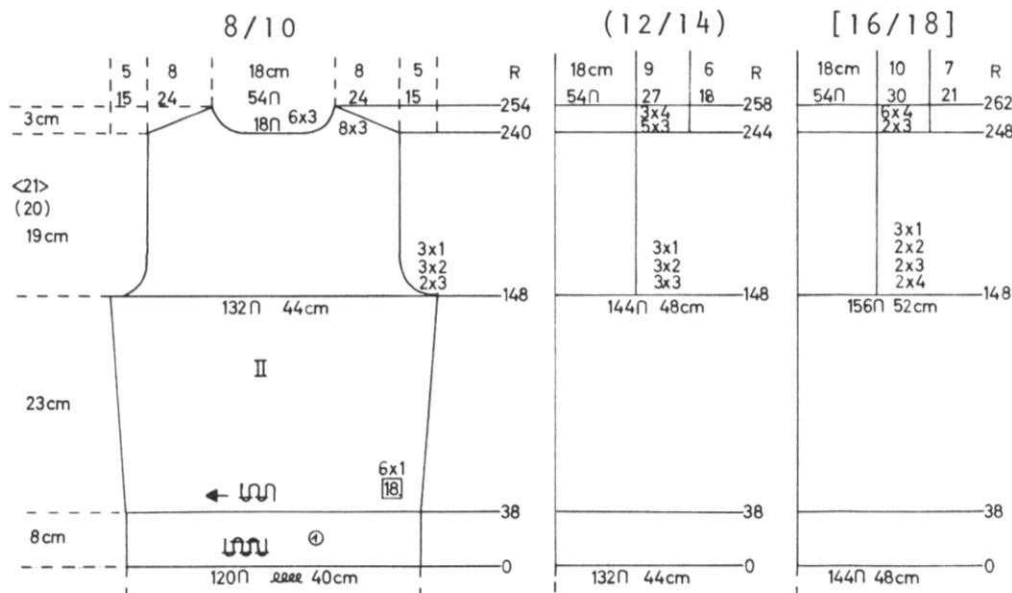

Cast on 120 (132) [144] sts. with color 1 and work 38 rows K1, P1 Ribbing. Change to Stockinette stitch.

ON EACH SIDE, increase 1 st. every 18th row 6x.

Knit to Row 148.

SHAPE ARMHOLE: ON EACH SIDE, bind off

3 sts. 2x, 2 sts. 3x, 1 st. 3x.

(3 sts. 3x, 2 sts. 3x, 1 st. 3x).

[4 sts. 2x, 3 sts. 2x, 2 sts. 2x,

1 st. 3x].

Knit to Row 240 (244) [248]. Bind

off the center 18 sts., put the

needles on the left into holding

position and complete the right

half first.

*SHAPE SHOULDER AND NECK AT THE

SAME TIME.

FOR SHOULDER, bind off

3 sts. 8x.

(3 sts. 5x, 4 sts. 3x).

[3 sts. 2x, 4 sts. 6x].

Move the Cam Box to the left side,

turn the Row Counter back to 240

(244) [248] and complete the left

half. Follow the instructions from *.

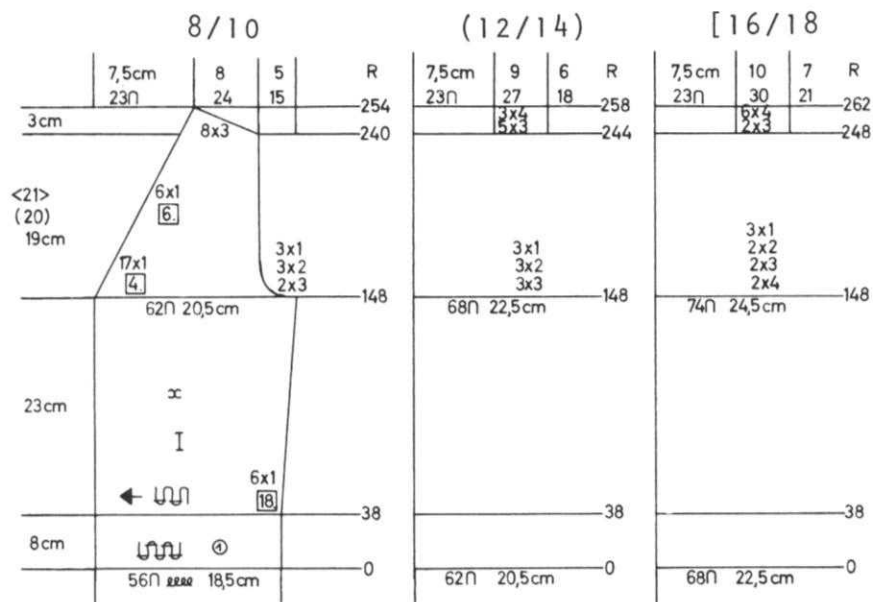

FRONT: I Make 1, reverse 1.

Cast on 56 (62) [68] sts. with color

1 and work 38 rows K1, P1 Ribbing.

Change to Stockinette stitch.

ON SIDE EDGE, increase 1 st. every

18th row 6x.

Knit to Row 148.

SHAPE ARMHOLE AND NECK AT THE SAME

TIME.

FOR ARMHOLE, make the bind-offs

the same as the back and ON NECK

SIDE, for all sizes, decrease

1 st. every 4th row 17x, every 6th

row 6x and after Row 240 (244)

[248], SHAPE SHOULDER same as the

back.

FRONT and NECK BANDS: VIII

Make 2 and omit Buttonholes in 2nd section.

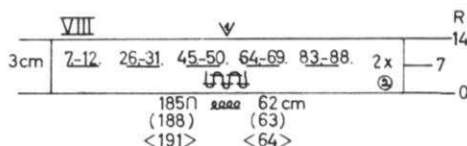

Cast on 185 (188) [191] sts. with

color 2 and work K1, P1 Ribbing.

After Row 7, make BUTTONHOLES over

the needles as shown on the Chart.

After Row 14, bind off the crochet

method for Ribbing.

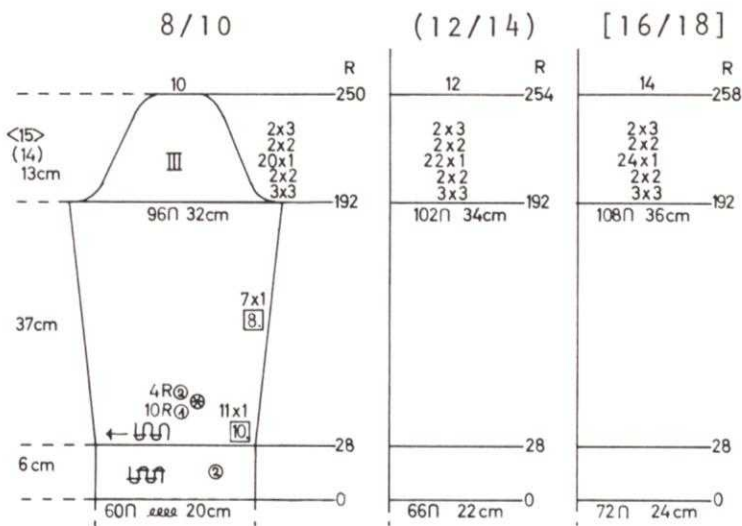

SLEEVE: III

Cast on 60 (66) [72] sts. with color 2 and work 28 rows K1, P1 Ribbing. Change to Stockinette stitch with REPEATED color stripes as shown on the Chart and ON EACH SIDE, increase 1 st. every 10th row 11x, every 8th row 7x. Knit to Row 192. SHAPE CAP: ON EACH SIDE, bind off 3 sts. 3x, 2 sts. 2x, 1 st. 20x, 2 sts. 2x, 3 sts. 2x. (3 sts. 3x, 2 sts. 2x, 1 st. 22x, 2 sts. 2x, 3 sts. 2x). [3 sts. 3x, 2 sts. 2x, 1 st. 24x, 2 sts. 2x, 3 sts. 2x]. After Row 250 (254) [258], bind off the remaining 10 (12) [14] sts.

DK 208



WOMAN'S PULLOVER

SIZE: 8 (12) [16]
 YARN: Sport Prima
 GRAMS: 400 450 500
 TENSION: 8 to 10
 GAUGE: 14 sts. 18 rows = 5 cm (2")

Stockinette stitch with a Cable Design on the front and back sections. Follow the Line Drawing. See Practical Knitting Hint this issue.

FINISHING: See General Instructions.

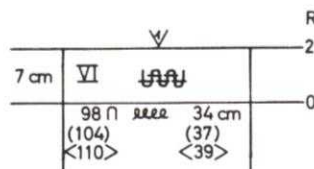

NECKBAND: VI

Cast on 98 (104) [110] sts. and work 28 rows K1, P1 Ribbing then bind off the crochet method for Ribbing.

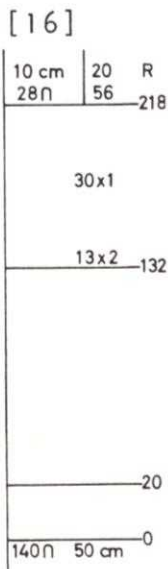
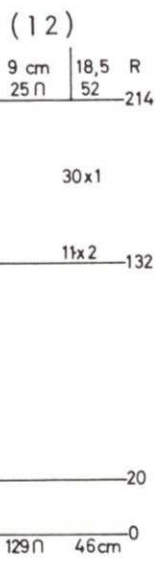
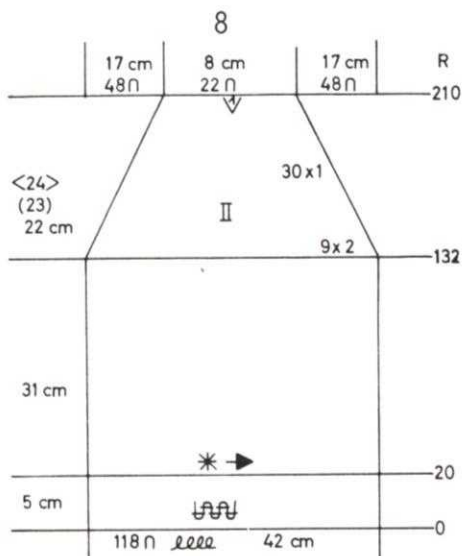

BACK: II

Cast on 118 (129) [140] sts. and work 20 rows K1, P1 Ribbing. Change to the Cable Design and knit to Row 132. SHAPE RAGLAN: ON EACH SIDE, on every 2nd row, decrease 2 sts. 9x (11x) [13x], then 1 st. 30x for all sizes. After Row 210 (214) [218], bind off the remaining 22 (25) [28] sts.

FRONT: I

Work the front the same as the back to Row 132. SHAPE RAGLAN: ON EACH SIDE, on every 2nd row, decrease 2 sts. 9x (11x) [13x] then 1 st. 26x for all sizes AND AT THE SAME TIME, after Row 192 (196) [200], bind off the center 8 (11) [14] sts., put the needles on the left into holding position and complete the right half first. *ON NECK SIDE, for all sizes, bind off 2 sts. 4x. Bring the needles on the left into working position, knit 1 row to the left side, turn the Row Counter back to 192 (196) [200] and complete the left half. Follow the instructions from *.

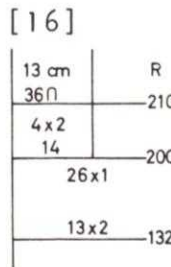
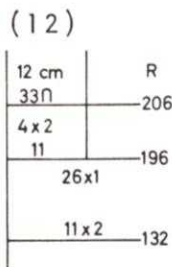
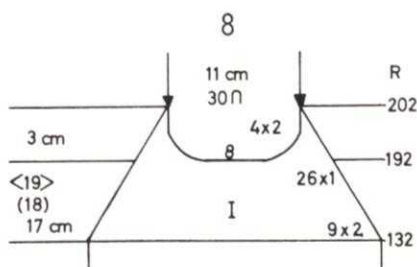

DK 208

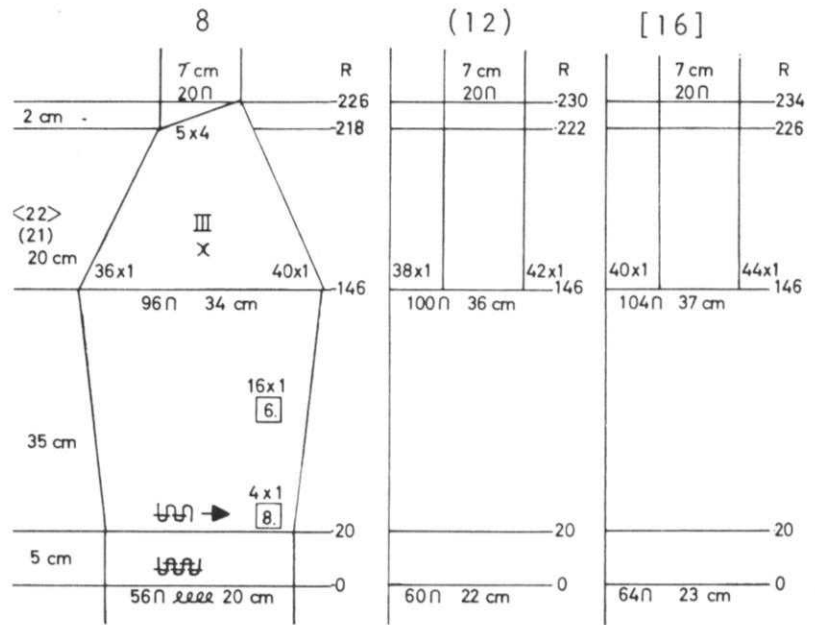
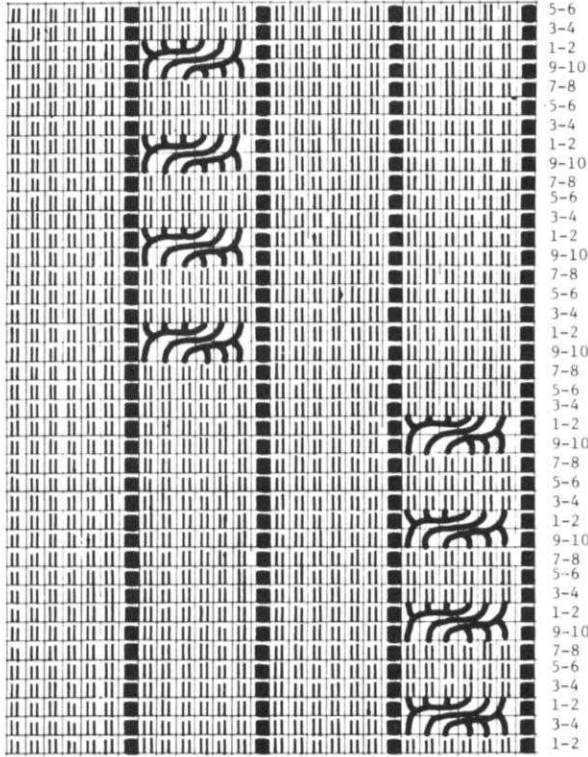

SLEEVE: III Make 1, reverse 1.

Cast on 56 (60) [64] sts. and work 20 rows K1, P1 Ribbing. Change to Stockinette stitch and ON EACH SIDE, increase 1 st. every 8th row 4x, every 6th row 16x. Knit to Row 146.

ON THE BACK SIDE OF SLEEVE, on every 2nd row, decrease 1 st. 40x (42x) [44x] and on the FRONT SIDE, decrease 1 st. 36x (38x) [40x], and after Row 218 (222) [226], work Short Rows. ON OPPOSITE SIDE OF CAM BOX, put into holding position 4 sts. 5x. After Row 226 (230) [234], bring all the needles into working position and bind off.

DK 209



WOMAN'S PULLOVER

SIZE: 14 (18) [22]
 YARN: Subita Crepe
 GRAMS: 300 350 400
 TENSION: 7 to 9
 GAUGE: Pat. 12 sts. 32 rows = 5 cm (2")

A Holding Position Design. KNITTING machine owners, use Wheel No. 4B. Follow the Line Drawing. The bands are Ribbing. Worn on the Purl side.

FINISHING: See General Instructions. Sew 1 band down the front, 1 on neck. Sew on buttons. See picture.

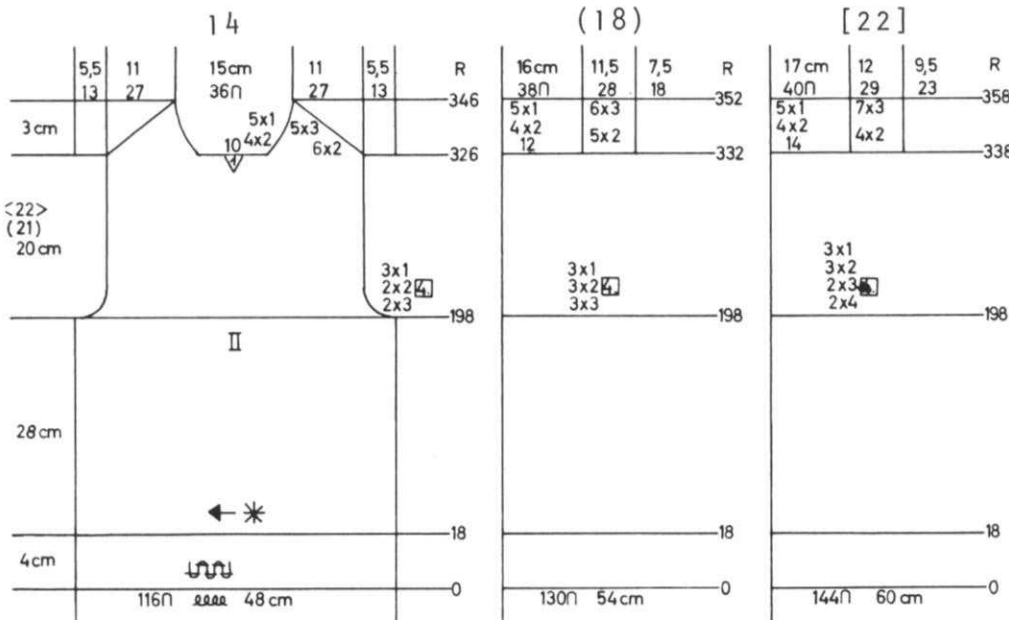
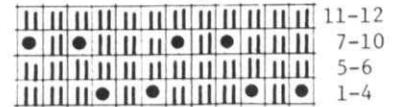

BACK: II

Cast on 116 (130) [144] sts. and work 18 rows K1, P1 Ribbing. Change to the Holding Position Design and knit to Row 198.

SHAPE ARMHOLE: ON EACH SIDE on every 4th row, bind off 3 sts. 2x, 2 sts. 2x, 1 st. 3x. (3 sts. 3x, 2 sts. 3x, 1 st. 3x). [4 sts. 2x, 3 sts. 2x, 2 sts. 3x, 1 st. 3x].

Knit to Row 326 (332) [338]. Bind off the center 10 (12) [14] sts., put the needles on the left into holding position and complete the right half first.

*SHAPE SHOULDER AND NECK AT THE SAME TIME.

FOR SHOULDER, bind off 2 sts. 6x, 3 sts. 5x. (2 sts. 5x, 3 sts. 6x). [2 sts. 4x, 3 sts. 7x].

FOR NECK, on all sizes, bind off 2 sts. 4x, 1 st. 5x. Bring the needles on the left into working position, knit 1 row in Pattern to the left side, turn the Row Counter back to 326 (332) [338] and complete the left half. Follow the instructions from *.

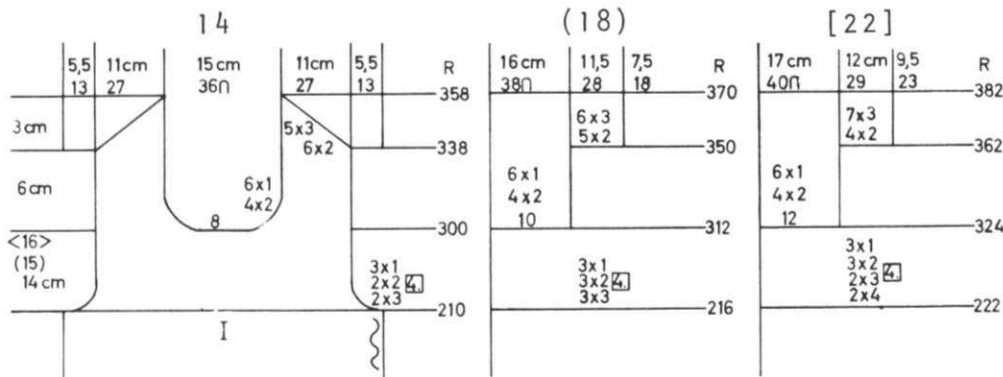

FRONT: I

Work the front the same as the back to Row 198, then knit to Row 210 (216) [222].
 SHAPE ARMHOLE same as the back then knit to Row 300 (312) [324].
 Bind off the center 8 (10) [12] sts. put the needles on the left into holding position and complete the right half first.
 *ON NECK SIDE, for all sizes, bind off 2 sts. 4x, 1 st. 6x.
 Knit to Row 338 (350) [362] then SHAPE SHOULDER same as the back. Bring the needles on the left into working position, knit 1 row in Pattern to the left side, turn the Row Counter back to 300 (312) [324] and complete the left half. Follow the instructions from *.

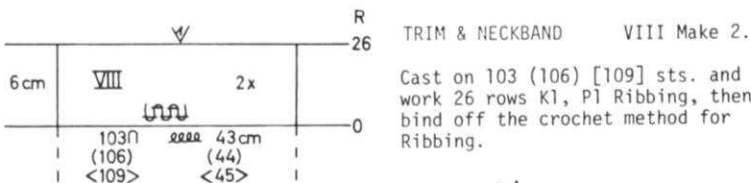

TRIM & NECKBAND VIII Make 2.

Cast on 103 (106) [109] sts. and work 26 rows K1, P1 Ribbing, then bind off the crochet method for Ribbing.

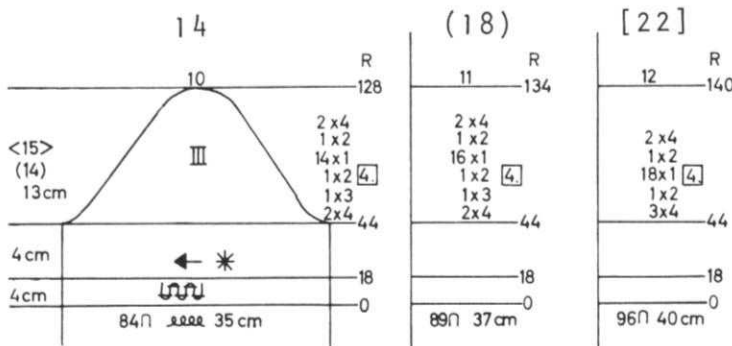

SLEEVE: III

Cast on 84 (89) [96] sts. and work 18 rows K1, P1 Ribbing.
 Change to the Holding Position Design and knit to Row 44.
 SHAPE CAP: ON EACH SIDE, on every 4th row, bind off
 4 sts. 2x, 3 sts. 1x, 2 sts. 1x, 1 st. 14x, 2 sts. 1x, 4 sts. 2x. (4 sts. 2x, 3 sts. 1x, 2 sts. 1x, 1 st. 16x, 2 sts. 1x, 4 sts. 2x). [4 sts. 3x, 2 sts. 1x, 1 st. 18x, 2 sts. 1x, 4 sts. 2x].
 After Row 128 (134) [140], bind off the remaining 10 (11) [12] sts.

OK 210



WOMAN'S SLEEVELESS PULLOVER

SIZE: 6/8 (10/12) [14/16]
 YARN: Beatrice
 GRAMS: 200 250 300
 TENSION: 5 to 7
 GAUGE: 16 sts. 22 rows = 5 cm (2")

A Cable Design on the front section only. Follow the Line Drawing. See Practical Knitting Hint this issue.

FINISHING: See General Instructions.

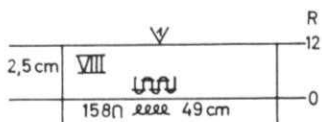
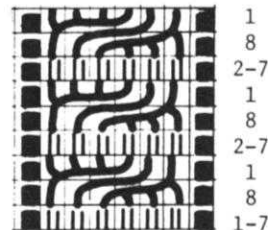

FRONT NECKBAND: VIII

Cast on 158 sts. and work 12 rows K1, P1 Ribbing, then bind off the crochet method for Ribbing.

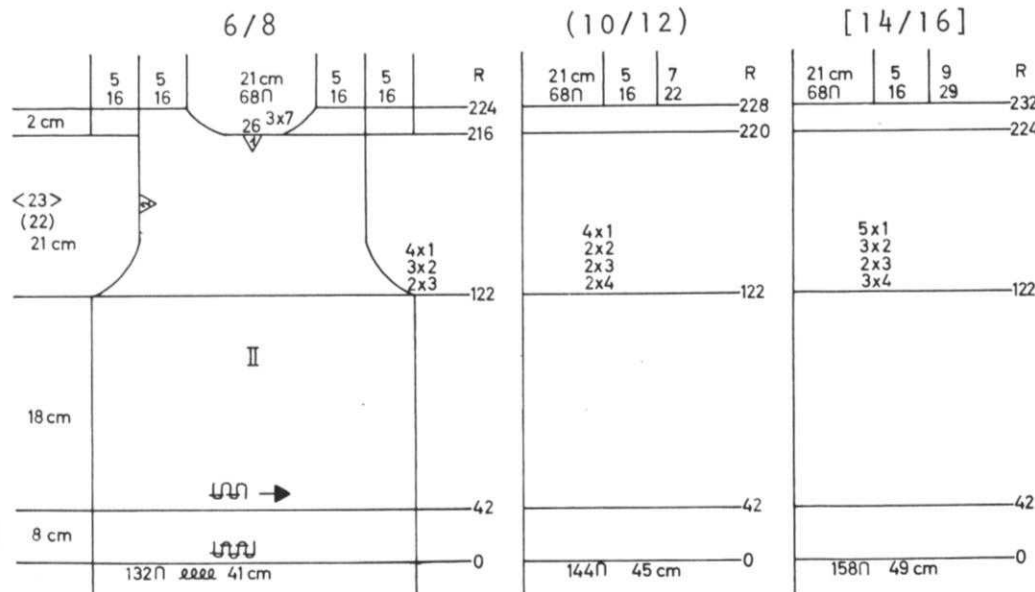

BACK: II

Cast on 132 (144) [158] sts. and work 42 rows K1, P1 Ribbing.
 Change to Stockinette stitch and knit to Row 122.
 SHAPE ARMHOLE: ON EACH SIDE, bind off 3 sts. 2x, 2 sts. 3x, 1 st. 4x. (4 sts. 2x, 3 sts. 2x, 2 sts. 2x, 1 st. 4x). [4 sts. 3x, 3 sts. 2x, 2 sts. 3x, 1 st. 5x].
 Knit to Row 216 (220) [224]. Bind off the center 26 sts., put the needles on the left into holding position and complete the right half first.
 *ON NECK SIDE, for all sizes, bind off 7 sts. 3x.
 After Row 224 (228) [232], bind off the remaining 16 sts.
 Move the Cam Box to the left side, turn the Row Counter back to 216 (220) [224] and complete the left half. Follow the instructions from *.



Continued

OK 210

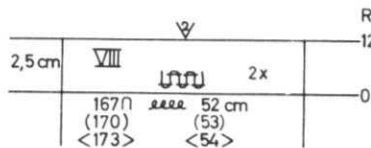

ARMBANDS: VIII Make 2.

Cast on 167 (170) [173] sts. and work 12 rows K1, P1 Ribbing then bind off the crochet method for Ribbing.

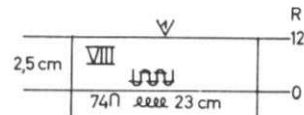

BACK NECKBAND: VIII
Cast on 74 sts. and work 12 rows K1, P1 Ribbing then bind off the crochet method for Ribbing.

6/8

(10/12)

[14/16]

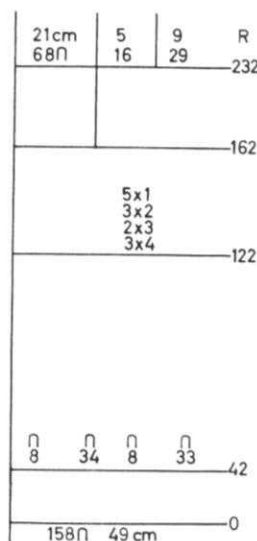
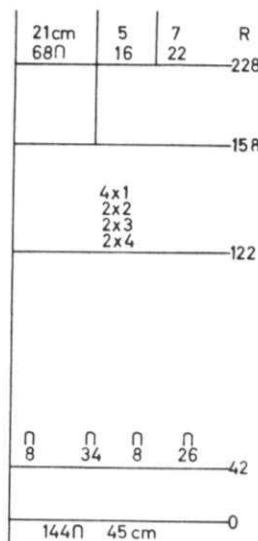
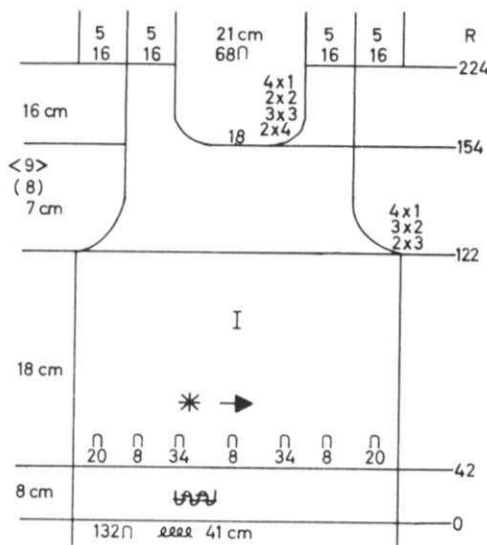

FRONT: I
Cast on 132 (144) [158] sts. and work 42 rows K1, P1 Ribbing. Change to the Cable Design. Follow the Chart and the Line Drawing. Knit to Row 122. SHAPE ARMHOLE same as the back then knit to Row 154 (158) [162]. Bind off the center 18 sts., put the needles on the left into holding position and complete the right half first. *ON NECK SIDE, for all sizes, bind off 4 sts. 2x, 3 sts. 3x, 2 sts. 2x, 1 st. 4x. After Row 224 (228) [232], bind off the remaining 16 sts. Bring the needles on the left into working position, knit 1 row to the left side, turn the Row Counter back to 154 (158) [162] and complete the left half. Follow the instructions from *.

OK 211

WOMAN'S SLEEVELESS PULLOVER



SIZE: 12 (14) [16]
YARN: Beatrice Silver or Venetia
GRAMS: 200 250 300
TENSION: 6 to 8
GAUGE: 15 sts. 20 rows = 5 cm (2")

Stockinette stitch with K1, P1 Ribbing for the Bands.

FINISHING: See General Instructions.

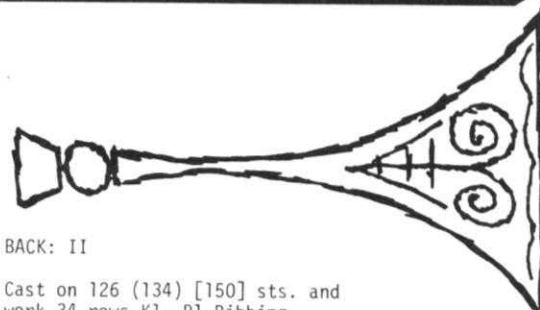

BACK: II

Cast on 126 (134) [150] sts. and work 34 rows K1, P1 Ribbing. Change to Stockinette stitch and ON EACH SIDE, increase 1 st. every 16th row 4x, every 14th row 2x. Knit to Row 126. SHAPE ARMHOLE: ON EACH SIDE, bind off 4 sts. 2x, 3 sts. 2x, 2 sts. 2x, 1 st. 3x. (4 sts. 2x, 3 sts. 3x, 2 sts. 2x, 1 st. 3x). [5 sts. 2x, 4 sts. 2x, 3 sts. 2x, 2 sts. 2x, 1 st. 2x]. Knit to Row 202 (206) [210]. Bind off the center 26 (28) [32] sts., put the needles on the left into holding position and complete the right half first. *ON NECK SIDE, for all sizes, bind off 4 sts. 5x. After Row 214 (218) [222], bind off the remaining 15 sts. Move the Cam Box to the left side, turn the Row Counter back to 202 (206) [210] and complete the left half. Follow the instructions from *.

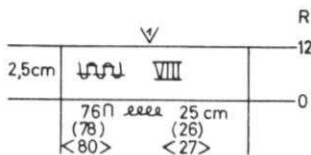
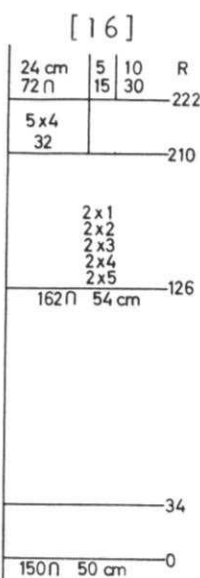
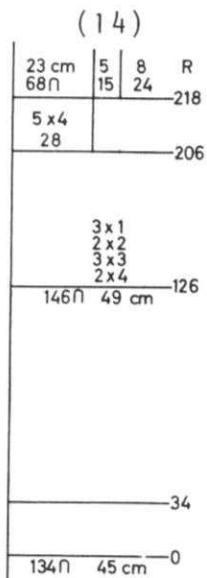
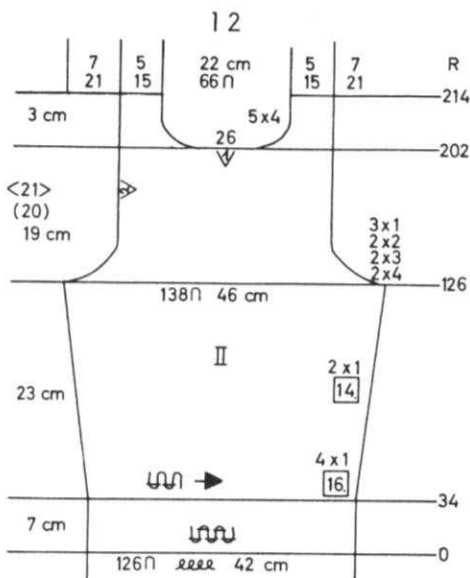

BACK NECKBAND: VIII

Cast on 76 (78) [80] sts. and work 12 rows K1, P1 Ribbing, then bind off the crochet method for Ribbing.

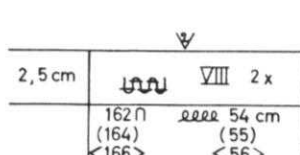

R

ARMBANDS: VIII Make 2.

Cast on 162 (164) [166] sts. and work 12 rows K1, P1 Ribbing, then bind off the crochet method for Ribbing.

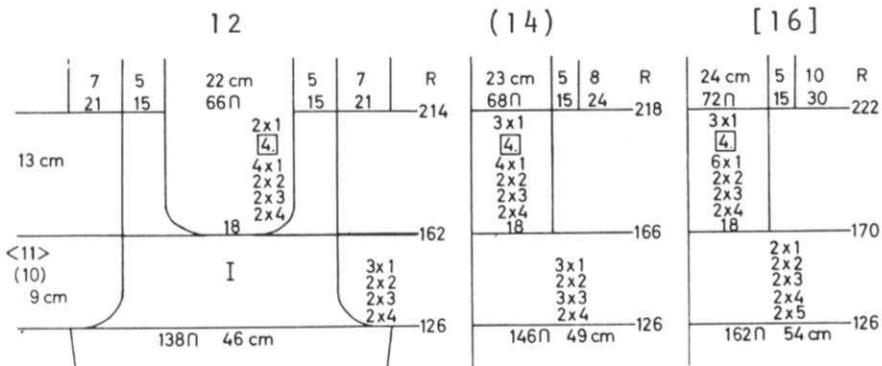
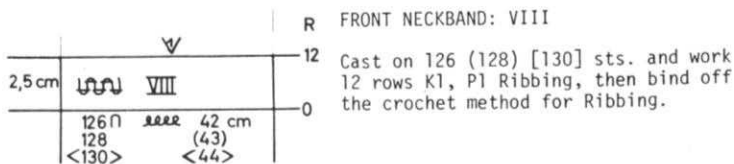

FRONT: I

Work the front the same as the back to Row 126. SHAPE ARMHOLE same as the back then knit to Row 162 (166) [170]. Bind off the center 18 sts., put the needles on the left into holding position and complete the right half first.

*ON NECK SIDE, bind off 4 sts. 2x, 3 sts. 2x, 2 sts. 2x, 1 st. 4x, then on every 4th row, 1 st. 2x. (4 sts. 2x, 3 sts. 2x, 2 sts. 2x, 1 st. 4x, then on every 4th row, 1 st. 3x). [4 sts. 2x, 3 sts. 2x, 2 sts. 2x, 1 st. 6x, then on every 4th row 1 st. 3x]. After Row 214 (218) [222], bind off the remaining 15 sts. Move the Cam Box to the left side, turn the Row Counter back to 162 (166) [170] and complete the left half. Follow the instructions from *.

DK 212



WOMAN'S DRESS

SIZE: 10/12 [14/16] [18/20]
 YARN: Color 1 Beatrice
 Color 2 Capriccio
 GRAMS:
 Color 1 450 500 550
 Color 2 150 150 150
 TENSION: Stock: 5 to 7
 Pat: 8 to 10
 GAUGE:
 Stock: 16 sts. 22 rows = 5 cm (2")
 Pat: 12 sts. 18 rows = 5 cm (2")

Bodice and Sleeve are Stockinette stitch, skirt is a Holding Position Design on the purl side. The out of work needles ARE COUNTED in the stitch gauge and instructions. KNITTING machine owners, use the Adjustable Needle Selector.

FINISHING: See General Instructions. Ease the skirt section to fit waist measurement then attach to bodice. Work 1 row single crochet around neck and sleeves then 1 row picot.

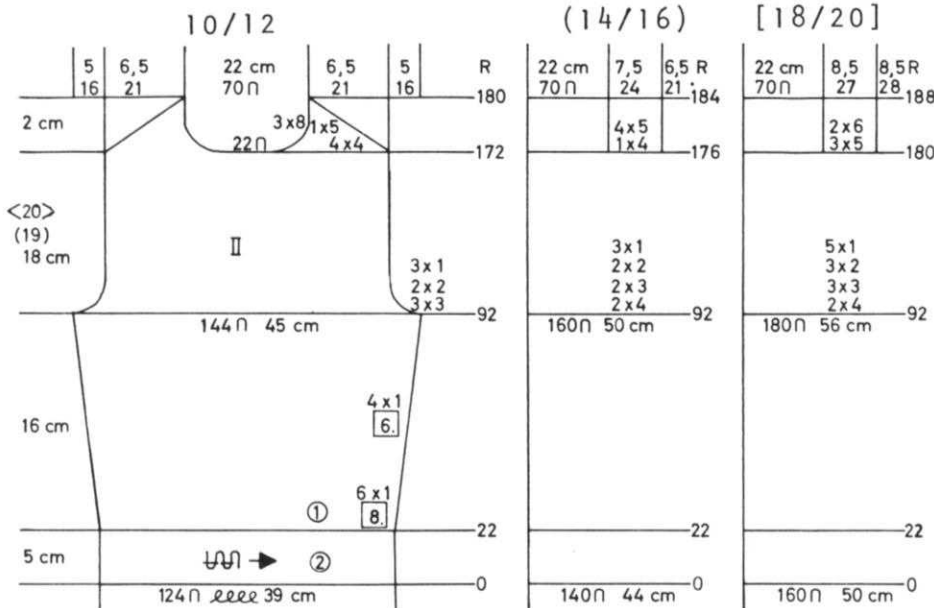

BACK BODICE: II
 Cast on 124 (140) [160] sts. with color 2 and work Stockinette stitch. Knit to Row 22, then change to color 1.
 ON EACH SIDE, increase 1 st. every 8th row 6x, every 6th row 4x. Knit to Row 92.
 SHAPE ARMHOLE: ON EACH SIDE, bind off 3 sts. 3x, 2 sts. 2x, 1 st. 3x. (4 sts. 2x, 3 sts. 2x, 2 sts. 2x, 1 st. 3x). [4 sts. 2x, 3 sts. 3x, 2 sts. 3x, 1 st. 5x]. Knit to Row 172 (176) [180]. Bind off the center 22 sts., put the needles on the left into holding position and complete the right half first.
 *SHAPE SHOULDER AND NECK AT THE SAME TIME.
 FOR SHOULDER, bind off 4 sts. 4x, 5 sts. 1x. (4 sts. 1x, 5 sts. 4x). [5 sts. 3x, 6 sts. 2x].
 FOR NECK, on all sizes, bind off 8 sts. 3x.
 Move the Cam Box to the left side, turn the Row Counter back to 172 (176) [180] and complete the left half. Follow the instructions from *.



11-12 Color 2
 7-10 Color 1
 5-6 Color 2
 1-4 Color 1



Continued

DK 212

10/12

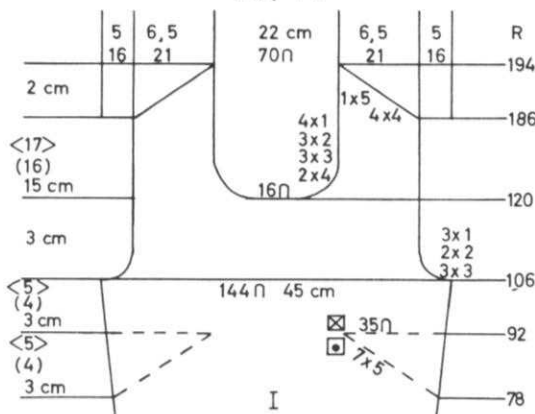

(14/16)

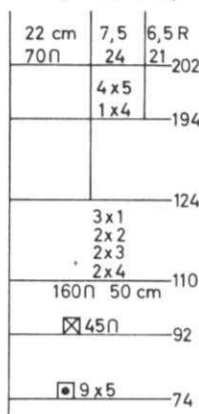

[18/20]

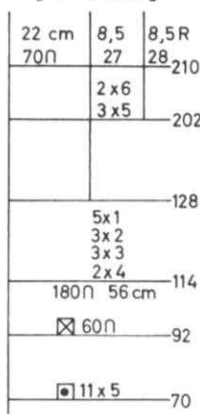

FRONT BODICE: I

Work the front the same as the back to Row 78 (74) [70], then work Short Rows for the BUST DARTS. ON OPPOSITE SIDE OF CAM BOX, put into holding position 5 sts. 7x ON EACH SIDE. (5 sts. 9x ON EACH SIDE). [5 sts. 11x ON EACH SIDE]. Bring all the needles back into working position before knitting the next 2 rows. Knit to Row 106 (110) [114]. SHAPE ARMHOLE same as the back then knit to Row 120 (124) [128]. Bind off the center 16 sts., put the needles on the left into holding position and complete the right half first. *ON NECK SIDE, for all sizes, bind off 4 sts. 2x, 3 sts. 3x, 2 sts. 3x, 1 st. 4x and SHAPE SHOULDER same as the back after Row 186 (194) [202]. Move the Cam Box to the left side, turn the Row Counter back to 120 (124) [128] and complete the left half. Follow the instructions from *.

DK 213



WOMAN'S SKIRT

SIZE: 7/8 (10/12) [14/16]
 YARN: Amore
 GRAMS:
 Color 1 650 700 750
 Color 2 250 250 250
 TENSION: 6 to 8
 GAUGE: 15 sts. 21 rows = 5 cm (2")

Stockinette stitch with a Norwegian Design. Each of 3 panels has a different Norwegian Design. Follow the Line Drawings.

FINISHING: See General Instructions. Gather the waist of skirt and sew to Waistband.

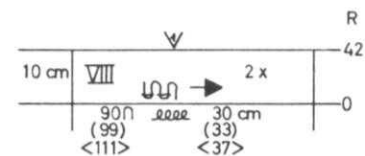

WAISTBAND: VIII Make 2.

Cast on 90 (99) [111] sts. with color 1 and work 42 rows Stockinette stitch then bind off.

PANEL 1A

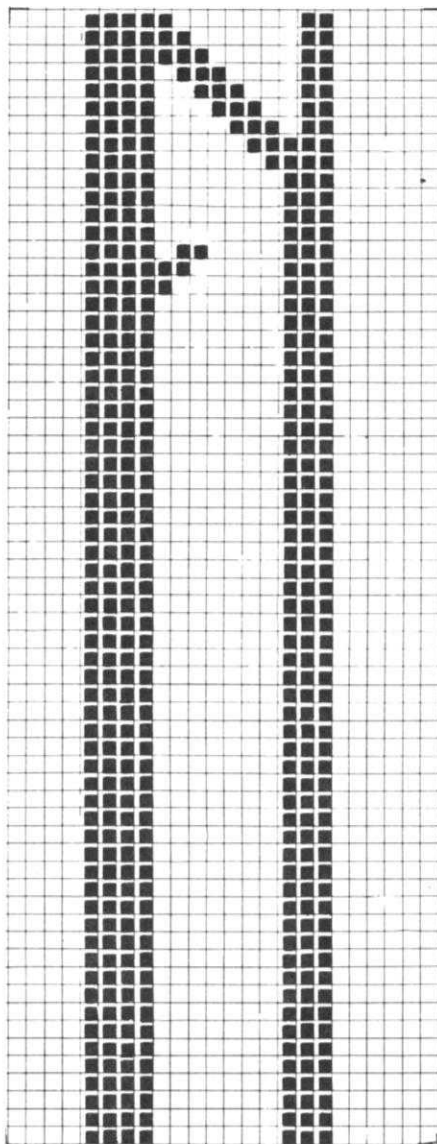

■ Color 2
 □ Color 1

PANEL 1B

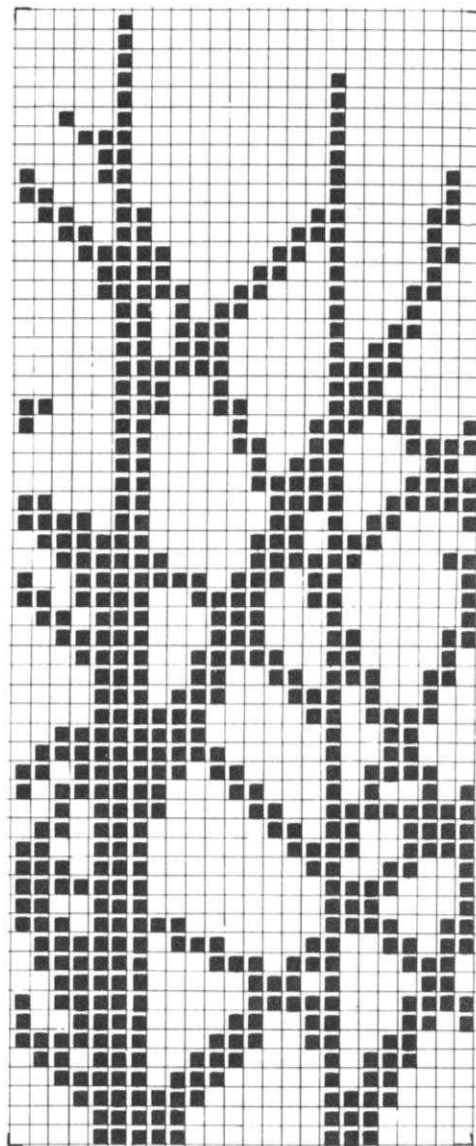

■ Color 2
 □ Color 1

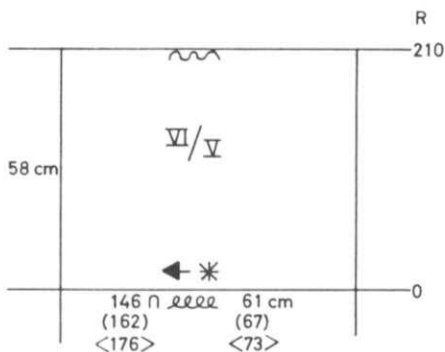

SKIRT FRONT AND BACK: V/VI

Bring 146 (162) [176] needles into working position, set into Pattern then cast on over the remaining needles in work. Work the Holding Position Design to Row 210, then bind off.



SLEEVE: III

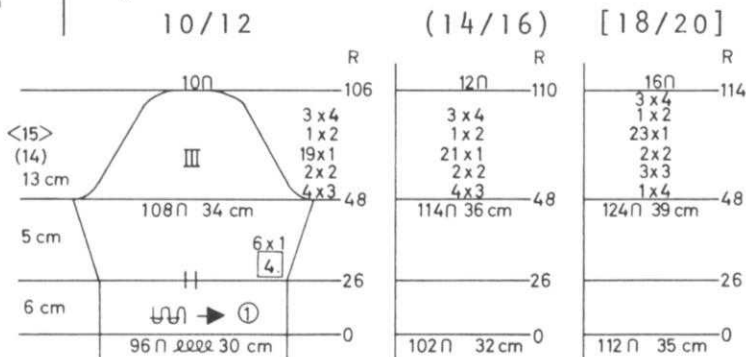

Cast on 96 (102) [112] sts. with color 1 and work Stockinette stitch. Knit to Row 26. Hang the hem. ON EACH SIDE, on every 4th row, increase 1 st. 6x. Knit to Row 48. SHAPE CAP: ON EACH SIDE, bind off 3 sts. 4x, 2 sts. 2x, 1 st. 19x, 2 sts. 1x, 4 sts. 3x. (3 sts. 4x, 2 sts. 2x, 1 st. 21x, 2 sts. 1x, 4 sts. 3x) [4 sts. 1x, 3 sts. 3x, 2 sts. 2x, 1 st. 23x, 2 sts. 1x, 4 sts. 3x]. After Row 106 (110) [114], bind off the remaining 10 (12) [16] sts.



PANEL 2

PANEL 3

7/8 (10/12) [14/16]

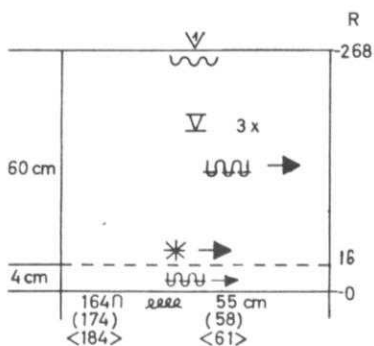

SKIRT: V Make 3 sections as follows:

Cast on 164 (174) [184] sts. with color 1 and work 16 rows Stockinette stitch. Change to the Norwegian Design and work Panel 1A followed by Panel 1B. After Row 139, change to Stockinette stitch and knit to Row 268, then bind off.

Work the other 2 Panels the same but follow the Line Drawing for Panel 2 for the 2nd section, then Panel 3 for the 3rd section. The Norwegian Design for Panel 2 will end at Row 68 and for Panel 3 at Row 74.

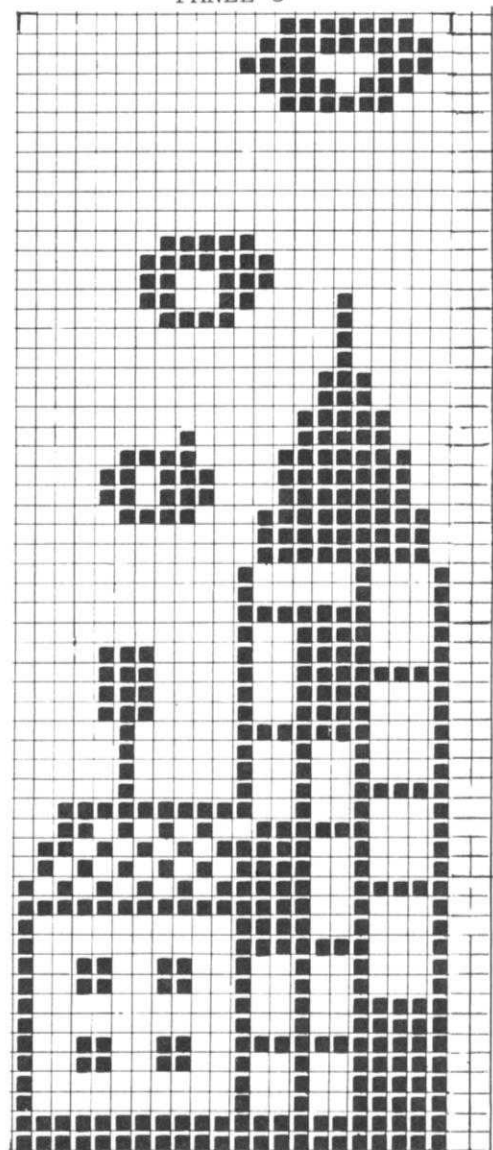
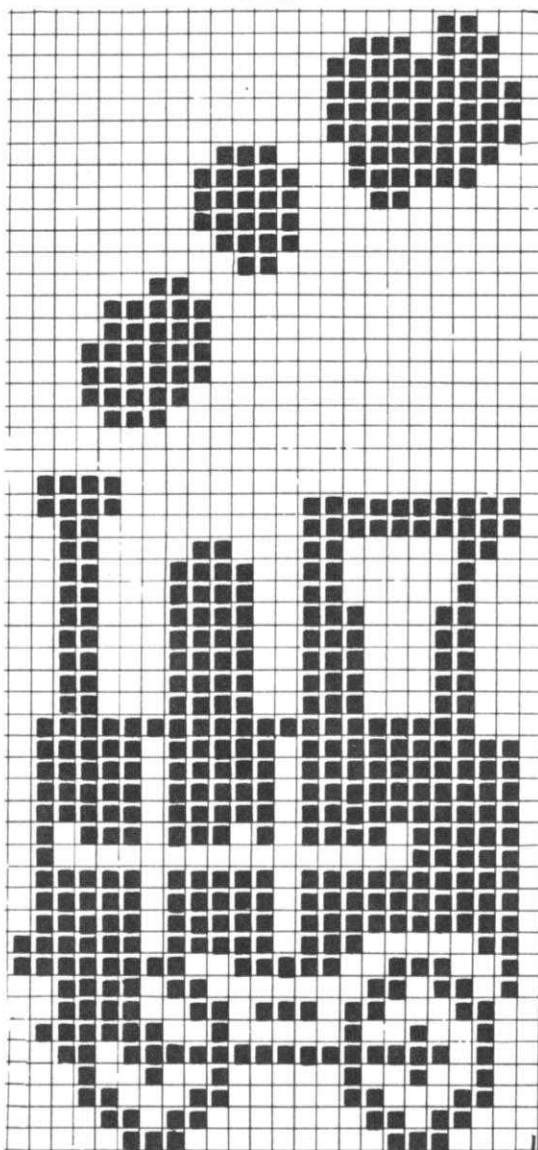

■ Color 2 □ Color 1

■ Color 2 □ Color 1

DK 214



WOMAN'S JUMPER & BLOUSE

SIZE: 7/8 (10/12) [14/16]
 YARN: Color 1 - Beatrice
 Color 2 - Combinella Fina
 Color 3 - Beatrice

GRAMS:
 Color 1 350 400 450
 Color 2 550 600 650
 Color 3 50 50 50

TENSION: Color 2 - 8 to 10
 Color 1 & 3 - 4 to 6

GAUGE:
 Color 2 - 13 sts. 19 rows = 5 cm (2")
 Color 1 & 3 - 16 sts. 22 rows = 5 cm

Blouse is Stockinette stitch with bands in contrast color.
 Jumper is Stockinette stitch.

FINISHING: See General Instructions.
 Work 1 row single crochet around neck opening.



BLOUSE BACK: II

Cast on 130 (144) [158] sts. with color 1 and work Stockinette stitch. Knit to Row 18 then hang the hem.

ON EACH SIDE, increase 1 st. every 24th row 5x.

Knit to Row 136.

SHAPE ARMHOLE: ON EACH SIDE, bind off 3 sts. 3x, 2 sts. 2x, 1 st. 3x.

(3 sts. 3x, 2 sts. 3x, 1 st. 4x).
 [4 sts. 2x, 3 sts. 2x, 2 sts. 3x, 1 st. 3x].

Knit to Row 210 (214) [218].

Bind off the center 22 sts., put the needles on the left into holding position and complete the right half first.

*SHAPE SHOULDER AND NECK AT THE SAME TIME.

FOR SHOULDER, bind off

5 sts. 3x, 4 sts. 2x.
 (5 sts. 4x, 6 sts. 1x).
 [5 sts. 1x, 6 sts. 4x].

FOR NECK, on all sizes, bind off 7 sts. 3x.

Move the Cam Box to the left side, turn the Row Counter back to 210 (214) [218] and complete the left half. Follow the instructions from *.

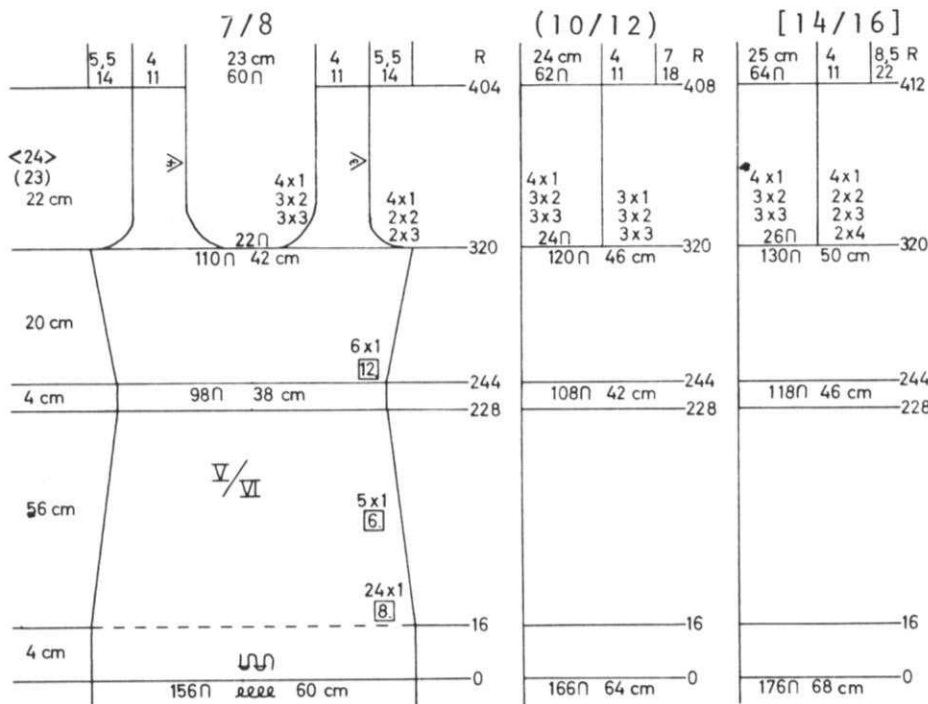
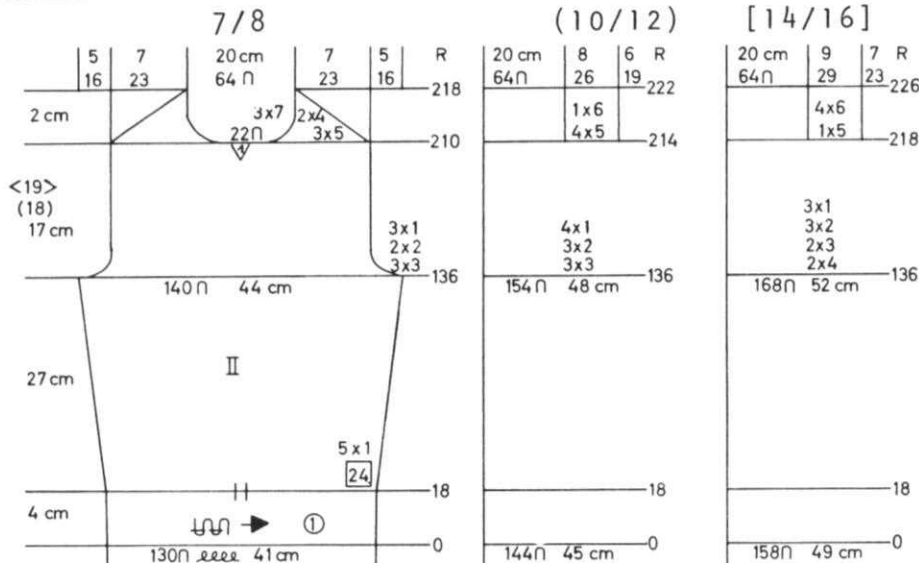

JUMPER BACK & FRONT: V/VI

Cast on 156 (166) [176] sts. with color 2 and work Stockinette stitch. Knit to Row 16.

ON EACH SIDE, decrease 1 st. every 8th row 24x, every 6th row 5x.

Knit to Row 244.

ON EACH SIDE, increase 1 st. every 12th row 6x.
 Knit to Row 320. Bind off the center 22 (24) [26] sts., put the needles on the left into holding position and complete the right half first.

*SHAPE NECK AND ARMHOLE AT THE SAME TIME.

FOR ARMHOLE, bind off 3 sts. 2x, 2 sts. 2x, 1 st. 4x.
 (3 sts. 3x, 2 sts. 3x, 1 st. 3x).
 [4 sts. 2x, 3 sts. 2x, 2 sts. 2x, 1 st. 4x].

FOR NECK, on all sizes, bind off 3 sts. 3x, 2 sts. 3x, 1 st. 4x.

Knit to Row 404 (408) [412].
 Bind off the remaining 11 sts.

Move the Cam Box to the left side, turn the Row Counter back to 320 and complete the left half. Follow the instructions from *.
 Make the 2nd section the same.

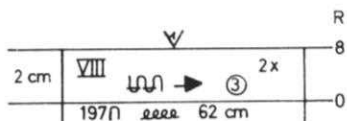

BLOUSE NECKBAND: VIII

Cast on 197 sts. with color 3 and work 8 rows Stockinette stitch then bind off.

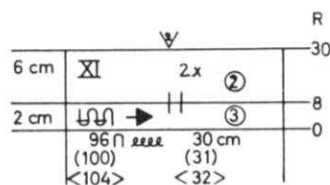

BLOUSE SLEEVE BAND: XI Make 2.

Cast on 96 (100) [104] sts. with color 3 and work Stockinette stitch. Knit to Row 8, hang the hem then change to color 2 and knit to Row 30. Bind off.



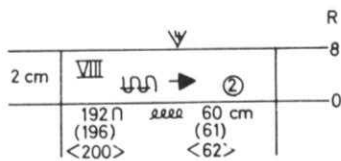

JUMPER NECKBAND: VIII

Cast on 192 (195) [197] sts. with color 2 and work 8 rows Stockinette stitch then bind off.

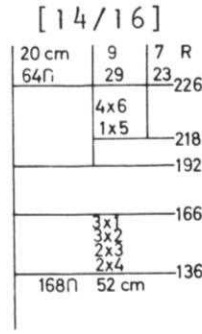
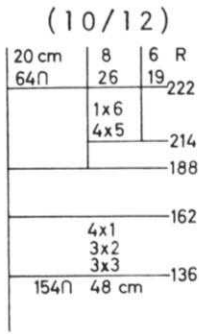
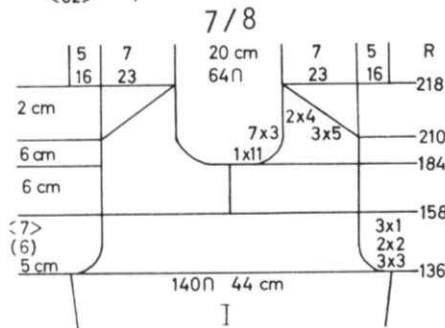

BLOUSE FRONT: I

Work the front the same as the back to Row 136. SHAPE ARMHOLE same as the back and after Row 158 (162) [166], divide in the center, put the needles on the left into holding position and complete the right half first. *Knit to Row 183 (187) [191]. ON NECK SIDE, for all sizes, bind off 11 sts. 1x, 3 sts. 7x and SHAPE SHOULDER same as the back after Row 210 (214) [218]. Move the Cam Box to the left side, turn the Row Counter back to 158 (162) [166] and complete the left half. Follow the instructions from *.

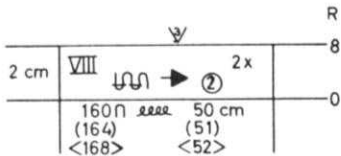

JUMPER ARMBANDS: VIII Make 2.

Cast on 160 (164) [168] sts. with color 2 and work 8 rows Stockinette stitch then bind off.

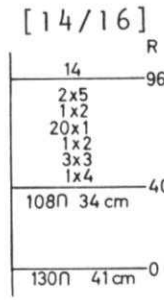
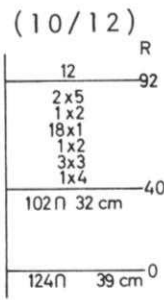
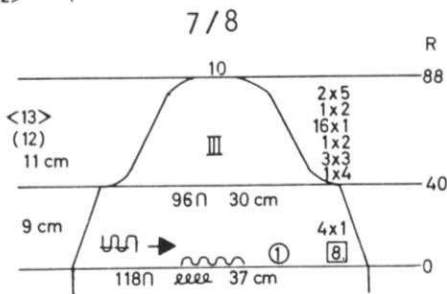

SLEEVE: III

Cast on 118 (124) [130] sts. with color 1 and work Stockinette stitch. ON EACH SIDE, decrease 1 st. every 8th row 4x. Knit to Row 40. SHAPE CAP: ON EACH SIDE, bind off 4 sts. 1x, 3 sts. 3x, 2 sts. 1x, 1 st. 16x, 2 sts. 1x, 5 sts. 2x. (4 sts. 1x, 3 sts. 3x, 2 sts. 1x, 1 st. 18x, 2 sts. 1x, 5 sts. 2x). [4 sts. 1x, 3 sts. 3x, 2 sts. 1x, 1 st. 20x, 2 sts. 1x, 5 sts. 2x]. After Row 88 (92) [96], bind off the remaining 10 (12) [14] sts.

DK 215

WOMAN'S SKIRT

SIZE: 5/6 (8/10) [12/14]
 YARN: Amore
 GRAMS:
 Color 1 550 600 650
 Color 2, 3, 4, 5, 6, 7 -100 grams
 of each color - for all sizes.
 TENSION: 5 to 7
 GAUGE: 15 sts. 21 rows = 5 cm (2")



A Norwegian Design using 3 different Patterns. Follow the Line Drawings or you can punch your own Cards.

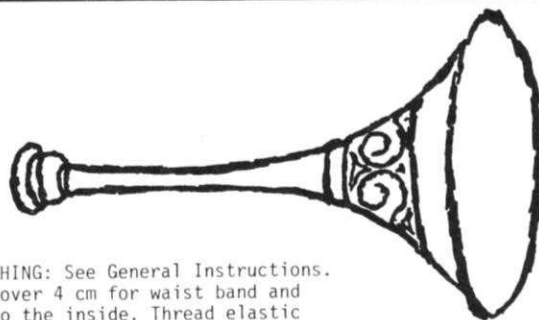

FINISHING: See General Instructions. Fold over 4 cm for waist band and sew to the inside. Thread elastic through casing.

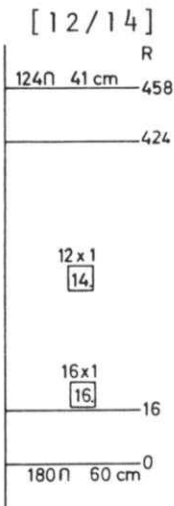
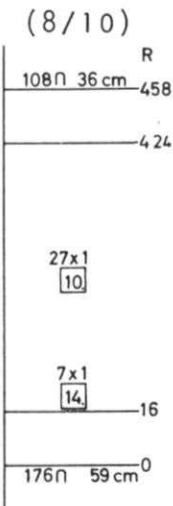
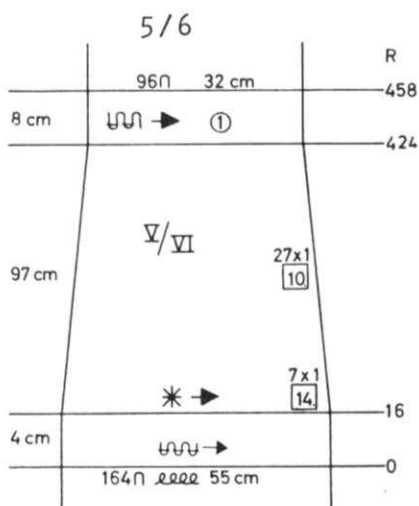

BACK & FRONT: V/VI

Cast on 164 (176) [180] sts. with color 1 and work 16 rows Stockinette stitch. Change to the Norwegian Design, following the numbered sequence on the Line Drawings and the color changes as shown. ON EACH SIDE, decrease 1 st. every 14th row 7x, every 10th row 27x. After Row 405, change to Stockinette stitch with color 1. Knit to Row 458, then bind off the remaining 96 (108) [124] sts. Make the 2nd section the same.



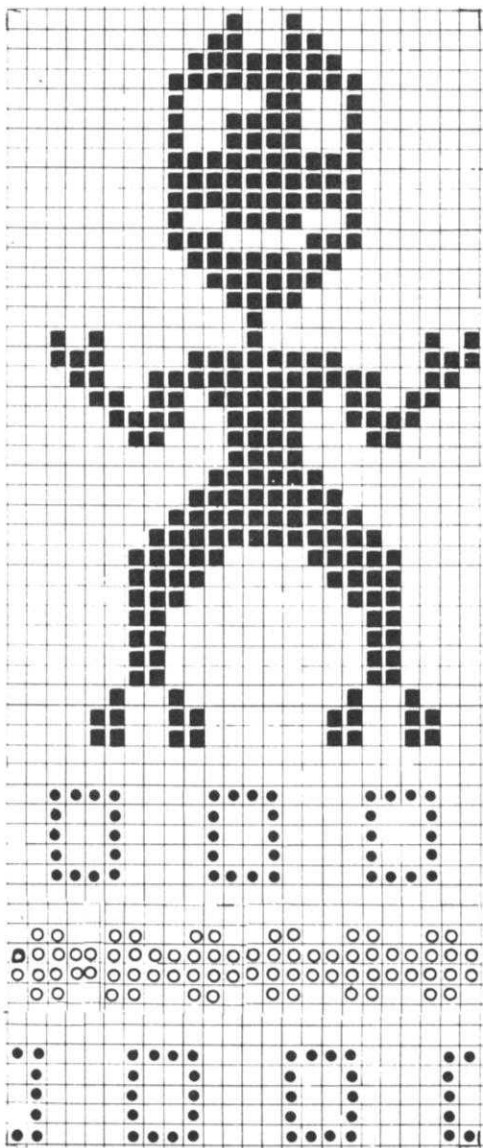

- Color 1
- Color 3
- Color 4
- Color 2

NO. 2 = 57 ROWS
NO. 5 = 57 ROWS

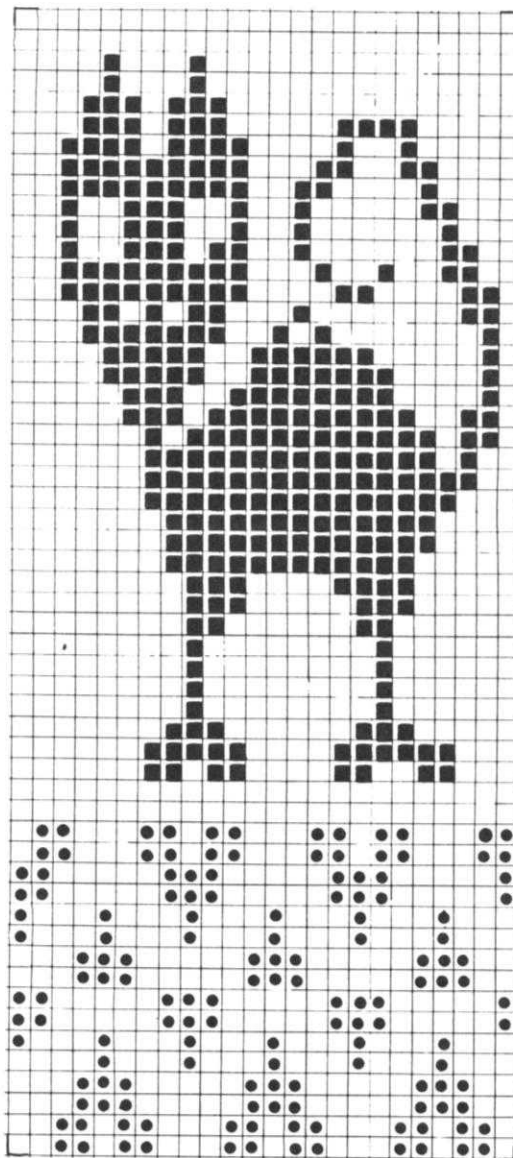

- Color 6
- Color 5
- Color 1

NO. 3 = 55 ROWS
NO. 6 = 55 ROWS

DK 216



WOMAN'S BLOUSE

SIZE: 8/10 (12/14) [16/18].
YARN: Beatrice or Venetia
GRAMS: 550 600 650
TENSION: 4 to 6
GAUGE: 16 sts. 22 rows = 5 cm (2")

Stockinette stitch worn on the purl side.

FINISHING: See General Instructions. Gather lower edge of Blouse, then sew 1 edge of Waistband to inside and 1 to the outside. Work 2 rows single crochet around neckline. Gather lower edge of sleeve to fit wrist then work 2 rows single crochet.

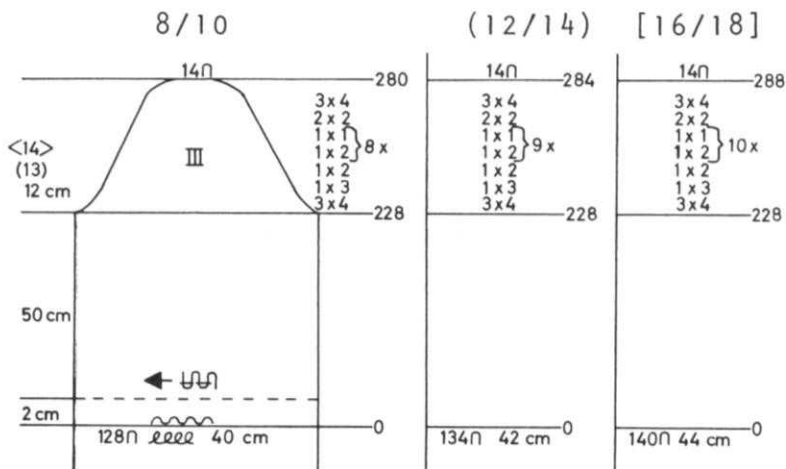

SLEEVE: III

Cast on 128 (134) [140] sts. and work Stockinette stitch. Knit to Row 228. SHAPE CAP: ON EACH SIDE, bind off

4 sts. 3x, 3 sts. 1x, 2 sts. 1x, *2 sts. 1x, 1 st. 1x and REPEAT from * 7x (8x) [9x] more, 2 sts. 2x, 4 sts. 3x. After Row 280 (284) [288], bind off the remaining 14 sts.

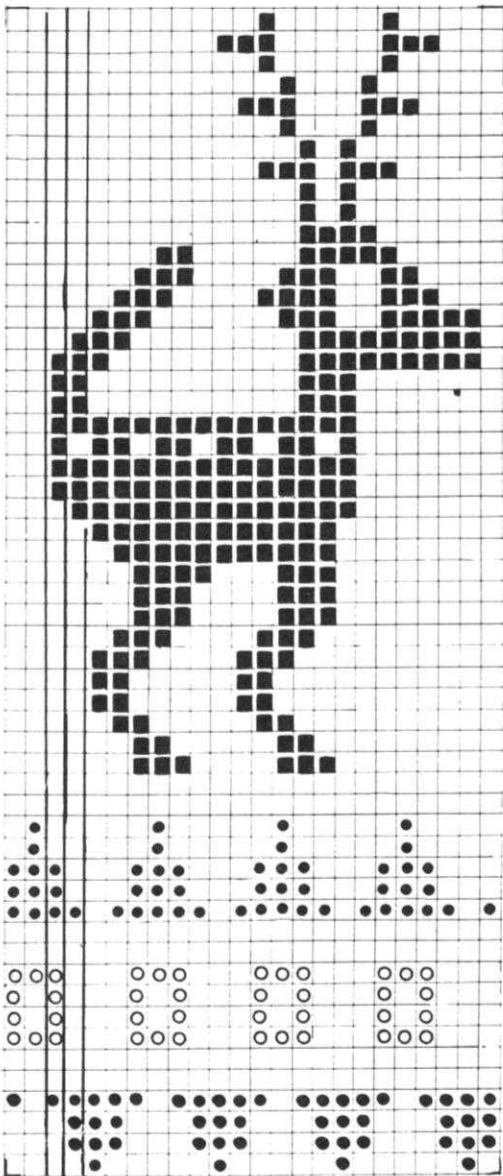

- Color 7
- Color 4
- Color 3
- Color 1



NO. 1 = 55 ROWS
 NO. 4 = 55 ROWS
 NO. 7 = 55 ROWS

BACK & FRONT: I/II

Cast on 160 (172) [184] sts. and work Stockinette stitch. Knit to Row 80.

SHAPE ARMHOLE: ON EACH SIDE, bind off 3 sts. 2x, 2 sts. 3x, 1 st. 4x. (3 sts. 3x, 2 sts. 3x, 1 st. 4x). [4 sts. 2x, 3 sts. 2x, 2 sts. 2x, 1 st. 4x].

Knit to Row 132 (136) [140]. Bind off the center 40 sts., put the needles on the left into holding position and complete the right half first.

*ON NECK SIDE for all sizes, bind off 5 sts. 2x, 4 sts. 2x, 2 sts. 2x, 1 st. 3x and AFTER ROW 158 (162) [166], SHAPE SHOULDER:

Bind off
 3 sts. 1x, 4 sts. 4x.
 (4 sts. 3x, 5 sts. 2x).
 [5 sts. 5x].

Move the Cam Box to the left side, turn the Row Counter back to 132 (136) [140] and complete the left half. Follow the instructions from *.

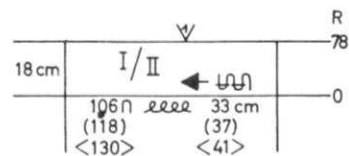
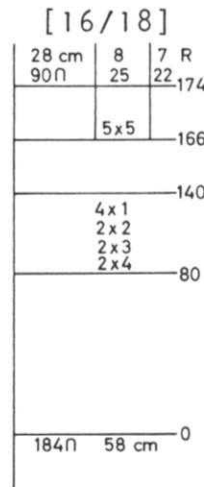
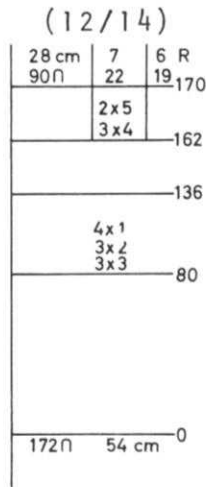
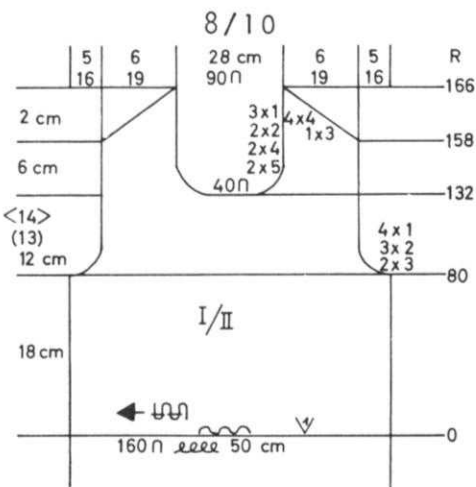

Cast on 106 (118) [130] sts. and work 78 rows Stockinette stitch then bind off.



WOMAN'S LONG SKIRT, PULLOVER & SCARF

SIZE: 7/8 (10/12) [14/16]
 YARN: Beatrice
 GRAMS:
 Color 1 800 850 900
 Color 2 350 400 450
 Color 3 350 400 450
 TENSION: 5 to 7
 GAUGE: 16 sts. 22 rows = 5 cm (2")

The Skirt and Scarf are a Norwegian Design. The Pullover is in Stockinette stitch.

FINISHING: See General Instructions.
 Scarf: With right sides together, fold in half and sew up the long edge. Turn to the right side. Fringe ends if desired.

FINISHING: See General Instructions.



PULLOVER BACK:

Cast on 134 (148) [160] sts. with color 1 and work Stockinette stitch. Knit to Row 18, then hang the hem. Knit to Row 176.
 SHAPE ARMHOLE: ON EACH SIDE, bind off 3 sts. 2x, 2 sts. 3x, 1 st. 4x. (4 sts. 2x, 3 sts. 2x, 2 sts. 2x, 1 st. 2x).
 [4 sts. 2x, 3 sts. 2x, 2 sts. 3x, 1 st. 3x].
 Knit to Row 252 (256) [260]. Bind off the center 22 sts., put the needles on the left into holding position and complete the right half first.
 *SHAPE SHOULDER AND NECK AT THE SAME TIME.
 FOR SHOULDER, bind off 4 sts. 4x, 3 sts. 1x. (4 sts. 3x, 5 sts. 2x). [5 sts. 5x].
 FOR NECK, on all sizes, bind off 7 sts. 3x.
 Move the Cam Box to the left side, turn the Row Counter back to 252 (256) [260] and complete the left half. Follow the instructions from *.

PULLOVER FRONT

Work the front the same as the back to Row 208 (212) [216]. Bind off the center 20 sts., put the needles on the left into holding position and complete the right half first.
 *ON NECK SIDE, for all sizes, bind off 4 sts. 2x, 3 sts. 2x, 2 sts. 2x, 1 st. 4x and SHAPE SHOULDER same as the back after Row 252 (256) [260].
 Move the Cam Box to the left side, turn the Row Counter back to 208 (212) [216] and complete the left half. Follow the instructions from *.

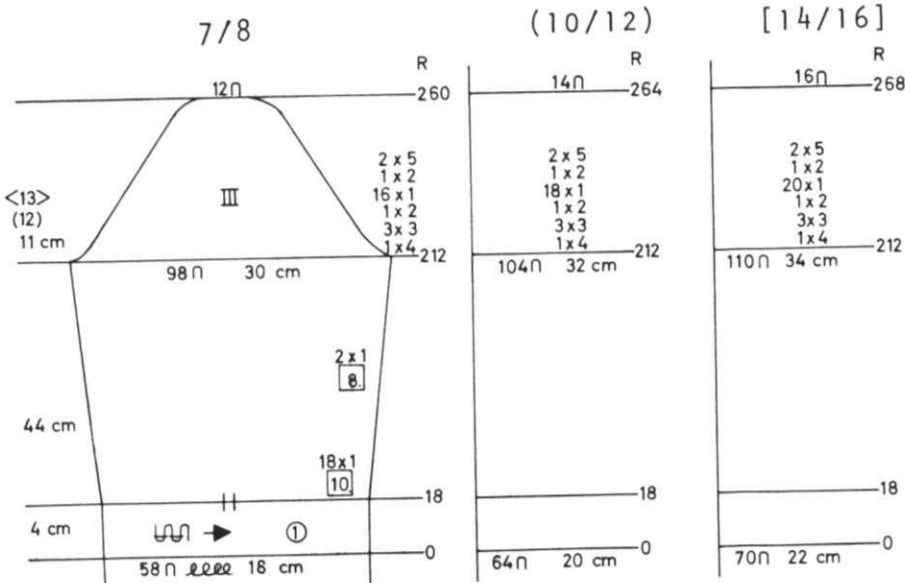
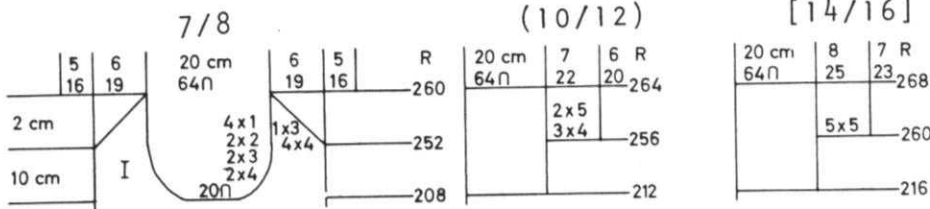
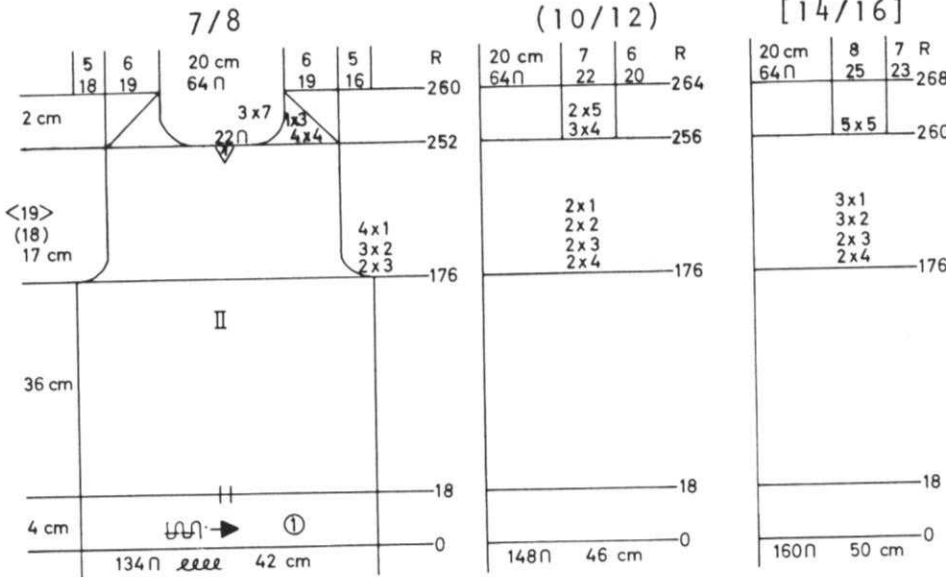

SLEEVE: III

Cast on 58 (64) [70] sts. with color 1 and work Stockinette stitch. Knit to Row 18 then hang the hem. ON EACH SIDE, increase 1 st. every 10th row 18x, every 8th row 2x. Knit to Row 212.
 SHAPE CAP: ON EACH SIDE, bind off 4 sts. 1x, 3 sts. 3x, 2 sts. 1x, 1 st. 16x, 2 sts. 1x, 5 sts. 2x. (4 sts. 1x, 3 sts. 3x, 2 sts. 1x, 1 st. 18x, 2 sts. 1x, 5 sts. 2x). [4 sts. 1x, 3 sts. 3x, 2 sts. 1x, 1 st. 20x, 2 sts. 1x, 5 sts. 2x].
 After Row 260 (264) [268], bind off the remaining 12 (14) [16] sts.

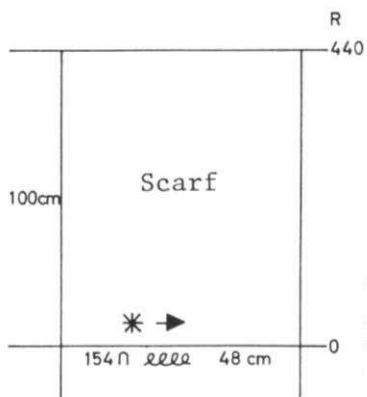

Scarf



154 σ 48 cm

SCARF

Cast on 154 sts. with color 1 and work the Norwegian Design. Knit to Row 440, then bind off.

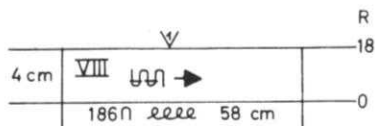

NECKBAND: VIII

Cast on 186 sts. with color 1 and work 18 rows Stockinette stitch, then bind off.

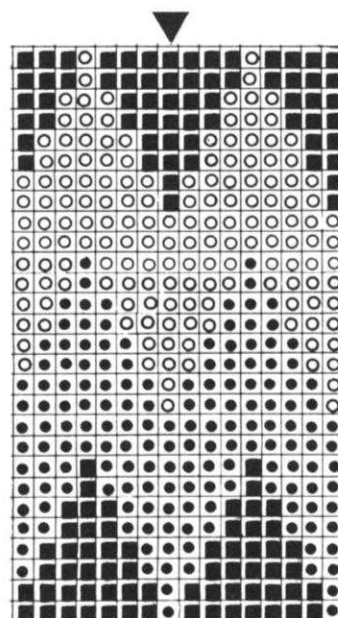

○ Color 3
■ Color 1
● Color 2

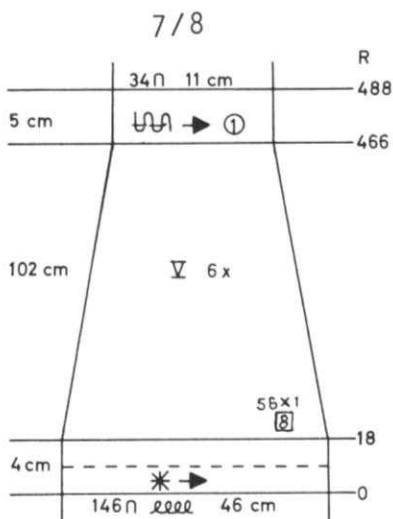

7/8

34 σ 11 cm

5 cm

102 cm

V 6x

56x1

4 cm

146 σ 46 cm

(10/12)

38 σ 12 cm

488

466

18

150 σ 47 cm

[14/16]

44 σ 14 cm

488

466

18

156 σ 48 cm

SKIRT: V Make 6

Cast on 146 (150) [156] sts. with color 1 and work the Norwegian Design. After Row 18, ON EACH SIDE, decrease 1 st. every 8th row 56x. After Row 466, continue in Stockinette stitch with color 1 and knit to Row 488. Bind off. Make 5 more sections the same.

are you unhappy with your present knitting machine?

DOES IT REFUSE TO KNIT FANCY DRESS YARNS?

DOES IT JAM UP WHEN YOU TRY TO KNIT LOOPED MOHAIR OR THICK AND THIN YARNS?

DOES IT DROP STITCHES ALL OVER THE PLACE?

ARE YOU CONTINUALLY HAVING TROUBLE WITH AWKWARD, CUMBERSOME WEIGHTS?

ARE YOU UNABLE TO MAKE A LARGE GARMENT WITH BULKY YARNS?

DO YOU HAVE TO SELECT PATTERN STITCHES MANUALLY?

DO YOU HAVE TO LATCH YOUR RIBBING BY HAND?

IF YOU ARE HAVING ANY OF THESE PROBLEMS YOU SHOULD TRADE UP TO A NEW FANTASTIC PUSH BUTTON KNITTING WITH COORDINATED RIBBER AND ENJOY KNITTING WITH THE WORLDS FINEST, MOST VERSATILE AND MOST AUTOMATIC KNITTER.

Send for your color brochure to: KNITTING — 1128 Crenshaw Blvd., Los Angeles, California 90019

DK 218

WOMAN'S SKIRT, TOP & SLEEVELESS PULLOVER



SIZE: 7/8 (10/12) (14/16)
 YARN: Crocus
 GRAMS:
 Color 1 700 750 800
 Color 2 400 450 500
 TENSION: 6 to 8
 GAUGE: 14 sts. 20 rows = 5 cm (2")

The Skirt and Top are a Norwegian Design, the Pullover is Stockinette stitch. Bands are K1, P1, Ribbing.

FINISHING: See General Instructions.

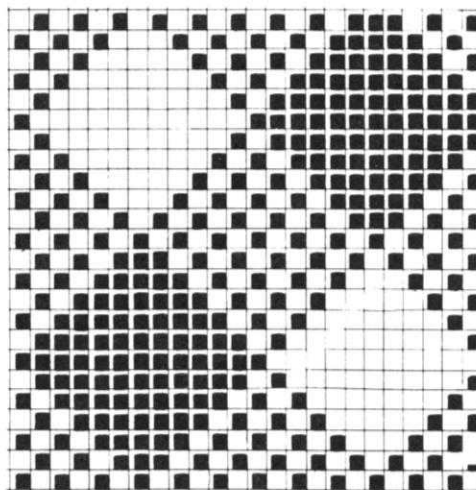

■ Color 2
 □ Color 1

TOP BACK: II

Cast on 92 (102) [112] sts. with color 1 and work 34 rows K1, P1 Ribbing. Change to the Norwegian Design and ON EACH SIDE, increase 1 st. every 6th row 3x, every 4th row 12x.

After Row 98, ON EACH SIDE, cast on 3 sts. 3x, 4 sts. 3x. After Row 110, ON EACH SIDE, increase 1 st.

every 16th row 4x. (every 14th row 5x). [every 12th row 6x].

Knit to Row 178 (182) [186].

*SHAPE SHOULDER AND SHAPE NECK AFTER ROW 194 (198) [202].

FOR SHOULDER, bind off

2 sts. 4x, 3 sts. 6x, 4 sts. 4x, 5 sts. 3x.

(3 sts. 9x, 4 sts. 4x, 5 sts. 4x). [3 sts. 5x, 4 sts. 6x, 5 sts. 6x].

FOR NECK, on all sizes, after Row 194 (198) [202], bind off the center 16 sts., put the needles on the left into holding position and complete the right half first.

*ON NECK SIDE, bind off 3 sts. 7x. Bring the needles on the left into working position, knit 1 row in Pattern to the left side, turn the Row Counter back to 194 (198) [202] and complete the left half. Follow the instructions from * and complete the shoulder shaping.

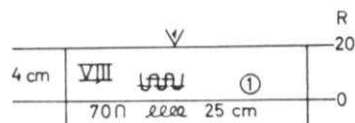
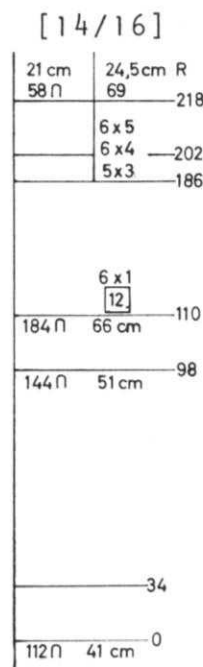
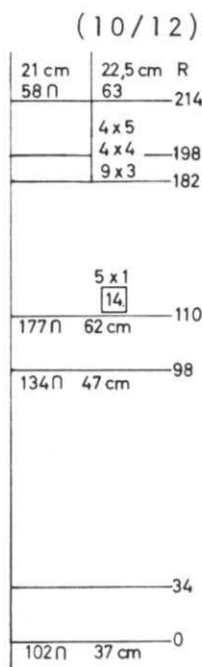
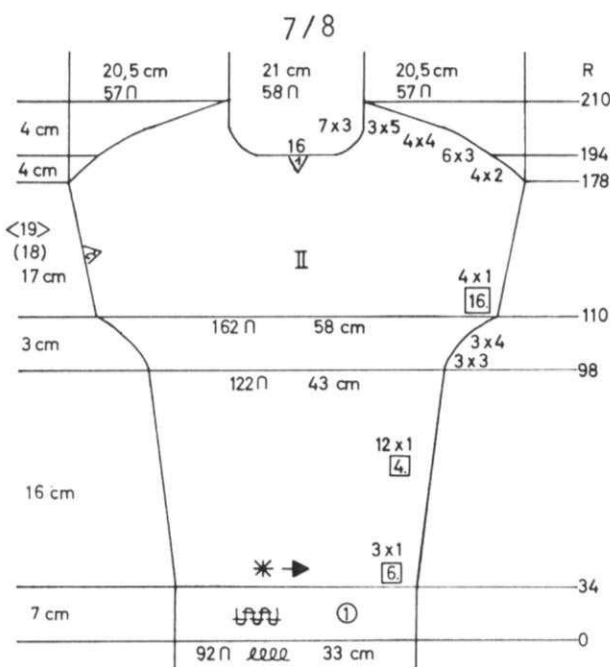

TOP - BACK NECKBAND: VIII

Cast on 70 sts. with color 1 and work 20 rows K1, P1 Ribbing, then bind off the crochet method for Ribbing.

TOP FRONT: I

Work the front the same as the back to Row 98.

ON EACH SIDE, cast on 3 sts. 4x, 4 sts. 2x.

After Row 110, ON EACH SIDE, increase 1 st.

every 16th row 4x. (every 14th row 5x). [every 12th row 6x].

Knit to Row 178 (182) [186].

Bind off the center 16 sts., put the needles on the left into holding position and complete the right half first.

*ON NECK SIDE, for all sizes, bind off 4 sts. 2x, 3 sts. 2x, 2 sts. 2x, 1 st. 3x, and SHAPE SHOULDER same as the back after Row 194 (198) [202].

Bring the needles on the left into working position, knit 1 row in Pattern to the left side, turn the Row Counter back to 178 (182) [186] and complete the right half. Follow the instructions from *.

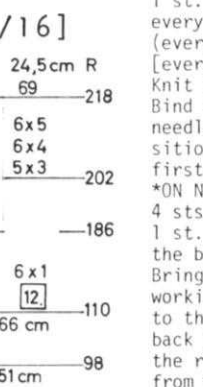
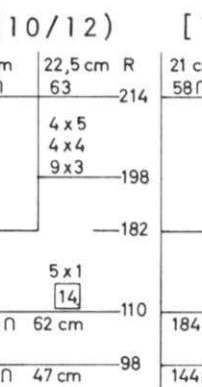
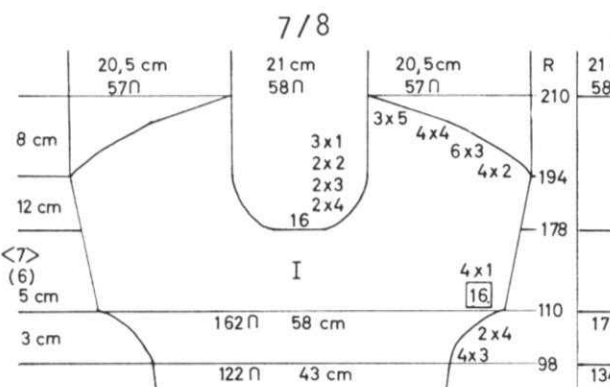

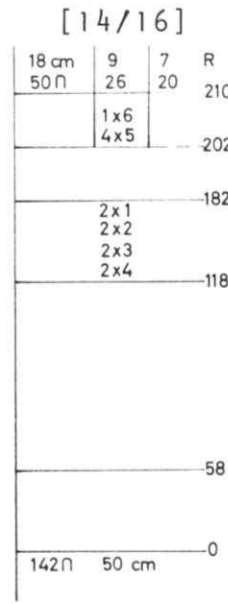
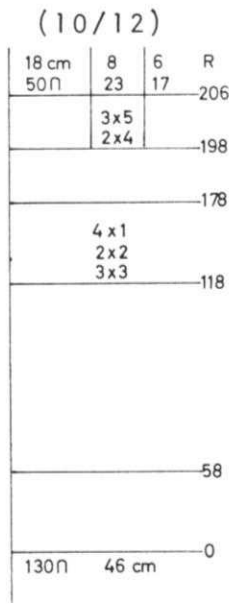
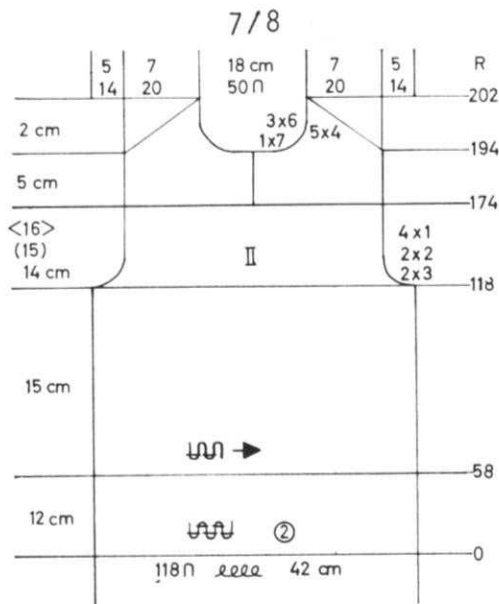

PULLOVER BACK: II

Cast on 118 (130) [142] sts. with color 2 and work 58 rows K1, P1 Ribbing. Change to Stockinette stitch and knit to Row 118.

SHAPE ARMHOLE: ON EACH SIDE, bind off 3 sts. 2x, 2 sts. 2x, 1 st. 4x. (3 sts. 3x, 2 sts. 2x, 1 st. 4x). [4 sts. 2x, 3 sts. 2x, 2 sts. 2x, 1 st. 2x].

Knit to Row 174 (178) [182]. Divide in the center and put the needles on the left into holding position and complete the right half first.

*Knit to Row 194 (198) [202]. SHAPE SHOULDER AND NECK AT THE SAME TIME.

FOR SHOULDER, bind off 4 sts. 5x. (4 sts. 2x, 5 sts. 3x). [5 sts. 4x, 6 sts. 1x].

FOR NECK, on all sizes, bind off 7 sts. 1x, 6 sts. 3x.

Move the Cam Box to the left side, turn the Row Counter back to 174 (178) [182] and complete the left half. Follow the instructions from *.

PULLOVER FRONT: I

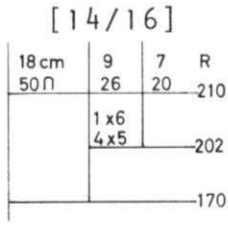
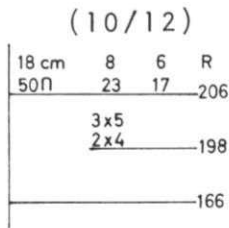
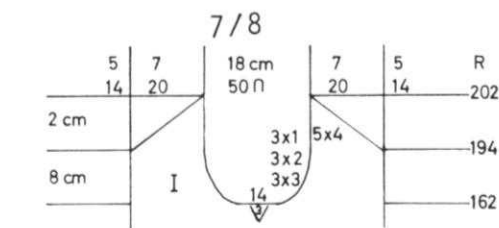

Work the front the same as the back to Row 162 (166) [170]. Bind off the center 14 sts., put the needles on the left into holding position and complete the right half first.

*ON NECK SIDE, for all sizes, bind off 3 sts. 3x, 2 sts. 3x, 1 st. 3x, and SHAPE SHOULDER same as the back after Row 194 (198) [202].

Move the Cam Box to the left side, turn the Row Counter back to 162 (166) [170] and complete the left half. Follow the instructions from *.

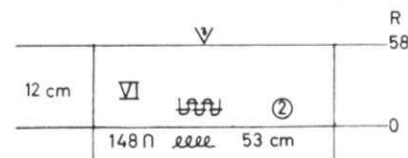
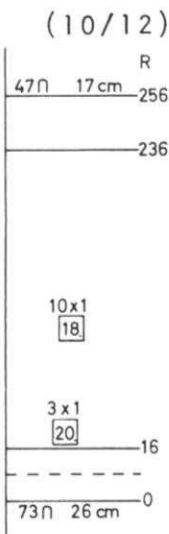
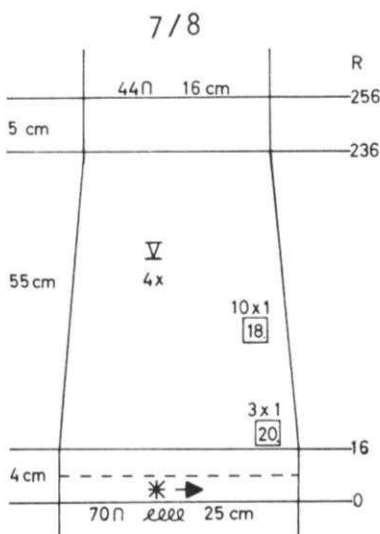

PULLOVER COLLAR: VI

Cast on 148 sts. with color 2 and work 58 rows K1, P1 Ribbing then bind off the crochet method for Ribbing.

SKIRT: V Make 4.

Cast on 70 (73) [76] sts. with color 1 and work the Norwegian Design. Knit to Row 16.

ON EACH SIDE, decrease 1 st. every 20th row 3x (3x) [11x], every 18th row 10x (10x) [0x].

Knit to Row 256, then bind off the remaining 44 (47) [54] sts.

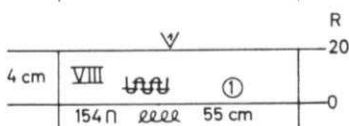

TOP-FRONT NECKBAND: VIII

Cast on 154 sts. with color 1 and work 20 rows K1, P1 Ribbing then bind off the crochet method for Ribbing.

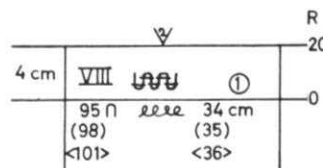

SLEEVE BAND: VIII Make 2.

Cast on 95 (98) [101] sts. with color 1 and work 20 rows K1, P1 Ribbing then bind off the crochet method for Ribbing.

WOMAN'S TWO-PIECE DRESS

SIZE: 8/10 (12/14) [16/18]
 YARN: Beatrice
 GRAMS:
 Color 1 700 750 800
 Color 2 150 200 250
 TENSION: 4 to 6
 GAUGE: 16 sts. 22 rows = 5 cm (2")



Skirt: Stockinette stitch with a Holding Position Design border on lower edge. Pullover: Stockinette stitch with Holding Position Design Yoke. Sleeves and bands are K1, P1 Ribbing. Follow the Line Drawing for the Design and KNITTING machine owners use Wheel No. 3.

FINISHING: See General Instructions.



| | |
|-------|---------|
| 59-60 | Color 2 |
| 57-58 | Color 1 |
| 55-56 | Color 2 |
| 53-54 | Color 1 |
| 51-52 | Color 2 |
| 49-50 | Color 1 |
| 47-48 | Color 2 |
| 45-46 | Color 1 |
| 43-44 | Color 2 |
| 41-42 | Color 1 |
| 39-40 | Color 2 |
| 37-38 | Color 1 |
| 35-36 | Color 2 |
| 33-34 | Color 1 |
| 31-32 | Color 2 |
| 29-30 | Color 1 |
| 27-28 | Color 2 |
| 25-26 | Color 1 |
| 23-24 | Color 2 |
| 21-22 | Color 1 |
| 19-20 | Color 2 |
| 17-18 | Color 1 |
| 15-16 | Color 2 |
| 13-14 | Color 1 |
| 11-12 | Color 2 |
| 9-10 | Color 1 |
| 7-8 | Color 2 |
| 5-6 | Color 1 |
| 3-4 | Color 2 |
| 1-2 | Color 1 |

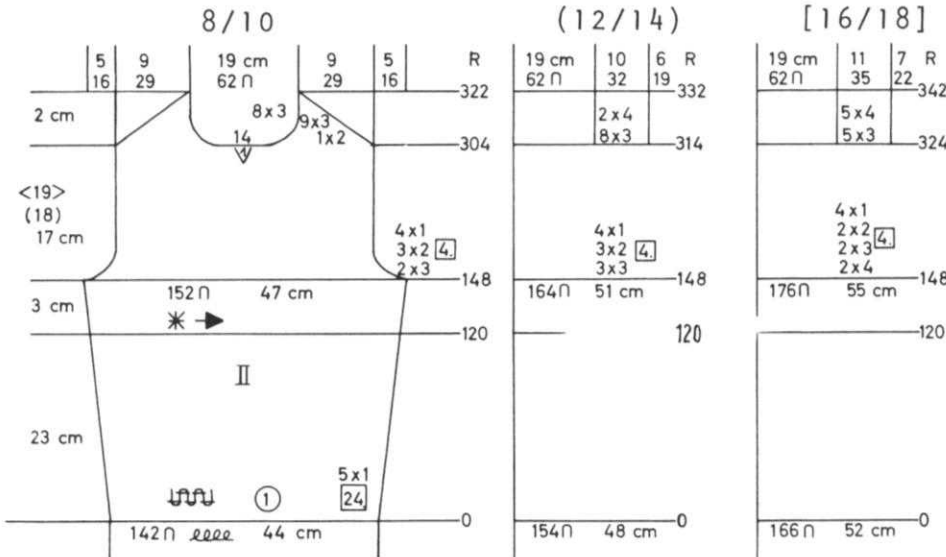

PULLOVER BACK: II

Cast on 142 (154) [166] sts. with color 1 and work K1, P1 Ribbing and ON EACH SIDE, increase 1 st. every 24th row 5x. After Row 120, change to the Holding Position Design and knit to Row 148. SHAPE ARMHOLE: ON EACH SIDE, on EVERY 4th ROW, bind off 3 sts. 2x, 2 sts. 3x, 1 st. 4x. (3 sts. 3x, 2 sts. 3x, 1 st. 4x). [4 sts. 2x, 3 sts. 2x, 2 sts. 2x, 1 st. 4x]. Knit to Row 304 (314) [324]. Bind off the center 14 sts., put the needles on the left into holding position and complete the right half first.

*SHAPE SHOULDER AND NECK AT THE SAME TIME.

FOR SHOULDER, bind off 2 sts. 1x, 3 sts. 9x. (3 sts. 8x, 4 sts. 2x). [3 sts. 5x, 4 sts. 5x]. FOR NECK, on all sizes, bind off 3 sts. 8x. Bring the needles on the left into working position, knit 1 row in Pattern to the left side, turn the Row Counter back to 304 (314) [324] and complete the left half. Follow the instructions from *.

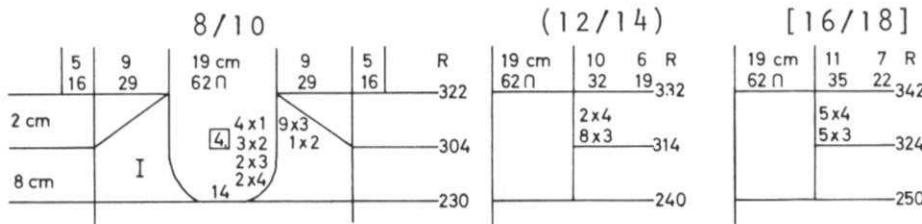

PULLOVER FRONT: I

Work the front the same as the back to Row 230 (240) [250]. Bind off the center 14 sts., put the needles on the left into holding position and complete the right half first.

*ON NECK SIDE, for all sizes, on EVERY 4th ROW, bind off 4 sts. 2x, 3 sts. 2x, 2 sts. 3x, 1 st. 4x, and SHAPE SHOULDER same as the back after Row 304 (314) [324]. Bring the needles on the left into working position, knit 1 row in Pattern to the left side, turn the Row Counter back to 230 (240) [250] and complete the left half. Follow the instructions from *.

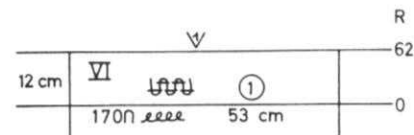

COLLAR: VI

Cast on 170 sts. with color 1 and work 62 rows K1, P1 Ribbing then bind off the crochet method for Ribbing.

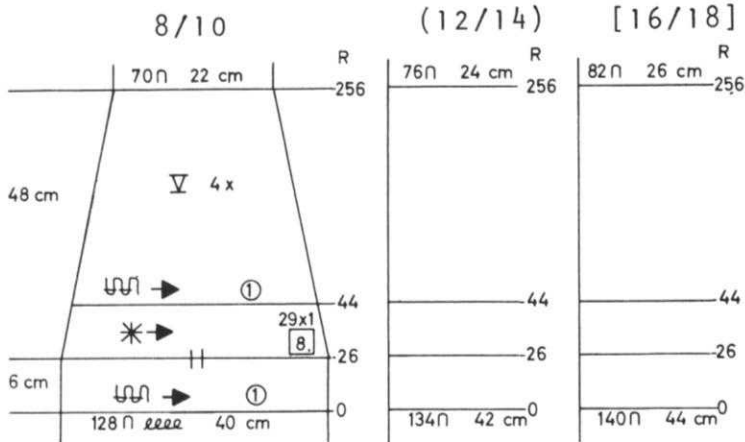

SKIRT: V Make 4.

Cast on 128 (134) [140] sts. with color 1 and work 26 rows Stockinette stitch. Hang the hem. Change to the Holding Position Design and ON EACH SIDE, decrease 1 st. every 8th row 29x and AFTER ROW 44, change to color 1 and Stockinette stitch. After Row 256, bind off the remaining 70 (76) [82] sts.



DK 220

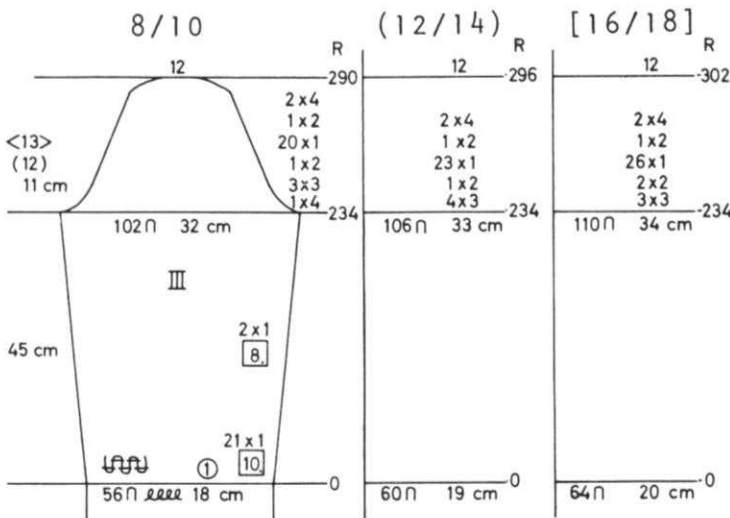

SLEEVE: III

Cast on 56 (60) [64] sts. with color 1 and work K1, P1 Ribbing. ON EACH SIDE, increase 1 st. every 10th row 21x, every 8th row 2x. Knit to Row 234. SHAPE CAP: ON EACH SIDE, bind off 4 sts. 1x, 3 sts. 3x, 2 sts. 1x, 1 st. 20x, 2 sts. 1x, 4 sts. 2x. (3 sts. 4x, 2 sts. 1x, 1 st. 23x, 2 sts. 1x, 4 sts. 2x). [3 sts. 3x, 2 sts. 2x, 1 st. 26x, 2 sts. 1x, 4 sts. 2x]. After Row 290 (296) [302], bind off the remaining 12 sts.

WOMAN'S DRESS

SIZE: 8/10 (12/14) [16/18]
 YARN: Beatrice
 GRAMS: 600 650 700
 TENSION: 5 to 7
 GAUGE: 15 sts. 21 rows = 5 cm (2")

FINISHING: See General Instructions. Work 1 row single crochet and 1 row picot around neck, fronts, and sleeve edges. Embroider flowers on front.

Skirt is Stockinette stitch. Top is K1, P1 Ribbing and Stockinette stitch. Worn on the purl side.

BODICE 60 : II

Cast on 133 (145) [157] sts. and work K1, P1 Ribbing. ON EACH SIDE, increase 1 st. every 20th row 4x. Knit to Row 110. SHAPE ARMHOLE: ON EACH SIDE, bind off 3 sts. 2x, 2 sts. 3x, 1 st. 3x. (3 sts 3x, 2 sts. 3x, 1 st. 3x). [4 sts. 2x, 3 sts. 2x, 2 sts. 2x, 1 st. 3x]. Knit to Row 190 (196) [202]. Bind off the center 17 sts., put the needles on the left into holding position and complete the right half first. *SHAPE SHOULDER AND NECK AT THE SAME TIME. FOR SHOULDER, bind off 5 sts. 3x, 4 sts. 3x. (5 sts. 6x). [5 sts. 3x, 6 sts. 3x]. FOR NECK, on all sizes, bind off 5 sts. 4x. Move the Cam Box to the left side, turn the Row Counter back to 190 (196) [202] and complete the left half. Follow the instructions from *.

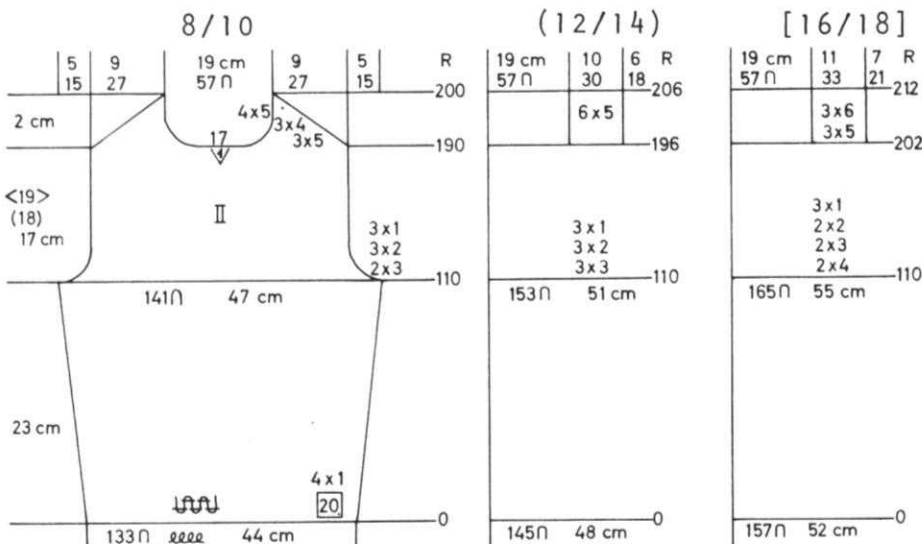

Continued



DK 220

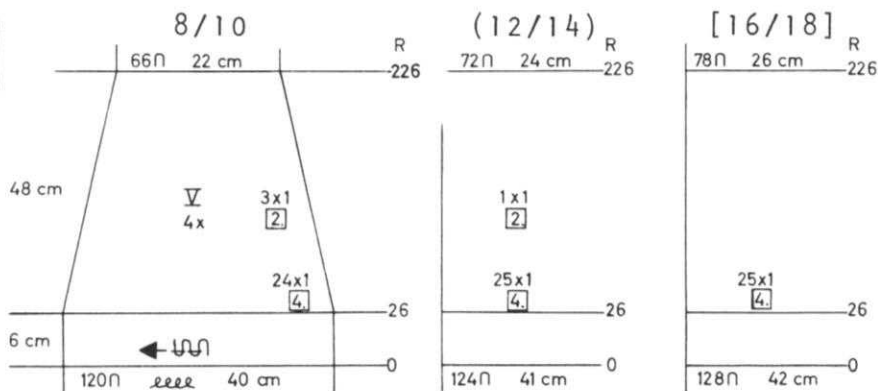

SKIRT: V Make 4.

Cast on 120 (124) [128] sts. and work Stockinette stitch. Knit to Row 26. ON EACH SIDE, decrease 1 st. every 4th row 24x, every 2nd row 3x. Knit to Row 226 then bind off the remaining 66 (72) [78] sts.

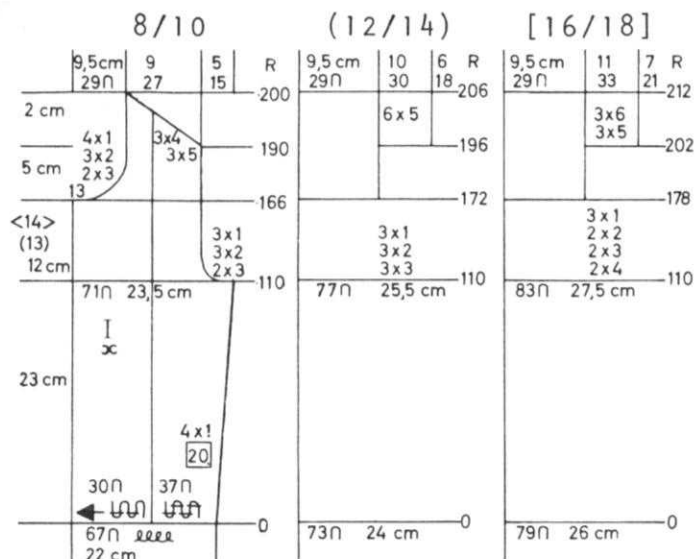

FRONT: I Make 1, reverse 1.

Cast on 67 (73) [79] sts. with 30 stitches on the LEFT (right for 2nd section) in Stockinette stitch and the remaining 37 in K1, P1 Ribbing. ON SIDE EDGE, increase 1 st. every 20th row 4x. Knit to Row 110. SHAPE ARMHOLE, same as the back then knit to Row 165 (171) [177]. ON NECK SIDE, for all sizes, bind off 13 sts., then bind off 3 sts. 2x, 2 sts. 3x, 1 st. 4x and after Row 190 (196) [202], SHAPE SHOULDER same as the back.

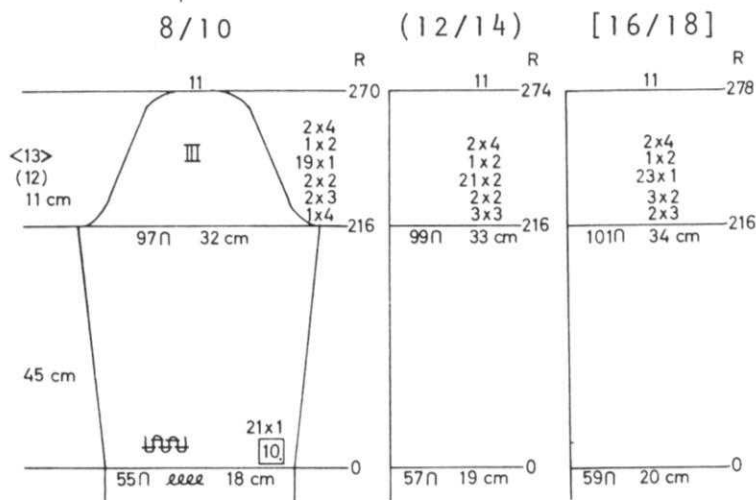
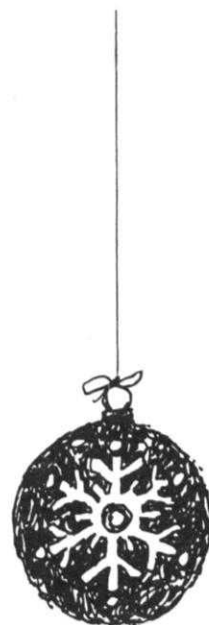

SLEEVE: III

Cast on 55 (57) [59] sts. and work K1, P1 Ribbing. ON EACH SIDE, increase 1 st. every 10th row 21x. Knit to Row 216. SHAPE CAP: ON EACH SIDE, bind off 4 sts. 1x, 3 sts. 2x, 2 sts. 2x, 1 st. 19x, 2 sts. 1x, 4 sts. 2x. (3 sts. 3x, 2 sts. 2x, 1 st. 21x, 2 sts. 1x, 4 sts. 2x). [3 sts. 2x, 2 sts. 3x, 1 st. 23x, 2 sts. 1x, 4 sts. 2x]. After Row 270 (274) [278], bind off the remaining 11 sts.

DK 221



WOMAN'S SKIRT & VEST

SIZE: 10/12 (14/16) [18/20]
 YARN: Beatrice
 GRAMS:
 Color 1 600 650 700
 Color 2 300 350 400
 TENSION: 4 to 6
 GAUGE: 16 sts. 21 rows = 5 cm (2")

Skirt is Stockinette stitch. Vest has a Norwegian Design on front section only. Follow the Line Drawing or use JAC 40 and Pattern No. 563.

FINISHING: See General Instructions. Ease the extra rows at bustline of front section. Work 1 row single crochet, 1 row double crochet around all edges.



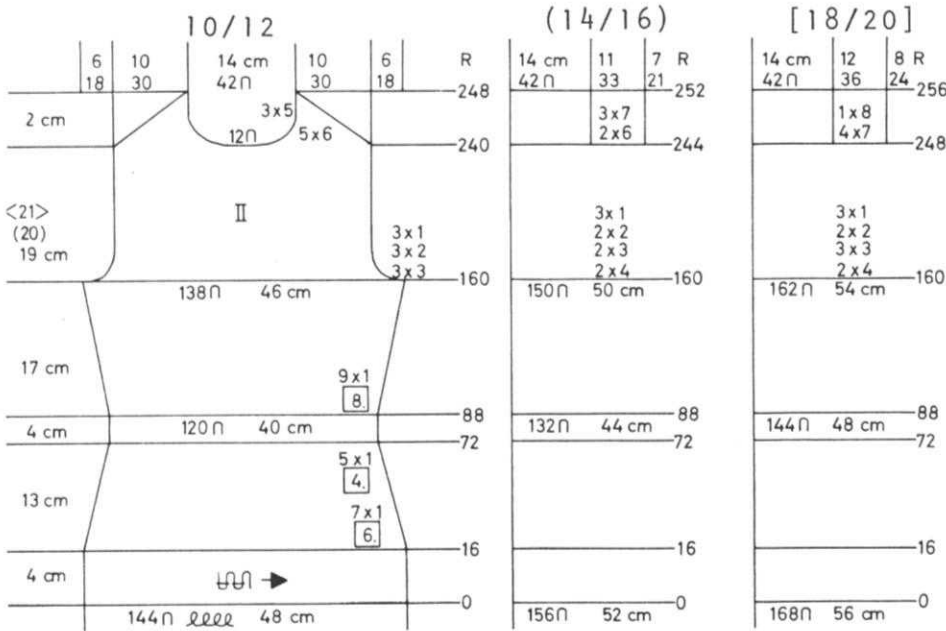

Cast on 144 (156) [168] sts. with color 1 and work Stockinette stitch. Knit to Row 16.
 ON EACH SIDE, decrease 1 st. every 6th row 7x, every 4th row 5x. Knit to Row 88.
 ON EACH SIDE, increase 1 st. every 8th row 9x. Knit to Row 160.
 SHAPE ARMHOLE: ON EACH SIDE, bind off 3 sts. 3x, 2 sts. 3x, 1 st. 3x. [4 sts. 2x, 3 sts. 2x, 2 sts. 2x, 1 st. 3x].
 [4 sts. 2x, 3 sts. 3x, 2 sts. 2x, 1 st. 3x].
 Knit to Row 240 (244) [248].
 Bind off the center 12 sts., put the needles on the left into holding position and complete the right half first.
 *SHAPE SHOULDER AND NECK AT THE SAME TIME.
 FOR SHOULDER, bind off 6 sts. 5x. [6 sts. 2x, 7 sts. 3x]. [7 sts. 4x, 8 sts. 1x].
 FOR NECK, on all sizes, bind off 5 sts. 3x.
 Move the Cam Box to the left side, turn the Row Counter back to 240 (244) [248] and complete the left half. Follow the instructions from *.

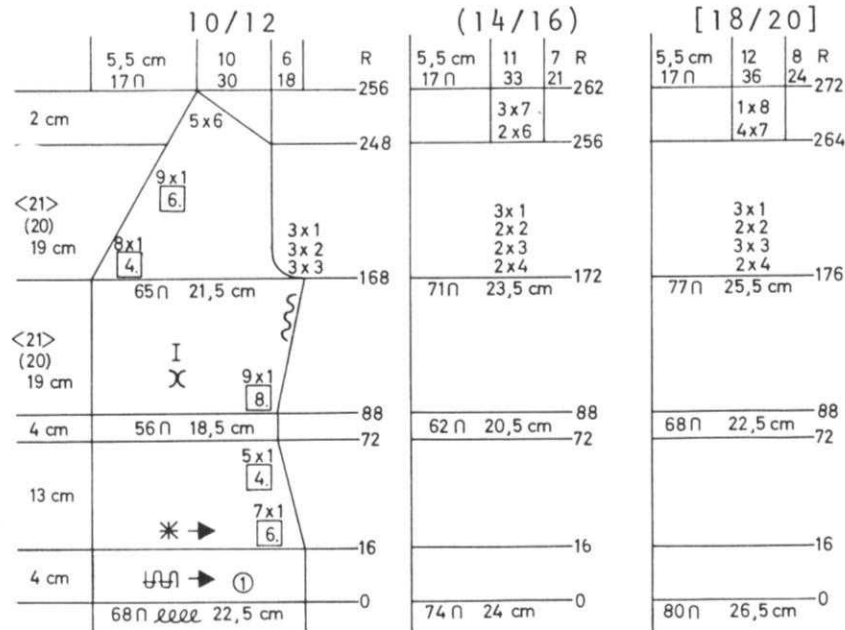

VEST FRONT: I Make 1, reverse 1.

Cast on 68 (74) [80] sts. with color 1 and work Stockinette stitch. Knit to Row 16.
 Change to the Norwegian Design and ON SIDE EDGE, decrease 1 st. every 6th row 7x, every 4th row 5x. Knit to Row 88.
 ON SIDE EDGE, increase 1 st. every 8th row 9x. Knit to Row 168 (172) [176].
 SHAPE ARMHOLE same as the back and ON NECK SIDE, for all sizes, decrease 1 st. every 4th row 8x, every 6th row 9x, AND AT THE SAME TIME, after Row 248 (256) [264], SHAPE SHOULDER same as the back.

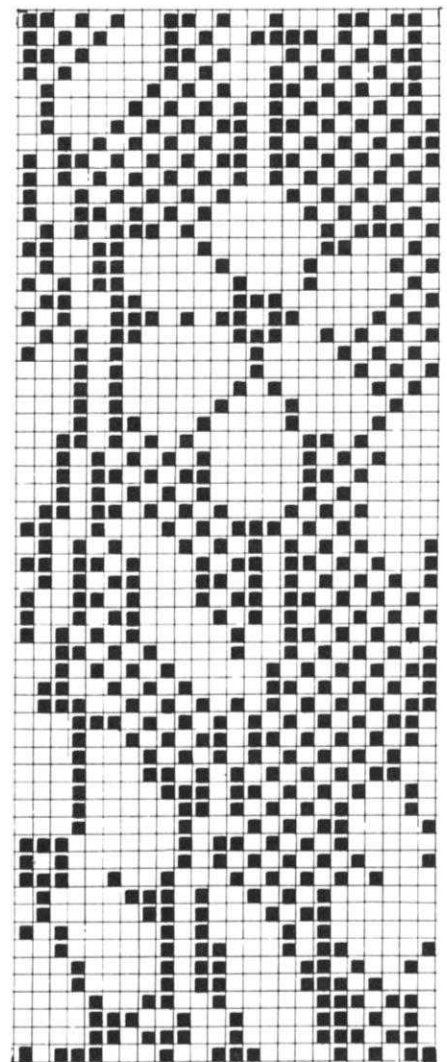

■ Color 2 □ Color 1

OK 221

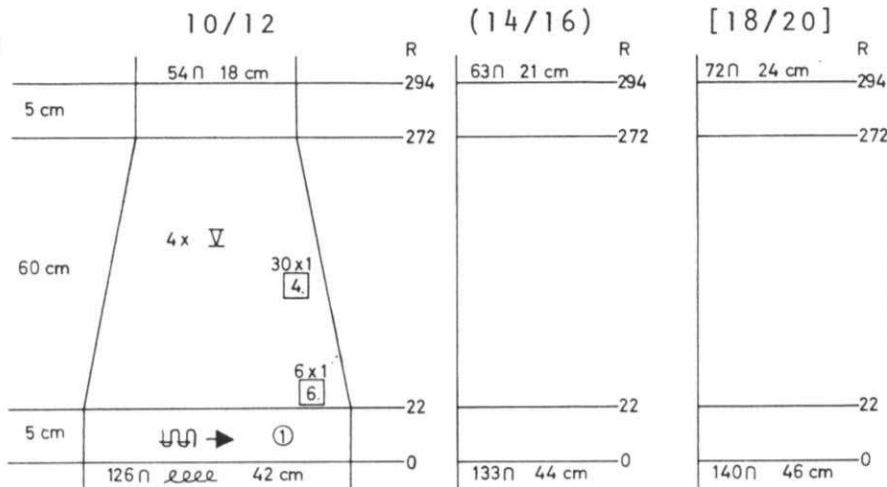

SKIRT: V Make 4

Cast on 126 (133) [140] sts. with color 1 and work Stockinette stitch. Knit to Row 22. ON EACH SIDE, decrease 1 st. every 6th row 6x, every 4th row 30x. Knit to Row 294. Bind off the remaining 54 (63) [72] sts.

OK 222

WOMAN'S PULLOVER



SIZE: 7/8 (10/12) [14/16]
 YARN: 2/20 Cone yarn
 GRAMS: 250 300 350
 TENSION: 3 to 5
 GAUGE: 14 sts. 48 rows = 5 cm (2")

A Holding Position Design that follows the Line Drawing. Worn on the Purl side. The bands are K1, P1 Ribbing.

FINISHING: See General Instructions.

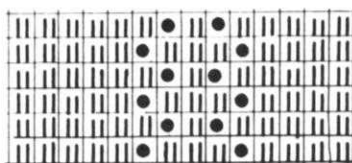

11-12
9-10
7-8
5-6
3-4
1-2

BACK: II

Cast on 117 (129) [141] sts. and work 28 rows K1, P1 Ribbing. Change to the Holding Position Design and knit to Row 278. SHAPE ARMHOLE: ON EVERY 4TH ROW, ON EACH SIDE, bind off 3 sts. 2x, 2 sts. 2x, 1 st. 4x. (3 sts. 3x, 2 sts. 2x, 1 st. 4x). [4 sts. 2x, 3 sts. 2x, 2 sts. 2x, 1 st. 2x]. Knit to Row 442 (452) [462]. Bind off the center 9 sts., put the needles on the left into holding position and complete the right half first. *SHAPE SHOULDER AND NECK AT THE SAME TIME. FOR SHOULDER, bind off 2 sts. 11x. (2 sts. 8x, 3 sts. 3x). [2 sts. 5x, 3 sts. 6x]. ON NECK SIDE, for all sizes, bind off 2 sts. 9x. Bring the needles on the left into working position, knit 1 row in Pattern to the left side, turn the Row Counter back to 442, (452) [462] and complete the left half. Follow the instructions from *.

FRONT: I

Work the front the same as the back to Row 278. Hang the center stitch on its neighboring needle, put the needles on the left into holding position and complete the right half first. *SHAPE ARMHOLE same as the back and ON NECK SIDE, for all sizes, decrease 1 st. every 8th row 22x and after Row 442 (452) [462], SHAPE SHOULDER same as the back. Bring the needles on the left into working position, knit 1 row in Pattern to the left side, turn the Row Counter back to 278 and complete the left half. Follow the instructions from *.

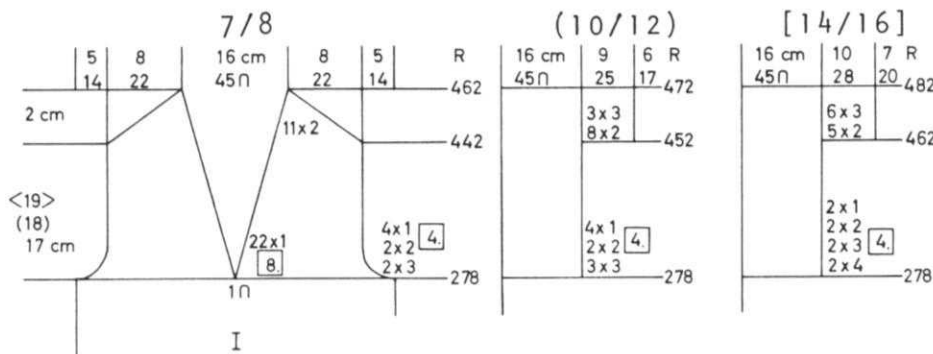
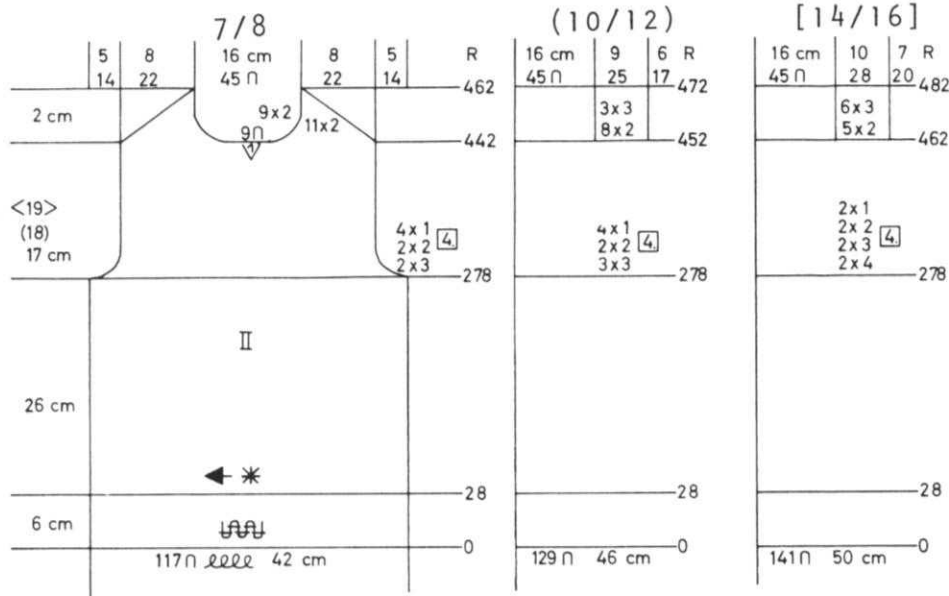

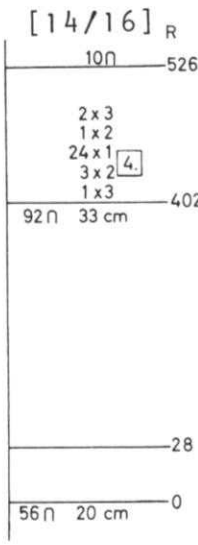
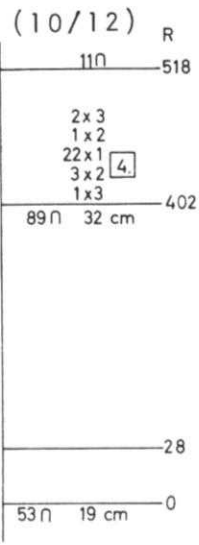
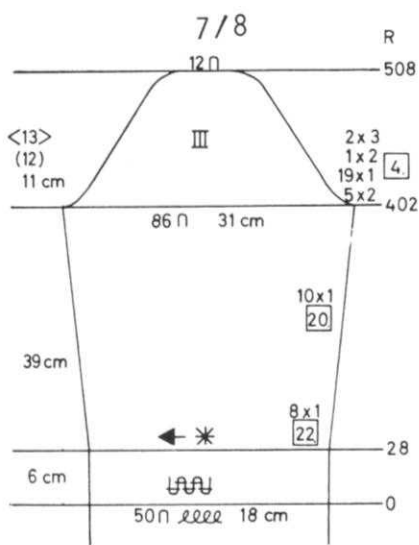

SLEEVE: III

Cast on 50 (53) [56] sts. and work 28 rows K1, P1 Ribbing. Change to the Holding Position Design and ON EACH SIDE, increase 1 st. every 22nd row 8x, every 20th row 10x. Knit to Row 402. SHAPE CAP: ON EACH SIDE, ON EVERY 4th ROW, bind off
2 sts. 5x, 1 st. 19x, 2 sts. 1x, 3 sts. 2x.
(3 sts. 1x, 2 sts. 3x, 1 st. 22x, 2 sts. 1x, 3 sts. 2x).
[3 sts. 1x, 2 sts. 3x, 1 st. 24x, 2 sts. 1x, 3 sts. 2x].
After Row 508 (518) [526], bind off the remaining 12 (11) [10] sts.

R NECKBAND: VIII Make 1, reverse 1.

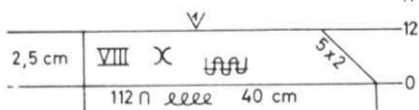

Cast on 112 sts. and work K1, P1 Ribbing. On the RIGHT (left for second section), decrease 2 sts. 5x. After Row 12, bind off the crochet method for Ribbing.

HR 223



MAN'S CARDIGAN

SIZE: 36/38 (40/42) [44/46]
YARN: Regia
GRAMS: 550 600 650
TENSION: 5 to 7
GAUGE: 15 sts. 23 rows = 5 cm (2")

Stockinette stitch with bands in K1, P1 Ribbing.

FINISHING: See General Instructions.

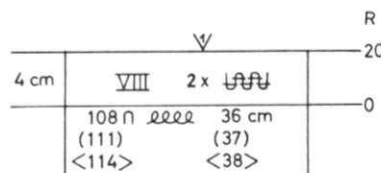

R NECKBAND: VIII Make 2.

Cast on 108 (111) [114] sts. and work 20 rows K1, P1 Ribbing then bind off the crochet method for Ribbing.

BACK: II

Cast on 148 (159) [170] sts. and work 30 rows K1, P1 Ribbing. Change to Stockinette stitch and knit to Row 200.

SHAPE ARMHOLE: ON EACH SIDE, bind off

3 sts. 2x, 2 sts. 3x, 1 st. 3x. (3 sts. 3x, 2 sts. 2x, 1st. 5x). [4 sts. 2x, 3 sts. 2x, 2 sts. 2x, 1 st. 3x].

Knit to Row 298 (302) [306]. Bind off the center 12 (15) [18] sts., put the needles on the left into holding position and complete the right half first.

*SHAPE SHOULDER AND NECK AT THE SAME TIME.

FOR SHOULDER, bind off

4 sts. 5x, 5 sts. 3x. (4 sts. 4x, 5 sts. 4x). [4 sts. 3x, 5 sts. 3x].

FOR NECK, on all sizes, bind off 3 sts. 6x.

Move the Cam Box to the left side, turn the Row Counter back to 298 (302) [306] and complete the left half. Follow the instructions from *.

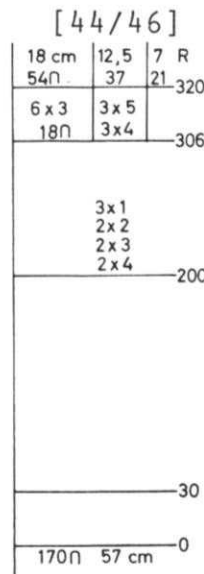
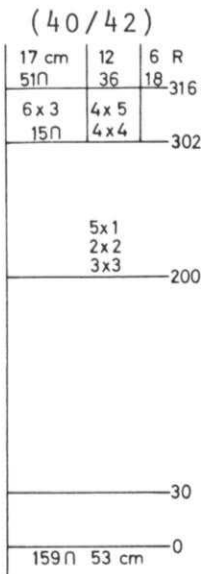
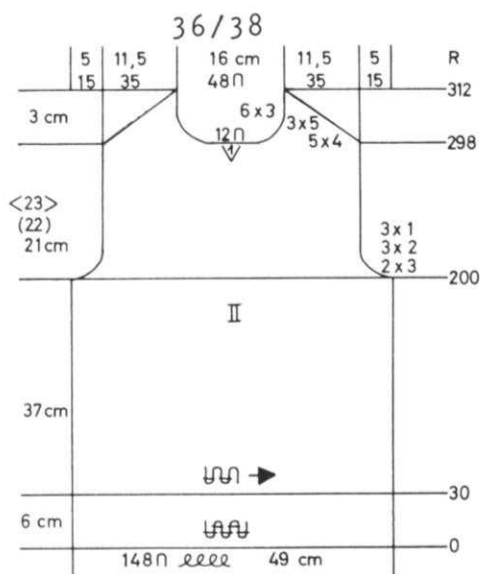

FRONT BANDS: VIII Make 2 but omit BUTTONHOLES in 2nd section.

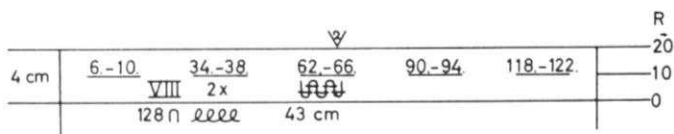

Cast on 128 sts. and work K1, P1 Ribbing. After Row 10, make BUTTONHOLES over the needles as shown on the Chart. After Row 20, bind off the crochet method for Ribbing.



Continued

HE 223

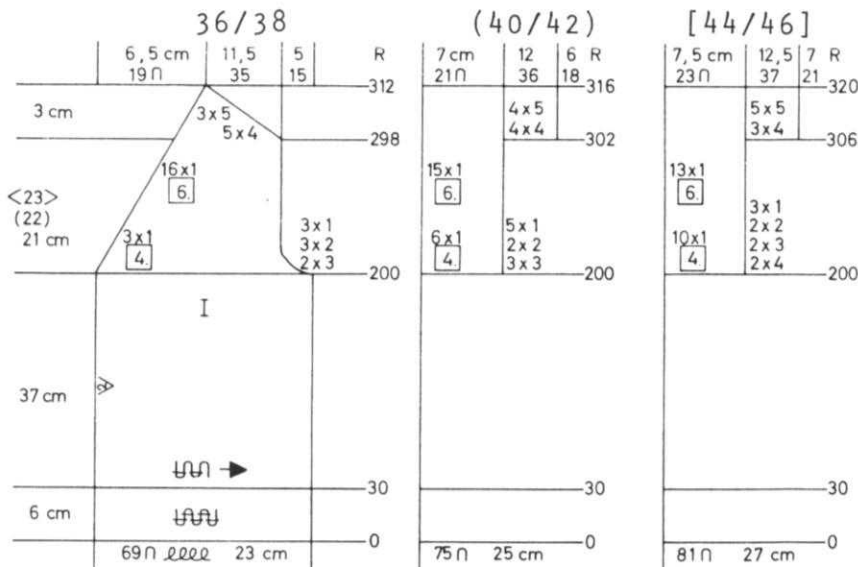

FRONT: I Make 1, reverse 1.

Cast on 69 (75) [81] sts. and work 30 rows K1, P1 Ribbing. Change to Stockinette stitch and knit to Row 200.

SHAPE ARMHOLE same as the back and ON NECK SIDE, decrease 1 st. every 4th row 3x (6x) [10x], every 6th row 16x (15x) [13x] and AT THE SAME TIME, SHAPE SHOULDER same as the back after Row 298 (302) [306].

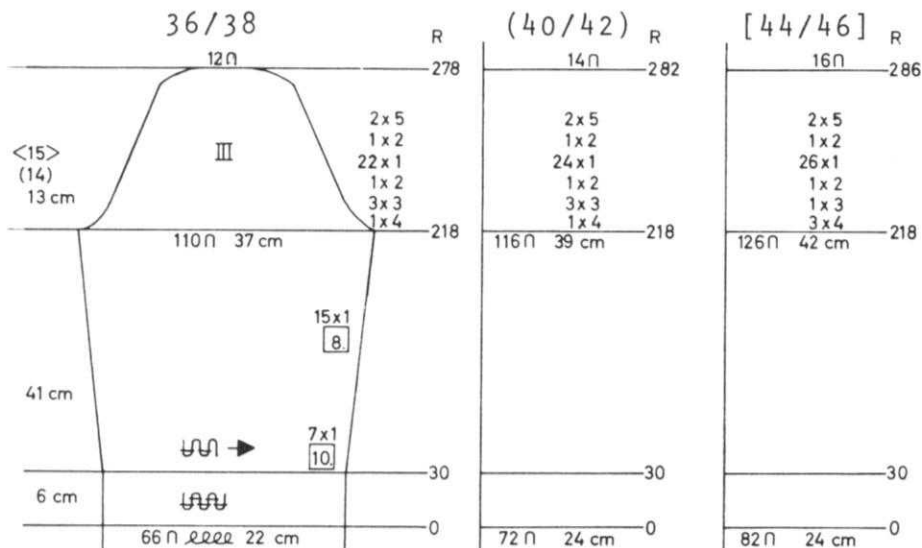

SLEEVE: III

Cast on 66 (72) [82] sts. and work 30 rows K1, P1 Ribbing.

Change to Stockinette stitch and ON EACH SIDE, increase 1 st. every 10th row 7x, every 8th row 15x. Knit to Row 218.

SHAPE CAP: ON EACH SIDE, bind off 4 sts. 1x, 3 sts. 3x, 2 sts. 1x, 1 st. 22x, 2 sts. 1x, 5 sts. 2x. (4 sts. 1x, 3 sts. 3x, 2 sts. 1x, 1 st. 24x, 2 sts. 1x, 5 sts. 2x). [4 sts. 3x, 3 sts. 1x, 2 sts. 1x, 1 st. 26x, 2 sts. 1x, 5 sts. 2x]. After Row 278 (282) [286], bind off the remaining 12 (14) [16] sts.

HE 224

MAN'S JACKET



SIZE: 34/36 (38/40) [42/44]
 YARN: Sport Prima
 GRAMS: Color 1 600 650 700
 Color 2 100 100 100
 TENSION: 7 to 9
 GAUGE: 14 sts. 17 rows = 5 cm (2")

Stockinette stitch with a Cable Design on the front section. Follow the Line Drawing and the Chart to set up the needles. Bands are Stockinette stitch.

FINISHING: See General Instructions.

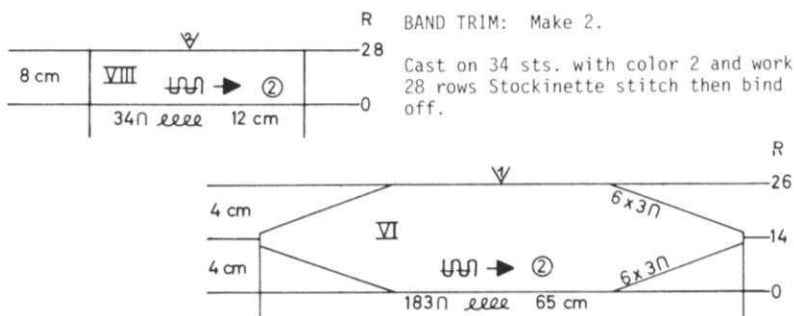

COLLAR: VI

Cast on 183 sts. with color 2 and work Stockinette stitch and SHORT ROWS.

ON OPPOSITE SIDE OF CAM BOX, put into holding position, 18 sts. at Row 0 and after Row 1.

ON OPPOSITE SIDE OF CAM BOX, bring back into working position, 3 sts. 6x ON EACH SIDE.

After Row 14, ON OPPOSITE SIDE OF CAM BOX, put into holding position 3 sts. 6x ON EACH SIDE, after Row 26, bring all the needles back into working position and bind off loosely.

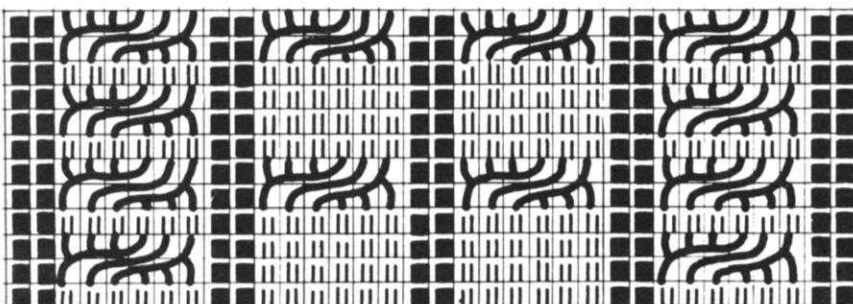

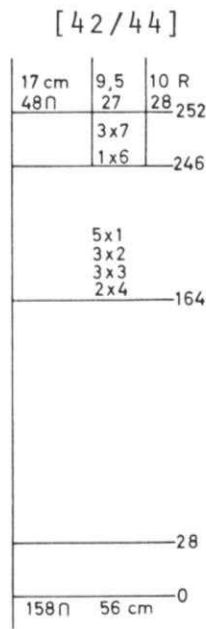
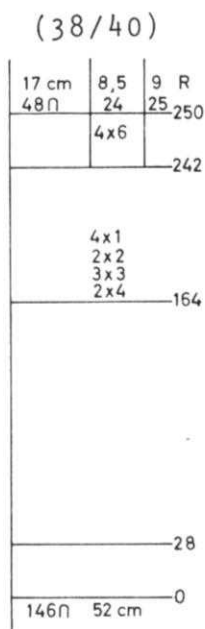
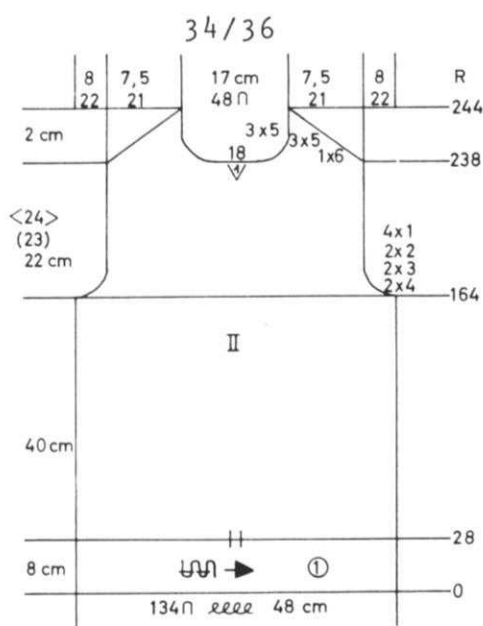

BACK: II

Cast on 134 (146) [158] sts. with color 1 and work Stockinette stitch.

After Row 28, hang the hem then knit to Row 164.

SHAPE ARMHOLE: ON EACH SIDE, bind off 4 sts. 2x, 3 sts. 2x, 2 sts. 2x, 1 st. 4x.

(4 sts. 2x, 3 sts. 3x, 2 sts. 2x, 1 st. 4x).

[4 sts. 2x, 3 sts. 3x, 2 sts. 3x, 1 st. 5x].

Knit to Row 238 (242) [246].

Bind off the center 18 sts., put the needles on the left into holding position and complete the right half first.

*SHAPE SHOULDER AND NECK AT THE SAME TIME.

FOR SHOULDER, bind off

6 sts. 1x, 5 sts. 3x.

(6 sts. 4x).

[6 sts. 1x, 7 sts. 3x].

FOR NECK, on all sizes, bind off 5 sts. 3x.

Move the Cam Box to the left side,

turn the Row Counter back to

238 (242) [246] and complete the

left half. Follow the instructions from *.

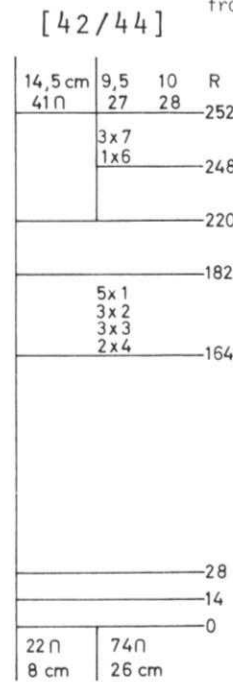
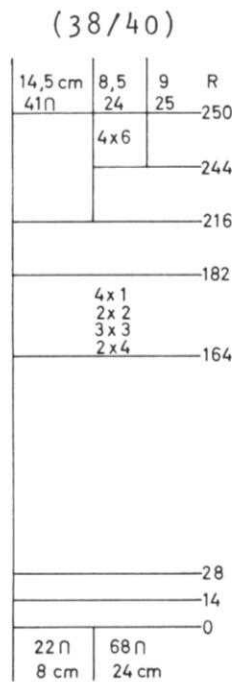
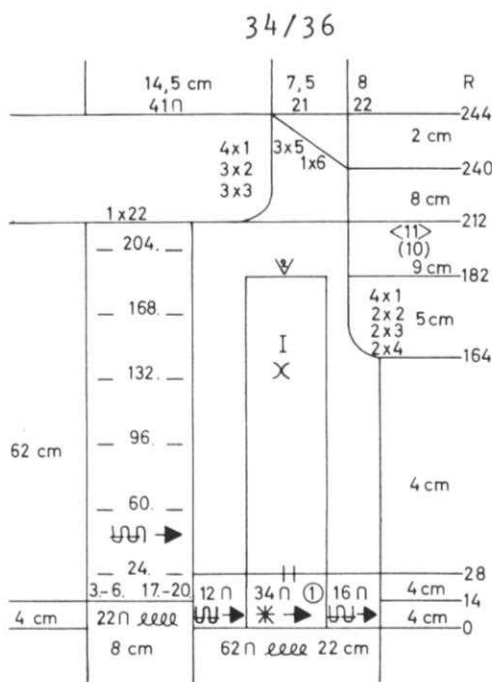

FRONT: I Make 1. reverse 1. DO NOT MAKE BUTTONHOLES in this Section.

Cast on 62 (68) [74] sts. with color 1 and work Stockinette stitch to Row 14. On the LEFT (right for 2nd section) cast on 22 sts. with a separate yarn. Begin the Cable design following the Chart and Line Drawing. After Row 28, hang the original cast on stitches onto the machine to form the hem.

Knit to Row 164.

SHAPE ARMHOLE on the right side, (left for 2nd section) same as the back and STOP the Cable Design after Row 182.

Continue in Stockinette stitch and knit to Row 211 (215) [219].

ON NECK SIDE, for all sizes, bind off 22 sts., then bind off 3 sts. 3x,

2 sts. 3x, 1 st. 4x and SHAPE SHOULDER same as the back after Row 240 (244)

[248].

Work the 2nd section with reverse shaping, making BUTTONHOLES on the

RIGHT side after rows shown on the Chart over needles 3 to 6 and 17 to 20 counting from the right edge.

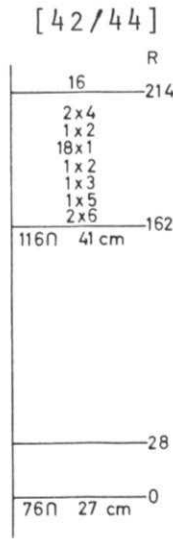
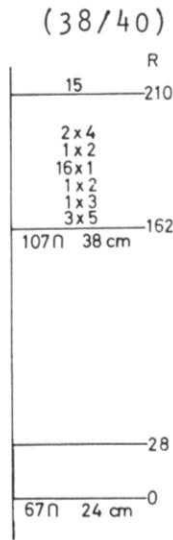
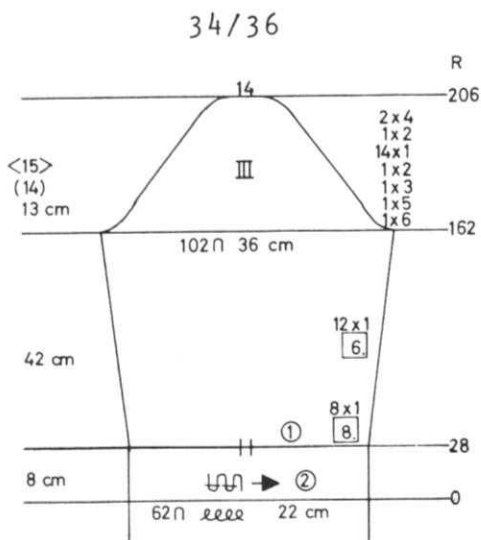

SLEEVE: III

Cast on 62 (67) [76] sts. with color 2 and work Stockinette stitch.

After Row 28, hang the hem and continue with color 1.

ON EACH SIDE, increase 1 st. every 8th row 8x, every 6th row 12x. Knit to Row 162.

SHAPE CAP: ON EACH SIDE, bind off

6 sts. 1x, 5 sts. 1x, 3 sts. 1x,

2 sts. 1x, 1 st. 14x, 2 sts. 1x,

4 sts. 2x.

(5 sts. 3x, 3 sts. 1x, 2 sts. 1x,

1 st. 16x, 2 sts. 1x, 4 sts. 2x).

[6 sts. 2x, 5 sts. 1x, 3 sts. 1x,

2 sts. 1x, 1 st. 18x, 2 sts. 1x,

4 sts. 2x].

After Row 206 (210) [214], bind off the remaining 14 (15) [16] sts.

HE 225

MAN'S JACKET

SIZE: 36/38 (40/42) [44/46]
 YARN: Regia
 GRAMS:
 Color 1 500 550 600
 Color 2 100 100 100
 TENSION: 5 to 7
 GAUGE: 15 sts. 21 rows = 5 cm (2")

Stockinette stitch with bands
 in color 2.

FINISHING: See General Instructions.

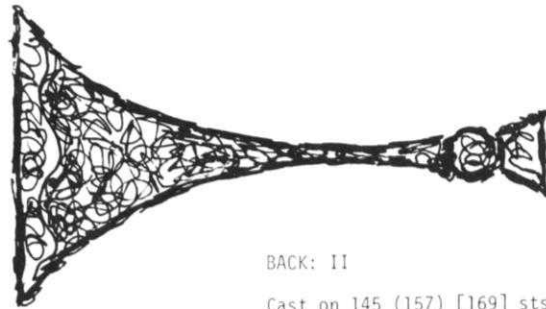

BACK: II

Cast on 145 (157) [169] sts. with color 2 and work Stockinette stitch. After Row 34, hang the hem then change to color 1. Knit to Row 202.
 SHAPE ARMHOLE: ON EACH SIDE, bind off 4 sts. 2x, 3 sts. 3x, 2 sts. 2x, 1 st. 3x.
 (4 sts. 2x, 3 sts. 3x, 2 sts. 3x, 1 st. 4x).
 [5 sts. 2x, 4 sts. 2x, 3 sts. 2x, 1 st. 6x].
 Knit to Row 294 (298) [302]. Bind off the center 15 sts., put the needles on the left into holding position and complete the right half first.
 *SHAPE SHOULDER AND NECK AT THE SAME TIME.
 FOR SHOULDER, bind off 4 sts. 2x, 5 sts. 3x. (5 sts. 4x, 6 sts. 1x). [5 sts. 1x, 6 sts. 4x].
 FOR NECK, on all sizes, bind off 6 sts. 3x.
 Move the Cam Box to the left side, turn the Row Counter back to 294 (298) [302] and complete the left half. Follow the instructions from *.

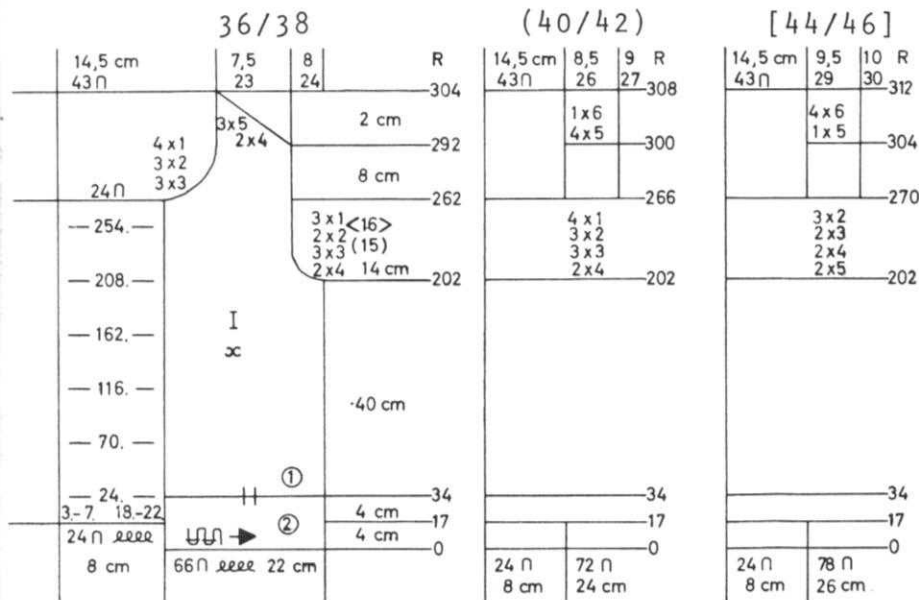
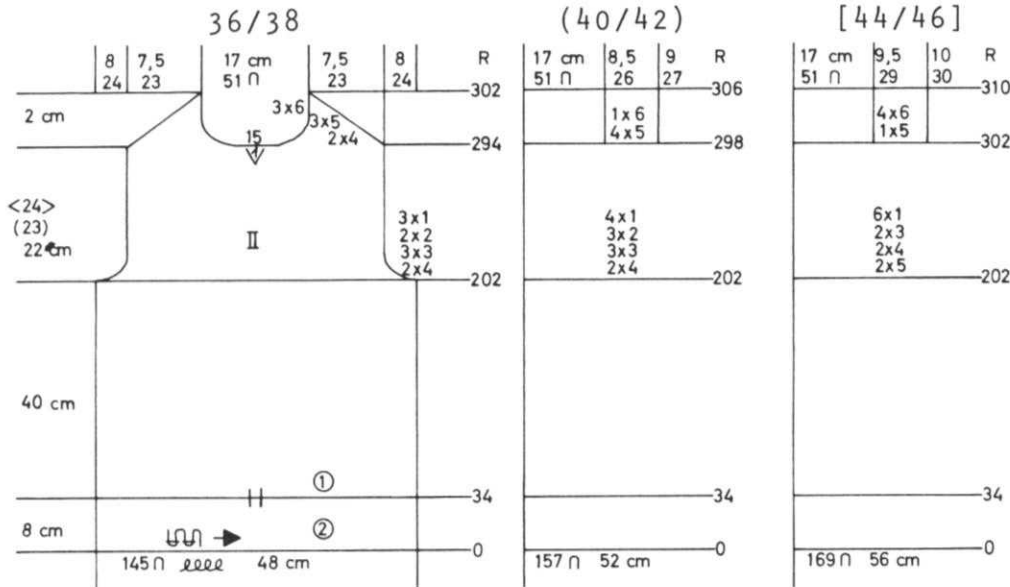

FRONT: I Make 1, reverse 1.
 DO NOT MAKE BUTTONHOLES in this section.

Cast on 66 (72) [78] sts. with color 2 and work Stockinette stitch. After Row 17, cast on 24 sts. on the left side (right for 2nd section). Knit to Row 34, then hang the original cast on stitches back onto the machine to form the hem. Change to color 1. Knit to Row 202.
 ON THE RIGHT (left for 2nd section) SHAPE ARMHOLE same as the back then knit to Row 261 (265) [269].
 ON NECK SIDE, for all sizes, bind off 24 sts., then bind off 3 sts. 3x, 2 sts. 3x, 1 st. 4x and SHAPE SHOULDER same as the back after Row 292 (300) [304].
 Work the 2nd section with reverse shaping, making BUTTONHOLES after the Rows shown on the Chart, over needles 3 to 7 and 18 to 22, counting from the RIGHT edge.

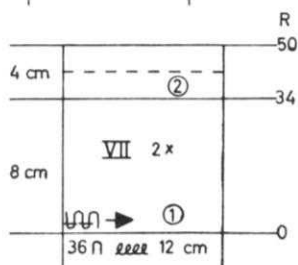

POCKET: VII Make 2.

Cast on 36 sts. with color 1 and work Stockinette stitch. Knit to Row 34 then change to color 2 and knit to Row 50. Bind off.

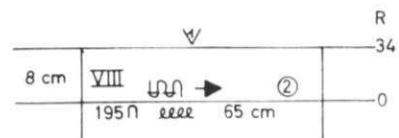

NECKBAND: VIII

Cast on 195 sts. with color 2 and work 34 rows Stockinette stitch. Bind off.

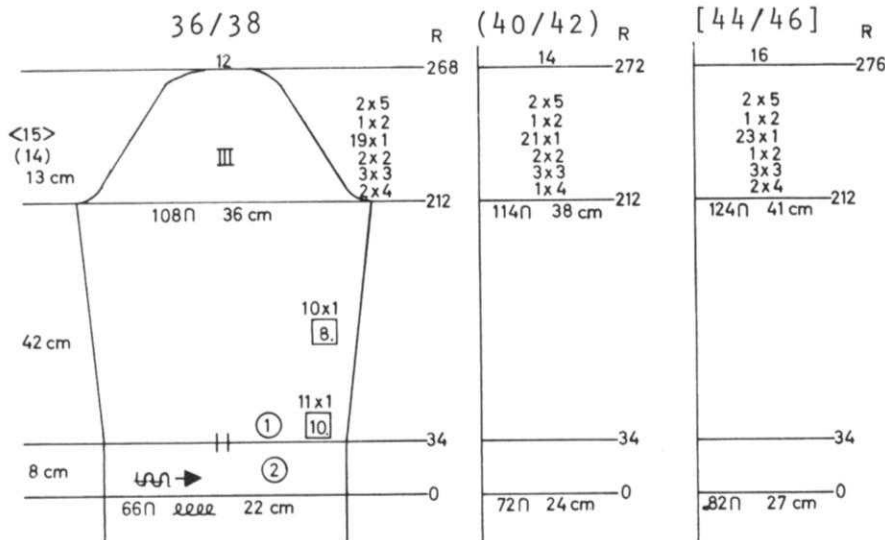

SLEEVE: III

Cast on 66 (72) [82] sts. with color 2 and work Stockinette stitch. Knit to Row 34, then hang the hem and continue with color 1. ON EACH SIDE, increase 1 st. every 10th row 11x, every 8th row 10x. Knit to Row 212. SHAPE CAP: ON EACH SIDE, bind off 4 sts. 2x, 3 sts. 3x, 2 sts. 2x, 1 st. 19x, 2 sts. 1x, 5 sts. 2x. (4 sts. 1x, 3 sts. 3x, 2 sts. 2x, 1 st. 21x, 2 sts. 1x, 5 sts. 2x). [4 sts. 2x, 3 sts. 3x, 2 sts. 1x, 1 st. 23x, 2 sts. 1x, 5 sts. 2x]. After Row 268 (272) [276], bind off the remaining 12 (14) [16] sts.

HP 226

MAN'S PULLOVER



SIZE: 34 (38) [42]
 YARN: Color 1 - Nicole
 Color 2 - Subita Crepe
 GRAMS: Color 1 450 500 550
 Color 2 50 50 50
 TENSION: 6 to 8
 GAUGE: 16 sts., 23 rows = 5 cm (2").

Stockinette stitch with color stripes as shown on the Chart.

FINISHING: See General Instructions.



BACK: II

Cast on 134 (146) [158] sts. with color 1 and work Stockinette stitch with color stripes as shown on the Chart. Continue with color 1 and knit to Row 34 then hang the hem. Knit to Row 194. SHAPE ARMHOLE: ON EACH SIDE, bind off 3 sts. 3x, 2 sts. 2x, 1 st. 3x. (3 sts. 3x, 2 sts. 2x, 1 st. 3x). [4 sts. 1x, 3 sts. 2x, 2 sts. 3x, 1 st. 3x]. Knit to Row 278 (282) [286]. Bind off the center 18 sts., put the needles on the left into holding position and complete the right half first. *SHAPE SHOULDER AND NECK AT THE SAME TIME. FOR SHOULDER, bind off 6 sts. 2x, 5 sts. 3x. (6 sts. 5x). [6 sts. 2x, 7 sts. 3x]. FOR NECK, on all sizes, bind off 6 sts. 3x. Move the Cam Box to the left side, turn the Row Counter back to 278 (282) [286] and complete the left half. Follow the instructions from *.

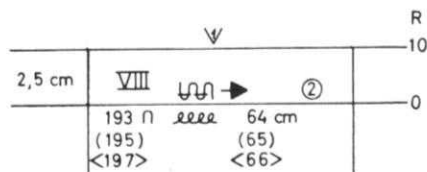
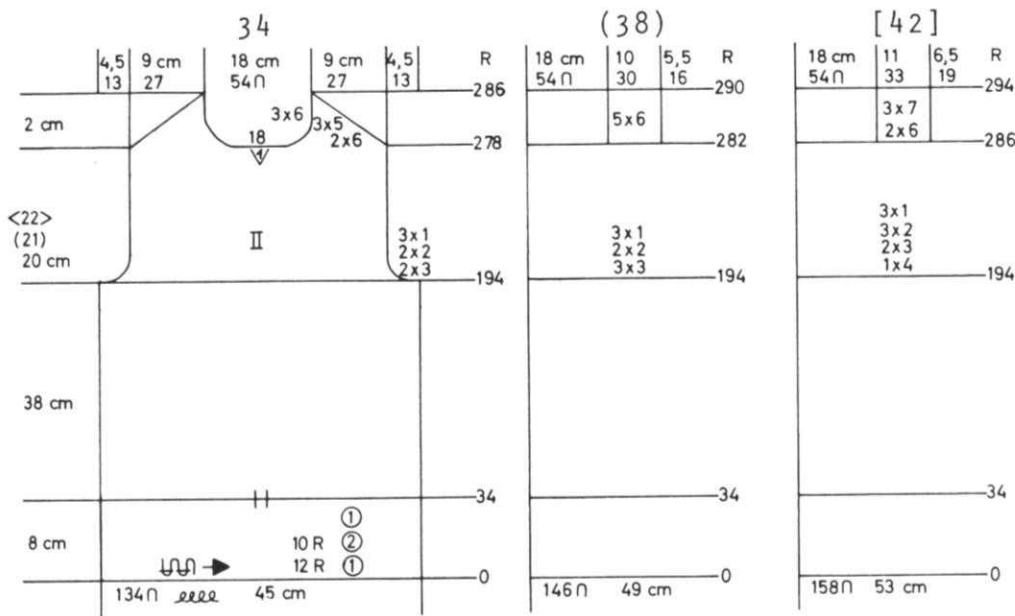

NECKBAND: VIII

Cast on 193 (195) [197] sts. with color 2 and work 10 rows Stockinette stitch then bind off.

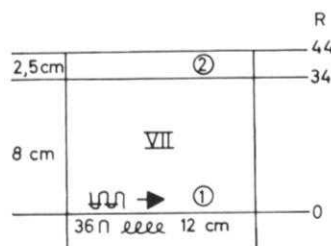

POCKET: Make 2.

Cast on 36 sts. with color 1 and work Stockinette stitch. Knit to Row 34, then change to color 2 and knit to Row 44. Bind off.



HE 226

FRONT: I

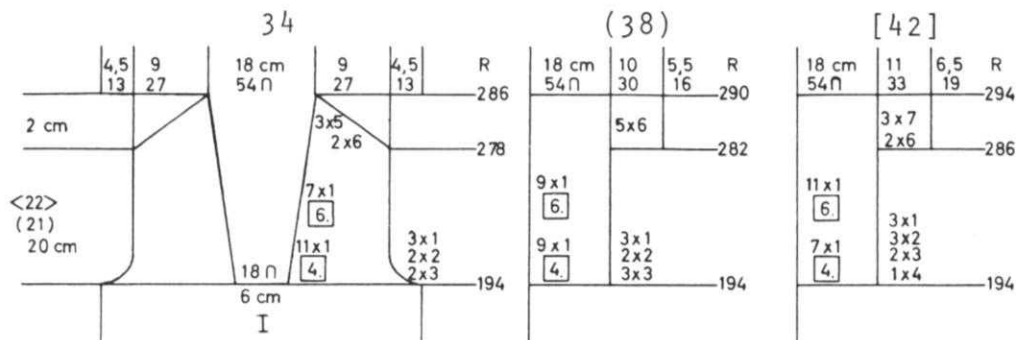

Work the front the same as the back to Row 194. Bind off the center 18 sts., put the needles on the left into holding position and complete the right half first. *SHAPE ARMHOLE AND NECK AT THE SAME TIME. FOR ARMHOLE, Make the bind-offs the same as the back and ON NECK SIDE, bind off 1 st. every 4th row 11x (9x) [7x] then every 6th row 7x (9x) [11x], and SHAPE SHOULDER same as the back after Row 278 (282) [286]. Move the Cam Box to the left side, turn the Row Counter back to 194 and complete the left half. Follow the instructions from *.

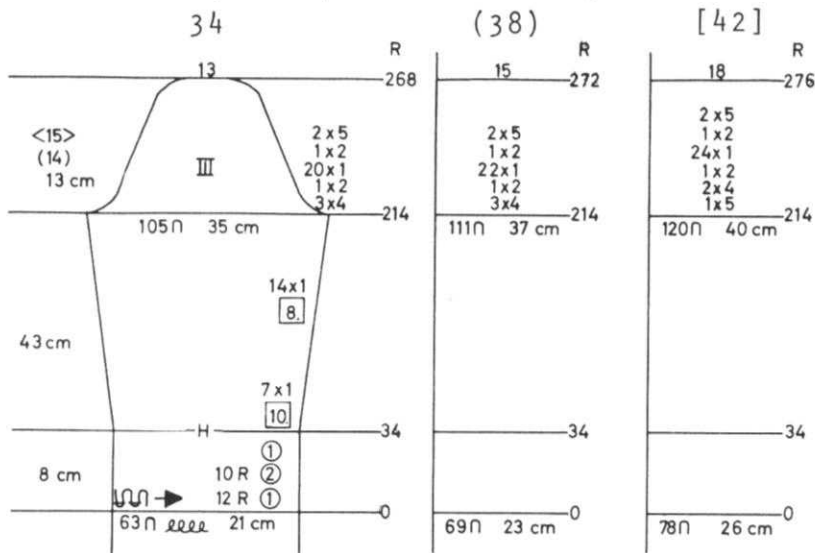

SLEEVE: III
Cast on 63 (69) [78] sts. with color 1 and work Stockinette stitch with color stripes as shown on the Chart then continue with color 1 to Row 34. Hang the hem. ON EACH SIDE, increase 1 st. every 10th row 7x, every 8th row 14x. Knit to Row 214. SHAPE CAP: ON EACH SIDE, bind off 4 sts. 3x, 2 sts. 1x, 1 st. 20x, 2 sts. 1x, 5 sts. 2x. (4 sts. 3x, 2 sts. 1x, 1 st. 22x, 2 sts. 1x, 5 sts. 2x). [5 sts. 1x, 4 sts. 2x, 2 sts. 1x, 1 st. 24x, 2 sts. 1x, 5 sts. 2x]. After Row 268 (272) [276], bind off the remaining 13 (15) [18] sts.

KK 227

CHILD'S SLEEVELESS PULLOVER



SIZE: 2 (4) [6]
YARN: Allegro
GRAMS: 100 150 200
TENSION: 5 to 7
GAUGE: 15 sts. 21 rows = 5 cm (2")

Stockinette stitch with 1 x 1 Ribbing for the Bands.

FINISHING: See General Instructions. Sew 2 felt appliques to front as shown in picture.

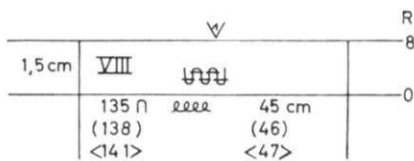

NECKBAND: VIII

Cast on 135 (138) [141] sts. and work 8 rows K1, P1 Ribbing then bind off the crochet method for Ribbing.

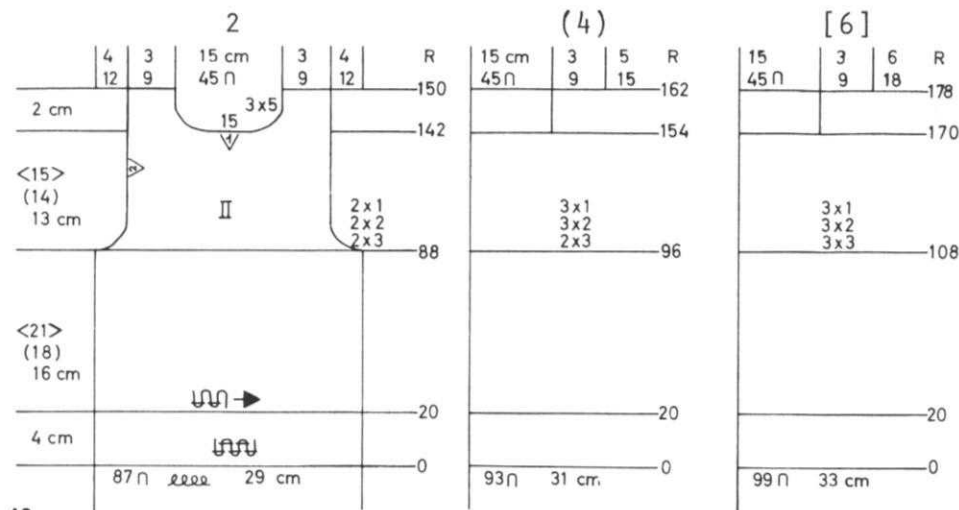

BACK: II

Cast on 87 (93) [99] sts. and work 20 rows K1, P1 Ribbing. Change to Stockinette stitch and knit to Row 88 (96) [108]. SHAPE ARMHOLE: ON EACH SIDE, bind off 3 sts. 2x, 2 sts. 2x, 1 st. 2x. (3 sts. 2x, 2 sts. 3x, 1 st. 3x). [3 sts. 3x, 2 sts. 3x, 1 st. 3x]. Knit to Row 142 (154) [170]. Bind off the center 15 sts., put the needles on the left into holding position and complete the right half first. *ON NECK SIDE, for all sizes, bind off 5 sts. 3x. Knit to Row 150 (162) [178] then bind off the remaining 9 sts. Move the Cam Box to the left side, turn the Row Counter back to 142 (154) [170] and complete the left half. Follow the instructions from *.

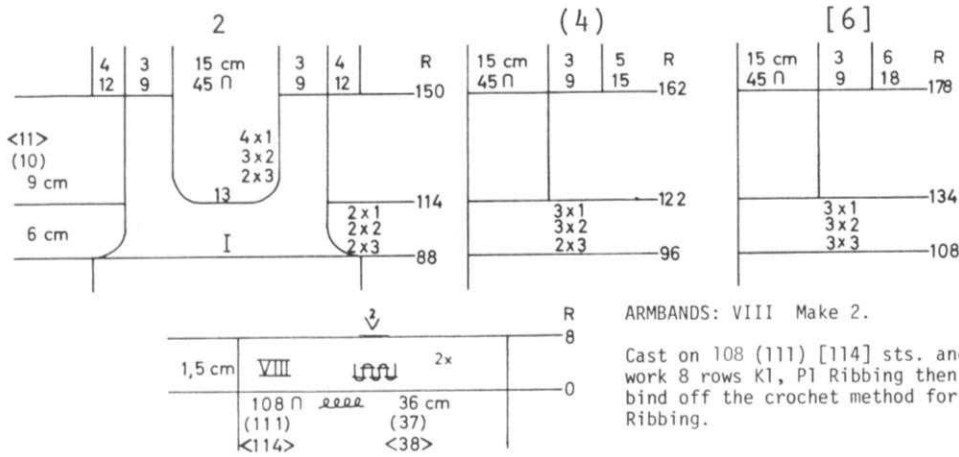

FRONT: I

Work the front the same as the back to Row 114 (122) [134]. Bind off the center 13 sts., put the needles on the left into hold-ing position and complete the right half first.

*ON NECK SIDE, for all sizes, bind off 3 sts. 2x, 2 sts. 3x, 1 st. 4x. Knit to Row 150 (162) [178] then bind off the remain-ing 9 sts.

Move the Cam Box to the left side, turn the Row Counter back to 114 (122) [134] and complete the left half. Follow the instructions from *.

ARMBANDS: VIII Make 2.

Cast on 108 (111) [114] sts. and work 8 rows K1, P1 Ribbing then bind off the crochet method for Ribbing.

baby blind stitch sewing machine

A brand new design Blind Stitch machine for the home sewer who accepts nothing but the best professional quality finishing.



List Price \$369.00

(California residents add Sales Tax)

Shipping charges: F.O.B. Los Angeles

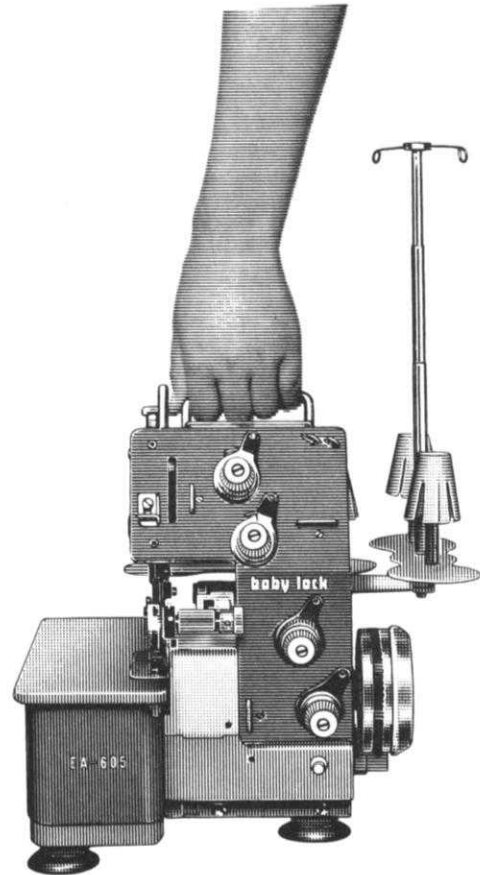

baby lock

MODEL NO. 605. Fabulous Cut, Sew and Overlock machine. Perfect for the entire Family.

List Price \$349.00

MODEL NO. 405. New Style Cut and Overlock Machine. Specially for knit materials.

List Price: \$329.00

(California residents add Sales Tax)

Shipping charges: F.O.B. Los Angeles

KK 228

GIRL'S DRESS

SIZE: 8 (10) [12]
 YARN: Allegro
 GRAMS:
 Color 1 450 500 550
 Color 2 50 50 50
 TENSION: 5 to 7
 GAUGE: 15 sts. 21 rows = 5 cm (2")



Stockinette stitch with a Cable Design. Follow the Line Drawing.

FINISHING: See General Instructions. Ease the Skirt to fit the Waistband. Sew pockets in place. Make short cords to fit across front opening, then sew the ends under one button, cross cord to opposite button - see picture.

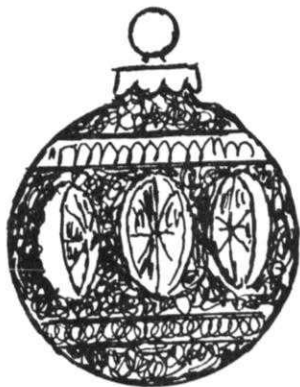

BACK: II

Cast on 108 (114) [120] sts. with color 1 and work Stockinette stitch and the Cable Design. Knit to Row 26, then hang the hem.
 ON EACH SIDE, increase 1 st. every 14th row 4x, every 12th row 2x. Knit to Row 114 (122) [130]. SHAPE ARMHOLE: ON EACH SIDE, bind off
 3 sts. 2x, 2 sts. 2x, 1 st. 2x. (3 sts. 2x, 2 sts. 2x, 1 st. 3x). [3 sts. 2x, 2 sts. 2x, 1 st. 5x]. Knit to Row 182 (194) [206]. Bind off the center 18 sts., put the needles on the left into holding position and complete the right half first.
 *SHAPE SHOULDER AND NECK AT THE SAME TIME.
 FOR SHOULDER, bind off 4 sts. 3x, 3 sts. 4x. (3 sts. 2x, 4 sts. 5x). [3 sts. 1x, 4 sts. 6x].
 FOR NECK, on all sizes, bind off 3 sts. 5x.
 Bring the needles on the left into working position, knit 1 row to the left side, turn the Row Counter back to 182 (194) [206] and complete the left half. Follow the instructions from *.

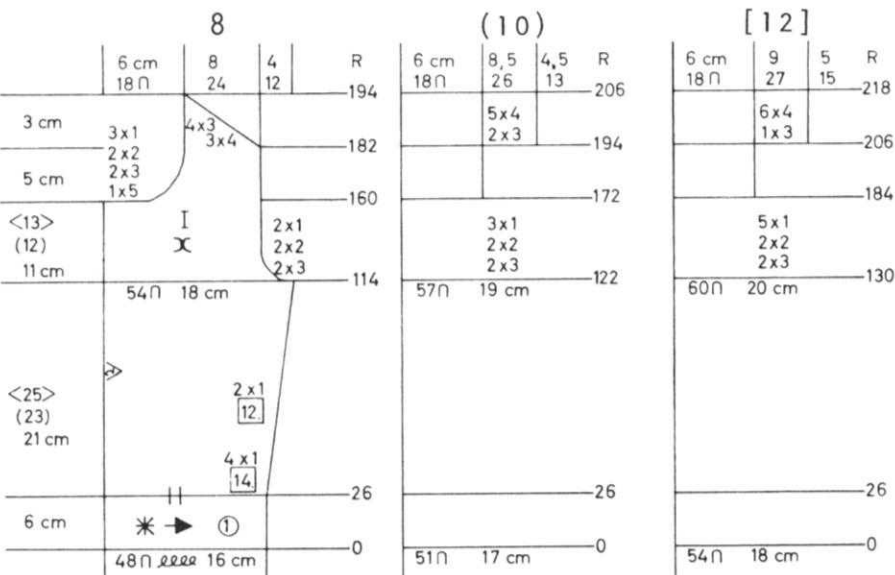
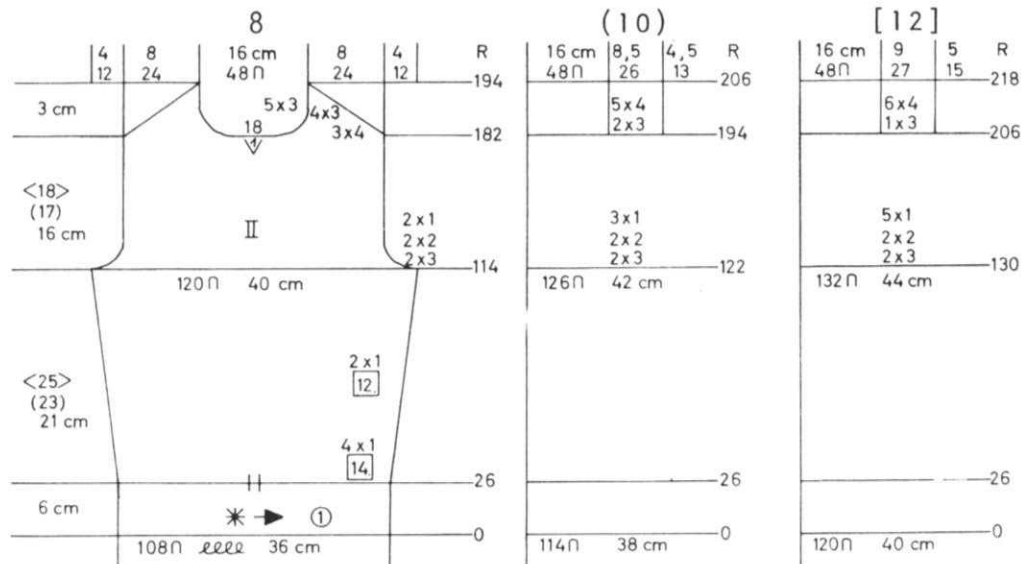

FRONT: I Make 1, reverse 1.

Cast on 48 (51) [54] sts. with color 1 and work Stockinette stitch with Cable Design. Knit to Row 26, then hang the hem. ON SIDE EDGE, increase 1 st. every 14th row 4x, every 12th row 2x. Knit to Row 114 (122) [130]. SHAPE ARMHOLE same as the back, then knit to Row 159 (171) [183]. ON NECK SIDE, for all sizes, bind off 5 sts. 1x, 3 sts. 2x, 2 sts. 2x, 1 st. 3x. SHAPE SHOULDER same as the back after Row 182 (194) [206].

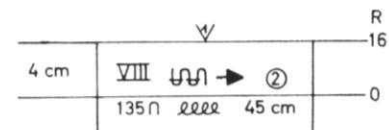

NECKBAND: VIII

Cast on 135 sts. with color 2 and work 16 rows Stockinette stitch then bind off.

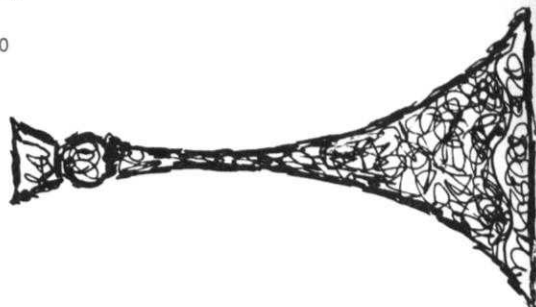

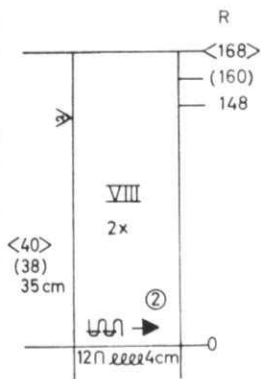

FRONT BAND: VIII Make 2.

Cast on 12 sts. with color 2 and work Stockinette stitch. Knit to Row 148 (160) [168] then bind off.

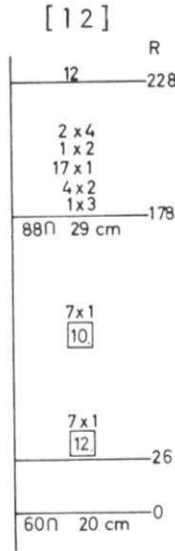
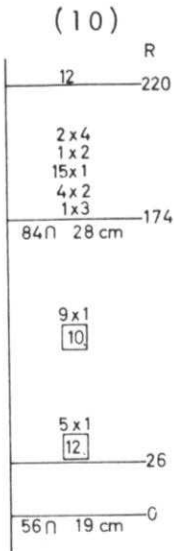
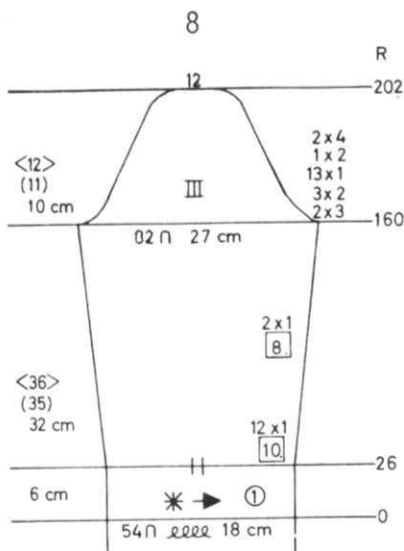

SLEEVE: III

Cast on 54 (56) [60] sts. with color 1 and work Stockinette stitch with Cable Design. Knit to Row 26, then hang the hem.
ON EACH SIDE, increase 1 st. every 10th row 12x, every 8th row 2x. (every 12th row 5x, every 10th row 9x). [every 12th row 7x, every 10th row 7x]. Knit to Row 160 (174) [178].
SHAPE CAP: ON EACH SIDE, bind off 3 sts. 2x, 2 sts. 3x, 1 st. 13x, 2 sts. 1x, 4 sts. 2x. (3 sts. 1x, 2 sts. 4x, 1 st. 15x, 2 sts. 1x, 4 sts. 2x). [3 sts. 1x, 2 sts. 4x, 1 st. 17x, 2 sts. 1x, 4 sts. 2x]. After Row 202 (220) [228], bind off the remaining 12 sts.

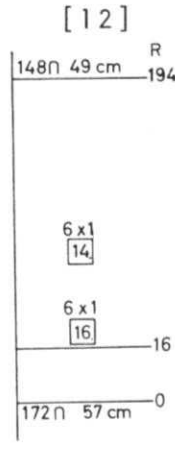
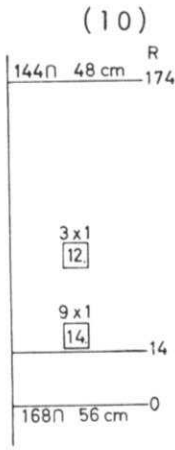
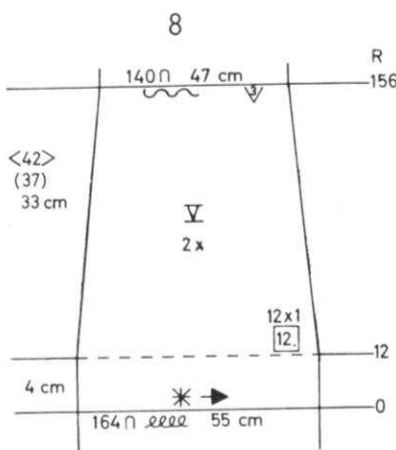

SKIRT: V Make 2.

Cast on 164 (168) [172] sts. with color 1 and work Stockinette stitch with Cable Design. Knit to Row 12 (14) [16].
ON EACH SIDE, decrease 1 st. every 12th row 12x. (every 14th row 9x, every 12th row 3x). [every 16th row 6x, every 14th row 6x]. Knit to Row 156 (174) [194], then bind off the remaining 140 (144) [148] sts.

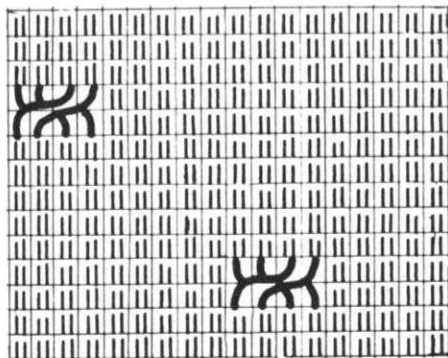

7-8
5-6
3-4
1-2
13-14
11-12
9-10
7-8
5-6
3-4
1-2
5-6
3-4
1-2

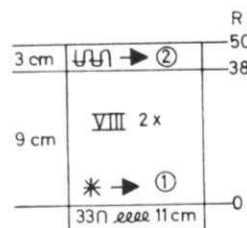

POCKET: VIII Make 2.

Cast on 33 sts. with color 1 and work Stockinette stitch with Cable Design. Knit to Row 38, change to color 2 and Stockinette stitch and knit to Row 50. Bind off.

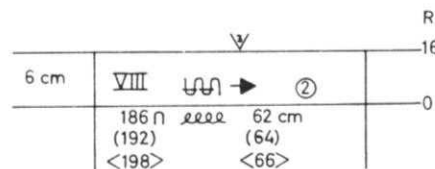

SKIRT WAISTBAND: VIII

Cast on 186 (192) [198] sts. with color 2 and work 16 rows Stockinette stitch then bind off.

KK 229

GIRL'S SKIRT & PULLOVER

SIZE: 4 (6) [8]
 YARN: Subita Crepe
 GRAMS: 350 400 450
 TENSION: 3 to 5
 GAUGE: 18 sts. 24 rows = 5 cm (2")

Stockinette stitch with Ribbed bands.

FINISHING: See General Instructions. Work 2 rows single crochet around lower edge of skirt, then turn to the inside and hem.

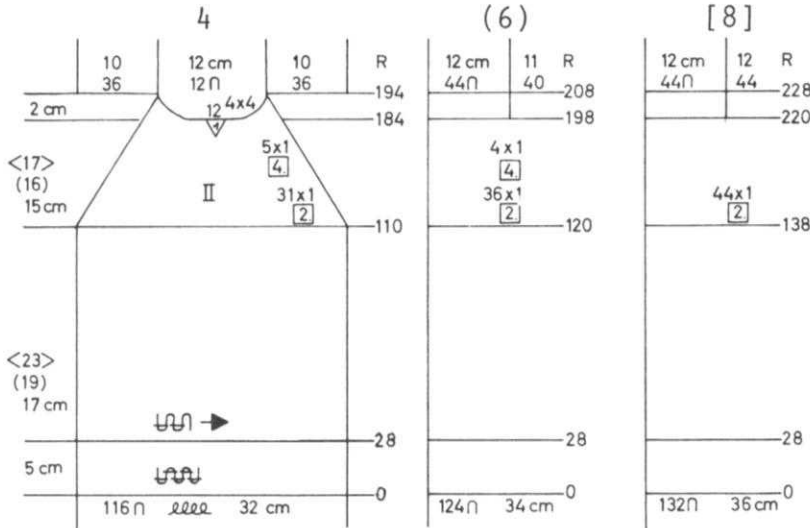

PULLOVER BACK: I

Cast on 116 (124) [132] sts. and work 28 rows K1, P1 Ribbing. Change to Stockinette stitch and knit to Row 110 (120) [138].

SHAPE RAGLAN: ON EACH SIDE, decrease 1 st. every 2nd row 31x (36x) [44x], then every 4th row 5x (4x) [0x] AND AT THE SAME TIME, after Row 184 (198) [220], bind off the center 12 sts., put the needles on the left into holding position and complete the right half first.

*ON NECK SIDE, for all sizes, bind off 4 sts. 4x.

Move the Cam Box to the left side, turn the Row Counter back to 184 (198) [220] and complete the left half. Follow the instructions from * and don't forget to complete the raglan shaping.



FRONT: I

Work the front the same as the back to Row 110 (120) [138].

SHAPE RAGLAN: ON EACH SIDE, decrease 1 st. every 2nd row 31x (38x) [2x], every 4th row 3x (0x) [40x] and AT THE SAME TIME, after Row 160 (174) [196], bind off the center 8 sts., put the needles on the left into holding position and complete the right half first.

*ON NECK SIDE, for all sizes, bind off 3 sts. 2x, 2 sts. 2x, 1 st. 7x. Move the Cam Box to the left side, turn the Row Counter back to 160 (174) [196] and complete the left half. Follow the instructions from * and don't forget to complete the raglan shaping.

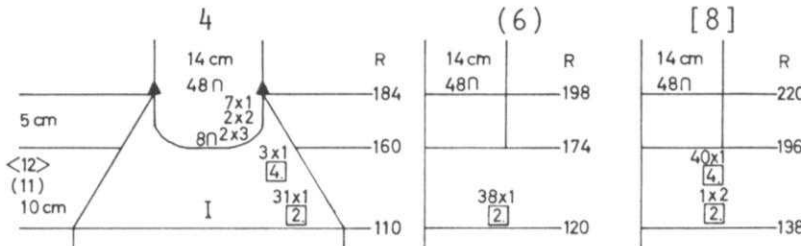

SLEEVE: III Make 1, reverse 1.

Cast on 60 (64) [68] sts. and work 28 rows K1, P1 Ribbing. Change to Stockinette stitch and ON EACH SIDE, increase 1 st. every 10th row 13x.

Knit to Row 158 (178) [198]. SHAPE RAGLAN: ON EACH SIDE, decrease 1 st. every 2nd row 31x (33x) [35x] then ON THE BACK SIDE of sleeve, for all sizes, decrease 1 st. every 4th row 5x, and ON THE FRONT SIDE for all sizes, on every 4th row, decrease 1 st. 2x and AT THE SAME TIME, after Row 230 (254) [278], work SHORT ROWS. ON OPPOSITE SIDE OF CAM BOX, put into holding position 3 sts. 5x, 2 sts. 1x. After Row 240 (264) [288], bring all the needles back into working position and bind off loosely.

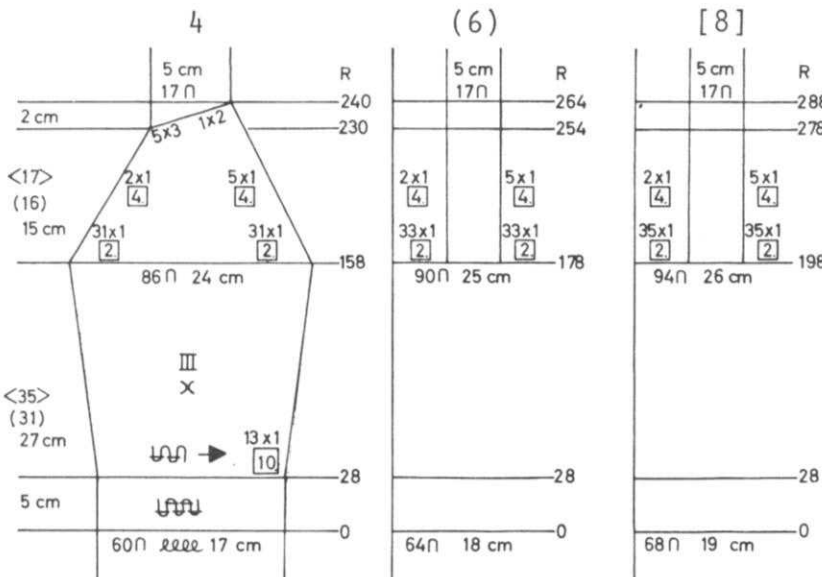

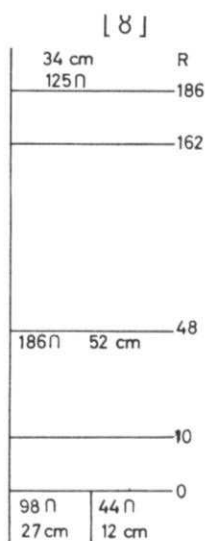
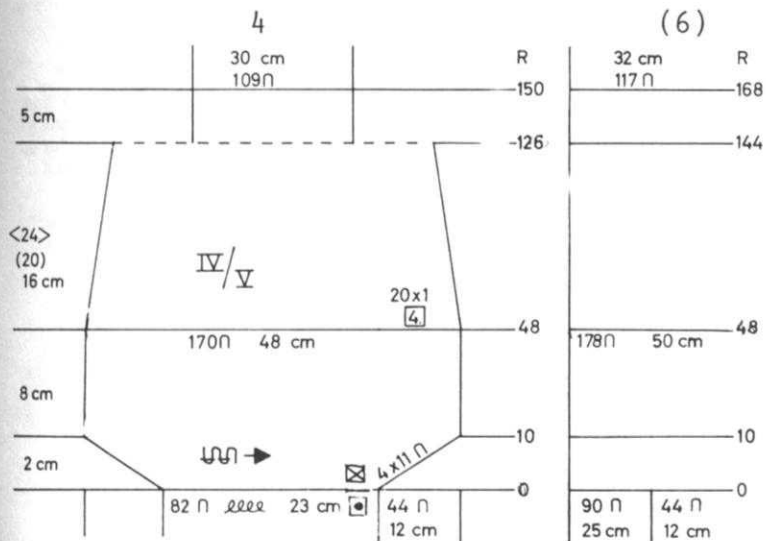

SKIRT BACK & FRONT: IV/V

Cast on 170 (178) [186] sts. and work Stockinette stitch. Work Short Rows.
ON OPPOSITE SIDE OF CAM BOX, put into holding position 44 sts. at Row 0 and after Row 1.
ON OPPOSITE SIDE OF CAM BOX, bring back into working position 11 sts. 4x ON EACH SIDE. Knit to Row 48.
ON EACH SIDE, decrease 1 st. every 4th row 20x.
After Row 126 (144) [162], remove the sts. onto contrast waste yarn.
Hang the sts. back onto the machine, decreasing to 109 (117) [125] sts. Knit to Row 150 (168) [186]. Bind off.

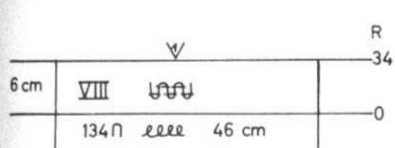

NECKBAND: VIII

Cast on 134 sts. and work 34 rows K1, P1 Ribbing then bind off the crochet method for Ribbing.

BE SURE TO NOTIFY US IMMEDIATELY OF ANY CHANGE OF ADDRESS. THE POST OFFICE WILL NOT FORWARD YOUR MAGAZINE TO YOU.



converta tape

For simple and speedy charting of custom knits.

List Price\$9.50

(California residents add Sales Tax)

Shipping charges: F.O.B. Los Angeles

Order direct from KNITKING

- 1128 Crenshaw Blvd., Los Angeles, California 90019

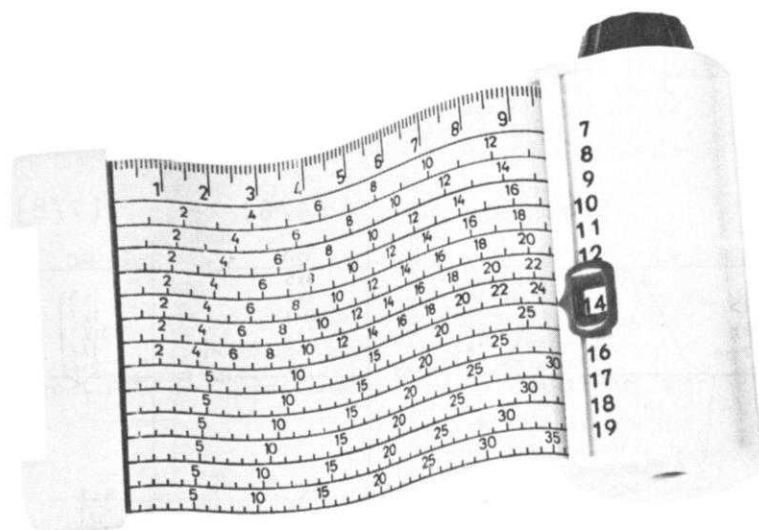

KK 230

CHILD'S PULLOVER

SIZE: 3/4 (5/6) [7/8]
 YARN: Mohana
 GRAMS:
 Color 1 200 250 300
 Color 2 50 50 50
 TENSION: 5 to 7
 GAUGE: 14 sts. 18 rows = 5 cm (2")



Stockinette stitch with a Norwegian Design. Follow the Line Drawing or use JAC 40 and Pattern No. 589. The bands are K1, P1 Ribbing.

FINISHING: See General Instructions.

NECKBAND: VIII

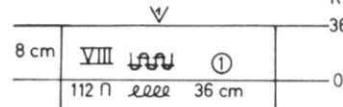

Cast on 112 sts. with color 1 and work 36 rows K1, P1 Ribbing then bind off the crochet method for Ribbing.

BACK: II

Cast on 84 (90) [96] sts. with color 1 and work 22 rows K1, P1 Ribbing. Change to the Norwegian Design and knit to Row 45, then continue with color 1 and Stockinette stitch. Knit to Row 84 (90) [96].

SHAPE ARMHOLE: ON EACH SIDE, bind off

2 sts. 2x, 1 st. 4x.
 (2 sts. 3x, 1 st. 4x).
 [3 sts. 2x, 2 sts. 2x, 1 st. 2x].
 Knit to Row 126 (136) [146].

Bind off the center 10 sts., put the needles on the left into holding position and complete the right half first.

*SHAPE SHOULDER AND NECK AT THE SAME TIME.

FOR SHOULDER, bind off

3 sts. 3x, 4 sts. 2x.
 (3 sts. 2x, 4 sts. 3x).
 [3 sts. 1x, 4 sts. 4x].

FOR NECK, on all sizes, bind off 4 sts. 3x.

Move the Cam Box to the left side, turn the Row Counter back to 126 (136) [146] and complete the left half. Follow the instructions from *.

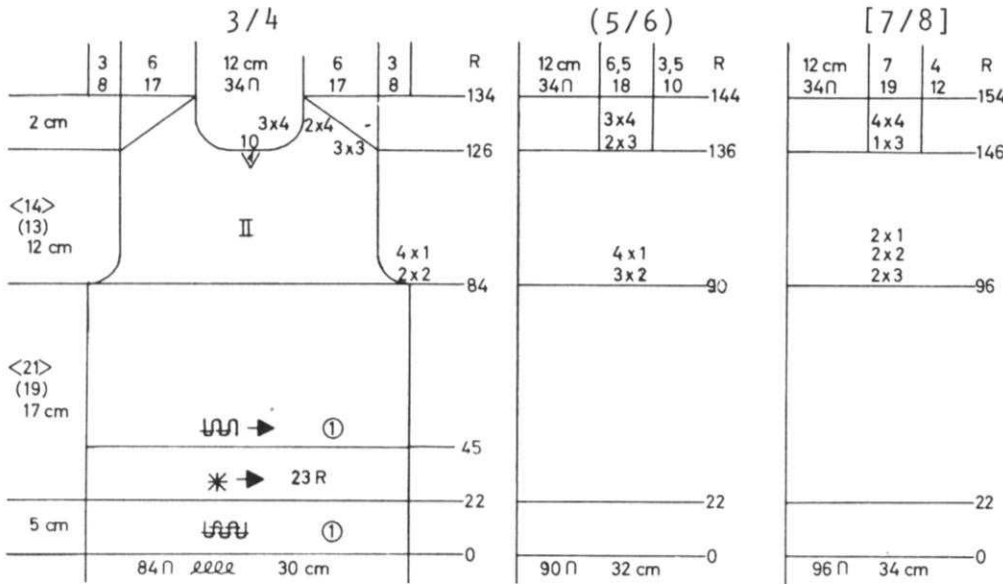

FRONT: I

Work the front the same as the back to Row 106 (118) [130]. Bind off the center 8 sts., put the needles on the left into holding position and complete the right half first.

*ON NECK SIDE, for all sizes, bind off 3 sts. 2x, 2 sts. 2x, 1 st. 3x, and SHAPE SHOULDER same as the back after Row 126 (136) [146].

Move the Cam Box to the left side, turn the Row Counter back to 106 (118) [130] and complete the left half. Follow the instructions from *.

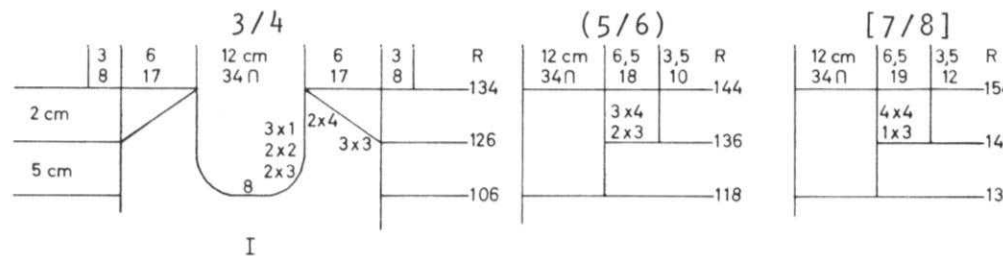

SLEEVE: III

Cast on 42 (48) [54] sts. with color 1 and work 22 rows K1, P1 Ribbing. Change to Stockinette stitch and ON EACH SIDE, increase 1 st. every 10th row 8x.

(every 12th row 6x, every 10th row 2x).
 [every 14th row 3x, every 12th row 5x].
 Knit to Row 102 (112) [122].

SHAPE CAP: ON EACH SIDE, bind off 3 sts. 2x, 2 sts. 1x, 1 st. 8x, 2 sts. 1x, 5 sts. 1x.

(4 sts. 1x, 3 sts. 1x, 2 sts. 1x, 1 st. 10x, 2 sts. 1x, 5 sts. 1x).
 [4 sts. 2x, 2 sts. 1x, 1 st. 11x, 2 sts. 1x, 5 sts. 1x].

After Row 128 (142) [154], bind off the remaining 12 (12) [14] sts.



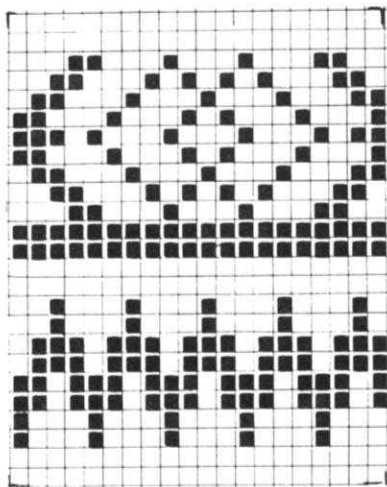

□ Color 1
■ Color 2



RK231

BABY DOLL ENSEMBLE 1A

SIZE: 13" to 14" 19" to 20"
YARN: Allegro Dunja
GRAMS 100 150
Small amounts of contrast color for crochet trim.
GAUGE:
Allegro: 15 sts. 21 rows = 5 cm
Dunja: 9 1/2 sts. 13 rows = 5 cm (2") over EVERY OTHER NEEDLE.



Stockinette stitch for dress, pantyies and booties. Simulated Rib for Hat. KNITTING machine owners, put Gate Cam Release Lever to the needle heels for the Rib stitch. Use every needle for Allegro and EVERY OTHER NEEDLE for Dunja. The instructions are the same.

FINISHING: See General Instructions. Dress: With contrast color, work 1 row single crochet around neck opening, neckline and sleeve edges, then 1 row picot as follows: *Chain 3, slip stitch into first chain, skip 1 single crochet, single crochet into next stitch and REPEAT from * around. Hat: Sew back seam, then pull up the top stitches and tie securely. Make pom-pom in contrast color and sew to top of hat. Booties: work 1 row single crochet, then 1 row double crochet. Make a chain with contrast color and pull through the openings in double crochet and tie in bow.

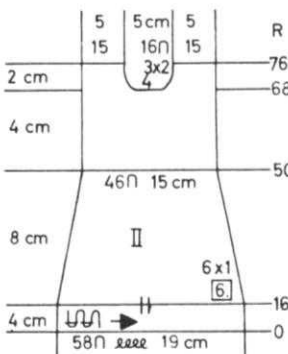

BACK: II

Cast on 58 sts. and work Stockinette stitch. Knit to Row 16 then hang the hem.
ON EACH SIDE, decrease 1 st. every 6th row 6x. Knit to Row 68. Bind off the center 4 sts., put the needles on the left into holding position and complete the right half first.
*ON NECK SIDE, bind off 2 sts. 3x. Bind off the remaining 15 sts. Move the Cam Box to the left side, turn the Row Counter back to 68 and complete the left half. Follow the instructions from *.

BOOTIES: Make 2

Cast on 11 sts. Knit 2 rows.
*WORK SHORT ROWS: ON OPPOSITE SIDE OF CAM BOX, put into holding position 1 st. 3x ON EACH SIDE. ON OPPOSITE SIDE OF CAM BOX, bring back into working position, 1 st. 3x ON EACH SIDE. REPEAT from * 1x more. With your latch tool, bind off 3-3-3-2 stitches at a time.

HAT:

Cast on 59 sts. Turn the tension down 1 number and knit 8 rows stockinette stitch. Change to simulated Rib (put Gate Cam Release Lever to needle heels). Knit 16 rows in Pattern, then hang the hem. Continue in Rib Pattern to Row 70. Change to Stockinette stitch, then knit to Row 74. Remove the stitches onto strand of yarn and pull up.

PANTS: BACK & FRONT:

Cast on 44 sts. and work Stockinette stitch. Knit to Row 12, hang the hem. Knit to Row 36.
ON EACH SIDE, decrease 1 st. every 2nd row 4x, then EVERY ROW to Row 56. Bind off the remaining 12 sts. Work the Front section the same except knit to Row 60, then bind off.

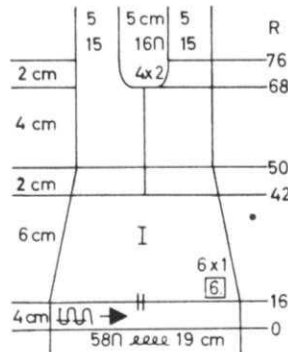

FRONT: I

Cast on 58 sts. and work Stockinette stitch. Knit to Row 16 then hang the hem. ON EACH SIDE, decrease 1 st. every 6th row 6x AND AT THE SAME TIME, after Row 42, divide in the center and put the needles on the left into holding position and complete the right half first.
*Knit to Row 67. ON NECK SIDE, bind off 2 sts. 4x. After Row 76, bind off the remaining 15 sts. Move the Cam Box to the left side, turn the Row Counter back to 42 and complete the left half. Follow the instructions from *.

TODDLER DOLL DRESS

SIZE: 14" to 16" Toddler Doll
YARN: Amore
GRAMS: 50 plus small amount contrast color for stripes and trim.
TENSION: 6 to 8
GAUGE: 15 sts. 21 rows = 5 cm (2").

Stockinette stitch with stripes in contrast color.

FINISHING: Same as finishing for 1A doll dress. Leave left shoulder open and sew small button to back and make loops on front shoulder.

BACK & FRONT the same.

Cast on 52 sts. with color 1 and work Stockinette stitch. Knit to Row 16, then hang the hem. ON EACH SIDE, decrease 1 st. every 4th row 8x. Knit to Row 50. Continue with REPEATED Color stripes as shown on the Chart. SHAPE ARMHOLE: ON EACH SIDE, bind off 1 st. 3x. Knit to Row 72. Bind off the center 4 sts. put the needles on the left into holding position and complete the right half first.
*ON NECK SIDE, bind off 2 sts. 2x, then bind off the remaining 9 sts. Move the Cam Box to the left side, turn the Row Counter back to 72 and complete the left half. Follow the instructions from *.

ALTERNATE BONNET:

Cast on 58 sts. and work Stockinette stitch. Knit to Row 16, hang the hem. Knit to Row 46. Bind off 19 sts. beginning next 2 rows, then ON EACH SIDE, decrease 1 st. every 6th row 3x. After Row 70, bind off the remaining 14 sts.

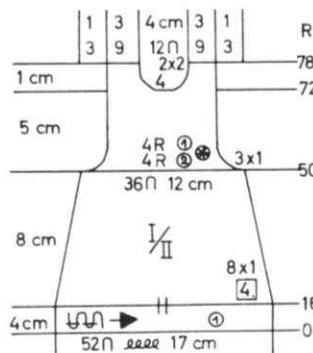

KK 232

BABY JACKET WITH HOOD and BOOTIES.



SIZE: Infant
 YARN: Amore
 GRAMS: 250
 TENSION: 5 to 7
 GAUGE: Pat: 12 sts. 42 rows = 5 cm (2")
 Stock: 15 sts. 24 rows = 5 cm

A Holding Position Design. Follow the Line Drawing. KNITTING machine owners, use Wheel No. 3.

FINISHING: See General Instructions.

Fold Hood in half and weave the open stitches together. Remove the contrast waste yarn. Finish all edges with 1 row single crochet, then 1 row double crochet. Sew Hood to neckline. Make a cord and thread through openings at neck. Make pom-poms and attach to ties. Booties: Weave the heel sts. together. Make cord and pom-pom for ties.

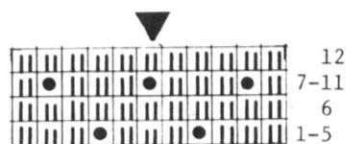

JACKET:

Cast on 62 sts. and work the Holding Position Design. Knit to Row 152.

ON EACH SIDE, cast on 31 sts. (use a separate yarn for left side). Be sure you watch Pattern. Knit to Row 220. Bind off the center 24 sts., put the needles on the left into holding position and complete the right half first. Be sure you note Pattern Row.

*Knit to Row 270. With a separate yarn, cast on 12 sts. at neck edge. Knit to Row 286.

Bind off 31 sts., then knit to Row 438 and bind off 31 sts. Bring the needles on the left into working position, knit 1 row in Pattern to the left side, turn the Row Counter back to 220 and complete the left half. Follow the instructions from *, BUT BE SURE YOU CONTINUE YOUR PATTERN FROM THE RIGHT SIDE.

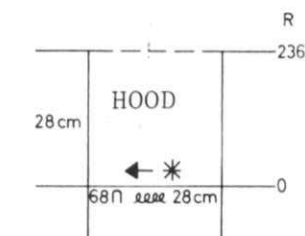

HOOD:

Cast on 68 sts. and work 236 rows Holding Position Design, then remove the sts. onto contrast waste yarn.

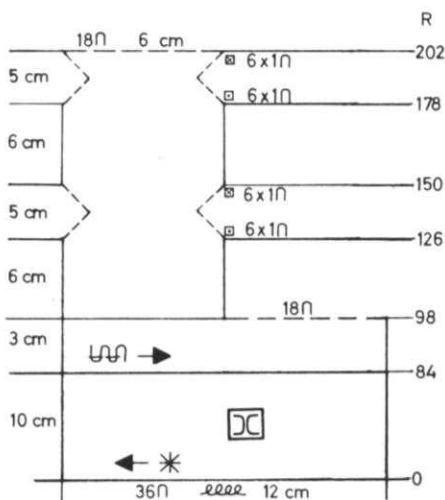
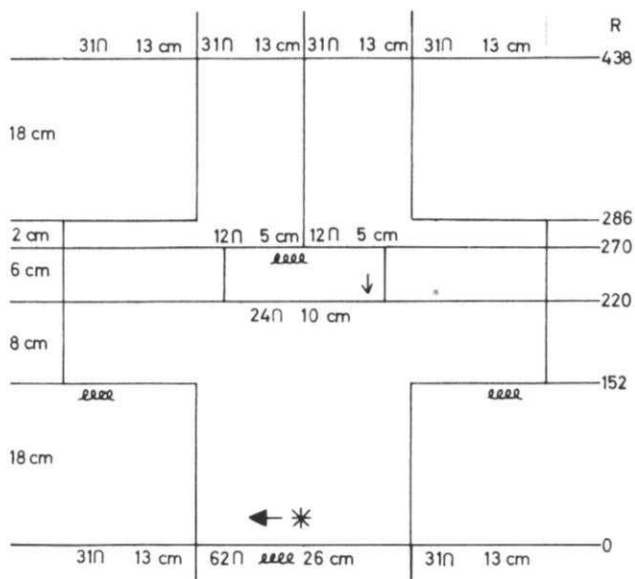

BOOTIES: Make 2.

Cast on 36 sts. and work the Holding Position Design to Row 84. Change to Stockinette stitch and knit to Row 98. Remove 18 sts. onto contrast waste yarn. Knit to Row 126.

WORK SHORT ROWS

*ON OPPOSITE SIDE OF CAM BOX, put into holding position 1 st. 6x ON EACH SIDE.

ON OPPOSITE SIDE OF CAM BOX, bring back into working position, 1 st. 6x ON EACH SIDE**.

Knit to Row 178. REPEAT the SHORT ROWS from * to **. Remove the 18 sts. onto contrast waste yarn. Work the 2nd Bootie with reverse shaping.

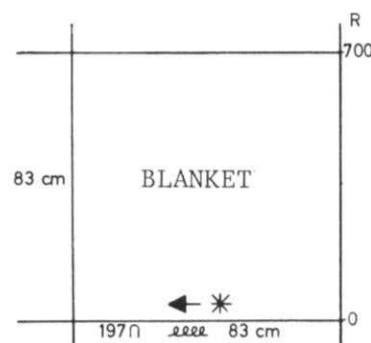

Cast on 197 sts. and work the Holding Position Design to Row 700 then bind off.

KK 233

BABY BLANKET

SIZE: 83 cm x 83 cm (Approximately 32" x 32".)
 YARN: Amore
 GRAMS: 250
 TENSION: 5 to 7
 Pattern: 12 sts. 42 rows = 5 cm (2")

A Holding Position Design. Follow the Line Drawing (same as KK 232). KNITTING machine owners use Wheel No. 3.

FINISHING: Work 2 rows single crochet around all edges, then make fringe on 2 sides.



RS234



PILLOW COVER

SIZE: 40 cm x 40 cm (approximately 16" x 16").
 YARN: Color 1 - Combinella Fina
 Color 2 - Beatrice
 GRAMS: Color 1 - 150
 Color 2 - 150
 TENSION: 6 to 8
 GAUGE: 16 sts. 20 rows = 5 cm.

A Norwegian Design. Follow the Line Drawing or you may punch your own card.

FINISHING: Fold in half and sew 2 sides. Pull Cover over a finished 16" Pillow Form.

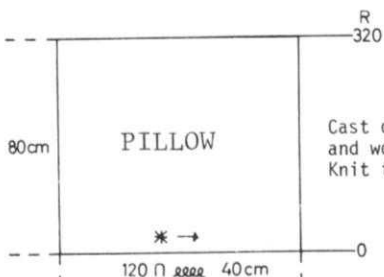

Cast on 120 sts. with color 1 and work the Norwegian Design. Knit to Row 320 then bind off.

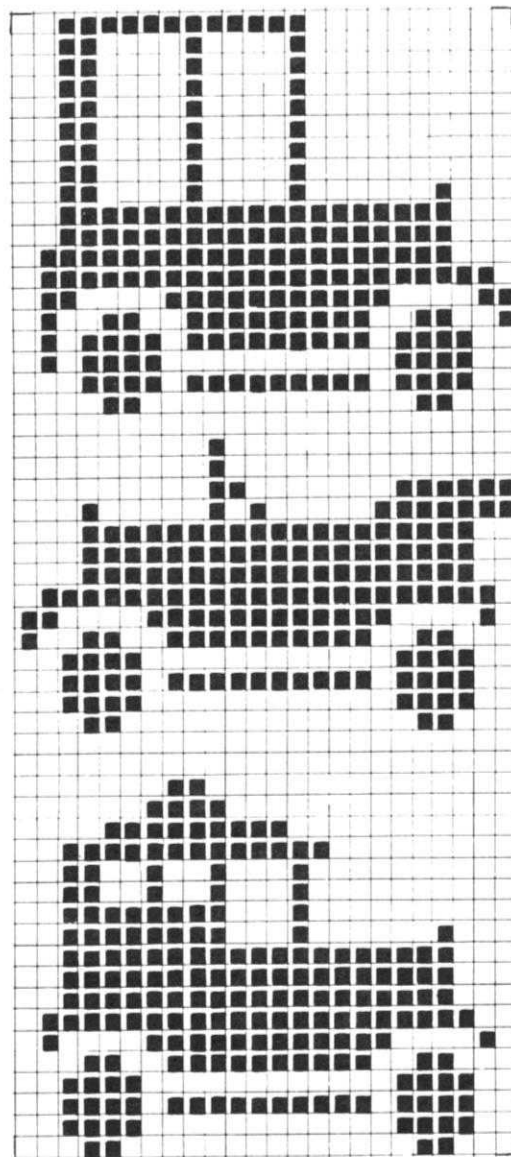

■ Color 2 □ Color 1

DK235



SCARF

SIZE: 15 cm x 180 cm (approximately 6" x 106").
 YARN: Beatrice
 GRAMS: Color 1 150
 Color 2 150
 TENSION: 5 to 7
 GAUGE: 16 sts. 42 rows = 5 cm (2").

FINISHING: Make fringe for each end.

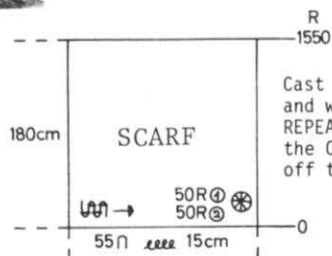

Cast on 55 sts. with color 2 and work K1, P1 Ribbing with REPEATED color stripes as shown on the Chart. After Row 1550, bind off the crochet method for Ribbing.

The Hand Knitting Machine with the most advanced automatic pattern selector

- 1 Lace designs
- 2 Weaving designs
- 3 Holding Position designs
- 4 Multi-color designs
- 5 Raised designs
- 6 Eyelet designs
- 7 Jacquard designs

Knit - Purl and fancy ribbed patterns

All knitted automatically without combs or weights. A multitude of fancy ribbed designs can be obtained with the cam operated push button controls.

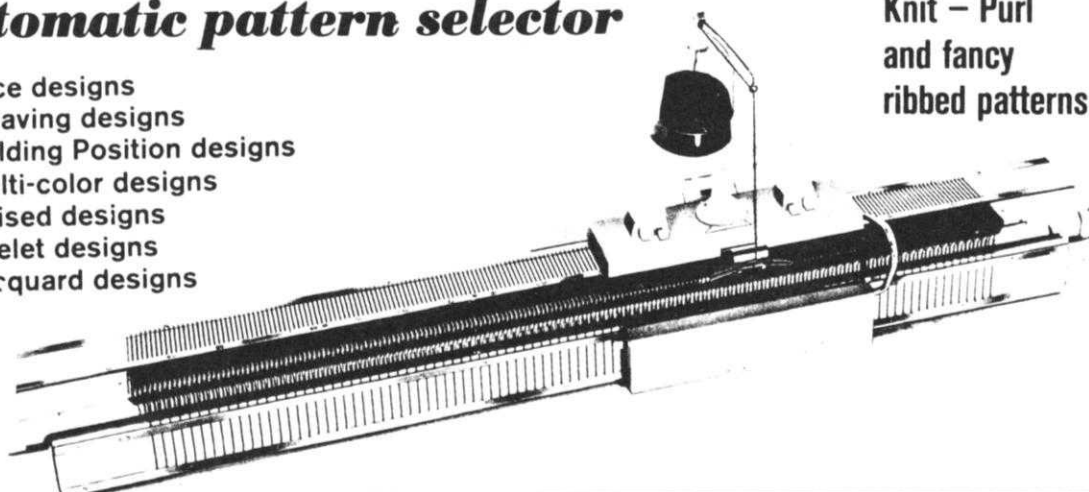

New products from KNITKING

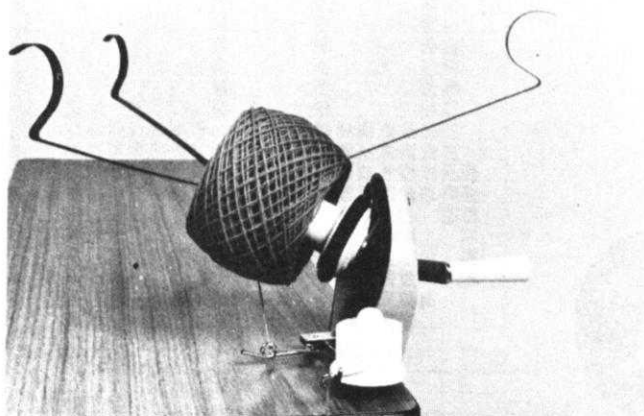

New design Yarn Winder with 'Waxamajig' and Skein Holder. As you can see from the illustration, this clever New Winder with Nylon Helical Gears winds a perfectly symmetrical ball. . . ! If you like to wax yarn (for easier knitting) you use the 'Waxamajig'. If waxing is not necessary, you bypass it . . . The Skein Holder is self adjusting. You will not find a better Hand Winder anywhere.

Complete price \$27.50
 (California residents add Sales Tax)
 Shipping charges: \$1.75

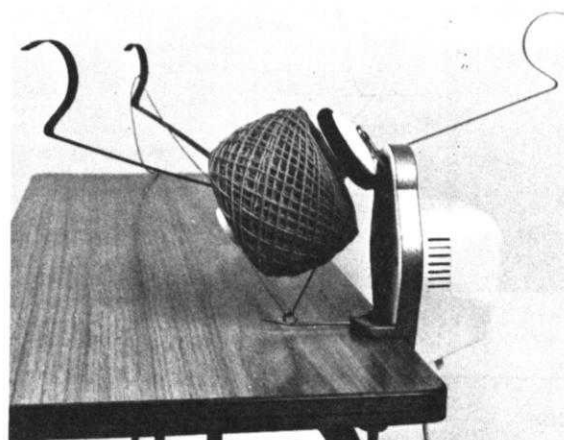

New design electric winder

Self-contained Motorized Winder (110/120 Volts) with Push Button on and off Switch . . . Special Clutch device to stop Winder if yarn bunches up or jams in the guide eye . . . Another excellent easy to use KNITKING product.

Price: Complete with Skein Holder \$44.95
 (California residents add Sales Tax).
 Shipping Charges: \$2.50



knitking carrying bags

Completely new design in heavy duty canvas with waterproof interior. For AM 3 Knitter and Yarn Container.

Price: \$46.50
 For Ribber only: \$23.00
 (California residents add Sales Tax)
 Shipping Costs: \$1.75 and \$1.00

Order direct from KNITKING —
 1128 Crenshaw Blvd., Los Angeles, California 90019

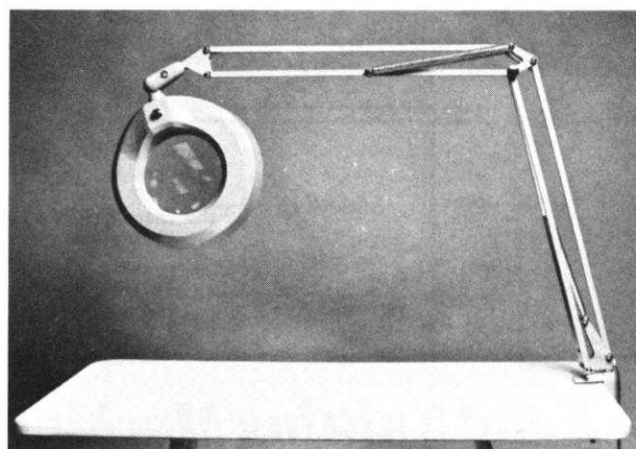

knitking magnifier lamp

A perfect gift item for any knitter. It has a large (5") magnifying lens and a cool fluorescent tube light. It stays in any position and is wonderful for general illumination for you to work under when joining seams, etc. Color: light grey.

Price: \$69.50
 (California residents add Sales Tax)
 Shipping Costs: \$3.00

NEW IMPROVED....

~~WHIZ KING~~ PATTERN READER

- It is now even easier to draw your own PATTERN READER CHARTS...
- A KNITKING Converta Tape is a part of every PATTERN READER...
- With the Converta Tape, you can measure anyone and immediately read off (without calculations) exactly how many stitches and rows you need for any part of a garment...
- TWO transparent sheets of special plastic graph are now with every PATTERN READER, together with a liquid crayon pen for drawing your own Charts, plus easy to follow instructions on how to draw any Chart...
- Because PATTERN READER Charts are drawn by stitches and rows, you are able to make Charts on a sheet 12 x 17 inches, instead of difficult to handle, life size sheets...

PRICE: \$69.50 Complete with instructions, practice Charts and illustrations of 50 complete Patterns for the entire family. (California residents add Sales Tax)
Shipping costs \$2.50.

ORDER DIRECT FROM KNITKING 1128 CRENSHAW BLVD. • LOS ANGELES, CALIFORNIA 90019

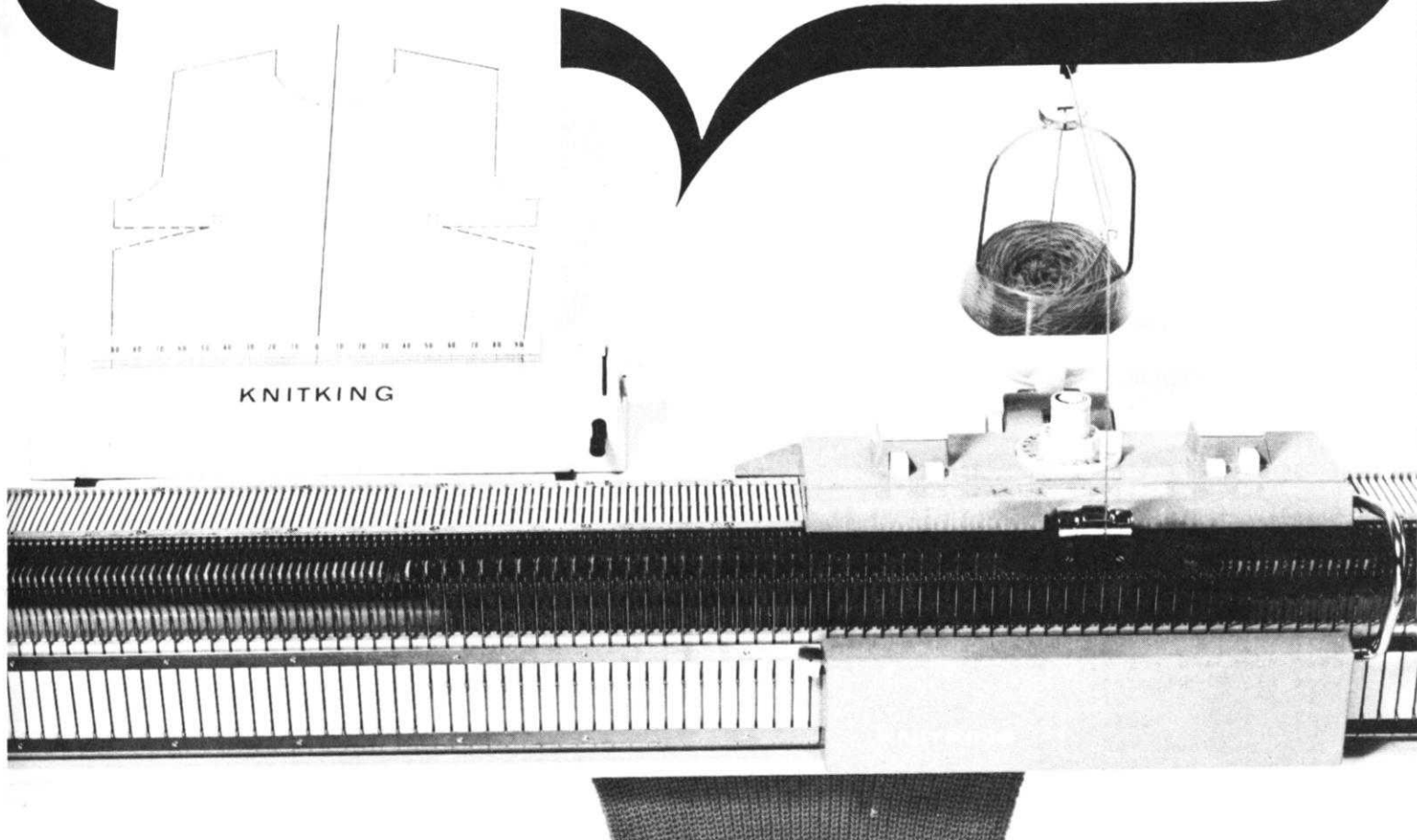



KnitKING News

PRACTICAL KNITTING HINTS

CABLE DESIGNS

In this issue of KNITKING MAGAZINE, there are Patterns which have a Cable Design and on each side of the twisted stitches there is a knit stitch (on the purl side). For example, DK 208 and DK 210 have this type of Cable Design. The easiest way to do this is... After knitting 20 or 30 rows, drop the stitch on each side of the twisted stitches and unravel them, then with a Latch Tool, latch the stitches up into knit stitches and hang them onto the needles... knit 20 or 30 rows and repeat the procedure, continuing with the twisted Cable as shown on the Line Drawing.

KNIT NECK AND ARMHOLE BANDS ONTO GARMENT SECTION

Sometimes it is easier for you to knit the bands for a neck or armhole right onto the garment sections. This is especially true if the bands are narrow and in Ribbing. DK 210 and DK 211 in this issue are good examples.

After blocking your sections, you can sew 1 shoulder together, then evenly pick up the neck stitches beginning with the open shoulder. Of course, if the back neckband is one section and the front neckband is two sections, you can sew up both shoulders, work the back neckband first, then each of the front sections. When working the armbands, hang a stitch from the shoulder first (as your center stitch) then pick up the stitches evenly on each side. If you are a bit round shouldered, you can space it so that you have an extra 1/2" on the back side of armhole and subtract this amount from the stitches for the front side.

Here is an excerpt from our PRACTICAL KNITTING HINTS BOOK which is no longer available. Although it is for a cast-on band, substitute 'pick up' for cast-on, follow the instructions and when you sew up your Ribbed band, it will be perfect.

When using the Ribber, the first and last stitches MUST always be on the main machine. When joining the sections that are ribbed, the seam at the ribbed part is very noticeable. To prevent this, and to end up with a continuous ribbing of K1, P1 when weaving seams together, you may use this method... On sleeves, round collars, armbands, etc., cast on an even number of stitches and put the first 2 stitches on the main machine. When knitting the bodice sections of a pullover, one of the sections only should have 2 stitches at each end on the main machine. On front bands that are knitted in 3 sections (which will be joined together), put 2 stitches at each end of the neckband section only, on the main machine. For cardigans and jackets, have two stitches at each end of the back section only on the main machine unless the cast on stitches for the front sections are an even number and in this case put 2 stitches on the side edge of each front section on the main machine. When you join the garment sections, always weave the ribbed part together 1 stitch in on each edge and you will see that the seams are an even K1, P1 Ribbing.

NEW PUNCHING ACCESSORY FOR JAC 40

Because we are introducing more and more 24 stitch repeat designs in KNITKING MAGAZINES in order that patterns can be duplicated on other brands of machines, it has become necessary to produce a punching accessory and blank cards for the JAC 40... The PUNCH and BLANK CARDS will be available in DECEMBER... We do not know their price at the time of going to press, but it will not be high, so if you want a PUNCH with BLANK CARDS and instructions, drop us a line and we will let you know as soon as they are available.

PATTERNS DK 219 and DK 220 THIS ISSUE

Only after the knitting and photographing of Patterns DK 219 and DK 220 did we decide to make instructions in adult sizes... so, please do not be confused because the dresses are photographed on teenagers...

KNITKING YARN CATALOGUE

We are producing an entirely new Catalogue with a lot of new yarns and new colors... We will be continuing with many of the popular yarns from our present catalogue... Colors and samples of our cone yarns will also be shown and the catalogue will be ready early in the new year... If you have already sent payment in for a catalogue, be patient with us... We have placed you on back order and the catalogue will be sent out as soon as available... If you have not sent in payment, please wait until we ask you to do so.

CHRISTMAS GIFT SLIPPERS

Sometime ago we published a one seam Patterned Slipper. Many of our readers wrote to us saying they make them often as gifts. We are reproducing the Pattern for you to knit for Christmas giving. They are easy and quickly made and make nice bed slippers without the bells.

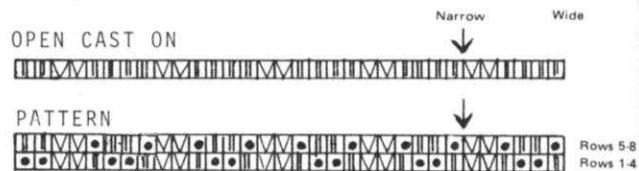

DO NOT WRAP THE NEEDLES WHEN WORKING PATTERN DESIGN.

MATERIAL: 2 balls Flamingo Dralon will make one pair. Wax the yarn when winding into a ball.
SIZE: Small, Medium, Large. There are two widths for the slippers. The narrow width is like a ballet slipper, the wider width is for those who like the slipper to come up higher on the foot.
TENSION: 7. KNITKING machine owners, use NEEDLE SHIFTER every 4 rows. The Purl side is the right side.

Set up the needles as shown in the Line Drawing - having 18 sts. in working position for the ballet type - 22 sts. in working position for the wider width. Use open cast-on with waste yarn. Knit several rows, ending with Cam Box on the LEFT side. Change to Main Yarn and knit 1 row to the right side. Turn Counter to 0.
 Knit in Pattern to: Row 316 for small size; Row 364 for medium size; Row 412 for large size.

(for extra large size, add 48 rows). Bring all the needles into working position and knit 1 row. Hang the first row of main yarn onto the needles in front of the latches, then knit these stitches through the ones in back of the latches. Bring 1 of the empty needles in each section (of those out of work) into working position and with Tension 10, knit 1 row, then bind off all stitches using the crochet method, dropping the yarn held on the original empty needles..(this was only to make binding off easier and to keep the bind-off elastic). Remove the waste yarn.

CORD: Make 2. Tension 1 to 3. Cast on 3 sts. Set your machine for knitting a cord. KNITTING machine owners, push back the right Cam Control Button and leave it there. (the empty rows do count). Knit 300 rows for small; 330 rows for medium; 350 rows for large and extra large.

FINISHING: Fold slipper in half and beginning at bind off end, and with right sides together, over cast the two bottom edges together. Run cord through openings at top so that you can tie in front. Put bells on ends (or beads) of ties.



CLEARANCE SALE OF DEMONSTRATOR AND TRADED MACHINES

Our warehouse is jammed to the ceiling with traded machines and we must get rid of them irrespective of price. In our CLEARANCE SALE, we are only offering machines that are in excellent working condition... so, if you have need of a second machine or you know a friend that would like one, get your order in fast... Just take a look at our prices... Juki 1300 is currently being sold as Model 1500... it is the identical machine and the retail price is \$369.00... Our price NEW is \$199.00... We have a batch of demonstrators and traded 1300 machines all in excellent condition at the greatly reduced price of \$99.50 each.

We have a great assortment of BROTHER demo and used machines available... take your pick and place your order fast.

Swiftomatic double bed machines sell for \$399.00.. Our drastically reduced price is \$75.00... Turmix double bed machines also sell for \$399.00 and are reduced to \$75.00... If you are looking for a really big double bed machine, we have two 444 needle Orion's reduced from \$499.00 to \$100.00 each.

The Duomatic generally recognized as the best of the double bed machines is available and our prices are excellent... This machine always sells fast.

There are some beautiful demonstrator BABY LOCK and BABY BLINDSTITCH machines at low low prices, but don't delay in placing your order...

| | | <u>CONDITION</u> | <u>SALE PRICE</u> |
|---------------------------|---|------------------|-------------------|
| <u>SINGLE BED</u> | | | |
| KNITTING | AM3 Cam operated with Ribbing Attachment - sells for \$499.00 | Like new (Demo) | \$349.00 |
| BROTHER | 820 Computerized with Lacemaker - sells for \$429.95 | Like new (Demo) | \$329.00 |
| | 800 Computerized with Lacemaker, Knitleader & Ribber | Excellent | 325.00 |
| | 588 with Ribber and Knitleader, Lacemaker | Excellent | 275.00 |
| | 588 with Lacemaker - Sells for \$269.95 | Excellent | 150.00 |
| | 585 with Lacemaker - Sold for \$239.50 | Excellent | 150.00 |
| | 585 with Lacemaker - Sold for \$239.50 | Very good | 95.00 |
| STUDIO | 500 - Basic Stockinette - Sells for \$99.50 | Like new | 55.00 |
| | 301 - with Ribber | Very good | \$ 95.00 |
| JUKI | 1300 Punch Card Lacemaker machine - sells for \$369.00 | Brand new | \$199.00 |
| | 1300 Punch Card Lacemaker machine - sells for \$369.00 | Excellent | 95.00 |
| GENIE | 1800 with Ribber | Like new | \$165.00 |
| | 1800 Sells for \$159.00 | Excellent | 85.00 |
| | 1800 Sells for \$159.00 | Very good | 65.00 |
| | 1500 Sells for \$99.50 | Very good | 50.00 |
| <u>DOUBLE BED</u> | | | |
| DUOMATIC | - Sold for \$419.50 | Like new | \$275.00 |
| DUOMATIC | - Sold for \$419.50 | Very good | 195.00 |
| SWIFTOMATIC | - Sold for \$399.00 | Very good | 75.00 |
| TURMIX | - Sold for \$399.00 | Very good | 75.00 |
| ORION | 444 needles- Sold for \$499.00 | Very good | 100.00 |
| ORION | 360 needles - Sold for \$399.00 | Very good | 75.00 |
| <u>BABY LOCK MACHINES</u> | | | |
| 605 | Cut, Sew, Overlock - List \$349.50 | Excellent | \$239.00 |
| 405 | 3 thread Overlock - List \$329.50 | Excellent | 229.00 |
| 606 | BABY BLINDSTITCH - List \$369.50 | Like new (Demo) | 239.00 |
| 606 | BABY BLINDSTITCH - List \$369.50 | Excellent | 239.00 |



knitking accessory price list

| | PRICE | SHIPPING | | PRICE | SHIPPING |
|------------------------------------|----------|----------|------------------------------------|---------|----------|
| WHIZ KING PATTERN READER | \$69.50 | \$2.50 | Reversing Bar (197 Needle KNIT- | | |
| Increase-Decrease Compensator .. | 27.50 | 2.00 | KING Machine only | \$34.95 | \$1.75 |
| 3-Color Yarn Feeder | 24.50 | 1.50 | Converta Tape (for Charting Pat- | | |
| Pattern Stitch Cards for AM 3 | | | terns to size) | 9.50 | .60 |
| KNITKING Machine only - | | | Fluorescent Magnifying Lamp with | | |
| #17 to #48 | 10.50 | 1.25 | 5 inch lens and adjustable 45 | | |
| Weaving Accessory for AM 3 | | | inch extension arm (specify | | |
| KNITKING only | 8.95 | .80 | table clamp or wall Fitting) . . . | 69.50 | 3.00 |
| Adjustable Needle Selector | | | JAC 40 (KNITKING Machine only) | 32.50 | 1.50 |
| (33 Needle) | 4.25 | .60 | JAC 40 Punch Cards. Please give | | |
| Cam Wheels for AM 3 KNITKING | | | alternate numbers ... Each | 1.25 | .15 |
| Machine only | 2.75 | .10 | Strap for JAC 40 | 2.00 | .30 |
| Knitting Table (suitable for all | | | KNITKING Instruction Book | | |
| machines | 39.50 | F.O.B. | (specify machine) | 4.00 | .50 |
| KNITKING Metal Table | 39.50 | F.O.B. | 1 Year Subscription to KNITKING | | |
| Treble Transfer Tool (pair) ... | 3.50 | .50 | MAGAZINE (6 issues) | 10.00 | (no tax) |
| Multiple Transfer Tool (33 needle) | 4.25 | .60 | Canada | 12.00 | |
| Double Transfer Tool (pair) | 2.50 | .50 | Back Issues of KNITKING MAGAZINE | | |
| Transfer Tools (1 each - 4 needle | | | SINGLE COPY (thru Vol. 10)Ea. | 1.50 | Postpaid |
| and 6 needle) | 3.25 | .50 | After Vol. 11 No. 1 ... Each | 3.00 | Postpaid |
| Combined Latch Needle & Transfer | | | Complete 6th or 7th or 8th or 9th | | |
| Tool | 1.50 | .25 | or 10th Bound Volume of | | |
| Combined Work Hook & Transfer | | | KNITKING MAGAZINE (6 | | |
| Tool | 1.50 | .25 | issues bound in Plastic Cover)Ea. | 7.95 | 1.15 |
| Knitting Machine Needles for | | | KNITKING Yarn Catalogue | 1.00 | Postpaid |
| KNITKING Machines only .. | .55 | .10 | | | |
| Ribbing Attachment Needles for | | | | | |
| KNITKING Ribbers only | .65 | .10 | | | |
| Ribber Transfer Needles | .45 | .10 | | | |
| Strippers for KNITKING Ribber(pr) | .95 | .25 | | | |
| KNITKING Sinker & Spring (specify | | | | | |
| Machine No.) | .20 | .15 | | | |
| Shipping for 20 | | .35 | | | |
| Yarn Winder with 'Waxamajig' and | | | | | |
| Skein Holder | 27.50 | 1.75 | | | |
| Wax Spools | Each .30 | .20 | | | |
| OR 4 for | 1.00 | .40 | | | |

Sorry, No C.O.D.'s or Billings, Please send money with your order. California Residents please add Sales Tax.

Price Lists prior to this date are obsolete.

KNITKING, INC.

1128 Crenshaw Blvd., Los Angeles, California 90019



DK 209





DK 212





DK 218





KK 228





KK 227

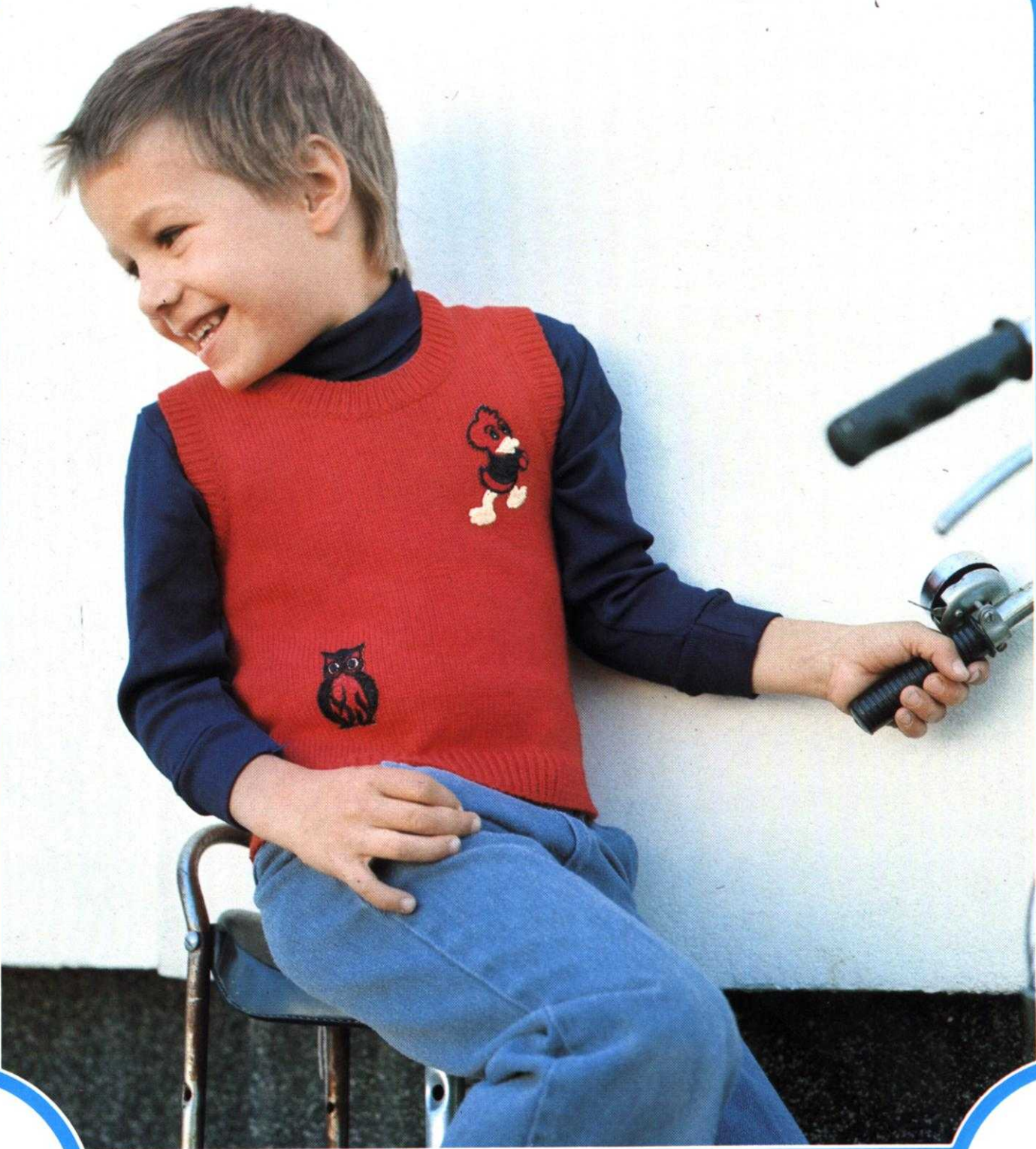



KK 232



KK 229



KK 233

DK 219



DK 220

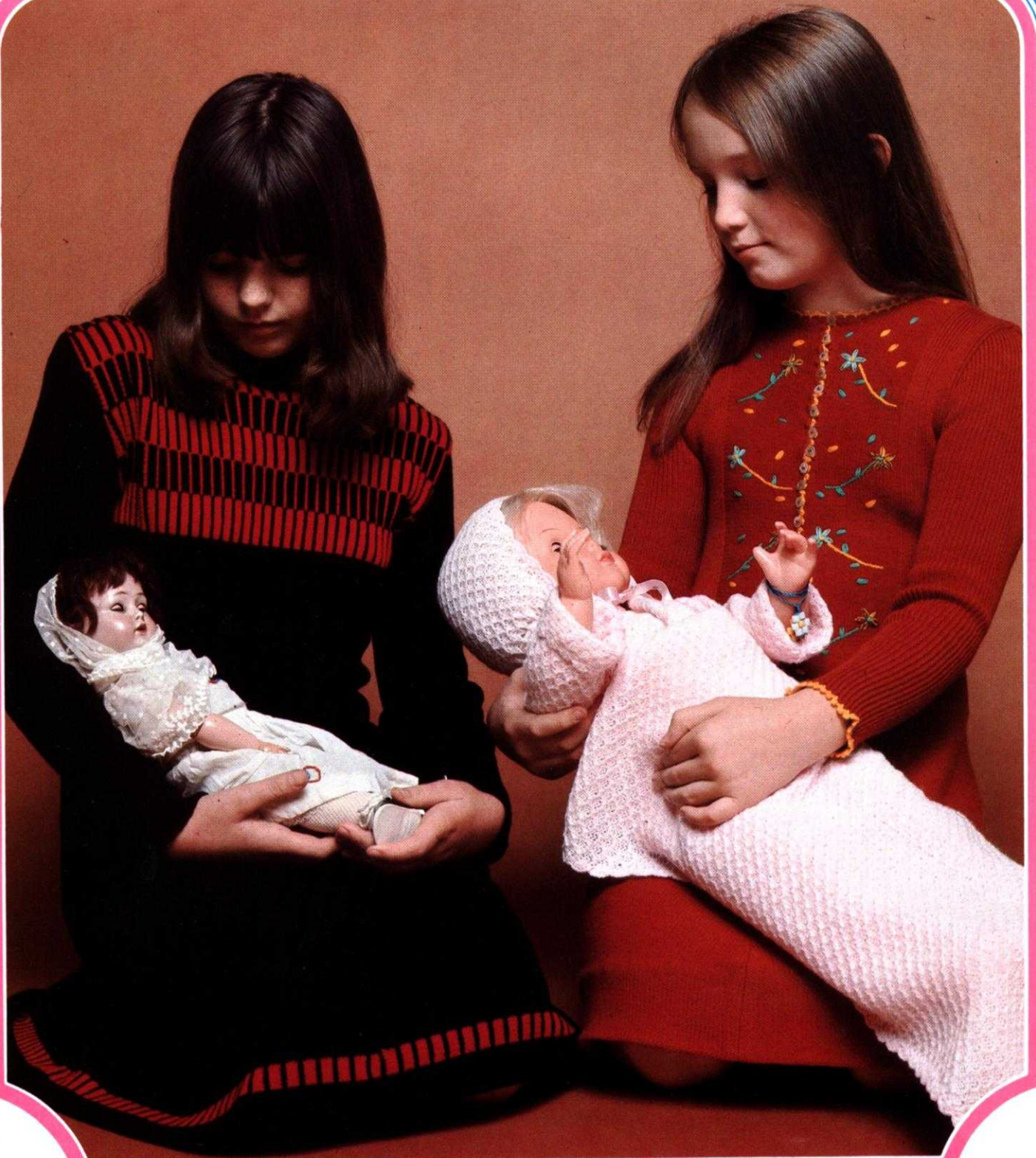



KK 230





KV 231

RS 234



