

knitking

magazine

may/june '72

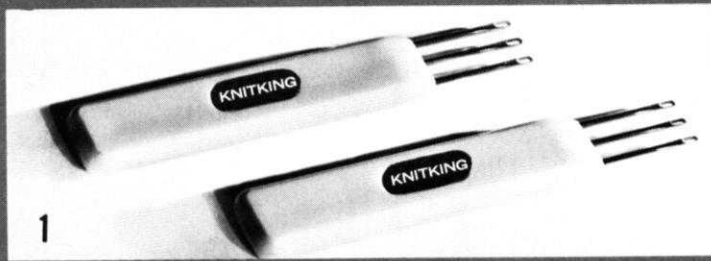

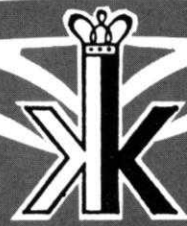

1

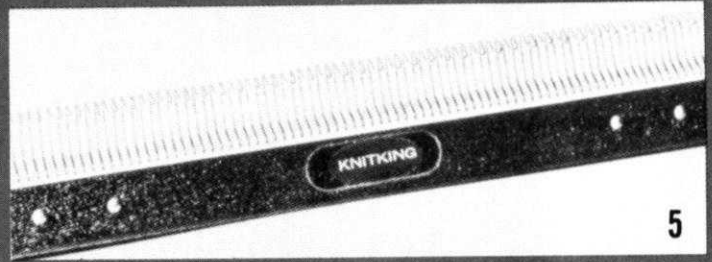

5

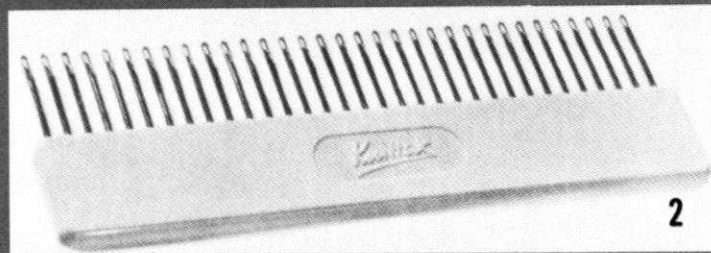

2

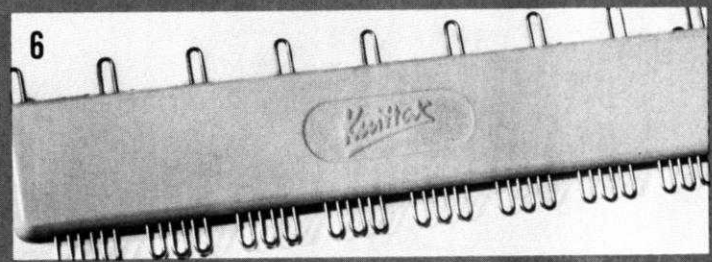

6

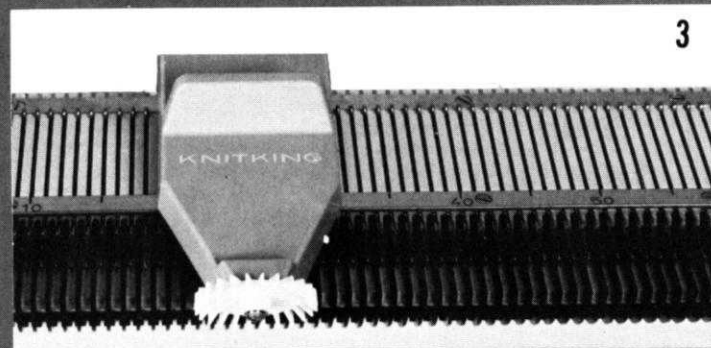

3

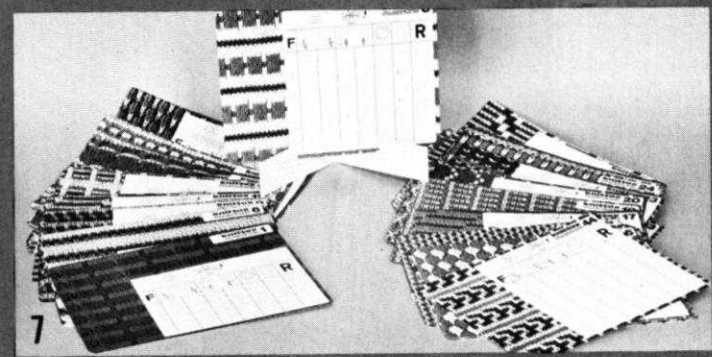

7

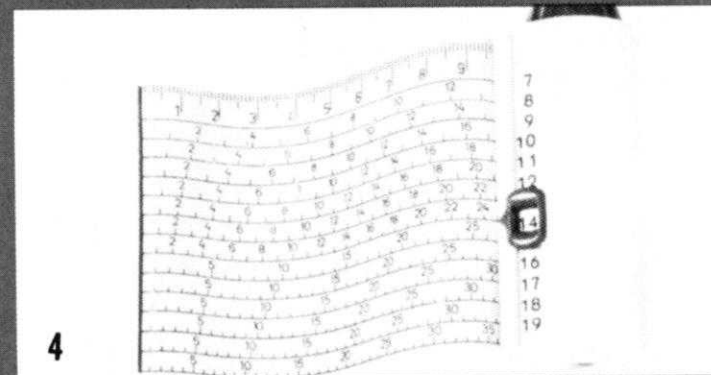

4

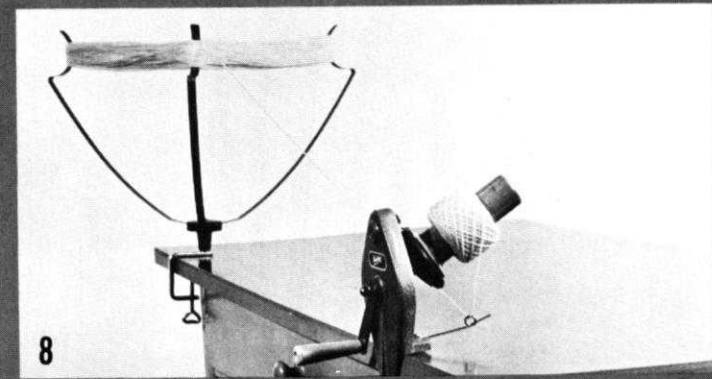

8

accessories

1. Treble Transfer Tools for rapid transfer of stitches and for Cable Stitch. \$1.80 pair plus 50¢ shipping.

2. 33 Needle Multi-Transfer Tool. For decreasing in the middle of a row. \$3.25 plus 50¢ shipping.

3. KNITKING Weaving Accessory (for AM 3 machine). Weaves an additional thread into your knitting and produces patterns with a woven appearance. \$7.95 plus 65¢ shipping.

4. Converta Tape. For simple and speedy charting of custom knits. \$7.95 plus 50¢ shipping.

5. Reversing Bar. For easy hem turning or reversing of knitting. \$18.95 plus \$1.50 shipping.

6. Adjustable Needle Selector. For setting unevenly spaced pattern stitches. \$3.50 plus 50¢ shipping.

7. KNITKING Pattern Stitch Cards (for AM 3 machine only). 48 Pattern Cards with 96 beautiful patterns in color and black and white. Simple row by row instructions. \$9.50 plus 95¢ shipping.

8. Yarn Winder and Skein Holder. Heavy cast frame and nylon gears. \$16.95 plus \$1.60 shipping. Without Skein Holder \$13.50 plus \$1.00 shipping.

California residents add 5% Sales Tax

KNITKING • 1128 Crenshaw Blvd., Los Angeles, California 90019

knitking

magazine

INDEX	PAGE NO.
DK 8023	Woman's Midriff and Pants 16
DK 8044	Woman's Bikini and Skirt 17
MK 5355	Girl's Dress, Top and Shorts 18
DK 8043	Woman's Midriff, Bikini Shorts & Long Pants 19
DK 8041	Woman's Shorts, Pullover & Midriff 21
HP 3665	Man's Pullover 22
DK 8034	Woman's Pants & Short Sleeved Jacket 22
KK 5339	Boy's Pants and Pullover 24
MK 5353	Girl's Midriff and Pants 25
HP 3662	Man's Pullover 26
MK 5345	Girl's Shell and Shorts 27
MK 5349	Girl's Beach Coat 27
MK 5350	Girl's Top and Shorts 28
KK 5352	Boy's Bathing Trunks 29
MK 5354	Girl's Midriff and Pants 30
MK 5351	Girl's Bathing Suit 31
KG 1942	Dog Coat 32



FRONTPIECE

Be on your way to easy Summer living and keep your cool . . . in a KNITKING designed wardrobe. Relax in our Cover Model DK 8023. The Stockinette Stitch Slacks are belted with knitted Cords (knit the cords longer and you could make them into a Macrame Belt). The Bodice and top of Sleeves of the hug-tight Midriff are in a Rib Stitch with Cuffs pulled snug using 3 x 3 Rib. Instructions are for Sizes 10, 12 and 14. See page 16

BACK COVER — MK 5351

A future Miss America models a one-piece Bathing Suit knitted in 2 colors using KNITKING Dralon yarn, the perfect synthetic. Trim the Suit with a small applique of her choice. It can be made in three sizes. See page 31

1970.
 MK 5273 — Size 7 to 8. See page 29.
 KK 5272 — Size 6. See page 30.

Publisher: KNITKING CORPORATION, 1128 Crenshaw Blvd., Los Angeles, Calif. 90019. Telephone: WEbster 8-2079. Published bi-monthly. Subscriptions: USA — \$6.00 annually, single copies \$1.50; Canada — \$7.00; other parts of the world — \$10.00. The entire contents of KNITKING MAGAZINE are copyright and must not be reproduced in any shape or form without the express permission, in writing of the publisher. COPYRIGHT © by KNITKING CORPORATION 1972.

Printed by George Rice & Sons, Los Angeles, California



KNITKING
 1128 Crenshaw Blvd.
 Los Angeles, Calif. 90019

ORDER IT NOW!

Every reader of KNITKING MAGAZINE needs the new big beautiful KNITKING YARN CATALOGUE with 329 actual yarn samples . . . the finest from around the world in an unbelievable range of colors.

I enclose one dollar
 Please RUSH my beautiful new
 KNITKING YARN CATALOGUE to me at:

 Name

 Address

_____ State _____ Zip



BOOKS by KNITKING



NEW VOLUME AVAILABLE NOW

A complete seventh volume of **KNITKING MAGAZINES** with a flexible, transparent plastic cover and specially bound so that it will stay open at any page, is available at the special price of **\$6.95** (plus 95 cents mailing costs).

If purchased separately the magazines would cost a total of **\$9.00**.

The volume contains over 120 fully illustrated complete stylish patterns for all members of the family together with many valuable, practical knitting hints.

There is a very limited number of these volumes available and it will undoubtedly become a collectors item.

If you already have the entire set it will almost certainly be well thumbed and marked. Why not purchase a perfect mint condition volume for your bookshelf and ready reference at any time.

Place your order today and avoid disappointment. Send it to **KNITKING MAGAZINE, 1128 Crenshaw Boulevard, Los Angeles, California 90019.**

PRACTICAL KNITTING HINTS

We call this book the **TEXT BOOK** for machine knitters because it answers the many questions that occur in machine knitting, from preparing to knit, taking measurements, shaping, making buttonholes, special effects, bindings, bands and edges, etc., through finishing and blocking. It sells for **\$2.95**

40 cents mailing
Calif. residents add 5% Sales Tax

I enclose \$7.90

Please RUSH my bound Seventh Volume of
KNITKING MAGAZINE to me at:

Name _____

Address _____

City _____

State _____

Zip _____

knitking

magazine

WE ARE GOING TO COLOR .!! Starting with the September-October Edition of KNITKING MAGAZINE, (it also marks the beginning of our ninth year of publication) we will include eight pages of full color inside each issue . . . The front and back Covers will also be in color for a total of Ten Color Pages.

Garments look much more interesting and exciting when photographed and illustrated in color . . . You get a much better idea of how finished garments should look and you are better able to judge how they will look on you . . . We are very excited over this further advance in the production of KNITKING MAGAZINE and we have a truly outstanding collection of garments ready for the September-October issue.

KNITKING MAGAZINE is already acknowledged as the finest English language knitting machine magazine in the world and we know that our readers will be thrilled with this demonstration of our intention to keep it that way . . . We carry no advertising in publications outside of the U.S. and Canada, yet we are gradually building up a subscriber list in most English speaking countries and magazines regularly go out to England, Australia and South Africa . . . We receive letters from many of our foreign subscribers in praise of the quality of KNITKING Patterns and the simplicity of the Instructions . . . The only complaints are about the lengthy time it takes for magazines to get to them.

When we introduced KNITKING MAGAZINE nearly eight years ago, we established a subscriber price of \$6.00 a year in the U.S., \$7.00 in Canada and \$10.00 for all other countries . . . We have maintained that price despite ever increasing production and mailing costs . . . and we have always operated at a loss despite circulation increases . . . We are now sorry to say that there has to be a small increase in one year subscriptions starting in September of this year . . . The subscription rate of \$6.00 per year, will however, be maintained if you subscribe for two years at a time . . . This means that our subscriber rates starting September 1st, 1972 will be: U.S.A. \$7.00 a year or \$12.00 for two years. Canada - \$8.00 a year or \$14.00 for two years. Foreign subscriptions will continue to be \$10.00 a year.

Nowhere else in America can you obtain top quality stylish, easy to understand machine knit patterns for a low price of 20 for \$1.00, so please keep sending in those subscriptions and be ready for an announcement early next year about what will be the greatest advance in Machine Knit Pattern Services since the introduction of the Home Knitting Machine.



LETTER
from the
PUBLISHER



MK 5355

Three-in-one Playtogs for your teen age girl. She'll be thrilled to have an outfit she can wear at the beach or in town. Shorts and a Midriff Top make a quick change with a Sleeveless cover-up Dress. The top of the Dress is knitted in a Rib Stitch . . . Stockinette for the Skirt section, Midriff and Pants. Use KNITKING Subita 2 x 3 for a Size 10; Amore for Sizes 12 and 14. See page 18



DK 8044

KNITKING Amore is the perfect yarn for a 3-piece Beach Ensemble. Line the Bra and Bikini Pants if you want to wear them in the water. Stockinette Stitch is used for the Bra and Pants, a Holding Position Design for the Skirt. Sizes 10, 12, 14 . . . all knitted with Amore. See page 17

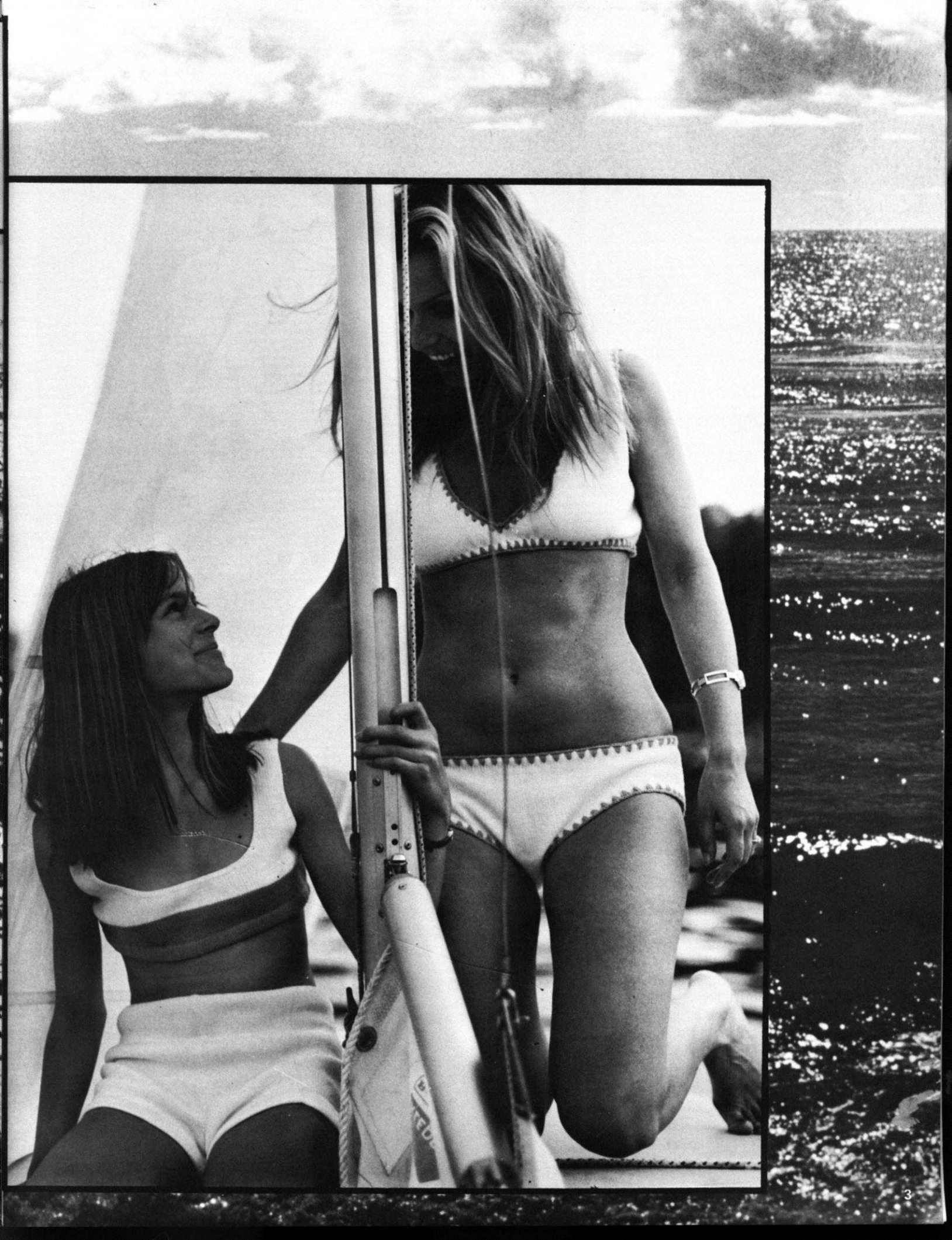

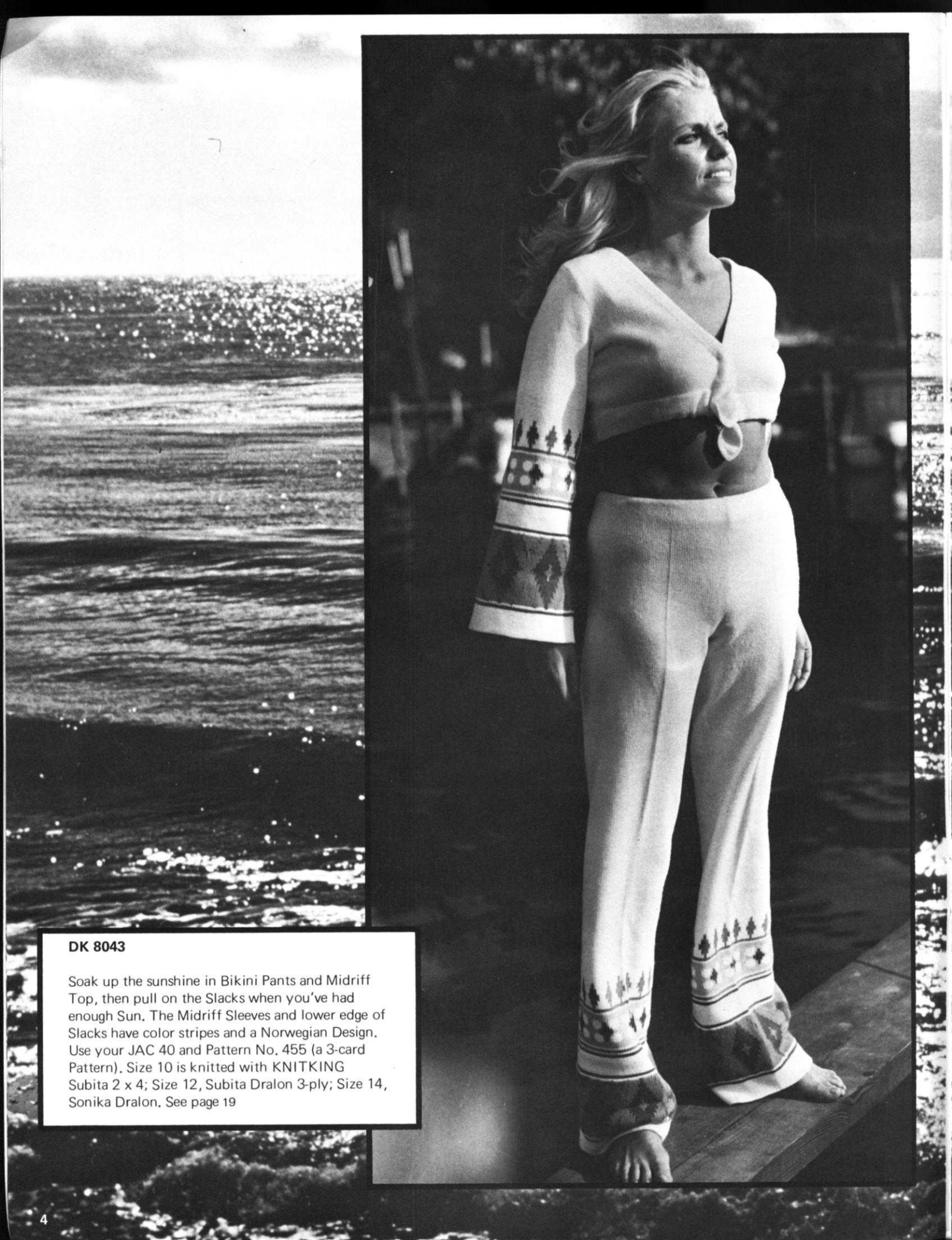

DK 8043

Soak up the sunshine in Bikini Pants and Midriff Top, then pull on the Slacks when you've had enough Sun. The Midriff Sleeves and lower edge of Slacks have color stripes and a Norwegian Design. Use your JAC 40 and Pattern No. 455 (a 3-card Pattern). Size 10 is knitted with KNITKING Subita 2 x 4; Size 12, Subita Dralon 3-ply; Size 14, Sonika Dralon. See page 19



HP 3665

A striped Pullover meets with his approval any-
time . . . and you knit this one using 5 colors. Size
36 is made with KNITKING Fortissima; Sizes 38
and 42 with Amore. See page 22

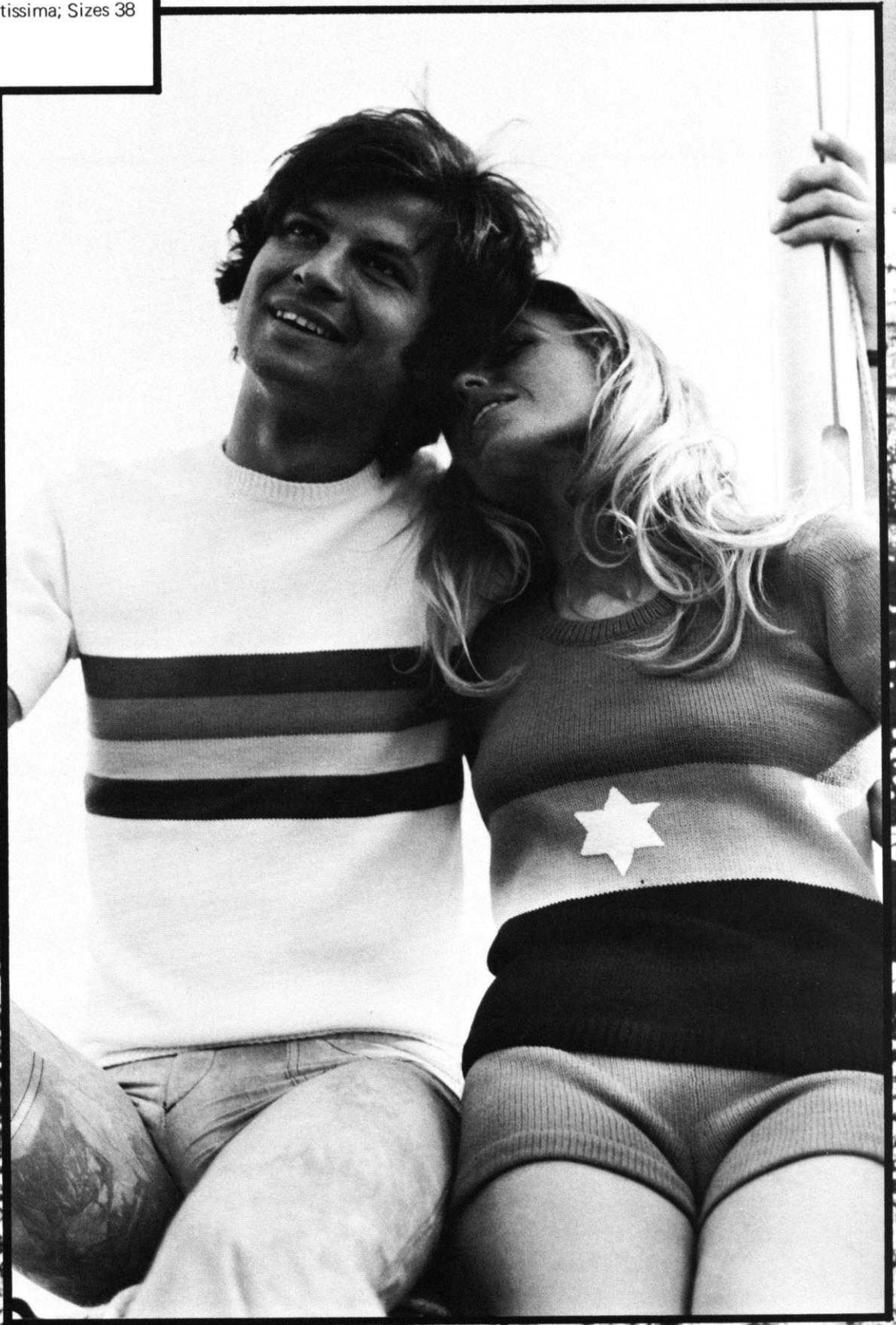



DK 8041

The best in Summer Fun Togs . . . Shorts, Midriff and a short sleeved Pullover are all knitted in Stockinette Stitch. The Midriff and Pullover are striped in 3 colors. Size 10, KNITKING Sonika Dralon; Size 12, Double Knitting. See page 21



MK 5350

A Bathing Suit to delight any young lady. The Top is knitted in Stockinette Stitch and striped. The Shorts are striped too, but in a fun to knit Holding Position Design. Use KNITKING Subita Dralon 3-ply for a Size 6; Sonika Dralon for Sizes 8 and 10. See page 28



MK 5349

She is cute and sassy . . . and warm and dry when the Sun stays behind a Cloud. Knit her a cozy Beach Coat in Stockinette Stitch with Ribbed Bands and a colorful Belt. Use KNITKING Subita Dralon 3-ply for Size 6, Sonika Dralon for Sizes 8 and 10. See page 27.

MK 5345

The fabulous KNITKING Dralons . . . that wash and dry in just a few minutes. Knit your Girl a Summer Shell with matching Shorts. Colorful stripes are in easy Stockinette Stitch. For a Size 6, use Subita Dralon 3-ply, Sizes 8 and 10, Sonika Dralon. See page 27



HP 3662

It looks absolutely great . . . and it stays that way when a Man's Shirt is knitted with KNITKING Amore. Knit it in Stockinette Stitch combined with a latched up Rib stitch and an Eyelet Design. All Bands are 1 x 1 Ribbing. Sizes 38 and 42. See page 26

DK 8034

Mother needs travel clothes too . . . and she feels quite dressed up in a lovely short sleeved Jacket and Slacks. Both are knitted in Stockinette Stitch with an Eyelet Design and latched up Rib stitch for the Jacket at Yoke, Sleeves, Pocket and lower edge. Size 12, KNITKING Subita Crepe 2 x 3; Size 14, Subita Crepe 2 x 4; Size 18, Amore. See page 22



KK 5339

Travel light and wash easy . . . Toss a Boy's Pants and striped Pullover into the washer and dryer and he can be fresh and clean in minutes. The Yarn . . . KNITKING Subita Dralon 3-ply for a Size 8; Sonika Dralon for Sizes 10 and 12. See page 24

KK 5352

Order enough yarn to knit your small Boy several pair of Swim Trunks. You can knit them in a jiffy and he'll live in them all summer long. Easy to knit Stockinette Stitch with KNITKING Subita Dralon 3-ply for a Size 3; Sonika Dralon for Sizes 4 and 6. See page 29

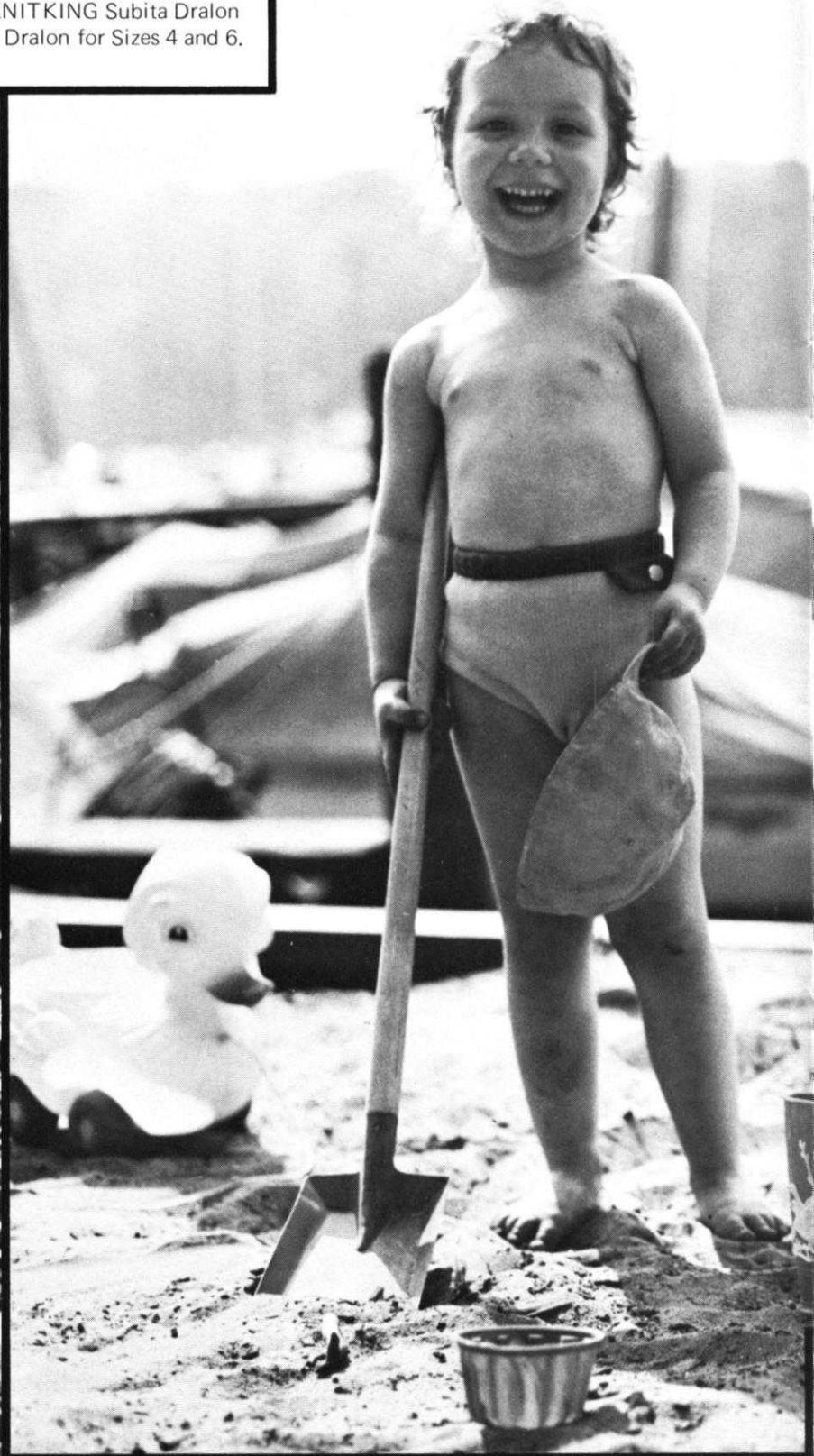

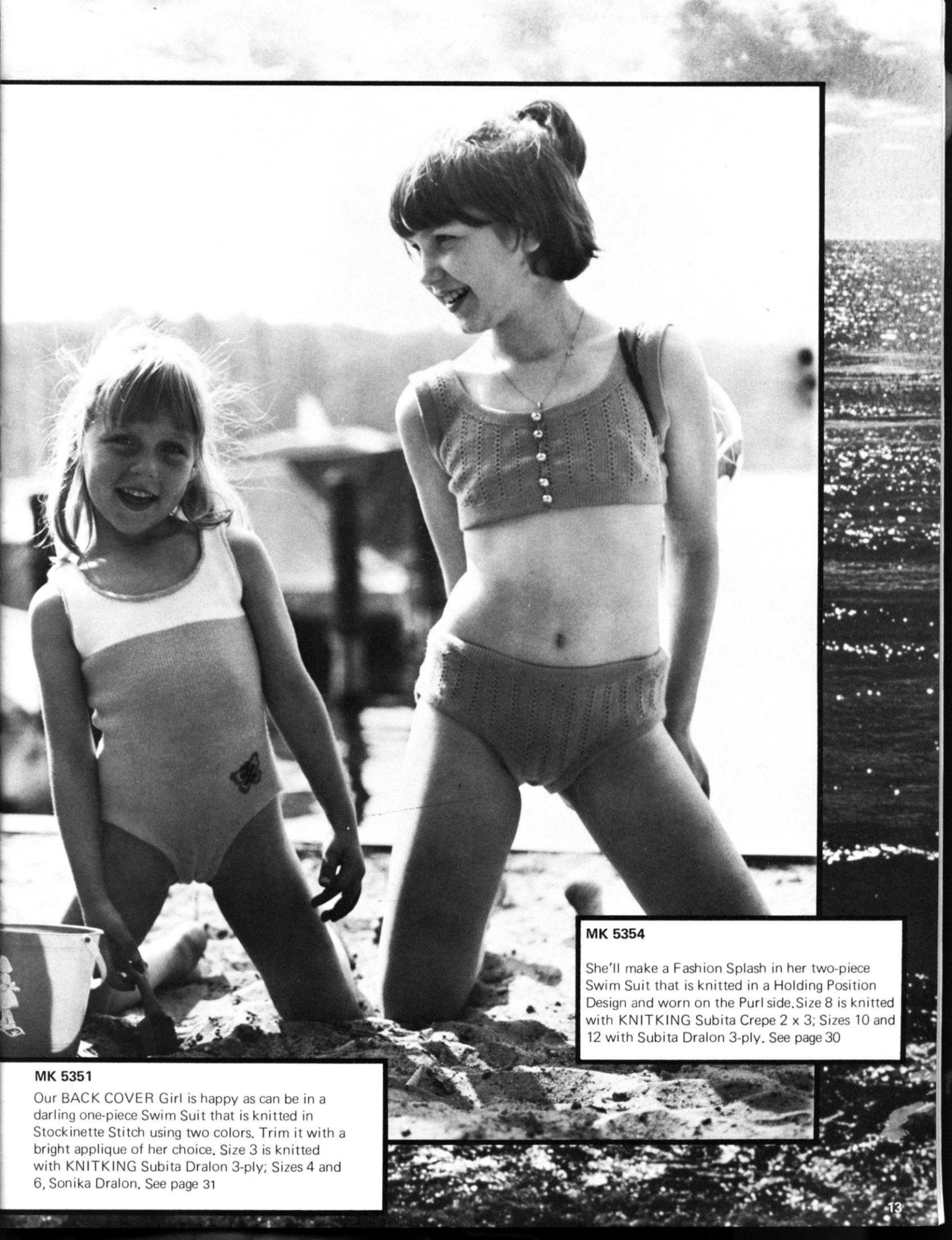

MK 5351

Our BACK COVER Girl is happy as can be in a darling one-piece Swim Suit that is knitted in Stockinette Stitch using two colors. Trim it with a bright applique of her choice. Size 3 is knitted with KNITKING Subita Dralon 3-ply; Sizes 4 and 6, Sonika Dralon. See page 31

MK 5354

She'll make a Fashion Splash in her two-piece Swim Suit that is knitted in a Holding Position Design and worn on the Purl side. Size 8 is knitted with KNITKING Subita Crepe 2 x 3; Sizes 10 and 12 with Subita Dralon 3-ply. See page 30



MK 5353

The very latest in bright Beach wear for the Girls. Shorts and Top are striped in 3 colors and knitted in easy Stockinette Stitch. For a Size 12, use KNITKING Subita Crepe 2 x 3; Size 14, Subita Dralon 3-ply. See page 25

KG 1944

Tiger shows off his very favorite Coat and wants to share the Pattern. Three sizes are given . . . the size being the measurement from the base of your Doggie's Neck to the base of Tail. Make the Coat in plain Stockinette Stitch first, then you will be experienced enough to knit all those Short Rows while knitting the Houndstooth Design using your JAC 40 and Pattern No. 10. For 15" size, use KNITKING Subita Crepe 2 x 3; 18", Subita Crepe 2 x 4; 20", Double Knitting. See page 32



ARE YOU UNHAPPY WITH YOUR PRESENT KNITTING MACHINE ?

DOES IT REFUSE TO KNIT FANCY DRESS YARNS?

DOES IT JAM UP WHEN YOU TRY TO KNIT LOOPED MOHAIR OR THICK AND THIN YARNS?

DOES IT DROP STITCHES ALL OVER THE PLACE?

ARE YOU CONTINUALLY HAVING TROUBLE WITH AWKWARD, CUMBERSOME WEIGHTS?

ARE YOU UNABLE TO MAKE A LARGE GARMENT WITH BULKY YARNS?

DO YOU HAVE TO SELECT PATTERN STITCHES MANUALLY?

DO YOU HAVE TO LATCH YOUR RIBBING BY HAND?

IF YOU ARE HAVING ANY OF THESE PROBLEMS YOU SHOULD TRADE UP TO A NEW FANTASTIC PUSH BUTTON KNITKING WITH COORDINATED RIBBER AND ENJOY KNITTING WITH THE WORLDS FINEST, MOST VERSATILE AND MOST AUTOMATIC KNITTER.

YOU WILL BE SURPRISED AT OUR GENEROUS TRADE-IN ALLOWANCE AND YOU CAN, IF YOU WISH, USE YOUR PRESENT MACHINE AS A DOWN-PAYMENT AND PURCHASE A COMPLETE KNITKING FOR JUST PENNIES A DAY. WRITE TODAY FOR FULL INFORMATION AND TELL US WHAT MACHINE YOU NOW OWN. THE ADDRESS IS:

KNITKING, Dept. T-1, 1128 Crenshaw Blvd., Los Angeles, Calif. - 90019

DK 8044

SIZE: 10 (Bust 32 1/2"-33")
YARN: Amore
50 gr BALLS: 7 Color 1
 1 Color 2
TENSION: Stock 5 to 7
 Pattern 6 to 8
GAUGE: 2" Stk. 16 sts, 25 rows
 Pattern 15 sts, 29 rows

12 (Bust 34"-35")
 Amore
 7 Color 1
 1 Color 2
 6 to 8
 7 to 9
 15 sts, 24 rows
 14 sts, 28 rows

14 (Bust 36"-37")
 Amore
 8 Color 1
 1 Color 2
 7 to 9
 8 to 10
 14 sts, 26 rows
 13 sts, 22 rows

The instructions are the same for all sizes. **PATTERN: BRA and BIKINIS:** Stockinette Stitch worn on the knit side; **SKIRT:** Holding Position Design according to Line Drawing, using Wheel 6. The purl side is the right side. **UPPER EDGE OF SKIRT:** K1, P1, Ribbing. **DECREASES:** Hang the 1st st. onto the 2nd st.

FINISHING: Block all sections. **SKIRT:** Weave the sections together, 1 st. in from each edge. Turn under 15 rows on upper edge and 4 rows on lower edge and hem to wrong side. Insert an elastic band into upper hem. With contrast yarn, crochet around lower edge as follows: Always inserting the crochet hook into the 4th row of skirt edge, make 4 single crochets into 1st st., skip 3, 4 single crochets into next st., skip 3, etc. **BIKINIS:** Weave the side seams together. Turn under 4 rows on upper edge and hem to wrong side. Insert an elastic band. Turn under about 1/2" on leg edges and hem to wrong side. Crochet around all edges as you did on the skirt. **BRA:** Join sections at center front and shoulders. Turn under 4 rows on lower edge and hem to wrong side. Insert an elastic band and fasten at edges. Turn under about 1/2" on front edges, neckline and armhole edges and hem to wrong side. Crochet around all edges as you did on the skirt. Work 3 loops on 1 edge of the back opening and sew 3 buttons to opposite edge.

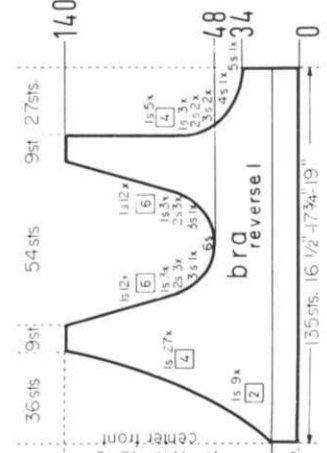
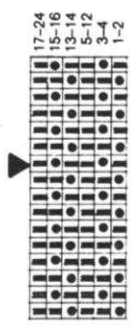

Work the second bra section with reverse shapings, casting on from right to left. (Cam Box will be on the LEFT side at Row 0).

Decrease 1 st. for **FRONT SHAPING** after Row 49, then again after Rows in (). ON **CAM BOX SIDE**, bind off 3 sts. after Row 50 (**EVEN ROWS-ARMHOLE SHAPING**); 2 sts. after Rows 52, 53, 54, 56; (57), 1 st. after Rows 58, 60, (61), 62, 64, (65), (69), 70, (73), 76, (77), (81), 82, (85), 88, (89), (93), 94, (97), 100, (101), (105), 106, (109), 112, (113), (117), 118, (121), 124, (125), (129), 130, (133), (137), then knit to Row 140 and bind off the 9 shoulder sts.

Bring the 56 needles into working position, turn the Row Counter back to 48 and complete the front part of the bra.

ON **CAM BOX SIDE**, bind off 1 st. after Row 48; 6 sts. after Row 49 (**ODD ROWS-ARMHOLE SHAPING**); 1 st. after Row 50; 3 sts. after Row 51; 1 st. after Row 52; 2 sts. after Rows 53, 55; 1 st. after Row 56; 2 sts. after Row 57; 1 st. after Row 59, 60, 61, 63, 64, 65, 68, (last time for back shaping) 71, 77, 83, 89, 95, 101, 107, 113, 119, 125, 131. After Row 140 bind off the 9 shoulder sts.

ON **CAM BOX SIDE**, decrease 1 st. for **FRONT SHAPING** after Rows 15, 17, 19, 21, 23, 25, 27, 29, 31, 33, then again after Rows in (). ON **CAM BOX SIDE**, bind off 5 sts. after Row 34 (**EVEN ROWS-BACK SHAPING**); 4 sts. after Row 36; (37), 3 sts. after Row 38, 40; (41), 2 sts. after Rows 42, 44; (45), 1 st. after Row 46, then knit to Row 48, put 56 needles on the left side (right side for second section) into holding position and complete the back part of the bra first.

ROWS 0 to 15: Knit even.
 Cast on 135 sts. and work stockinette st.

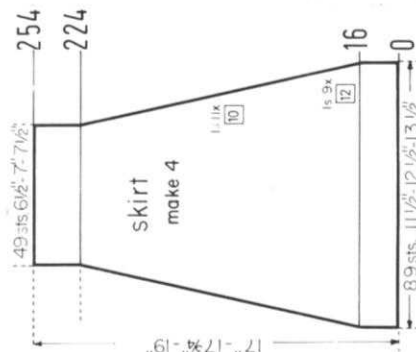
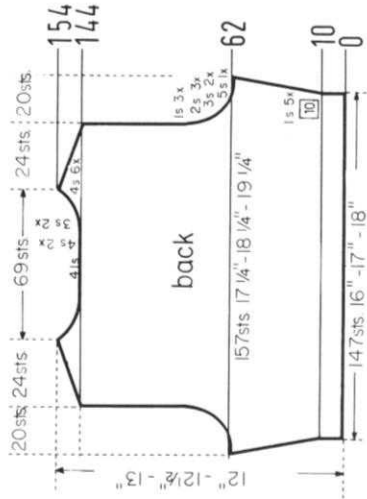

ON **EACH SIDE**, decrease 1 st. after Rows 16, 28, 40, 52, 64, 76, 88, 100, 112, 124, 134, 144, 154, 164, 174, 184, 194, 204, 214, 224, but do not knit after last decreases. Transfer every other st. to the ribber and work K1, P1. Ribbing to Row 254, then bind off the remaining 49 sts. the crochet method for ribbing. Work 3 more sections the same. **ROWS 0 to 16:** Knit even.
 Cast on 89 sts. and work the Holding Position Design.

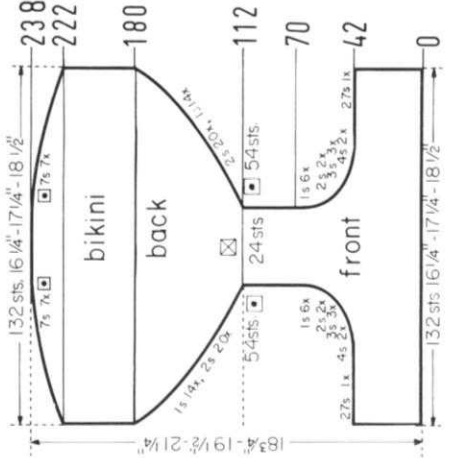

Using 2 separate strands of yarn, cast on 54 sts. ON **EACH SIDE** of the center 24 sts., then put the needles with the newly cast-on sts. in holding position and work Short Rows.

ON **OPPOSITE SIDE** of CAM BOX put into holding position 27 needles after Rows 42, 43; 4 needles after Rows 44, 45, 46, 47; 3 needles after Rows 48, 49, 50, 51, 52, 53; 2 needles after Rows 54, 55, 56, 57; 1 needle after Rows 58, 59, 60, 61, 62, 63, 64, 65, 67, 68, 69. After Row 70 bind off 54 sts. ON **EACH SIDE** (all sts. on the needles in holding position). Knit over the remaining 24 sts. to Row 112.

ROWS 0 to 42: Knit even, then work Short Rows.

Cast on 132 sts. and work stockinette st.

Bring the needles on the left side into working position, knit 1 row in **PATTERN** to the left side, turn the Row Counter back to 144 and complete the left half. Follow the instructions from*.

*ON **CAM BOX SIDE**, bind off 4 sts. after Rows 144 (**EVEN ROWS=SHOULDER SHAPING**), 145 (**ODD ROWS=NECK SHAPING**), 146, 147, 148; 3 sts. after Row 149; 4 sts. after Row 150; 3 sts. after Row 151; 4 sts. after Rows 152, 154.

ON **CAM BOX SIDE**, bind off 5 sts. after Rows 62, 63; 3 sts. after Rows 64, 65, 66, 67; 2 sts. after Rows 68, 69, 70, 71, 72, 73; 1 st. after Rows 74, 75, 76, 77, 78, 79, then knit to Row 144, bind off the center 41 sts., put the needles on the left side into holding position and complete the right half first. (Transfer the ribber sts. to the main machine before putting the needles into holding position).

ON **EACH SIDE**, increase 1 st. after Rows 10, 20, 30, 40, 50, then knit to Row 62.

ROWS 0 to 10: Knit even.
 Cast on 147 sts. and work the **TRIBBED PATTERN**.

ON **OPPOSITE SIDE** of CAM BOX put into holding position 7 needles after Rows 22, 23, 24, 25, 26, 27, 28, 29, 30, 31, 32, 33, 34, 35. ON **OPPOSITE SIDE** of CAM BOX bring all needles back into working position after Rows 236, 237. After Rows 238 bind off all 132 sts.

ON **OPPOSITE SIDE** of CAM BOX, bring back into working position 2 needles after Rows 112, 113, 114, 115, 116, 117, 118, 119, 120, 121, 122, 123, 124, 125, 126, 127, 128, 129, 130, 131, 132, 133, 134, 135, 136, 137, 138, 139, 140, 141, 142, 143, 144, 145, 146, 147, 148, 149, 150, 151; 1 needle after Rows 152, 153, 154, 155, 156, 157, 158, 159, 160, 161, 162, 163, 164, 165, 166, 167, 168, 169, 170, 171, 172, 173, 174, 175, 176, 177, 178, 179. After Row 180 knit over all 132 needles to Row 222, then work Short Rows.

Using 2 separate strands of yarn, cast on 54 sts. ON **EACH SIDE** of the center 24 sts., then put the needles with the newly cast-on sts. in holding position and work Short Rows.

ON **OPPOSITE SIDE** of CAM BOX put into holding position 27 needles after Rows 42, 43; 4 needles after Rows 44, 45, 46, 47; 3 needles after Rows 48, 49, 50, 51, 52, 53; 2 needles after Rows 54, 55, 56, 57; 1 needle after Rows 58, 59, 60, 61, 62, 63, 64, 65, 67, 68, 69. After Row 70 bind off 54 sts. ON **EACH SIDE** (all sts. on the needles in holding position). Knit over the remaining 24 sts. to Row 112.

ROWS 0 to 42: Knit even, then work Short Rows.

Cast on 132 sts. and work stockinette st.

MK 5355

SIZE: 12 (Chest 28½") 14 (Chest 32")
YARN: Subita Crepe 2 x 3 Amore
50 gr BALLS: Dress 7 Color 1 8 Color 1 9 Color 1
 1 Color 2 1 Color 2 1 Color 2
Top & Shorts: 1 Color 1 4 Color 2 5 Color 2
 4 to 6 6 to 8 7 to 9
TENSION: 2" Stk. Pattern 17 sts, 24 rows 15 sts, 22 rows
GAUGE: 17 sts, 26 rows 16 sts, 25 rows

The instructions are the same for all sizes. **PATTERN:** Shorts, Top, Dress Skirt and Bindings: Stockinette Stitch worn on the knit side; Dress Bodice: Knit 1, Purl 3 Ribbing according to Line Drawing, worn on the Purl side. **DECREASES:** Hang the 3rd st. onto the 2nd st. then move the end sts. inward to fill the empty needle. Begin the Dart by hanging the sts. together as marked in the Diagram, then move the sts. inward to fill the empty needles. The following decreases for the Dart lie directly above. **INCREASES:** Move the 2 end sts. 1 needle outward, then place the 3rd st. from the row below onto the empty needle. To turn the knitting at row 174 (Dress), knit several rows with contrast waste yarn, then remove the knitting from the machine. Turn the knitting over and hang the garment sts. held on contrast yarn back onto the machine. The knit side is now facing you. Remove the waste yarn, transfer the appropriate sts. to the ribber, turn the Row Counter back to 174 and with the Cam Box on the proper side, continue with the Pattern Stitch. To form the hems, hang the cast-on sts. back onto the machine behind the latches, then knit the following row with 1 tension setting higher.

FINISHING: Block all sections. **DRESS:** Join back and front sections at sides and shoulders. Turn under 18 rows on lower edge and hem to wrong side. Sew 1 edge of the binding to the inside and 1 edge to the outside of the front edges and neckline. Join short ends of the armhole binding, then sew the binding to armhole edges. Finish buttonholes, sew on buttons. **SHORTS:** Sew the leg seams together. Turn under 14 rows on leg edges and hem to wrong side. Join sections at center front and center back. Turn under 16 rows on upper edge and hem to wrong side. Insert an elastic band. **TOP:** Join back and front sections at sides and shoulders. Insert an elastic band into lower hem and sew in place. Turn under about ¾" at back edges and hem to wrong side. Work 2 rows of single crochet around neckline and armhole edges. Work 3 loops on 1 side of back opening and sew 3 buttons to other side.

Move the Cam Box to the left side, turn the Row Counter back to 380 and complete the left half. Follow the instructions from *. (Be sure to transfer the proper sts. back to the ribber).

*ON CAM BOX SIDE, bind off 4 sts. after Rows 381, 383; 3 sts. after Rows 385, 387; 2 sts. after Rows 389, 391, 393, then knit to Row 400 and bind off the 13 shoulder sts.

ON CAM BOX SIDE, bind off 5 sts. after Rows 310, 311; 3 sts. after Rows 312, 313, 314, 315; 2 sts. after Rows 316, 317, 318, 319, 320, 321; 1 st. after Rows 322, 323, 324, 325, 326, 327, then knit to Row 380, bind off the center 25 sts, put the needles on the left side into holding position and complete the right half first. (Transfer the ribber sts. to the main machine before putting the needles into hold).

ON EACH SIDE, increase 1 st. after Rows 224, 242, 260, 278, 296, then knit to Row 310.

Continue to decrease 1 st. ON EACH SIDE after Rows 174, 180, 186, 192, 198, 204, then knit to Row 224.

ON EACH SIDE, decrease 1 st. after Rows 54, 62, 70, 78, 86, 94, 102, 110, 118, 126, 132, 138, 144, 150, 156, 162, 168, then knit to Row 174, turn the knitting over and with the Cam Box on the RIGHT side begin the Ribbed Pattern.

ROWS 0 to 54: Knit even.

Cast on 167 sts. with color 1 and work stockinette st.

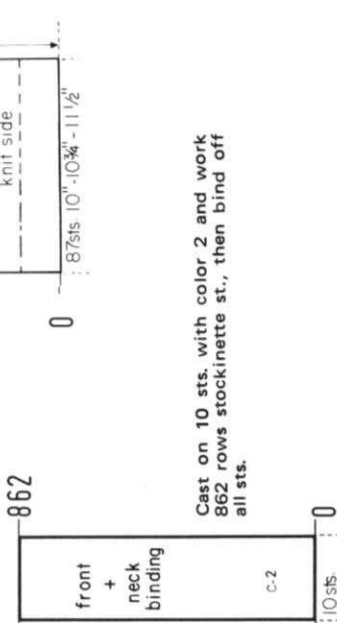
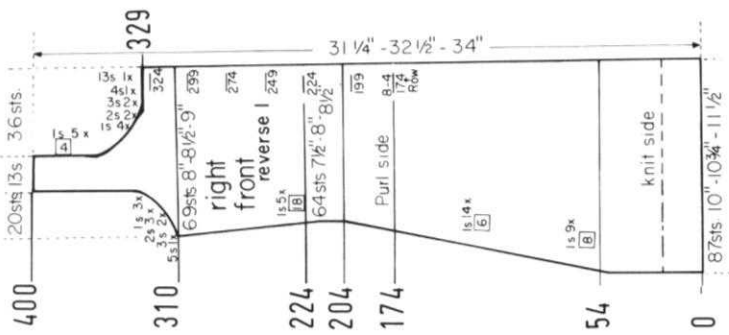
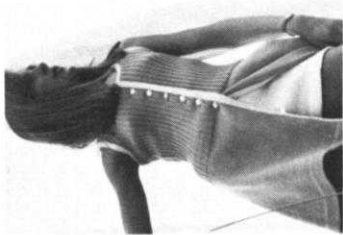

Cast on 10 sts. with color 2 and work 862 rows stockinette st., then bind off all sts.

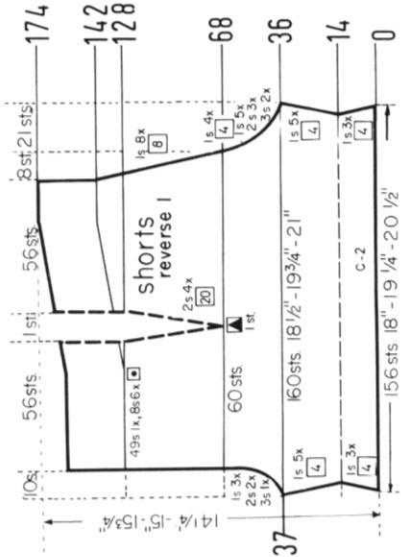

Work the left front section with reverse shapings, casting on from right to left. (Cam Box will be on the LEFT side at Row 0 and the RIGHT side after turning the knitting over after Row 174). Omit the buttonholes.

ON CAM BOX SIDE, bind off 13 sts. after Row 329; 4 sts. after Row 331; 3 sts. after Rows 333, 335; 2 sts. after Rows 337, 339; 1 st. after Rows 341, 343, 345, 347, 349, 353, 357, 361, 365. Knit to Row 400, then bind off the 13 shoulder sts.

ON CAM BOX SIDE, bind off 5 sts. after Row 310, 3 sts. after Rows 312, 314; 2 sts. after Rows 316, 318, 320; 1 st. after Rows 322, 324, (324), 326, then knit to Row 329.

ON CAM BOX SIDE, increase 1 st. after Rows 224, (224), 242, (249), 260, (274), 278, 296, (299), then knit to Row 310. Make 1 more buttonhole after Row in ().

Make buttonholes after Rows in () over the 4th-8th sts. counting from the right side. Continue to decrease 1 st. ON CAM BOX SIDE after Rows 174, (174), 180, 186, 192, 198, (199), 204, then knit to Row 224. Continue to make buttonholes after Rows in ().

ON CAM BOX SIDE, decrease 1 st. after Rows 54, 62, 70, 78, 86, 94, 102, 110, 118, 126, 132, 138, 144, 150, 156, 162, 168, then knit to Row 174, turn the knitting over and with the Cam Box on the LEFT side begin the Ribbed Pattern.

ROWS 0 to 54: Knit even.

Cast on 87 sts. with color 1 and work stockinette st. (Cam Box must be on the RIGHT side at Row 0).

Work the second section with reverse shapings, casting on from right to left. (Cam Box will be on the LEFT side at Row 0).

Decrease 2 sts. for the DART after Rows in (). Continue to decrease 1 st. ON CAM BOX SIDE after Rows 68, (68), 72, 80, 88, (88), 96, 104, (108), 112, 120, 128, (128), but do not knit after the last decreases. Work Short Rows. ON OPPOSITE SIDE OF CAM BOX, put into holding position 49 needles after Row 128; 8 needles after Rows 130, 132, 134, 136, 138, 140. After Row 142 bring all needles back into working position, then knit to Row 174 and bind off the remaining 113 sts.

ON CAM BOX SIDE, bind off 3 sts. after Rows 36 (EVEN ROWS = CENTER BACK SHAPING), 37 (ODD ROWS = CENTER FRONT SHAPING), 38; 2 sts. after Rows 39, 40, 41, 42; 1 st. after Row 43; 2 sts. after Row 44; 1 st. after Rows 45, 46, 47, 48, 50, 52, 54, 56, 60, 64, then knit to Row 68.

ON EACH SIDE, decrease 1 st. after Rows 4, 8, 12, then increase 1 st. ON EACH SIDE after Rows 16, 20, 24, 28, 32, then knit to Row 36.

Cast on 156 sts. with color 2 and work stockinette st.

DK 8041

SIZE: 10 (Bust 31½"-32½") 12 (Bust 34"-35")
YARN: Double Knitting
 12 Color 1
 3 Color 2
 3 Color 3
50 gr BALLS: 7 Color 1
 2 Color 2
 3 Color 3
 8 to 10
TENSION: 2"
GAUGE: 14 sts, 20 rows

The instructions are the same for both sizes. **PATTERN:** Stockinette Stitch with Color Stripes in Pullover and Midriff Top. **EDGES:** K1, P1, Ribbing. The Star is an applique and is sewn on. **INCREASES:** Move the 2 and sts. 1 needle outward, then place the 3rd st. from the row below onto the empty needle. **DECREASES:** Hang the 3rd st. onto the 2nd st., then move the end sts. inward to fill the empty needle. Begin the Dart by hanging the sts. together as marked on the Diagram. The following decreases for the dart lie directly above.

FINISHING: Block all sections. **PULLOVER:** Sew applique to front section. Join front and back section at sides and shoulders. Sew sleeves together and set in. Join short ends of neckband, then sew band to neckline. **MIDRIFF TOP:** Sew applique to front section. Join front and back section at sides and shoulders. Join short ends of neckband and short ends of armhole bands, then sew bands in place. **SHORTS:** Sew leg seams together. Turn under 12 rows on leg edges and hem to wrong side. Join sections at center front and center back. Turn under 16 rows on upper edge and hem to wrong side. Insert an elastic band.

Move the Cam Box to the left side, turn the Row Counter back to 206 and complete the left half. Follow the instructions from*.

*ON CAM BOX SIDE, bind off 4 sts. after Row 207 (ODD ROWS = NECK SHAPING); 3 sts. after Rows 209, 211, 213; 4 sts. after Row 214 (EVEN ROWS = SHOULDER SHAPING); 2 sts. after Row 215; 4 sts. after Row 216; 2 sts. after Row 217; 4 sts. after Row 218; 5 sts. after Rows 220, 222.

ON CAM BOX SIDE, bind off 3 sts. after Rows 146, 147, 148, 149; 2 sts. after Rows 150, 151, 152, 153; 1 st. after Rows 154, 155, 156, 157, 158, 159, then knit to Row 206. (For the FRONT Section knit to Row 162) bind off the center 17 sts., put the needles on the left side into holding position and complete the right half first.

ON EACH SIDE, increase 1 st. after Rows 42, 62, (change to color 3 after Row 70) 82, 102, (change to color 1 after Row 106) 122, then knit to Row 146.

ROWS 15 to 42: Knit even.

ROWS 0 to 14: Knit even, then change to stockinette st.

Cast on 111 sts. with color 2 and work K1, P1, Ribbing.

Move the Cam Box to the left side, turn the Row Counter back to 162 and complete the left half. Follow the instructions from*.

*ON CAM BOX SIDE, bind off 3 sts. after Rows 163, 165; 2 sts. after Rows 167, 169, 171; 1 st. after Rows 173, 175, 177, 179, 181, 185, 189, 193. For SHOULDER bind off 4 sts. after Rows 214, 216, 218; 5 sts. after Rows 220, 222.

Work the front section the same as the back section to Row 162, then bind off the center 11 sts., put the needles on the left side into holding position and complete the right half first.

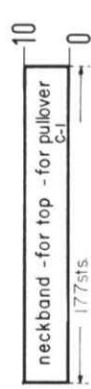
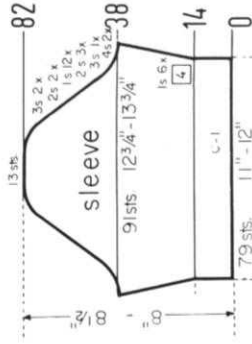
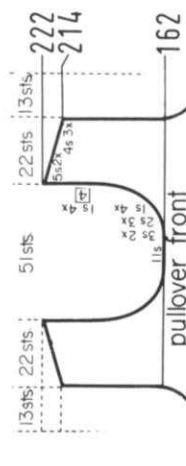
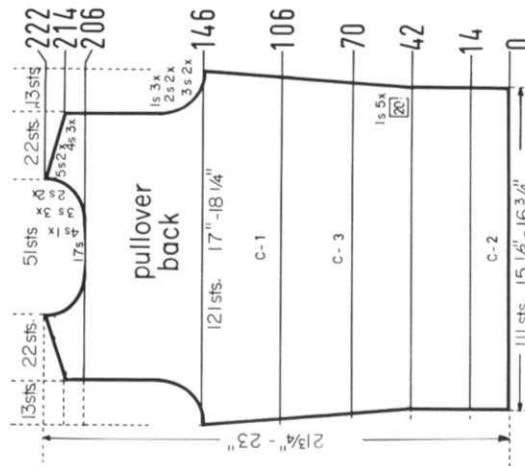

Cast on 177 sts. with color 1 and work 10 rows K1, P1, Ribbing, then bind off all sts.

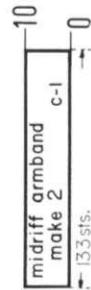
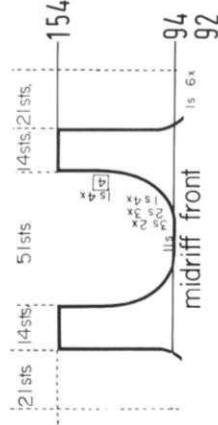

Cast on 133 sts. with color 1 and work 10 rows K1, P1, Ribbing, then bind off all sts.

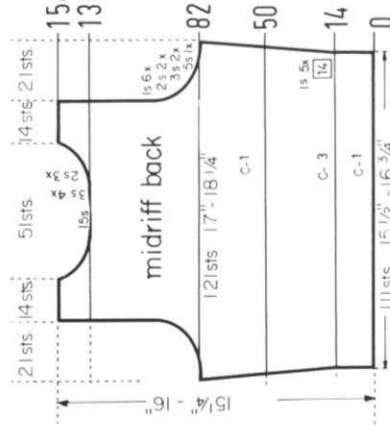

Move the Cam Box to the left side, turn the Row Counter back to 94 and complete the left half. Follow the instructions from*.

*For ARMHOLE, decrease 1 st. ON CAM BOX SIDE, after Row 94, then again after Rows in (. ON CAM BOX SIDE, bind off 3 sts. after Rows 95, (96), 97; (98), 2 sts. after Rows 99, (100), 101, (102), 103; 1 st. after Rows 105, 107, 109, 111, 113, 117, 121, 125, then knit to Row 154 and bind off the 14 shoulder sts.

Work the front section the same as the back section to Row 92. Decrease 1 st. ON EACH SIDE after Row 92, then knit to Row 94, bind off the center 11 sts., put the needles on the left side into holding position and complete the right half first.

Move the Cam Box to the left side, turn the Row Counter back to 138 and complete the left half. Follow the instructions from*.

*ON CAM BOX SIDE, bind off 3 sts. after Rows 139, 141, 143, 145; 2 sts. after Rows 147, 149, 151, then knit to Row 154 and bind off the 14 shoulder sts.

ON CAM BOX SIDE, bind off 5 sts. after Rows 82, 83; 3 sts. after Rows 84, 85, 86, 87; 2 sts. after Rows 88, 89, 90, 91; (For the FRONT Section make the bind-off after Row 91, then knit to Row 92.) 1 st. after Rows 92, 93, 94, 95, 96, 97, 98, 99, 100, 101, 102, 103, then knit to Row 138, bind off the center 15 sts., put the needles on the left side into holding position and complete the right half first.

ON EACH SIDE, increase 1 st. after Rows 14, 28, 42, (change to color 1 after Row 56) 56, 70, then knit to Row 82.

ROWS 0 to 14: Knit even, then change to stockinette st. and color 3.

Cast on 111 sts. with color 1 and work K1, P1, Ribbing.

SIZE: 36 (Chest 35"-36") 38 (Chest 37"-38") 42 (Chest 41"-42")
YARN: Fortissima Amore
 6 Color 1 7 Color 1
 1 Color 2 1 Color 2
 1 Color 3 1 Color 3
 1 Color 4 1 Color 4
 1 Color 5 1 Color 5
TENSION: 4 to 6 5 to 7
GAUGE: 2" 16 sts, 23 rows 15 sts, 23 rows

The instructions are the same for all sizes. **PATTERN:** Stockinette Stitch with Color Stripes as marked in the Diagram. **EDGES:** K1, P1, Ribbing. **Sleeve INCREASES:** ON EACH SIDE, move the 2 end sts. 1 needle outward, then place the 3rd st. from the row below onto the empty needle.
FINISHING: Block all sections. Join front and back section at sides and shoulders. Sew the sleeves together and set in. Join short ends of neckband, then sew band to neckline.



Move the Cam Box to the left side, turn the Row Counter to 274 and complete the left half. Follow the instructions from*.

*ON CAM BOX SIDE, bind off 3 sts. after Rows 275, 277; 2 sts. after Rows 279, 281, 283; 1 st. after Rows 285, 287, 289, 291, 293, 297, 301. For SHOULDER bind off 4 sts. after Rows 304, 306, 308, 310, 312; 5 sts. after Rows 314, 316, 318.

Work the front section the same as the back section to Row 274, then bind off the center 13 sts, put the needles on the left side into holding position and complete the right half first.

Move the Cam Box to the left side, turn the Row Counter back to 304 and complete the left half. Follow the instructions from*.

*ON CAM BOX SIDE, bind off 4 sts. after Row 304 (EVEN ROWS = SHOULDER SHAPING), 305 (ODD ROWS = NECK SHAPING), 306, 307, 308; 3 sts. after Row 309; 4 sts. after Row 310; 3 sts. after Row 311; 4 sts. after Row 312; 2 sts. after Row 313; 5 sts. after Row 314; 2 sts. after Row 315; 5 sts. after Rows 316, 318.

ON CAM BOX SIDE, bind off 3 sts. after Rows 212, 213, 214, 215; 2 sts. after Rows 216, 217, 218, 219, 220, 221; 1 st. after Rows 222, 223, 224, 225, 226, 227, 228, 229 then knit to Row 304. (for the FRONT Section knit to Row 274) bind off the center 15 sts., put the needles on the left side into holding position and complete the right half first.

ROWS 11 to 212: Knit even AND change to color 2 after Row 148, to color 3 after Row 164, to color 4 after Row 180, to color 5 after Row 196, then knit to Row 212 and continue with color 1.

ROWS 0 to 10: Knit even, then change to stockinette st.
 Cast on 153 sts. with color 1 and work K1, P1, Ribbing.

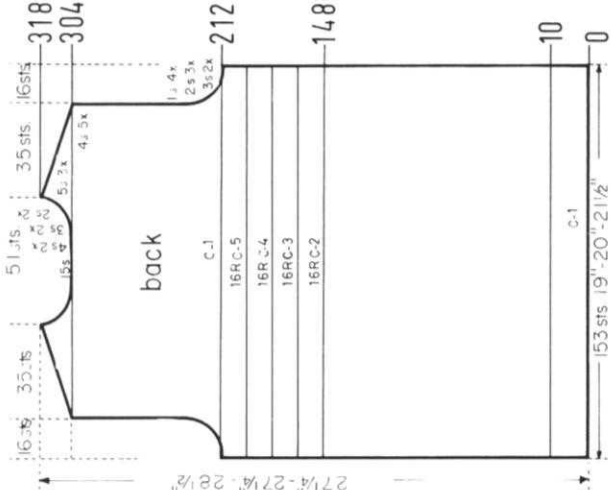
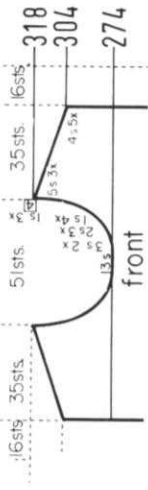

Work the second section with reverse shapings, casting on from right to left. (Cam Box will be on the LEFT side at Row 0).

Decrease 1 st. ON CAM BOX SIDE and 2 sts. for the DART after Rows 68, 76, 84, 92, 100, 108, 116, but do not knit after last decrease. Work Short Rows ON OPPOSITE SIDE of CAM BOX put into holding position 45 needles after Row 116; 8 needles after Rows 118, 120, 122, 124 (AND decrease 1 st. more ON CAM BOX SIDE after Row 124), 126. After Row 128 bring all needles back into working position, then knit to Row 160 and bind off the remaining 97 sts.

ON CAM BOX SIDE bind off 3 sts. after Rows 36 (EVEN ROWS=CENTER BACK SHAPING), 37 (ODD ROWS = CENTER FRONT SHAPING), 38; 2 sts. after Rows 39, 40, 41, 42; 1 st. after Rows 43, 44, 45, 46, 47, 48, 50, 51, 52, 54, 55, 56, 58, 60, 64, then knit to Row 68.

ON EACH SIDE, decrease 1 st. after Rows 4, 8, then increase 1 st. ON EACH SIDE after Rows 16, 20, 24, 28, 32, then knit to Row 36.

Cast on 145 sts. with color 1 and work stockinette st.

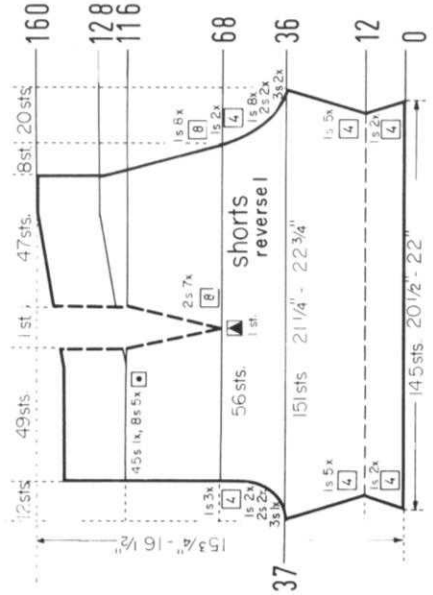

DK 8034

SIZE: 12 (Bust 34") 14 (Bust 36") 18 (Bust 39"-40")
YARN: Subita Crepe 2 x 3 14 (Bust 36") Amore
 50 gr. BALLS: 8 10 11
JACKET: 10 13 14
PANTS: 4 to 6 5 to 7 7 to 9
TENSION: 2" 17 sts, 24 rows 16 sts, 23 rows
GAUGE: 2" 17 sts, 24 rows 16 sts, 23 rows

The instructions are the same for all sizes. **PATTERN:** Stockinette Stitch. The Jacket has an Eyelet Design with puri sts. on the lower section, yoke section, sleeves and pockets. **DECREASES:** Hang the 3rd st. onto the 2nd st., then move the end sts. inward to fill the empty needle. Begin the Pants Darts by hanging the sts. together as marked in the Diagram, then move the end sts. inward to fill the empty needle. The following decreases for the Dart lie directly above. **INCREASES:** Move the 2 end sts. 1 needle outward, then place the 3rd st. from the row below onto the empty needle.

FINISHING: Block all sections. **JACKET:** Join front and back sections at sides and shoulders. Sew the sleeves together and set in. Turn under 22 rows on lower edge and 11 rows on sleeve edges and hem to wrong side. Weave the open sts. of the back facing together, then sew the facing to neckline. Turn under 10 sts. on front edge and neck facing and hem to wrong side. Turn under 12 rows on upper edge of pockets and hem to wrong side. Sew the pockets in place. Finish buttonholes, sew on buttons. **PANTS:** Sew the leg seams together. Join the sections at center back and center front. Turn under 18 rows on leg edges and 18 rows on upper edge and hem to wrong side. Insert an elastic band into upper hem.

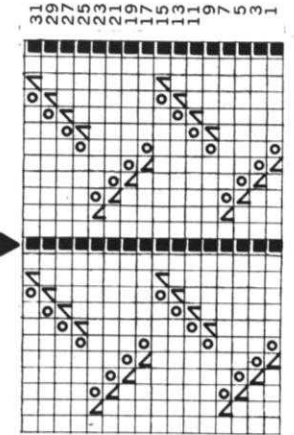

LINE DRAWING

The dark squares in the Line Drawing represent sts. to be dropped about every 20-30 rows, (while knitting the Eyelet Design) then to be latched up into knit back cover.

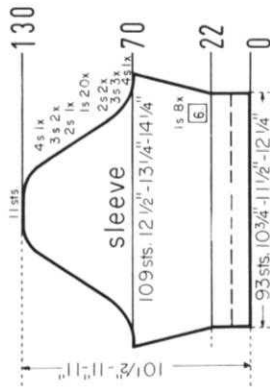

ON CAM BOX SIDE, bind off 4 sts. after Rows 70, 71; 3 sts. after Rows 72, 73, 74, 75, 76, 77; 2 sts. after Rows 78, 79, 80, 81. ON EACH SIDE, hang the 1st st. onto the 2nd st. after Rows 82, 84, 86, 88, 90, 92, 94, 96, 98, 100, 102, 104, 106, 108, 110, 112, 114, 116, 118, 120. ON CAM BOX SIDE, bind off 2 sts. after Rows 122, 123; 3 sts. after Rows 124, 125, 126, 127; 4 sts. after Rows 128, 129; 11 sts. after Row 130.

ON EACH SIDE, increase 1 st. after Rows 22, 28, 34, 40, 46, 52, 58, 64, then knit to Row 70.

ROWS 0 to 22: Knit even.
Cast on 93 sts. and work the Eyelet Design.

Work the second front section with reverse shapings, casting on from right to left. (Cam Box will be on the LEFT side at Row 0). Omit the buttonholes.

For SHOULDER, bind off 3 sts. after Row 342; 4 sts. after Rows 344, (344), 346, 348, 350, (350), 352, 354, 356, 358, 360, then knit over the remaining 20 sts. to Row 392. Put these sts. onto a stitch holder.

ON OPPOSITE SIDE of CAM BOX, decrease 1 st. after Rows in () by hanging the 22nd st. ON NECK SIDE onto the 21st st., then moving the end sts. inward to fill the empty needle. ON CAM BOX SIDE, bind off 5 sts. after Row 254; (254), 3 sts. after Rows 256, 258; 2 sts. after Rows 260, (260), 262; 1 st. after Rows 264, 266, (266). The Armhole Shaping is now completed. Begin the Eyelet Design after Row 268 AND continue to decrease 1 st. ON NECK SIDE after Rows 272, 278, 284, 290, 296, 302, 308, 314, 320, 326, 332, 338, then again after Rows in ().

Continue to make buttonholes after Rows in (). ON CAM BOX SIDE, increase 1 st. after Rows 166, 178, (182), 190, 200, 210, (214), 220 then knit to Row 223 and work Short Rows. ON OPPOSITE SIDE of CAM BOX put into holding position 5 needles after Rows 223, 225, 227, 229, 231, 233, 235. After Row 137 bring all needles back into working position, make buttonholes after Row 246, then knit to Row 254.

Make buttonholes after Rows in () over the same sts. as before. ON CAM BOX SIDE, decrease 1 st. after Rows 60, 68, 76, 84, (86), 92, 100, 108, 116, (118), 124, 130, 136, 142, 148, (150), then knit to Row 166.

ROWS 24 to 60: Knit even AND make buttonholes after Row 54 over the 2nd-6th and 15th-19th sts. counting from the left side. Change to stockinette st. after Row 60.

ROWS 0 to 23: Knit even, then cast on 20 sts. ON CAM BOX SIDE.

Cast on 80 sts. and work the Eyelet Design.

Continued on next page

ON CAM BOX SIDE, bind off 4 sts. after Rows 62, 63; 3 sts. after Rows 64, 65, 66, 67, 68, 69; 2 sts. after Rows 70, 71, 72, 73. ON EACH SIDE, hang the 1st st. onto the 2nd st. after Rows 74, 76, 78, 80, 82, 84, 86, 88, 90, 92, 94, 96, 98, 100, 102, 104, 106, 108, 110, 112. ON CAM BOX SIDE, bind off 2 sts. after Rows 114, 115, 116, 117; 3 sts. after Rows 118, 119, 120, 121; 4 sts. after Rows 122, 123; 11 sts. after Row 124.

ON EACH SIDE, increase 1 st. after Rows 10, 18, 26, 34, 42, 50, 58, then knit to Row 62.

ROWS 0 to 10: Knit even, then change to stockinette st.

Cast on 99 sts. and work K1, P1, Ribbing.

Cast on 151 sts. and work 10 rows K1, P1, Ribbing, then bind off all sts. the crochet method for ribbing.

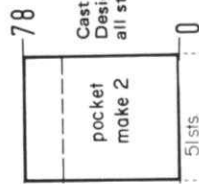
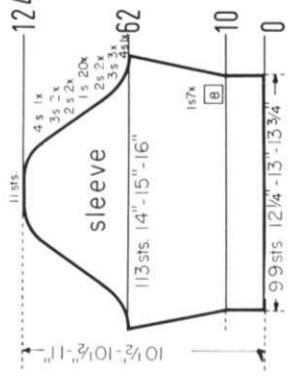

Cast on 51 sts. and work the Eyelet Design. Knit to Row 78, then bind off all sts.

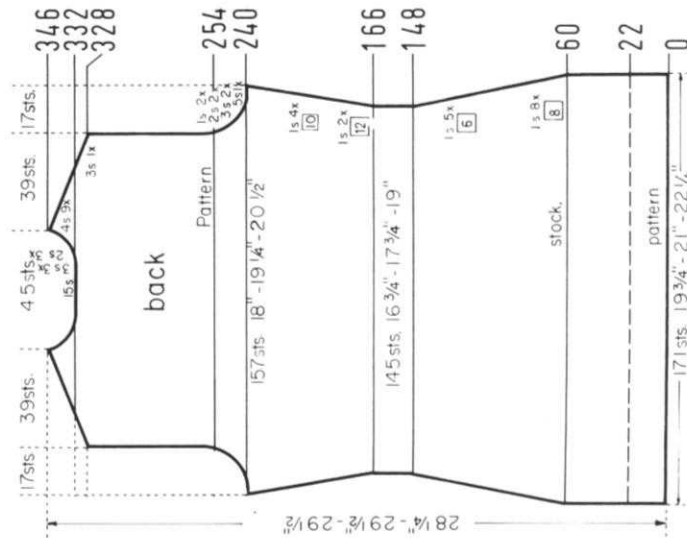

Bring the needles on the left side into working position, knit 1 row in PATTERN to the left side, turn the Row Counter back to 332 and complete the left half. Follow the instructions from *.

*ON CAM BOX SIDE, bind off 4 sts. after Row 332 (EVEN ROWS = SHOULDER SHAPING); 3 sts. after Row 333 (ODD ROWS=NECK SHAPING); 4 sts. after Row 334; 3 sts. after Row 335; 4 sts. after Row 336; 3 sts. after Row 337; 4 sts. after Row 340; 2 sts. after Row 341; 4 sts. after Row 342; 2 sts. after Row 343; 4 sts. after Rows 344, 346.

ON CAM BOX SIDE, bind off 3 sts. after Rows 328, 329; 4 sts. after Rows 330, 331, then knit to Row 332, bind off the center 15 sts., put the needles on the left side into holding position and complete the right half first.

ON CAM BOX SIDE, bind off 5 sts. after Rows 240, 241; 3 sts. after Rows 242, 243, 244, 245; 2 sts. after Rows 246, 247, 248, 249; 1 st. after Rows 250, 251, 252, 253, then knit to Row 254 and begin the Eyelet Design. Knit to Row 328.

ON EACH SIDE, increase 1 st. after Rows 166, 178, 190, 200, 210, 220, then knit to Row 240.

ON EACH SIDE, decrease 1 st. after Rows 60, 68, 76, 84, 92, 100, 108, 116, 124, 130, 136, 142, 148, then knit to Row 166.

ROWS 0 to 60: Knit even, then change to stockinette st.

Cast on 171 sts. and work the Eyelet Design.

- SIZE:** 8 (Chest 26") 10 (Chest 28") 12 (Chest 30")
- YARN:** Subita Dralon 3 ply Sonika Dralon
- 50 gr. BALLS:** 8 Color 1 10 Color 1 11 Color 1
1 Color 2 1 Color 2
1 Color 3 1 Color 3
- TENSION:** 6 to 8
- GAUGE:** 2" 15 sts, 20 rows 14 sts, 18 rows 13 sts, 17 rows

The instructions are the same for all sizes. **PATTERN:** Stockinette Stitch. The Pullover has repeated color stripes as marked in the Diagram. Lower edge of Pullover: K1, P1, Ribbing. **Pants Pocket:** Knit 1, Purl 3 Ribbing according to Line Drawing, worn on the purl side. **DECREASES:** Hang the 3rd st. onto the 2nd st., then move the end sts. inward to fill the empty needle. Begin the Darts by hanging the sts. together as marked in the Diagram, then move the end sts. inward to fill the empty needles. The following decreases for the Darts lie directly above. **INCREASES:** Move the 2 end sts. 1 needle outward, then place the 3rd st. from the row below onto the empty needle.

FINISHING: Pullover: Join front and back section at sides and shoulders. Join short ends of the neckband and short ends of the armhole bands. Sew 1 edge of the neckband to inside and 1 edge to outside of neckline. Sew the armhole bands to armhole edges in the same manner. **Pants:** Join front and back sections at sides. Sew leg seams together, then turn under 25 rows on lower edge and hem to wrong side. Join the sections at center back and center front, leaving about 6 1/2" free for the zipper. Turn under a small amount around the opening and hem to wrong side. Turn under 14 rows on upper edge and hem to wrong side. Insert an elastic band. Sew the zipper in place. Sew the pockets in place.

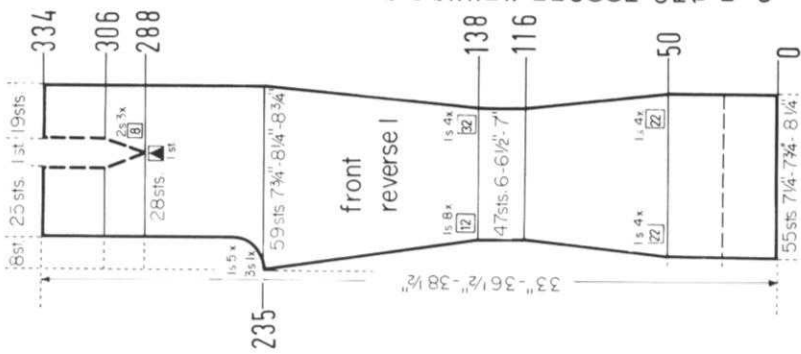

Work the second front section with reverse shapings, casting on from right to left. (Cam Box will be on the LEFT side at Row 0).

ON CAM BOX SIDE, bind off 3 sts. after Row 235; 1 st. after Rows 237, 239, 241, 243, 245, then knit to Row 288. For the DART decrease 2 sts. after Rows 288, 296, 304, then knit to Row 334 and bind off the remaining 45 sts.

Increase 1 st. ON CAM BOX SIDE after Rows in (). ON OPPOSITE SIDE of CAM BOX increase 1 st. after Rows 138, (138), 150, 162, (170), 174, 186, 198, (202), 210, 222, (234), then knit to Row 235.

ON EACH SIDE, decrease 1 st. after Rows 50, 72, 94, 116, then knit to Row 138.

ROW 0 to 50: Knit even.

Cast on 55 sts. and work stockinette st.

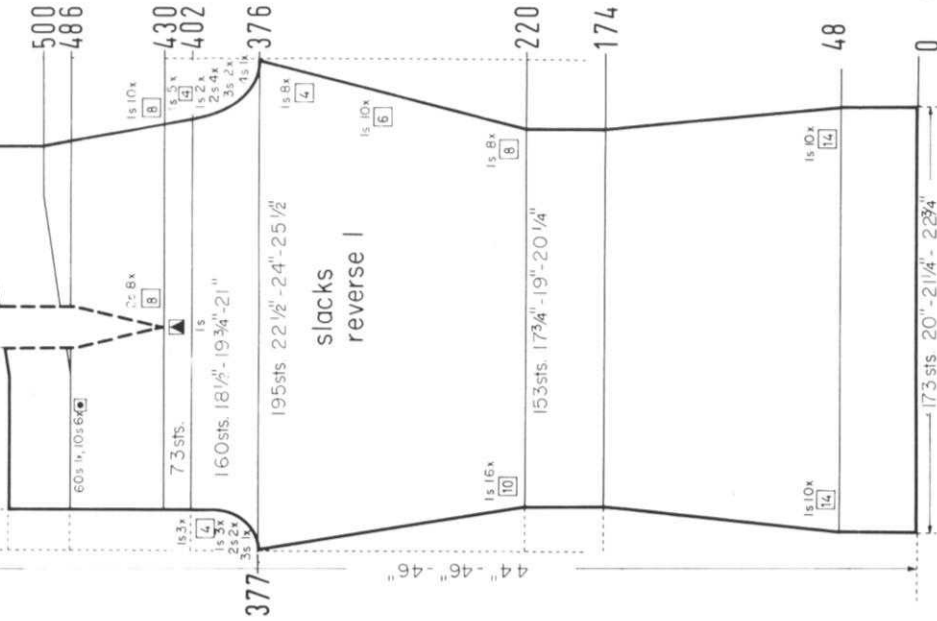
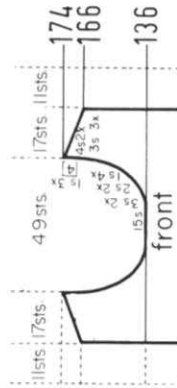

Work the second section with reverse shapings, casting on from right to left. (Cam Box will be on the LEFT side at Row 0).

Decrease 2 sts. for the DART and 1 st. ON CAM BOX SIDE after Rows 430, 438, 446, 454, 462, 470, 478, 486, but do not knit after the last decrease. Work Short Rows. ON OPPOSITE SIDE of CAM BOX put into holding position 60 needles after Row 486; 10 needles after Rows 488, 490, 492, 494, 496, 498. After Row 500 bring all needles back into working position, knit to Row 536, then bind off the remaining 131 sts.

ON CAM BOX SIDE, bind off 4 sts. after Row 376 (EVEN ROWS=CENTER BACK SHAPING); 3 sts. after Rows 377 (ODD ROWS=CENTER FRONT SHAPING), 378; 2 sts. after Row 379; 3 sts. after Row 380; 2 sts. after Rows 381, 382; 1 st. after Row 383; 2 sts. after Row 384; 1 st. after Row 385; 2 sts. after Row 386; 1 st. after Row 387; 2 sts. after Row 388; 1 st. after Rows 389, 390, 392, 393, 394, 397, 398, 402, 406, 410, 414, 422, then knit to Row 430.

Increase 1 st. ON OPPOSITE SIDE of CAM BOX after Rows in (). ON CAM BOX SIDE, increase 1 st. after Rows 220, (220), 228, (230), 236, (240), 244, (250), 252, 260, (260), 268, (270), 276, (280), 284, 290, (290), 296, (300), 302, 308, (310), 314, 320, (320), 326, (330), 332, 338, (340), 344, 348, (350), 352, 356, 360, (360), 364, 368, (370), 372, then knit to Row 376.

ON EACH SIDE, decrease 1 st. after Rows 48, 62, 76, 90, 104, 118, 132, 146, 160, 174, then knit to Row 220.

ROWS 0 to 48: Knit even.

Cast on 173 sts. and work stockinette st.



Cast on 126 sts. with color 1 and work 8 rows stockinette st., then bind off all sts.



Cast on 101 sts. with color 1 and work 8 rows stockinette st., then bind off all sts.

Move the Cam Box to the left side, turn the Row Counter back to 136 and complete the left half. Follow the instructions from *.

*ON CAM BOX SIDE, bind off 3 sts. after Rows 137, 139; 2 sts. after Rows 141, 143; 1 st. after Rows 145, 147, 149, 151, 153, 157, 161. For SHOULDER, bind off 3 sts. after Rows 166, 168, 170; 4 sts. after Rows 172, 174.

Work the front section the same as the back section to Row 136, then bind off the center 15 sts., put the needles on the left side into holding position and complete the right half first.

MK 5353

SIZE: 12 (Chest 30") 14 (Chest 32")
 YARN: Subita Dralon 3 ply
 2 Color 1
 2 Color 2
 2 Color 3
 4 to 6
 17 sts, 23 rows
 16 sts, 22 rows

TENSION: 2"

The instructions are the same for both sizes. **PATTERN:** Stockinette Stitch with repeated color stripes as marked in the Diagram. **INCREASES:** Move the 2 end sts. 1 needle outward, then place the 3rd st. from the row below onto the empty needle. To form the hem, hang the cast-on sts. back onto the machine behind the latches, then knit the following row with 2 tension settings higher.

FINISHING: Block all sections. **PANTS:** Sew the leg seams together, then join the sections at center front and center back. Turn under 18 rows on upper edge and hem to wrong side. Insert an elastic band. With color 3 work a knitted cord, then insert the cord into upper front (See picture). **TOP:** Join front and back sections at sides and shoulders. Join the neck binding at center back and the armhole bindings at short ends. Sew 1 edge of the armhole binding to inside and 1 edge to outside of armhole edges. Sew neck binding to neckline and front bindings to front edges in the same manner. With color 3 work a knitted cord then lace the cord through the front edges. (See Practical Knitting Hints Book page 58 for knitted cord).

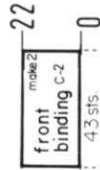

Cast on 43 sts. with color 2 and work 22 rows stockinette st., then bind off all sts.

Work the second front section with reverse shapings, casting on from right to left. (Cam Box will be on the LEFT side at Row 0).

ON CAM BOX SIDE, bind off 5 sts. after Row 44. (EVEN ROWS = ARMHOLE SHAPING); 3 sts. after Row 46; 2 sts. after Rows 48, 50, 52; 1 st. after Rows 54, 56; 4 sts. after Row 57 (ODD ROWS = NECK SHAPING); 1 st. after Row 58; 3 sts. after Row 59; 1 st. after Row 60; 3 sts. after Row 61; 1 st. after Row 62; 2 sts. after Rows 65, 67, 69; 1 st. after Rows 70, 71, 73, 75, 77, 79, 81, 83, 85, 89, then knit to Row 120 and bind off the 10 shoulder sts.

ROWS 19 to 44: Knit even.

ROWS 0 to 18: Knit even, then form the hem and work the repeated color stripes as marked in the Diagram.

Cast on 58 sts. with color 2 and work stockinette st.

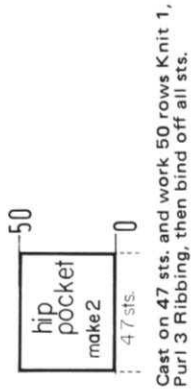
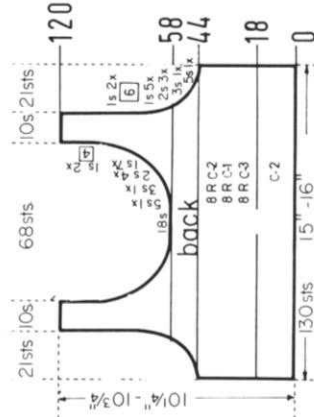
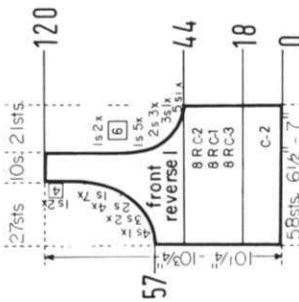

Cast on 47 sts. and work 50 rows Knit 1, Purl 3 Ribbing, then bind off all sts.

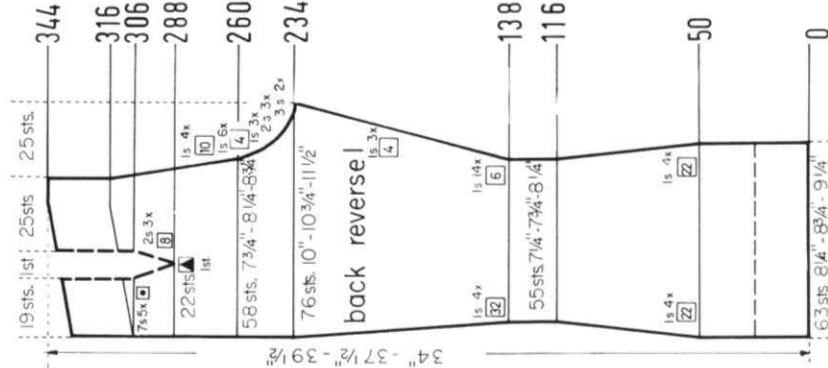
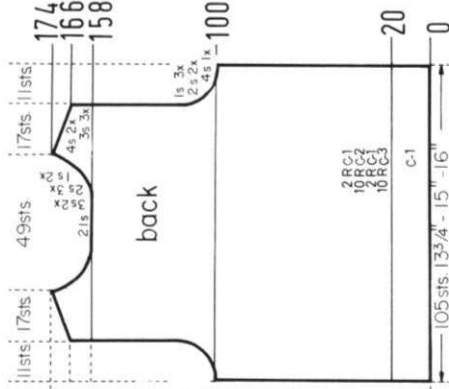

Move the Cam Box to the left side, turn the Row Counter back to 158 and complete the left half. Follow the instructions from *.

*ON CAM BOX SIDE, bind off 3 sts. after Rows 159, 161. (ODD ROWS = NECK SHAPING); 2 sts. after Rows 163, 165; 3 sts. after Row 166 (EVEN ROWS = SHOULDER SHAPING); 2 sts. after Row 167; 3 sts. after Row 168; 1 st. after Row 169; 3 sts. after Row 170; 1 st. after Row 171; 4 sts. after Rows 172, 174.

ON CAM BOX SIDE, bind off 4 sts. after Rows 100, 101; 2 sts. after Rows 102, 103, 104, 105; 1 st. after Rows 106, 107, 108, 109, 110, 111, then knit to Row 158. (for the FRONT Section knit to Row 136) bind off the center 21 sts., put the needles on the left side into holding position and complete the right half first.

ROWS 21 to 100: Knit even.

ROWS 0 to 20: Knit even, then change to stockinette st. and work the color stripes as marked in the Diagram.

Cast on 105 sts. with color 1 and work K1, P1, Ribbing.

Work the second back section with reverse shapings, casting on from right to left. (Cam Box will be on the LEFT side at Row 0).

Decrease 2 sts. for the DART after Row 288, then again after Rows in (). Continue to decrease 1 st. ON CAM BOX SIDE after Rows 294, (296), 304, (304), then knit to Row 306 and work Short Rows. ON OPPOSITE SIDE of CAM BOX put into holding position 7 needles after Rows 306, 308, 310, 312, 314. After Row 316 bring all needles back into working position, then knit to Row 344 and bind off the remaining 45 sts.

ON CAM BOX SIDE, bind off 3 sts. after Rows 234, 236; 2 sts. after Rows 238, 240, 242; 1 st. after Rows 244, 246, 248, 250, 254, 258, 262, 266, 270, 274, 284, then knit to Row 288.

Increase 1 st. ON OPPOSITE SIDE of CAM BOX after Rows in (). ON CAM BOX SIDE, increase 1 st. after Rows 138, (138), 144, 150, 156, 162, 168, (170), 174, 180, 186, 192, 198, (202), 204, 210, 216, 222, 226, 230, (234), but do not knit after the last increase.

ON EACH SIDE, decrease 1 st. after Rows 50, 72, 94, 116, then knit to Row 138.

Rows 0 to 50: Knit even.

Cast on 63 sts. and work stockinette st.

Continued on next page

MAN'S PULLOVER HP 3662

SIZE: 38 (Chest 37"-38")
YARN: Amore
50 gr BALLS: 9
TENSION: 6 to 8
GAUGE: 2" 14 sts, 24 rows

The instructions are the same for both sizes. **PATTERN:** Stockinette Stitch with an Eyelet Design and puri sts, according to Line Drawing. **EDGES:** K1, P1, Ribbing. **IN-CREASES:** Move the 2 and sts. 1 needle outward, then place the 3rd st. from the row below onto the empty needle.

FINISHING: Join front and back section at sides and shoulders. Sew the sleeves together and set in. Sew the buttonhole band to the left side and the button band to the right side of the front opening. Sew the neck band to neckline. Finish buttonholes, sew on buttons.

LINE DRAWING

The dark squares in the Line Drawing represent sts. to be dropped about every 20-30 rows, (the first time down to the ribbing) then to be latched up into knit sts. For the Eyelet Symbols see inside back cover.

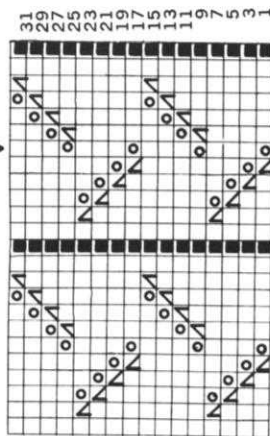

Work the second section with reverse shapings, casting on from right to left. (Cam Box will be on the LEFT side at Row 0).

ON CAM BOX SIDE, bind off 4 sts. after Rows 124 (EVEN ROWS = CENTER BACK SHAPING), 125 (ODD ROWS = CENTER FRONT SHAPING); 3 sts. after Row 126; 2 sts. after Rows 127, 128, 129, 130; 1 st. after Row 131; 2 sts. after Row 132; 1 st. after Rows 133, 134, 135, 136, 137, 138, 139, 141, 142, 146, 150, 162, 174, 186, 198, then knit to Row 210, decrease 1 st. more ON CAM BOX SIDE and change to color 2. Knit to Row 246 and bind off the remaining 125 sts.

ON EACH SIDE, increase 1 st. after Rows 30, 36, 42, 48, 54, 60, 66, 72, 78, 84, 88, 92, 96, 100, 104, 108, 112, 116, 120, then knit to Row 124.

ROWS 19 to 30: Knit even.

ROWS 0 to 18: Knit even, then form the hem and work the repeated color stripes as marked in the Diagram.

Cast on 125 sts. with color 1 and work stockinette st.

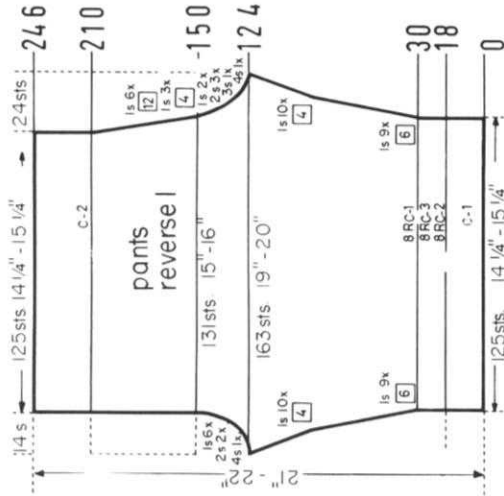

Bring the needles on the left side into working position, knit 1 row in PATTERN to the left side, turn the Row Counter back to 310 and complete the left half. Follow the instructions from *.

* **ON CAM BOX SIDE,** bind off 3 sts. after Rows 310 (EVEN ROWS = SHOULDER SHAPING), 311 (ODD ROWS = NECK SHAPING), 312, 313, 314, 315, 316; 2 sts. after Row 317; 3 sts. after Row 318; 2 sts. after Row 319; 3 sts. after Row 320; 2 sts. after Row 321; 4 sts. after Row 322; 2 sts. after Row 323; 4 sts. after Rows 324, 326, 328.

ON CAM BOX SIDE, bind off 3 sts. after Rows 210, 211, 212, 213; 2 sts. after Rows 214, 215, 216, 217; 1 st. after Rows 218, 219, 220, 221, 222, 223, 226, 227, 230, 231, then knit to Row 310, bind off the center 11 sts. put the needles on the left side into holding position and complete the right half first.

ROWS 29 to 210: Knit even. (For the FRONT Section knit even to Row 186.) **ROWS 0 to 28:** Knit even, then transfer the ribber sts. to the main machine and begin the Eyelet Design.

Cast on 143 sts. and work K1, P1, Ribbing.

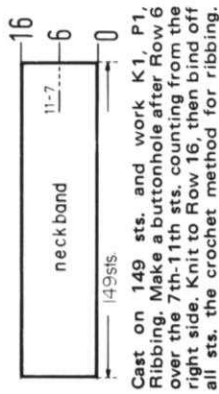

Cast on 149 sts. and work K1, P1, Ribbing. Make a buttonhole after Row 6 over the 7th-11th sts. counting from the right side. Knit to Row 16, then bind off all sts. the crochet method for ribbing.

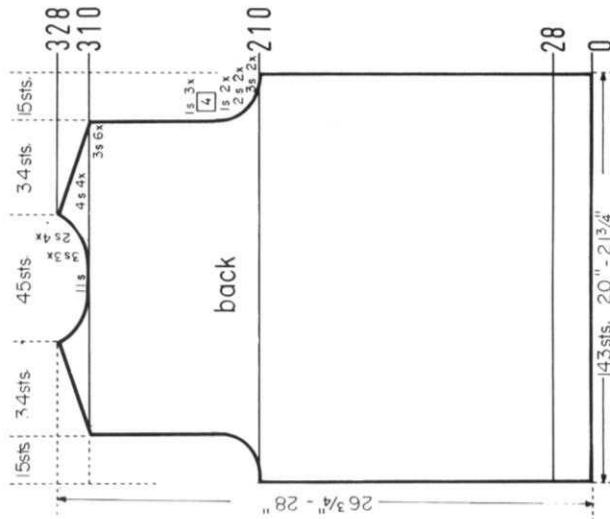

Cast on 75 sts. and work K1, P1, Ribbing. Make buttonholes after Row 8 over the 17th-21st, 37th-41st and 57th-61st sts. counting from the left side. Knit to Row 16, then bind off all sts. the crochet method for ribbing. Work the button band the same, but omit the buttonholes.

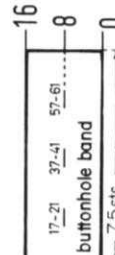

Bring the needles on the left side into working position, knit 1 row in PATTERN to the left side, turn the Row Counter back to 186 and complete the left half. Follow the instructions from *.

ON CAM BOX SIDE, bind off 4 sts. after Row 291 (ODD ROWS = NECK SHAPING); 3 sts. after Rows 293, 295; 2 sts. after Rows 297, 299; 1 st. after Rows 301, 303, 305, 309; 3 sts. after Rows 310, 312 (EVEN ROWS = SHOULDER SHAPING); 1 st. after Row 313; 3 sts. after Rows 314, 316, 318, 320; 4 sts. after Rows 322, 324, 326, 328.

ON CAM BOX SIDE, bind off 3 sts. after Rows 210, 212; 2 sts. after Rows 214, 216; 1 st. after Rows 218, 220, 222, 226, 230, then knit to Row 291.

* **ROWS 187 to 210:** Knit even.

Work the front section the same as the back section to Row 186, then bind off the center 7 sts., put the needles on the left side into holding position and complete the right half first.

ON CAM BOX SIDE, bind off 4 sts. after Rows 64, 65; 3 sts. after Rows 66, 67; 2 sts. after Rows 68, 69, 70, 71, 72, 73. **ON EACH SIDE,** hang the 1st st. onto the 2nd st. after Rows 74, 76, 78, 80, 82, 84, 86, 88, 90, 92, 94, 96, 98, 100, 102, 104, 106, 108, 110, 112, 114, 116, 118, 120. **ON CAM BOX SIDE,** bind off 2 sts. after Rows 122, 123, 124, 125; 3 sts. after Rows 126, 127, 128, 129; 13 sts. after Row 130.

ON EACH SIDE, increase 1 st. after Rows 16, 24, 32, 40, 48, 56, then knit to Row 64.

ROWS 0 to 16: Knit even, then transfer the ribber sts. to the main machine and begin the Eyelet Design.

Cast on 95 sts. and work K1, P1, Ribbing.

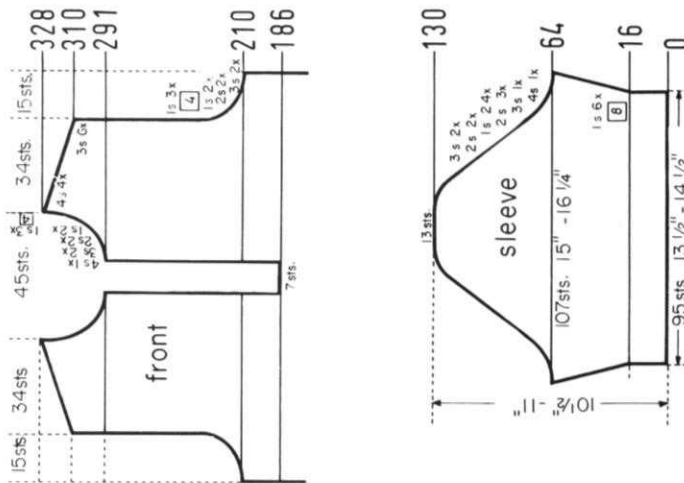

MK 5350

- SIZES:** 6 (Chest 24") 8 (Chest 26") 10 (Chest 28 1/2")
- YARN:** Subita Dralon 3 ply Sonika Dralon
- 50 gr BALLS:** 2 Color 1 2 Color 1 1 Color 2 1 Color 3 1 Color 4 1 Color 5 6 to 8 15 sts, 21 rows 12 sts, 23 rows
- TENSION:** 2" Stk. Pattern 16 sts, 22 row 13 sts, 27 rows

The instructions are the same for all sizes. **PATTERN:** PANTS: Holding Position Design according to Line Drawing using Wheel 3, changing the colors of your choice every 6 rows. **TOP:** Stockinette Stitch using the same color scheme as in the pants, but changing the colors every 4 rows. **EDGES of TOP:** K1, P1, Ribbing.

FINISHING: PANTS: Sew the leg seams together, then join sections at center front and center back. Turn under about 1 1/2" at upper edge and leg edges and hem to wrong side. Insert an elastic band into upper hem. **TOP:** Join front and back section at sides and shoulders. Join short ends of neckband and short ends of armhole bands, then sew the bands in place.

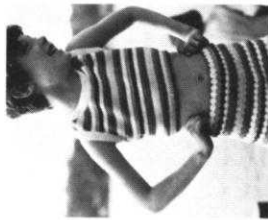
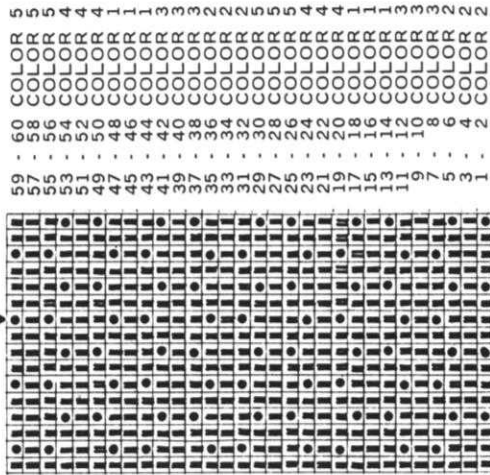

Move the Cam Box to the left side, turn the Row Counter back to 238 and complete the left half. Follow the instructions from *.

*ON CAM BOX SIDE, bind off 4 sts. after Rows 238 (EVEN ROWS = SHOULDER SHAPING), 239 (ODD ROWS = NECK SHAPING), 240: 3 sts. after Row 241; 4 sts. after Row 242; 3 sts. after Row 243; 4 sts. after Rows 244, 246.

ON CAM BOX SIDE, bind off 4 sts. after Rows 230, 231, 232, 233, 234, 235, 236, 237, then knit to Row 238, bind off the center 16 sts., put the needles on the left side into holding position and complete the right half first.

ON EACH SIDE, decrease 1 st. after Rows 42, 50, 58, 66, 74, 82, 90, 98, 106, 114, 122, 128, 134, 140, 146, 152, 158, 164, 170, 176, then knit to Row 230.

ROWS 0 to 42: Knit even.
Cast on 148 sts. and work stockinette st.

ON CAM BOX SIDE, bind off 3 sts. after Rows 136, 137, 138, 139, 140, 141, 142, 143, 144, 145; 4 sts. after Rows 146, 147, 148, 149, 150, 151; 24 sts. after Row 152.

ON EACH SIDE, decrease 1 st. after Rows 42, 58, 74, 90, 106, then knit to Row 136.

ROWS 0 to 42: Knit even.
Cast on 88 sts. and work stockinette st.

Cast on 195 sts. and work 10 rows K1, P1, Ribbing, then bind off all sts. the crochet method for ribbing. Work 1 more section the same.

Cast on 195 sts. with color of your choice and work K1, P1, Ribbing, changing color after Rows 4, 8, 12, and 16. After Row 20 bind off all sts. the crochet method for ribbing. Work 1 more section the same.

Cast on 129 sts. with main color and work 8 rows K1, P1, Ribbing, then bind off all sts.

Cast on 115 sts. with main color and work 8 rows K1, P1, Ribbing, then bind off all sts.

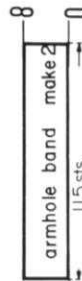
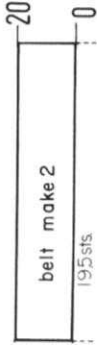
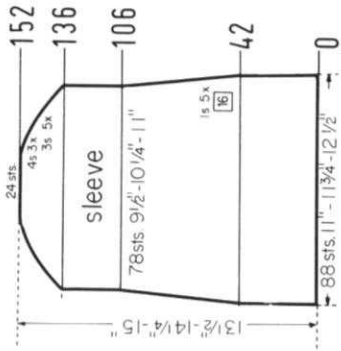
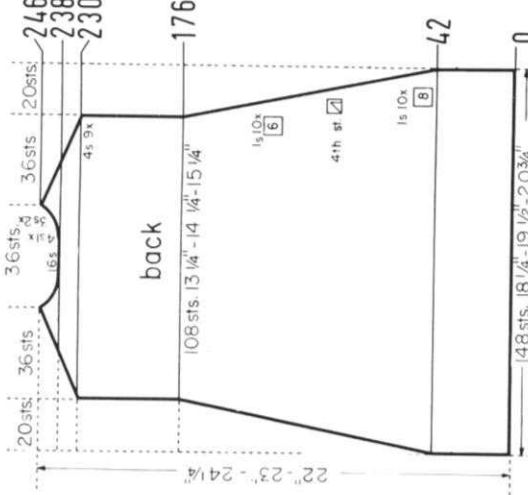

Work the second section with reverse shapings. Cast on the regular way, then knit 1 row in PATTERN to the left side and turn the Row Counter back to 0.

ON OPPOSITE SIDE of CAM BOX put into holding position 30 needles after Row 162; 10 needles after Rows 164, 166, 168, 170. After Row 172 bring all needles back into working position and bind off the remaining 80 sts.

ON CAM BOX SIDE, bind off 2 sts. after Rows 36 (EVEN ROWS = CENTER BACK SHAPING), 37 (ODD ROWS = CENTER FRONT SHAPING), 38, 39; 1 st. after Rows 40, 41, 42, 43, 44, 45, 46, 47, 50, 54, 58, 62, 66, 74, 82, 90, 98, 106, 114, 122, 130, then knit to Row 162 and work Short Rows.

ON EACH SIDE, decrease 1 st. after Rows 4, 8, 12, then increase 1 st. ON EACH SIDE after Rows 16, 20, 24, 28, 32, then knit to Row 36.

Cast on 105 sts. with color of your choice and work the Holding Position Design, changing color after every 6 rows.

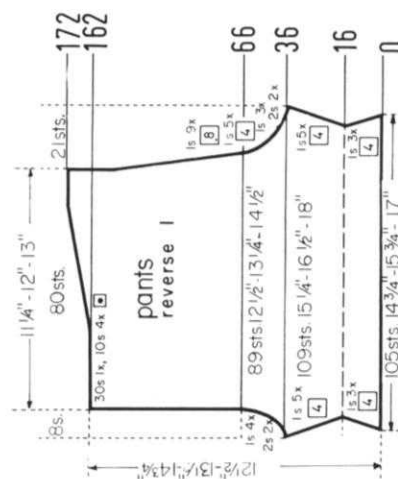

Move the Cam Box to the left side, turn the Row Counter back to 90 and complete the left half. Follow the instructions from*.

*ON CAM BOX SIDE, bind off 3 sts. after Rows 91, 93; 2 sts. after Rows 95, 97; 1 st. after Rows 99, 101, 103, 105, 107, 109, then knit to Row 126 and bind off the 9 shoulder sts.

Work the front section the same as the back section to ROW 90, then bind off the center 17 sts., put the needles on the left side into holding position and complete the right half first.

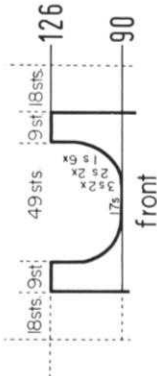

KK 5352

SIZE:	3 (Hip 22")	4 (Hip 23")	6 (Hip 25")
YARN:	Subita Dralon 3 ply	Sonika Dralon	Sonika Dralon
50 gr BALLS:	1 Color 1 1 Color 2	2 Color 1 1 Color 2	2 Color 1 1 Color 2
TENSION:	4 to 6	6 to 8	7 to 9
GAUGE:	2" 16 sts. 22 rows	15 sts. 21 rows	14 sts. 20 rows

The instructions are the same for all sizes. **PATTERN:** Stockinette Stitch. To form the hem, hang the cast-on sts. back onto the machine behind the latches, then knit the following row with 2 tension settings higher.

FINISHING: Join the back section to the front section at sides. Weave the open sts. of the crotch together. Turn under about 1/2" around leg edges and hem to wrong side. Insert an elastic band into the upper hem. Fold the flap in half and close side edges, then sew the flap to waist band (See picture). Sew a button to the flap.

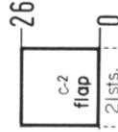

Cast on 21 sts. with color 2 and work 26 rows stockinette st., then bind off all sts.

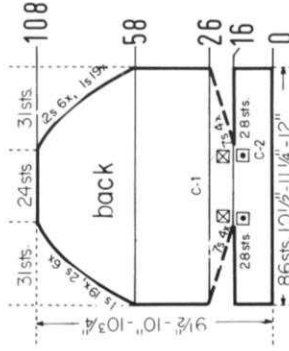

Patterns are selected — row by row — through a pre-stamped card that is fed into the Jac.

There are over 300 cards available and illustrations of them are included with each Jac. Jac 40's are made for most brands of machines. When ordering be sure to specify your brand of knitter as needle spacings vary. Simple to use and an essential tool for the modern knitter, Jac 40's are \$26.95 complete with 3 cards for practicing the 3 techniques, plus complete instructions.

Order from your dealer or direct from
KNITTING

1128 Crenshaw Boulevard, Los Angeles, Calif. 90019

Shipping Cost \$1.25 — California residents add 5% sales tax.

Move the Cam Box to the left side, turn the Row Counter back to 114 and complete the left half. Follow the instructions from*.

*ON CAM BOX SIDE, bind off 4 sts. after Row 115; 3 sts. after Rows 117, 119, 121, 123. After Row 126 bind off the 9 shoulder sts.

ON CAM BOX SIDE, bind off 3 sts. after Rows 60, 61, 62, 63; 2 sts. after Rows 64, 65, 66, 67, 68, 69; 1 st. after Rows 70, 71, 72, 73, 74, 75, 76, 77, 78, 79, 80, 81, then knit to Row 114 (for the FRONT Section knit to ROW 90.) bind off the center 17 sts., put the needles on the left side into holding position and complete the right half first.

ROWS 9 to 60: Knit even.

ROWS 0 to 8: Knit even, then change to stockinette st.

Cast on 103 sts. with color of your choice, work K1, P1, Ribbing and change color after every 4 rows.

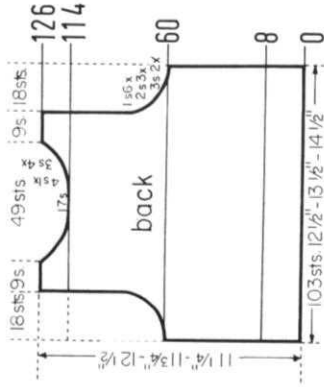

ON OPPOSITE SIDE OF CAM BOX put into holding position 1 needle after Rows 58, 59, 60, 61, 62, 63, 64, 65, 66, 67, 68, 69, 70, 71, 72, 73, 74, 75, 76, 77, 78, 79, 80, 81, 82, 83, 84, 85, 86, 87, 88, 89, 90, 91, 92, 93, 94, 95; 2 needles after Rows 96, 97, 98, 99, 100, 101, 102, 103, 104, 105, 106, 107. After Row 108 bind off 31 sts. ON EACH SIDE (the sts. on the needles in holding position) and put the remaining 24 sts. onto a stitch holder.

ON OPPOSITE SIDE OF CAM BOX put into holding position 28 needles after Rows 16, 17. ON OPPOSITE SIDE OF CAM BOX bring back into working position 7 needles after Rows 18, 19, 20, 21, 22, 23, 24, 25, then work over all 86 needles to Row 58. Work Short Rows.

ROWS 0 to 16: Knit even, then form the hem, change to color 1 and work Short Rows.

Cast on 86 sts. with color 2 and work stockinette st.

ON OPPOSITE SIDE OF CAM BOX put into holding position 16 needles after Rows 50, 51; 3 needles after Rows 52, 53, 54, 55; 2 needles after Rows 56, 57, 58, 59; 1 needle after Rows 60, 61, 62, 63, 64, 65, 66, 67, 68, 69. After Row 70 bind off 31 sts. ON EACH SIDE (the sts. on the needles in holding position), then knit over the remaining 24 sts. to Row 100 and put the sts. onto a stitch holder.

ROWS 17 to 50: Knit even, then work Short Rows.

ROWS 0 to 16: Knit even, then form the hem and change to color 1. Cast on 86 sts. with color 2 and work stockinette st.

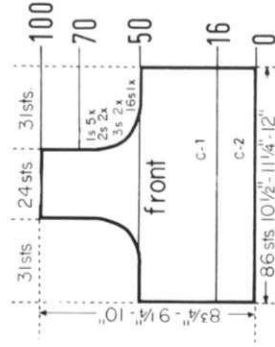

jac 40 amust



- SIZE:** 8 (Chest 26") 10 (Chest 28") 12 (Chest 30")
YARN: Subita Crepe 2 x 3 Subita Dralon 3 ply Subita Dralon 3 ply
50 gr. BALLS: 3 4 4
TENSION: 4 to 6 5 to 7 6 to 8
GAUGE: 2" 16 sts, 28 rows 15 sts, 26 rows 14 sts, 24 rows

The instructions are the same for all sizes. **PATTERN:** Holding Position Design according to Line Drawing, using Wheel 2. The puri side is the right side. **EDGES:** Stockinette Stitch, worn on the knit side. To make the hem, hang the cast-on sts. back onto the machine in **FRONT** of the latches, then push the right Cam Control Button toward the back and knit 2 rows without yarn. Push the Cam Control Button forward, turn the Row Counter back to 18 and begin the Holding Position Design.

FINISHING: **SHORTS:** Join the sections at sides and at the crotch. Join short ends of leg bands, then sew 1 edge of band to inside and 1 edge to outside of leg edges. Insert an elastic band into upper hem. **TOP:** Join back and front sections at sides and shoulders. Join short ends of armhole bands, then sew 1 edge of band to inside and 1 edge to outside of armhole edges. Sew the neckband to neckline in the same manner. Work 2 rows of single crochet on edges of back opening, working 5 loops on 1 edge and sewing 5 buttons to other edge of opening.

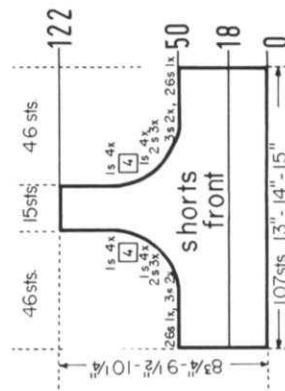
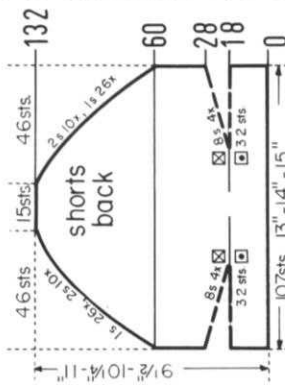
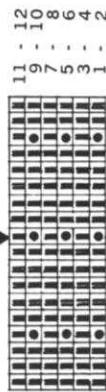

ON EACH SIDE, hang the 1st st. onto the 2nd st. after Rows 60, 62, 64, 66, 68, 70, 72, 74, 76, 78, 80, 82, 84, 86, 88, 90, 92, 94, 96, 98, 100, 102, 104, 106, 108, 110. **ON CAM BOX SIDE,** bind off 2 sts. after Rows 112, 113, 114, 115, 116, 117, 118, 119, 120, 121, 122, 123, 124, 125, 126, 127, 128, 129, 130, 131. After Row 132 bind off the remaining 15 sts.

ON OPPOSITE SIDE OF CAM BOX put into holding position 32 needles after Rows 18, 19. **ON OPPOSITE SIDE OF CAM BOX** bring back into working position 8 needles after Rows 20, 21, 22, 23, 24, 25, 26, 27, then knit over all needles to Row 60.

ROWS 0 to 18: Knit even, then form the hem. Now begin the Holding Position Design AND work Short Rows. Cast on 107 sts. and work stockinette st.

ON CAM BOX SIDE, bind off 26 sts. after Rows 50, 51; 3 sts. after Rows 52, 53, 54, 55; 2 sts. after Rows 56, 57, 58, 59, 60, 61. **ON EACH SIDE,** hang the 1st st. onto the 2nd st. after Rows 62, 64, 66, 68, 70, 74, 78, 82, then knit to Row 122 and bind off the remaining 15 sts.

ROWS 19 to 50: Knit even. **ROWS 0 to 18:** Knit even, then form the hem and begin the Holding Position Design. Cast on 107 sts. and work stockinette st.

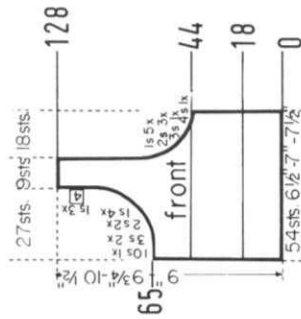

Cast on 123 sts. and work 14 rows stockinette st., then bind off all sts.

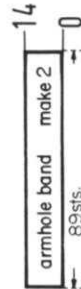
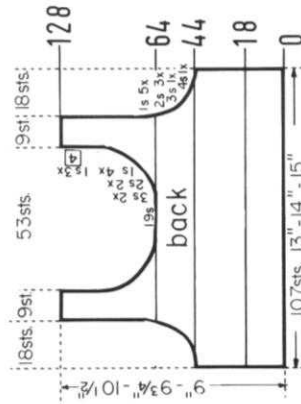

Cast on 89 sts. and work 14 rows stockinette st., then bind off all sts.



Cast on 191 sts. and work 14 rows stockinette st., then bind off all sts.

Work the second front section with reverse shapings. Cast on the regular way, then knit 18 rows for the band, make the hem and knit 1 row in **PATTERN** to the left side. Turn the Row Counter back to 18. (Cam Box will now be on the **LEFT** side at even numbered Rows).

ON CAM BOX SIDE, bind off 10 sts. after Row 65; 3 sts. after Rows 67, 69; 2 sts. after Rows 71, 73; 1 st. after Rows 75, 77, 79, 81, 83, 87, 91, then knit to Row 128 and bind off the 9 shoulder sts.

ON CAM BOX SIDE, bind off 4 sts. after Row 44; 3 sts. after Row 46; 2 sts. after Rows 48, 50, 52; 1 st. after Rows 54, 56, 58, 60, 62, then knit to Row 65. **ROWS 19 to 44:** Knit even.

ROWS 0 to 18: Knit even, then form the hem and begin the Holding Position Design.

Cast on 54 sts. and work stockinette st.

Bring the needles on the left side into working position, knit 1 row in **PATTERN** to the left side, turn the Row Counter back to 64 and complete the left half. Follow the instructions from*.

***ON CAM BOX SIDE,** bind off 3 sts. after Rows 65, 67; 2 sts. after Rows 69, 71; 1 st. after Rows 73, 75, 77, 79, 81, 85, 89, then knit to Row 128 and bind off the 9 shoulder sts.

ON CAM BOX SIDE, bind off 4 sts. after Rows 44, 45; 3 sts. after Rows 46, 47; 2 sts. after Rows 48, 49, 50, 51, 52, 53; 1 st. after Rows 54, 55, 56, 57, 58, 59, 60, 61, 62, 63, then knit to Row 64, bind off the center 19 sts., put the needles on the left side into holding position and complete the right half first.

ROWS 19 to 44: Knit even.

ROWS 0 to 18: Knit even, then form the hem and begin the Holding Position Design.

Cast on 107 sts. and work stockinette st.

MK 5351

- SIZE:** 3 (Chest 22") 4 (Chest 23") 6 (Chest 24"-25")
YARN: Subita Dralon 3 ply Sonika Dralon
50 gr BALLS: 2 Color 1 3 Color 1
 1 Color 2 1 Color 2
TENSION: 4 to 6 6 to 8 7 to 9
GAUGE: 16 sts, 22 rows 15 sts, 21 rows 14 sts, 20 rows

The instructions are the same for all sizes. **PATTERN:** Stockinette Stitch. **DECREASES:** Hang the 3rd st. onto the 2nd st., then move the end sts. inward to fill the empty needle. **INCREASES:** Move the 2 end sts. 1 needle outward, then place the 3rd st. from the row below onto the empty needle.

FINISHING: Join front and back section at sides and at the crotch. With Color 2, work a knitted cord over 3 needles with tension 1. Knit 920 rows (empty rows do count). Sew the cord to the neckline and armhole edges. Work 3 loops on each front shoulder and sew 3 buttons to each back shoulder. Sew an applique of your choice to the lower front part of the bathing suit.

Move the Cam Box to the left side, turn the Row Counter back to 164 and complete the left half. Follow the instructions from*.

*ON CAM BOX SIDE, bind off 3 sts. after Rows 165, 167; 2 sts. after Rows 169, 171; 1 st. after Rows 173, 175, 177, 181. After Row 206 bind off the 9 shoulder sts.

ON CAM BOX SIDE, bind off 3 sts. after Rows 146, 147, 148, 149; 2 sts. after Rows 150, 151, 152, 153, 154, 155; 1 st. after Rows 156, 157, 158, 159, 160, 161, then knit to Row 164, bind off the center 14 sts., put the needles on the left side into holding position and complete the right half first.

ON EACH SIDE, increase 1 st. after Rows 108, 118, 128, 138, then knit to Row 146 and change to color 2.

ON EACH SIDE, decrease 1 st. after Rows 60, 66, 72, 78, 84, 90, 96, then knit to Row 108.

ON OPPOSITE SIDE of CAM BOX, bring back into working position 1 needle after Rows 34, 35, 36, 37, 38, 39; 2 needles after Rows 40, 41, 42, 43, 44, 45; 3 needles after Rows 46, 47, 48, 49, 50, 51; 18 needles after Rows 52, 53, then knit over all 96 needles to Row 60.

ROWS 0 to 34: Knit even. Using 2 separate strands of yarn, cast on 36 sts. ON EACH SIDE of the center 24 sts., then put the needle with the newly cast-on sts. into holding position and work Short Rows.

Cast on 24 sts. with color 1 and work stockinette st.

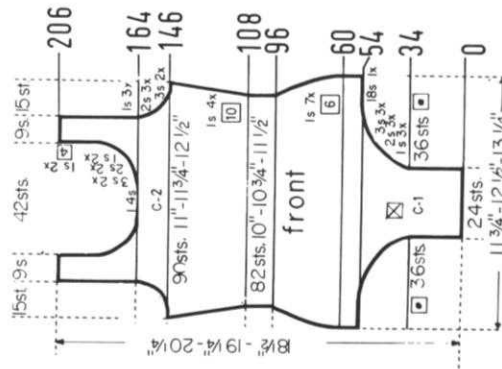
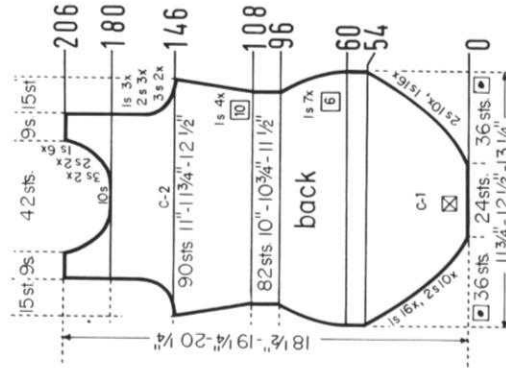

Move the Cam Box to the left side, turn the Row Counter back to 180 and complete the left half. Follow the instructions from*.

*ON CAM BOX SIDE, bind off 3 sts. after Rows 181, 183; 2 sts. after Rows 185, 187; 1 st. after Rows 189, 191, 193, 195, 197, 199. After Row 206 bind off the 9 shoulder sts.

ON CAM BOX SIDE, bind off 3 sts. after Rows 146, 147, 148, 149; 2 sts. after Rows 150, 151, 152, 153, 154, 155; 1 st. after Rows 156, 157, 158, 159, 160, 161, then knit to Row 180, bind off the center 10 sts., put the needles on the left side into holding position and complete the right half first.

ON EACH SIDE, increase 1 st. after Rows 108, 118, 128, 138, then knit to Row 146 and change to color 2.

ON EACH SIDE, decrease 1 st. after Rows 60, 66, 72, 78, 84, 90, 96, then knit to Row 108.

ON OPPOSITE SIDE of CAM BOX, bring into working position 2 needles after Rows 2, 3, 4, 5, 6, 7, 8, 9, 10, 11, 12, 13, 14, 15, 16, 17, 18, 19, 20, 21; 1 needle after Rows 22, 23, 24, 25, 26, 27, 28, 29, 30, 31, 32, 33, 34, 35, 36, 37, 38, 39, 40, 41, 42, 43, 44, 45, 46, 47, 48, 49, 50, 51, 52, 53, then work over all 96 needles to Row 60.

ROWS 0 to 2: Knit even. Using 2 separate strands of yarn, cast on 36 sts. ON EACH SIDE of the center 24 sts., then put the needles with the newly cast-on sts. into holding position and work Short Rows.

Cast on 24 sts. with color 1 and work stockinette st.

BE SURE TO NOTIFY US IMMEDIATELY OF ANY CHANGE OF ADDRESS. THE POST OFFICE WILL NOT FORWARD YOUR MAGAZINE TO YOU.

SIZE: 15" 18" 20"
 (measured from neck to tail)

YARN: Subita Crepe 2 x 3 Subita Crepe 2 x 4 Double Knitting
 2 Color 1 3 Color 1 4 Color 1
 1 Color 2 1 Color 2 2 Color 2
TENSION: 3 to 5 6 to 8 8 to 10
GAUGE: 2" 18 sts., 24 rows 15 sts., 20 rows 13 sts., 18 rows

The instructions are the same for all sizes. **PATTERN:** Stockinette Stitch. The Coat may also be knitted with a Norwegian Design such as shown in the picture, JAC 40 PATTERN No. 10. For the two larger sizes, you will need equal amounts of each color yarn.

FINISHING: Block the coat. Take out the cast-on row of the band, then weave these sts. and the sts. from the stitch holder together. With right side up, weave the band all around onto the edges of the Coat. Fold the band in half toward the wrong side and sew against the edge. Fold tab in half lengthwise and sew all open edges together. Sew the tab to one side of the coat, fasten with snaps to the other side. Sew snaps to neck and sew pocket flaps in place. (A neat neckline and shoulder line will be obtained if the neck and shoulder shapings are worked with short rows).

TAB
 Cast on 22 sts. with color 2 and work 24 rows stockinette st., then bind off all sts.

BAND
 Cast on 11 sts. with color 2 and work 760 rows stockinette st., then put the sts. onto a stitch holder.

POCKETS
 Cast on 26 sts. with color 2 and work 36 rows stockinette stitch, then bind off all stitches. Make 2

Move the Cam Box to the left side, turn the Row Counter back to 176 and complete the left half. Follow the instructions from*.

ON CAM BOX SIDE, bind off 1 st. after Row 176 (EVEN ROWS = SHOULDER SHAPING); 2 sts. after Row 177 (ODD ROWS - NECK SHAPING); 1 st. after Row 178; 2 sts. after Row 179; 1 st. after Row 180; 2 sts. after Rows 181, 182, 183, 184, 185, 186, 187, 188, 189; 3 sts. after Row 190; 2 sts. after Row 191; 3 sts. after Row 192; 2 sts. after Row 193; 3 sts. after Row 194; 2 sts. after Row 195; 4 sts. after Row 196; 2 sts. after Row 197; 4 sts. after Row 198; 7 sts. after Row 200.

ON CAM BOX SIDE, bind off 1 st. after Rows 170, 171, 172, 173, 174, 175, then knit to Row 176, bind off the center 49 sts., put the needles on the left side into holding position and complete the right half first.

ON CAM BOX SIDE, increase 2 sts. after Rows 156, 157, 158, 159, 160, 161, 162, 163, 164, 165, 166, 167, 168, 169. ON EACH SIDE, increase 1 st. after Rows 138, 140, 142, 144, 146, 148, 150, 152, 154.

ON EACH SIDE, decrease 1 st. after Rows 90, 94, 98, 102, 106, 110, 114, 118, 122, 126, 130, then knit to Row 138. ON EACH SIDE, increase 1 st. after Rows 22, 30, 38, 46, 54, 62, 70, 78, then knit even to Row 90.

ON OPPOSITE SIDE OF CAM BOX, put into holding position 17 needles after Rows 0, 1. ON OPPOSITE SIDE OF CAM BOX, bring back into working position 3 needles after Rows 2, 3; 2 needles after Rows 4, 5, 6, 7, 8, 9, 10, 11, 12, 13; 1 needle after Rows 14, 15, 16, 17, 18, 19, 20, 21.

Cast on 129 sts. with color 1. Work stockinette st. and Short Rows.



New! New! New! Suitable for all types of knitting machines . . . even double beds.

\$39.50

F.O.B. Los Angeles
 Calif. residents add 5% Sales Tax



knitking
 Knitting Machine Table
 48" long, 14" deep
 Walnut finish,
 Mar-proof top.

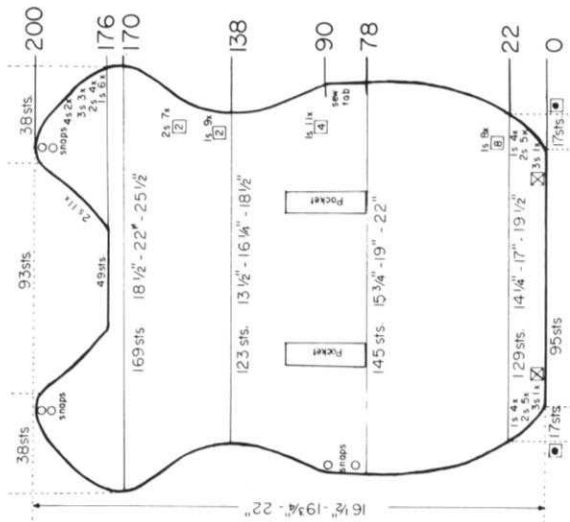



KNITTING NEWS

May/June, 1972

OUR READERS WRITE...

Mrs. Melvin A. Butts of Bozeman Montana writes.... "Entered the Winter Fair here in Bozeman last Saturday with six garments... all made from KNITTING MAGAZINE and won... 1 first - 4 second and 1 third place..." Congratulations! Next time you will receive all first awards...!!

On the Questionnaire Mrs. Bozeman returned to us she says that finishing is difficult and she would like us to give more helps and hints, particularly when the front band is turned in. She would also like to know how to put in a Zipper...

The finishing of your knitted garment is MOST important... for as you well know, you can do a perfect job of knitting... then if you do a poor job of finishing, your garment does not have that professional look of a beautifully made knit... so... look to your finishing and if there is something specific that is NOT COVERED in our marvelous little book "Practical Knitting Hints" (which everyone should own) please write to us and we will be delighted to help you... Meantime, Mrs. Bozeman, here is the answer to the procedure you seem to have problems with....

When you have a band that turns under for a facing on a Cardigan or a Jacket such as the Jacket DK 8059 in the Jan/Feb issue of KNITTING MAGAZINE, you will note that you are told to cast on 30 sts. after Row 15. Instead of doing this, begin by casting on the 30 sts. FIRST, using a contrast waste yarn BEFORE you begin your garment knitting. Knit about 7 or 9 rows with the waste yarn (be sure it is the same weight as your garment yarn) then take these sts. off onto a stitch holder. Now begin your garment... Cast on the 74 sts. with your garment yarn and knit to Row 15, break the yarn, then to the left of your garment section, hang the 30 sts. from your stitch holder, attach garment yarn and continue knitting.

When you reach the neck shaping, take the 27 sts. for the neck off onto contrast waste yarn instead of binding them off. When your Counter reads 267, put all but the 27 neck sts. into holding position and with contrast waste yarn, knit at least 10 rows, then drop these sts. off the machine, turn your Row Counter to 267, attach yarn at neck edge, bring all the needles into working position and continue with your knitting. Reverse the sides for the second front section.

You can use Short Rows for shaping the rest of your neckline. Providing the shaping is done on every other row, Short Rows can be used for all shaping of necklines, armholes and shoulders - See KNITTING Practical Knitting Hints Book, pages 17 to 20. In KNITTING MAGAZINE we tell you to bind off these stitches because space does not permit us to explain Short Rows in every pattern and because the new knitters would be confused.

After blocking all sections of your garment (and the Ironall - available from KNITTING for \$3.50 plus 80¢ Shipping costs, is just perfect for all types of knitting yarns) making sure you use the proper setting of your iron for the type of yarn being used (NEVER hot steam for synthetics) and ALWAYS PLEASE DO BLOCK every single piece before putting a garment together... fold the front facing over and weave the open stitches held on waste yarn, then remove the waste yarn. Explicit directions for Weaving Open Stitches together is given in the Newsletter of KNITTING MAGAZINE for September/October 1970. If you do not have a copy of this issue, you may order it for \$1.50 (single issue price) postpaid.

When you put a zipper into a garment, always sew it in by hand when your garment is completed. If the opening has no facing (as at a Neckline) you must work one or two rows of single crochet around the opening, holding it in a bit so as not to stretch the opening. Pin the zipper into the opening with the garment edges against the edge of the zipper teeth (right side for both zipper and garment). Be sure the edges will not catch in the zipper. Sew your zipper in with matching sewing thread, not yarn, using an invisible back stitch and use a sharp needle. Work from the right side and take a tiny stitch, bringing the needle down to the wrong side, then up to the right side approximately 3/8" in front of the first stitch; take a tiny stitch back, bringing the needle down to the wrong side, then up again to the right side approximately 3/8" in front of that stitch, etc., etc. Just be sure the zipper is pinned in flat and smooth (you can baste it if you want to) before you begin.

We will tell you how to put a zipper in when you have a separate facing in a future issue of KNITTING MAGAZINE.

MORE PRACTICAL KNITTING HINTS

In the Practical Knitting Hints of KNITTING MAGAZINE for January/February, 1972, we gave you one method for knitting a Sleeve where you had to INCREASE a specific number of stitches after knitting the close fitting section. You can use the same method for DK 8023 in this issue... or... use this easier way which is DECREASING the stitches instead of increasing. This simply means you will knit the full section first and the tight section (or cuff) last.

Cast on 128 sts. using waste yarn. Knit several rows ending with the Cam Box on the right side. Turn the Row Counter to 28, change to the garment yarn and follow the instructions beginning with Row 29. At Row 206, the instructions tell you to turn the knitting. If you do not know how to do this, one way is to knit 7 to 9 rows with contrast waste yarn and remove the work from the machine. Turn the knitting over and replace the garment sts (with knit side facing you) onto the machine. Complete the upper section of the Sleeve. (Of course, if you own a Reversing Bar, by all means use it to turn your knitting).

To knit the Cuff... Bring 107 needles into working position, then counting from the right side, push the 6th and every following 5th needle into holding position (20 needles in holding position). Now hang the Sleeve sts. held on contrast waste yarn back onto the machine, decreasing to 107 sts. by hanging 1 st. on each needle in working position and 2 sts. on each needle in holding position. After all the sts. are on the machine, carefully remove the waste yarn. Connect the Ribber and transfer every other stitch (or double sts.) to the Ribber. Knit 28 rows of K1, P1 Ribbing then bind off all 107 sts. the crochet method for Ribbing.

COVER MODEL Midriff DK 8023

To make the Bust Darts in P3, K1 Ribbing... The Bust Dart starts after Row 55. Your Cam Box is on the left side. On opposite side of Cam Box, bring 7 needles into holding position (the stitches on the Ribber MUST be transferred to the Main Machine if they are to be put into holding position). When knitting Short Rows, you wind the yarn around the inside needle in holding position... In this instance, where the garment is to be worn on the Purl side, knit across to the holding needles, then with the eye end of your latch tool, take the stitch from the first inside needle onto the tool and hold it while you wind the yarn around the empty needle first, then hang the stitch back onto the needle. This will place the wrap-around yarn to the wrong side and at the same time keep the continuity of your Ribbing. In all our instructions for Ribbing, we stress the point that end needles must always be on the Main Machine, but in this case, when you are knitting Short Rows, if the first needle (after holding needle) is a Ribber needle, leave it there, as you do not need to worry about it when knitting a Dart.

KNITTING DESKS ARE AVAILABLE AGAIN

Because we were aware several months beforehand, that the recently ended West Coast Dock Strike was going to take place, we managed to stockpile most of our imported merchandise, but we erred somewhat in our estimate of Desk sales with the result that we were completely out of them before the end of the year and have only just taken delivery of a new shipment.. We were sorry to have to return the cash on many orders placed for Desks, but we told everybody that we would honor their orders at the Sale Price if they wanted to leave them with us.. Those that did, have now taken possession of their

handsome Desks... and our warehouse is stocked to the ceiling with them all packed in cartons ready for shipment... We do not have to increase the price as much as was expected and we are putting them on "Special" immediately.

KNITTING DESKS can be used for most brands of knitting machines with the exception of very heavy double bed machines.... Your knitter disappears inside the Desk on its own spring loaded platform, and you have a very good looking piece of useful furniture that fits nicely in any room of your house... KNITTING DESKS come in several finishes, the most popular is Natural Walnut, the others are Natural Oak, (a light finish), Natural Pearwood (a fruitwood that blends with Mahogany and Maple) and Natural Teak, a very beautiful exotic and rare wood... Walnut, Oak and Pearwood Desks retail at \$169.50 each and the Teak at \$179.50 (all F.O.B. Los Angeles).

We are putting them on "Special" at a big saving to you of \$30.00... This means that the Walnut, Oak and Pearwood Desks can be obtained (until the end of June) for \$139.50 and the Teak for \$149.50 ... Don't delay, get your order in right away and be sure of the finish of your choice. (California residents be sure to add 5% Sales Tax).



NOTES TO KNIT BY . . .

STITCH AND ROW GAUGE

KNIT A SAMPLE SWATCH . . . before you begin to knit any garment . . . for this is the MOST IMPORTANT STEP toward the correct size and the proper fit of any garment you wish to make. You MUST use the SAME YARN for your sample swatch that you will use to knit your garment and your sample swatch must be knitted large enough and using several different tension numbers on your machine. When you have done this, then you can determine the number of stitches and the number of rows in a two-inch measure. KNITTING MAGAZINE PATTERNS give you 3 tensions to try and one of them should give you the correct stitch and row gauge if you are using the yarn we recommend or a similar weight yarn. Here is the way to make your sample swatch.

Cast on over a sufficient number of needles to produce a swatch at least 4 inches wide. (If the pattern calls for 16 stitches to 2", then $16 \times 2 = 32$ stitches to cast on). Now knit 4 inches of rows at the first suggested tension number. (If the pattern calls for 22 rows to 2", $22 \times 2 = 44$ rows to knit). Knit 2 rows using a contrast color, change to the next higher tension and with garment yarn knit another 4", knit 2 rows with contrast color, change to the 3rd higher tension and knit another 4" and then bind off.



Roll the swatch into a cylinder over its length and pull on both ends, unroll it and stretch it diagonally by pulling on the four corners. Allow the swatch to rest and settle (preferably overnight) and then using a stitch gauge or a ruler, count the number of stitches over a 2" width, then the number of rows over a 2" length in EACH of the 3 tensions. Select the tension number that produces the stitches and rows called for in the pattern. If none of them are correct, you are most likely using the wrong weight of yarn.



READING OF CHARTS

You will notice the instructions start at the bottom of the Chart and work UP. Follow the charts exactly as written and providing your sample stitch and row gauge is correct, your garment will come out the right size. Please remember that the section of garment as it is knitted on the machine, faces the same way as the Charts are in this magazine. Where two front pieces are needed, (or any other part of a garment that needs two sections) only one section is normally shown and the second section is usually made with reverse shapings. Set in sleeves are usually identical, but raglan sleeves have to be knitted with reverse shapings for the second sleeve.

READING OF SYMBOLS

To simplify Pattern Knitting, we use Symbols in the Line Drawings and the Chart Diagrams. In the Line Drawings the symbols are shown and are to be read as you look at them while knitting a garment. For instance, if



a Purl stitch faces you, the Purl stitch Symbol  is shown; if a knit stitch faces you (as when using the Ribber) then this Symbol  is shown. The Symbol  at the top of the Line Drawing is the center of the garment section and you use this as a guide for setting up the needles.

The following Symbols    are used for Eyelet Designs in the Line Drawings and also for Full Fashion shaping on the Charts. The Line Drawings have row numbers on the right side. Missing Row numbers are always knitted straight or plain.

In Holding Position Designs  selected needles are pushed into holding position for the stated number of rows. The numbers of rows appear at the right of the Line Drawings; Example: 1-4 means knit Rows 1 to 4; 5 to 7 means knit Rows 5 to 7, etc. This same Symbol is also shown on the Charts and is used for putting needles into holding position for Short Rows. The

Symbol  on the Charts is used to put needles back into working position when knitting Short Rows.

A number in a box stands for the number of rows to be knitted between shapings. Make shapings first, then knit the necessary number of rows. If for instance it reads:

1 st. 8 x

 1 st. 10 x



As you will be reading the instructions from the bottom up, here is the way you will follow them: . . . Decrease or increase (depending on the direction of the garment outline) 1 st. at the row where the shaping begins, then knit 8 rows, make the next decrease, then knit 8 rows, until you have decreased (or increased) 1 st. 10 x and you have knitted 8 rows after each decrease (or increase) (1 st. 10 x + 8 rows 10 x). Now begin the first decrease (or increase) for the shaping (which has to be made 8 x) in every 6th row. Decrease (or increase) 1 st. first, then knit 6 rows until you have decreased 1 st. 6 x and after each decrease (or increase) have knitted 6 rows (1 st. 8 x + 6 rows 8 x).

Where shapings are given without a boxed number as on most armholes, necklines, etc., make the shapings on every second row (on each side of course).

(See below for more Pattern Stitch Symbols.)

PATTERN STITCH SYMBOLS

 = knit stitch

 = purl stitch

 = empty needle (leave in working position)

 = needle not used (in the out of work position)

 = needle in the holding position

 = Needles back into working position.

 = 2 stitches on 1 needle — either transferred from the right side or the left side, then put the needle into holding position

 = needle holding 2 stitches. Stitch has been transferred from the LEFT

 = needle holding 2 stitches. Stitch has been transferred from the RIGHT

 = 3 stitches on 1 needle. The 1st and 3rd stitch in a group of 3 needles has been hung on the 2nd or center needle.

 = Center of Garment Section.

 = Number of rows to be knitted between shapings.

The diagrams (Line Drawings) for pattern work are followed just as they are shown and are to be read as you look at them while knitting the garment.

open darts



closed darts



