

# knitking

*magazine*

mar/apr '72





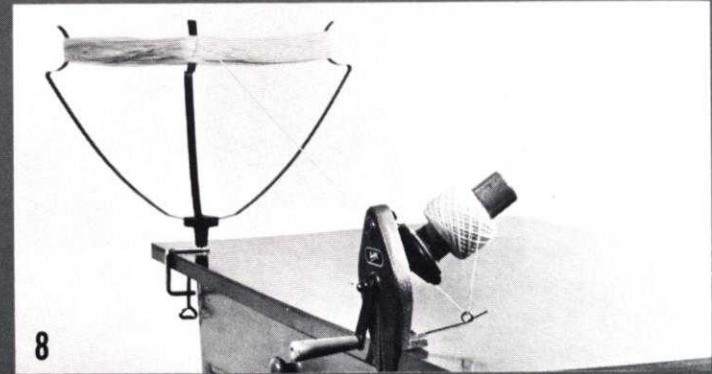
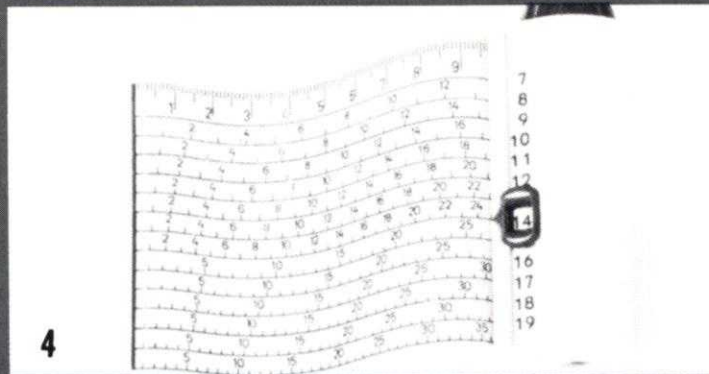
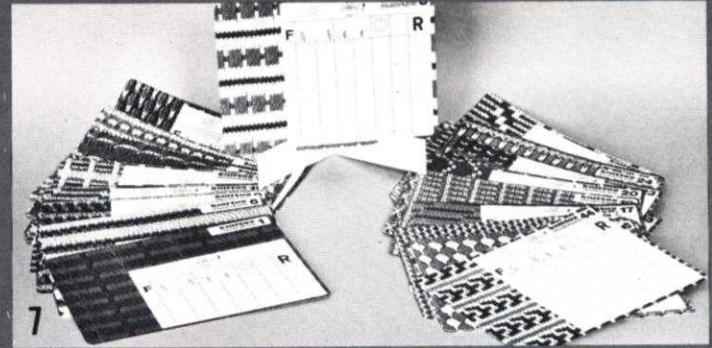
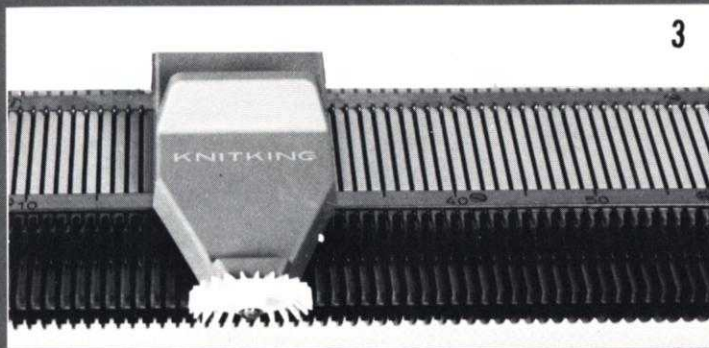
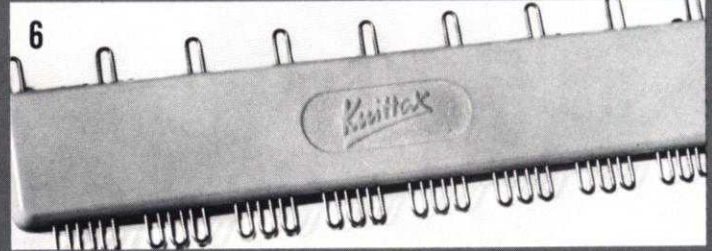
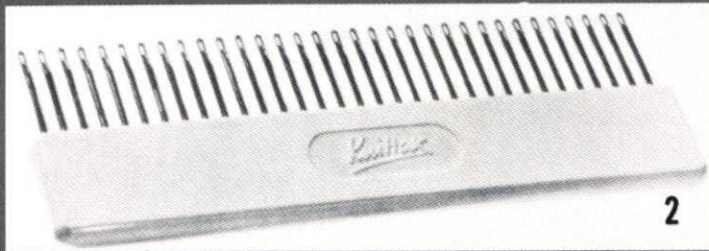

1. Treble Transfer Tools for rapid transfer of stitches and for Cable Stitch. \$1.80 pair plus 50¢ shipping.

2. 33 Needle Multi-Transfer Tool. For decreasing in the middle of a row. \$3.25 plus 50¢ shipping.

3. KNITKING Weaving Accessory (for AM 3 machine). Weaves an additional thread into your knitting and produces patterns with a woven appearance. \$7.95 plus 65¢ shipping.

4. Converta Tape. For simple and speedy charting of custom knits. \$7.95 plus 50¢ shipping.

# accessories

5. Reversing Bar. For easy hem turning or reversing of knitting. \$18.95 plus \$1.50 shipping.

6. Adjustable Needle Selector. For setting unevenly spaced pattern stitches. \$3.50 plus 50¢ shipping.

7. KNITKING Pattern Stitch Cards (for AM 3 machine only). 48 Pattern Cards with 96 beautiful patterns in color and black and white. Simple row by row instructions. \$9.50 plus 95¢ shipping.

8. Yarn Winder and Skein Holder. Heavy cast frame and nylon gears. \$16.95 plus \$1.60 shipping. Without Skein Holder \$13.50 plus \$1.00 shipping.

California residents add 5% Sales Tax

**KNITKING • 1128 Crenshaw Blvd., Los Angeles, California 90019**



# knitking magazine

INDEX	PAGE NO.
DP 8081	Woman's Twinset . . . . . 14
DK 8027	Woman's Pullover and Vest . . . . . 16
HP 3663	Man's Striped Shirt . . . . . 17
DP 7769	Woman's Coat . . . . . 18
DK 8036	Woman's Dress . . . . . 20
HP 3658	Man's Pullover Vest . . . . . 20
DK 8012	Woman's Pantsuit . . . . . 21
DK 8006	Woman's Dress . . . . . 22
DK 8007	Woman's Dress . . . . . 24
MK 5344	Girl's Two-piece Dress . . . . . 25
HP 3659	Man's Pullover . . . . . 26
MK 5337	Girl's Pullover and Slacks . . . . . 27
DK 8086	Woman's Hotpants Jumpsuit . . . . . 28
DK 8087	Long Hostess Skirt . . . . . 29
KK 5334	Boy's Pullover and Slacks . . . . . 30
KG 1942	Shawl . . . . . 31
KG 1943	Shawl . . . . . 31
KG 1939	Rug . . . . . 32
KG 1940	Pillow . . . . . 32
KG 1941	Pillow . . . . . 32



**FRONTPIECE**

Spring starts NOW! Knit yourself some no care Cruise clothes that travel wrinkle free. Our Cover Model Twinset DP 8081 is a perfect example of what you'll need. Designed for our larger sized friends, it has slim and flattering lines. Size 18 is knitted with KNITKING Fortissima, Size 20 and 24 with Subita Crepe 2 x 4. See page 14

**BACK COVER - DK 8027**

Stripe a Pullover and matching Vest for that layered look (or wear them separately). Choose 4 colors . . . they'll blend beautifully when you use KNITKING Fortissima for a size 8 and Amore for Sizes 12 and 16. See page 16

Publisher: KNITKING CORPORATION, 1128 Crenshaw Blvd., Los Angeles, Calif. 90019. Telephone: WEbster 8-2079. Published bi-monthly. Subscriptions: USA - \$6.00 annually, single copies \$1.50; Canada - \$7.00; other parts of the world - \$10.00. The entire contents of KNITKING MAGAZINE are copyright and must not be reproduced in any shape or form without the express permission, in writing of the publisher. COPYRIGHT © by KNITKING CORPORATION 1972.

Printed by George Rice & Sons, Los Angeles, California



## ORDER IT NOW!

Every reader of KNITKING MAGAZINE needs the big beautiful KNITKING YARN CATALOGUE with 329 actual yarn samples . . . the finest from around the world in an unbelievable range of colors.

KNITKING  
1128 Crenshaw Blvd.  
Los Angeles, Calif. 90019

I enclose one dollar . . . . .  
Please RUSH my beautiful new  
KNITKING YARN CATALOGUE to me at:

Name \_\_\_\_\_

Address \_\_\_\_\_

City \_\_\_\_\_ State \_\_\_\_\_ Zip \_\_\_\_\_





BOOKS by KNITTING

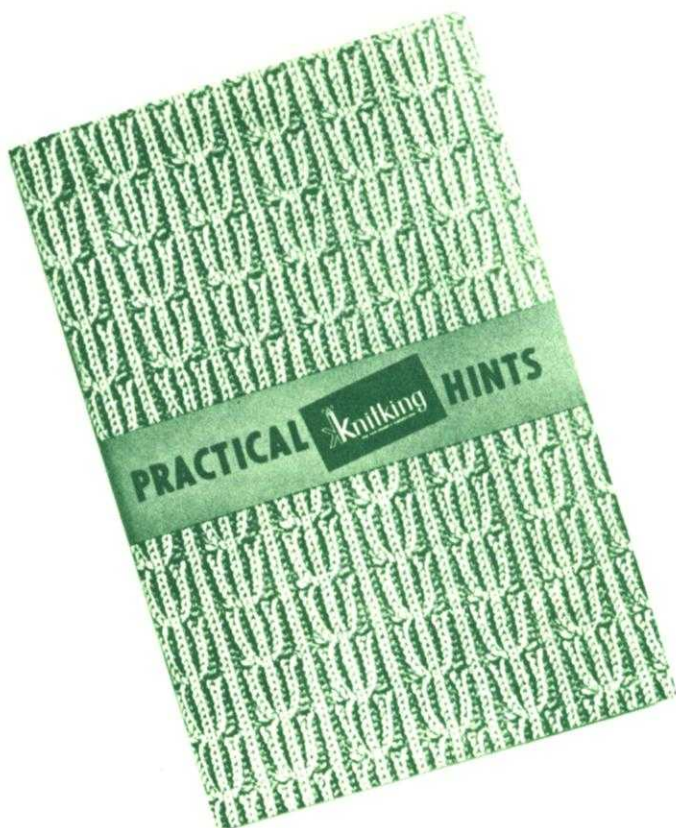

NEW VOLUME AVAILABLE NOW

A complete seventh volume of KNITTING MAGAZINES with a flexible, transparent plastic cover and specially bound so that it will stay open at any page, is available at the special price of \$6.95 (plus 95 cents mailing costs).

If purchased separately the magazines would cost a total of \$9.00.

The volume contains over 120 fully illustrated complete stylish patterns for all members of the family together with many valuable, practical knitting hints.

There is a very limited number of these volumes available and it will undoubtedly become a collectors item.

If you already have the entire set it will almost certainly be well thumbed and marked. Why not purchase a perfect mint condition volume for your bookshelf and ready reference at any time.

Place your order today and avoid disappointment. Send it to KNITTING MAGAZINE, 1128 Crenshaw Boulevard, Los Angeles, California 90019.

PRACTICAL KNITTING HINTS

We call this book the TEXT BOOK for machine knitters because it answers the many questions that occur in machine knitting, from preparing to knit, taking measurements, shaping, making buttonholes, special effects, bindings, bands and edges, etc., through finishing and blocking. It sells for \$2.95

40 cents mailing  
Calif. residents add 5% Sales Tax

I enclose \$7.90  
Please RUSH my bound Seventh Volume of  
KNITTING MAGAZINE to me at:

Name \_\_\_\_\_

Address \_\_\_\_\_

City \_\_\_\_\_ State \_\_\_\_\_ Zip \_\_\_\_\_



# knitking *magazine*

Statistics show that most National subscription Magazines lose 40% of their subscribers each year! Which explains why you receive so many enticing letters from publishers, encouraging you to remain a subscriber at special rates that decrease annually according to the number of years for which you renew. All the money that is spent encouraging you to renew on an annual basis is saved when you renew for several years at a time and those savings are passed on to you the reader.

For the past year, we have been offering a Stitch and Row Calculator (that sells elsewhere for \$4.95) free with every 2 year subscription placed and are happy to say that many thousands of our readers have taken advantage of this generous offer and that as a result, our subscriber list is somewhat longer than it would be if we had not made the offer. . . but, we still lose subscribers. . . and it worries us. . . we cannot easily understand why anybody that owns a knitting machine can afford to be without the up-to-date patterns and knitting machine information we offer in each issue. . . We, of course, know that it is not possible to keep all readers happy all of the time. . . but we try each year to make KNITKING MAGAZINE worth at least \$6.00 to every individual subscriber. . . Nobody can be expected to use all the patterns we publish. . . surely one or two usable patterns each issue, for you and your family, makes the investment worthwhile.

The questionnaire included with each renewal notice has been helpful in our efforts to determine why subscriptions are not renewed. . . One very obvious reason for not renewing is the readers inability to use her knitting machine. . . Many thousands of machines are sold in America each year through mail-order catalogues and discount stores, with no other instruction facility than the frequently badly prepared instruction manual. . . No personal help is available. . . no follow-up of pattern instruction. . . no service for the machine should it be needed, etc. . . Many purchasers of such machines (and in most instances, the quality of the machine is high) start with great enthusiasm. They collect all the information they can about machine knitting. . . they subscribe to KNITKING MAGAZINE. . . they purchase yarn, set their knitting machine up and endeavor to get started, then something goes wrong. . . Their knitter will just not perform for them. . . the knitting falls off after a few rows are knitted. . . they cannot obtain the Stitch and Row gauge the pattern calls for, etc., etc. . . then after many hours of wasted time and frayed nerves, they give up in disgust. . . They put their machines out of sight and allow their subscriptions to run out.

We want to help all subscribers (irrespective of the brand of machine owned by them) to get full use from their machines and from KNITKING MAGAZINE. . . We employ the finest group of knitting machine experts in the country and it is at the disposal of our readers. . . so. . . if you are having problems using your knitting machine, don't hesitate, write to us in detail. . . tell us of your problems. . . be sure to tell us the brand name of the machine you own, as controls vary. . . tell us also its Model Number and age. . . we will do our utmost to help you and to keep you as a subscriber.

The next issue of KNITKING MAGAZINE is a special one, featuring Beach and Holiday wear. . . it has Bikinis. . . Bathing Suits. . . Swim Trunks. . . Shorts. . . Pullovers. . . Shells. . . Pants and bare Midriff Tops, etc. . . Watch out for it. . . .

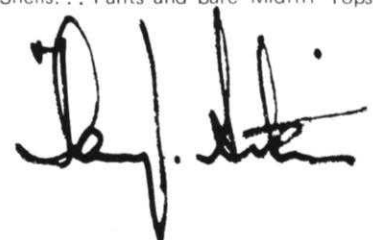

LETTER  
from the  
PUBLISHER



DK 7769

Just in time for Spring . . . an easy to knit Coat with matching Beret. Stockinette Stitch with a pretty Cable Design on the front section. The pert Beret is knitted in 9 sections. Size 10 is made with KNIT-KING Subita Crepe 2 x 4; Size 12 Subita Dralon 3-ply and Size 14 Sonika Dralon. See page 18







HP 3658

Let your Man relax and go casual in a good looking Pullover Vest. Stripe it in two colors of Knitting Subita Crepe 2 x 4 for a Size 36; Sonika Dralon for Size 38 and 40. See page 20

DK 8012

Show off a pretty figure in a knitted Pantsuit. The Skinny Ribbed Pullover is striped in 3 colors and trimmed with crochet (or use the knitted Trim we give in the KNITTING NEWS for this issue). The Slacks are knitted in Stockinette Stitch with stripes on lower leg sections. Size 10 is knitted with KNITTING Fortissima; Size 12 with Subita Crepe 2 x 3; Size 14 Subita Dralon 3-ply. See page 21

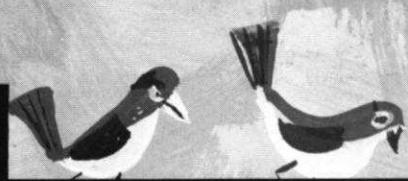



HP 3663

He'll join you for tea (or cocktails) on deck, wearing a handsome Shirt striped in 2 colors. The Sleeves and Pockets knitted in the darker color make this one a big hit with your favorite Man. Size 36, use KNIT-KING Subita Crepe 2 x 3; Size 38 Fortissima. See page 17

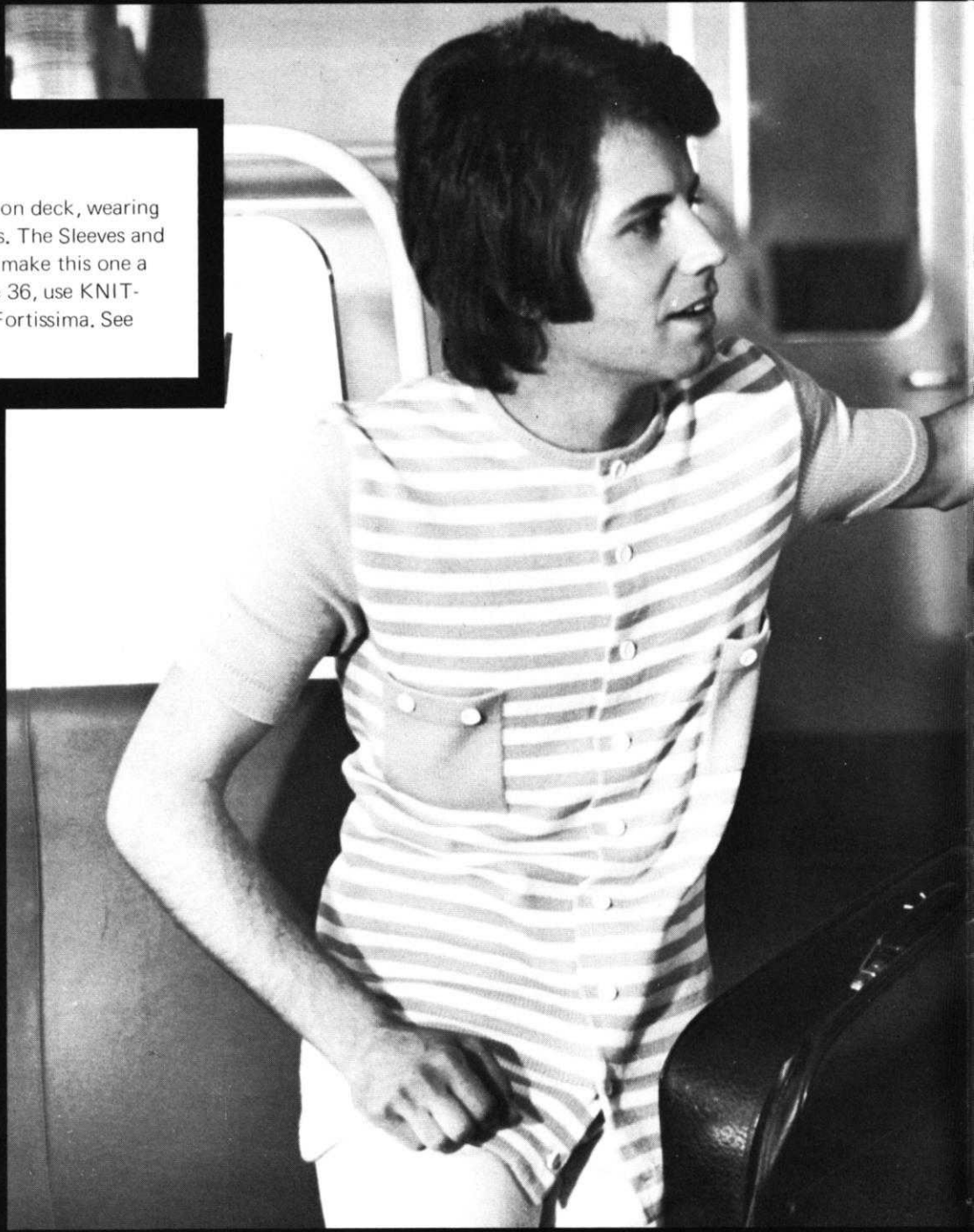





DK 8036

On land or sea, you'll feel elegant in a simple Dress with soft figure revealing lines. Knit it in Stockinette Stitch and make the Bows from a round knitted Cord. Size 8 is made with KNITKING Gardenia Baby; Size 10 Subita Dralon 3-ply; Size 16 Sonika Dralon. See page 20





DK 8006

Dance to Folk music wearing a brightly patterned Dress knitted in Stockinette Stitch with a Norwegian Design that follows the Chart, or you may use your JAC 40 and Pattern No. 418. Size 10 and Size 14 is knitted with KNITKING Excelsior. See page 22

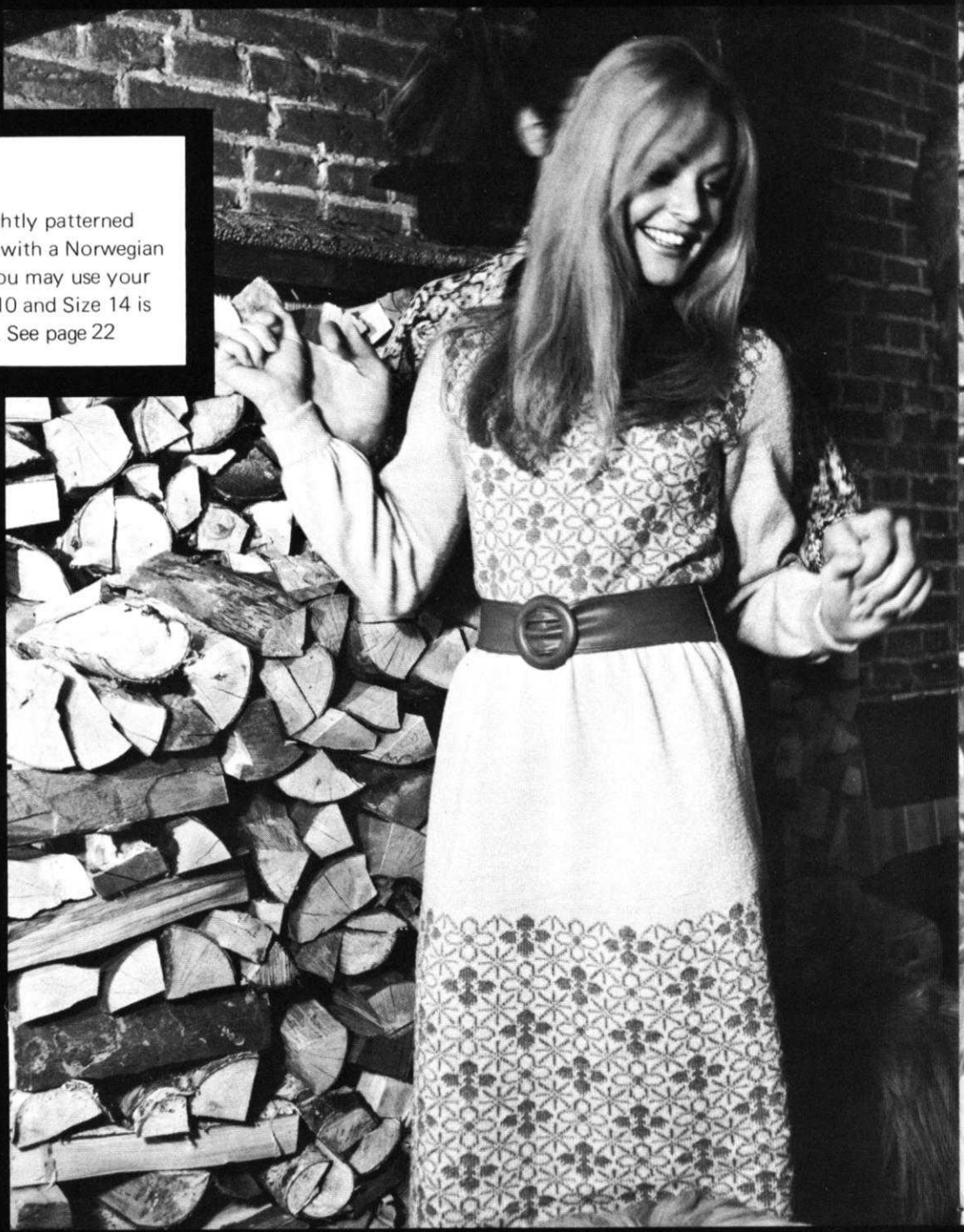





**DK 8007**

The shape of Spring . . . The all feminine Dress is quickly knitted in easy Stockinette Stitch. A flutter of striped Ruffles is lovely for the trim around Sleeves and lower edge. Size 10 is knitted with KNIT-KING Subita Crepe 2 x 3; Size 12 Fortissima; Size 20 Crocus Crepe. See page 24







MK 5344

Smart and attractive for the teen-age girl is this lovely two-piece dress. The wrap over Skirt is accented with a 1 x 1 Ribbed Band and Buttons. The Pullover has a Ribbed Pattern on the Sleeves with the trim and Neckband in a 1 x 1 Rib. She'll love it! Size 9/10 and 11/12 is knitted with KNITKING Crocus Crepe; Size 15/16 with Sonika Dralon. See page 25







**MK 5337 and KK 5334**

Knitted Pantsuits are just great for the Boys as well as the Girls. Both outfits have long Ribbed Pullovers that are belted in the latest style. Her Pullover is a wide Rib Pattern; his a 1 x 1 Rib. Pants are in Stockinette Stitch.

MK 5337: Size 9/10 KNITKING Subita Crepe 2 x 3; Size 11/12 Fortissima; 14/15 Subita Dralon 3-ply. See page 27 KK 5334: Size 6 KNITKING Subita Crepe 2 x 3; Size 10 Crocus Crepe, Size 12 Subita Crepe 2 x 4. See page 30







HP 3659

VIP . . . He'll feel like a "very important person" if you knit your man a new Pullover that boasts the latest widely spaced Rib. Purchase matching Buttons and Belt. Size 40 uses KNITKING Fortissima; Size 44 Subita Crepe 2 x 4. See page 26







**DK 8086 and DK 8087**

Entertain, or be entertained wearing a delightful one-piece Hotpants Jumpsuit with a long slim Skirt unbuttoned at the side front to expose as much leg as you like. The Hotpants Jumpsuit is knitted in a 1 x 1 Rib, the Skirt in Stockinette Stitch.

DK 8086: Use KNITKING Subita Crepe 2 x 3 for a Size 10; Subita Crepe 2 x 4 for Sizes 12 and 14. See page 28

DK 8087: Size 10, 12, 14. All are knitted with KNITKING Subita Crepe with Lurex. See page 29





**KG 1942 and KG 1943**

Be Romantic . . . look ultra feminine in a lovely knitted Shawl. Choose one made in a soft Pattern Stitch . . . or if you prefer the lacey look, knit the other with needles out of work as well as a Holding Position Design. We give you two yarns . . . both Shawls can be knitted with KNITKING Subita Crepe with Lurex for evening glamour, or you can use Amore for a different look.

KG 1942: See page 31

KG 1943: See page 31



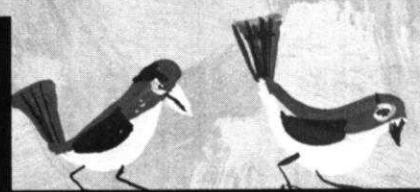
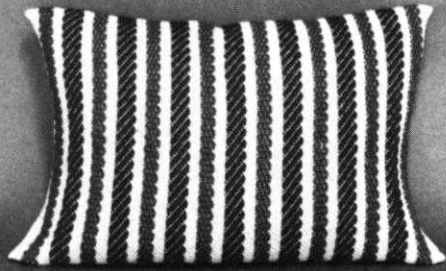

**KG 1939 and KG 1940**

This is the Needlecraft Era . . . so get out your KNITKING Weaving Accessory and Pattern Wheels No. 3 and 6 for a really fun project . . . Knit a Rug and matching Pillow using KNITKING Sonika Dralon with 2 colors of Leacril for Weaving. See page 32



**KG 1941**

It's an elegant large sized Pillow with the Homespun look. To get the texture, use KNITKING Amoretta for the knitting, Amorina for the Weaving. Follow the Line Drawing and use your KNITKING Weaver with Wheel No. 6. See page 32



# DP 8081

**SIZE:**  
YARN: 50gr. balls

18 (Bust 40"-41")  
Fortissima  
10 for Pullover  
11 for Cardigan  
4 for Trim  
5 to 7  
17 sts. 23 rows

20 (Bust 42"-43")  
Subita Crepe 2 x 4  
11 for Pullover  
12 for Cardigan  
4 for Trim  
5 to 7  
16 sts. 23 rows

24 (Bust 45"-46")  
Subita Crepe 2 x 4  
12 for Pullover  
14 for Cardigan  
4 for Trim  
6 to 8  
15 sts. 22 rows

**TENSION:** 2"  
**GAUGE:** 2"

The instructions are the same for all sizes. **PATTERN:** Stockinette stitch with a Cable Design. **PULLOVER:** The Design is worked over the center 37 sts. on the front section. On every second row, cross the 4th and 5th, 9th and 10th etc. stitches. **CARDIGAN:** FRONT SECTION: After Row 198, cross the 3rd and 4th st. for the point, then bring another Cable stripe after every 6th row. **BACK SECTION:** Begin the Cable Design after Row 246. 1 x 1 Ribbing on lower edge of Pullover. **INCREASES and DECREASES:** Full Fashion (see KNTKING Practical Knitting Hints Book, pages 14 to 17).

**FINISHING:** PULLOVER: Join front and back sections at sides and shoulders. Sew sleeve seams and set in. Sew on neckband with one edge to inside and one to outside of neckline. Work 1 row of single crochet around opening. Make 3 loops and sew on buttons. **CARDIGAN:** Join front and back sections at sides and shoulders. Sew sleeve seams and set in. Sew on button and buttonhole bands with one edge to inside and one edge to outside of front sections. Fold collar in half lengthwise and sew short sides, then sew to neck edge with one side to inside and one to outside, leaving 3/8" free on each front edge. Make 1 1/2" hem on upper edge of pockets then sew to Cardigan. Finish buttonholes and sew on buttons. Hem lower edge and sleeve edges.

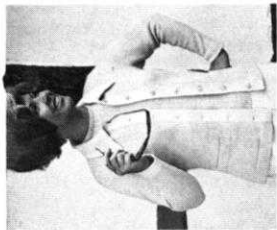

Move the Cam Box to the left side, turn the Row Counter back to 246 and complete the left half. Follow the instructions from \*.

**ON CAM BOX SIDE,** bind off 5 sts. after Row 264; 4 sts. after Rows 266, 268, 270, 272, 276, 278, 280, 282.  
\***ON CAM BOX SIDE,** bind off 4 sts. after Row 247; 3 sts. after Rows 249, 251; 2 sts. after Rows 253, 255; 1 st. after Rows 257, 259, 261, 263.

**ON CAM BOX SIDE,** bind off 4 sts. after Rows 172, 173, 174, 175; 3 sts. after Rows 176, 177, 178, 179; 2 sts. after Rows 180, 181, 182, 183, 184, 185. **ON EACH SIDE,** decrease 1 st. after Rows 186, 188, 190, 192, 194, then knit to Row 246, bind off the center 15 sts., put the needles on the left side into holding position and complete the right half first.

**ON OPPOSITE SIDE OF CAM BOX,** put into holding position 5 needles after Rows 136, 137, 138, 139, 140, 141, 142, 143, 144, 145, 146, 147, 148, 149, 150, 151, 152, 153. **ON OPPOSITE SIDE OF CAM BOX,** bring all the needles back into working position after Rows 154, 155, then knit to Row 172.

**ON EACH SIDE,** increase 1 st. after Rows 70, 82, 94, 104, 114, 124, 134. After Row 136, work Short Rows. Rows 21 to 70: Knit even.

Rows 0 to 20: Knit even, then change to Stockinette stitch and begin the Cable Design over the center 37 sts.

Cast on 169 sts. and work K1, P1 Ribbing.

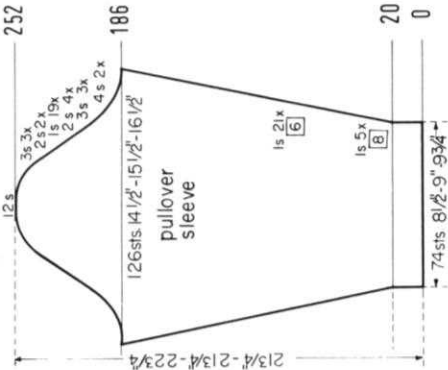
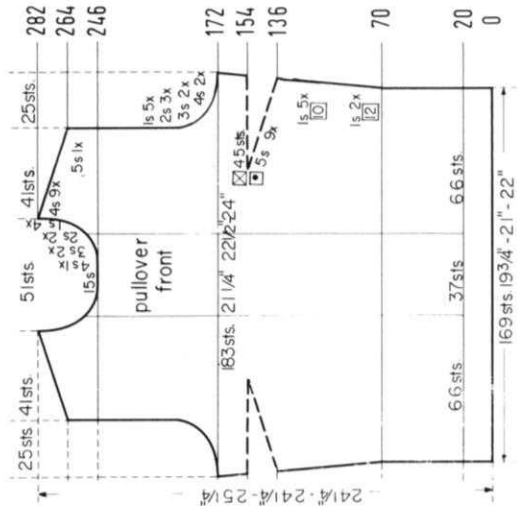

**ON CAM BOX SIDE,** bind off 4 sts. after Rows 186, 187, 188, 189; 3 sts. after Rows 190, 191, 192, 193, 194, 195; 2 sts. after Rows 196, 197, 198, 199, 200, 201, 202, 203. **ON EACH SIDE,** decrease 1 st. after Rows 204, 206, 208, 210, 212, 214, 216, 218, 220, 222, 224, 226, 228, 230, 232, 234, 236, 238, 240. **ON CAM BOX SIDE,** bind off 2 sts. after Rows 242, 243, 244, 245; 3 sts. after Rows 246, 247, 248, 249, 250, 251; 12 sts. after Row 252.

**ON EACH SIDE,** increase 1 st. after Rows 20, 28, 36, 44, 52, 60, 66, 72, 78, 84, 90, 96, 102, 108, 114, 120, 126, 132, 138, 144, 150, 156, 162, 168, 174, 180, then knit to Row 186.

Rows 0 to 20: Knit even, then change to Stockinette stitch.

Cast on 74 sts. and work K1, P1 Ribbing.

Move the Cam Box to the left side, turn the Row Counter back to 228 and complete the left half. Follow the instructions from \*.

**ON CAM BOX SIDE,** bind off 5 sts. after Row 246 (EVEN ROWS = SHOULD SHAPING); 4 sts. after Rows 248, 250, 252, 254; 16 sts. (15 sts. for left half) after Row 255 (ODD ROWS = NECK SHAPING); 4 sts. after Row 256; 3 sts. after Row 257; 4 sts. after Row 258; 3 sts. after Row 259; 4 sts. after Row 260; 2 sts. after Row 261; 4 sts. after Row 262; 2 sts. after Row 263; 4 sts. after Row 264.

\* Rows 229 to 246: Knit even.  
**ON CAM BOX SIDE,** bind off 4 sts. after Rows 154, 155, 156, 157; 3 sts. after Rows 158, 159, 160, 161; 2 sts. after Rows 162, 163, 164, 165, 166, 167. **ON EACH SIDE,** decrease 1 st. after Rows 168, 170, 172, 174, 176, then knit to Row 228, put 66 needles on the left side into holding position and complete the right half first.

**ON EACH SIDE,** increase 1 st. after Rows 70, 82, 94, 104, 114, 124, 134, 144, then knit to Row 154.

Rows 21 to 70: Knit even.

Rows 0 to 20: Knit even, then change to Stockinette stitch.

Cast on 169 sts. and work K1, P1 Ribbing.

\* Make 2. Cast on 48 sts. with color 1 and knit 70 rows Stockinette stitch, then bind off all sts.



Move the Cam Box to the left side, turn the Row Counter back to 302 and complete the left half. Follow the instructions from\*.

\*ON CAM BOX SIDE, bind off 4 sts. after Row 302 (EVEN ROWS = SHOULDER SHAPING); 4 sts. after Row 303 (ODD ROWS = NECK SHAPING); 4 sts. after Row 304; 4 sts. after Row 305; 4 sts. after Row 306; 2 sts. after Row 307; 4 sts. after Row 308; 2 sts. after Row 309; 4 sts. after Rows 310, 312.

ON CAM BOX SIDE, bind off 5 sts. after Rows 294, 295; 4 sts. after Rows 296, 297, 298, 299, 300, 301. After Row 302, bind off the center 30 sts., put the needles on the left side into holding position and complete the right half first.

Rows 246 to 294: Knit even.

ON CAM BOX SIDE, bind off 5 sts. after Rows 198, 199, 200, 201; 3 sts. after Rows 202, 203, 204, 205; 2 sts. after Rows 206, 207, 208, 209, 210, 211. ON EACH SIDE, decrease 1 st. after Rows 212, 214, 216, 218, 220. Knit to Row 246, then begin the Cable Design.

ON EACH SIDE, increase 1 st. after Rows 124, 134, 144, 152, 160, 168, 176. Knit to Row 198.

ON EACH SIDE, decrease 1 st. after Rows 48, 54, 60, 66, 72, 78, 84, 90, 96, 102, then knit to Row 124.

Rows 0 to 48: Knit even.

Cast on 196 sts. with color 1 and work Stockinette stitch.

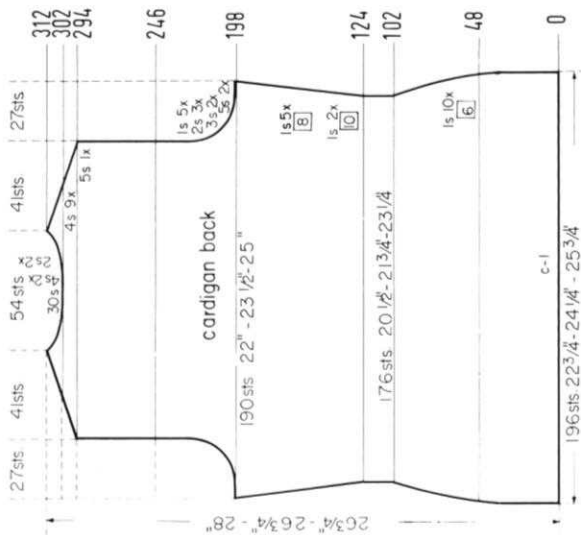

Work the second front section with reverse shaping, casting on from right to left. Cam Box will be on the left side at Row 0.

ON CAM BOX SIDE, bind off 5 sts. after Row 312; 4 sts. after Rows 314, 316, 318, 320, 322, 324, 326, 328, 330. ON CAM BOX SIDE, bind off 4 sts. after Row 283; 3 sts. after Rows 285, 287; 2 sts. after Rows 289, 291, 293; 1 st. after Rows 295, 297, 299, 301, 303, then knit to Row 312.

ON CAM BOX SIDE, bind off 5 sts. after Rows 216, 218; 3 sts. after Rows 220, 222; 2 sts. after Rows 224, 226, 228; 1 st. after Rows 230, 232, 234, 236, 238, then knit to Row 283.

ON OPPOSITE SIDE OF CAM BOX, put into holding position, 4 needles after Rows 181, 183, 185, 187, 189, 191, 193, 195, 197. After Row 198, begin the Cable design and after Row 199, bring all the needles back into working position, then knit to Row 216.

ON CAM BOX SIDE, increase 1 st. after Rows 124, 134, 144, 152, 160, 168, 176. Knit to Row 181, then work Short Rows.

ON CAM BOX SIDE, decrease 1 st. after Rows 48, 54, 60, 66, 72, 78, 84, 96, 102. Knit to Row 124.

Rows 0 to 48: Knit even.

Cast on 92 sts. with color 1 and work Stockinette stitch.



ON EACH SIDE, decrease 1 st. after Rows 52, 54, 56, 58, 60, 62, 64, 66, 70, 74, 78, 82, 86. Knit to Row 92, then bind off all sts.

ON EACH SIDE, increase 1 st. after Rows 12, 16, 20, 24, 28, 32, 36, 38, 40, 42, 44, 46, 48. Knit to Row 52.

ON OPPOSITE SIDE OF CAM BOX, put into holding position, 45 needles at Rows 0 and Row 1. ON OPPOSITE SIDE OF CAM BOX, bring back into working position 15 needles after Rows 2, 3, 4, 5, 6, 7.

Cast on 144 sts. with color 2 and work Stockinette stitch and Short Rows.

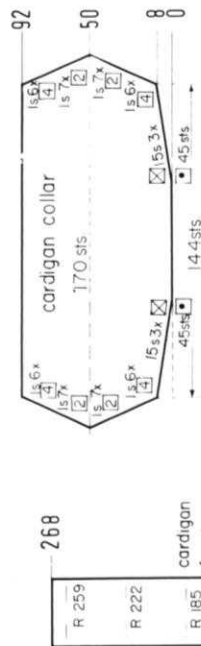

Make Buttonholes over needles 3 to 8 and 21 to 26 (counting from the left edge) after Rows 37, 74, 111, 148, 185, 222, 259. Knit to Row 268, then bind off all sts. Make the Button Band the same but omit the Buttonholes.

Cast on 28 sts. with color 2 and work Stockinette stitch.

Cast on 129 sts. and work 14 rows Stockinette stitch, then bind off all sts.

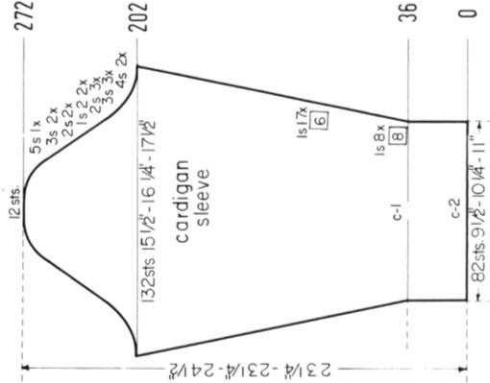

ON CAM BOX SIDE, bind off 4 sts. after Rows 202, 203, 204, 205; 3 sts. after Rows 206, 207, 208, 209, 210, 211; 2 sts. after Rows 212, 213, 214, 215, 216, 217. ON EACH SIDE, decrease 1 st. after Rows 218, 220, 222, 224, 226, 228, 230, 232, 234, 236, 238, 240, 242, 244, 246, 248, 250, 252, 254, 256, 258, 260. ON CAM BOX SIDE, bind off 2 sts. after Rows 262, 263, 264, 265; 3 sts. after Rows 266, 267, 268, 269; 5 sts. after Rows 270, 271; 12 sts. after Row 272.

ON EACH SIDE, increase 1 st. after Rows 36, 44, 52, 60, 68, 76, 84, 92, 98, 104, 110, 116, 122, 128, 134, 140, 146, 152, 158, 164, 170, 176, 182, 188, 194, then knit to Row 202.

Rows 0 to 36: Knit even, then change to Color 1.

Cast on 82 sts. with Color 2 and work Stockinette st.

- SIZE:** 8 (Bust 31 1/2"-32 1/2") 12 (Bust 34"-35") 16 (Bust 38"-39")
- YARN:** 50gr. balls
- TENSION:** 2" 18 sts, 26 rows
- GAUGE:** 2" 17 sts, 26 rows
- |                     |                 |                 |                 |
|---------------------|-----------------|-----------------|-----------------|
| Fortissima Pullover | 1 C-1           | 1 C-1           | 1 C-1           |
|                     | 2 C-2           | 2 C-2           | 2 C-2           |
|                     | 4 C-3           | 4 C-3           | 4 C-3           |
|                     | 1 C-4           | 1 C-4           | 1 C-4           |
| Vest                | 1 C-4           | 1 C-4           | 1 C-4           |
|                     | 4 C-1           | 4 C-1           | 5 C-1           |
|                     | 3 C-2           | 4 C-2           | 5 C-2           |
|                     | 4 C-3           | 4 C-3           | 5 C-3           |
|                     | 3 C-4           | 4 C-4           | 4 C-4           |
|                     | 2 to 4          | 4 to 6          | 6 to 8          |
|                     | 18 sts, 26 rows | 17 sts, 26 rows | 15 sts, 24 rows |

The instructions are the same for all sizes. **PATTERN:** Stockinette stitch with color stripes as shown on the Charts. Bands are ribbed. **INCREASES and DECREASES:** Full Fashion (see KNITTING Practical Knitting Hints Book, pages 14 to 17).

**FINISHING:** Block all sections. **PULLOVER:** Join front to back at side seams and shoulders. Sew sleeve seams and set in. Join neckband into a circle and sew to neck edge. For the Belt, make a twisted cord from 12 strands of yarn and sew a tassel to each end (see KNITTING Practical Knitting Hints Book, page 58). **VEST:** Weave the seams of the back sections together 1 st. in from each edge. Join fronts to back at side seams and shoulders. Make a 3/8" hem around armholes. Join neck facing at center back then sew to neck edge. Fold neck and front facings 1 1/4" to inside and hem in place. Join all sections of edging and sew to front and neck edge at the folded line, working 4 buttonholes on the right side. Make first buttonhole about 2" below the waistline by leaving 3/4" open. The following buttonholes are about 2 1/4" apart. Finish buttonholes, sew on buttons.

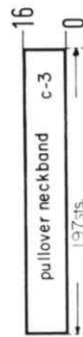

Cast on 197 sts, with color 3 and work 16 rows K1, P1 Ribbing, then bind off all sts.

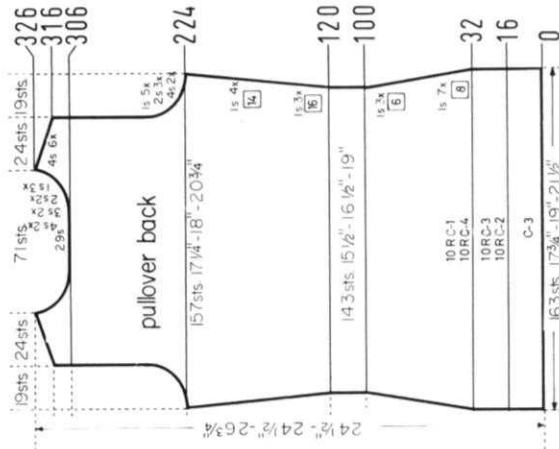

Move the Cam Box to the left side, turn the Row Counter back to 306 and complete the left half. Follow the instructions from\*.

\*ON CAM BOX SIDE, bind off 4 sts. after Rows 307, 309 (ODD ROWS = NECK SHAPING); 3 sts. after Rows 311, 313; 2 sts. after Row 315; 4 sts. after Row 316 (EVEN ROWS = SHOULDER SHAPING); 2 sts. after Row 317; 4 sts. after Row 318; 1 st. after Row 319; 4 sts. after Row 320; 1 st. after Row 321; 4 sts. after Row 322; 1 st. after Row 323; 4 sts. after Rows 324, 326.

ON CAM BOX SIDE, bind off 4 sts. after Rows 224, 225, 226, 227; 2 sts. after Rows 228, 229, 230, 231, 232, 233. ON EACH SIDE, decrease 1 st. after Rows 234, 236, 238, 240, 242, then knit to Row 306 (282 on front section), bind off the center 29 sts., put the needles on the left side into holding position and complete the right side first.

ON EACH SIDE, increase 1 st. after Rows 120, 136, 152, 168, 182, 196, 210, then knit to Row 224.

ON EACH SIDE, decrease 1 st. after Rows 32, 40, 48, 56, 64, 72, 80, 88, 94, 100. Knit to Row 120.

Rows 17 to 32: Knit even.

Rows 0 to 16: Knit even, then change to Stockinette stitch and work the color stripes as shown on the Chart.

Cast on 163 sts, with color 3 and work K1, P1 Ribbing.

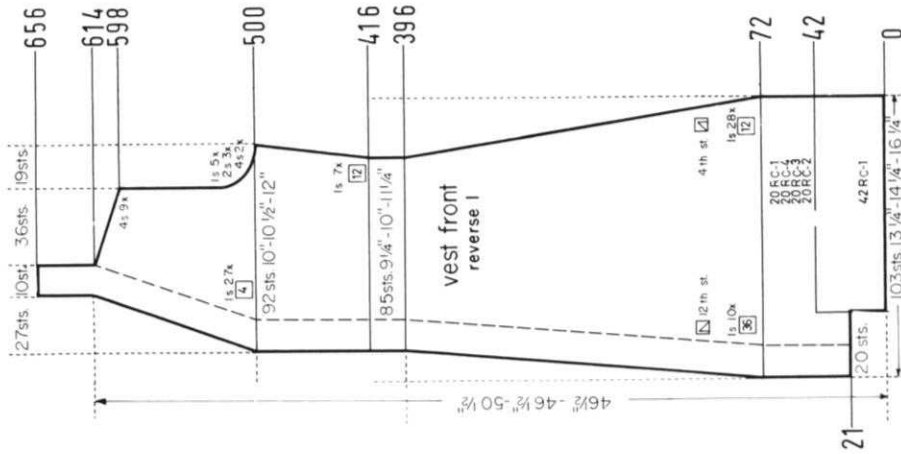
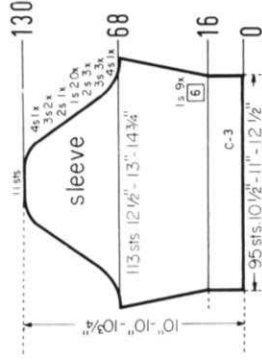
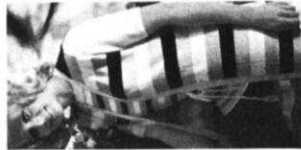

Work the second front section with reverse shaping, casting on from RIGHT to LEFT. Cam Box will be on the left side at Row 0.

Continue to decrease 1 st. on OPPOSITE SIDE OF CAM BOX after Rows in ( ). ON CAM BOX SIDE, bind off 4 sts. after Rows 598, 600, (600), 602, 604, (604), 606, 608, 610, 612, 614. Knit to Row 656, then take the remaining 10 sts. off onto a stitch holder.

ON OPPOSITE SIDE OF CAM BOX, decrease 1 st. after Rows in ( ). ON CAM BOX SIDE, bind off 4 sts. after Rows 500, (500), 502; 2 sts. after Rows 504, (504), 506, 508, (508); 1 st. after Rows 510, 512, (512), 514, 516, (516), 518. Continue to decrease 1 st. ON OPPOSITE SIDE OF CAM BOX after Rows 520, 524, 528, 532, 536, 540, 544, 548, 552, 556, 560, 564, 568, 572, 576, 580, 584, 588, 592, 596.

ON CAM BOX SIDE, increase 1 st. after Rows 416, 428, 440, 452, 464, 476, 488, then knit to Row 500.

ON OPPOSITE SIDE OF CAM BOX, decrease 1 st. after Rows in ( ). ON CAM BOX SIDE, decrease 1 st. after Rows 72, (72), 84, 96, 108, (108), 120, 132, 144, (144), 156, 168, 180, (180), 192, 204, 216, (216), 228, 240, 252, (252), 264, 276, 288, (288), 300, 312, 324, (324), 336, 348, 360, (360), 372, 384, 396, (396), then knit to Row 416.

Rows 43 to 72: Knit even.

Rows 22 to 42: Knit even, then begin the color stripes as shown on the Chart.

Rows 0 to 21: Knit even, then cast on 20 sts.

Cast on 103 sts, with color 1 and work Stockinette stitch.

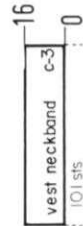

Cast on 101 sts, with color 3 and work 16 rows K1, P1 Ribbing, then bind off all sts.

ON CAM BOX SIDE, bind off 4 sts. after Rows 68, 69; 3 sts. after Rows 70, 71, 72, 73, 74, 75; 2 sts. after Rows 76, 77, 78, 79, 80, 81. ON EACH SIDE, decrease 1 st. after Rows 82, 84, 86, 88, 90, 92, 94, 96, 98, 100, 102, 104, 106, 108, 110, 112, 114, 116, 118, 120. ON CAM BOX SIDE, bind off 2 sts. after Rows 122, 123; 3 sts. after Rows 124, 125, 126, 127; 4 sts. after Rows 128, 129; 11 sts. after Row 130.

ON EACH SIDE, increase 1 st. after Rows 16, 22, 28, 34, 40, 46, 52, 58, 64, then knit to Row 68.

Rows 0 to 16: Knit even, then change to Stockinette stitch.

Cast on 95 sts, with color 3 and work K1, P1 Ribbing.



Move the Cam Box to the left side, turn Row Counter back to 282 and complete the left half. Follow the instructions from \*.

ON CAM BOX SIDE, bind off 4 sts. after Rows 316, 318, 320, 322, 324, 326.

\*ON CAM BOX SIDE, bind off 4 sts. after Rows 283, 285; 3 sts. after Rows 287, 289; 2 sts. after Rows 291, 293; 1 st. after Rows 295, 297, 299, 301, 305, 309, 313. Knit to Row 316.

Work the front section the same as the back section to Row 282, bind off the center 21 sts., put the needles on the left side into holding position and complete the right half first.

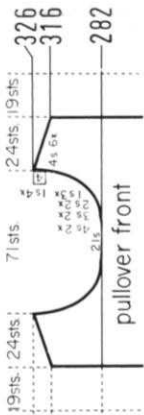

# HP 3663

SIZE: 36 (Chest 35"-36")  
YARN: Subita Crepe 2 x 3  
4 Color 1  
3 Color 2  
3 to 5

TENSION: 2"  
GAUGE: 17 sts, 25 rows

The instructions are the same for all sizes. PATTERN: Stockinette stitch with color stripes of 6 rows color 2, 6 rows color 1 on the front and back sections. Full Fashion INCREASES on Sleeves (see KNITTING Practical Knitting Hints Book, pages 14 to 17).

FINISHING: Block all sections. Join front and back sections at sides and shoulders. Sew sleeves together and set in. Fold front facings 1 1/2" to the wrong side and sew. Make a 1 1/2" hem on upper edge of pockets, sew on 2 buttons then sew pockets to shirt. Sew 1 edge of neckband to inside and one edge to outside of neckline, leaving the right edge with a small opening for buttonhole. Finish buttonholes and sew on buttons.

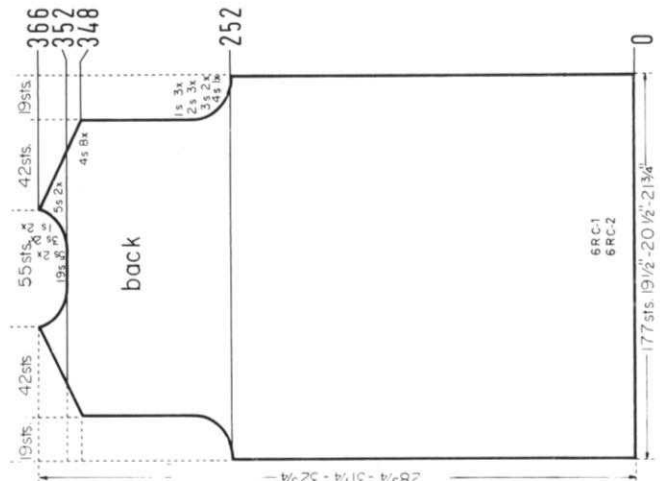

Cast on 196 sts. with color 3 and work 16 rows K1, P1 Ribbing, then bind off all sts. Make 3 more sections the same.

Work the second back section with reverse shaping, casting on from RIGHT to LEFT. Cam Box will be on the left side at Row 0.

ON CAM BOX SIDE, bind off 4 sts. after Row 598 (EVEN ROWS = SHOULDERS SHAPING); 13 sts. after Row 599 (ODD ROWS = NECK SHAPING); 4 sts. after Row 600; 3 sts. after Row 601; 4 sts. after Row 602; 3 sts. after Row 603; 4 sts. after Row 604; 2 sts. after Row 605; 4 sts. after Row 606; 2 sts. after Row 607; 4 sts. after Row 608; 2 sts. after Row 609; 4 sts. after Row 610; 2 sts. after Row 611; 4 sts. after Rows 612, 614.

ON CAM BOX SIDE, bind off 4 sts. after Rows 500, 502; 2 sts. after Rows 504, 506, 508; 1 st. after Rows 510, 512, 514, 516, 518, then knit to Row 598.

ON OPPOSITE SIDE OF CAM BOX, increase 1 st. after Rows in ( ). ON CAM BOX SIDE, increase 1 st. after Rows 416, 418, 420, 422, 424, 426, 428, 430, 432, 434, 436, 438, 440, 442, 444, 446, 448, 450, but do not knit the row after the last increase.

ON OPPOSITE SIDE OF CAM BOX, decrease 1 st. after Rows ( ). ON CAM BOX SIDE, decrease 1 st. after Row 72, (72), 84, 96, (98), 108, 120, (124), 132, 144, (150), 156, 168, (176), 180, 192, (202), 204, 216, 228, (238), 240, 252, (252), 264, 276, (276), 288, 300, (300), 312, 324, (324), 336, 348, (348), 360, 372, (372), 384, 396, (396), then knit to Row 416.

Rows 43 to 72: Knit even.

Rows 0 to 42: Knit even, then begin the color stripes as shown on the Chart.

Cast on 113 sts. with color 1 and work Stockinette stitch.

ON CAM BOX SIDE, bind off 4 sts. after Rows 74, 76, 78, 77; 3 sts. after Rows 78, 80, 81; 2 sts. after Rows 82, 83, 84, 85, 86, 87, 88, 89. ON EACH SIDE, decrease 1 st. after Rows 90, 92, 94, 96, 98, 100, 102, 104, 106, 108, 110, 112, 114, 116, 118, 120, 122, 124, 126. ON CAM BOX SIDE, bind off 2 sts. after Rows 128, 129; 3 sts. after Rows 130, 131, 132, 133; 4 sts. after Rows 134, 135, 136, 137; 12 sts. after Row 138.

ON EACH SIDE, increase 1 st. after Rows 28, 32, 36, 40, 44, 48, 52, 56, 60, 64, 68, then knit to Row 74.

Rows 0 to 28: Knit even.

Cast on 104 sts. with color 1 and work Stockinette stitch.

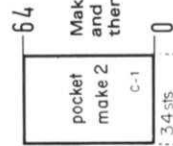

Make 2. Cast on 34 stitches with color 1 and work 64 rows Stockinette stitch, then bind off all stitches.

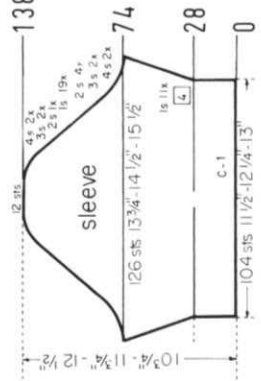

**SIZE:** 10 (Bust 32½"-33") 12 (Bust 34"-35") 14 (Bust 36"-37")  
**YARN:** 50gr. balls Subita Dralon 2 x 4 14 (Bust 36"-37") Sonika Dralon 18  
**TENSION:** 4 to 6 15 sts. 22 rows 6 to 8 14 sts. 21 rows  
**GAUGE:** 2" 16 sts. 23 rows

The instructions are the same for all sizes. **PATTERN:** Stockinette stitch with Cable Stripes on the front sections. **POCKET Edges and lower edge of BERET:** K1, P1 Ribbing. **INCREASES and DECREASES:** Full Fashion (see **KNITTING Practical Knitting Hints Book**, pages 14 to 17). **NECK SHAPING:** On the Front section: ALL decreases of 1 st. after ODD ROWS are for the Neck Shaping. After Rows indicated, always hang the 26th st. onto the 25th st. then move the end sts. inward to fill the empty needle.

**FINISHING:** Block all sections. Join front and back sections at sides and shoulders, easing in the fullness at the bustline of front sections. Sew sleeves together and set in. Turn under 17 rows on lower edge and sleeve edges and hem. Weave open sts. of neckband together, then sew band to neckline. Turn under 12 sts. around front edges and neckline and hem. Sew pockets to coat (see picture). Finish buttonholes, sew on buttons. Weave Beret sections together, 1 st. in on each edge, making sure that the ribbed edge is a continuous K1, P1 Rib.



### CABLE DESIGN

- Of the 15 Cable Stitches, let the 8th st. slide off the needle, leave empty needle in working position. 2. With 2 double transfer tools, hang the 6th and 7th sts. onto the 4th and 5th needles and the 4th and 5th sts. onto the 6th and 7th needles. Hang the 9th and 10th sts. onto the 11th and 12th needles and the 11th and 12th sts. onto the 9th and 10th needles. 3. Knit 2 rows. 4. Let the 1st and 15th sts. slide from the needles, leave empty needles in working position. 5. Hang the 4th and 5th sts. onto the 2nd and 3rd needles and the 2nd and 3rd sts. onto the 4th and 5th needles. Hang the 11th and 12th sts. onto the 13th and 14th needles and the 13th and 14th sts. onto the 11th and 12th needles. 6. Knit 16 rows. Repeat Steps 1 to 6 throughout. After each 30-40 rows, let the 1st, 8th and 15th sts. slide from the needles, allow to run down (the first time down to Row 176), then latch up into knit sts. Cross the inner Cable sts. the first time after Row 184, the outer Cable sts. after Row 186.

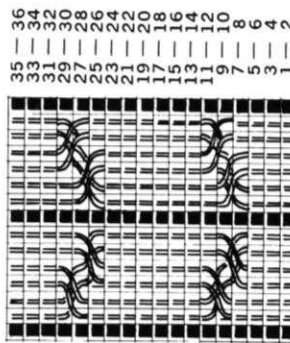

Rows 67 to 86: Knit even, then bind off the crochet method for ribbing.

Rows 0 to 66: Knit even, then transfer every other st. to the Ribber and continue with K1, P1, Ribbing.

Make 2. Cast on 49 sts. and work stockinette st.

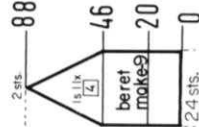
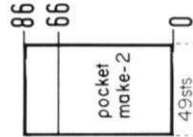

ON EACH SIDE, decrease 1 st. after Rows 46, 50, 54, 58, 62, 66, 70, 74, 78, 82, 86, and after Row 88, bind off the remaining 2 sts.

Knit even to Row 46.

Rows 0 to 20: Work K1, P1, Ribbing, then change to stockinette st.

Make 9. Use the Ribber and cast on 24 sts., having 2 sts. on the right side on the Main machine.

Make the right front section with reverse shaping, casting on from left to right. Cam Box will be on the right side at Row 0. Omit the buttonholes.

ON CAM BOX SIDE, bind off 4 sts. after Rows 348, 350, 352, 354, 356, 358, 360, 362; 5 sts. after Rows 364, 366.

ON CAM BOX SIDE, bind off 27 sts. after Row 317; 3 sts. after Rows 319, 321; 2 sts. after Rows 323, 325, 327; 1 st. after Rows 329, 331, 333, 335, 337, 339, 343, 347.

ON CAM BOX SIDE, bind off 4 sts. after Row 252; 3 sts. after Rows 254, 256; 2 sts. after Rows 258, 260, 262; 1 st. after Rows 264, 266, 268. Knit to Row 285 and make buttonholes as you did before, then knit to Row 317.

Rows 19 to 252: Knit even, but make buttonholes over needles 3 to 7 and 21 to 25 (counting from the right edge) after Rows 33, 69, 105, 141, 177, 213, 249. Knit to Row 252.

Rows 0 to 18: Knit even, then using a separate strand of yarn, cast on 27 sts. on the RIGHT SIDE. (LEFT side for second section).

Cast on 81 sts. from RIGHT to LEFT with color 2 and work Stockinette stitch and color stripes as shown on the Chart. (Cam Box will be on the LEFT side at Row 0).

Cast on 153 sts. with color 1 and work 14 rows Stockinette stitch, then bind off all sts.

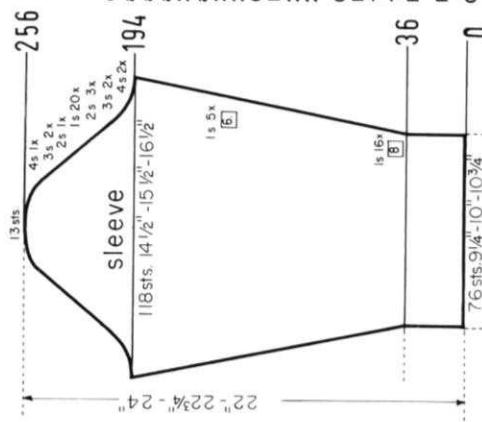
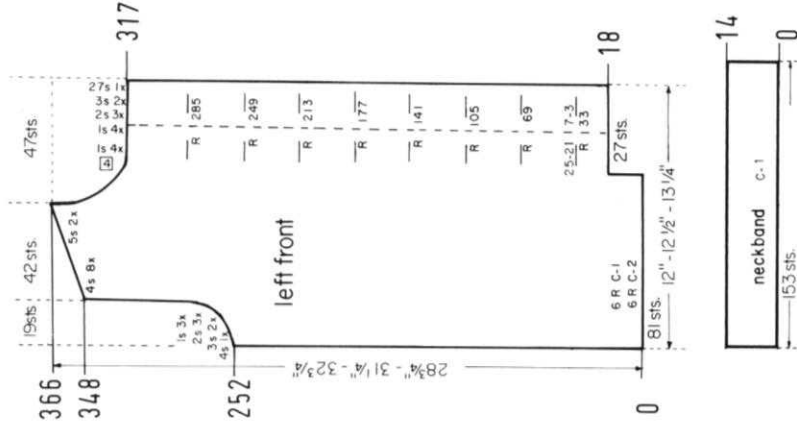

ON CAM BOX SIDE, bind off 4 sts. after Rows 194, 195, 196, 197; 3 sts. after Rows 198, 199, 200, 201; 2 sts. after Rows 202, 203; 204, 205, 206, 207. ON EACH SIDE, bind off 1 st. after Rows 208, 210, 212, 214, 216, 218, 220, 222, 224, 226, 228, 230, 232, 234, 236, 238, 240, 242, 244, 246. ON CAM BOX SIDE, bind off 2 sts. after Rows 248, 249; 3 sts. after Rows 250, 251, 252, 253; 4 sts. after Rows 254, 255; 14 sts. after Row 256.

ON EACH SIDE, increase 1 st. after Rows 36, 44, 52, 60, 68, 76, 84, 92, 100, 108, 116, 124, 132, 140, 148, 156, 164, 170, 176, 182, 188, then knit to Row 194.

Rows 0 to 36: Knit even.

Cast on 76 sts. and work stockinette st.





# DK 8036

**SIZE:** 8 (Bust 31 1/2"-32") 10 (Bust 32 1/2"-33") 16 (Bust 38"-39")  
**YARN:** Gardenia Baby 12 Subita Dralon 3-ply 10 Sonika Dralon 13  
**TENSION:** 50gr. balls 6 to 8 7 to 9  
**GAUGE:** 2" 15 sts, 21 rows 13 sts, 20 rows

The instructions are the same for all sizes. **PATTERN:** Stockinette stitch, INCREASES and DECREASES: Full Fashion (see **KNITTING Practical Knitting Hints Book**, pages 14 to 17). **FINISHING:** Block all sections. Join front and back sections at sides and shoulders. Sew sleeves together and set in. Make a 1 1/4" hem on lower edge of dress and sleeves. Work 1 row of single crochet around opening and neck edge then 1 row of reverse single crochet. Knit a round cord for the bow over 3 needles, using tension 1. Knit 1320 rows (empty rows do count). See your instruction manual for knitting a round cord. Make bows (see illustration) then sew on dress.

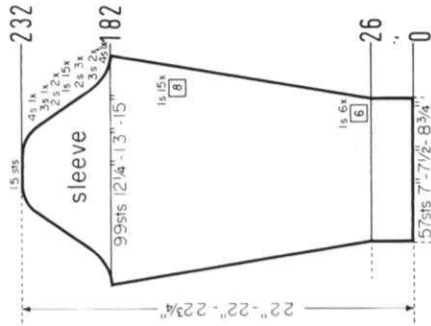
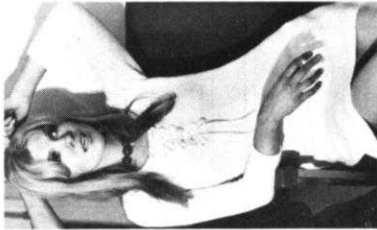

**ON CAM BOX SIDE, bind off 4 sts.** after Rows 182, 183; 3 sts. after Rows 184, 185, 186, 187; 2 sts. after Rows 188, 189, 190, 191, 192, 193. **ON EACH SIDE, decrease 1 st.** after Rows 194, 196, 198, 200, 202, 204, 206, 208, 210, 212, 214, 216, 218, 220, 222. **ON CAM BOX SIDE, bind off 2 sts.** after Rows 224, 225, 226, 227; 3 sts. after Rows 228, 229; 4 sts. after Rows 230, 231; 15 sts. after Row 232.

**ON EACH SIDE, increase 1 st.** after Rows 26, 32, 38, 44, 50, 56, 62, 70, 78, 86, 94, 102, 110, 118, 126, 134, 142, 150, 158, 166, 174. Knit to Row 182.

**Rows 0 to 26:** Knit even.  
**Cast on 57 sts.** and work Stockinette stitch.

# HP 3658

**SIZE:** 36 (Chest 35"-36") 38 (Chest 38"-39") 42 (Chest 41"-42")  
**YARN:** Subita Crepe 2 x 4 4 C-1 Sonika Dralon 5 C-1  
**TENSION:** 50gr. balls 3 C-2 4 C-2  
**GAUGE:** 2" 6 to 8 7 to 9 13 sts, 21 rows

The instructions are the same for all sizes. **PATTERN:** Stockinette stitch with color stripes of 16 rows of each color. Bands are ribbed. **INCREASES and DECREASES:** Full Fashion (see **KNITTING Practical Knitting Hints Book**, pages 14 to 17).

**FINISHING:** Join front and back at side seams and shoulders. Join neck and armhole bands into circles and sew to Vest.

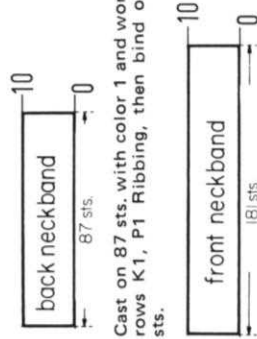

**Cast on 87 sts.** with color 1 and work 10 rows K1, P1 Ribbing, then bind off all sts.

**Cast on 181 sts.** with color 1 and work 10 rows K1, P1 Ribbing, then bind off all sts.

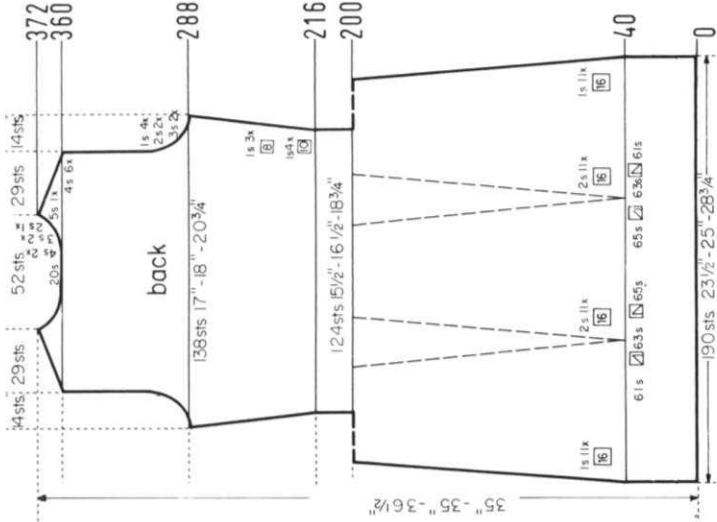

Move the Cam Box to the left side, turn the Row Counter back to 360 and complete the left half. Follow the instructions from \*.

\***ON CAM BOX SIDE, bind off 4 sts.** after Row 360 (EVEN ROWS = SHOULDER SHAPING); 4 sts. after Row 361 (ODD ROWS = NECK SHAPING); 4 sts. after Rows 362, 363, 364; 3 sts. after Row 365; 4 sts. after Row 366; 3 sts. after Row 367; 4 sts. after Row 368; 2 sts. after Row 369; 4 sts. after Row 370; 5 sts. after Row 372.

**ON CAM BOX SIDE, bind off 3 sts.** after Rows 288, 289, 290, 291; 2 sts. after Rows 292, 293, 294, 295. **ON EACH SIDE, decrease 1 st.** after Rows 296, 298, 300, 302, then knit to Row 360, bind off the center 20 sts., put the needles on the left side into holding position and complete the right half first.

**ON EACH SIDE, increase 1 st.** after Rows 216, 226, 236, 246, 256, 264, 272, then knit to Row 288.

**Rows 201 to 216:** Knit even.

**ON EACH SIDE, decrease 1 st.** and at the same time decrease 2 sts. for EACH DART after Rows 40, 56, 72, 88, 104, 120, 136, 152, 168, 184, 200.

**Rows 0 to 40:** Knit even.

**Cast on 190 sts.** and work Stockinette stitch.

Move the Cam Box to the left side, turn the Row Counter back to 254 and complete the left half. Follow the instructions from \*.

**ON CAM BOX SIDE, bind off 4 sts.** after Rows 370, 372, 374, 376, 378, 380; 5 sts. after Row 382.

**ON CAM BOX SIDE, bind off 3 sts.** after Rows 298, 300; 2 sts. after Rows 302, 304; 1 st. after Rows 306, 308, 310, 312. Knit to Row 317 and bind off 8 sts. for Neck. Bind off 3 sts. after Rows 319, 321; 2 sts. after Rows 323, 325, 327; 1 st. after Rows 329, 331, 333, 335, 339, 343. Knit to Row 370.

**ON OPPOSITE SIDE OF CAM BOX, put into holding position, 6 needles** after Rows 273, 275, 277, 279, 281. After Row 283, bring all the needles back into working position and knit to Row 298.

\***ON CAM BOX SIDE, increase 1 st.** after Row 256, 264, 272. After Row 273, work Short Rows.

**ON EACH SIDE, increase 1 st.** after Rows 216, 226, 236, 246. Knit to Row 254, put 66 needles on the left side into holding position and complete the right half first.

Work the front section the same as the back section to Row 216.

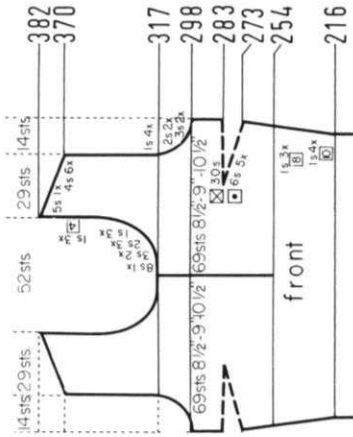



Move the Cam Box to the left side, turn the Row Counter back to 242 and complete the left half. Follow the instructions from \*.

\*ON CAM BOX SIDE, bind off 4 sts. after Row 243 (ODD ROWS = NECK SHAPING); 3 sts. after Rows 245, 247, 249; 2 sts. after Rows 251, 253, 4 sts. after Row 254 (EVEN ROWS = SHOULDER SHAPING); 2 sts. after Row 257; 4 sts. after Row 258; 1 st. after Row 259; 4 sts. after Row 260; 5 sts. after Row 262.

ON CAM BOX SIDE, bind off 5 sts. after Rows 154, 155; 3 sts. after Rows 156, 157, 158, 159; 2 sts. after Rows 160, 161, 162, 163, 164, 165. ON EACH SIDE, decrease 1 st. after Rows 166, 168, 170, 172, 174, then knit to Row 242, bind off the center 18 sts., put the needles on the left side into holding position and complete the right half first.

ON EACH SIDE, increase 1 st. after Rows 66, 88, 110, 132, then knit to Row 154.

Rows 0 to 18: Knit even, then change to Stockinette stitch and color stripes of 16 rows color 2, 16 rows color 1.

Cast on 138 sts. with color 1 and work K1, P1 Ribbing.

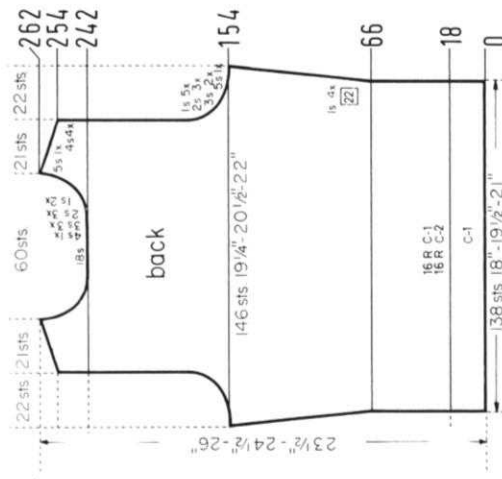

## DK 8012

**SIZE:** 10 (Bust 32 1/2"-33")  
**YARN:** 50gr. balls  
 Fortissima 11 C-1  
 3 C-2  
 3 C-3  
 4 to 6

**TENSION:** 2"  
 Stock. 17 sts. 23 rows  
 Ribbing: 16 sts. 25 rows

**12 (Bust 34"-35")**  
 Subita Dralon 3-ply 9 C-1  
 3 C-2  
 3 C-3  
 5 to 7

**14 (Bust 36"-37")**  
 Subita Dralon 3-ply 9 C-1  
 3 C-2  
 3 C-3  
 6 to 8

**15 sts. 21 rows**  
**15 sts. 23 rows**

The instructions are the same for all sizes. **PATTERN:** Stockinette stitch for Pants; K1, P1 Ribbing with color stripes as shown on Chart, for Pullover. **INCREASES and DECREASES:** Full Fashion (see **KNITTING Practical Knitting Hints Book**, pages 14 to 17), for Stockinette stitch and on the edges for the Ribbing.

**FINISHING:** PANTS: Join front and back and leg seams. Fold in half, then make hem at top of pants. Insert elastic at waist and sew 2 buttons on band. Turn under and hem legs. **PULLOVER:** Join front and back at sides and shoulders. Sew sleeve seams and set in. Work 1 row of single crochet around neck edge, sleeves edges and across top stripe then continue crocheting as follows: Row 2: 1 single crochet into 1st single crochet; 5 double crochet into 3rd st.; 1 single crochet into 5th st.; 5 double crochet into 7th st., etc. Row 3: 1 single crochet into each stitch on previous row with 1 picot into the 3rd st. of each of the 5 double crochet stitches. To make picot, chain 3, slip stitch into 1st chain.



Make 2. Cast on 187 sts. with color 1 and work 10 rows K, P1 Ribbing, then bind off all sts.

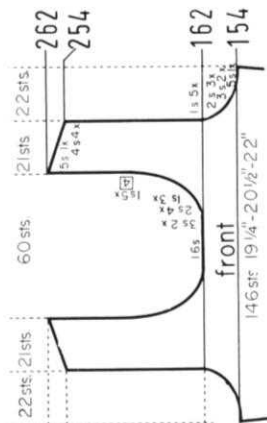

Move the Cam Box to the left side, turn the Row Counter back to 162 and complete the left half. Follow the instructions from \*.

ON CAM BOX SIDE, bind off 4 sts. after Rows 254, 256, 258, 260; 5 sts. after Row 262.

\*ON CAM BOX SIDE, bind off 2 sts. after Row 162 (EVEN ROWS = ARM-HOLE SHAPING); 3 sts. after Row 163 (ODD ROWS = NECK SHAPING); 2 sts. after Row 164; 3 sts. after Row 165; 1 st. after Row 166; 2 sts. after Row 167; 1 st. after Row 168; 2 sts. after Row 169; 1 st. after Row 170; 2 sts. after Row 171; 1 st. after Row 172; 2 sts. after Row 173; 1 st. after Rows 174, 175, 177, 179, 181, 185, 189, 193, 197, then knit to Row 254.

ON CAM BOX SIDE, bind off 5 sts. after Rows 154, 155; 3 sts. after Rows 156, 157, 158, 159; 2 sts. after Rows 160, 161. After Row 162, bind off the center 16 sts. put the needles on the left side into holding position and complete the right half first.

Work the front section the same as the back section to Row 154.

Move the Cam Box to the left side, turn the Row Counter back to 292 and complete the left half. Follow the instructions from \*.

\*ON CAM BOX SIDE, bind off 3 sts. after Row 292 (EVEN ROWS = SHOULDER SHAPING); 4 sts. after Row 293 (ODD ROWS = NECK SHAPING); 3 sts. after Row 294; 4 sts. after Row 295; 3 sts. after Row 296; 3 sts. after Row 297; 3 sts. after Row 298; 3 sts. after Row 299; 3 sts. after Row 300; 2 sts. after Row 301; 3 sts. after Row 302; 2 sts. after Row 303; 3 sts. after Row 304; 2 sts. after Row 305; 3 sts. after Row 306; 4 sts. after Row 308.

ON CAM BOX SIDE, bind off 4 sts. after Rows 198, 199; 3 sts. after Rows 200, 201, 202, 203; 2 sts. after Rows 204, 205, 206, 207; 1 st. after Rows 208, 209, 210, 211, 212, 213, 214, 215, then knit to Row 292 (240 for front section), bind off the center 21 sts., put the needles on the left side into holding position and complete the right half first.

Rows 0 to 198: Knit even.  
 Cast on 153 sts. with color 3 and work K1, P1 Ribbing with color stripes of 30 rows color 3, 30 rows color 2, 30 rows color 1.

Continued on next page

Move the Cam Box to the left side, turn the Row Counter back to 240 and complete the left half. Follow the instructions from \*.

ON CAM BOX SIDE, bind off 3 sts. after Rows 292, 294, 296, 298, 300, 302, 304, 306; 4 sts. after Row 308.

\*ON CAM BOX SIDE, bind off 4 sts. after Rows 241, 243; 2 sts. after Rows 245, 247, 249, 251; 1 st. after Rows 253, 255, 257, 259, 261, then knit to Row 292.

Work the front section the same as the back section to Row 240, bind off the center 19 sts., put the needles on the left side into holding position and complete the right half first.

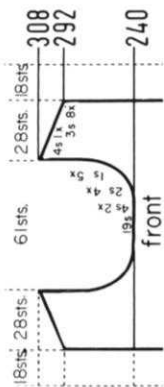

# DK 8006

SIZE:  
YARN:

50gr. balls

- 10 (Bust 32 1/2"-33") Excelsior
- 14 Main Color
- 6 Contrast Color
- 4 to 6
- 15 sts. 23 rows Stock.
- 15 sts. 20 rows Pattern
- 14 sts. 22 rows
- 14 sts. 18 rows
- 14 (Bust 36"-37") Excelsior
- 16 Main Color
- 7 Contrast Color
- 5 to 7

TENSION:  
GAUGE:

- 15 sts. 23 rows
- 15 sts. 20 rows
- 14 sts. 22 rows
- 14 sts. 18 rows

The instructions are the same for both sizes. **PATTERN:** Stockinette stitch and Norwegian Design. Follow the Chart or use JAC 40 and Pattern No. 418. In the instructions, each row in the Norwegian Design is counted as 1 row, but several movements of the Cam Box are needed to complete 1 row. **INCREASES and DECREASES:** Full fashion on stockinette stitch; on the edges for the Pattern Design. (see **KNITTING Practical Knitting Hints Book**, pages 14 to 17).

**FINISHING:** Block all sections. Join front to back at side seams and shoulders, easing the fullness at bustline of front section. Sew Sleeve seams and set in. Gather lower edge of sleeve to measure 7". Sew short ends of cuffs to form circles, then sew to sleeve with one side inside and one side to the outside of sleeve edge. Sew Collar to neck edge in the same way. Work 1 row of single crochet around edges of opening, then sew in zipper. Join skirt sections, gather to fit, then sew to bodice; Turn under and sew hem.

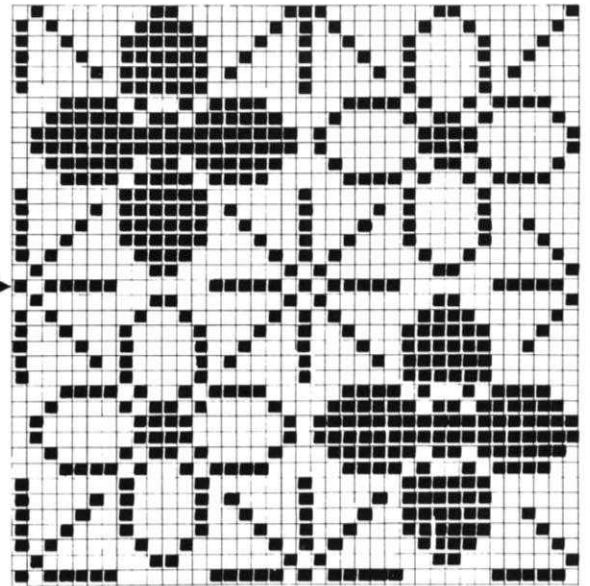

■ CONTRAST COLOR  
□ MAIN COLOR

ON CAM BOX SIDE, bind off 4 sts. after Rows 84, 86; 3 sts. after Rows 86, 87, 88, 89; 2 sts. after Rows 90, 91, 92, 93, 95, 96, 97. ON EACH SIDE, decrease 1 st. after Rows 98, 100, 102, 104, 106, 108, 110, 112, 114, 116, 118, 120, 122, 124, 126, 128, 130, 132, 134. ON CAM BOX SIDE, bind off 2 sts. after Rows 136, 137, 138, 139, 140, 141; 3 sts. after Rows 142, 143, 144, 145; 13 sts. after Row 146.

ON EACH SIDE, increase 1 st. after Rows 6, 12, 18, 24, 30, 36, 42, 48, 54, 60, 66, 72, 78, then knit to Row 84. Rows 0 to 6: Knit even.

Cast on 85 sts. with color 3 and work K1, P1 Ribbing.

Work the second pants section with reverse shaping, casting on from right to left. Cam Box will be on the left side at Row 0.

ON OPPOSITE SIDE OF CAM BOX, put into holding position, 57 needles after Row 442; 8 needles after Rows 444, 446, 448, 450, 452, 454. After Row 456, Bring all the needles back into working position and knit 1 row, then cast on 7 sts. Knit to Row 492 and bind off the remaining 131 sts.

ON CAM BOX SIDE, bind off 4 sts. after Row 350 (EVEN ROWS = CENTER BACK); 3 sts. after Row 351 (ODD ROWS = CENTER FRONT); 3 sts. after Row 352; 2 sts. after Row 353; 3 sts. after Row 354; 2 sts. after Rows 355, 356; 1 st. after Row 357; 2 sts. after Row 358; 1 st. after Row 359; 2 sts. after Row 360; 1 st. after Rows 361, 362, 363, 364, 365, 366, 368, 369, 372, 373, 376, 377, 380, 381, 384, 388. Decrease 2 sts. for the Back Dart after Row 386, then decrease 2 sts. for EACH Dart after Rows in ( ). Continue to decrease 1 st. ON CAM BOX SIDE, after Rows 388, 394, (398), 400, 406, (410), 412, 418, (422), 424, 430, (432), 436, 442, (442), but do not knit after the last decreases. Work Short Rows.

ON OPPOSITE SIDE OF CAM BOX, increase 1 st. after Rows in ( ). ON CAM BOX SIDE, increase 1 st. after Rows 194, (194), 200, (204), 205, 212, (214), 218, 224, (224), 230, (234), 236, 242, (244), 248, 254, (254), 260, (264), 266, 272, (274), 278, 284, (284), 290, (294), 296, 302, (302), 308, (310), 314, (318), 320, 326, (326), 332, (334), 338, 342, (342), 346. Knit to Row 350.

ON EACH SIDE, decrease 1 st. after Rows 36, (begin the color stripes after Row 48), 62, 88, 114, 138. Continue with Color 1 and knit to Row 194.

Row 0 to 36: Knit even.

Cast on 163 sts. with color 1 and work Stockinette stitch.

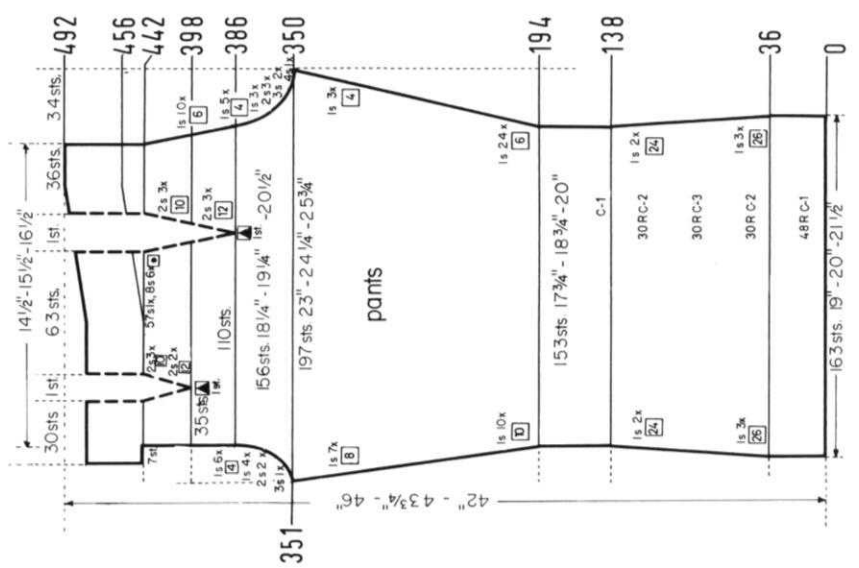



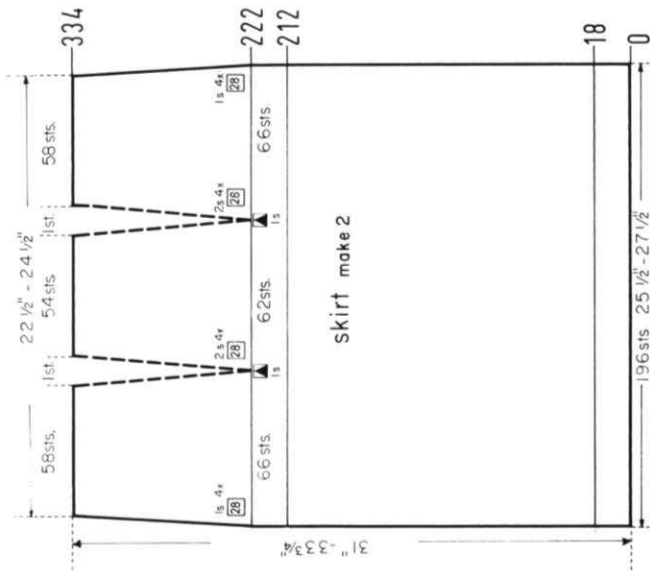

Skirt make 2

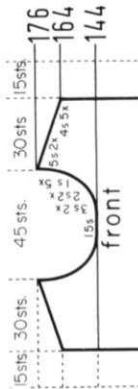

front

ON EACH SIDE, decrease 1 st. and decrease 2 sts. for EACH DART after Rows 222, 250, 278, 306. Knit to Row 334 and bind off the remaining 172 sts. Work the second Skirt section the same.

Rows 19 to 212: Work even, then change to Stockinette stitch and knit to Row 222.

Rows 0 to 18: Knit even, then change to the Norwegian Design.

Cast on 196 sts. and work Stockinette stitch.

NEW!! NEW!! NEW!!

Suitable for all types of knitting machines... even double beds.

\$39.50

F.O.B. Los Angeles  
Calif. residents add 5% Sales Tax



**knitking**

Knitting Machine Table  
48" long, 14" deep  
Walnut finish,  
Mar-proof top.

KNITKING 1128 CRENSHAW BLVD., LOS ANGELES, CALIFORNIA 90019

Bring the needles on the left side into working position, knit 1 row to the left side in PATTERN, turn the Row Counter back to 144 and complete the left half. Follow the instructions from \*.

ON CAM BOX SIDE, bind off 4 sts. after Rows 164, 166, 168, 170, 172; 5 sts. after Row 174, 176.

\* ON CAM BOX SIDE, bind off 3 sts. after Rows 145, 147; 2 sts. after Rows 149, 151; 1 st. after Rows 153, 155, 157, 159, 161. Knit to Row 164.

Work the front section the same as the back section to Row 144, bind off the center 15 sts, put the needles on the left side into holding position and complete the right half first.

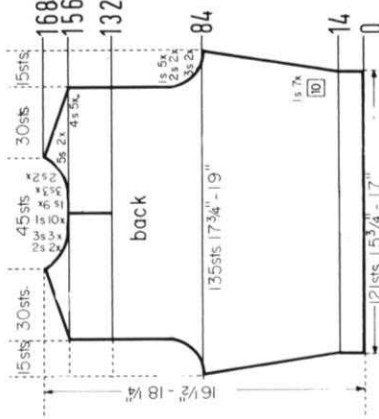

back

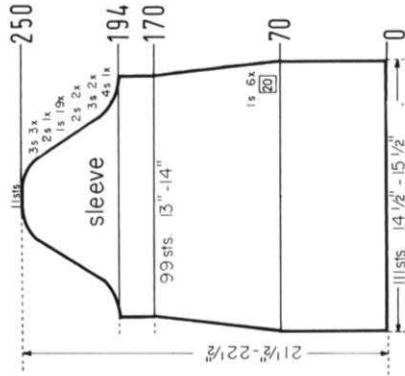

sleeve

neckband

cuff make 2

Bring the needles on the left side into working position, knit 1 row to the left side in PATTERN, turn the Row Counter back to 132 and complete the left half. Follow the instructions from \*.

ON CAM BOX SIDE, bind off 4 sts. after Row 156 (EVEN ROWS = SHOULD SHAPING); 9 sts. (10 sts. for the left half) after Row 157 (ODD ROWS = NECK SHAPING); 4 sts. after Row 158; 3 sts. after Row 159; 4 sts. after Row 160; 3 sts. after Row 161; 4 sts. after Row 162; 3 sts. after Row 163; 4 sts. after Row 164; 2 sts. after Row 165; 5 sts. after Row 166; 2 sts. after Row 167; 5 sts. after Row 168.

\* Rows 133 to 156: Knit even.

ON CAM BOX SIDE, bind off 3 sts. after Rows 84, 85, 86, 87; 2 sts. after Rows 88, 89, 90, 91. ON EACH SIDE, decrease 1 st. after Rows 92, 94, 96, 98, 100 then knit to Row 132. Put 53 needles on the left side into holding position and complete the right half first.

ON EACH SIDE, increase 1 st. after Rows 14, 24, 34, 44, 54, 64, 74, then knit to Row 84 (92 for the front section).

Rows 0 to 14: Knit even.

Cast on 121 sts. and work the Norwegian design.

ON CAM BOX SIDE, bind off 4 sts. after Rows 194, 195; 3 sts. after Rows 196, 197, 198, 199; 2 sts. after Rows 200, 201, 202, 203. ON EACH SIDE, decrease 1 st. after Rows 204, 206, 208, 210, 212, 214, 216, 218, 220, 222, 224, 226, 228, 230, 232, 234, 236, 238, 240. ON CAM BOX SIDE, bind off 2 sts. after Rows 242, 243; 3 sts. after Rows 244, 245, 246, 247, 248, 249; 11 sts. after Row 250.

ON EACH SIDE, decrease 1 st. after Rows 70, 90, 110, 130, 150, 170, then knit to Row 194.

Rows 0 to 70: Knit even.

Cast on 111 sts. and work Stockinette stitch.

Cast on 111 sts. and knit 36 rows Stockinette stitch, then bind off all sts.

Make 2. Cast on 54 sts. and work 46 rows Stockinette stitch, then bind off all sts.

# DK 8007

SIZE: 10 (Bust 32 1/2"-33")  
 12 (Bust 34"-35")  
 20 (Bust 42"-43")

YARN: Subita Crepe 2 x 3  
 Fortissima  
 16 Color 1  
 4 Color 2  
 3 to 5  
 18 sts. 25 rows

TENSION: 2"  
 19 sts. 27 rows

The instructions are the same for all sizes. PATTERN: Stockinette stitch with color stripes on ruffles. INCREASES and DECREASES: Full Fashion (see KNITTING Practical Knitting Hints Book, pages 14 to 17).

FINISHING: Block all sections. Gather ruffle to fit lower edge of sleeve then sew on. Join two sections of skirt ruffle, gather to fit, and attach to lower edge of front of dress, then repeat for back section. Join front to back of dress at side seams and shoulders. Sew seams of sleeves together and set in. Turn under 1 1/4" at lower edge and sleeve edges and hem. Work 2 rows of single crochet around neckline.

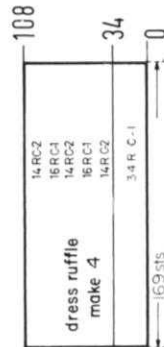
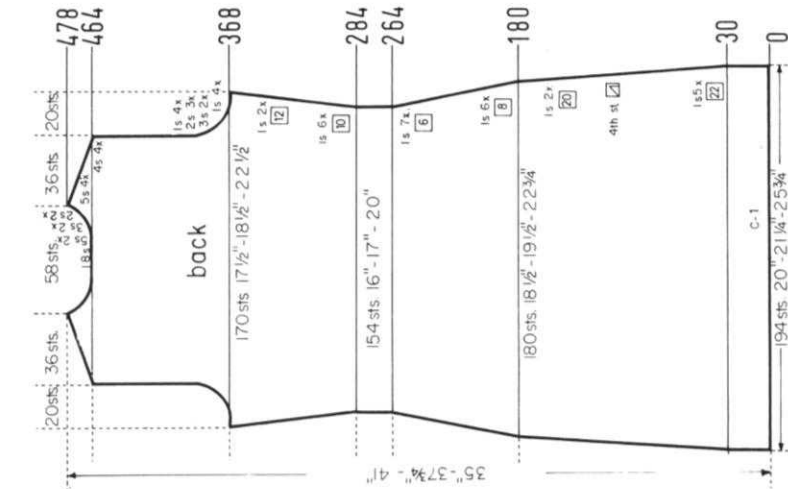

Dress Ruffle. Make 4. Cast on 169 sts. and work Stockinette stitch with color stripes: 34 rows color 1; 14 rows color 2; 16 rows color 1; 14 rows color 2; 16 rows color 1; 14 rows color 2. After Row 108, bind off all sts.

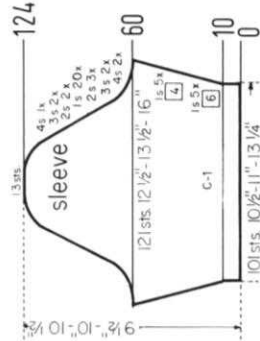
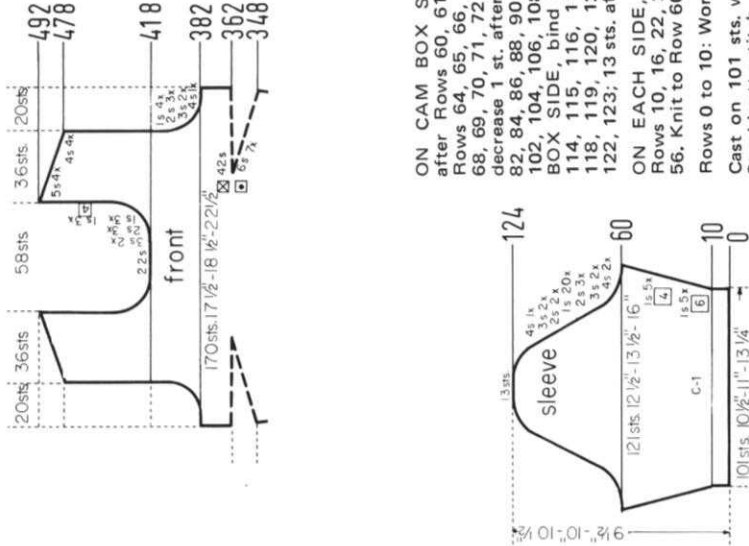

ON CAM BOX SIDE, bind off 4 sts. after Rows 60, 61, 62, 63; 3 sts. after Rows 64, 65, 66, 67; 2 sts. after Rows 68, 69, 70, 71, 72, 73. ON EACH SIDE, decrease 1 st. after Rows 74, 76, 78, 80, 82, 84, 86, 88, 90, 92, 94, 96, 98, 100, 102, 104, 106, 108, 110, 112. ON CAM BOX SIDE, bind off 2 sts. after Rows 114, 115, 116, 117; 3 sts. after Rows 118, 119, 120, 121; 4 sts. after Rows 122, 123; 13 sts. after Row 124.

ON EACH SIDE, increase 1 st. after Rows 10, 16, 22, 28, 34, 40, 44, 48, 52, 56. Knit to Row 60.

Rows 0 to 10: Work even.

Cast on 101 sts. with color 1 and work Stockinette stitch.

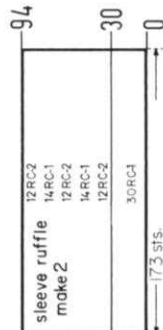

Sleeve Ruffle. Make 2. Cast on 173 sts. and work Stockinette stitch with color stripes: 30 rows color 1; 12 rows color 2; 14 rows color 1; 12 rows color 2; 14 rows color 1; 12 rows color 2. After Row 94, bind off all sts.

Move the Cam Box to the left side, turn the Row Counter back to 418 and complete the left half. Follow the instructions from \*.

ON CAM BOX SIDE, bind off 4 sts. after Rows 478, 480, 482, 484; 5 sts. after Rows 486, 488, 490, 492.

\* ON CAM BOX SIDE, bind off 3 sts. after Rows 419, 421; 2 sts. after Rows 423, 425, 427; 1 st. after Rows 429, 431, 433, 435, 439, 443, then knit to Row 478.

ON CAM BOX SIDE, bind off 4 sts. after Rows 382, 383; 3 sts. after Rows 384, 385, 386, 387; 2 sts. after Rows 388, 389, 390, 391, 392, 393. ON EACH SIDE, decrease 1 st. after Rows 394, 396, 398, 400. Knit to Row 418, bind off the center 22 sts., put the needles on the left side into holding position and complete the right half first.

ON OPPOSITE SIDE OF CAM BOX, put into holding position, 6 needles after Rows 348, 349, 350, 351, 352, 353, 354, 355, 356, 357, 358, 359, 360, 361, 362, 363. ON OPPOSITE SIDE OF CAM BOX, bring all the needles back into working position after Rows 362, 363. ON EACH SIDE, after Row 370 increase 1 st. Knit to Row 382.

Work the front section the same as the back section to Row 348, then work Short Rows.





# MK 5344

**SIZE:** TEEN 9/10 (Bust 30 1/2") 11/12 (Bust 32") 15/16 (Bust 35")  
**YARN:** Crocus Crepe 14 14 12  
 50gr. balls 4 to 6 5 to 7 6 to 8  
**TENSION:** 2" 16 sts, 24 rows 15 sts, 23 rows 14 sts, 21 rows  
**GAUGE:** Ribbing 18 sts, 24 rows 17 sts, 23 rows 16 sts, 21 rows

The instructions are the same for all sizes. **PATTERN:** Stockinette stitch with 1 x 1 ribbing for Bands and P3, K1 Ribbing for Sleeves, INCREASES and DECREASES: Full Fashion (see **KNITTING Practical Knitting Hints Book**, pages 14 to 17.)

**FINISHING:** SKIRT: Weave the skirt sections together 1 st. in on each edge. Fold 1" over on front edges of skirt and hem. Sew ribbed border to right side of skirt front. Sew elastic to top edge of skirt and sew on hooks and eyes for closure. Sew on buttons as illustrated in picture. **TOP:** Join front to back at side seams and shoulders. Sew sleeve seams and set in. Join neckband into circle then sew to neck edge. Sew ribbed band to left side of top then sew on buttons as illustrated.



Move the Cam Box to the left side, turn the Row Counter back to 214 and complete the left half. Follow the instructions from \*.

\*ON CAM BOX SIDE, bind off 3 sts. after Rows 215, 217, 219 (ODD ROWS = NECK SHAPING); 2 sts. after Rows 221, 223, 225; 1 st. after Rows 227, 229, 231, 233, 235, 237, 241; 3 sts. after Rows 242, 244 (EVEN ROWS = SHOULDER SHAPING); 1 st. after Row 245; 4 sts. after Rows 246, 248, 250, 252.

Work the front section the same as the back section to Row 214, then bind off the center 18 sts., put the needles on the left side into holding position and complete the right half first.

Move the Cam Box to the left side, turn the Row Counter back to 232 and complete the left half. Follow the instructions from \*.

\*ON CAM BOX SIDE, bind off 4 sts. after Rows 233, 235 (ODD ROWS = NECK SHAPING); 3 sts. after Rows 237, 239; 2 sts. after Row 241; 3 sts. after Row 242 (EVEN ROWS = SHOULDER SHAPING); 2 sts. after Row 243; 3 sts. after Row 244; 2 sts. after Row 245; 4 sts. after Row 246; 1 st. after Row 247; 4 sts. after Row 248; 1 st. after Row 249; 4 sts. after Rows 250, 252.

ON CAM BOX SIDE, bind off 3 sts. after Row 166, 167, 168, 169; 2 sts. after Rows 170, 171, 172, 173; 1 st. after Rows 174, 175, 176, 177, 178, 179, then knit to Row 232 (214 on front section), bind off the center 20 sts., put the needles on the left side into holding position and complete the right half first.

ON EACH SIDE, increase 1 st. after Rows 74, 88, 102, 116, 130, 144, then knit to Row 166.

Rows 17 to 74: Knit even.

Rows 0 to 16: Knit even then change to Stockinette stitch.

Cast on 122 sts. and work K1, P1 Ribbing.

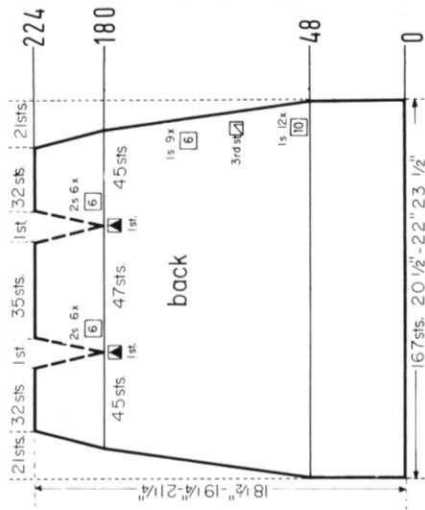

Cast on 163 sts. and work 14 rows K1, P1 Ribbing, then bind off all sts.

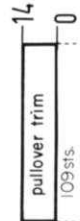
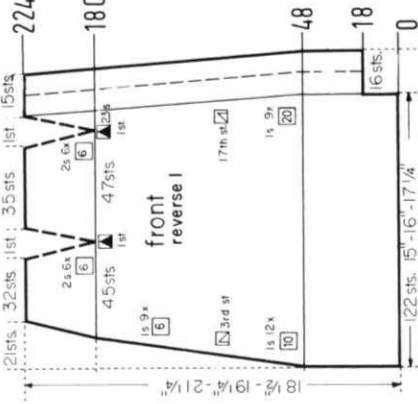

Cast on 109 sts. and work 14 rows K1, P1 Ribbing, then bind off all sts.

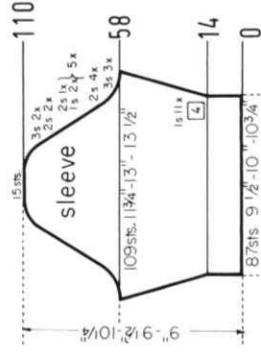

Decrease 2 sts. for EACH DART and 1 st. on EACH SIDE after Rows 180, 186, 192, 198, 204, 210. After Row 216, decrease 1 st. more on EACH SIDE, then knit to Row 224 and bind off the remaining 101 sts.

ON EACH SIDE, decrease 1 st. after Rows 48, 58, 68, 78, 88, 98, 108, 118, 128, 138, 148, 158, 168, 174.

Rows 0 to 48: Knit even.

Cast on 167 sts. and work Stockinette stitch.

Make the second front section with reverse shaping, casting on from RIGHT to LEFT. Cam Box will be on the left side at Row 0.

ON CAM BOX SIDE, decrease 1 st. after Rows in ( ) by hanging the 17th st. onto the 16th st., then moving the end sts. inward. ON OPPOSITE SIDE OF CAM BOX, decrease 1 st. after Rows 48, (48), 58, 68, (68), 78, 88, (88), 98, 108, (108), 118, 128, (128), 138, 148, (148), 158, 168, (168), 174. Continue to decrease 1 st. ON CAM BOX SIDE after Rows in ( ). Decrease 1 st. ON OPPOSITE SIDE OF CAM BOX and 2 sts. for EACH DART after Rows 180, 186, (188), 192, 198, 204, (208), 210. After Row 216 decrease 1 st. more. ON OPPOSITE SIDE OF CAM BOX, then knit to Row 224 and bind off the remaining 84 sts.

Rows 19 to 48: Knit even.

Rows 0 to 18: Knit even, then cast on 16 sts. on the Cam Box Side.

Cast on 122 sts. and work Stockinette stitch.

ON CAM BOX SIDE, bind off 3 sts. after Rows 58, 59, 60, 61, 62, 63; 2 sts. after Rows 64, 65, 66, 67, 68; 69, 70, 71; 1 st. after Rows 72, 73, 74, 75; 2 sts. after Rows 76, 77; 1 st. after Rows 78, 79, 80, 81; 2 sts. after Rows 82, 83; 1 st. after Rows 84, 85, 86, 87; 2 sts. after Rows 88, 89; 1 st. after Rows 90, 91, 92, 93; 2 sts. after Rows 94, 95; 1 st. after Rows 96, 97, 98, 99; 2 sts. after Rows 100, 101; 2 sts. after Rows 102, 103, 104, 105; 3 sts. after Rows 106, 107, 108, 109; 15 sts. after Row 110.

ON EACH SIDE, increase 1 st. after Rows 14, 18, 22, 26, 30, 34, 38, 42, 46, 50, 54, then knit to Row 58.

Rows 0 to 14: Knit even.

Cast on 87 sts. and work K1, P3 Ribbing.





# MK 5337

**SIZE:** 9/10 (Bust 28"-29") 11/12 (Bust 31"-32") 14/15 (Bust 33"-34")  
**YARN:** Subita Crepe 2 x 3 Fortissima Subita Dralon 3-ply  
 50gr. balls 7 for Pullover 7 for Pullover  
**TENSION:** 8 for Pants 10 for Pants 9 for Pants  
 4 to 6 Pattern 5 to 7 Pattern  
 3 to 5 Stock. 4 to 6 Stock.  
**GAUGE:** 2" Pattern 15 sts, 23 rows 14 sts, 22 rows  
 Stock. 18 sts, 23 rows 16 sts, 22 rows

The instructions are the same for all sizes. **PATTERN:** Pullover: Ribbed Pattern as shown on Line Drawing with neckband K1, P1 Ribbing. Pants: Stockinette stitch, INCREASES and DECREASES: Full Fashion for Stockinette stitch, on the edges of each section for Ribbed Pattern.

**FINISHING:** Pullover: Join front and back at side seams. Sew right shoulder then sew left shoulder for 3/4". Narrowly turn edges of opening at shoulder and hem. Sew sleeve seams and set in. Sew neckband to neck edge with one side of band to inside and one to outside edge. Make 3 loops on shoulder opening and sew on buttons. Sew 3 buttons in place as illustrated. Pants: Join front and back and leg seams. Make hem on legs and at waist. Insert elastic through waistband.



Move the Cam Box to the left side, turn the Row Counter back to 264 and complete the left half. Follow the instructions from \*.

\*ON CAM BOX SIDE, bind off 4 sts. after Row 264 (EVEN ROWS = SHOULDER SHAPING); 5 sts. after Row 265 (ODD ROWS = NECK SHAPING); 4 sts. after Row 266; 5 sts. after Row 267; 4 sts. after Row 268, 269; 5 sts. after Row 270; 4 sts. after Row 271; 5 sts. after Row 272, 274.

ON CAM BOX SIDE, bind off 3 sts. after Rows 184, 185; 2 sts. after Rows 186, 187, 188, 189. ON EACH SIDE, decrease 1 st. after Rows 190, 192, 194, 196, 198, 200, then knit to Row 264, bind off the center 13 sts., put the needles on the left side into holding position and complete the right half first.

Rows 0 to 184: Knit even.  
 Cast on 129 sts. and work the Ribbing Design as shown on the Line Drawing.

Move the Cam Box to the left side, turn the Row Counter back to 240 and complete the left half. Follow the instructions from \*.

ON CAM BOX SIDE, bind off 4 sts. after Rows 264, 266, 268; 5 sts. after Rows 270, 272, 274.

\*ON CAM BOX SIDE, bind off 3 sts. after Rows 241, 243; 2 sts. after Rows 245, 247, 249; 1 st. after Rows 251, 253, 255, 257, 259, 261, then knit to Row 264.

Work the front section the same as the back section to Row 240, bind off the center 13 sts., put the needles on the left side into holding position and complete the right half first.

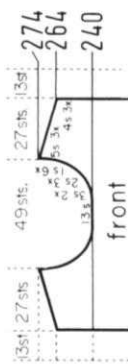
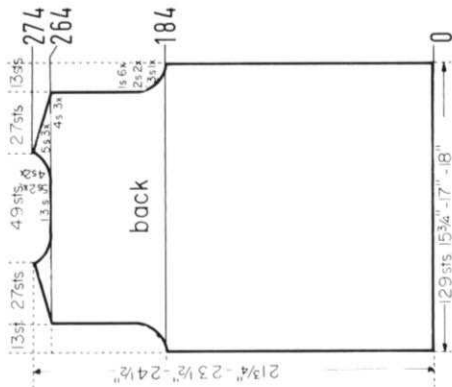

Cast on 137 sts. and work 26 rows K1, P1 Ribbing, then bind off all sts.

ON CAM BOX SIDE, bind off 3 sts. after Rows 64, 65, 66, 67; 2 sts. after Rows 68, 69, 70, 71. ON EACH SIDE, decrease 1 st. after Rows 72, 74, 76, 78, 80, 82, 84, 86, 88, 90, 92, 94, 96, 98, 100, 102, 104, 106, 108, 110. ON CAM BOX SIDE, bind off 2 sts. after Rows 112, 113, 114, 115; 3 sts. after Rows 116, 117, 118, 119; 10 sts. after Row 120.

ON EACH SIDE, increase 1 st. after Rows 10, 16, 22, 28, 34, 40, 46, 52, 58, then knit to Row 64.

Rows 0 to 10: Knit even.  
 Cast on 72 sts. and work the Ribbing Design.

Work the second pants section with reverse shaping, casting on from right to left. Cam Box will be on the left side at Row 0.

ON OPPOSITE SIDE OF CAM BOX, put into holding position 45 needles after Row 410; 15 needles after Rows 412, 414, 416, 418. After Row 420, bring all the needles back into working position and knit to Row 450. Bind off the remaining 133 sts.

ON CAM BOX SIDE, bind off 6 sts. after Row 294 (EVEN ROWS = Center Back); 3 sts. after Row 295 (ODD ROWS = Center Front); 3 sts. after Row 296; 2 sts. after Row 297; 3 sts. after Row 298; 2 sts. after Rows 299, 300; 1 st. after Row 301; 2 sts. after Row 302; 1 st. after Row 303; 2 sts. after Row 304; 1 st. after Row 305; 2 sts. after Row 306; 1 st. after Rows 307, 308, 309, 310, 311, 312, 314, 315, 316, 318, 319, 322, 323, 326, 327, 330, 331, 334, 338, 346, 354, 362, 370, 378, 386, 394, 402, 410 but do not knit the next row after the last bind off. Work Short Rows.

ON OPPOSITE SIDE OF CAM BOX, increase 1 st. on Rows in (. ON CAM BOX SIDE, increase 1 st. after Rows 170, (170), 176, (180), 182, 188, (190), 194, 200, (200), 206, (210), 212, 218, (220), 224, 230, (230), 236, (238), 242, (246), 248, 254, (254), 260, (262), 266, (270), 272, 278, (278), 282, 286, (288), 290. Knit to Row 294.

Rows 0 to 170: Knit even.  
 Cast on 155 sts. and work Stockinette stitch.

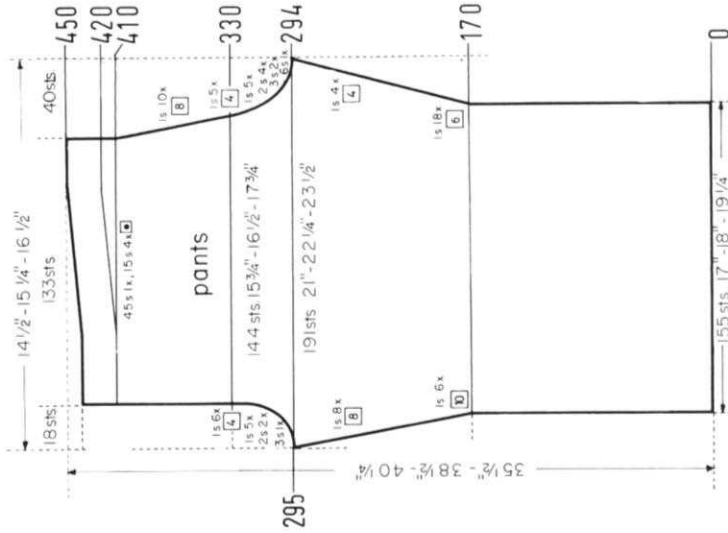

SIZE: 10 (Bust 32½") 12 (Bust 34") 14 (Bust 36")  
 YARN: Subita Crepe 2 x 3 2 x 4 2 x 4  
 50gr. BALLS: 10 12 13  
 TENSION: 6 to 7 6 to 8 7 to 9  
 GAUGE: 17 sts, 24 rows 16 sts, 23 rows 15 sts, 22 rows  
 All Sizes: An 18" Zipper 2" Pat.

The instructions are the same for all sizes. PATTERN: K1, P1, Ribbing. DECREASES: Hang the 1st st. onto the 2nd st. INCREASES: Place the end st. from the row below onto the next empty needle. After every 2nd increase transfer the proper st. to the ribber.

FINISHING: Damp block all sections. Do not press, but let dry thoroughly before removing the pins. Sew the leg seams together, then join the sections at center front and center back, leaving about 3½" on the upper back seam free. Join front and back section of the bodice at sides and shoulders. Sew the sleeves together and set in. Join bodice and pants. Work 1 row of single crochet around the back opening and neckline. Work a 2nd row of crochet around neckline as follows: \*Chain 4, skip 2, single crochet into next stitch. Repeat from \* for pattern. Sew the zipper to back opening.

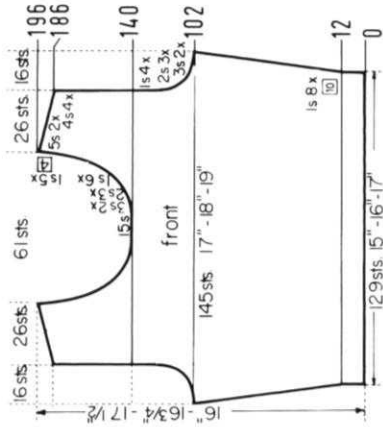

Work the second back section with reverse shapings, casting on from right to left. (Cam Box will be on the LEFT side at Row 0)

ON CAM BOX SIDE, bind off 9 sts. after Row 167 (ODD ROWS = NECK SHAPING); 3 sts. after Rows 169, 171, 173, 175; 4 sts. after Row 176 (EVEN ROWS = SHOULDER SHAPING); 2 sts. after Row 177; 4 sts. after Row 178; 2 sts. after Row 179; 4 sts. after Row 180; 2 sts. after Row 181; 4 sts. after Row 182; 2 sts. after Row 183; 5 sts. after Row 184; 2 sts. after Row 185; 5 sts. after Row 186.

ON CAM BOX SIDE, bind off 3 sts. after Rows 92, 94; 2 sts. after Rows 96, 98, 100; 1 st. after Rows 102, 104, 106, 108, then knit to Row 167.

ON CAM BOX SIDE, increase 1 st. after Rows 12, 22, 32, 42, 52, 62, 72, 82, then knit to Row 92.

ROWS 0 to 12: Knit even.

Cast on 65 sts. and work K1, P1, Ribbing.

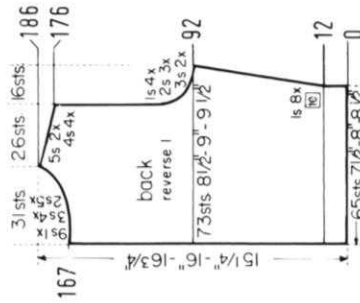

ON CAM SIDE, bind off 4 sts. after Rows 202, 203; 3 sts. after Rows 204, 205, 206, 207; 2 sts. after Rows 208, 209, 210, 211, 212, 213. ON EACH SIDE, hang the first st. onto the 2nd st. after Rows 214, 216, 218, 220, 222, 224, 226, 228, 230, 232, 234, 236, 238, 240, 242, 244, 246. ON CAM BOX SIDE, bind off 2 sts. after Rows 248, 249, 250, 251; 3 sts. after Rows 252, 253, 254, 255; 4 sts. after Rows 256, 257; 11 sts. after Row 258.

ON EACH SIDE, increase 1 st. after Rows 14, 22, 30, 38, 46, 54, 62, 72, 82, 92, 102, 112, 122, 132, 142, 152, 162, 172, 182, 192, then knit to Row 202.

ROWS 0 to 14: Knit even.

Cast on 65 sts. and work K1, P1, Ribbing.

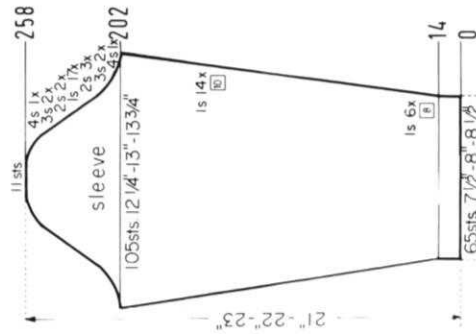

Bring the needles on the left side into working position, knit 1 row in PATTERN to the left side, turn the Row Counter back to 140 and complete the left half. Follow the instructions from \*.

\* ON CAM BOX SIDE, bind off 3 sts. after Rows 141, 143; 2 sts. after Rows 145, 147, 149; 1 st. after Rows 151, 153, 155, 157, 159, 161, 165, 169, 173. FOR SHOULDER, bind off 4 sts. after Rows 186, 188, 190, 192; 5 sts. after Rows 194, 196.

ON CAM BOX SIDE, bind off 3 sts. after Rows 102, 103, 104, 105; 2 sts. after Rows 106, 107, 108, 109, 110, 111; 1 st. after Rows 112, 113, 114, 115, 116, 117, 118, 119, then knit to Row 140, bind off the center 15 sts, put the needles on the left side into holding position and complete the right half first. (Transfer the ribber sts. to the main machine before putting the needles in hold.)

ON EACH SIDE, increase 1 st. after Rows 12, 22, 32, 42, 52, 62, 72, 82, then knit to Row 102.

ROWS 0 to 12: Knit even.

Cast on 129 sts. and work K1, P1, Ribbing.

Work the second section with reverse shapings, casting on from right to left. (Cam Box will be on the LEFT side at Row 0).

ON CAM BOX SIDE, bind off 4 sts. after Row 46 (EVEN ROWS = CENTER BACK SHAPING); 3 sts. after Rows 47 (ODD ROWS = CENTER FRONT SHAPING), 48; 2 sts. after Row 49; 3 sts. after Row 50; 2 sts. after Row 51; 3 sts. after Row 52; 2 sts. after Rows 53, 54, 55, 56; 1 st. after Row 57; 2 sts. after Row 58; 1 st. after Rows 59, 60, 61, 62, 63, 64, 65, 66, 70, 74, 78, 90, 102, 114, 126, 138, 150, 162, 174, but do not knit after the last decrease. Work Short Rows. (Transfer the ribber sts. to the main machine before putting the needles into holding position). ON OPPOSITE SIDE OF CAM BOX put into holding position 48 needles after Row 174; 11 needles after Rows 176, 178, 180, 182, 184, 186. After Row 188 bring all needles back into working position, then bind off all 129 sts.

ON EACH SIDE, increase 1 st. after Rows 10, 14, 18, 22, 26, 30, 34, 38, 42, then knit to Row 46.

ROWS 0 to 10: Knit even.

Cast on 161 sts. and work K1, P1, Ribbing.



# DK 8087

- SIZE: 10 (Hip 34½) 12 (Hip 36½) 14 (Hip 38½)  
 YARN: Subita Crepe with Lurex Subita Crepe with Lurex Subita Crepe with Lurex  
 11 11 12  
 5 to 7 6 to 8 7 to 9  
 16 sts. 23 rows 15 sts. 22 rows 14 sts. 21 rows  
 Taffeta to line the skirt.

The instructions are the same for all sizes. PATTERN: Stockinette st., worn on the purl side. For all side edge decreases hang the 4th st. onto the 3rd st. Begin the DART decreases by hanging the sts. together as marked in the Diagram. The following decreases lie directly above. Always move the sts. inward to fill the empty needles.

FINISHING: Block all sections. Weave the skirt sections together at sides, 1 st. in from each edge. Turn under 18 rows on upper and lower edges and hem to wrong side. Turn under 12 sts. on front edges and hem to wrong side. Insert an elastic band into upper hem and sew in place. Finish open edges. Finish buttonholes. Sew on buttons. Line the skirt with taffeta.

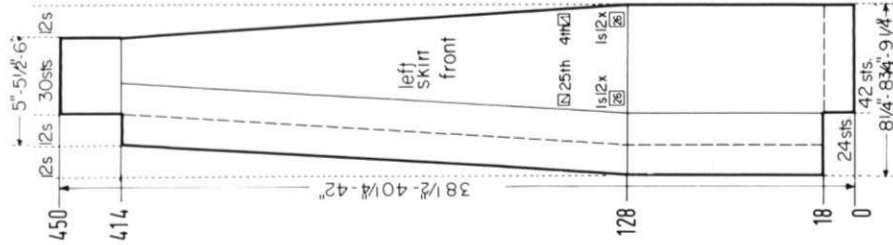
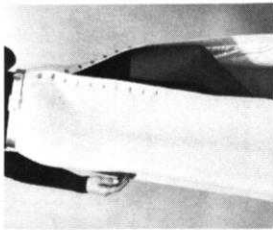

ON CAM BOX SIDE, hang the 25th st. onto the 24th st. AND ON OPPOSITE SIDE of CAM BOX hang the 4th st. onto the 3rd st. after Rows 128, 154, 180, 206, 232, 258, 284, 310, 336, 362, 388, 414, but do not knit after the last decreases. After Row 414 bind off 12 sts. ON CAM BOX SIDE, then knit to Row 450 and bind off the remaining 30 sts.

ROWS 19 to 128: Knit even.

ROWS 0 to 18: Knit even, then cast on 24 sts. ON CAM BOX SIDE.

From right to left, cast on 42 sts. and work stockinette st. (Cam Box will be on the LEFT side at Row 0).

Make buttonholes after Rows in ( ) over the 3rd-7th and 18th-22nd sts. counting from the right side. ON OPPOSITE SIDE of CAM BOX AND for EACH DART, decrease 1 st. after Rows 128, 154, 180, 206, (224), 232, (243), 258, (262), (281), 284, (300), 310, (319), 336, (338), (357), 362, (376), 388, (395), 414, then knit to Row 432. Bind off 24 sts. ON CAM BOX SIDE, then knit to Row 450 and bind off the remaining 84 sts.

ROWS 19 to 128: Knit even.

ROWS 0 to 18: Knit even, then cast on 24 sts. ON CAM BOX SIDE.

Cast on 132 sts. and work stockinette st.

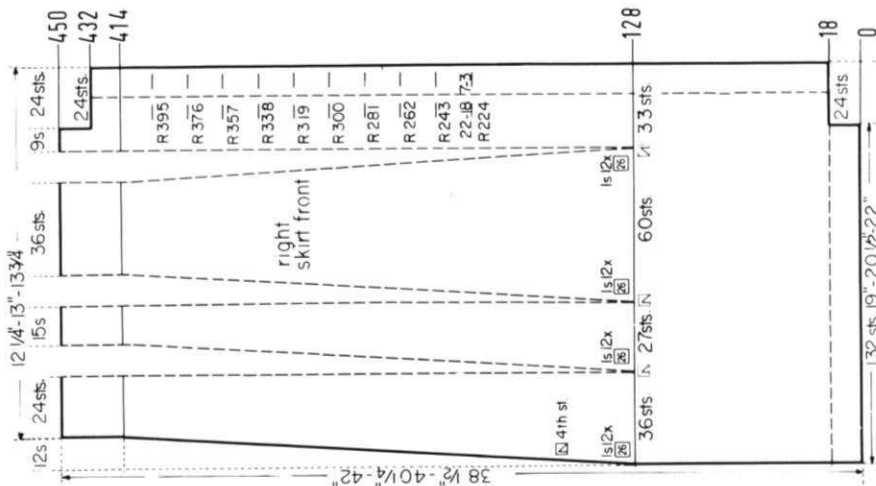

ON EACH SIDE AND for EACH DART, decrease 1 st. after Rows 128, 154, 180, 206, 232, 258, 284, 310, 336, 362, 388, 414, then knit to Row 450 and bind off the remaining 114 sts.

ROWS 0 to 128: Knit even.

Cast on 186 sts. and work stockinette st.

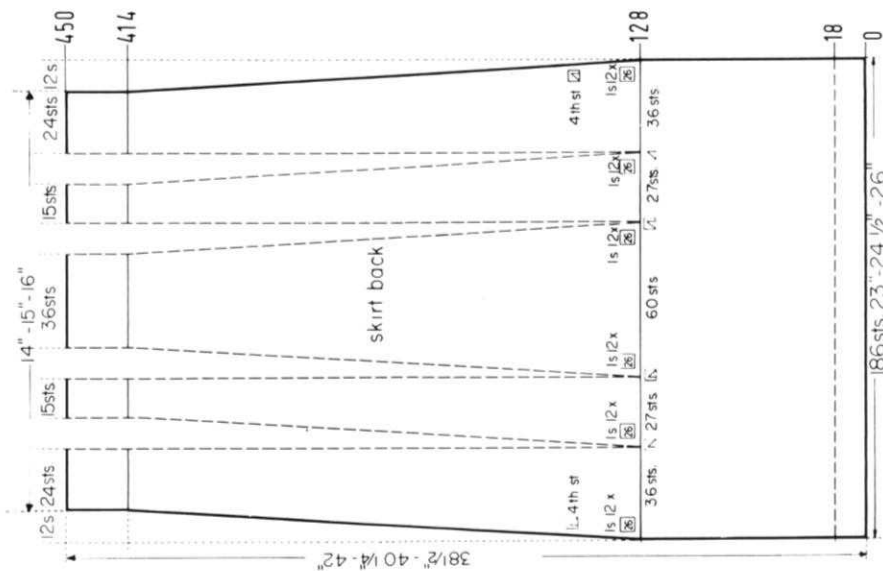

- SIZE:**  
**YARN:** 50gr. balls  
**TENSION:** 2"  
**GAUGE:** Ribbing 18 sts. 24 rows  
 Stockinette 18 sts. 25 rows
- 6 (Chest 24"-25")  
 Subita Crepe 2 x 3  
 5 for Pullover  
 6 for Pants  
 6 to 8 Rib.  
 2 to 4 Stock.
- 10 (Chest 28"-29")  
 Crocus Crepe  
 7 for Pullover  
 9 for Pants  
 8 to 10 Rib.  
 4 to 6 Stock.
- 12 (Chest 30"-31")  
 Subita Crepe 2 x 4  
 7 for Pullover  
 9 for Pants  
 8 to 10 Rib.  
 6 to 8 Stock.
- 15 sts. 21 rows  
 15 sts. 22 rows
- 16 sts. 23 rows  
 16 sts. 24 rows
- 18 sts. 24 rows  
 18 sts. 25 rows

The instructions are the same for all sizes. **PATTERN:** Pants and bands on Pullover are Stockinette stitch. Pullover: K1, P1 Ribbing, INCREASES and DECREASES: Full Fashion for Stockinette stitch; on the edges of all sections for Ribbing.

**FINISHING:** Pullover: Join front and back at side seams and shoulders. Sew sleeve seams and set in. Sew button and buttonhole band and neckband to Pullover with one side of band inside and one side to the outside of edges. Finish buttonholes and sew on buttons. Pants: Join front and back and leg seams leaving 3" open on front for zipper. Turn edges of opening to form narrow hem. Fold over and make hem at top of pants and insert elastic. Sew in zipper. Make hem on legs.



Move the Cam Box to the left side, turn the Row Counter back to 96 and complete the left half. Follow the instructions from\*.

ON CAM BOX SIDE, bind off 3 sts. after Rows 183, 185, 187; 2 sts. after Rows 189, 191; 1 st. after Rows 193, 195, 197, 199, 201, 203. Knit to Row 206. For SHOULDER, bind off 4 sts. after Rows 206, 208, 210, 212, 214; 5 sts. after Row 216.

ON CAM BOX SIDE, bind off 3 sts. after Rows 144, 146; 2 sts. after Rows 148, 150; 1 st. after Rows 152, 154, 156, 158, then knit to Row 183.

\*Rows 97 to 144: Knit even. Work the front section the same as the back section to Row 96, then bind off the center 9 sts., put the needles on the left side into holding position and complete the right half first.

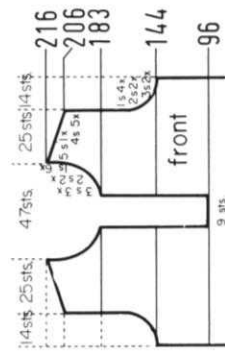

ON CAM BOX SIDE, bind off 4 sts. after Rows 58, 59; 3 sts. after Rows 60, 61, 62, 63; 2 sts. after Rows 64, 65, 66, 67. ON EACH SIDE, decrease 1 st. after Rows 68, 70, 72, 74, 76, 78, 80, 82, 84, 86. ON CAM BOX SIDE, bind off 2 sts. after Rows 88, 89; 3 sts. after Rows 90, 91, 92, 93, 94, 95, then bind off the remaining 12 sts. after Row 96.

ON EACH SIDE, increase 1 st. after Rows 34, 42, 50, then knit to Row 58. Rows 0 to 34: Knit even. Cast on 76 sts. and work K1, P1 Ribbing.

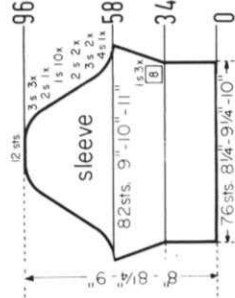

Work the second section with reverse shaping, casting on from right to left. Cam Box will be on the left side at Row 0.

ON CAM BOX SIDE, bind off 3 sts. after Row 230 (EVEN ROWS = CENTER BACK); 3 sts. after Row 231 (ODD ROWS = CENTER FRONT); 3 sts. after Row 232; 2 sts. after Rows 233, 234, 235, 236; 1 st. after Row 237; 2 sts. after Row 238; 1 st. after Rows 239, 240, 241, 242, 243, 244, 245, 246, 247, 248, 251, 252, 255, 256, 259, 260, 270, 280, 290, 300, 310, 320, 330, and work Short Rows after Row 330. ON OPPOSITE SIDE OF CAM BOX, put into holding position 40 needles after Row 330, 14 needles after Rows 332, 334, 336, 338. After Row 340, bring all the needles back into working position then knit to Row 370 and bind off the remaining 122 sts.

ON OPPOSITE SIDE OF CAM BOX, increase 1 st. after Rows in ( ), ON CAM BOX SIDE, increase 1 st. after Rows 124, (124), 128, (130), 132, 136, (136), 140, (142), 144, 148, (148), 152, (152), 156, 160, (160), 164, (166), 168, 172, (172), 176, (178), 180, 184, (184), 188, (190), 192, 196, (196), 200, (202), 204, (208), 212, (214), 216, 218, 220, (220), 222, 224, 226, (226), knit to Row 230.

Rows 0 to 124: Knit even. Cast on 118 sts. and work Stockinette stitch.

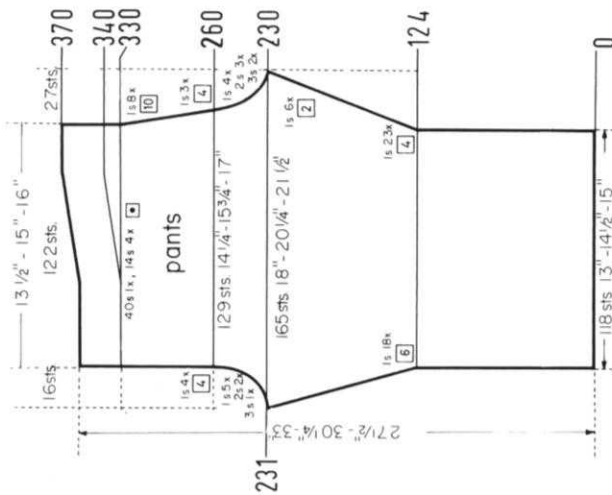

Cast on 65 sts. and work Stockinette stitch. After Row 7, work buttonholes over needles 8 to 12, 30 to 34, 52 to 56, counting from the left edge. Knit to Row 24 and make buttonholes again over the same needles as before. Knit to Row 30 and bind off all sts. Work the Button Band the same but omit the buttonholes.

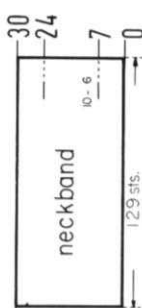

Cast on 129 sts. and work Stockinette stitch. After Row 7, make the buttonhole over needles 6 to 10 counting from the right edge. Knit to Row 24 and make buttonhole over same needles as before. After Row 30, bind off all sts.

Move the Cam Box to the left side, turn the Row Counter back to 206, and complete the left half. Follow the instructions from\*.

\*ON CAM BOX SIDE, bind off 4 sts. after Row 206 (EVEN ROWS = SHOULDER SHAPING); 4 sts. after Row 207 (ODD ROWS = NECK SHAPING); 4 sts. after Rows 208, 209, 210, 211, 212, 213, 214; 5 sts. after Row 216.

ON CAM BOX SIDE, bind off 3 sts. after Rows 144, 145, 146, 147; 2 sts. after Rows 148, 149, 150, 151; 1 st. after Rows 152, 153, 154, 155, 156, 157, 158, 159, then knit to Row 206, bind off the center 15 sts. put all the needles on the left side into holding position (you must transfer the Ribber sts. to main machine first before putting needles into holding position) and complete the right half first.

Rows 0 to 144: Knit even. Cast on 125 sts. and work K1, P1 Ribbing.

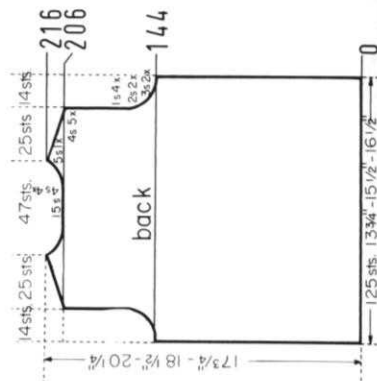



# KG 1942

## YARN:

50gr. BALLS: 6  
TENSION: 10  
GAUGE: 2"

Subita Crepe with Lurex 5  
10  
approx. 12 sts. 19 rows

Amore 6  
10  
approx. 12 sts. 19 rows

**PATTERN:** Holding Position Design with omitted needles according to Line Drawing. (See inside Back Cover for Pattern Stitch Symbols). The knit side is the right side. The omitted needles in the Pattern Stitch are counted as stitches in the Gauge and Instructions. (Keep this in mind when shaping). (See also Practical Knitting Hints Book Page 23).

**FINISHING:** Damp block the sections to the measurements given. (Measurements are approximate.) Do not press, but let dry thoroughly before removing the pins. Join the sections at back. Work 2 rows of single crochet on the front edge (long shaped edge). Knot fringe on lower edge (cast-on edge) as follows:

Wind yarn around a 12" cardboard, then cut only one end. Using 4 strands of yarn, fold in half and knot Fringe evenly across lower edge of Shawl. Make a second row of knots approximately 4" down using 4 strands from one fringe and 4 from the next. Cut fringe evenly.



Work the second section with reverse shapings, casting on from left to right. (Cam Box will be on the RIGHT side at Row 0).

ON THE RIGHT SIDE (LEFT SIDE for the second section) decrease 1 st. after Rows in ( ). ON CAM BOX SIDE, decrease 1 st. after Rows 2, (3), 4, 6, (6), 8, (9), 10, 12, (12), 14, (15), 16, 18, (18), 20, (21), 22, 24, (24), 26, (27), 28, 30, (30), 32, (33), 34, 36, (36), 38, (39), 40, 42, (42), 44, (45), 46, 48, (48), 50, (51), 52, 54, (54), 56, (57), 58, 60, (60), 62, (63). Continue to decrease 1 st. on the RIGHT side (LEFT side for the second section) after Rows in ( ). ON CAM BOX SIDE, bind off 2 sts. after Rows 64, 66, (66), 68, (69), 70, 72, (72), 74, (75), 76, 78, (78), 80, (81), 82, 84, (84), 86, (87), 88, 90, (90), 92, (93), 94, 96, (96), 98, (99), 100, 102, (102), 104, (105), 106, 108, (108), 110, (111), 112, 114, (114), 116, (117), 118, 120, (120), 122, (123), 124, 126, (126), 128, (129), 130, 132, (132), 134, (135), 136, 138, (138), 140, (141), 142, 144, (144), 146, (147), 148, 150, (150), 152, (153), 154, 156, (156), 158, (159). Continue to decrease 1 st. on the RIGHT side (LEFT side for the second section) after Rows in ( ). ON CAM BOX SIDE, bind off 3 sts. after Rows 160, 162, (162), 164, (165), 166, 168.

Cast on 197 sts. from right to left and work the Holding Position Design. (Cam Box will be on the LEFT side at Row 0).

# KG 1943

## YARN:

50gr. BALLS: 6  
TENSION: 10  
GAUGE: 2"

Subita Crepe with Lurex 6  
10  
approx 10 sts. 22 rows

Amore 7  
10  
approx 10 sts. 22 rows

**PATTERN:** Holding Position Design according to Line Drawing. The purl side is the right side. Wrap the yarn around the needle when the end needles are in holding position. To decrease 1 st., hang the first st. onto the 2nd st. If the st. to be decreased is on a holding needle, knit off the st. using the last cross-over thread, then hang the st. onto the next occupied needle.

**FINISHING:** Damp block the sections to the measurements given. (Measurements are approximate.) Do not press, but let dry thoroughly before removing the pins. Join sections at center back. Work 2 rows of single crochet on the front edge (long shaped edge). Knot fringe on the lower edge (cast-on edge) as follows:

Wind yarn around a 12" cardboard, then cut only one end. Using 4 strands of yarn, knot Fringe evenly across lower edge of Shawl. Make a second row of knots approximately 4" down by taking 4 strands from one fringe and 4 from the next and tie them together.

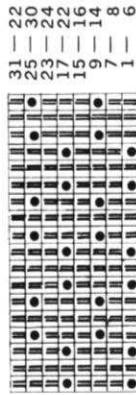

Work the second section with reverse shapings, casting on from left to right. (Cam Box will be on the RIGHT side at Row 0).

Decrease 1 st. ON OPPOSITE SIDE of CAM BOX after Rows in ( ). ON CAM BOX SIDE decrease 1 st. after Rows 2, 4, (4), 6, 8, (8), 10, 12, (12), 14, 16, (16), 18, 20, (20), 22, 24, (24), 26, 28, (28), 30, 32, (32), 34, 36, (36), 38, 40, (40), 42, 44, (44), 46, 48, (48), 50, 52, (52), 54, 56, (56), 58, 60, (60), 62, 64, (64), 66, 68, (68), 70, 72, (72), 74, 76, (76), 78, 80, (80), 82, 84, (84), 86, 88, (88), 90, 92, (92), 94, 96, (96), 98, 100, (100), 102, 104, (104), 106, 108, (108), 110, 112, (112), 114, 116, (116), 118, 120, (120), 122, 124, (124), 126, 128, (128), 130, 132, (132), 134, 136, (136), 138, 140, (140), 142, 144, (144), 146, 148, (148), 150, 152, (152), 154, 156, (156), 158, 160, (160), 162, 164, (164), 166, 168, (168), 170, 172, (172).

Continue to decrease 1 st. ON OPPOSITE SIDE of CAM BOX after Rows in ( ). ON CAM BOX SIDE, bind off 2 sts. after Rows 174, 176, (176), 178, 180, (180), 182, 184, (184), 186, 188, (188), 190, 192, (192), 194, 196, (196), 198, 200, (200), 202, 204, (204). Continue to decrease 1 st. ON OPPOSITE SIDE of CAM BOX after Rows in ( ). ON CAM BOX SIDE, bind off 3 sts. after Rows 206, 208, (208), 210, 212, (212), 214, 216, (216), 218, 220. Break the yarn and pull through last st.

Cast on 197 sts. from right to left and work the Holding Position Design. (Cam Box will be on the LEFT side at Row 0).

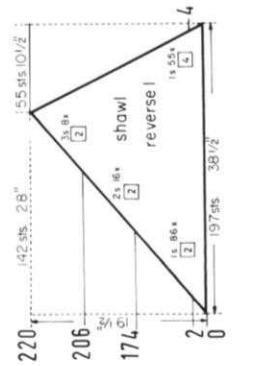

# KG 1939 KG 1940

**SIZE:** 18" x 25"  
**YARN:** 50gr. balls

**PILLOW:** 18" x 17 1/2"  
 Sonika Dralon and Leacril for both  
 For Rug  
 5 C-1 Sonika  
 7 C-1 Sonika  
 2 C-2 Leacril  
 3 C-3 Leacril  
 For Fringe:  
 2 Balls Leacril, your color choice.  
 8 to 10  
 11 sts. 32 rows

**TENSION:** 2"  
**GAUGE:** 2"

**FINISHING:** Block and weave in all ends. There are different ways to finish your Rug and you may use any one of them. 1. Back the Rug with a fabric such as Burlap (after attaching fringe). Make fringe by winding yarn around a 6" cardboard then cut only 1 end. Use 3 or more strands and fringe both ends of rug. Trim fringe evenly. 2. Make fringe for each end after single crocheting around all edges. Spray back of rug with a latex rug spray. 3. Make fringe, then bind all edges with rug binding. **PILLOW:** Fold pillow cover in half, sew sides and top, leaving an opening big enough to insert stuffed pillow. Make a pillow by cutting one out of musline using the cover as a pattern and allowing 1 1/2" all around. Stuff with dacron or foam chips then insert into knitted cover. Close opening or sew in a zipper.

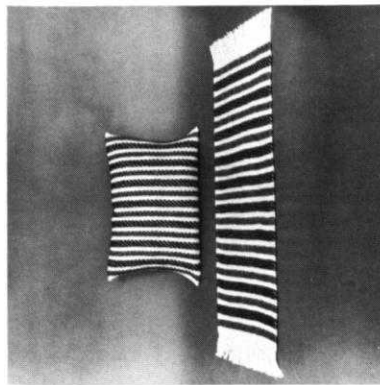

KG 1939 and KG 1940

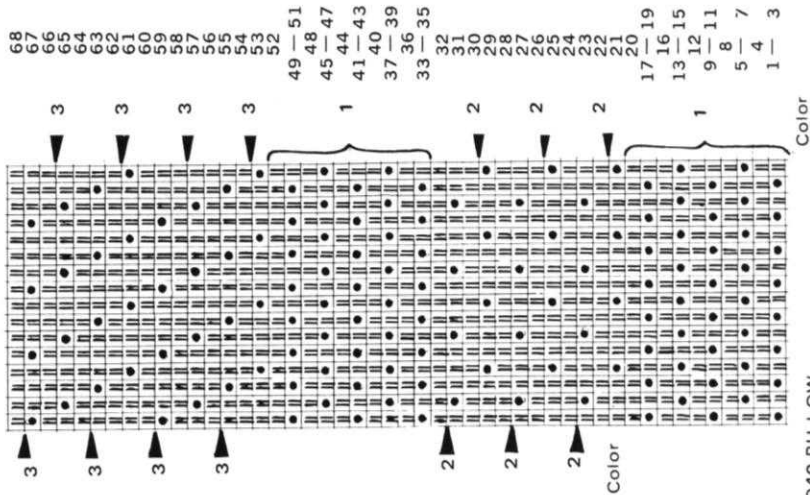

KG 1940 PILLOW

Cast on 100 sts. and follow the Line Drawing and the basic instructions the same as for the Rug. After Row 392, repeat from Row 1. After Row 784, bind off all sts.

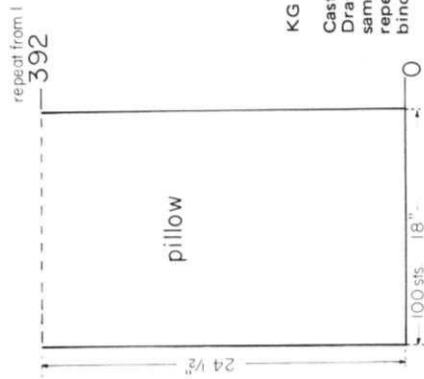

# KG 1941

**SIZE:** 19" x 25"  
**YARN:** Amoretta and Amorina  
 5 Amoretta as basic yarn  
 7 Amorina for Weaving  
 6 to 8  
 11 sts. 32 rows

**TENSION:** 2"  
**GAUGE:** 2"

The Pillow is made with a weaving pattern. Use Amoretta as the basic yarn and Amorina for Weaving.

**FINISHING:** Fold Pillow Cover in half and sew side seams. Use cover as a pattern and cut pillow from Muslin allowing 1 1/2" all around. Stuff Pillow with Dacron or Foam Chips. Pull Pillow Cover over pillow and sew up opening, or you may put in a zipper.

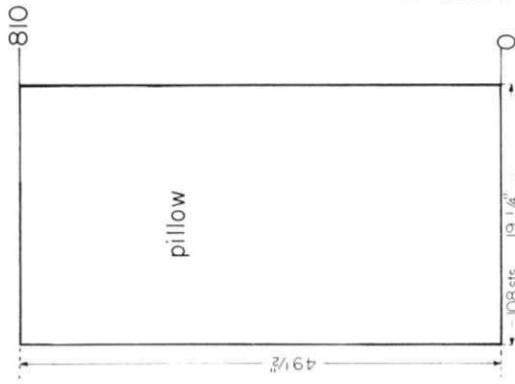
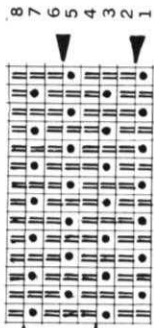

KG 1941 PILLOW

Cast on 108 sts. and follow the Line Drawing for the Weaving Pattern. **KNITTING** Machine owners, use Wheel No. 6. After Row 810, bind off all sts.

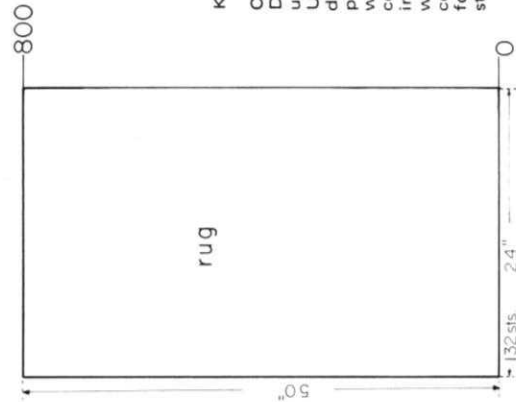

KG 1939 RUG

Cast on 132 sts. and follow the Line Drawing. **KNITTING** Machine owners use **KNITTING** Weaver and Wheel No. 6. Use Wheel No. 3 for the holding position design. Work 20 rows in the holding position Design with Color 1; 12 rows weaving pattern with color 1 as basic color, color 2 for weaving; 20 rows holding position Design with color 1; 16 rows weaving pattern with color 1 as basic color and color 3 for weaving. **REPEAT** for pattern. After Row 800, bind off all sts.





# KNITKING NEWS

March/April, 1972

## OUR READERS WRITE

The New Sizing, Tensions, Gauge, amounts of Yarn etc., listed at the top of each KNITKING MAGAZINE Pattern has brought a flood of letters from Readers telling us how they just love it... As most of you know, KNITKING YARNS as well as most fine imported yarns, are put up in 50gr. balls (gr. stands for grams). To avoid confusion, we give you the number of 50gr. balls you will need to knit a specific garment. When we list 8 C-1 and directly under that, 4 C-2, we are telling you that you will need 8 balls of Color 1 and 4 balls of Color 2. The C stands for Color. If you want to convert gram balls into ounces, look at the Chart below. We published this before, but in case you have forgotten and for our new readers, we are printing it once again. In our Yarn Catalogue, we give the approximate yardage for each of the yarns (just in case you want to know that too).

BALLS	GRAMS (gr.)	OUNCES
1 ball	50 gr.	1 3/4 oz.
2 balls	100 gr.	3 1/2 oz.
3 balls	150 gr.	5 1/4 oz.
4 balls	200 gr.	7 oz.
5 balls	250 gr.	8 3/4 oz.
6 balls	300 gr.	10 1/2 oz.
7 balls	350 gr.	12 1/4 oz.
8 balls	400 gr.	14 oz.
9 balls	450 gr.	15 3/4 oz.
10 balls	500 gr.	17 1/2 oz.
11 balls	550 gr.	19 1/4 oz.
12 balls	600 gr.	21 oz.
13 balls	650 gr.	22 3/4 oz.
14 balls	700 gr.	24 1/2 oz.
15 balls	750 gr.	26 1/4 oz.
16 balls	800 gr.	28 oz.
17 balls	850 gr.	29 3/4 oz.
18 balls	900 gr.	31 1/2 oz.
19 balls	950 gr.	33 1/4 oz.
20 balls	1000 gr.	35 oz.

## PRACTICAL HINTS

There are two beautiful Shawls with long fringe in this issue of KNITKING MAGAZINE and we thought you would like to know how to make the fringe hang beautifully... When you have completed the fringe, heat water in your tea kettle until a steady stream of steam pours from the spout. Carefully hold the fringe (a bit at a time of course) over the live steam and watch all the crinkles fall out. When you have steamed all of it, trim the fringe evenly in this manner. Place the Shawl on a table, with the fringe ends over the table edge, pull the fringe back so that only the part that needs to be cut off hangs over the edge. You can put a bit of tape on the table to mark where the top knots line up. Now use a yardstick and lay it across the fringe. Have someone hold the yardstick or you can put some heavy books on top of the yardstick to hold it. Now cut the fringe evenly along the edge of the table.

KNITTED TRIM for Pullover DK 8012 in this issue. Use Subita Crepe 2 x 3 or Subita Dralon 3-ply. TENSION: 1 or 2.

Bring 8 needles into working position. Counting from the right side, push the 5th needle back to the out of work position. Cast on over the remaining 7 needles and knit 2 rows. \*Counting from the Right, push into holding position, needles 3, 4, 5, 6, 7. Knit 4 rows over the remaining 2 needles (do not wrap the yarn). Bring all the needles into working position and knit 6 rows. REPEAT from \* for as long as you need.

You can vary this Trim for other garments. Use the same needle set-up but knit 6 rows over the 2 needles and 4 to 6 rows over all of the needles. Another narrow version is to cast on over 5 needles, knit 4, 6, 8 or 10 rows over the 2 end needles, then 4, 6, or 8 rows over all the needles. Have fun!!

## A LESSON IN COURAGE

When the Federation of the Handicapped in New York asked us to provide a teacher to help them with their KNITKING machines - used for preparing handicapped youngsters for work - we immediately thought of Lorraine Aitken of the Bronx..Lorraine has been a KNITKING customer for many years and for some time now, has helped us by giving instruction to KNITKING owners in her area... She also gives demonstrations to potential customers and is lavish in her praise for the simplicity of operation and versatility of KNITKING Knitting Machines... We understand that when she demonstrates on her own machine, she does everything but make it stand up and dance... Now, that in itself is nothing unusual... everybody seeing KNITKING for the first time expresses amazement... what is unusual is the fact that Lorraine is sightless...!!

She makes complete garments from KNITKING MAGAZINE Her Mother puts them on tape and she follows them, even the fancy stitches... She says she has a seeing finger... she types all her own correspondence and her letters are perfectly composed, without error... Lorraine was not always blind. She, in fact, worked for twenty years as a typist. She had what is known as tunnel vision and, to use her own words "it konked out on me in 1966". Hers is a display of courage and determination from which we can all benefit.

## KNITKING YARNS ON SALE

All subscribers to KNITKING MAGAZINE living in the U.S.A. recently received literature in regard to our Pre-Inventory Sale of yarns and other KNITKING merchandise... Study the literature and you will see that there is a big saving on all the yarns we use for the garments in the magazine... Take advantage of these savings now and order yarn for all the garments you have been promising yourself you would make from back issues of KNITKING MAGAZINE... Select something you like from this issue and order yarn for it... The savings are quite substantial.



USED MACHINES OF OTHER BRANDS

We take hundreds of machines in trade on KNITKING machines... Many of them are in brand new condition... Some have never had a garment made on them... We offer them for resale twice a year and have a good selection for you to choose from now... All machines listed are sold on a cash with order basis and sent out freight collect... The prices are so low, they are almost silly... They are sold on "first come, first served" basis. We have several of each brand and if any that you order are sold out when your order arrives, we will return your money to you... You can also use your BankAmericard or Master Charge Card and if you send a personal check for any substantial amount, you will receive your machines much faster if you have the check certified.

KNITKING SALE OF TRADED MACHINES

<u>Single Bed</u>			<u>Condition</u>	<u>Sale Price</u>
Brothers	550	Sells for \$79.50	Excellent	\$30.00
	551	Sells for \$129.50	Excellent	\$50.00
	Other		Very good	\$40.00
	551	With Ribber Sells for \$229.00	Excellent	\$90.00
	551	With Ribber Sells for \$229.00	Very good	\$80.00
	521	With Ribber	Very good	\$50.00
Empisal (Sears)	250	Sells for \$179.50	Excellent	\$45.00
Empisal	Instant	Sells for \$69.50	Excellent	\$20.00
Genie	Jiffy	Sells for \$59.50	Excellent	\$20.00
	1500	Sells for \$99.50	Excellent	\$45.00
	1800	With Ribber Sells for \$199.00	Excellent	\$100.00
Speed-O-Knit		Gold color with Automatic Lock Sold for \$269.50	Excellent	\$45.00
Studio	305	Sells for \$200.00 Like New	Excellent	\$125.00
	SK 8	With Ribber	Very good	\$45.00
Tricoss	180	needles	Very good	\$30.00

DOUBLE BED

Swiftomatic	400	needles - like new - never had a garment made on them	Excellent	\$125.00
	400	needles - Used	Excellent	\$75.00
Swiss Magic	400	needles	Excellent	\$75.00
Turmix	400	needles Sells for \$399.00	Like new	\$100.00
	400	needles	Excellent	\$75.00
Toyota	K203	400 needles - 3 color automatic changer - Commerical type - has it's own table Sells for \$499.00	Excellent	\$150.00

ALL PRICES F.O.B. Los Angeles

## ARE YOU UNHAPPY WITH YOUR PRESENT KNITTING MACHINE ?

DOES IT REFUSE TO KNIT FANCY DRESS YARNS?

DOES IT JAM UP WHEN YOU TRY TO KNIT LOOPED MOHAIR OR THICK AND THIN YARNS?

DOES IT DROP STITCHES ALL OVER THE PLACE?

ARE YOU CONTINUALLY HAVING TROUBLE WITH AWKWARD, CUMBERSOME WEIGHTS?

ARE YOU UNABLE TO MAKE A LARGE GARMENT WITH BULKY YARNS?

DO YOU HAVE TO SELECT PATTERN STITCHES MANUALLY?

DO YOU HAVE TO LATCH YOUR RIBBING BY HAND?

IF YOU ARE HAVING ANY OF THESE PROBLEMS YOU SHOULD TRADE UP TO A NEW FANTASTIC PUSH BUTTON KNITKING WITH COORDINATED RIBBER AND ENJOY KNITTING WITH THE WORLDS FINEST, MOST VERSATILE AND MOST AUTOMATIC KNITTER.

YOU WILL BE SURPRISED AT OUR GENEROUS TRADE-IN ALLOWANCE AND YOU CAN, IF YOU WISH, USE YOUR PRESENT MACHINE AS A DOWN-PAYMENT AND PURCHASE A COMPLETE KNITKING FOR JUST PENNIES A DAY. WRITE TODAY FOR FULL INFORMATION AND TELL US WHAT MACHINE YOU NOW OWN. THE ADDRESS IS:

**KNITKING, Dept. T-1, 1128 Crenshaw Blvd., Los Angeles, Calif. - 90019**



# NOTES TO KNIT BY . . .

## STITCH AND ROW GAUGE

KNIT A SAMPLE SWATCH . . . before you begin to knit any garment . . . for this is the MOST IMPORTANT STEP toward the correct size and the proper fit of any garment you wish to make. You MUST use the SAME YARN for your sample swatch that you will use to knit your garment and your sample swatch must be knitted large enough and using several different tension numbers on your machine. When you have done this, then you can determine the number of stitches and the number of rows in a two-inch measure. KNITTING MAGAZINE PATTERNS give you 3 tensions to try and one of them should give you the correct stitch and row gauge if you are using the yarn we recommend or a similar weight yarn. Here is the way to make your sample swatch.

Cast on over a sufficient number of needles to produce a swatch at least 4 inches wide. (If the pattern calls for 16 stitches to 2", then  $16 \times 2 = 32$  stitches to cast on). Now knit 4 inches of rows at the first suggested tension number. (If the pattern calls for 22 rows to 2",  $22 \times 2 = 44$  rows to knit). Knit 2 rows using a contrast color, change to the next higher tension and with garment yarn knit another 4", knit 2 rows with contrast color, change to the 3rd higher tension and knit another 4" and then bind off.



Roll the swatch into a cylinder over its length and pull on both ends, unroll it and stretch it diagonally by pulling on the four corners. Allow the swatch to rest and settle (preferably overnight) and then using a stitch gauge or a ruler, count the number of stitches over a 2" width, then the number of rows over a 2" length in EACH of the 3 tensions. Select the tension number that produces the stitches and rows called for in the pattern. If none of them are correct, you are most likely using the wrong weight of yarn.



## READING OF CHARTS

You will notice the instructions start at the bottom of the Chart and work UP. Follow the charts exactly as written and providing your sample stitch and row gauge is correct, your garment will come out the right size. Please remember that the section of garment as it is knitted on the machine, faces the same way as the Charts are in this magazine. Where two front pieces are needed, (or any other part of a garment that needs two sections) only one section is normally shown and the second section is usually made with reverse shapings. Set in sleeves are usually identical, but raglan sleeves have to be knitted with reverse shapings for the second sleeve.

## READING OF SYMBOLS

To simplify Pattern Knitting, we use Symbols in the Line Drawings and the Chart Diagrams. In the Line Drawings the symbols are shown and are to be read as you look at them while knitting a garment. For instance, if

a Purl stitch faces you, the Purl stitch Symbol  is shown; if a knit stitch faces you (as when using the Ribber) then this Symbol  is shown. The Symbol  at the top of the Line Drawing is the center of the garment section and you use this as a guide for setting up the needles.

The following Symbols    are used for Eyelet Designs in the Line Drawings and also for Full Fashion shaping on the Charts. The Line Drawings have row numbers on the right side. Missing Row numbers are always knitted straight or plain.

In Holding Position Designs  selected needles are pushed into holding position for the stated number of rows. The numbers of rows appear at the right of the Line Drawings; Example: 1-4 means knit Rows 1 to 4; 5 to 7 means knit Rows 5 to 7, etc. This same Symbol is also shown on the Charts and is used for putting needles into holding position for Short Rows. The

Symbol  on the Charts is used to put needles back into working position when knitting Short Rows.

A number in a box stands for the number of rows to be knitted between shapings. Make shaping first, then knit the necessary number of rows. If for instance it reads:

1 st. 8 x



1 st. 10 x



As you will be reading the instructions from the bottom up, here is the way you will follow them: . . . Decrease or increase (depending on the direction of the garment outline) 1 st. at the row where the shaping begins, then knit 8 rows, make the next decrease, then knit 8 rows, until you have decreased (or increased) 1 st. 10 x and you have knitted 8 rows after each decrease (or increase) (1 st. 10 x + 8 rows 10 x). Now begin the first decrease (or increase) for the shaping (which has to be made 8 x) in every 6th row. Decrease (or increase) 1 st. first, then knit 6 rows until you have decreased 1 st. 6 x and after each decrease (or increase) have knitted 6 rows (1 st. 8 x + 6 rows 8 x).

Where shapings are given without a boxed number as on most armholes, necklines, etc., make the shapings on every second row (on each side of course).

(See below for more Pattern Stitch Symbols.)

### PATTERN STITCH SYMBOLS



= knit stitch



= purl stitch



= empty needle (leave in working position)



= needle not used (in the out of work position)



= needle in the holding position



= Needles back into working position.



= 2 stitches on 1 needle - either transferred from the right side or the left side, then put the needle into holding position



= needle holding 2 stitches. Stitch has been transferred from the LEFT



= needle holding 2 stitches. Stitch has been transferred from the RIGHT



= 3 stitches on 1 needle. The 1st and 3rd stitch in a group of 3 needles has been hung on the 2nd or center needle.



= Center of Garment Section.



= Number of rows to be knitted between shapings.

The diagrams (Line Drawings) for pattern work are followed just as they are shown and are to be read as you look at them while knitting the garment.

open darts



closed darts





