

## USING THE KNIT LEADER

### SETTING THE KNIT LEADER

1

Pull out the setting plates from the knit leader.  
\*Do not use these setting plates, but keep them.

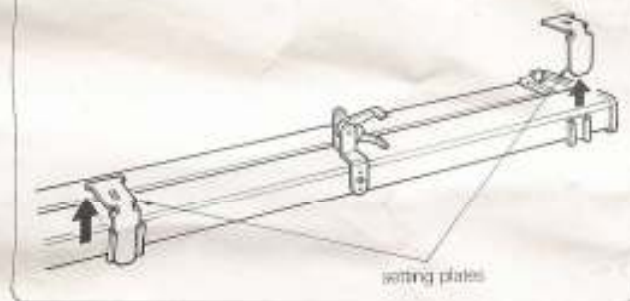

2

Insert the KL brackets into the right and left holders.

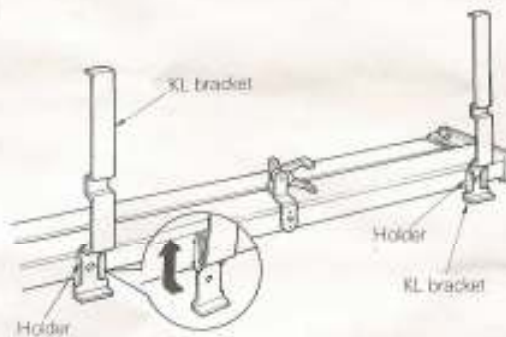

3

Put the knit leader on the table and adjust the position so that the hooks of the brackets meet the edge of the table.

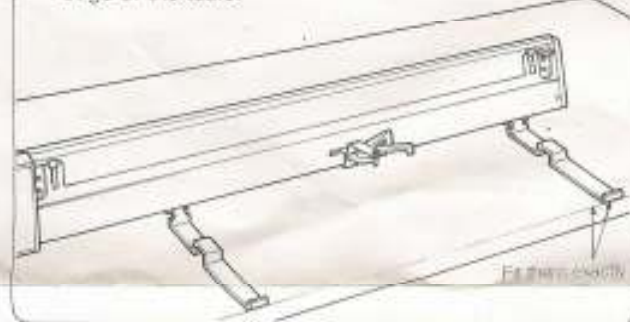

4

Turn out the feeding lever and insert the connecting pin into the left side hole of the feeding lever.

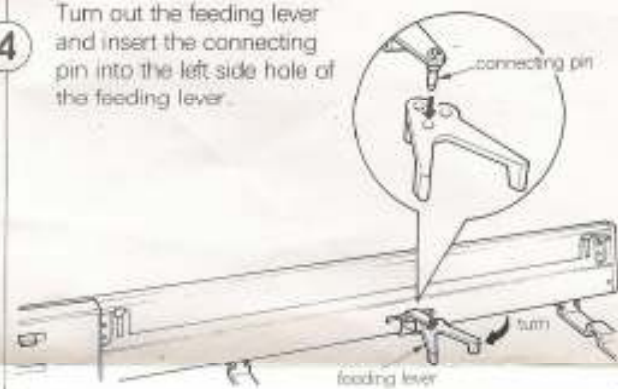

5

Attach the tension rod stand and row counter to the knitting machine.  
Put the knitting machine on the KL brackets pressing the machine against the part A of the KL bracket.

Turn the feeding lever to the left and make sure that the feeding lever does not hit against the row counter.

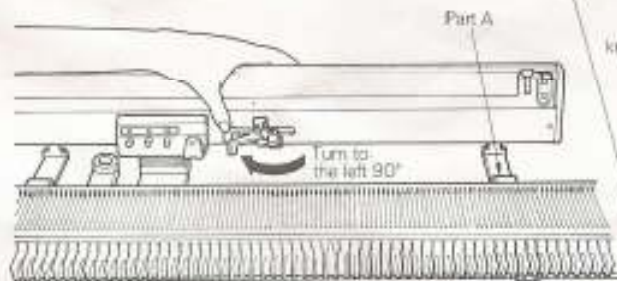

[From side]

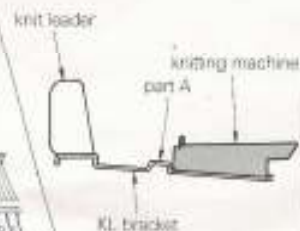

6

Make sure that the hooks of the brackets hold the knitting machine securely.  
Pull out the two table clamps and turn it until becomes vertical. Fasten the table clamps.

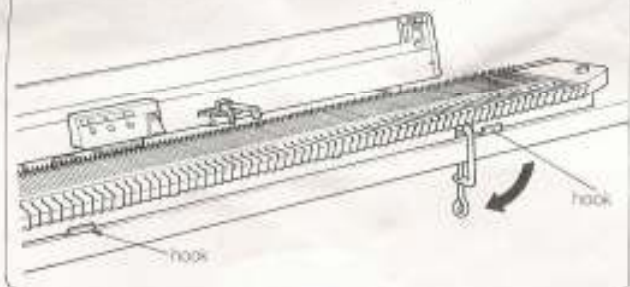

7

Insert the tension rod into the stand and push up the rear guide until it becomes about 10cm away from the tension head. Attach the yarn rest to the knitting machine.

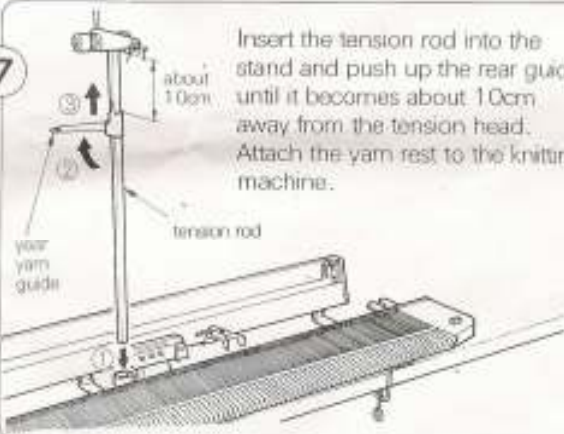

8

Insert the sheet guides (one each at right and left) to the rear side of the knit leader.

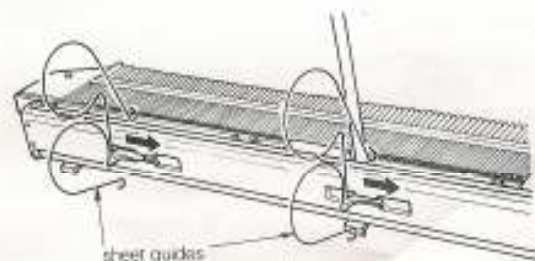

### KNITTING A TENSION SWATCH AND PATTERN DRAWING

Methods of tension swatch knitting and pattern drawing depend on the gate pegs you use.

A

When you use 4.5mm pitch gate pegs...

Measure the width of 40 stitches and length of 60 rows.  
Draw your pattern on the sheet in the actual size.

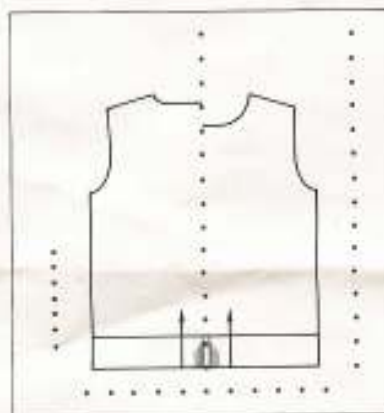
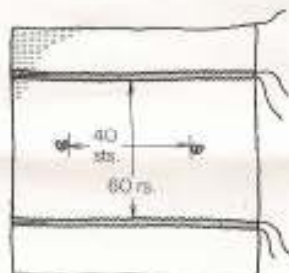

B

When you use 9mm pitch gate pegs...

Measure the width of 20 stitches and length of 30 rows.  
(When you need to set the measure scale for 40 stitches, instead set the scale for 20 stitches.)

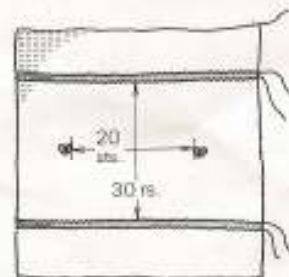

When you need to set the regulator for 60 rows, instead set the regulator for 30 rows.  
Draw your pattern on the sheet in the half size.

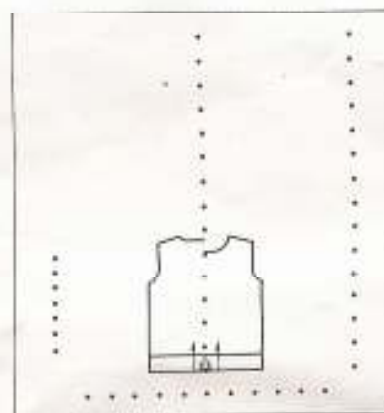

- Refer to the "Tension Swatch 1" on the knitting machine manual to know how to knit a tension swatch.
- When you use knit leader with 7mm pitch knitting machine, use the method B, but if the width of 20 stitches is less than 8cm or the length of 30 rows is less than 6cm, double the width of 20 stitches and length of 30 rows to get the measurement of 40 stitches and 60 rows and use method A.

#### NOTE

- Make sure that the carriage kicks the feeding lever every row.
- For detail instruction except explanation on this sheet, refer to the pages of knit leader manual from 8.



23.3 cm. Overall  
r 11 cm 7

2.5  
cm

r 5.7 cm. 7

4 ● cm

23.3 cm. Overall  
r 11 cm.

2.5  
cm

5.7 cm

4 ● cm