

knitking

magazine



nov/dec '70

Accessories

1. Treble Transfer-Tools. For rapid transfer of stitches and for cable stitch. \$1.50 pair plus 25c shipping.
2. Yarn Winder and Skein Holder. Heavy cast frame and nylon gears. \$15.95 plus \$1.00 shipping.
3. 33 Needle Multi-Transfer Tool. For decreasing in the middle of a row. \$3.25 plus 25c shipping.
4. Adjustable Needle Selector. For setting unevenly spaced pattern stitches. \$3.50 plus 25c shipping.

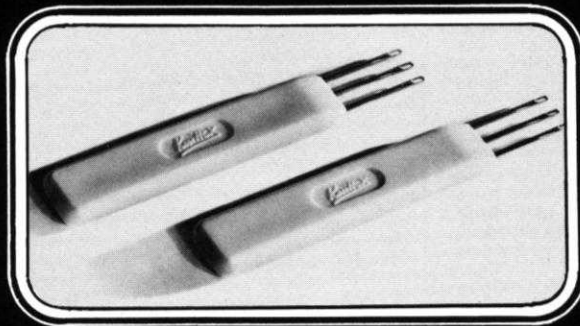

5. Reversing Bar. For easy hem turning or reversing of knitting. \$17.95 plus \$1.50 shipping.
6. Automatic Pattern Selector. For all KNITTING machines prior to Push Button. \$7.95 plus 35c shipping.
7. Converta Tape. For simple and speedy charting of custom knits. \$6.95 plus 30c shipping.

California residents add
5% sales tax.

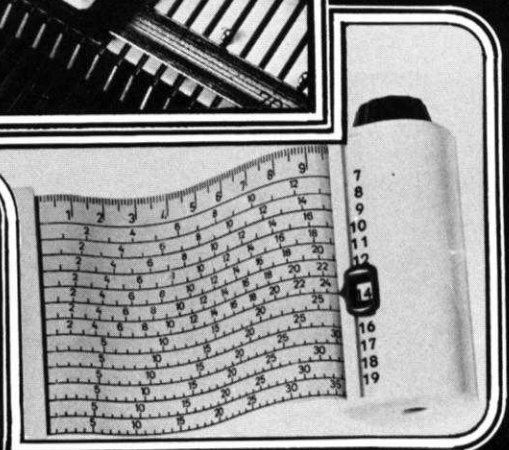
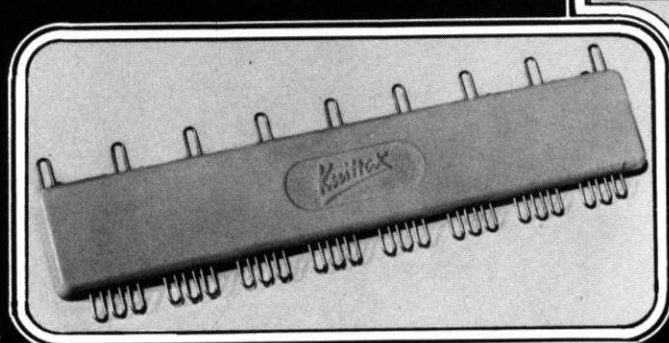
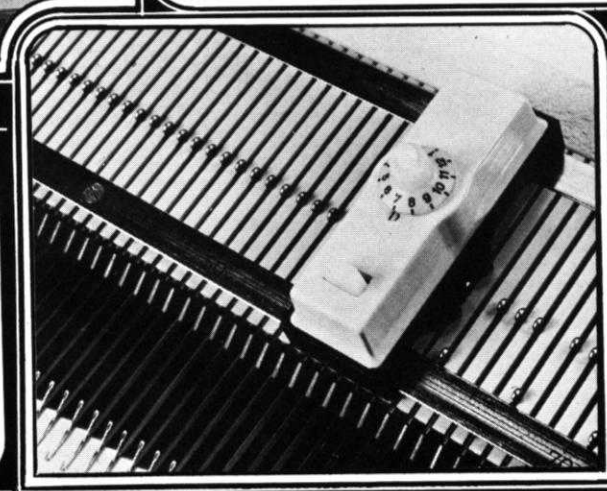
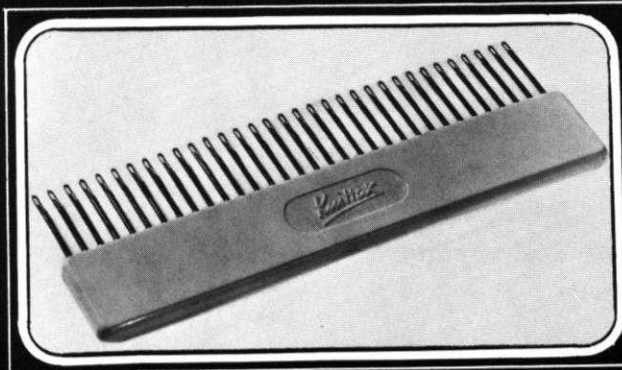
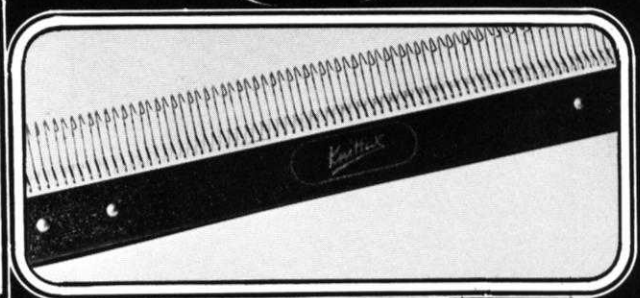
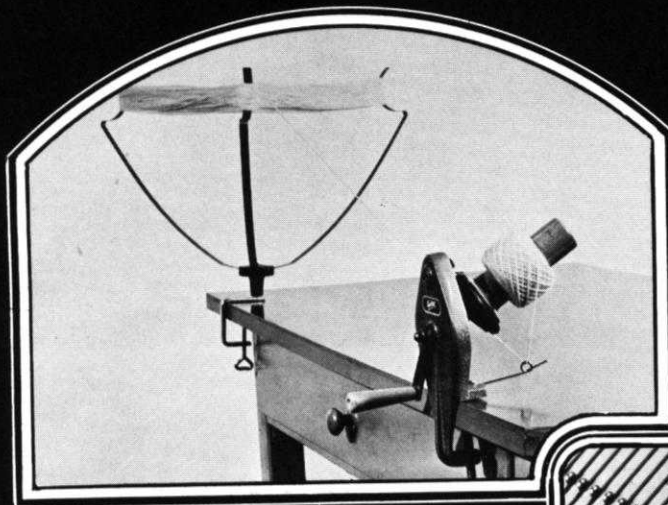

knitking

magazine

INDEX		PAGE NO.
DK	7850	Woman's Dress 12
DK	7852	Woman's Pullover, Slacks & Tunic . . 13
DK	7929	Woman's Skirt & Vest 16
DK	7925	Woman's Dress 17
DK	7926	Woman's Pantsuit 18
DK	7934	Woman's Pantsuit 21
HP	3611	Man's Pullover 22
DP	7853	Woman's Pullover 23
DP	7854	Woman's Pullover 24
HP	3612	Man's Pullover 25
DP	7857	Woman's Pullover 26
KK	5231	Boy's Pullover 27
KK	5230	Boy's Pullover 28
MK	5229	Girl's Pullover 29
HP	3608	Man's Pullover 30
KG	1912	Slippers 31
KG	1913	Indian Headband 31
KG	1914	Indian Necklace 31
KG	1915	Santa Claus Doorknob Cover 31
KG	1916	Toy Snake 32
KG	1917	Chickie 32
KG	1918	Lace Bun Bonnet 32
KG	1919	Key Chain Ball 32



We're in a festive mood . . . all set for any Winter Scene or Holiday Happening. You'll wear the smartly designed Pantsuits on many occasions . . . The beautiful Norwegian Designs for the Pullovers and our Cover Model Dress will inspire you to knit up a storm for yourself and members of your family . . . Small Gifts . . . knitted

in a jiffy, are sure to delight those on your special list . . . The Cover Model Dress DK 7850 is knitted in KNITKING Excelsior using your JAC 40 and Pattern No. 418 . . . or you may follow the Line Drawing. Size 10/12. See page 12.

HP 3608 (on the back cover)

Your favorite Sportsman will surely want this warm Norwegian designed Pullover. Use 4 colors of KNITKING Crocus and follow the Line Drawing or use your JAC 40 and Pattern No. 416. Size 42/44. See page 30.

Publisher: KNITKING CORPORATION, 1128 Crenshaw Blvd., Los Angeles, Calif. 90019. Telephone: WEbster 8-2079. Published bi-monthly. Subscriptions: USA — \$6.00 annually, single copies \$1.50; Canada — \$7.00; other parts of the world — \$10.00. The entire contents of KNITKING MAGAZINE are copyright and must not be reproduced in any shape or form without the express permission, in writing of the publisher. COPYRIGHT © by KNITKING CORPORATION 1970.

Printed by George Rice & Sons, Los Angeles, California



KNITKING
1128 Crenshaw Blvd.
Los Angeles, Calif. 90019

ORDER IT NOW!

Every reader of KNITKING MAGAZINE needs the new big beautiful KNITKING YARN CATALOGUE with 329 actual yarn samples . . . the finest from around the world in an unbelievable range of colors.

I enclose one dollar . . .
Please RUSH my beautiful new
KNITKING YARN CATALOGUE to me at:

Name _____

Address _____

City _____ State _____ Zip _____

BOOKS by KNITTING

KNITTING CHILDREN'S BOOK

The Big, beautiful book of children's patterns. Over 50 complete and lovely patterns for infants and children to teenage. Buntings, Blankets and Baby outfits, cute Dresses, Leotites, Skirts, Suits, Pull-overs, Cardigans, Stockings, Trousers, etc. . . . The only Children's Book for the machine knitter published in the U.S.A. It sells for **\$2.95**

40 cents mailing
Calif. residents add 5% Sale*



PRACTICAL KNITTING HINTS

We call this book the TEXT BOOK for machine knitters because it answers the many questions that occur in machine knitting, from preparing to knit, taking measurements, shaping, making button-holes, special effects, bindings, bands and edges, etc., through finishing and blocking. It sells for **\$2.95**

40 cents mailing
Calif. residents add 5% Sales Tax

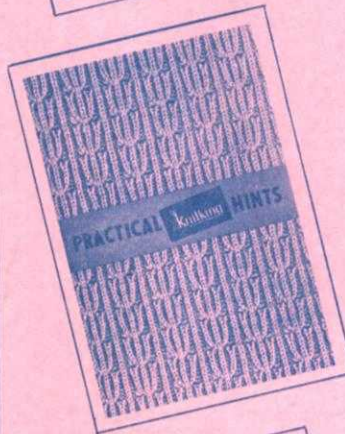

COLLECTING FILE

Keep your valuable KNITTING MAGAZINES in mint condition in a Collecting File. Each file holds twelve issues. **\$2.95**

75 cents mailing
Calif. residents add 5% Sales Tax

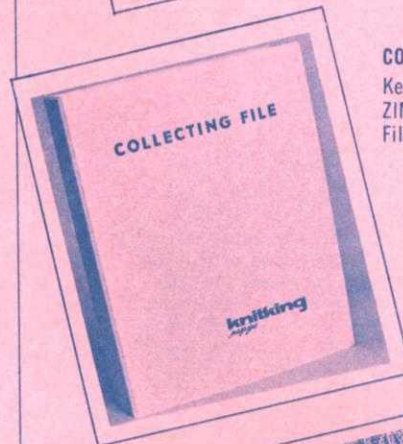

INTERCHANGEABLE YARN CHART

Specially prepared to allow you to substitute Nationally distributed brand name yarns for the KNITTING YARNS used in KNITTING MAGAZINE. CHARTS are complete with ROWS and STITCHES per inch at various Tensions. Order from KNITTING, 1128 Crenshaw Blvd., Los Angeles, California 90019.

\$1.00
plus 12 cents mailing
Calif. residents add 5% Sales Tax



NEW VOLUME AVAILABLE NOW

A complete sixth volume of KNITTING MAGAZINES with a flexible, transparent plastic cover and specially bound so that it will stay open at any page, is available at the special price of \$6.95 (plus 85 cents mailing costs).

If purchased separately the magazines would cost a total of \$9.00.

The volume contains over 120 fully illustrated complete stylish patterns for all members of the family together with many valuable, practical knitting hints.

There is a very limited number of these volumes available and it will undoubtedly become a collectors item.

If you already have the entire set it will almost certainly be well thumbed and marked. Why not purchase a perfect mint condition volume for your bookshelf and ready reference at any time.

Place your order today and avoid disappointment. Send it to KNITTING MAGAZINE, 1128 Crenshaw Boulevard, Los Angeles, California 90019.

I enclose \$7.80
Please RUSH my bound Sixth Volume of
KNITTING MAGAZINE to me at:

Name _____

Address _____

City _____ State _____ Zip _____

knitking *magazine*

In our continuing efforts to improve KNITKING MAGAZINE and satisfy the needs of our readers, we sometimes wonder how we can 'top' certain issues . . . Our September-October edition was such an issue . . . So when we got together with our knitting experts to determine the contents of this issue and with our art department to plan its layout, we had quite a task on our hands . . . But, we think that this Christmas issue is one of the best we have ever published . . . And that the January-February 1971 issue will present quite a challenge.

We include 8 easy to make fun things for gift giving at Christmas in this issue. The knitted snake was not originally intended for use in the magazine, but one of the girls in the office made it up as a toy for "Tiger" . . . KNITKING's favorite Poodle . . . It caused such comment in our store . . . So many people asked how to knit it, we decided to include it . . . We are confident that every reader will find something to make for friends and relatives . . . Such hand crafted gifts are always acceptable and so inexpensive to make. We know several readers who solve all their gift problems each Christmas by knitting up dozens of pairs of slippers.

The biggest current demand from readers is for pants suits . . . We have three in this issue and will be including another three in the next . . . One features an eyelet design on the pants and on the long sleeveless vest. The second has a top with short sleeves and a V-neck . . . The third a long sleeved tank top with a higher neckline and side slits . . . They are all new and original KNITKING designs.

The January-February issue will also contain an unusual dress and tunic outfit following the new layered look. A figure flattering side button dress with a jacquard border . . . The cover garment will be a very handsome two piece suit specially designed so that it is very easy to make . . . We will have some high neck pullovers for men . . . One of them following the belted trend, plus several unusual outfits for the youngsters.

We take great pleasure in wishing all our readers a joyous Christmas and peace and contentment for 1971.



LETTER
from the
PUBLISHER

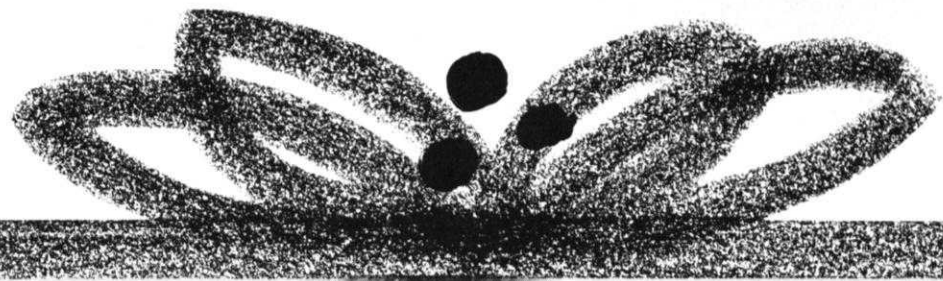

DK 7852

Purr-fect for day or evening wear is our beautifully styled 3 piece Pant-suit. Knit it in KNITKINGS' Subita Crepe 2 x 3. The Tunic top has a zippered front closure and both Pullover and Tunic have a Norwegian Border Design at lower edge. Follow the line drawing or use JAC 40 and Pattern No. 420. Size 8/10. See page 13



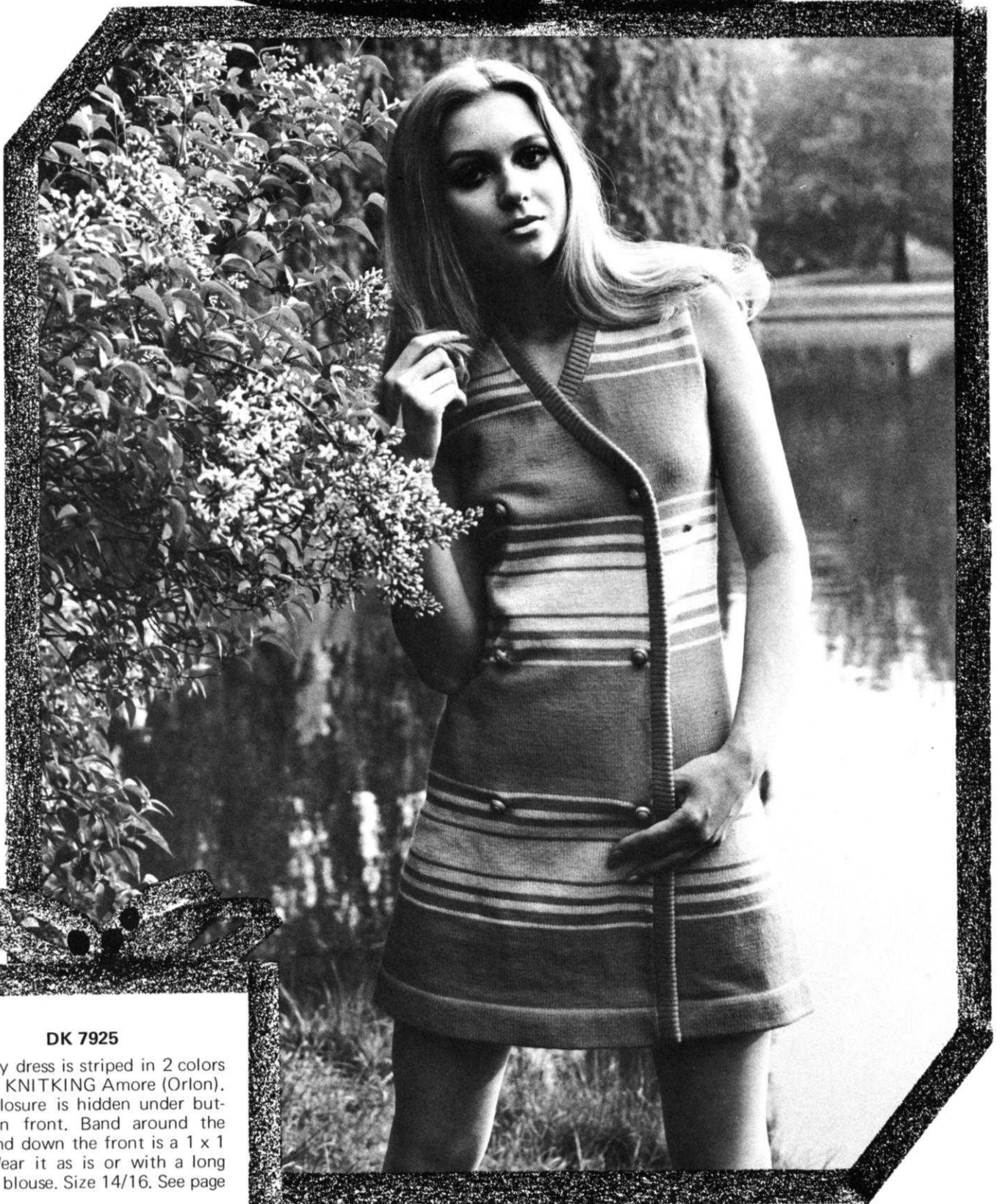

DK 7925

A lovely dress is striped in 2 colors of lush KNITKING Amore (Orlon). Snap closure is hidden under buttons on front. Band around the neck and down the front is a 1 x 1 Rib. Wear it as is or with a long sleeved blouse. Size 14/16. See page 17.



DK 7926

A smartly tailored Pantsuit is knitted in stockinette stitch with KNITKING Excelsior. You have a choice of short sleeves as shown in Photograph or long sleeves included with Pattern. The Collar, sleeve edges and top of large pockets are ribbed. A zipper is used for closing the front. Size 16/18. See page 18.



DK 7929

Look smart and fashionable in a Skirt with a matching Vest. The Skirt is knitted in 6 sections then woven together. The Vest has an Eyelet Design on the front section. Use a 1 x 1 rib for the Bands. KNITKING Crocus Crepe. Size 18/20. See page 16.



HP 3611

A patterned V Necked Pullover for a Man is knitted in a Holding Position Design that follows the line drawing. KNITKING machines may use Wheel 6 and the Needle Shifter. The yarn... Blue and White KNITKING Fortissima... a long hard wearing sport weight yarn. Size 38/40. See page 22.

DP 7853

Red and White KNITKING machine washable Crocus Crepe makes a beautiful Norwegian Design Pullover. Follow the Line Drawing or use your JAC 40 and Pattern No. 417. Size 14/16. See page 23.

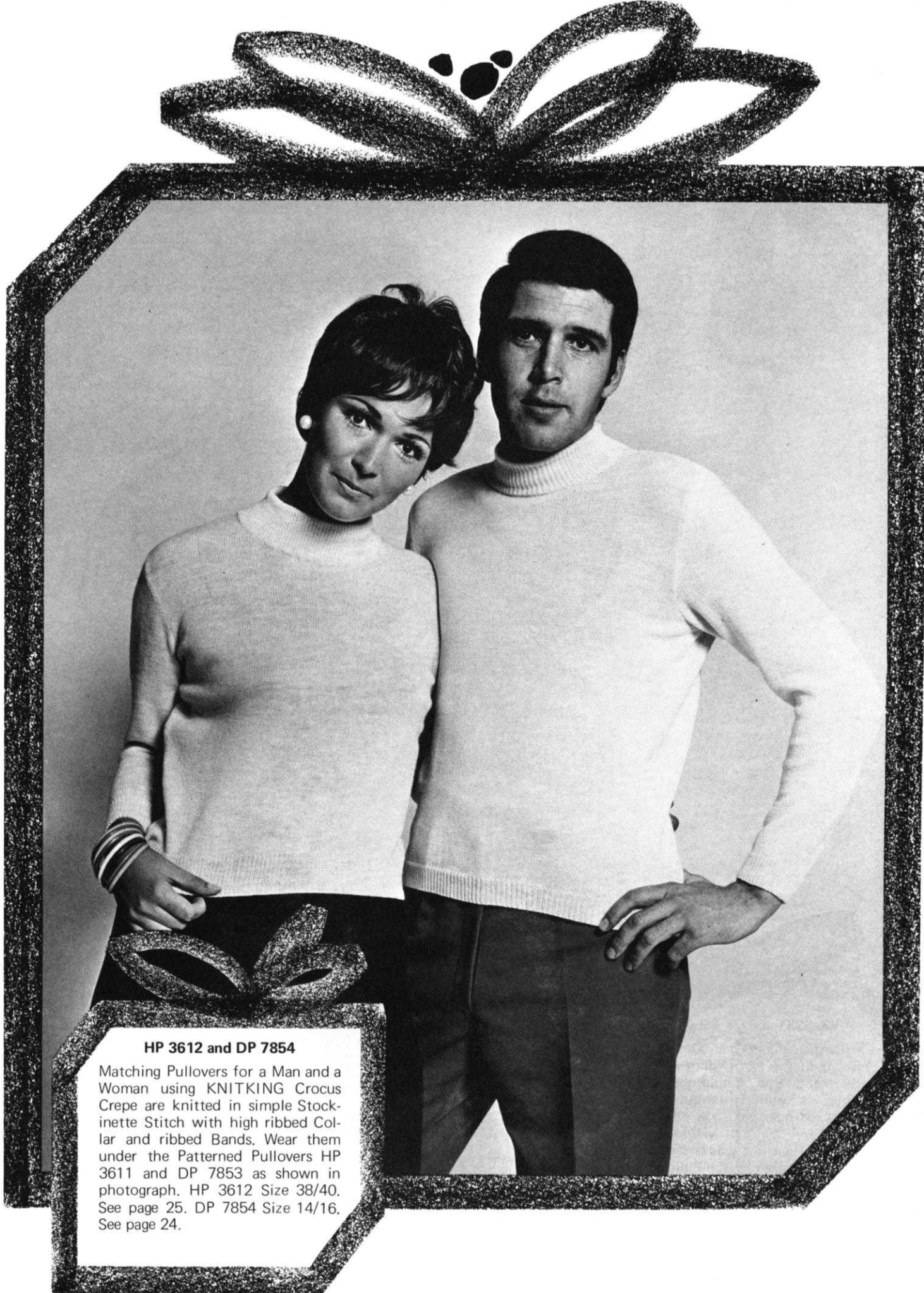

HP 3612 and DP 7854

Matching Pullovers for a Man and a Woman using KNITTING Crocus Crepe are knitted in simple Stockinette Stitch with high ribbed Collar and ribbed Bands. Wear them under the Patterned Pullovers HP 3611 and DP 7853 as shown in photograph. HP 3612 Size 38/40. See page 25. DP 7854 Size 14/16. See page 24.



KK 5231 and DP 7857

The identical Norwegian Design is used to knit the warm Pullovers for Mother and Son (could be for daughter as well). Different color schemes change the look of the design. Use 4 colors of KNITKING 100% wool machine washable Crocus Crepe for each of the Pullovers and follow the Line Drawing or use your JAC 40 and Pattern No. 430. KK 5231 Size 6 to 8. See page 27. DP 7857 Size 14/16. See page 26.

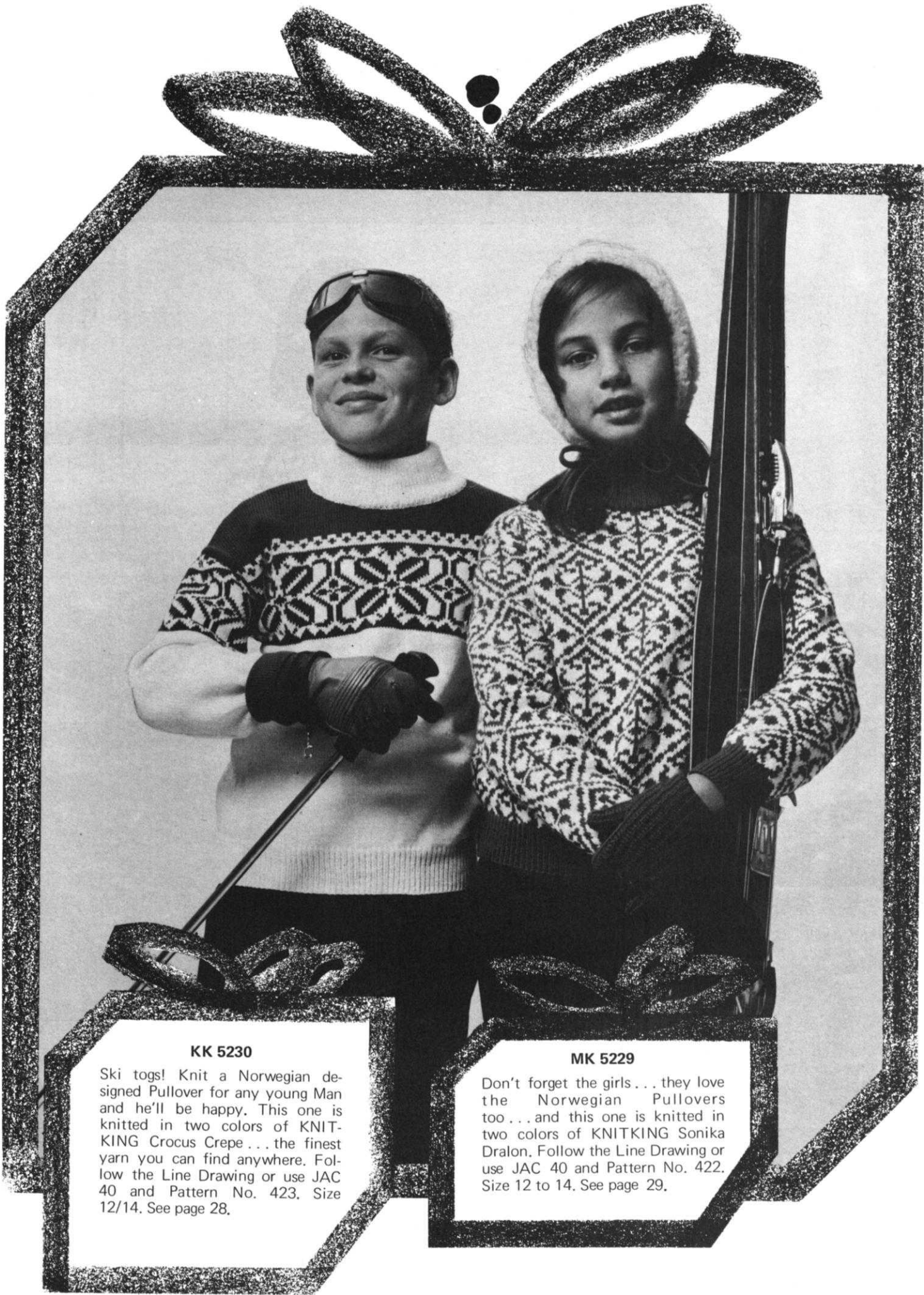

KK 5230

Ski togs! Knit a Norwegian designed Pullover for any young Man and he'll be happy. This one is knitted in two colors of KNITKING Crocus Crepe . . . the finest yarn you can find anywhere. Follow the Line Drawing or use JAC 40 and Pattern No. 423, Size 12/14. See page 28.

MK 5229

Don't forget the girls . . . they love the Norwegian Pullovers too . . . and this one is knitted in two colors of KNITKING Sonika Dralon. Follow the Line Drawing or use JAC 40 and Pattern No. 422. Size 12 to 14. See page 29.



DK 7934

Flattery will get you everywhere...and this delectable sleeveless Pantsuit is quickly knitted in stockinette Stitch with KNITKING Lovely. Purchase an embroidered border trim for the Tunic...or knit your own trim. The Slacks are knitted in two pieces and are slightly flared at the bottom. You'll love this Suit... Size 12/14. See page 21.

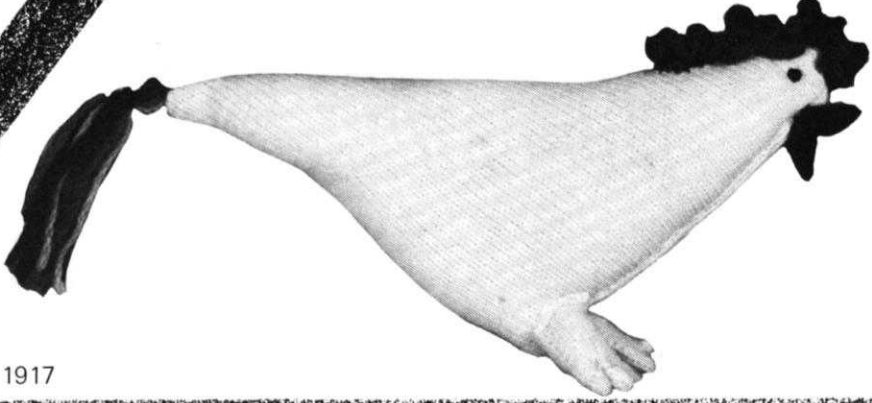
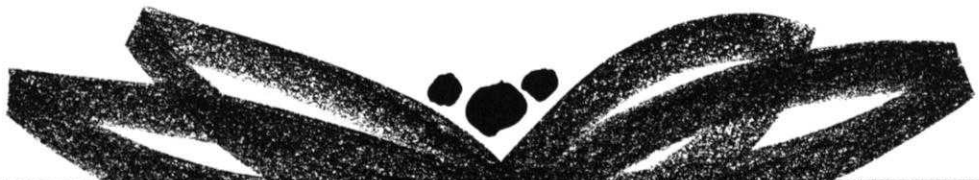

KG 1917

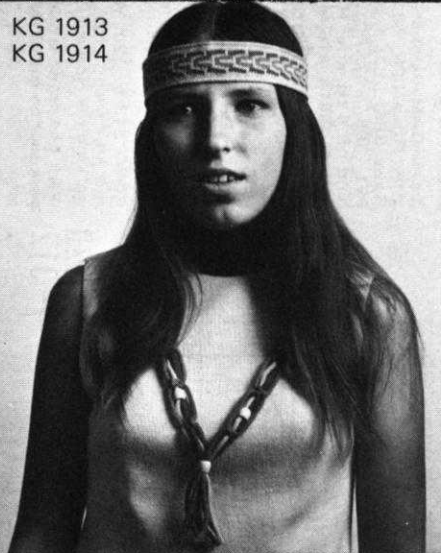

KG 1913
KG 1914



KG 1916

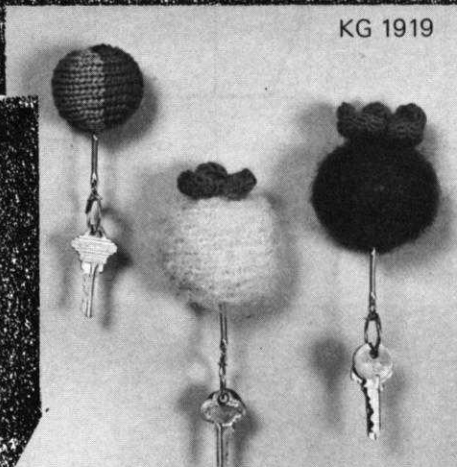

KG 1919

A whole bevy of gifts for Christmas giving. Each one takes a small amount of time and effort . . . and the results are simply great! . . . See pages 31 and 32.

- KG 1912 – Slippers
- KG 1913 – Indian Headband
- KG 1914 – Indian Necklace
- KG 1915 – Santa Doorknob Cover
- KG 1916 – Toy Snake
- KG 1917 – Chickie
- KG 1918 – Lace Bun Bonnet
- KG 1919 – Key Chain Ball



KG 1912



KG 1915



KG 1918

Move the Cam Box to the left side, turn the Row Counter back to 378 and complete the left half. Follow the instructions from *.

* ON CAM BOX SIDE, bind off 3 sts. after Rows 379, 381, 383; 2 sts. after Rows 385, 387; 1 st. after Rows 389, 391, 393, 397, 401. For SHOULDER bind off 4 sts. after Rows 404, 406, 408, 410, 412, 414, 416, 418.

ON CAM BOX SIDE, bind off 4 sts. after Rows 320, 321; 3 sts. after Rows 322, 323, 324, 325; 2 sts. after Rows 326, 327, 328, 329; 1 st. after Rows 330, 331, 332, 333, then knit to Row 378, bind off the center 15 sts., put the needles on the left side into holding position and complete the right half first.

ROWS 313 to 320: Work stockinette st. and knit even. After Row 320 continue working the Norwegian Design. Work the front section the same as the back section to ROW 312.

Move the Cam Box to the left side, turn the Row Counter back to Row 396 and complete the left half. Follow the instructions from *.

* ON CAM BOX SIDE, bind off 4 sts. after Row 396 (EVEN ROWS = SHOULDER SHAPING), 397 (ODD ROWS = NECK SHAPING), 398, 399, 400, 401, 402; 3 sts. after Row 403; 4 sts. after Row 404; 3 sts. after Row 405; 4 sts. after Rows 406, 408, 410.

ON CAM BOX SIDE, bind off 4 sts. after Rows 312, 313; 3 sts. after Rows 314, 315, 316, 317; 2 sts. after Rows 318, 319, 320, 321; 1 st. after Rows 322, 323, 324, 325, then knit to Row 396, bind off the center 15 sts., put the needles on the left side into holding position and complete the right half first.

ON EACH SIDE, increase 1 st. after Rows 242, 256, 270, 284, 298, then knit to Row 312 and continue working the Norwegian Design.

ON EACH SIDE, decrease 1 st. after Rows 66, 74, 82, 90, 98, 106, 114, 122, 130, 138, 146, then knit to ROW 150, change to white and work stockinette st. CONTINUE to decrease 1 st. ON EACH SIDE after Rows 152, 158, 164, 170, 176, 182, 188, 194, 200, 206, 212, 218, 224, then knit even to Row 242.

ROWS 19 to 66: Knit even. ROWS 0 to 18: Knit even, then begin the Norwegian Design. Cast on 185 sts. with white and work stockinette st.

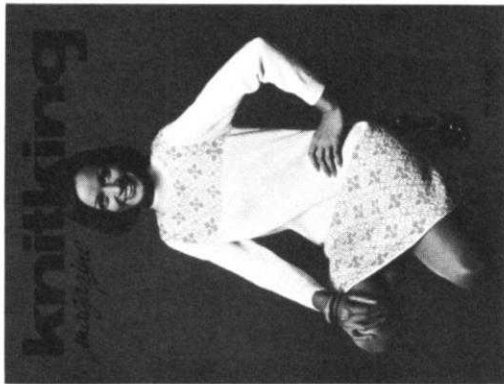

SIZE: 10/12. MATERIAL: 23% oz. (13 balls) white and 7 oz. (4 balls) turquoise. KNITTING Excelsior. TENSION: KNITTING 4 to 6. GAUGE: 16 sts., 2", 22 rows 2". PATTERN: Stockinette Stitch and Norwegian Design on Skirt and Yoke section according to Line Drawing or use JAC 40 and Pattern No. 418. In the instructions each row in the Norwegian Design is counted as 1 row, but several movements of the Cam Box are needed to complete 1 row. SLEEVE EDGES and COLLAR: K1, P1, Ribbing. DECREASES: While working the Norwegian Design, hang the 1st st. ON EACH SIDE onto the 2nd st., then continue with Full-fashion decreases as follows: ON EACH SIDE, hang the 3rd st. onto the 2nd st., then move the end sts. inward to fill the empty needle. INCREASES: ON EACH SIDE, move the 2 end sts. 1 needle outward, then place the 3rd st. from the row below onto the empty needle. The finished length of the dress is 35".

FINISHING: Block all sections to measurements given. Join front and back section at sides and shoulders, easing in the fullness at bustline of front section. Sew sleeves together and set in. Turn under 18 rows on lower edge and hem to wrong side. Join short ends of collar, then sew 1 edge of collar to inside and 1 edge to outside of neckline.

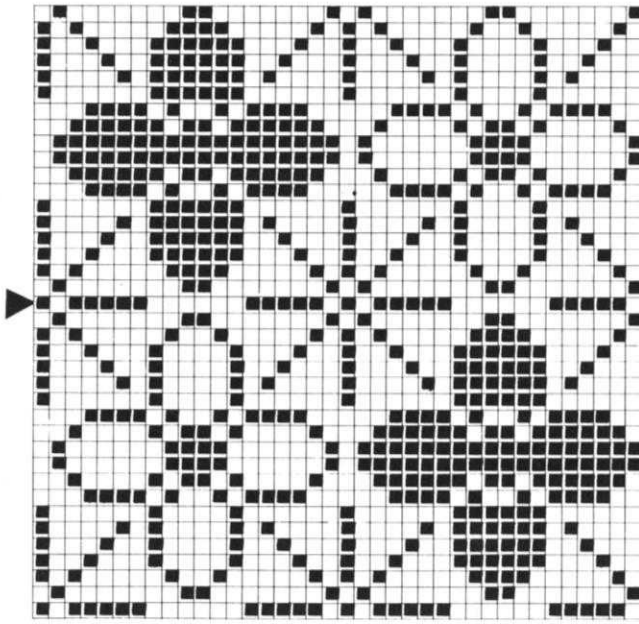

White ■ Turquoise

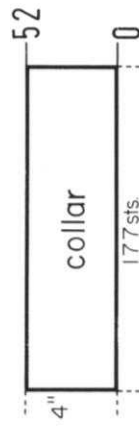

Cast on 177 sts. with white and work 52 rows K1, P1, Ribbing, then bind off all sts. the crochet method for ribbing.

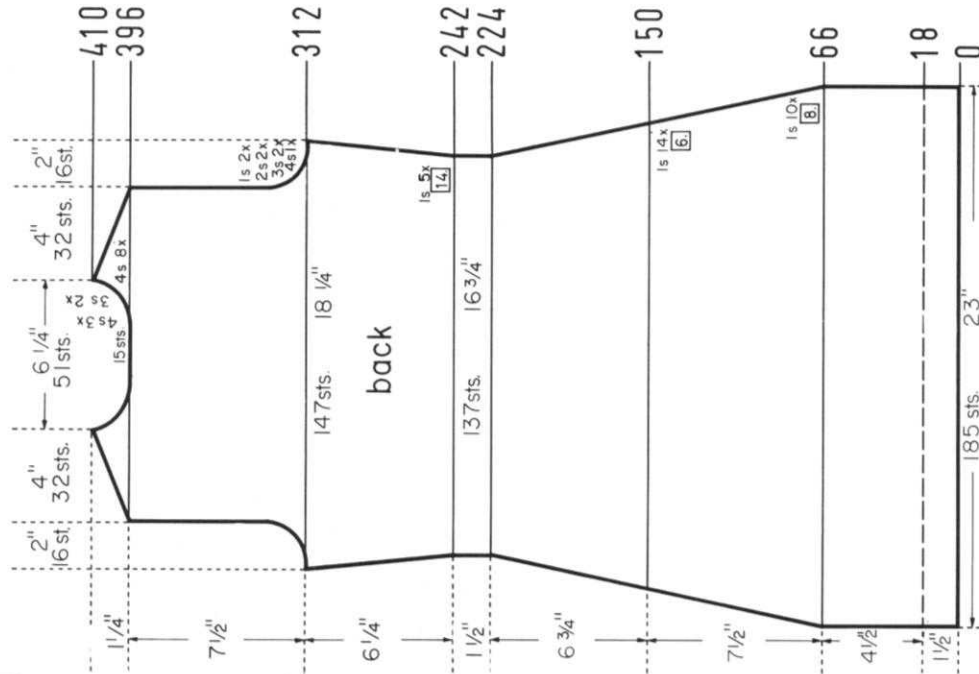
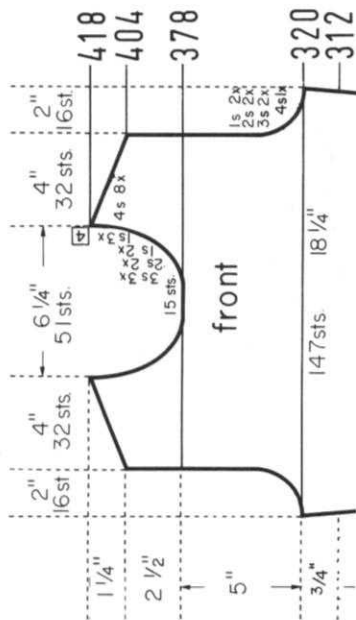

DK 7852

SIZE: 8/10. **MATERIAL:** Pullover 14 oz. (8 balls) black and 3 1/2 oz. (2 balls) white; Vest 1 1/2 oz. (1 1/2 balls) white and 3 1/2 oz. (2 balls) black; Slacks 1 1/2 oz. (1 1/2 balls) black KNITTING Subita Crepe 2 x 3 and a 16" Jacket Type Zipper. **TENSION:** KNIT-KING 3 to 5, GAUGE: Stockinette Stitch 18 sts and 2", 25 rows 2". **PATTERN:** Stockinette Stitch and a Norwegian Design on lower edge of Pullover and Vest according to Line Drawing or use JAC.40 and Pattern No. 420. **BANDS and Sleeve EDGES:** K1, P1, Ribbing. In the instructions each row in the Norwegian Design is counted as 1 row, but several movements of the Cam Box are needed to complete 1 row. Except the Pullover Armholes, make all shapings of 1 st. Full-fashion. **DECREASES:** After rows indicated, hang the 3rd st. on the appropriate sides onto the 2nd st., then move the end sts. inward to fill the empty needle. **INCREASES:** After rows indicated, move the 2 end sts. on the appropriate sides 1 needle outward, then place the 3rd st. from the row below onto the empty needle. Begin the SLACK DARTS by hanging the sts. together as marked on the diagram, then move the end sts. inward. The following decreases for the darts lie directly above. **FINISHING:** Block all sections to measurements given. **PULLOVER:** Join front and back section at sides and shoulders, easing in the fullness at bustline of front section. Sew sleeves together and set in. Turn under 16 rows on lower edge and hem to wrong side. Join short ends of collar, then sew 1 edge of collar to inside and 1 edge to outside of neckline. **VEST:** Join front and back sections at sides and shoulders, easing in the fullness at bustline of front sections. Turn under 7 sts. on front edges and 22 rows on lower edge and hem to wrong side. Join front bands to neckband, then sew band to fronts and neckline. Join short ends of armhole bands, then sew bands to armholes. Sew zipper in place. **SLACKS:** Weave front and back sections together at sides, 1 st. in from each edge. Close inner leg seams. Join the sections at center back and center front. Turn under 20 rows on upper edge and leg edges and hem to wrong side. Insert an elastic band into upper hem.

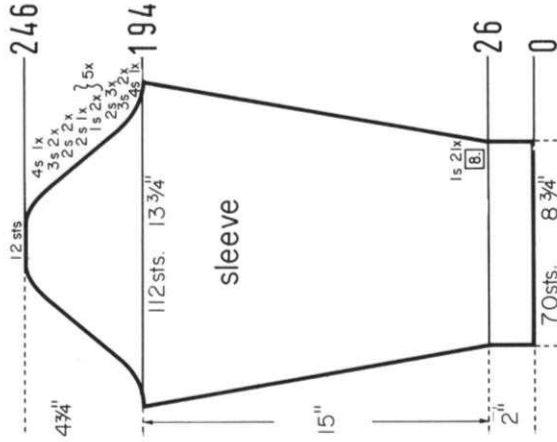
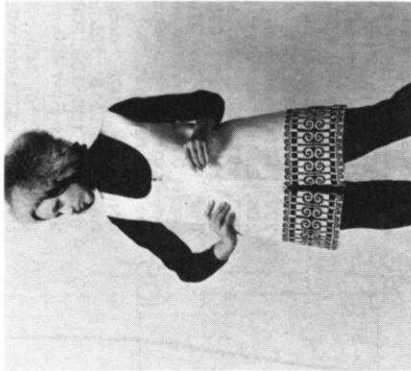

ON CAM BOX SIDE, bind off 4 sts. after Rows 194, 195; 3 sts. after Rows 196, 197, 198, 199; 2 sts. after Rows 200, 201, 202, 203, 204, 205; 1 st. after Rows 206, 207, 208, 209; 2 sts. after Rows 210, 211; 1 st. after Rows 212, 213, 214, 215; 2 sts. after Rows 216, 217; 1 st. after Rows 218, 219, 220, 221; 2 sts. after Rows 222, 223; 1 st. after Rows 224, 225, 226, 227; 2 sts. after Rows 228, 229; 1 st. after Rows 230, 231, 232, 233; 2 sts. after Rows 234, 235, 236, 237, 238, 239; 3 sts. after Rows 240, 241, 242, 243; 4 sts. after Rows 244, 245; 12 sts. after Row 246.

ON EACH SIDE, increase 1 st. after Rows 26, 34, 42, 50, 58, 66, 74, 82, 90, 98, 106, 114, 122, 130, 138, 146, 154, 162, 170, 178, 186, then knit to Row 194.

ROWS 0 to 26: Knit even, then change to stockinette st.

Cast on 70 sts. with white and work K1, P1, Ribbing.

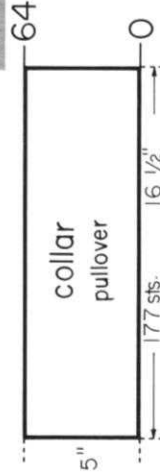

Cast on 177 sts. and work 64 rows K1, P1, Ribbing, then bind off all sts.

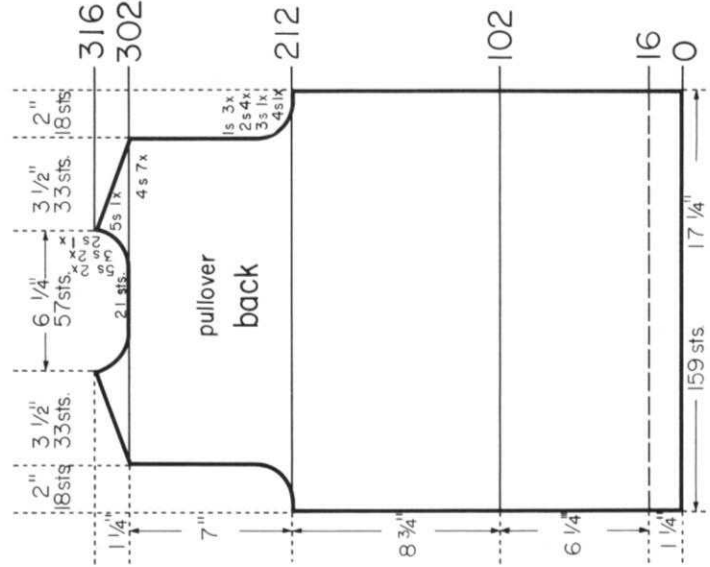

Move the Cam Box to the left side, turn the Row Counter back to 302 and complete the left half. Follow the instructions from *.

* ON CAM BOX SIDE, bind off 4 sts. after Row 302 (EVEN ROWS = SHOULDER SHAPING); 5 sts. after Row 303 (ODD ROWS = NECK SHAPING); 4 sts. after Row 304; 5 sts. after Row 305; 4 sts. after Row 306; 3 sts. after Row 307; 4 sts. after Row 308; 3 sts. after Row 309; 4 sts. after Row 310; 2 sts. after Row 311; 4 sts. after Row 312, 314; 5 sts. after Row 316.

ON CAM BOX SIDE, bind off 4 sts. after Rows 212, 213; 3 sts. after Rows 214, 215; 2 sts. after Rows 216, 217, 218, 219, 220, 221, 222, 223; 1 st. after Rows 224, 225, 226, 227, 228, 229, then knit to Row 302, bind off the center 21 sts., put the needles on the left side into holding position and complete the right half first.

ROWS 103 to 212: Knit even.

ROWS 17 to 102: Knit even, then change to black and work stockinette st.

ROWS 0 to 16: Knit even, then begin the Norwegian Design.

Cast on 159 sts. with black and work stockinette st.

(Continued on next page)

Move the Cam Box to the left side, turn the Row Counter back to 288 and complete the left half. Follow the instructions from *.

* ON CAM BOX SIDE, bind off 3 sts. after Rows 289, 291 (ODD ROWS = NECK SHAPING); 2 sts. after Rows 293, 295, 297, 299; 1 st. after Rows 301, 303, 305, 307, 309. For SHOULDER bind off 4 sts. after Rows 312, 314, 316, 318, 320, 322, 324; 5 sts. after Row 326.

ON CAM BOX SIDE, bind off 4 sts. after Rows 222, 223; 3 sts. after Rows 224, 225; 2 sts. after Rows 226, 227, 228, 229, 230, 231, 232, 233; 1 st. after Rows 234, 235, 236, 237, 238, 239, then knit to Row 288, bind off the center 19 sts. and complete the right half first.

ROWS 213 to 222: Knit even.

Work the front section the same as the back section to ROW 212.

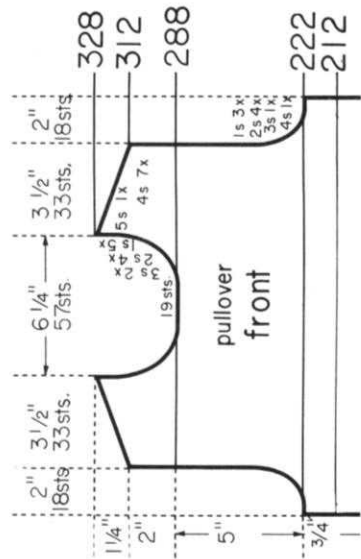

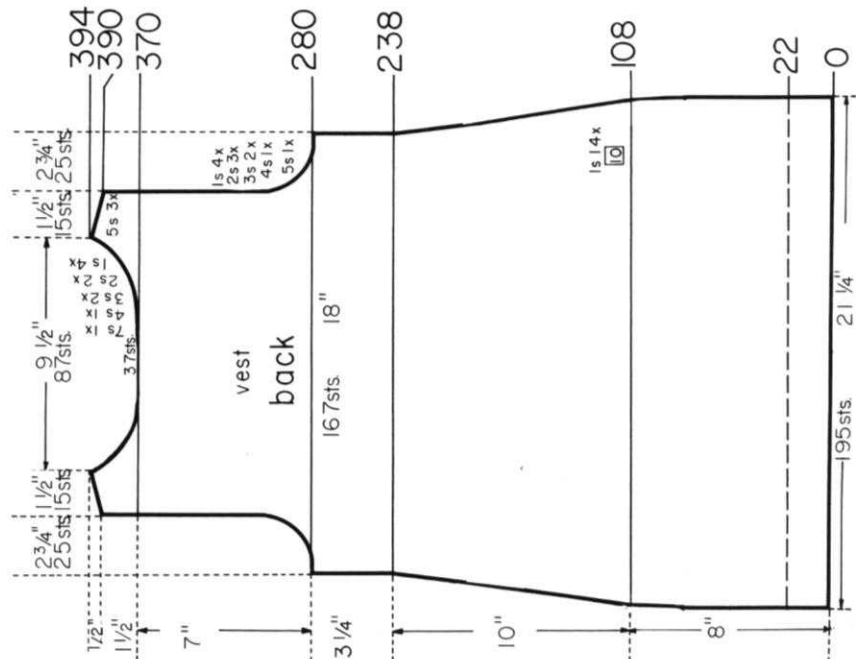
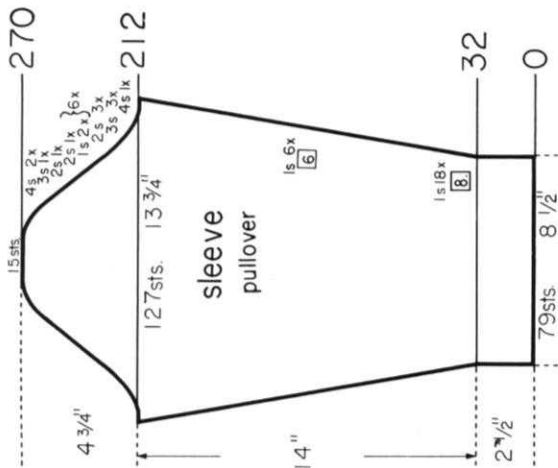

ON CAM BOX SIDE, bind off 4 sts. after Rows 212, 213; 3 sts. after Rows 214, 215, 216, 217, 218, 219; 2 sts. after Rows 220, 221, 222, 223, 224, 225; 1 st. after Rows 226, 227, 228, 229; 2 sts. after Rows 230, 231; 1 st. after Rows 232, 233, 234, 235; 2 sts. after Rows 236, 237; 1 st. after Rows 238, 239, 240, 241; 2 sts. after Rows 242, 243; 1 st. after Rows 244, 245, 246, 247; 2 sts. after Rows 248, 249; 1 st. after Rows 250, 251, 252, 253; 2 sts. after Rows 254, 255; 1 st. after Rows 256, 257, 258, 259; 2 sts. after Rows 260, 261, 262, 263; 3 sts. after Rows 264, 265; 4 sts. after Rows 266, 267, 268, 269; 15 sts. after Row 270.

ON EACH SIDE, increase 1 st. after Rows 32, 40, 48, 56, 64, 72, 80, 88, 96, 104, 112, 120, 128, 136, 144, 152, 160, 168, 176, 182, 188, 194, 200, 206, then knit to Row 212.
ROWS 0 to 32: Knit even, then change to stockinette st.
Cast on 79 sts. and work K1, P1, Ribbing.

Move the Cam Box to the left side, turn the Row Counter back to 370 and complete the left half. Follow the instructions from *.

* ON CAM BOX SIDE, bind off 7 sts. after Row 371 (ODD ROWS = NECK SHAPING); 4 sts. after Row 373; 3 sts. after Rows 375, 377; 2 sts. after Rows 379, 381; 1 st. after Rows 383, 385, 387, 389. For SHOULDER bind off 5 sts. after Rows 390, 392, 394.

ON CAM BOX SIDE, bind off 5 sts. after Rows 280, 281; 4 sts. after Rows 282, 283; 3 sts. after Rows 284, 285, 286, 287; 2 sts. after Rows 288, 289, 290, 291, 292, 293; 1 st. after Rows 294, 295, 296, 297, 298, 299, 300, 301, then knit to Row 370, bind off the center 37 sts., put the needles on the left side into holding position and complete the right half first.

ON EACH SIDE, decrease 1 st. after Rows 108, 118, 128, 138, 148, 158, 168, 178, 188, 198, 208, 218, 228, 238, then knit to Row 280.
ROWS 23 to 108: Knit even, then change to white and work stockinette st.
ROWS 0 to 22: Knit even, then begin the Norwegian Design.
Cast on 195 sts. and work stockinette st.

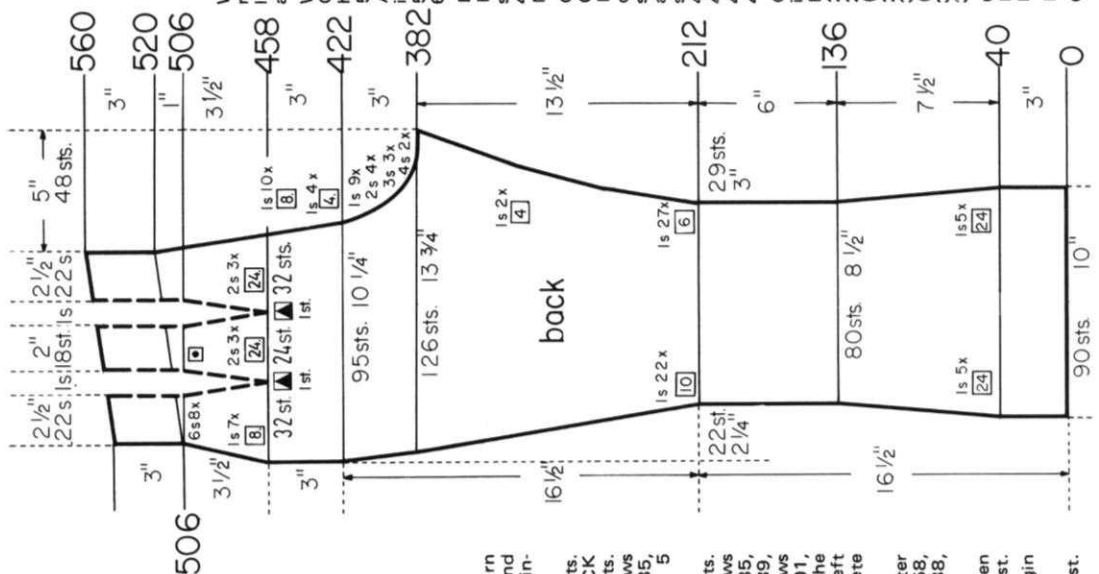
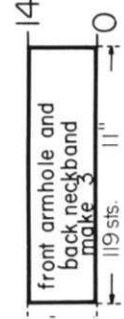
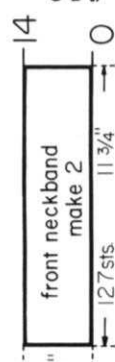
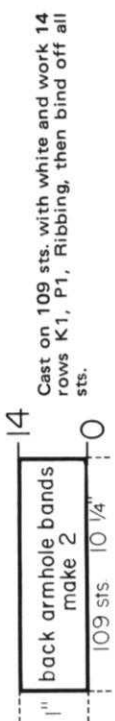

Work the second back section with reverse shapings, casting on from right to left. (Cam Box will be on the LEFT side at Row 0).
Work Short Rows for the shaping. ON OPPOSITE SIDE of CAM BOX put into holding position 7 needles after Rows 506, 508, 510, 512, 514, 516, 518. After Row 520 bring all needles back into working position, then knit to Row 560 and bind off loosely the remaining 64 sts.

Decrease 2 sts. for EACH DART after Rows in (). ON EACH SIDE, decrease 1 st. after Rows 458, (458), 466, 474, 482, (482), 490, 498, 506, (506), but do NOT KNIT THE NEXT ROW NOW.

ON OPPOSITE SIDE of CAM BOX CONTINUE TO INCREASE 1 st. after Rows in (), ON CAM BOX SIDE, bind off 4 sts. after Rows 382, (382), 384; 3 sts. after Rows 386, 388, 390; 2 sts. after Rows 392, (392), 394, 396, 398; 1 st. after Rows 400, 402, (402), 404, 406, 408, 410, 412, (412), 414, 416, 418, 422, (422 last INCREASE), 426, 430, 434, 442, 450, then knit to Row 458.

ON OPPOSITE SIDE of CAM BOX increase 1 st. after Rows in (). ON CAM BOX SIDE, increase 1 st. after Rows 212, (212), 218, (222), 224, 230, (232), 236, 242, (242), 248, (252), 254, 260, (262), 266, 272, (272), 278, (282), 284, 290, (292), 296, 302, (302), 308, (312), 314, 320, (322), 326, 332, (332), 338, (342), 344, 350, (352), 356, 362, (362), 368, (372), 374, 378, then knit to Row 382.

ON EACH SIDE, decrease 1 st. after Rows 40, 64, 88, 112, 136, then knit to Row 212.
ROWS 0 to 40: Knit even.
Cast on 90 sts. and work stockinette st.

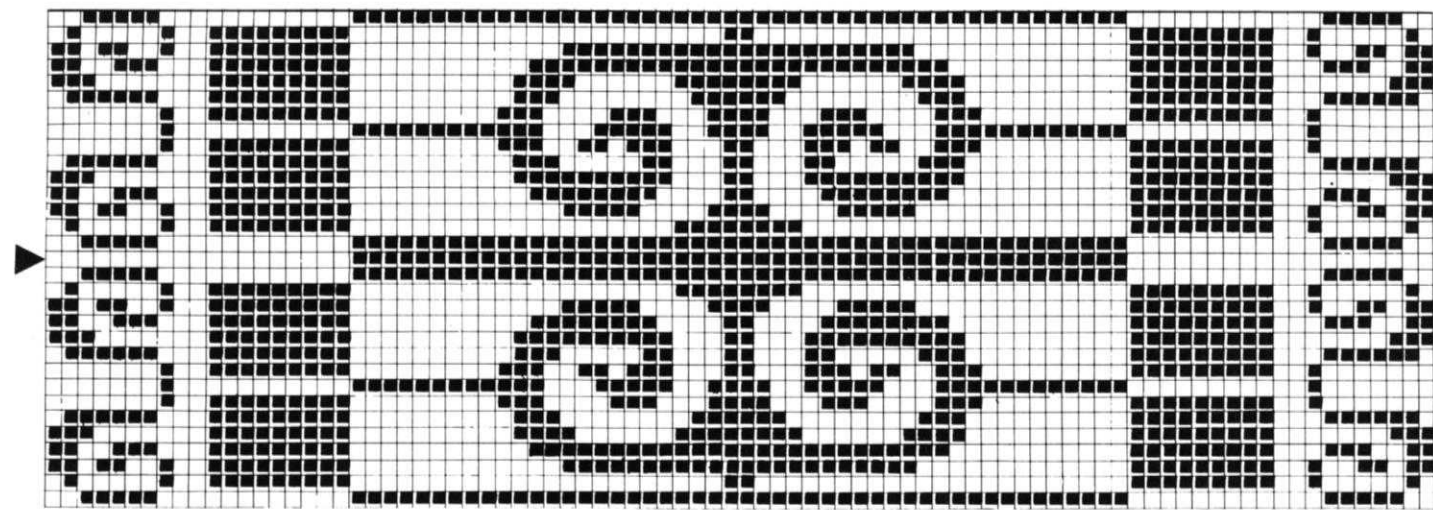

Black
 White

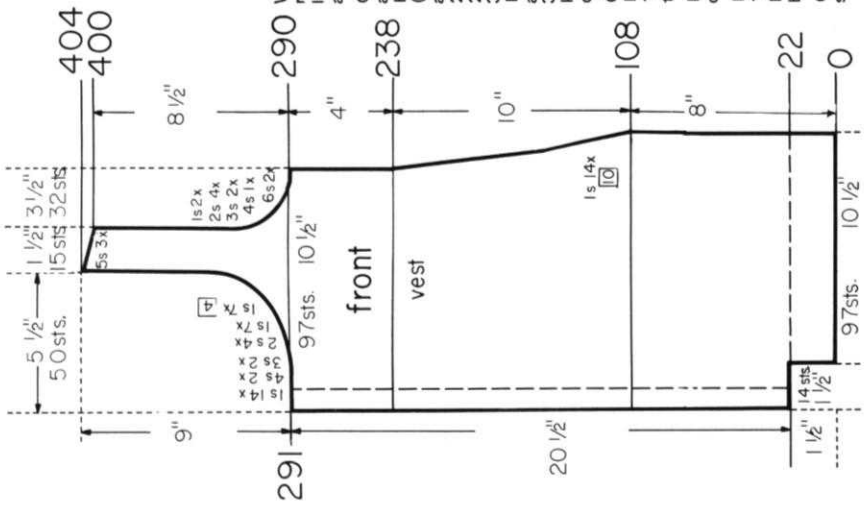

Work the second front section with reverse shapings, casting on from right to left. (Cam Box will be on the LEFT side at Row 0).
 ON CAM BOX SIDE, bind off 6 sts. after Row 290 (EVEN ROWS = ARM-HOLE SHAPING); 14 sts. after Row 291 (ODD ROWS = NECK SHAPING); 6 sts. after Row 292; 4 sts. after Rows 293, 294, 295; 3 sts. after Rows 296, 297, 298, 299; 2 sts. after Rows 300, 301, 302, 303, 304, 305, 306, 307; 1 st. after Rows 308, 309, 310 (last time for armhole), 311, 313, 315, 317, 319, 321, 323, 327, 331, 335, 339, 343, 347, then knit to Row 400. For SHOULDER bind off 5 sts. after Rows 400, 402, 404.
 ON CAM BOX SIDE, decrease 1 st. after Rows 108, 118, 128, 138, 148, 158, 168, 178, 188, 198, 208, 218, 228, 238, then knit to Row 290.
 ROWS 23 to 108: Knit even, then change to white and work stockinette st.
 ROWS 0 to 22: Knit even, then cast on 14 sts. ON OPPOSITE SIDE of CAM BOX (use a separate length of yarn) and begin the Norwegian Design.
 Cast on 97 sts. with white and work stockinette st.

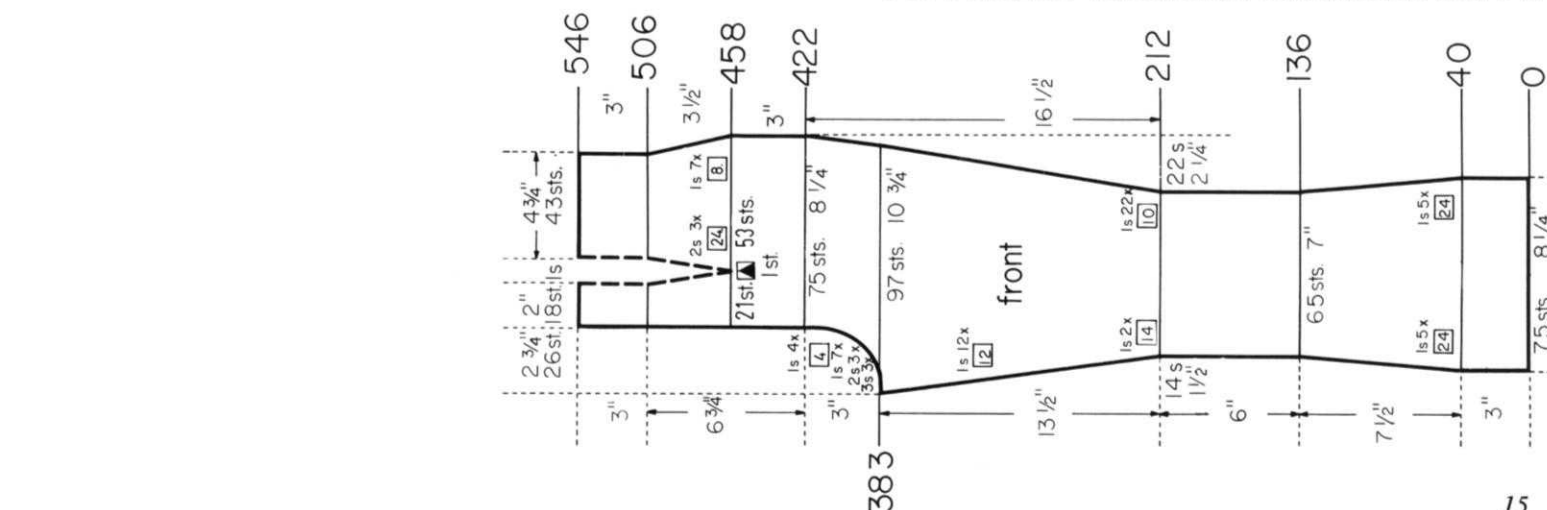

Work the second front section with reverse shapings, casting on from right to left. (Cam Box will be on the LEFT side at Row 0).
 Decrease 2 sts. for the DART after Rows in (), ON CAM BOX SIDE, decrease 1 st. after Rows 458, (458), 466, 474, 482, (482), 490, 498, 506, (506), then knit to Row 546 and bind off loosely the remaining 62 sts.
 ON CAM BOX SIDE (SIDE SEAM), continue to INCREASE 1 st. after Rows in (). ON CAM BOX SIDE (INNER LEG SEAM), bind off 3 sts. after Rows 383, 385, 387; 2 sts. after Rows 389, 391, (392), 393; 1 st. after Rows 395, 397, 399, 401, (402), 403, 405, 407, 409, (412), 413, 417, 421, (422 last INCREASE), then knit to Row 458.
 ON OPPOSITE SIDE of CAM BOX increase 1 st. after Rows in (). ON CAM BOX SIDE, increase 1 st. after Rows 212, (212), 222, (226), 232, (240), 242, 252, (252), 262, (264), 272, (276), 282, (288), 292, (300), 302, 312, (312), 322, (324), 332, (336), 342, (348), 352, (360), 362, 372, (372), 382, then knit to Row 383.
 ON EACH SIDE, decrease 1 st. after Rows 40, 64, 88, 112, 136, then knit to Row 212.
 ROWS 0 to 40: Knit even.
 Cast on 75 sts. and work stockinette st.

DK 7929

SIZE: 18/20. **MATERIAL:** 29% oz. (17 balls) green KNITTING Crocus Crepe. **TENSION:** KNIT-KING 5 to 7. **GAUGE:** 16 sts. 2", 23 rows 2". **PATTERN:** Stockinette. Stitch and an Eyelet Design on the front sections of the vest. Follow the Line Drawing for the Eyelet Design. **BANDS:** K1, P1, Ribbing. Bind off the bands the crochet method for ribbing. **SKIRT DECREASES:** After rows indicated, hang the 4th st. ON EACH SIDE onto the 3rd st. then move the end sts. inward to fill the empty needle. **FRONT SHAPING:** After rows indicated, hang the 3rd st. ON NECK SIDE onto the 2nd st., then move the end sts. inward to fill the empty needle. The finished length of the skirt is 23 1/4".

FINISHING: Block all sections to measurements given. **VEST:** Join front and back sections at sides and shoulders, easing in the fullness at bustline of front section. Join short ends of armhole bands, then sew bands to armhole. Join front bands to neckbands, then join at center back. Sew band to front edges and neckline, leaving 6 spaces on the right side free for buttonholes. The buttonholes are 5/8" long. Begin the first buttonhole 1/2" from lower edge. The following buttonholes are 2" apart. Sew on Buttons. **SKIRT:** Weave the skirt sections together, 1 st. in from each edge. Turn under 14 rows on upper edge and 18 rows on lower edge, then hem to wrong side. Insert an elastic band into upper hem.



Cast on 195 sts. and work 10 Rows K1, P1, Ribbing, then bind off all sts.



Cast on 133 sts. and work 10 Rows K1, P1, Ribbing, then bind off all sts.

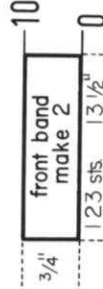

Cast on 123 sts. and work 10 Rows K1, P1, Ribbing, then bind off all sts.

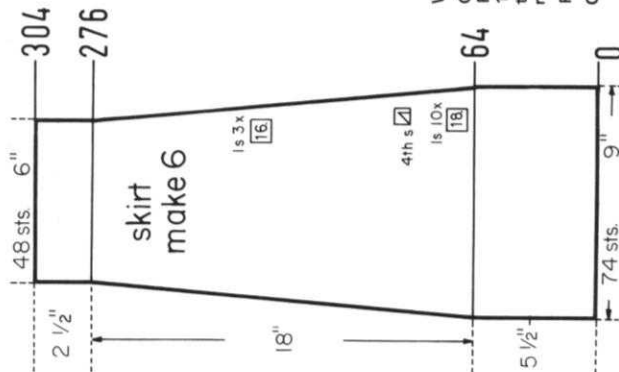

Work 5 more sections the same.

ON EACH SIDE, decrease 1 st. after Rows 64, 82, 100, 118, 136, 154, 172, 190, 208, 226, 244, 260, 276, then knit to Row 304 and loosely bind off the remaining 48 sts.

ROWS 0 to 64: Knit even.

Cast on 74 sts. and work stockinette st.

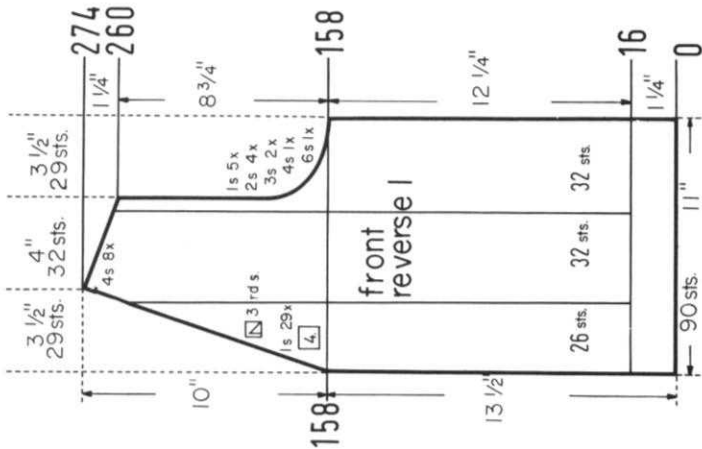

Work the second front section with reverse shapings, casting on from right to left. (Cam Box will be on the LEFT side at Row 0).

ON OPPOSITE SIDE of CAM BOX decrease 1 st. after Rows in (). ON CAM BOX SIDE, bind off 6 sts. after Row 158; (158), 4 sts. after Row 160; 3 sts. after Rows 162, (162), 164; 2 sts. after Rows 166, (166), 168, 170, (170), 172; 1 st. after Rows 174, (174), 176, 178, (178), 180, 182; (182). The Armhole shaping is now completed. Continue to decrease 1 st. ON NECK SIDE after Rows 186, 190, 194, 198, 202, 206, 210, 214, 218, 222, 226, 230, 234, 238, 242, 246, 250, 254, 258, then again after Rows in (). For SHOULDER bind off 4 sts. after Rows 260, 262, (262), 264, 266, (266), 268, 270, (270), 272, 274.

ROWS 17 to 158: Knit even.

ROWS 0 to 16: Knit even, then change to stockinette st. and begin working the Eyelet Design over the sts. marked on the Diagram.

Cast on 90 sts. and work K1, P1, Ribbing.

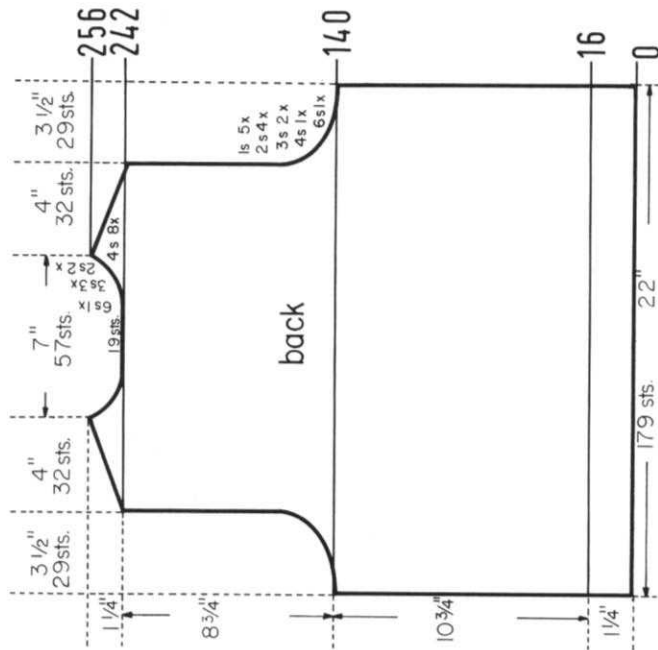

Move the Cam Box to the left side, turn the Row Counter back to 242 and complete the left half. Follow the instructions from*.

* ON CAM BOX SIDE, bind off 4 sts. after Row 242 (EVEN ROWS = SHOULDER SHAPING); 6 sts. after Row 243 (ODD ROWS = NECK SHAPING); 4 sts. after Row 244; 3 sts. after Row 245; 4 sts. after Row 246; 3 sts. after Row 247; 4 sts. after Row 248; 3 sts. after Row 249; 4 sts. after Row 250; 2 sts. after Row 251; 4 sts. after Row 252; 2 sts. after Row 253; 4 sts. after Rows 254, 256.

ON CAM BOX SIDE, bind off 6 sts. after Rows 140, 141; 4 sts. after Rows 142, 143; 3 sts. after Rows 144, 145, 146, 147; 2 sts. after Rows 148, 149, 150, 151, 152, 153, 154, 155; 1 st. after Rows 156, 157, 158, 159, 160, 161, 162, 163, 164, 165, then knit to Row 242, bind off the center 19 sts., put the needles on the left side into holding position and complete the right half first.

ROWS 17 to 140: Knit even.

ROWS 0 to 16: Knit even, then change to stockinette st.

Cast on 179 sts. and work K1, P1, Ribbing.

DK 7925

SIZE: 14/16. **MATERIAL:** 15½ oz. (9 balls) medium brown color 1 and 7 oz. (4 balls) beige color 11 **KNITTING** Amore. **TENSION:** KNITTING 6 to 8. **GAUGE:** 15 sts, 2", 23 rows 2". **PATTERN:** Stockinette Stitch with color stripes as marked in the diagram of the back section. **BANDS:** K1, P1, Ribbing. **DECREASES:** After rows indicated, hang the 3rd st. on the appropriate sides onto the 2nd st., then move the end sts. inward to fill the empty needle. **INCREASES:** After rows indicated, move the 2 end sts. on the appropriate sides 1 needle outward, then place the 3rd st. from the row below onto the empty needle. The finished length is about 34".

FINISHING: Block all sections to measurements given. Weave back sections together. Join front and back section at sides and shoulders. Turn under 3 sts. around armholes and hem to wrong side. Turn under 18 rows on lower edge and hem to wrong side. Join neckband at center back then sew to side. Join neckband at center back then sew to side. Sew 1 edge of band to inside and 1 edge to outside of front edges and neckline. Sew buttons to dress as pictured. Close dress with snaps.

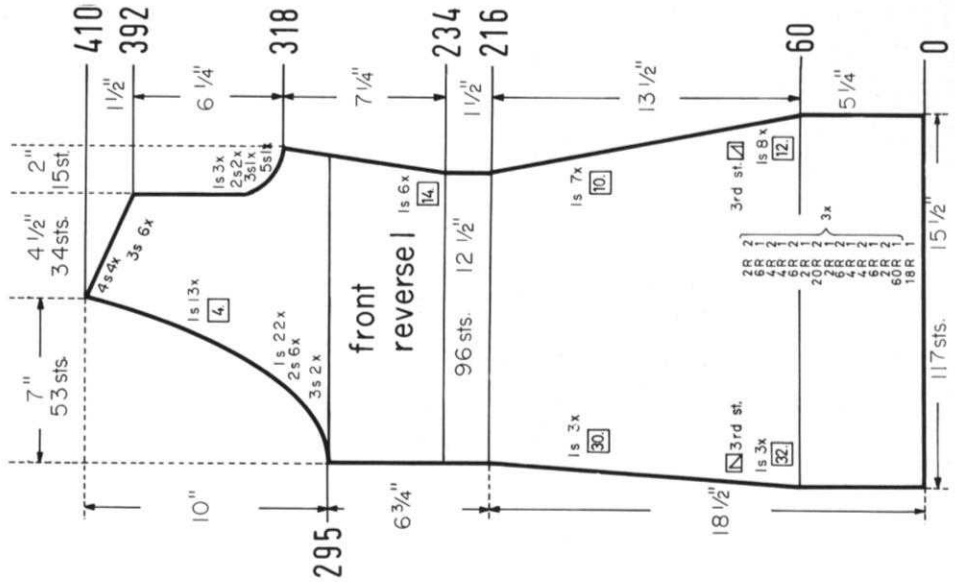

Work the second front section with reverse shapings, casting on from right to left. (Cam Box will be on the LEFT side at Row 0).

Continue to decrease 1 st. ON NECK SIDE after Rows (). ON CAM BOX SIDE, bind off 5 sts. after Row 318 (EVEN ROWS = ARMHOLE SHAPING); (319) 3 sts. after Row 320; (321), 2 sts. after Rows 322, (323), 324; (325), 1 st. after Rows 326, (327), 328, (329), 330. The Armhole Shaping is now completed. Continue to decrease 1 st. ON NECK SIDE after Rows 331, 333, 335, 337, 339, 341, 343, 345, 347, 349, 351, 353, 355, 359, 363, 367, 371, 375, 379, 383, 387, 391, then again after Rows in (). For SHOULDER bind off 3 sts. after Rows 392, 394, (395), 396, 398, (399), 400, 402; (403), 4 sts. after Rows 404, 406, 408, 410.

ON CAM BOX SIDE (NECK SIDE), bind off 3 sts. after Rows 295, 297; 2 sts. after Rows 299, 301, 303, (304), 305, 307, 309; Full-fashion decrease 1 st. after Rows 311, 313, 315, 317, then knit to Row 318.

ON CAM BOX SIDE, increase 1 st. after Rows 234, 248, 262, 276, 290, then 1 more time after Row in (). Knit to Row 295.

ON OPPOSITE SIDE of CAM BOX decrease 1 st. after Rows in (). ON CAM BOX SIDE, decrease 1 st. after Rows 60, (60), 72, 84, (92), 96, 108, 120, (124), 132, 144, 156, (156), 166, 176, 186, (186), 196, 206, 216, (216), then knit to Row 234.

ROWS 0 to 60: Knit even. Cast on 117 sts. with brown, work stockinette st. and the color stripes as marked in the diagram of the back section.

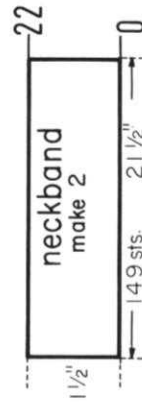
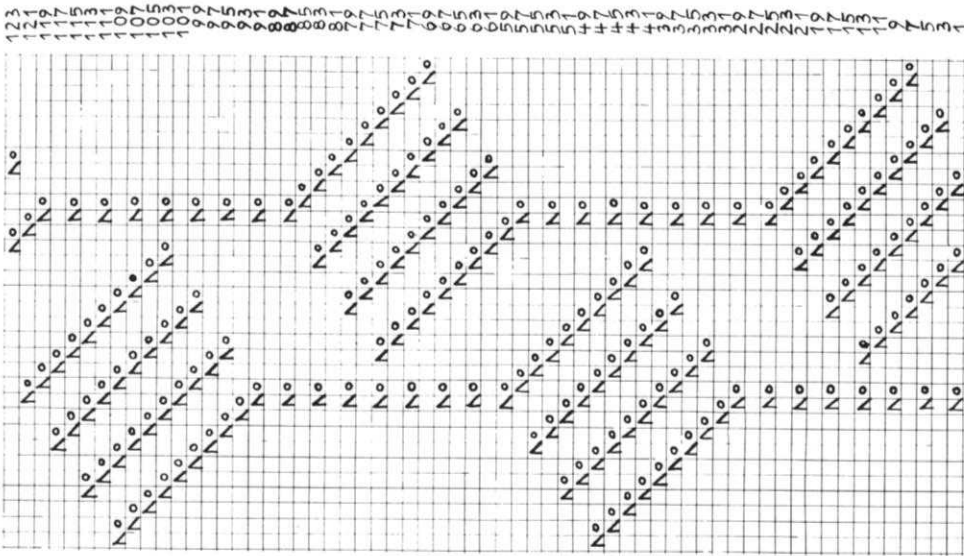

Cast on 149 sts. with brown and work 22 rows K1, P1, Ribbing, then bind off all sts.



Cast on 195 sts. with brown and work 22 rows K1, P1, Ribbing, then bind off all sts.

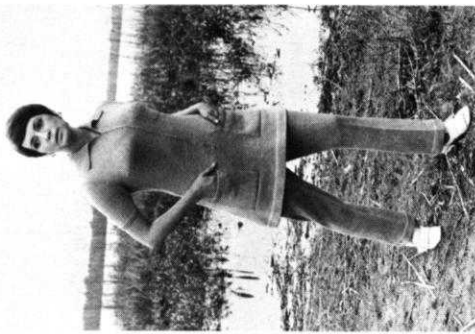

SIZE: 16/18. **MATERIAL:** Short Sleeves 45½ oz. (26 balls); Long Sleeves 49 oz. (28 balls) plum KNITTING Excelsior and a 20" zipper. **TENSION:** KNITTING 6 to 8. **GAUGE:** 15 sts, 2", 21 rows 2". **PATTERN:** Stockinette Stitch. **SLEEVE EDGES** and **COLLAR:** K1, P1, Ribbing. Except on Armholes, make all shapings of 1 st. Full-fashion. **DECREASES:** After rows indicated, hang the 3rd st. on the appropriate sides onto the 2nd st., then move the end sts. inward to fill the empty needles. **INCREASES:** After rows indicated, move the 2 end sts. on the appropriate sides 1 needle outward, then place the 3rd st. from the row below onto the empty needle. Begin the **SLACK DARTS** by hanging the sts. together as marked on the diagram, then move the end sts. inward to fill the empty needles. The following decreases for the darts lie directly above.

FINISHING: Block all sections to measurements given. **TUNIC:** Join front and back section at sides and shoulders. Sew sleeves together and set in. Sew pockets in place. (See picture). Sew collar to neckline. Work 1 row of single crochet around front opening. Sew in zipper. **SLACKS:** Join front and back sections at sides. Close inner leg seams. Join sections at center front and center back. Turn under 17 rows on upper and lower edges and hem to wrong side. Insert an elastic band into upper hem.

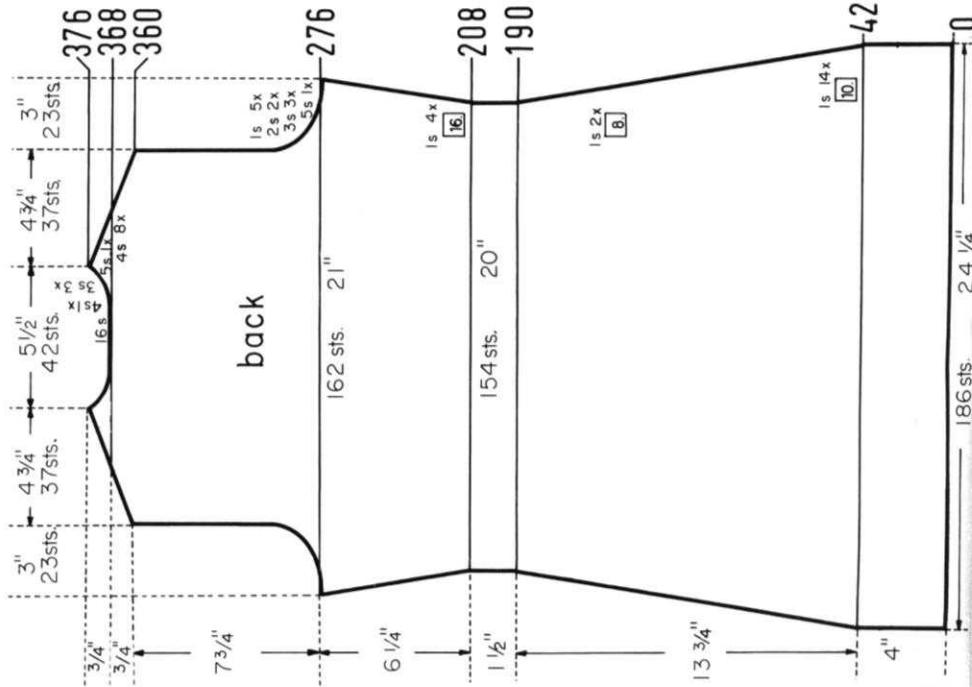

Move the Cam Box to the left side, turn the Row Counter back to 368 and complete the left half. Follow the instructions from *.

* ON CAM BOX SIDE, bind off 4 sts. after Rows 368 (EVEN ROWS = SHOULDER SHAPING), 369 (ODD ROWS = NECK SHAPING), 370; 3 sts. after Row 371; 4 sts. after Row 372; 3 sts. after Row 373; 4 sts. after Row 374; 3 sts. after Row 375; 5 sts. after Row 376.

ON CAM BOX SIDE, bind off 4 sts. after Rows 360, 361, 362, 363, 364, 365, 366, 367, then knit to Row 368, bind off the center 16 sts., put the needles on the left side into holding position and complete the right half first.

ON CAM BOX SIDE, bind off 5 sts. after Rows 276, 277; 3 sts. after Rows 278, 279, 280, 281, 282, 283; 2 sts. after Rows 284, 285, 286, 287; 1 st. after Rows 288, 289, 290, 291, 292, 293, 294, 295, 296, 297, then knit to Row 360.

ON EACH SIDE, increase 1 st. after Row 208, 224, 240, 256, then knit to Row 276.

ON EACH SIDE, decrease 1 st. after Rows 42, 52, 62, 72, 82, 92, 102, 112, 122, 132, 142, 152, 162, 172, 182, 190, then knit to Row 208.

ROWS 0 to 42: Knit even.
Cast on 186 sts. and work stockinette st.

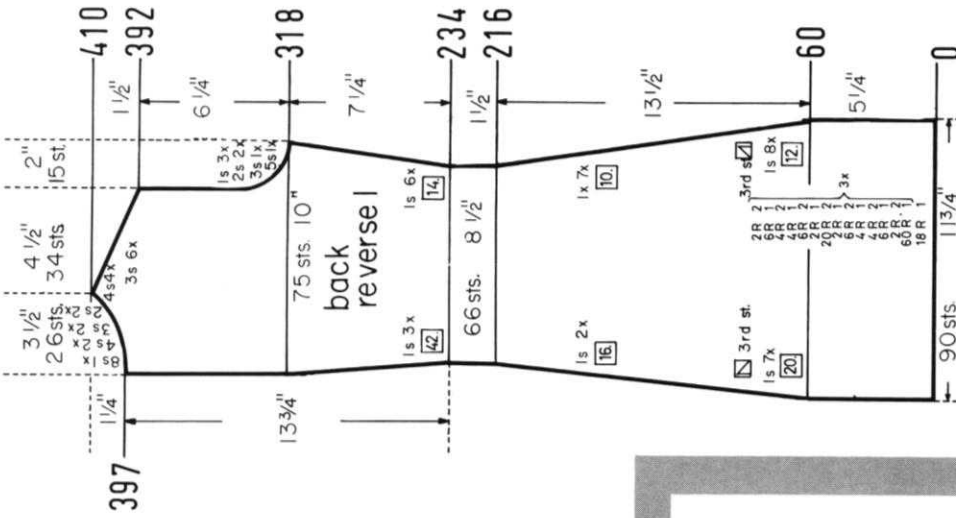

Work the second section with reverse shapings, casting on from right to left. (Cam Box will be on the LEFT side at Row 0).

ON CAM BOX SIDE, bind off 3 sts. after Rows 392, 394, 396 (EVEN ROWS = SHOULDER SHAPING); 8 sts. after Row 397 (ODD ROWS = NECK SHAPING); 3 sts. after Row 398; 4 sts. after Row 399; 3 sts. after Row 400; 4 sts. after Row 401; 3 sts. after Rows 402, 403; 4 sts. after Row 404; 3 sts. after Row 405; 4 sts. after Row 406; 2 sts. after Row 407; 4 sts. after Row 408; 2 sts. after Row 409; 4 sts. after Row 410.

ON CAM BOX SIDE, bind off 5 sts. after Row 318; 3 sts. after Row 320; 2 sts. after Rows 322, 324; 1 st. after Rows 326, 328, 330, then knit to Row 392.

ON OPPOSITE SIDE of CAM BOX increase 1 st. after Rows in (). ON CAM BOX SIDE, increase 1 st. after Rows 234, (234), 248, 262, 276, (276), 290, 304 AND (318), but do NOT knit this row until the first Armhole Bind-off.

ON OPPOSITE SIDE of CAM BOX decrease 1 st. after Rows in (). ON CAM BOX SIDE, decrease 1 st. after Rows 60, (60), 72, (80), 84, 96, (100), 108, 120, (120), 132, (140), 144, 156, (160), 166, 176, (180), 186, 196, (200), 206, 216, (216), then knit to Row 234. ROWS 0 to 60: Knit even.

Cast on 90 sts. with brown, work stockinette st. and the color stripes as marked in the diagram.

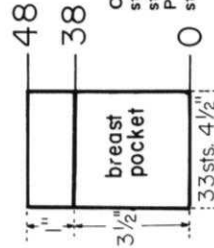
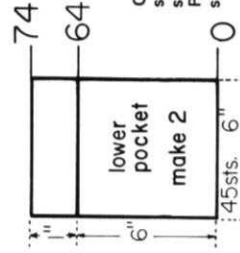

Cast on 45 sts. and work 64 rows stockinette st., then transfer every other st. to the ribber and work 10 rows K1, P1, Ribbing. After Row 74 bind off all sts. the crochet method for ribbing.

Cast on 33 sts. and work 38 rows stockinette st., then transfer every other st. to the ribber and work 10 rows K1, P1, Ribbing. After Row 48 bind off all sts. the crochet method for ribbing.

ON CAM BOX SIDE, bind off 6 sts. after Rows 52, 53; 3 sts. after Rows 54, 55, 56, 57, 58, 59; 2 sts. after Rows 60, 61, 62, 63, 64, 65, 66, 67. ON EACH SIDE, hang the 1st st. onto the 2nd st. after Rows 68, 70, 72, 74, 76, 78, 80, 82, 84, 86, 88, 90, 92, 94. ON CAM BOX SIDE, bind off 2 sts. after Rows 96, 97, 98, 99; 3 sts. after Rows 100, 101, 102, 103; 4 sts. after Rows 104, 105; 12 sts. after Row 106.

ON EACH SIDE, increase 1 st. after Rows 10, 16, 22, 28, 32, 36, 40, 44, 48, then knit to Row 52.

ROWS 0 to 10: Knit even, then change to stockinette st.

Cast on 96 sts. and work K1, P1, Ribbing.

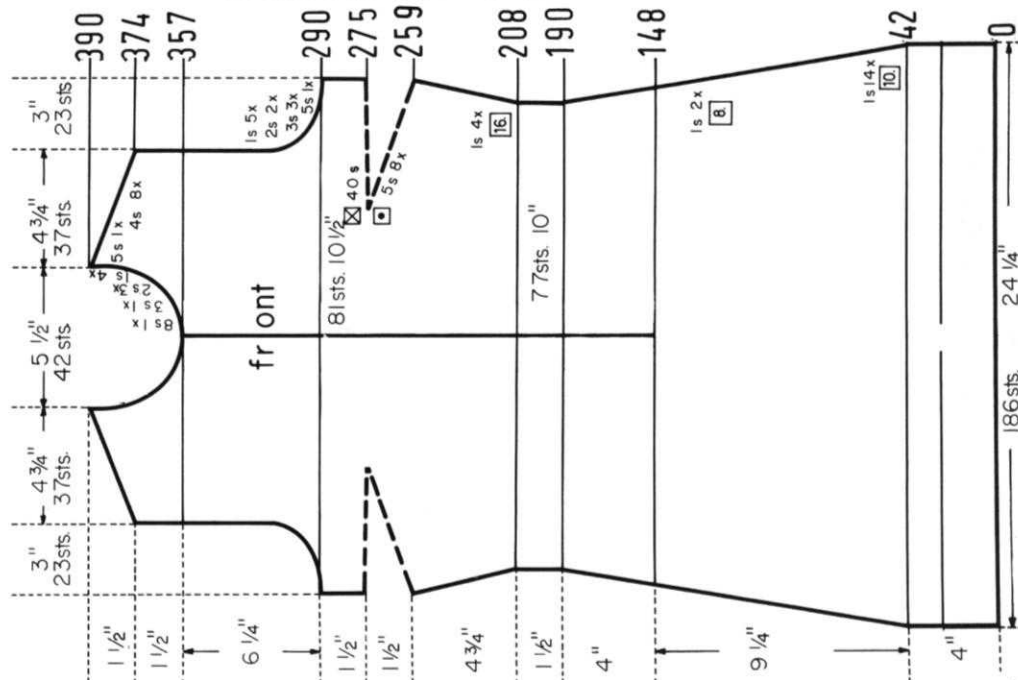
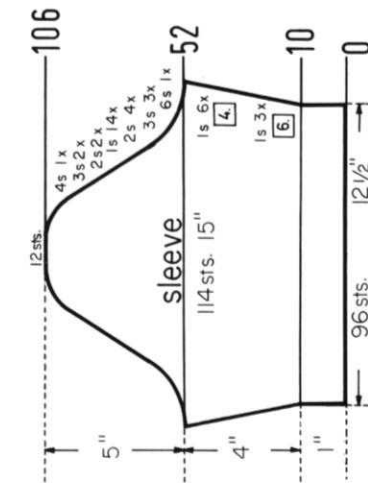
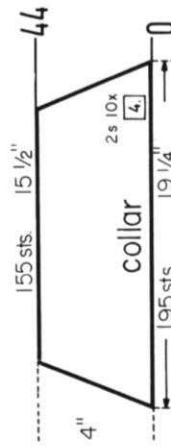
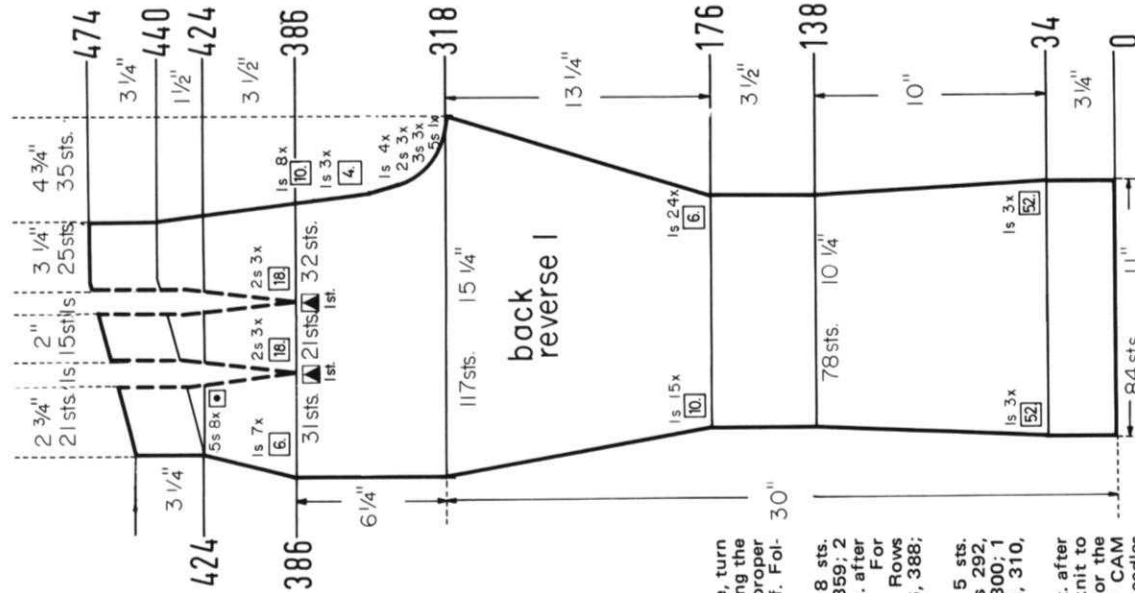

Move the Cam Box to the left side, turn the Row Counter back to 148, (hang the doubled up st. back onto the proper needle) and complete the left half. Follow the instructions from *.

ON CAM BOX SIDE, bind off 8 sts. after Row 357; 3 sts. after Row 359; 2 sts. after Rows 361, 363, 365; 1 st. after Rows 367, 369, 371, 373. For SHOULDER bind off 4 sts. after Rows 374, 376, 378, 380, 382, 384, 386, 388; 5 sts. after Row 390.

ON CAM BOX SIDE, bind off 5 sts. after Row 290; 3 sts. after Rows 292, 294, 296; 2 sts. after Rows 298, 300; 1 st. after Rows 302, 304, 306, 308, 310, then knit to Row 357.

ON CAM BOX SIDE, increase 1 st. after Rows 208, 224, 240, 256, then knit to Row 259 and work Short Rows for the DART. ON OPPOSITE SIDE of CAM BOX put into holding position 5 needles after Rows 259, 261, 263, 265, 267, 269, 271, 273. After Row 275 bring all needles back into working position and knit to Row 290.

* ON CAM BOX SIDE, decrease 1 st. after Rows 152, 162, 172, 182, 190, then knit to Row 208.

ON EACH SIDE, decrease 1 st. after Rows 42, 52, 62, 72, 82, 92, 102, 112, 122, 132, 142, then knit to Row 148, put 82 needles on the left side into holding position and complete the right half first. (To make working room, hang the 1st st. from the left half onto the next left needle and put empty needle in the non-working position).

ROWS 0 to 42: Knit even.

Cast on 186 sts. and work stockinette st.

Work the second section with reverse shapings, casting on from right to left. (Cam Box will be on the LEFT side at Row 0).

Work Short Rows for the shaping. ON OPPOSITE SIDE of CAM BOX put into holding position 5 needles, after Rows 424, 426, 428, 430, 432, 434, 436, 438. After Row 440 bring all needles back into working position and knit to Row 474, then bind off loosely the remaining 63 sts.

Decrease 2 sts. for EACH DART and 1 st. ON OPPOSITE SIDE of CAM BOX after Row 386. Continue to decrease 1 st. ON OPPOSITE SIDE of CAM BOX after Rows in () and 2 sts. for EACH DART when indicated. ON CAM BOX SIDE, decrease 1 st. after Rows 392, (392), (398), 402, (404 and 2 sts. for EACH DART), (410), 412, (416), 422, (422 and 2 sts. for EACH DART), then knit to Row 424.

ON CAM BOX SIDE, bind off 5 sts. after Row 318; 3 sts. after Rows 320, 322, 324; 2 sts. after Rows 326, 328, 330; 1 st. after Rows 332, 334, 336, 338, 340, 344, 348, 352, 362, 372, 382, then knit to Row 386.

ON OPPOSITE SIDE of CAM BOX, (SIDE SEAM) increase 1 st. after Rows in (). ON CAM BOX SIDE, (INNER SEAM) increase 1 st. after Rows 176 (176), 182, (186), 188, 194, (196), 200, 206, (206), 212, (216), 218, 224, (226), 230, 236, (236), 242, (246), 248, 254, (256), 260, 266, (266), 272, (276), 278, 284, (286), 290, 296, (296), 302, (306), 308, 314, (316), then knit to Row 318. ON EACH SIDE, decrease 1 st. after Rows 34, 86, 138, then knit to Row 176.

ROWS 0 to 34: Knit even.

Cast on 84 sts. and work stockinette st.

Cast on 195 sts. and work K1, P1, Ribbing. ON EACH SIDE, decrease 2 sts. after Rows 4, 8, 12, 16, 20, 24, 28, 32, 36, 40. After Row 44 bind off all sts. the crochet method for ribbing.

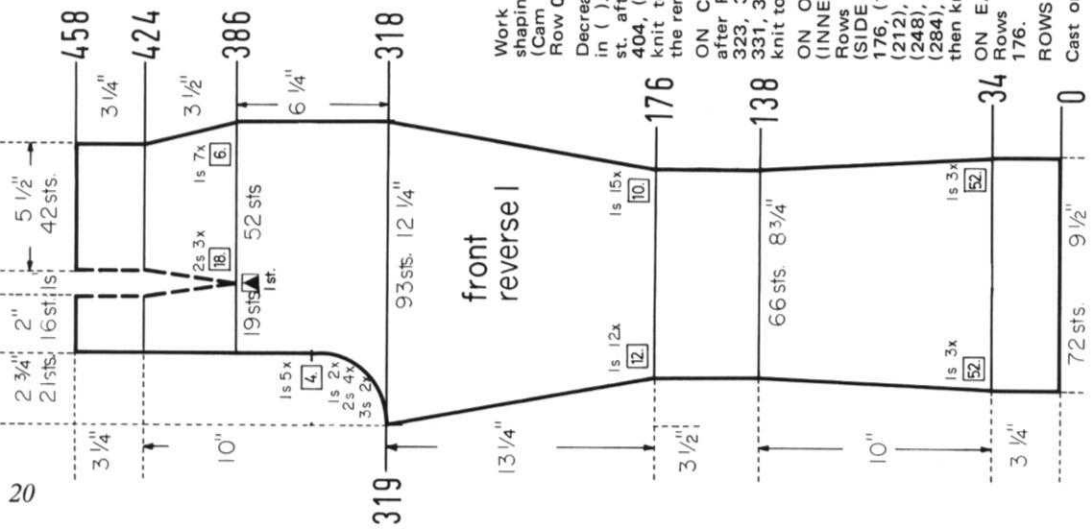

Work the second section with reverse shapings, casting on from right to left. (Cam Box will be on the LEFT side at Row 0).

Decrease 2 sts. for the DART after Rows in (). ON CAM BOX SIDE, decrease 1 st. after Rows 386, (386), 392, 398, 404, (404), 410, 416, 422, (422), then knit to Row 458 and bind off loosely the remaining 59 sts.

ON CAM BOX SIDE, bind off 3 sts. after Rows 319, 321; 2 sts. after Rows 323, 325, 327, 329; 1 st. after Rows 331, 333, 335, 339, 343, 347, 351, then knit to Row 386.

ON OPPOSITE SIDE of CAM BOX, (INNER SEAM) increase 1 st. after Rows in (). ON CAM BOX SIDE, (SIDE SEAM) increase 1 st. after Rows 176, (176), 186, (188), 196, (200), 206, (212), 216, (224), 226, 236, (236), 246, (248), 256, (260), 266, (272), 276, (284), 286, 296, (296), 306, (308), 316, then knit to Row 319.

ON EACH SIDE, decrease 1 st. after Rows 34, 86, 138, then knit to Row 176.

ROWS 0 to 34: Knit even.

Cast on 72 sts. and work stockinette st.

CANADIAN READERS

Please note that KNITTING dealers based in the U.S.A. are unable to sell machines and accessories to residents of Canada. They are also unable to sell parts and service. Would all Canadian readers please contact the following appointed KNITTING dealer.

KNITTING Sales and Service
2243 Danforth Ave.
Toronto 13, Ontario

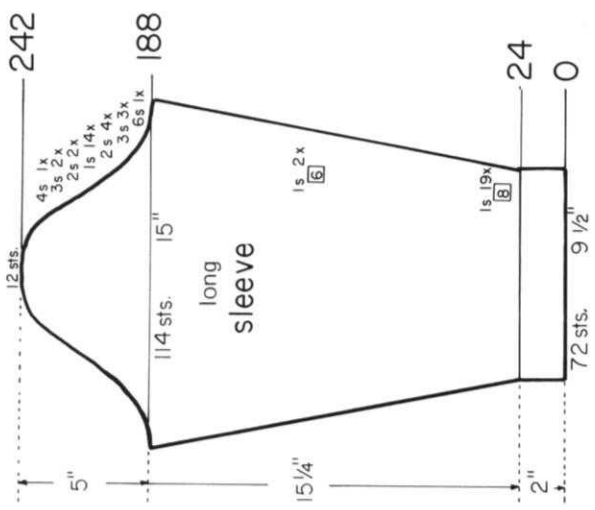

ON CAM BOX SIDE, bind off 6 sts. after Rows 188, 189; 3 sts. after Rows 190, 191, 192, 193, 194, 195; 2 sts. after Rows 196, 197, 198, 199, 200, 201, 202, 203. ON EACH SIDE, hang the 1st st. onto the 2nd st. after Rows 204, 206, 208, 210, 212, 214, 216, 218, 220, 222, 224, 226, 228, 230. ON CAM BOX SIDE, bind off 2 sts. after Rows 232, 233, 234, 235; 3 sts. after Rows 236, 237, 238, 239; 4 sts. after Rows 240, 241; 12 sts. after Row 242.

ON EACH SIDE, increase 1 st. after Rows 24, 32, 40, 48, 56, 64, 72, 80, 88, 96, 104, 112, 120, 128, 136, 144, 152, 160, 168, 176, 182, then knit to Row 188.

ROWS 0 to 24: Knit even, then change to stockinette st.

Cast on 72 sts. and work K1, P1, Ribbing.

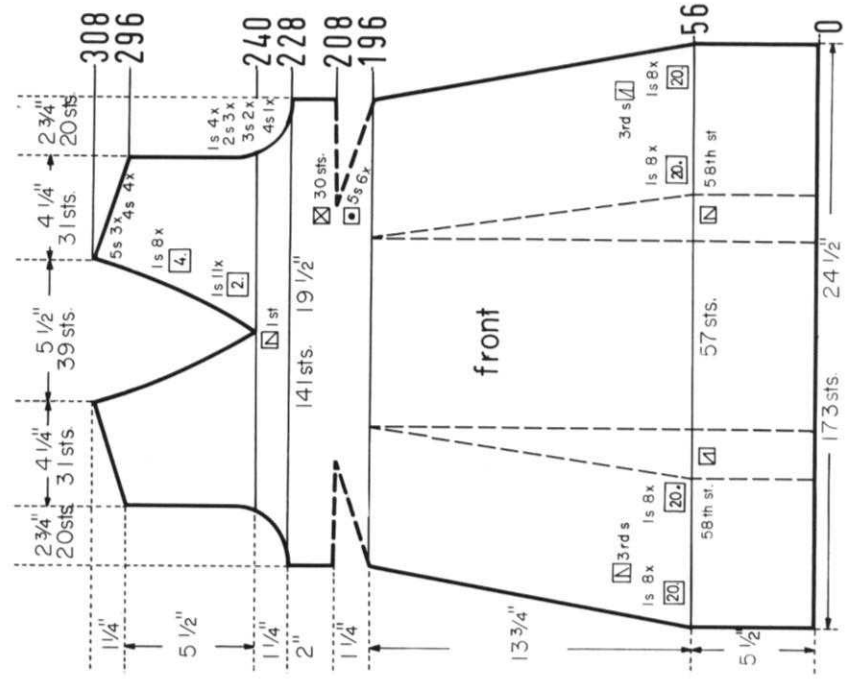

Move the Cam Box to the left side, turn the Row Counter back to 240 and complete the left half. Follow the instructions from *.

* ON OPPOSITE SIDE of CAM BOX decrease 1 st. after Rows in (). ON CAM BOX SIDE, decrease 1 st. after Rows 240, 242, (242), 244, (244), 246, (246). The Armhole shaping is now completed. Continue to decrease 1 st. ON NECK SIDE after Rows 248, 250, 252, 254, 256, 258, 260, 262, 264, 268, 272, 276, 280, 284, 288, 292. For SHOULDER bind off 4 sts. after Rows 296, 298, 300, 302; 5 sts. after Rows 304, 306, 308.

ON CAM BOX SIDE, bind off 4 sts. after Rows 228, 229; 3 sts. after Rows 230, 231, 232, 233; 2 sts. after Rows 234, 235, 236, 237, 238, 239, then knit to Row 240, put the center st. onto the neighboring needle, put the needles on the left side into holding position and complete the right half first.

Work Short Rows for the DARTS. ON OPPOSITE SIDE of CAM BOX put into holding position 5 needles after Rows 196, 197, 198, 199, 200, 201, 202, 203, 204, 205, 206, 207. ON OPPOSITE SIDE of CAM BOX bring all needles back into working position after Rows 208, 209, then knit to Row 228.

Work the front section the same as the back section to Row 196.

SIZE: 12/14. MATERIAL: 38½ oz. (22 balls) turquoise KNITTING Lovely and 4 yards ready made embroidered border trim. TENSION: KNIT-KING 6 to 8. GAUGE: 14 sts, 2", 20 rows 2".
PATTERN: Stockinette Stitch. Make all shapings of 1 st. Full-fashion. **DECREASES:** After rows indicated, hang the 3rd st. on the appropriate sides onto the 2nd st. **DARTS:** Begin the darts by hanging the sts. together as marked on the diagrams. The following decreases for the SLACK darts lie directly above. To make the following decreases for the darts on the TUNIC always hang the st. to be decreased onto the same NEEDLE. After all Full-fashion decreases the end sts. have to be moved inward to fill the empty needles.
INCREASES: After rows indicated, move the 2 end sts. on EACH SIDE 1 needle outward, then place the 3rd st. from the row below onto the empty needle.

FINISHING: Block all sections to measurements given. **TUNIC:** Join front and back section at shoulders and sides, leaving about 3" on each side open for the slit. Turn under 3 sts. around armholes and hem to wrong side. Sew the border trim to neckline and to lower edge. (See picture).
SLACKS: Join the sections at center front and center back. Close leg seams. Turn under 12 rows on upper edge and hem to wrong side. Insert an elastic band. Sew border trim to lower leg edges.

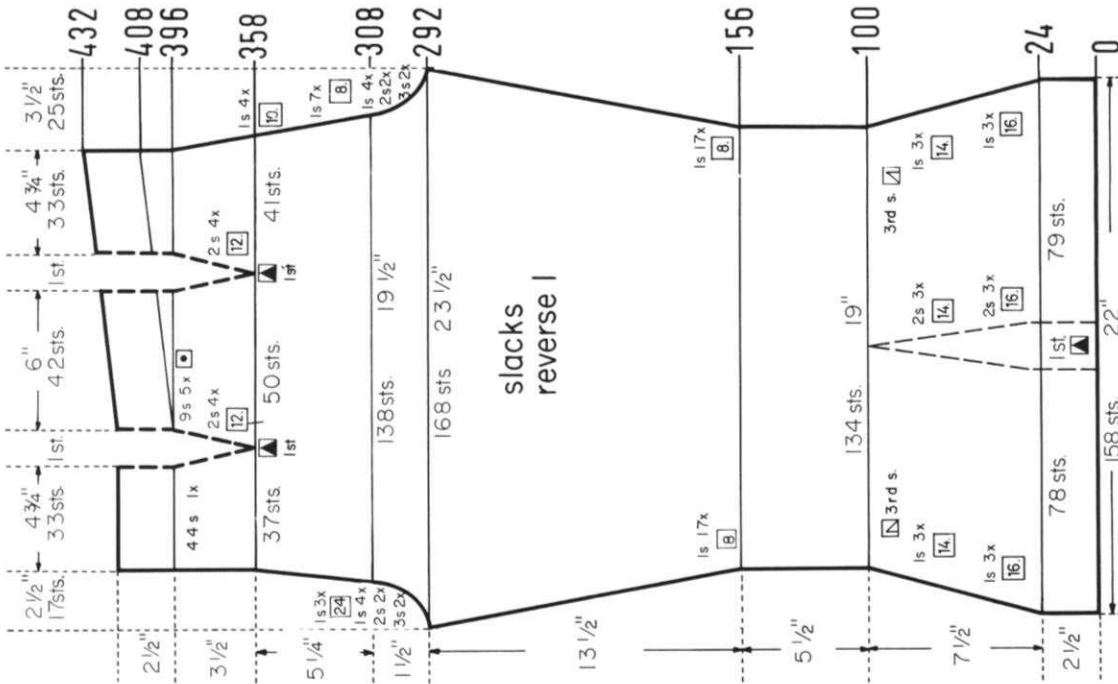
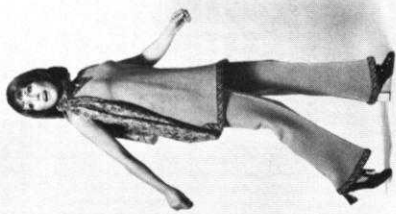

Work the second section with reverse shapings, casting on from right to left. (Cam Box will be on the LEFT side at Row 0).

Work Short Rows for the shaping. ON OPPOSITE SIDE of CAM BOX put into holding position 44 needles after Row 396, 9 needles after Rows 398, 400, 402, 404, 406. After Row 408 bring all needles back into working position, knit to Row 432, then bind off loosely the remaining 110 sts.

Decrease 2 sts. for EACH DART after Row 358, then again after Rows in (), ON CAM BOX SIDE, decrease 1 st. after Rows 364, (370), 374, (382), 384, 394, (394), then knit to Row 396.

ON CAM BOX SIDE, bind off 3 sts. after Rows 292, 293, 294, 295; 2 sts. after Rows 296, 297, 298, 299 ON EACH SIDE, decrease 1 st. after Rows 300, 302, 304, 306, 308. ON OPPOSITE SIDE of CAM BOX decrease 1 st. after Rows in (). ON CAM BOX SIDE decrease 1 st. after Rows 316, 324, 332, (332), 340, 348, 356, (356), then knit to Row 358.

ON EACH SIDE, increase 1 st. after Rows 156, 164, 172, 180, 188, 196, 204, 212, 220, 228, 236, 244, 252, 260, 268, 276, 284, then knit to Row 292.

Decrease 1 st. ON EACH SIDE and 2 sts. for the DART after Rows 24, 40, 56, 72, 86, 100, then knit to Row 156.

ROWS 0 to 24: Knit even.
 Cast on 158 sts. and work stockinette st.

BE SURE TO NOTIFY US IMMEDIATELY OF ANY CHANGE OF ADDRESS. THE POST OFFICE WILL NOT FORWARD YOUR MAGAZINE TO YOU.

HP 3611

SIZE: 38/40. **MATERIAL:** 15 3/4 oz. (9 balls) blue and 10 1/2 oz. (6 balls) white KNITTING Fortissima. **TENSION:** KNITTING 5 to 7. **GAUGE:** Pattern Stitch 14 sts., 2", 48 rows 2". **PATTERN:** Holding Position Design according to Line Drawing. **KNITTING** machines use Wheel 6 and the Needle Shifter. **NECKLINE DECREASES:** After rows indicated, hang the 1st st. ON NECK SIDE onto the 2nd st. **SLEEVE INCREASES:** ON EACH SIDE, hang the 1st st. from the row below onto the next empty needle. Reset Pattern Disc Number after shapings.

FINISHING: Block all sections to measurements given. Join front and back section at sides and shoulders. Sew sleeves together and set in. Join short ends of neckband at center back and front, then sew neckband to neckline.

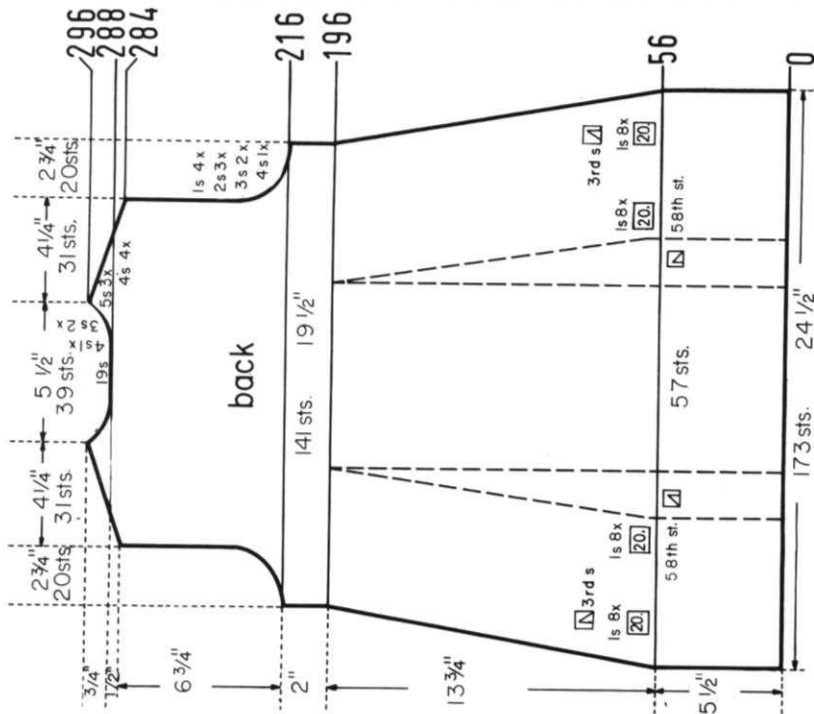
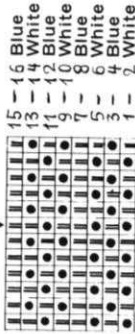

Move the Cam Box to the left side, turn the Row Counter back to 288 and complete the left half. Follow the instructions from *.

* ON CAM BOX SIDE, bind off 4 sts. after Row 288 (EVEN ROWS = SHOULDER SHAPING), 289 (ODD ROWS = NECK SHAPING), 290: 3 sts. after Row 291; 5 sts. after Row 292; 3 sts. after Row 293; 5 sts. after Rows 294, 296.

ON CAM BOX SIDE bind off 4 sts. after Rows 284, 285, 286, 287, then knit to Row 288, bind off the center 19 sts., put the needles on the left side into holding position and complete the right half first.

ON CAM BOX SIDE, bind off 4 sts. after Rows 216, 217; 3 sts. after Rows 218, 219, 220, 221; 2 sts. after Rows 222, 223, 224, 225, 226, 227; 1 st. after Rows 228, 229, 230, 231, 232, 233, 234, 235, then knit to Row 284.

Decrease 1 st. ON EACH SIDE and 1 st. for EACH DART, after Rows 56, 76, 96, 116, 136, 156, 176, 196, then knit to Row 216. (For front section knit to ROW 196 and make the last decreases). ROWS 0 to 56: Knit even.

Cast on 173 sts. and work stockinette st.

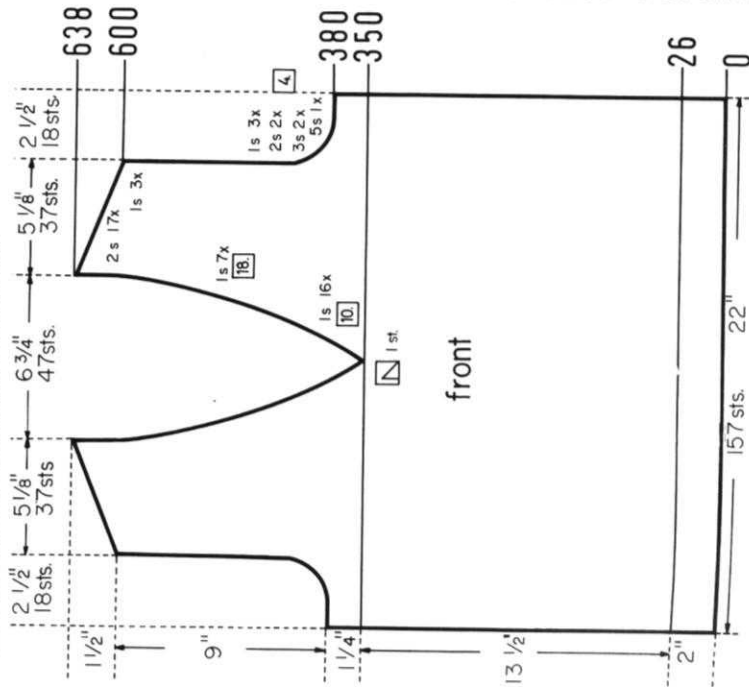

Move the Cam Box to the left side, turn the Row Counter back to 350 and complete the left half. Follow the instructions from *.

* ON NECK SIDE, decrease 1 st. after Rows 360, 370, then after Rows in (). ON CAM BOX SIDE, decrease 5 sts. after Row 380; (380), 3 sts. after Rows 384, 388; (390), 2 sts. after Rows 392, 396; 1 st. after Rows 400, (400), 404, 408. The Armhole shaping is now completed. Continue to decrease 1 st. ON NECK SIDE after Rows 410, 420, 430, 440, 450, 460, 470, 480, 490, 500, 510, 520, 538, 556, 574, 592, then again after Rows in (). For SHOULDER bind off 1 st. after Rows 600, 602, 604; 2 sts. after Rows 606, 608, 610 (610), 612, 614, 616, 618, 620, 622, 624, 626, 628, (628), 630, 632, 634, 636, 638.

Work the front section the same as the back section to ROW 350, then transfer the center st. onto the neighboring needle, put the needles on the left side into holding position and complete the right half first.

ON CAM BOX SIDE, bind off 4 sts. after Rows 410, 411; 3 sts. after Rows 414, 415, 418, 419; 2 sts. after Rows 422, 423, 426, 427, 430, 431. ON EACH SIDE, hang the 1st st. onto the 2nd st. after Rows 434, 438, 442, 446, 450, 454, 458, 462, 466, 470, 474, 478, 482, 486, 490, 494, 498, 502, 506, 510, 514, 518, 522, 526, 530, 534. ON CAM BOX SIDE, bind off 2 sts. after Rows 538, 539, 542, 543; 4 sts. after Rows 546, 547, 550, 551; 11 sts. after Row 554.

ON EACH SIDE, increase 1 st. after Rows 26, 42, 58, 74, 90, 106, 122, 138, 154, 170, 186, 202, 218, 234, 250, 266, 284, 302, 320, 338, 356, 374, 392, then knit to Row 410.

ROWS 0 to 26: Knit even, then transfer the ribber sts. to the main machine and work the Holding Position Design. Cast on 73 sts. with blue and work K1, P1, Ribbing.

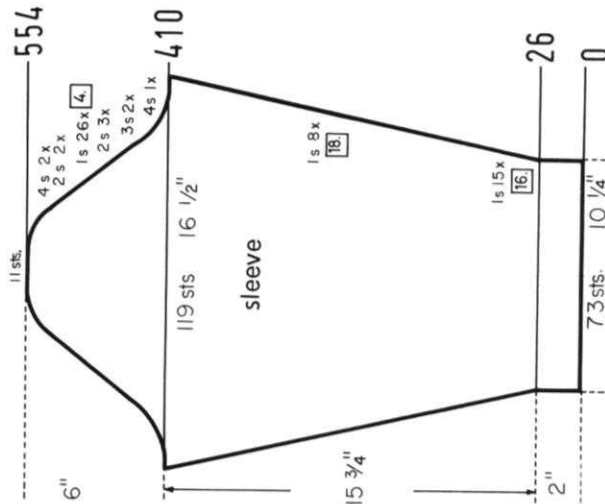

Move the Cam Box to the left side, turn the Row Counter back to 350 and complete the left half. Follow the instructions from *.

* ON NECK SIDE, decrease 1 st. after Rows 360, 370, then after Rows in (). ON CAM BOX SIDE, decrease 5 sts. after Row 380; (380), 3 sts. after Rows 384, 388; (390), 2 sts. after Rows 392, 396; 1 st. after Rows 400, (400), 404, 408. The Armhole shaping is now completed. Continue to decrease 1 st. ON NECK SIDE after Rows 410, 420, 430, 440, 450, 460, 470, 480, 490, 500, 510, 520, 538, 556, 574, 592, then again after Rows in (). For SHOULDER bind off 1 st. after Rows 600, 602, 604; 2 sts. after Rows 606, 608, 610 (610), 612, 614, 616, 618, 620, 622, 624, 626, 628, (628), 630, 632, 634, 636, 638.

Work the front section the same as the back section to ROW 350, then transfer the center st. onto the neighboring needle, put the needles on the left side into holding position and complete the right half first.

Cast on 133 sts. with blue and work K1, P1, Ribbing. ON OPPOSITE SIDE of CAM BOX put into holding position 2 needles after Rows 2, 4, 6, 8, 10, 12, 14. After Row 16 bring all needles back into working position and bind off all sts. the crocheted method for ribbing. Work the second section with reverse shaping, casting on from right to left. (Cam Box will be on the LEFT side at Row 0).

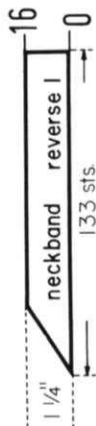

DP 7853

SIZE: 14/16. **MATERIAL:** 15½ oz. (9 balls) white and 10½ oz. (6 balls) red **KNITTING** Crocus Crepe. **TENSION:** **KNITTING** 6 to 8. **GAUGE:** 16 sts., 2" = 21 rows 2". **PATTERN:** Norwegian Design according to Line Drawing or use JAC. 40 and Pattern No. 417. In the instructions each row in the Norwegian Design is counted as 1 row, but several movements of the Cam Box are needed to complete 1 row. **EDGES:** K1, P1, Ribbing. **SLEEVE INCREASES:** After rows indicated, move the end st. ON EACH SIDE 1 needle outward, then place the 2nd st. from the row below onto the empty needle.

FINISHING: Block all sections to measurements given. Join front and back section at sides and shoulders, easing in the fullness at bustline of front section. Sew sleeves together and set in. Join neckband sections at back and front, then sew band to neckline.

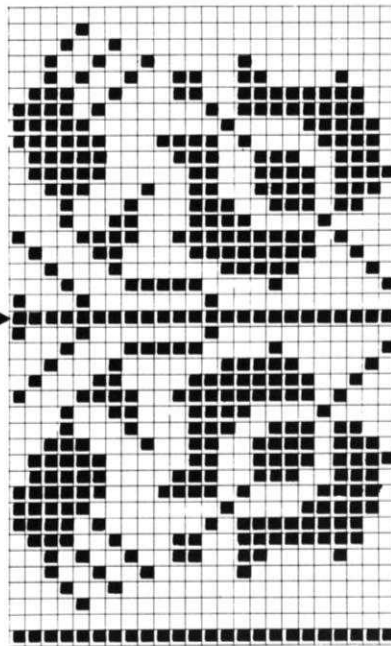

□ White ■ Red

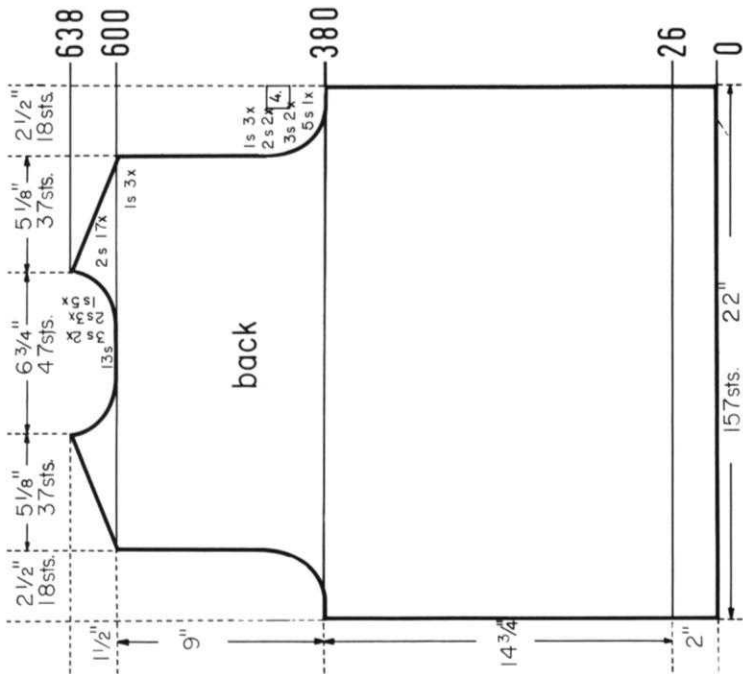
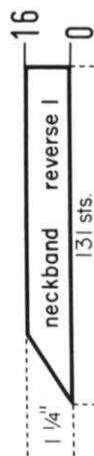

Move the Cam Box to the left side, turn the Row Counter back to 600 and complete the left half. Follow the instructions from *.

* ON CAM BOX SIDE, bind off 1 st. after Row 600 (EVEN ROWS = SHOULDER SHAPING); 3 sts. after Row 601 (ODD ROWS = NECK SHAPING); 1 st. after Row 602; 3 sts. after Row 603; 1 st. after Row 604; 2 sts. after Rows 605, 606, 607, 608, 609, 610; 1 st. after Row 611; 2 sts. after Row 612; 1 st. after Row 613; 2 sts. after Row 614; 1 st. after Row 615; 2 sts. after Row 616; 1 st. after Row 617; 2 sts. after Row 618; 1 st. after Row 619 (last time for Neck); 2 sts. after Rows 620, 622, 624, 626, 628, 630, 632, 634, 636, 638.

ON CAM BOX SIDE, bind off 5 sts. after Rows 380, 381; 3 sts. after Rows 384, 385, 388, 389; 2 sts. after Rows 392, 393, 396, 397; 1 st. after Rows 400, 401, 404, 405, 408, 409, then knit even to Row 600, bind off the center 13 sts., put the needles on the left side into holding position and complete the right half first.

ROWS 27 to 380: Knit even. (For Front Section knit even to ROW 350).

ROWS 0 to 26: Knit even, then transfer the ribber sts. to the main machine and work the Holding Position Design.

Cast on 157 sts. with blue and work K1, P1, Ribbing.

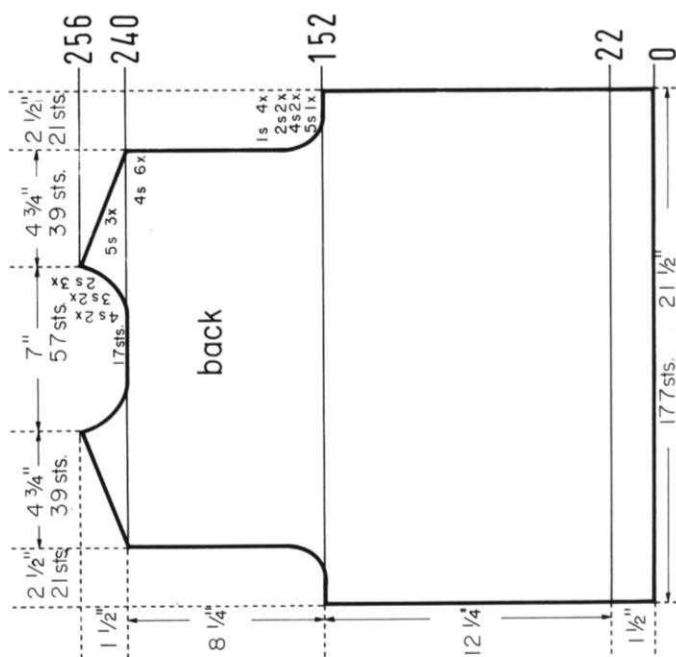

Move the Cam Box to the left side, turn the Row Counter back to 240 and complete the left half. Follow the instructions from *.

* ON CAM BOX SIDE, bind off 4 sts. after Row 240 (EVEN ROWS = SHOULDER SHAPING), 241 (ODD ROWS = NECK SHAPING), 242, 243, 244; 3 sts. after Row 245; 4 sts. after Row 246; 3 sts. after Row 247; 4 sts. after Row 248; 2 sts. after Row 249; 4 sts. after Row 250; 2 sts. after Row 251; 5 sts. after Row 252; 2 sts. after Row 253; 5 sts. after Rows 254, 256.

ON CAM BOX SIDE, bind off 5 sts. after Rows 152, 153; 4 sts. after Rows 154, 155, 156, 157; 2 sts. after Rows 158, 159, 160, 161; 1 st. after Rows 162, 163, 164, 165, 166, 167, 168, 169, then knit to Row 240, bind off the center 17 sts., put the needles on the left side into holding position and complete the right half first.

ROWS 23 to 152: Knit even.

ROWS 0 to 22: Knit even, then transfer the ribber sts. to the main machine and begin the Norwegian Design.

Cast on 177 sts. with white and work K1, P1, Ribbing.

Continued on next page

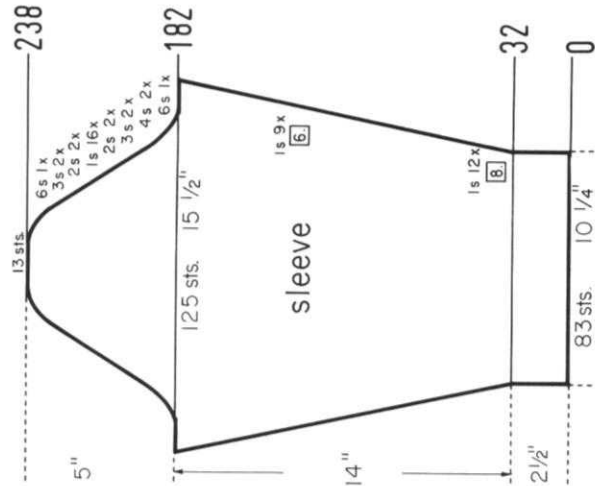

ON CAM BOX SIDE, bind off 6 sts. after Rows 182, 183; 4 sts. after Rows 184, 185, 186, 187; 3 sts. after Rows 188, 189, 190, 191; 2 sts. after Rows 192, 193, 194, 195. ON EACH SIDE, hang the 1st st. onto the 2nd st. after Rows 196, 198, 200, 202, 204, 206, 208, 210, 212, 214, 216, 218, 220, 222, 224, 226. ON CAM BOX SIDE, bind off 2 sts. after Rows 228, 229, 230, 231; 3 sts. after Rows 232, 233, 234, 235; 6 sts. after Rows 236, 237; 13 sts. after Row 238.

ON EACH SIDE, increase 1 st. after Rows 32, 40, 48, 56, 64, 72, 80, 88, 96, 104, 112, 120, 128, 134, 140, 146, 152, 158, 164, 170, 176, then knit to Row 182.

ROWS 0 to 32: Knit even, then transfer the ribber sts. to the main machine and begin the Norwegian Design.

Cast on 83 sts. with white and work K1, P1, Ribbing.

Move the Cam Box to the left side, turn the Row Counter back to 160 and complete the left half. Follow the instructions from *.

* Hang the 1st st. ON NECK SIDE onto the 2nd st. after Rows in (). ON CAM BOX SIDE, bind off 5 sts. after Row 160; 4 sts. after Rows 162, (162), 164; (164), 2 sts. after Rows 166, (166), 168; (168), 1 st. after Rows 170, (170), 172; (172), 174, (174), 176. The Armhole shaping is now completed. Continue to decrease 1 st. ON NECK SIDE after Rows 178, 182, 186, 190, 194, 198, 202, 206, 210, 214, 218, 222, 226, 230, 234, 238, 242, 246, then again after Rows in (). For SHOULDER bind off 4 sts. after Rows 248, 250, (250), 252, 254, (254), 256, 258; (258), 5 sts. after Rows 260, 262, 264.

ROWS 153 to 160: Knit even, then transfer the center st. onto the neighboring needle, put the needles on the left side into holding position and complete the right half first.

Work the front section the same as the back section to ROW 152.

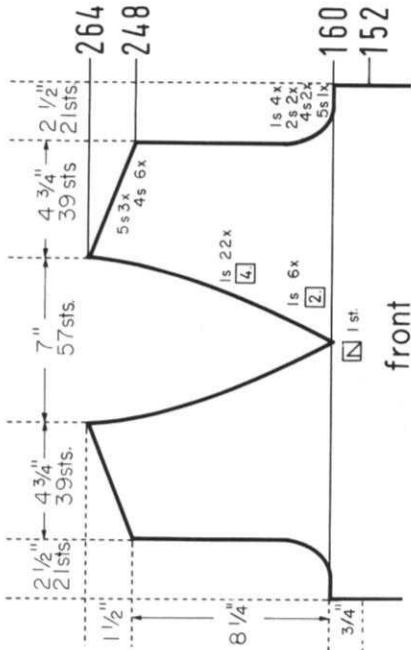

DP 7854

SIZE: 14/16. MATERIAL: 14 oz. (8 balls) white KNITTING Fortissima. TENSION: KNITTING 4 to 6. GAUGE: Stockinette Stitch 16 sts. 2", 23 rows 2". PATTERN: Stockinette Stitch, EDGES and COLLAR: K1, P1, Ribbing. SLEEVE INCREASES: After rows indicated, move the 2 end sts. ON EACH SIDE 1 needle outward, then place the 3rd st. from the row below onto the empty needle.

FINISHING: Block all sections to measurements given. Join front and back section at sides and shoulders, easing in the fullness at bustline of front section. Sew sleeves together and set in. Join short ends of collar, then sew 1 edge of collar to inside and 1 edge to outside of neckline.

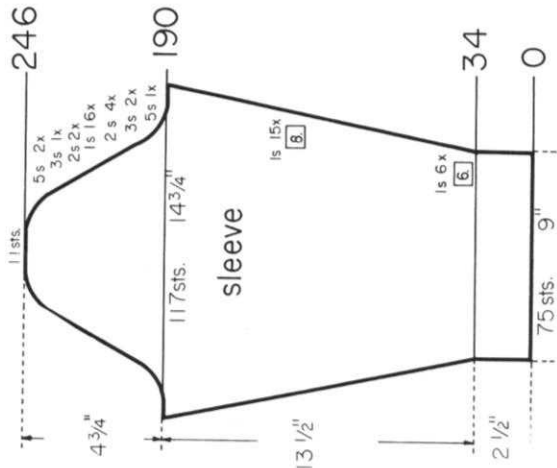

ON CAM BOX SIDE, bind off 5 sts. after Rows 190, 191; 3 sts. after Rows 192, 193, 194, 195; 2 sts. after Rows 196, 197, 198, 199, 200, 201, 202, 203. ON EACH SIDE, hang the 1st st. onto the 2nd st. after Rows 204, 206, 208, 210, 212, 214, 216, 218, 220, 222, 224, 226, 228, 230, 232, 234. ON CAM BOX SIDE, bind off 2 sts. after Rows 236, 237, 238, 239; 3 sts. after Rows 240, 241; 5 sts. after Rows 242, 243, 244, 245; 11 sts. after Row 246.

ON EACH SIDE, increase 1 st. after Rows 34, 40, 46, 52, 58, 64, 70, 78, 86, 94, 102, 110, 118, 126, 134, 142, 150, 158, 166, 174, 182, then knit to Row 190.

ROWS 0 to 34: Knit even, then change to stockinette st.

Cast on 75 sts. and work K1, P1, Ribbing.

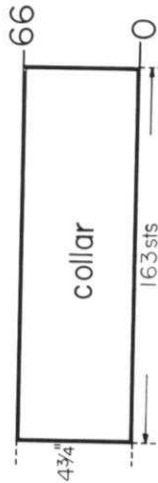

Cast on 163 sts. and work 66 rows K1, P1, Ribbing, then bind off all sts. the crochet method for ribbing.

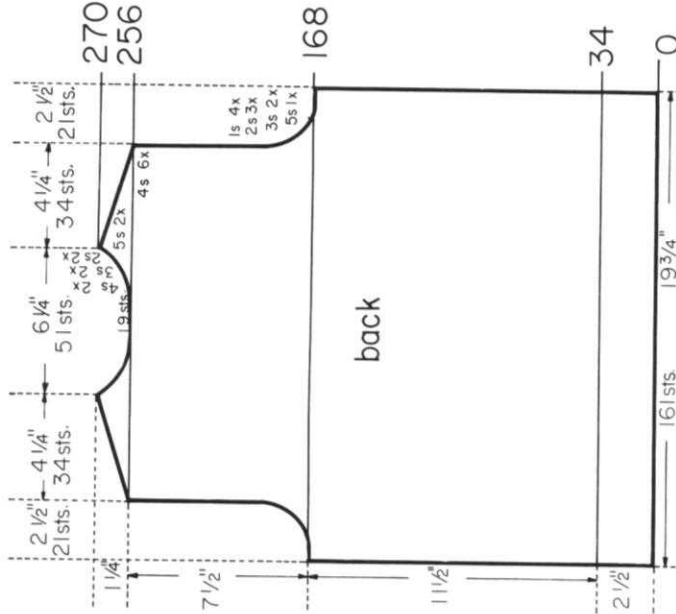

Move the Cam Box to the left side, turn the Row Counter back to 256 and complete the left half. Follow the instructions from *.

* ON CAM BOX SIDE, bind off 4 sts. after Rows 256 (EVEN ROWS = SHOULDER SHAPING), 257 (ODD ROWS = NECK SHAPING), 258, 259, 260; 3 sts. after Row 261; 4 sts. after Row 262; 3 sts. after Row 263; 4 sts. after Row 264; 2 sts. after Row 265; 4 sts. after Row 266; 2 sts. after Row 267; 5 sts. after Rows 268, 270.

ON CAM BOX SIDE, bind off 5 sts. after Rows 168, 169; 3 sts. after Rows 170, 171, 172, 173; 2 sts. after Rows 174, 175, 176, 177, 178, 179; 1 st. after Rows 180, 181, 182, 183, 184, 185, 186, 187, then knit to Row 256, bind off the center 19 sts., put the needles on the left side into holding position and complete the right half first.

ROWS 35 to 168: Knit even.

ROWS 0 to 34: Knit even, then change to stockinette st.

Cast on 161 sts. and work K1, P1, Ribbing.

HP 3612

SIZE: 38/40. MATERIAL: 15½ oz. (9 balls) white KNITTING Fortissima. TENSION: KNITTING 4 to 6. GAUGE: 16 sts, 2", 23 rows 2". PATTERN: Stockinette Stitch. EDGES and COLLAR: K1, P1, Ribbing. SLEEVE INCREASES: After rows indicated, move the 2 end sts. ON EACH SIDE 1 needle outward, then place the 3rd st. from the row below onto the empty needle.

FINISHING: Block each section to measurements given. Join front and back section at sides and shoulders. Sew sleeves together and set in. Join short ends of collar, then sew 1 edge of collar to inside and 1 edge to outside of neckline.

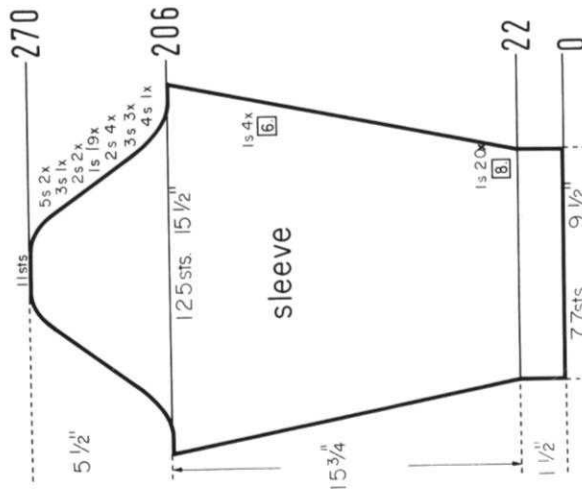
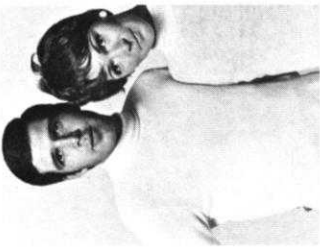

ON CAM BOX SIDE, bind off 4 sts. after Rows 206, 207; 3 sts. after Rows 208, 209, 210, 211, 212, 213; 2 sts. after Rows 214, 215, 216, 217, 218, 219, 220, 221. ON EACH SIDE, hang the 1st st. onto the 2nd st. after Rows 222, 224, 226, 228, 230, 232, 234, 236, 238, 240, 242, 244, 246, 248, 250, 252, 254, 256, 258. ON CAM BOX SIDE, bind off 2 sts. after Rows 260, 261, 262, 263; 3 sts. after Rows 264, 265; 5 sts. after Rows 266, 267, 268, 269; 11 sts. after Row 270.

ON EACH SIDE, increase 1 st. after Rows 22, 30, 38, 46, 54, 62, 70, 78, 86, 94, 102, 110, 118, 126, 134, 142, 150, 158, 166, 174, 182, 188, 194, 200, then knit to Row 206.

ROWS 0 to 22: Knit even, then change to stockinette st. Cast on 77 sts. and work K1, P1, Ribbing.

Move the Cam Box to the left side, turn the Row Counter back to 262 and complete the left half. Follow the instructions from *.

* ON CAM BOX SIDE, bind off 4 sts. after Row 263 (ODD ROWS = NECK SHAPING); 3 sts. after Rows 265, 267; 2 sts. after Rows 269, 271, 273; 1 st. after Rows 275, 277, 279, 281. For SHOULDER bind off 4 sts. after Rows 280, 292; 5 sts. after Rows 294, 296, 298, 300, 302, 304.

Work the front section the same as the back section to ROW 262, then bind off the center 12 sts., put the needles on the left side into holding position and complete the right half first.

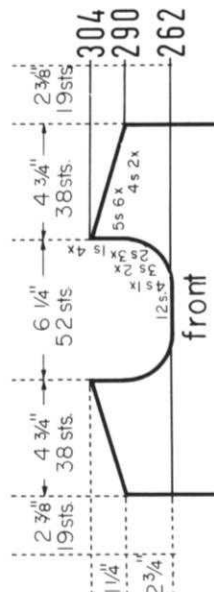

Move the Cam Box to the left side, turn the Row Counter back to 238 and complete the left half. Follow the instructions from *.

* ON CAM BOX SIDE, bind off 3 sts. after Rows 239, 241, 243; 2 sts. after Rows 245, 247, 249; 1 st. after Rows 251, 253, 255, 257. For SHOULDER bind off 4 sts. after Rows 266, 268, 270, 272, 274, 276; 5 sts. after Rows 278, 280.

ON CAM BOX SIDE, bind off 5 sts. after Rows 178, 179; 3 sts. after Rows 180, 181, 182, 183; 2 sts. after Rows 184, 185, 186, 187, 188, 189; 1 st. after Rows 190, 191, 192, 193, 194, 195, 196, 197, then knit to Row 238, bind off the center 13 sts., put the needles on the left side into holding position and complete the right half first.

ROWS 169 to 178: Knit even. Work the front section the same as the back section to ROW 168.

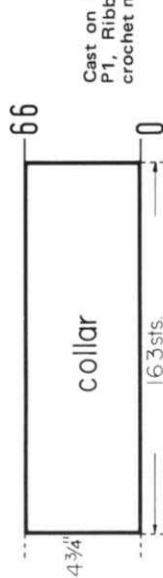
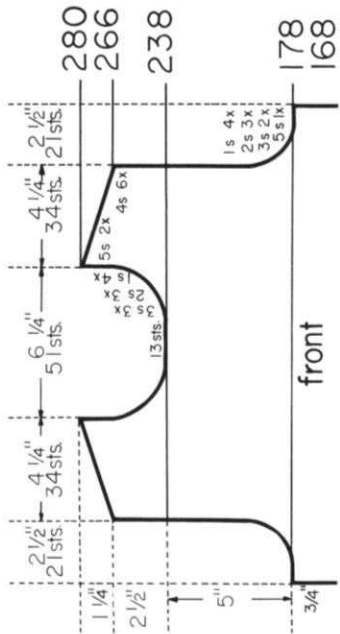

Cast on 163 sts. and work 66 rows K1, P1, Ribbing, then bind off all sts. the crocheted method for ribbing.

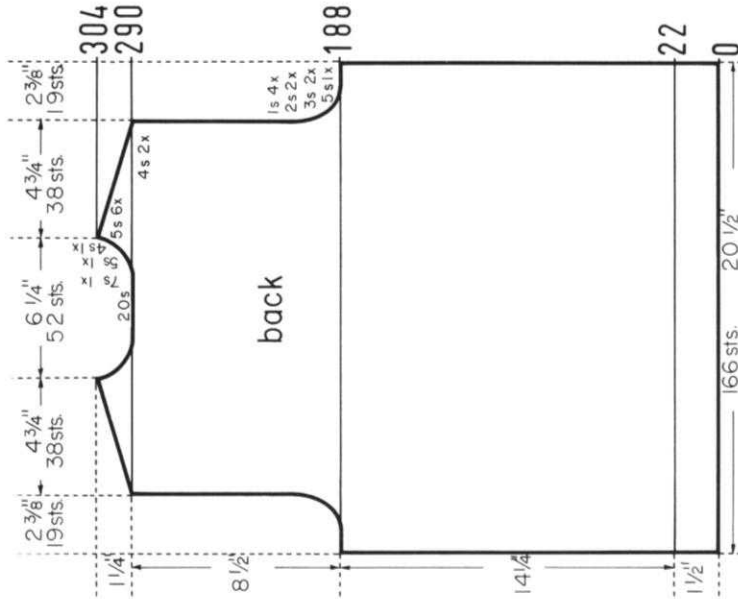

Move the Cam Box to the left side, turn the Row Counter back to 290 and complete the left half. Follow the instructions from *.

* ON CAM BOX SIDE, bind off 4 sts. after Row 290 (EVEN ROWS = SHOULDER SHAPING); 7 sts. after Row 291 (ODD ROWS = NECK SHAPING); 4 sts. after Row 292; 5 sts. after Rows 293, 294; 4 sts. after Row 295; 5 sts. after Rows 296, 298, 300, 302, 304.

ON CAM BOX SIDE, bind off 5 sts. after Rows 188, 189; 3 sts. after Rows 190, 191, 192, 193; 2 sts. after Rows 194, 195, 196, 197; 1 st. after Rows 198, 199, 200, 201, 202, 203, 204, 205, then knit to Row 290, bind off the center 20 sts., put the needles on the left side into holding position and complete the right half first. (After completing the armhole shaping on the FRONT SECTION, knit even to ROW 262).

ROWS 23 to 188: Knit even. ROWS 0 to 22: Knit even, then change to stockinette st. Cast on 166 sts. and work K1, P1, Ribbing.

DP 7857

SIZE: 14/16. **MATERIAL:** 14 oz. (8 balls) turquoise, 5½ oz. (3 balls) black, 5½ oz. (3 balls) gray and 3½ oz. (2 balls) red KNITTING CROCHUS CREPE.
TENSION: KNITTING 6 to 8. **GAUGE:** 16 sts, 2", 21 rows 2". **PATTERN:** Norwegian Design according to Line Drawing or use JAC 40 and Pattern No. 430. In the instructions each row in the Norwegian Design is counted as 1 row, but several movements of the Cam Box are needed to complete 1 row. **EDGES:** K1, P1, Ribbing. When decreasing 1 st., hang the 1st st. on the appropriate side onto the 2nd st. **SLEEVE INCREASES:** After rows indicated, move the end st. ON EACH SIDE 1 needle outward, then place the 2nd st. from the row below onto the empty needle.

FINISHING: Block each section to measurements given. Join front and back section at sides and shoulders. Sew sleeves together and set in. Turn under 20 rows on lower edge and 25 rows on sleeve edges and hem to wrong side. Join short ends of neckband, then sew 1 edge of neckband to inside and 1 edge to outside of neckline.

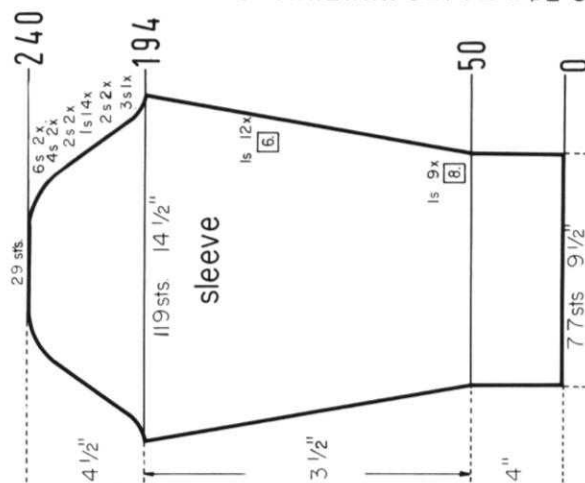

ON CAM BOX SIDE, bind off 3 sts. after Rows 194, 195; 2 sts. after Rows 196, 197, 198, 199. ON EACH SIDE decrease 1 st. after Rows 200, 202, 204, 206, 208, 210, 212, 214, 216, 218, 220, 222, 224, 226. ON CAM BOX SIDE, bind off 2 sts. after Rows 228, 229, 230, 231; 4 sts. after Rows 232, 233, 234, 235; 6 sts. after Rows 236, 237, 238, 239; 29 sts. after Row 240.

ON EACH SIDE, increase 1 st. after Rows 50, 58, 66, 74, 82, 90, 98, 106, 114, 122, 128, 134, 140, 146, 152, 158, 164, 170, 176, 182, 188, then knit to Row 194.

ROWS 0 to 50: Knit even, then transfer the ribber sts. to the main machine and begin the Norwegian Design.

Cast on 77 sts. with turquoise and work K1, P1, Ribbing.

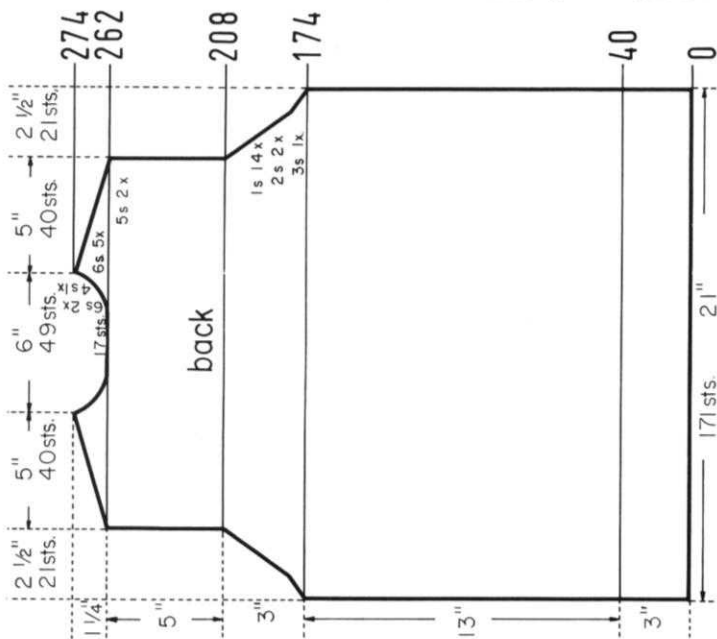

Move the Cam Box to the left side, turn the Row Counter back to 262 and complete the left half. Follow the instructions from *.

* ON CAM BOX SIDE, bind off 5 sts. after Row 262 (EVEN ROWS = SHOULDER SHAPING); 6 sts. after Row 263 (ODD ROWS = NECK SHAPING); 5 sts. after Row 264; 6 sts. after Rows 265, 266; 4 sts. after Row 267; 6 sts. after Rows 268, 270, 272, 274.

ON CAM BOX SIDE, bind off 3 sts. after Rows 174, 175; 2 sts. after Rows 176, 177, 178, 179. ON EACH SIDE decrease 1 st. after Rows 180, 182, 184, 186, 188, 190, 192, 194, 196, 198, 200, 202, 204, 206, then knit even to Row 262, bind off the center 17 sts., put the needles on the left side into holding position and complete the right half first. (After completing the armhole shaping on the front section, knit to ROW 208.)

ROWS 41 to 174: Knit even.

ROWS 0 to 40: Knit even, then transfer the ribber sts. to the main machine and begin the Norwegian Design.

Cast on 171 sts. with turquoise and work K1, P1, Ribbing.

Move the Cam Box to the left side, turn the Row Counter back to 220 and complete the left half. Follow the instructions from *.

* ON NECK SIDE, decrease 1 st. after Rows 222, 224, 226, 228, 230, 232, 234, 236, 238, 240, 242, 244, 246, 248, 250, 252, 254, 256, 258, 260, then again after Rows in (. For SHOULDER, bind off 5 sts. after Rows 262, (262), 264; (264), 6 sts. after Rows 266, (266), 268, (268), 270, 272, 274.

ROWS 209 to 220: Knit even, then transfer the center st. onto the neighboring needle, put the needles on the left side into holding position and complete the right half first.

Work the front section the same as the back section to ROW 208.

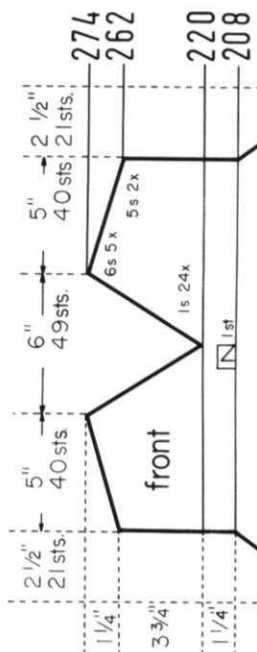

Cast on 173 sts. with turquoise and work K1, P1, Ribbing. ON EACH SIDE, decrease 1 st. after Rows 2, 4, 6, 8, 10, 12, 14, 16, 18, 20, then increase 1 st. ON EACH SIDE after Rows 22, 24, 26, 28, 30, 32, 34, 36, 38, 40, then knit to Row 42 and bind off all sts. the crochet method for ribbing.



KK 5231

SIZE: 6-8, (Chest 24"-26"). **MATERIAL:** 7 oz. (4 balls) dark blue, 3 1/2 oz. (2 balls) white, 3 1/2 oz. (2 balls) red and 1 1/2 oz. (1 ball) medium blue **KNITTING CROCHUS CREPE. TENSION:** KNITTING 6 to 8. **GAUGE:** 16 sts. 2", 21 rows 2". **PAT. TERN:** Norwegian Design according to Line Drawing or use JAC 40 and Pattern No. 430. In the instructions each row in the Norwegian Design is counted as 1 row, but several movements of the Cam Box are needed to complete 1 row. **EDGES:** K1, P1. **Ribbing.** **SLEEVE INCREASES:** After rows indicated, move the end st. ON EACH SIDE 1 row below onto the empty needle.

FINISHING: Block all sections to measurements given. Join front and back section at sides and shoulders. Sew sleeves together and set in. Turn under 20 rows on lower edge and 22 rows on sleeve edges and hem to wrong side. Join short ends of neckband, then sew 1 edge of neckband to inside and 1 edge to outside of neckline.

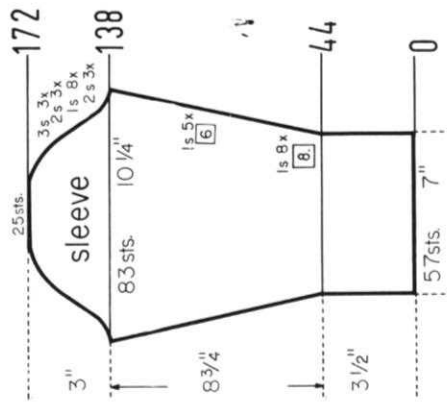
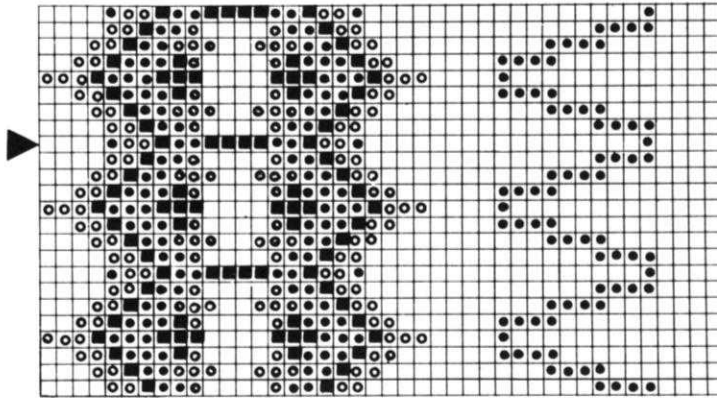

ON CAM BOX SIDE, bind off 2 sts. after Rows 138, 139, 140, 141, 142, 143; 1 st. after Rows 144, 145, 146, 147, 148, 149, 150, 151, 152, 153, 154, 155, 156, 157, 158, 159; 2 sts. after Rows 160, 161, 162, 163, 164, 165; 3 sts. after Rows 166, 167, 168, 169, 170, 171; 25 sts. after Row 172. (Knit the last 2 rows with dark blue).

ON EACH SIDE, increase 1 st. after Rows 44, 52, 60, 68, 76, 84, 92, 100, 108, 114, 120, 126, 132, then knit to Row 138.

ROWS 0 to 44: Knit even, then transfer the ribber sts. to the main machine and begin the Norwegian Design.

Cast on 57 sts. with dark blue and work K1, P1, Ribbing.

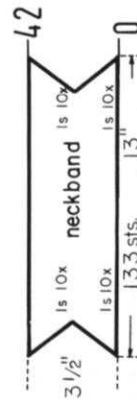

Cast on 133 sts. and work K1, P1, Ribbing. ON EACH SIDE, decrease 1 st. after Rows 2, 4, 6, 8, 10, 12, 14, 16, 18, 20, then increase 1 st. ON EACH SIDE after Rows 22, 24, 26, 28, 30, 32, 34, 36, 38, 40, then knit to Row 42 and bind off all sts. the crochet method for ribbing.

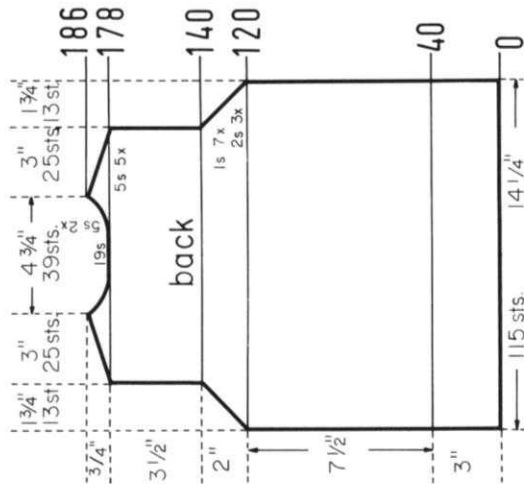

Move the Cam Box to the left side, turn the Row Counter back to 178 and complete the left half. Follow the instructions from *.

* ON CAM BOX SIDE, bind off 5 sts. after Rows 178 (EVEN ROWS = SHOULDER SHAPING), 179 (ODD ROWS = NECK SHAPING), 180, 181, 182, 184, 186.

ON CAM BOX SIDE, bind off 2 sts. after Rows 120, 121, 122, 123, 124, 125; 1 st. after Rows 126, 127, 128, 129, 130, 131, 132, 133, 134, 135, 136, 137, 138, 139. Now knit to Row 178, bind off the center 19 sts., put the needles on the left side into holding position and complete the right half first. (After completing the armhole shaping on the front section, knit to ROW 140).

ROWS 41 to 120: Knit even.

ROWS 0 to 40: Knit even, then transfer the ribber sts. to the main machine and begin the Norwegian Design.

Cast on 115 sts. with dark blue and work K1, P1, Ribbing.

Move the Cam Box to the left side, turn the Row Counter back to 140 and complete the left half. Follow the instructions from *.

* ON NECK SIDE, hang the 1st st. onto the 2nd st. after Rows 142, 144, 146, 148, 150, 152, 154, 156, 158, 160, 162, 164, 166, 168, 170, 172, 174, 176, 178, 1 more time after Row in (). For SHOULDER bind off 5 sts. after Rows 178, (178), 180, 182, 184, 186.

Work the front section the same as the back section to ROW 140, then transfer the center st. onto the neighboring needle, put the needles on the left side into holding position and complete the right half first.

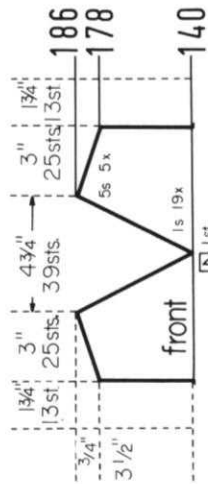

SIZE: 12-14. (Chest 30"-32"). **MATERIAL:** 1 1/4 oz. (7 balls) white and 5 1/2 oz. (3 balls) blue **KNITTING** Crocus Crepe. **TENSION:** KNITTING 6 to 8. **GUAGE:** 16 sts. 2", 21 rows 2". **PATTERN:** Stockinette Stitch and a Norwegian Design according to Line Drawing or use JAC 40 and Pattern No. 423. In the instructions each row in the Norwegian Design is counted as 1 row, but several movements of the Cam Box are needed to complete 1 row. **EDGES and COLLAR:** K1, P1, Ribbing. **SLEEVE INCREASES:** After rows indicated, move the 2 end sts. **ON EACH SIDE** 1 needle outward, then place the 3rd st. from the row below onto the empty needle.

FINISHING: Block each section to measurements given. Join front and back section at shoulders, then, at sides, leaving the upper portion 7 1/2" open for the armholes. Sew sleeves together and set in. Join short ends of collar, then sew 1 edge of collar to inside and 1 edge to outside of neckline.

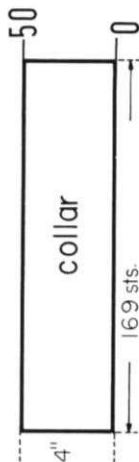

Cast on 169 sts. with white and work 50 rows K1, P1, Ribbing, then bind off all sts. the crochet method for ribbing.

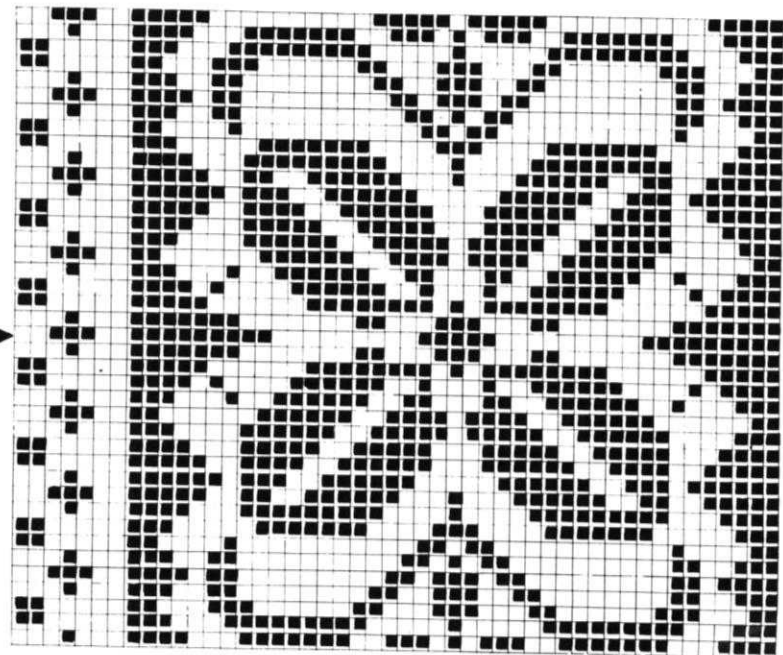

Blue □ White

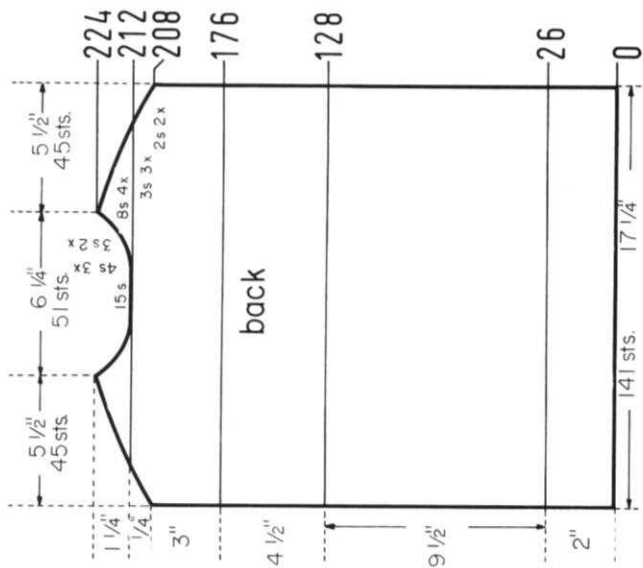

Move the Cam Box to the left side, turn the Row Counter back to 212 and complete the left half. Follow the instructions from *.

* ON CAM BOX SIDE, bind off 3 sts. after Row 212 (EVEN ROWS = SHOULDER SHAPING); 4 sts. after Row 213 (ODD ROWS = NECK SHAPING); 3 sts. after Row 214; 4 sts. after Row 215; 3 sts. after Row 216; 4 sts. after Row 217; 8 sts. after Row 218; 3 sts. after Row 219; 8 sts. after Row 220; 3 sts. after Row 221; 8 sts. after Row 222, 224.

ON CAM BOX SIDE, bind off 2 sts. after Row 208, 209, 210, 211, then knit to Row 212, bind off the center 15 sts., put the needles on the left side into holding position and complete the right half first.

ROWS 177 to 208: Knit even.

ROWS 129 to 176: Knit even, then change to blue and work stockinette st.

ROWS 27 to 128: Knit even, then begin the Norwegian Design.

ROWS 0 to 26: Knit even, then change to stockinette st.

Cast on 141 sts. with white and work K1, P1, Ribbing.

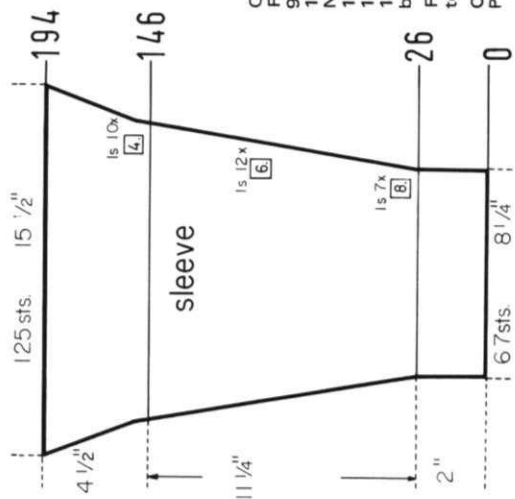

ON EACH SIDE, increase 1 st. after Rows 26, 34, 42, 50, 58, 66, 74, 82, 88, 94, 100, 106, 112, 118, 124, 130, 136, 142, then knit to Row 146 and begin the Norwegian Design. Continue to increase 1 st. ON EACH SIDE after Rows 148, 154, 158, 162, 166, 170, 174, 178, 182, 186, 190, then knit to Row 194 and bind off all 125 sts.

ROWS 0 to 26: Knit even, then change to stockinette st.

Cast on 67 sts. with white and work K1, P1, Ribbing.

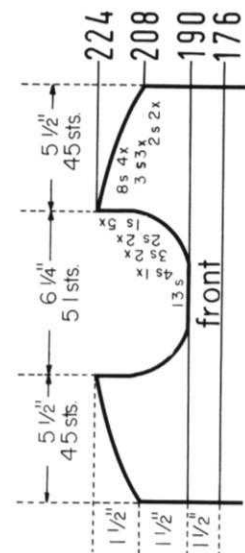

Move the Cam Box to the left side, turn the Row Counter back to 190 and complete the left half. Follow the instructions from *.

* ON CAM BOX SIDE, bind off 4 sts. after Row 191 (ODD ROWS = NECK SHAPING); 3 sts. after Rows 193, 195; 2 sts. after Rows 197, 199; 1 st. after Rows 201, 203, 205, 207; 2 sts. after Row 208 (EVEN ROWS = SHOULDER SHAPING); 1 st. after Row 209 (last time for Neck); 2 sts. after Row 210; 3 sts. after Rows 212, 214, 216; 8 sts. after Rows 218, 220, 222, 224.

ROWS 177 to 190: Knit even, then bind off the center 13 sts., put the needles on the left side into holding position and complete the right half first.

Work the front section the same as the back section to Row 176, then change to blue and work stockinette st.

MK 5229

SIZE: 12-14, (Chest 30"-32"). **MATERIAL:** 12½" oz. (7 balls) red and 10½ oz. (6 balls) white **KNITTING:** Double Knitting. **TENSION:** KNITTING 7 to 9. **GAUGE:** 15 sts, 2", 18 rows 2". **PATTERN:** Norwegian Design according to Line Drawing or use JAC40 and Pattern No. 422. In the instructions, each row in the Norwegian Design is counted as 1 row, but several movements of the Cam Box are needed to complete 1 row. **EDGES and COLLAR:** K1, P1, Ribbing. **SLEEVE INCREASES:** After rows indicated, move the 1st st. ON EACH SIDE 1 needle outward, then place the 2nd st. from the row below onto the empty needle.

FINISHING: Block each section to measurements given. Join front and back section at sides and shoulders. Sew sleeves together and set in. Join short ends of collar, then sew 1 edge of collar to inside and 1 edge to outside of neckline.

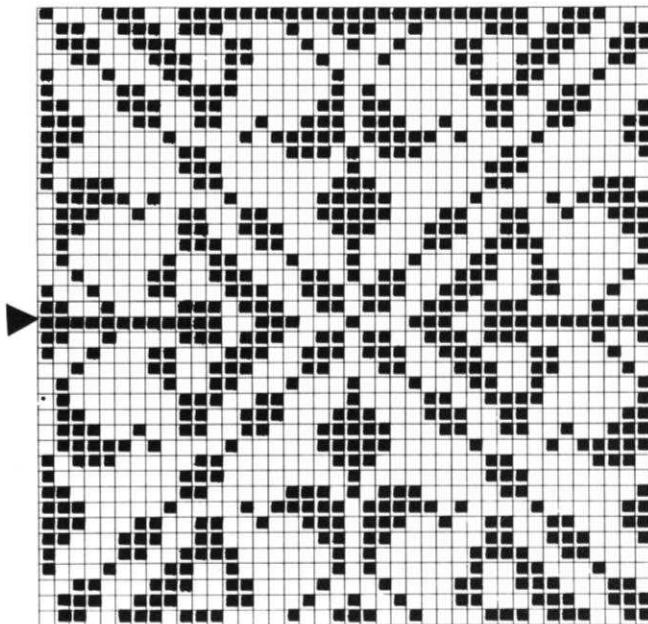

□ White ■ Red

Move the Cam Box to the left side, turn the Row Counter back to 158 and complete the left half. Follow the instructions from *.

* ON CAM BOX SIDE, bind off 3 sts. after Rows 159, 161 (ODD ROWS = NECK SHAPING); 2 sts. after Rows 163, 165; 1 st. after Rows 167, 169, 171, 173, 175. For SHOULDER bind off 5 sts. after Rows 178, 180, 182; 6 sts. after Rows 184, 186, 188.

Work the front section the same as the back section to Row 158, then bind off the center 13 sts., put the needles on the left side into holding position and complete the right half first.

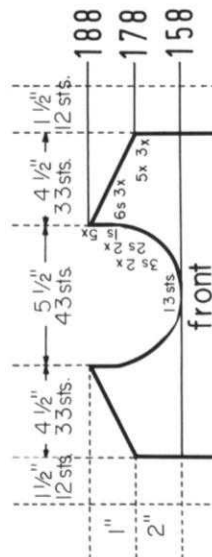

Move the Cam Box to the left side, turn the Row Counter back to 178 and complete the left half. Follow the instructions from *.

* ON CAM BOX SIDE, bind off 5 sts. after Rows 178 (EVEN ROWS = SHOULDER SHAPING), 179 (ODD ROWS = NECK SHAPING), 180; 4 sts. after Row 181; 5 sts. after Row 182; 3 sts. after Row 183; 6 sts. after Row 184; 3 sts. after Row 185; 6 sts. after Rows 186, 188.

ON CAM BOX SIDE, bind off 2 sts. after Rows 110, 111, 112, 113, 114, 115, 116, 117, 118, 119; 1 st. after Row 120, 121, 122, 123, then knit to Row 178, bind off the center 13 sts., put the needles on the left side into holding position and complete the right half first. (After last armhole decrease ON FRONT SECTION knit even to Row 158).

ROWS 27 to 110: Knit even.

ROWS 0 to 26: Knit even, then transfer the ribber sts. to the main machine and work the Norwegian Design.

Cast on 133 sts. with red and work K1, P1, Ribbing.

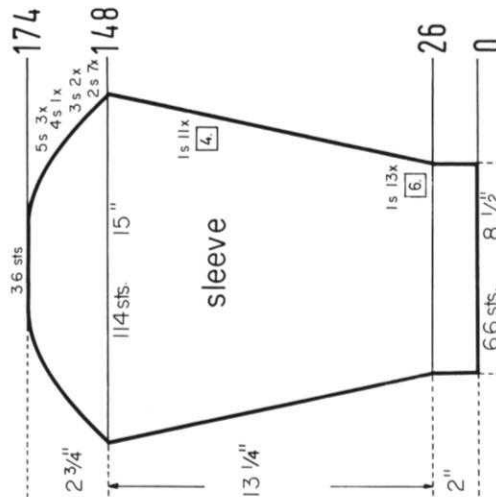
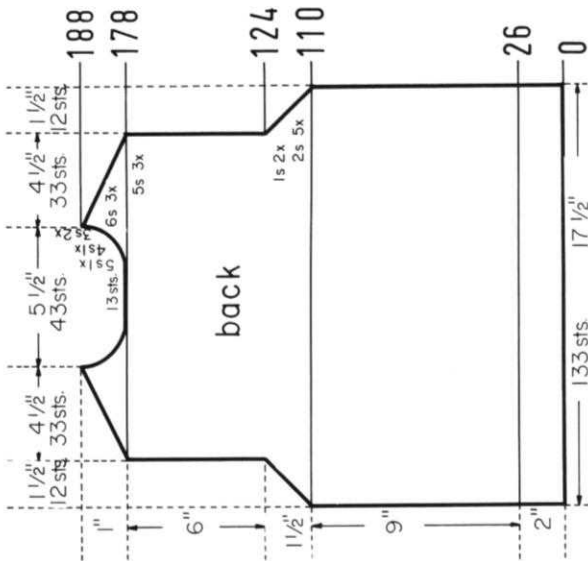

ON CAM BOX SIDE, bind off 2 sts. after Rows 148, 149, 150, 151, 152, 153, 154, 155, 156, 157, 158, 159, 160, 161; 3 sts. after Rows 162, 163, 164, 165; 4 sts. after Rows 166, 167; 5 sts. after Rows 168, 169, 170, 171, 172, 173; 36 sts. after Row 174.

ON EACH SIDE, increase 1 st. after Rows 26, 32, 38, 44, 50, 56, 62, 68, 74, 80, 86, 92, 98, 104, 108, 112, 116, 120, 124, 128, 132, 136, 140, 144, then knit to Row 148.

ROWS 0 to 26: Knit even, then transfer the ribber sts. to the main machine and work the Norwegian Design.

Cast on 66 sts. with red and work K1, P1, Ribbing.

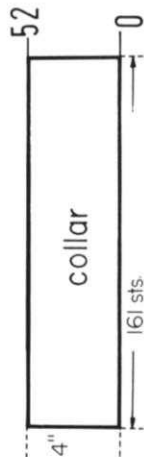

Cast on 161 sts. with red and work 52 rows K1, P1, Ribbing, then bind off all sts. the crochet method for ribbing.



SIZE: 42/44. **MATERIAL:** 12 1/4 oz. (7 balls) beige, 10 1/2 oz. (6 balls) brown, 5 1/2 oz. (3 balls) green and 5 1/4 oz. (3 balls) gold **KNITTING** Crocus Crepe. **TENSION:** KNITTING 6 TO 8. **GAUGE:** 16 sts. 2", 21 rows 2". **PATTERN:** Norwegian Design according to Line Drawing or use JAC 40 and Pattern No. 416. In the instructions, each row in the Norwegian Design is counted as 1 row, but several movements of the Cam Box are needed to complete 1 row. **EDGES and COLLAR:** K1, P1, Ribbing. **SLEEVE INCREASES:** After rows indicated, move the 1st st. ON EACH SIDE 1 needle outward, then place the 2nd st. from the row below onto the empty needle.

FINISHING: Block each section to measurements given. Join front and back section at sides and shoulders. Sew sleeves together and set in. Join short ends of collar, then sew 1 edge of collar to inside and 1 edge to outside of neckline.

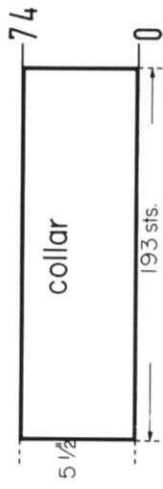
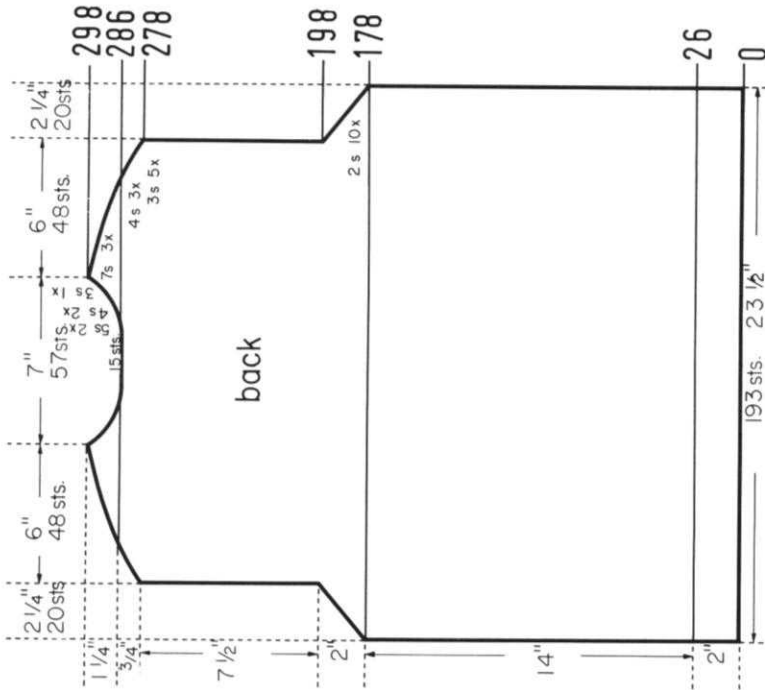

Cast on 193 sts. with beige and work 4 rows K1, P1, Ribbing, then bind off all sts. the crochet method for ribbing.

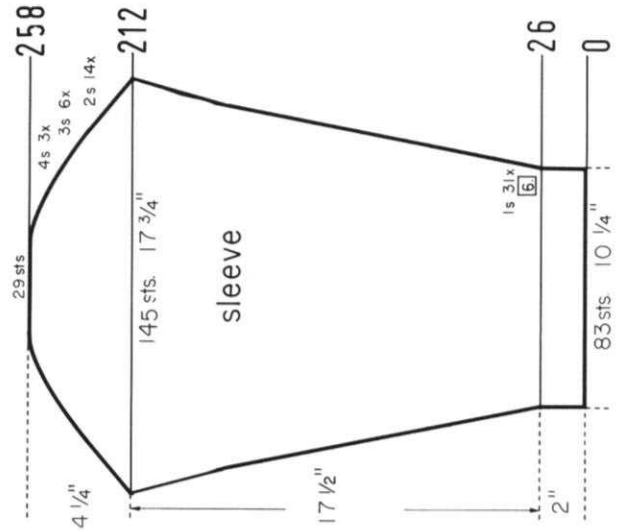

ON CAM BOX SIDE, bind off 2 sts. after Rows 212, 213, 214, 215, 216, 217, 218, 219, 220, 221, 222, 223, 224, 225, 226, 227, 228, 229, 230, 231, 232, 233, 234, 235, 236, 237, 238, 239; 3 sts after Rows 240, 241, 242, 243, 244, 245, 246, 247, 248, 249, 250, 251; 4 sts. after Rows 252, 253, 254, 255, 256, 257; 29 sts. after Row 258.

ON EACH SIDE, increase 1 st. after Rows 26, 32, 38, 44, 50, 56, 62, 68, 74, 80, 86, 92, 98, 104, 110, 116, 122, 128, 134, 140, 146, 152, 158, 164, 170, 176, 182, 188, 194, 200, 206, then knit to Row 212.

ROWS 0 to 26: Knit even, then transfer the ribber sts. to the main machine and work the Norwegian Design. Cast on 83 sts. with beige and work K1, P1, Ribbing.

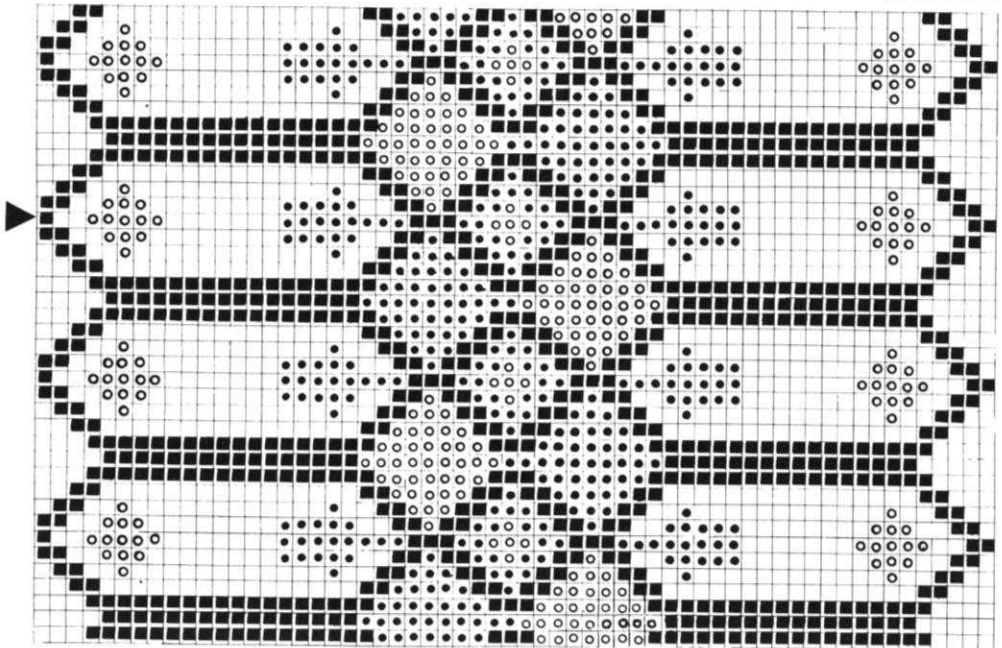

● Gold
○ Green
■ Brown
□ Beige

Move the Cam Box to the left side, turn the Row Counter back to 286 and complete the left half. Follow the instructions from *.

* ON CAM BOX SIDE, bind off 3 sts. after Row 286 (EVEN ROWS = SHOULDER SHAPING); 5 sts. after Row 287 (ODD ROWS = NECK SHAPING); 4 sts. after Row 288; 5 sts. after Row 289; 4 sts. after Rows 290, 291, 292, 293; 7 sts. after Row 294; 3 sts. after Row 295; 7 sts. after Rows 296, 298.

ON CAM BOX SIDE, bind off 3 sts. after Rows 278, 279, 280, 281, 282, 283, 284, 285, then knit to Row 286, bind off the center 15 sts., put the needles on the left side into holding position and complete the right half first.

ON CAM BOX SIDE, bind off 2 sts. after Rows 178, 179, 180, 181, 182, 183, 184, 185, 186, 187, 188, 189, 190, 191, 192, 193, 194, 195, 196, 197, then knit even to Row 278. (on FRONT SECTION knit even to ROW 262.)

ROWS 27 to 178: Knit even.

ROWS 0 to 26: Knit even, then transfer the ribber sts. to the main machine and work the Norwegian Design.

Cast on 193 sts. with beige and work K1, P1, Ribbing.

KG 1912

SLIPPERS — Tweed stitch using every 3rd needle. MATERIAL: 3 balls KNITTING Frigate or Leacril will make two pair. TENSION: 9 or 10 over every 3rd needle. GAUGE: 8 sts. 22 rows 2" measured over pattern.

FINISHING: Sew up the front to end of decreases. Pull up the cast on edge firmly then sew up back seam pulling up the bottom of heel to round it off. Make 1 row of single crochet using a contrast color around top edge going into every other stitch on edge, then 1 row of reverse single crochet. Trim front with Pom-poms, flowers (See KNITTING MAGAZINE March/April 1970, page 32 for flower trim), or any kind of trim you wish.

PATTERN: Tweed stitch. Purl side is the right side. *Put 2nd, then every other needle into holding position, knit 2 rows. Return all needles to working position. Put the 1st, then every other needle into holding position, knit 2 rows. Return all needles to working position. REPEAT from * for pattern. IMPORTANT! When end needle is a holding position needle, be sure to wrap the yarn around it in order to prevent a hole. KNITTING machines use NEEDLE SHIFTER.

SIZE: Small, Medium and Large in (). Make two.

Cast on 25 (27 — 27) sts. Knit in tweed stitch till counter reads 70 (78 — 88).

Decrease 1 stitch on each side, then decrease 1 st. each side every other row till 11 sts. remain (13 — 13). Knit 1 row over all needles and take off the stitches on a double strand of yarn. Pull up and tie tightly.

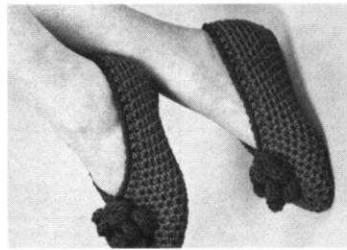

KG 1913

INDIAN HEADBAND — fits head size 20" to 22". If you want larger size, cast on more stitches.

MATERIAL: 1½ oz. (1 ball) each of 3 colors KNITTING Subita Crepe 2 x 4 (will make 5 or more headbands). 3/4 yd 1½" grosgrain ribbon in Color A. TENSION: 4 or 5. GAUGE: 16 sts. 22 rows 2". **PATTERN:** Follow Line Drawing. KNITTING machines use Wheel No. 2. When knitting the pattern, push in the LEFT Retractor Button when Cam Box is on the left side and release it when Cam Box is on the right side.

FINISHING: With the right side of band facing you, slip stitch crochet the open stitches held on waste yarn. This will give you the same edge as the bind off row. Cut waste yarn at each end and pull out. Line the back of Headband with Grosgrain Ribbon, finishing the ends neatly. Make a loop buttonhole for one side (crochet it, or make a cord to fit button) and sew button on other end, or if you prefer make cords for tying, or sew snaps on for closure. To make cords for tying, set machine for knitting a cord. Cast on 3 stitches and knit 150 rows for each cord. Make 8 cords and attach 2 at each corner BEFORE closing each end of lining. Sew a bright bead at the end of each cord. You may use this as a headband or a belt.

Using the open cast-on method, cast on 164 sts. (more for larger size) with waste yarn. After knitting several rows, change to Color A and follow the Line Drawing for 22 rows. Bind off the Crochet method.

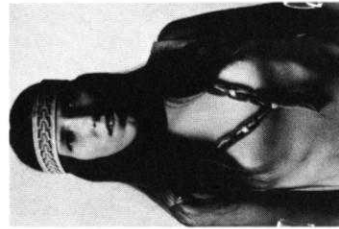

A orange
B turquoise
C red

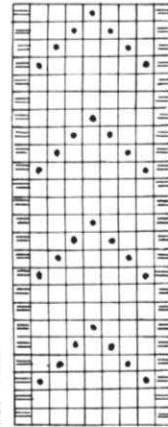

Move the Cam Box to the left side, turn the Row Counter back to 262 and complete the left half. Follow the instructions from *.

* ON CAM BOX SIDE, bind off 4 sts. after Rows 263, 265 (ODD ROWS = NECK SHAPING); 3 sts. after Rows 267, 269; 2 sts. after Rows 271, 273; 1 st. after Rows 275, 277; 3 sts. after Row 278 (EVEN ROWS = SHOULDER SHAPING); 1 st. after Row 279 (last time for Neck); 3 sts. after Rows 280, 282, 284, 286; 4 sts. after Rows 288, 290, 292; 7 sts. after Rows 294, 296, 298.

Work the front section the same as the back section to ROW 262, then bind off the center 15 sts., put the needles on the left side into holding position and complete the right half first.

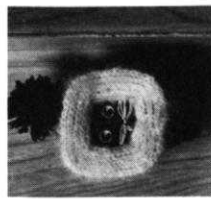
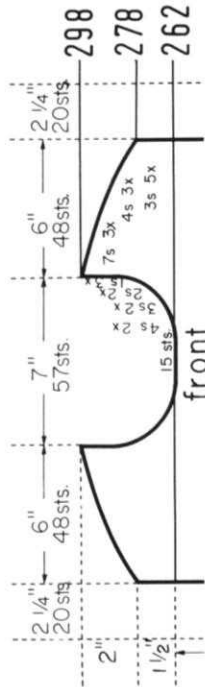

KG 1915

SANTA CLAUS Doorknob Cover

MATERIAL: 1½ oz. (1 ball) Red KNITTING Leacril and 1½ oz. (1 ball) White Rhapsodie (will make 4 or more). TENSION 8 or 9 over every other needle. GAUGE: 10 sts., 13 rows 2".

FINISHING: Weave ends together and remove waste yarn from beard. Single crochet around opening of face section pulling up to fit over door-knob. Brush the Beard then sew in place to frame face with 1½" of red showing at top and bottom. Embroider eyes or use purchased eyes and sew on. Make large french knot for nose with black. Use 6 strands of scrap white yarn (fine) and make mustache. Make red pom-pom for top of hat.

With Red cast on 17 sts. over every other needle. Knit Short Rows.

* Put into holding position 1 needle opposite Cam Box beginning each row until 1 needle remains in work.

Put back into working position 1 needle opposite Cam Box until all are in work.

Knit 2 rows. REPEAT from * to * 1 time. Bind off the crochet method. **BEARD:** Using Open cast-on method, cast on 6 sts. over every other needle. After knitting several rows with waste yarn, change to white Rhapsodie and knit short rows. Cam Box is on the Right.

Put 2 needles opposite Cam Box (left) into holding position and knit 2 rows. Put 1 needle on left into holding position and knit 2 rows. Knit 8 rows. REPEAT from * to * 3 times more, but knit 4 rows at the end instead of 8. Take off on contrast waste yarn.

KG 1914

INDIAN NECKLACE

MATERIAL: 1½ oz. each of 3 colors, Red, Orange, Turquoise KNITTING Subita Crepe 2 x 4. 1 dozen wooden beads 1/2" diameter (make sure the beads have fairly large holes). TENSION 1.

FINISHING: Lay the 4 cords flat along side each other, even at the top and with the two red cords on the outside, and other two colors on the inside. Begin approximately 7" down from the top and make a square knot on each side, the outer cord over first inner cord, the right outer cord over right inner cord to the left, the left outer cord over left inner cord to the right. (If you have a book that shows Macrame, this will help). String a bead on the center two cords together, then 2" down from first knots, make another set of knots, string a bead again and continue in this way until you have approximately 7" of cord left. Thread a small tapestry needle with 1 end at a time and pull through one bead, pulling the cord down so that there is a 2" space from last knot as shown in Photograph. The last cords will be hard to pull through but if you are careful you can do it. Cut the ends evenly and tie off ends.

Set your machine for knitting a cord. KNITTING machines, push in (pull up) right Cam Control Button. Leave a 5" end, then cast on 3 stitches and knit the cords as follows: Make 2 cords in the same color 1250 rows. Make 1 cord in each of the two other colors 900 rows (the empty rows do count). Be sure to leave ends on cords for pulling through a bead.

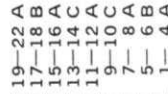



KNITTING NEWS

November/December, 1970

OUR READERS WRITE

Somehow the Post Office manages to lose a number of copies of KNITTING MAGAZINE every issue and we receive indignant letters from readers asking that we take our mailing department to task!!! We thought you would be amused by the following letter from (Mrs.) Betty Tlush of Pennsylvania.

Ye Gods!

Panic in the streets! My KNITTING MAGAZINE Sept/Oct aint in yet! I am horrified - terror stricken! Did I forget to renew... or has some Cad at the Post Office sneaked MY copy "home to the little Woman?" He can have Time or Life or Newsweek, EVEN Good Housekeeping but NOT my KNITTING.. Call the Police, the F.B.I. - the CIA or what have you.... If I owe YOU money (I hope not), I'll ransom the poor thing by return mail - if it is lost - please send out its twin - but please! send me my beloved KNITTING MAGAZINE.... I am bereft.....

Sincerely,

Marla Laine lives in one of the areas here in California where we had terrible fires and when the fire crept close to her home and the Laine family was told to evacuate, she rushed inside to save her precious possessions... and she tells us the first thing she thought of was - her KNITTING machine... We are happy that her home was saved and terribly sorry for the many many people that lost theirs....

CHANGING SIZES

We get letters from readers asking how to adjust certain patterns to their own sizes... We explained in a recent issue how it was possible to make a garment larger or smaller by knitting at a different tension.... It is also possible to make garments larger or smaller by using a yarn different to the one called for in the pattern. We give you two examples to show you how simple this procedure is:

DRESS - DK 7925

The instructions are given for a Size 14/16 using KNITTING Amore. The Tension we recommend is 6 to 8 and it, of course depends on your machine. Our Stitch and Row Gauge is: 15 sts. 2" and 23 rows 2". The finished dress will measure 40" at the bustline when closed. If you use KNITTING Crocus Crepe and Tension 5 to 7, the Stitch and Row Gauge should be 16 sts. 2", 23 rows 2" and the measurement at the bustline of the finished dress will be 38" when closed. If you use KNITTING Subita Crepe 2 x 3 and Tension 4 to 6, the Stitch and Row Gauge should be 17 sts. 2" and 23 rows 2" and the measurement at the bustline of the finished dress when closed will be 36". All the other width measurements will be smaller in proportion. All the length measurements will remain the same because the Row Gauge for all 3 yarns is the same. As sizes between 10 and 16 differ mainly in the width (unless you are a petite size) you can, by using different weights of yarn and changing the tensions, easily change from one size to another.

If the armhole measurement seems a little too long when you change to a smaller size, start the armhole shaping a few rows later.... Also if the measurement from the waistline to the armhole seems too long for you, shorten it by knitting less rows before the armhole shaping begins. You must remember to be sure and set your Row Counter ahead if you deduct rows so that you do not become confused when you begin the armhole shaping.

PANTSUIT - DK 7934

KNITTING Lovely is the yarn used for the easy to knit Pantsuit DK 7934. If you are a petite size 6 or 7, you can knit this in KNITTING Conchita Crylor. Your Stitch and Row Gauge should be 16 sts., 24 rows 2" using Tension 4 or 5.

If you are long legged and the pants need to be made longer, add the extra rows where there is no shaping (between Rows 100 and 156) then put your Counter to Row 156 when you begin the shaping. If the pants need to be made shorter, this is where you will shorten them as well... simply deduct the necessary number of rows, but put your Row Counter to Row 156 before you start the shaping.

OPERATION OF JAC 40

Owners of a JAC 40 will know that most of the punch cards available produces designs 40 stitches wide. There are a few punch cards however that produce patterns of a lesser number. Before using any punch card you should check the number beside the word "Breite" at the top right hand corner of the card. In most cases, it will say 40 and your needles will have to be set in multiples of 40. If it says 38, your needles will have to be set in multiples of 38. It is important that patterns knitted with JAC designs have a balanced look especially when viewed directly from the front or back, but because it is not possible to produce all sizes of garments in exact multiples of 40 stitches, it will not be possible to always match your side seams.

If you read the instructions that came with the JAC 40, you will see that we suggest that needles should be set so that the 0 needle in the middle of your machine is the center of your knitting and that you push your needles forward into the holding position with the JAC by locating the red plastic foot in the center needle groove and then in the 40 needle groove on each side, then in the 80 needle groove on each side. There are however times when the center of your knitting will not be the 0 needle and when this is the case, we tell you and show you at the top of the line drawing by marking it with a black triangle. You will then mark the back rail of your machine with a bright color crayon. You should mark it BEFORE you start knitting the Jac Pattern and BEFORE you insert the pattern card into the JAC, and then mark each 40th needle (or 38th or 36th) on each side of the center needle across the needle bed. You will then place the red plastic foot in the needle grooves of the marked needles.

HOW TO AVOID HOLES WHEN USING THE JAC 40

Sometimes when using the JAC 40, a color will finish in the middle of a row instead of at the end and unless that color is anchored in some way, a hole will show in your finished garment. This is the way you should anchor the yarn and avoid holes.

First set up your pattern for the next row, then take up the loose end of the contrast yarn, lay it over a needle in knitting position (behind the latch) that is closest to a needle in holding position. If your Cam Box is at the right, it should be a needle to the right. If the Cam Box is at the left, it should be a needle to the left.

NORWEGIAN PATTERN KNITTING MADE EASY Using Example DK 7850 (Cover Garment)

To knit a Norwegian Pattern Design, the yarn must be hand fed and several movements of the Cam Box are needed to complete one row. Because of this, your Row Counter will not show the true number of rows knitted. Some knitters automatically re-set the Counter after each row is completed... some knitters use a small coin adder that sells for about \$1.00 in most dime stores, drug stores and Super Markets. It is about 4 inches long and two inches deep and has 3 control buttons. The windows are marked - dollars, dimes and cents and every time you complete one actual row of knitting (irrespective of the number of times you move your Cam Box to do it) you push in the cents button once. This is a very useful tool and can be used to keep track of increases and decreases when shaping as well as for Jac designs.

Here is another way to keep track of Rows when using your JAC 40. We will use DK 7850 (Cover garment) for our example. JAC Pattern No. 418 is a 38 stitch pattern. The center of the Jac Pattern is the 0 needle and so you must mark (on the back rail of your needle bed) needle 38 and 76 on each side. The Design is a repeat of 38 rows. The pattern begins after Row 18 of the dress. Up to Row 66, no shaping takes place. By then you have inserted the Jac Punch card twice, and are on the beginning of Row 11 of your Punch Card. The shapings are made after every 8 rows. On a slip of paper, mark the Jac Card row and right next to it the first decreasing row. Now add 8 to the Jac Card row and 8 to the decreasing row. Continue to do this up to the last decrease row within the Norwegian Design which is at Row 146.

Beginning of JAC Card Row	After actual Row (not row No. on Counter)	decrease
11	66	1 st. each
19	74	side
27	82	etc.
35	90	etc.
5	98	
13	106	
21	114	
29	122	
37	130	
7	138	
15	146	

You now have 3 more rows of the Norwegian design before you begin the stockinette section and so when you have completed Row 18 of your JAC Card, turn your Row Counter to Row 150 and continue knitting with white yarn in stockinette stitch.

Follow the same procedure when you work the Norwegian Design after Row 312 on the Back section and Row 320 on the front section.

As you can see, we ignored the Row Counter by figuring how many Jac Pattern rows to knit and you can use this method for any Norwegian Design using two or more colors. Always remember however, that it is the COMPLETED Jac Pattern row that we count regardless of how many times you must move the Cam Box to complete one row.

KNITKING YARN CATALOGUE

Our beautiful new Yarn Catalogue had really set the hand knitting and machine knitting world on its ear... We know that our fantastic assortment of yarns and colors is the finest of any in the U.S. but it is nice to have the confirmation of our customers... Dozens of letters arrive by every mail praising our Catalogue... We expected the demand to be good, but it far exceeded our expectations... so much so that we sold completely out of our first printing in 6 weeks...!!! More Catalogues were ordered in that time than were sold for the entire previous twelve months.

Our assortment of yarns runs from 100% pure wool crepes that are machine washable to handsome tight twisted Orlons... thick and thin Orlons... handsome Tweeds... dressy Metallics... gorgeous Mohairs... pure hard wearing easy care Acrylics, etc., etc., and all in a range of colors to dazzle you.

Although KNITKING YARN CATALOGUES cost us more than \$3.00 each to produce, we literally give them to our readers free... The \$1.00 token payment we ask is deducted from your first \$10.00 order at our regular low prices.

Even if you do not use KNITKING yarns to make the garments in our magazines and books, the Catalogue is invaluable as a guide for comparison purposes when you buy yarns from your local yarn store.

Frankly, we believe that every reader of KNITKING MAGAZINE needs and should have a KNITKING YARN CATALOGUE... so, if you have not already ordered one, please do so immediately... An order form is included for your convenience on the Contents page of this issue. Just fill in your name and address and send it to us with a one dollar bill. We pay the mailing costs anywhere in the U.S. and Canada.

KNITKING CONVERTA TAPE

If you look at the accessory numbered 7 on the inside front cover of this magazine you will see the KNITKING Converta Tape.... an indispensable tool and yet our most neglected accessory... The Converta Tape is more than twice the size of the illustration and its 5 foot long tape rolls onto a drum.

With a KNITKING Converta Tape you can easily and speedily chart your garments to any body measurements... The Converta Tape has its own stitch gauge measure and after making a sample swatch, you set the gauge on the drum (if you study the illustration you will see that it is set at 14") pull out the tape to the measurement you need and the point on the gauge tells you exactly how many stitches you need...!! You use the same procedure to find out exactly how many rows you need for a garment section.

The KNITKING Converta Tape also tells you exactly how many stitches and rows you need if you are using a different weight yarn or stitch gauge to that called for in a pattern.

The price of this "priceless" tool that never makes a calculating mistake is just \$6.95 (and Sales Tax to residents of California) plus 30¢ mailing costs.

NOTES TO KNIT BY . . .

STITCH AND ROW GAUGE

KNIT A SAMPLE SWATCH . . . before you begin to knit any garment . . . for this is the MOST IMPORTANT STEP toward the correct size and the proper fit of any garment you wish to make. You MUST use the SAME YARN for your sample swatch that you will use to knit your garment and your sample swatch must be knitted large enough and using several different tension numbers on your machine. When you have done this, then you can determine the number of stitches and the number of rows in a two-inch measure. KNITTING MAGAZINE PATTERNS give you 3 tensions to try and one of them should give you the correct stitch and row gauge if you are using the yarn we recommend or a similar weight yarn. Here is the way to make your sample swatch.

Cast on over a sufficient number of needles to produce a swatch at least 4 inches wide. (If the pattern calls for 16 stitches to 2", then $16 \times 2 = 32$ stitches to cast on). Now knit 4 inches of rows at the first suggested tension number. (If the pattern calls for 22 rows to 2", $22 \times 2 = 44$ rows to knit). Knit 2 rows using a contrast color, change to the next higher tension and with garment yarn knit another 4", knit 2 rows with contrast color, change to the 3rd higher tension and knit another 4" and then bind off.



Roll the swatch into a cylinder over its length and pull on both ends, unroll it and stretch it diagonally by pulling on the four corners. Allow the swatch to rest and settle (preferably overnight) and then using a stitch gauge or a ruler, count the number of stitches over a 2" width, then the number of rows over a 2" length in EACH of the 3 tensions. Select the tension number that produces the stitches and rows called for in the pattern. If none of them are correct, you are most likely using the wrong weight of yarn.



READING OF CHARTS

You will notice the instructions start at the bottom of the Chart and work UP. Follow the charts exactly as written and providing your sample stitch and row gauge is correct, your garment will come out the right size. Please remember that the section of garment as it is knitted on the machine, faces the same way as the Charts are in this magazine. Where two front pieces are needed, (or any other part of a garment that needs two sections) only one section is normally shown and the second section is usually made with reverse shapings. Set in sleeves are usually identical, but raglan sleeves have to be knitted with reverse shapings for the second sleeve.

READING OF SYMBOLS

To simplify Pattern Knitting, we use Symbols in the Line Drawings and the Chart Diagrams. In the Line Drawings the symbols are shown and are to be read as you look at them while knitting a garment. For instance, if

a Purl stitch faces you, the Purl stitch Symbol  is shown; if a knit stitch faces you (as when using the Ribber) then this Symbol  is shown. The Symbol  at the top of the Line Drawing is the center of the garment section and you use this as a guide for setting up the needles.

The following Symbols    are used for Eyelet Designs in the Line Drawings and also for Full Fashion shaping on the Charts. The Line Drawings have row numbers on the right side. Missing Row numbers are always knitted straight or plain.

In Holding Position Designs  selected needles are pushed into holding position for the stated number of rows. The numbers of rows appear at the right of the Line Drawings; Example: 1-4 means knit Rows 1 to 4; 5 to 7 means knit Rows 5 to 7, etc. This same Symbol is also shown on the Charts and is used for putting needles into holding position for Short Rows. The

Symbol  on the Charts is used to put needles back into working position when knitting Short Rows.

A number in a box stands for the number of rows to be knitted between shapings. Make shapings first, then knit the necessary number of rows. If for instance it reads:

1 st. 8 x



1 st. 10 x



As you will be reading the instructions from the bottom up, here is the way you will follow them: . . . Decrease or increase (depending on the direction of the garment outline) 1 st. at the row where the shapings begin, then knit 8 rows, make the next decrease, then knit 8 rows, until you have decreased (or increased) 1 st. 10 x and you have knitted 8 rows after each decrease (or increase) (1 st. 10 x + 8 rows 10 x). Now begin the first decrease (or increase) for the shapings (which has to be made 8 x) in every 6th row. Decrease (or increase) 1 st. first, then knit 6 rows until you have decreased 1 st. 6 x and after each decrease (or increase) have knitted 6 rows (1 st. 8 x + 6 rows 8 x).

Where shapings are given without a boxed number as on most armholes, necklines, etc., make the shapings on every second row (on each side of course).

(See below for more Pattern Stitch Symbols.)

PATTERN STITCH SYMBOLS



= knit stitch



= purl stitch



= empty needle (leave in working position)



= needle not used (in the out of work position)



= needle in the holding position



= Needles back into working position.



= 2 stitches on 1 needle — either transferred from the right side or the left side, then put the needle into holding position



= needle holding 2 stitches. Stitch has been transferred from the LEFT



= needle holding 2 stitches. Stitch has been transferred from the RIGHT



= 3 stitches on 1 needle. The 1st and 3rd stitch in a group of 3 needles has been hung on the 2nd or center needle.



= Center of Garment Section.



= Number of rows to be knitted between shapings.

The diagrams (Line Drawings) for pattern work are followed just as they are shown and are to be read as you look at them while knitting the garment.

open darts



closed darts



