

knitking

magazine



V6II
sept/oct '69

Accessories

1. Treble Transfer-Tools. For rapid transfer of stitches and for cable stitch. \$1.50 pair plus 25c shipping.
2. Yarn Winder and Skein Holder. Heavy cast frame and nylon gears. \$15.95 plus \$1.00 shipping.
3. 33 Needle Multi-Transfer Tool. For decreasing in the middle of a row. \$3.25 plus 25c shipping.
4. Adjustable Needle Selector. For setting unevenly spaced pattern stitches. \$3.50 plus 25c shipping.

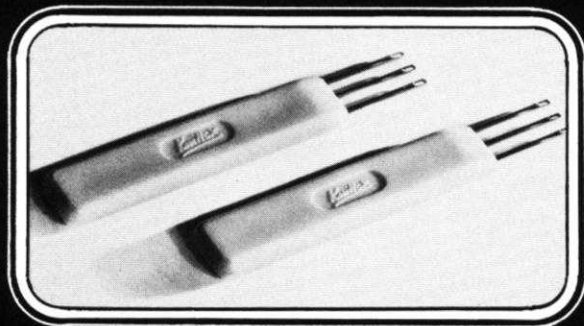

5. Reversing Bar. For easy hem turning or reversing of knitting. \$17.95 plus \$1.50 shipping.
6. Automatic Pattern Selector. For all KNITTING machines prior to Push Button. \$7.95 plus 35c shipping.
7. Converta Tape. For simple and speedy charting of custom knits. \$6.95 plus 30c shipping.

California residents add
5% sales tax.

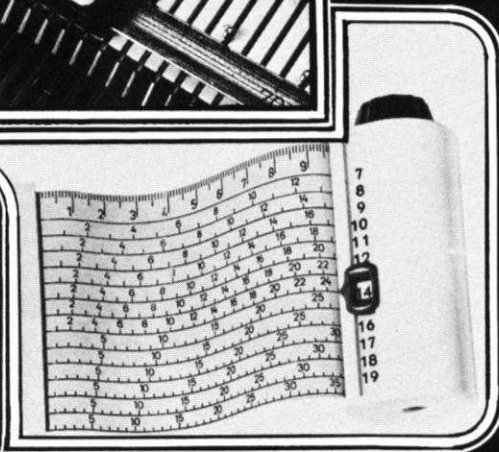
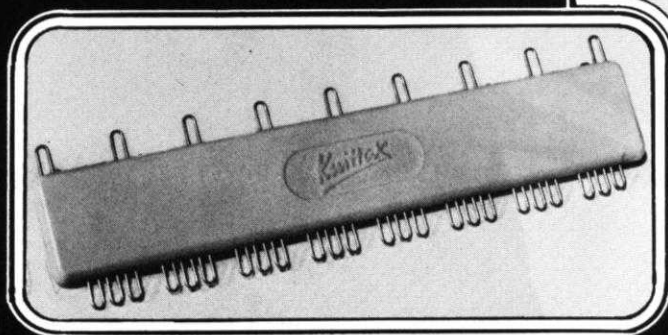
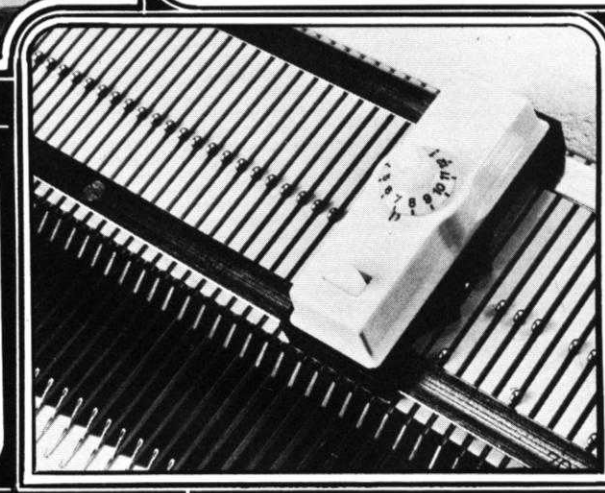
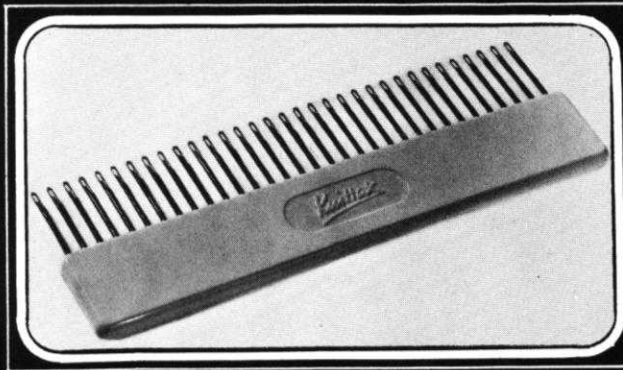
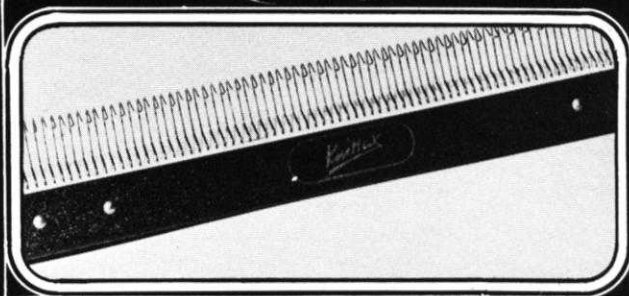
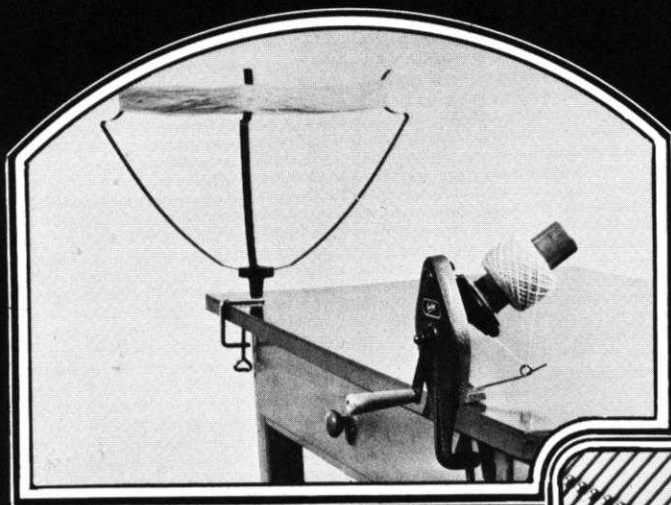

knitking

magazine

The excitement among the staff in our KNITKING offices as this new format magazine gradually took shape, has been quite remarkable . . . as though each individual felt a personal responsibility to every single reader . . . As the publisher of KNITKING MAGAZINE, I am very gratified by the loyalty and enthusiasm displayed by everybody at KNITKING . . . We are all anticipating that you, our readers, will echo our sentiments that this is the most beautiful knitting machine magazine published anywhere in the world . . . the dedication and care that goes into the preparation of each issue of KNITKING MAGAZINE certainly has never reached the peak shown in this truly outstanding issue.

The first thing regular readers will notice is that the magazine has been increased in size . . . It is physically impossible to squeeze all the photos and charts onto the old size page and we were determined to make them large enough for everybody to easily understand . . . You will also notice the new modern lettering in the name "KNITKING MAGAZINE" and that, in response to many reader requests, we have included the date on the front cover.

The most revolutionary change is, of course, in the instruction presentation . . . We have devised an entirely new method of presentation that tells you exactly what to do and when to do it on a row to row basis . . . Written instructions are placed by the side of every chart and you read the instructions from the bottom up . . . Charts are drawn so that each section of your garment, as it is being made, faces the same way as the chart and looks just the same . . . It may seem a little strange at first reading from the bottom up, but each part of each section (i.e., ribbed band, body, armhole, neckline, etc.) has its own paragraph, and if you place a ruler or some other type of straight edge above each paragraph, as you are working on the instructions in that particular paragraph, you will never be confused by reading the wrong paragraph . . . Try a pattern . . . when you have made one garment, the rest will be easy.

You must be sure to read thoroughly "Notes to Knit By" on the inside back cover of this issue . . . Some of the patterns have fancy stitch designs and it is important that you fully understand the symbols appearing in the line-drawings.

Your garments will only be the correct size if you obtain the correct stitch gauge, so always be sure to make a sample swatch exactly as outlined in "Notes to Knit By" . . . we tell you what tensions to use in our instructions, but this is only meant as a guide. Some colors in the identical yarn will knit up tighter than other colors, so always get off on the right foot by insuring that you are knitting at the correct tension.

We are sorry that it is not possible to give instructions for all sizes in each garment . . . To do so would need a publication almost three times the size of this one, but we will soon overcome this problem with the publication of the KNITKING CHARTING COURSE . . . It will tell you exactly how to take any pattern from this or any other publication and chart it to fit your own figure . . .

If there is anything you do not fully understand, drop us a line. The experts at KNITKING, as always, are ready and eager to help . . . Why not drop a line anyway and tell us what you think of the "new" KNITKING MAGAZINE prepared with you in mind.



LETTER
from the
PUBLISHER

Publisher: KNITKING CORPORATION, 1128 Crenshaw Blvd., Los Angeles, Calif. 90019, Telephone: WEbster 8-2079. Published bi-monthly. Subscriptions: USA—\$6.00 annually, single copies \$1.50; Canada—\$7.00; other parts of the world—\$10.00. The entire contents of KNITKING MAGAZINE are copyright and must not be reproduced in any shape or form without the express permission in writing of the publisher. COPYRIGHT © by KNITKING CORPORATION 1969.

Printed by: George Rice & Sons, Los Angeles, California.



DK 7780

Fashion News is KNITKING NEWS . . . and our brand new format for KNITKING MAGAZINE starts off our 6th year of publication. We think it's the greatest . . . most exciting happening for all machine knitters. Beginning with our Cover Model dress, we've filled the pages with all the beautiful garments (for all the beautiful people) we could possibly squeeze in . . . a Special, Special . . .

Wrap yourself in a swinging dress with side front ties. It is knitted in stockinette stitch with bands of contrast color. Size 10/12. See page 12



DK 7787

Ensemble . . . Two complete patterns. The long lean "skinny" Vest is Fashions "great look" of today. Low pockets and Cable stitch down the sides of Vest. Stripe the ribbing on dress with same color as Vest. You'll want more than one of these . . .
Size 10/12. See page 13

TWO FOR ONE



DP 7782

A weaving stitch that follows a chart (or you may use Special Cam Wheel W-2) is used to knit a Pullover with an interesting pattern design. All edges are a 1 x 1 Rib. See page 20

WEAVE ALONG



DK 7785

Jumpers make the scene for Fall and Winter fashions . . . so do knit this one that buttons down the front, has high pockets and a new rounded hemline. Size 8/10. See page 26

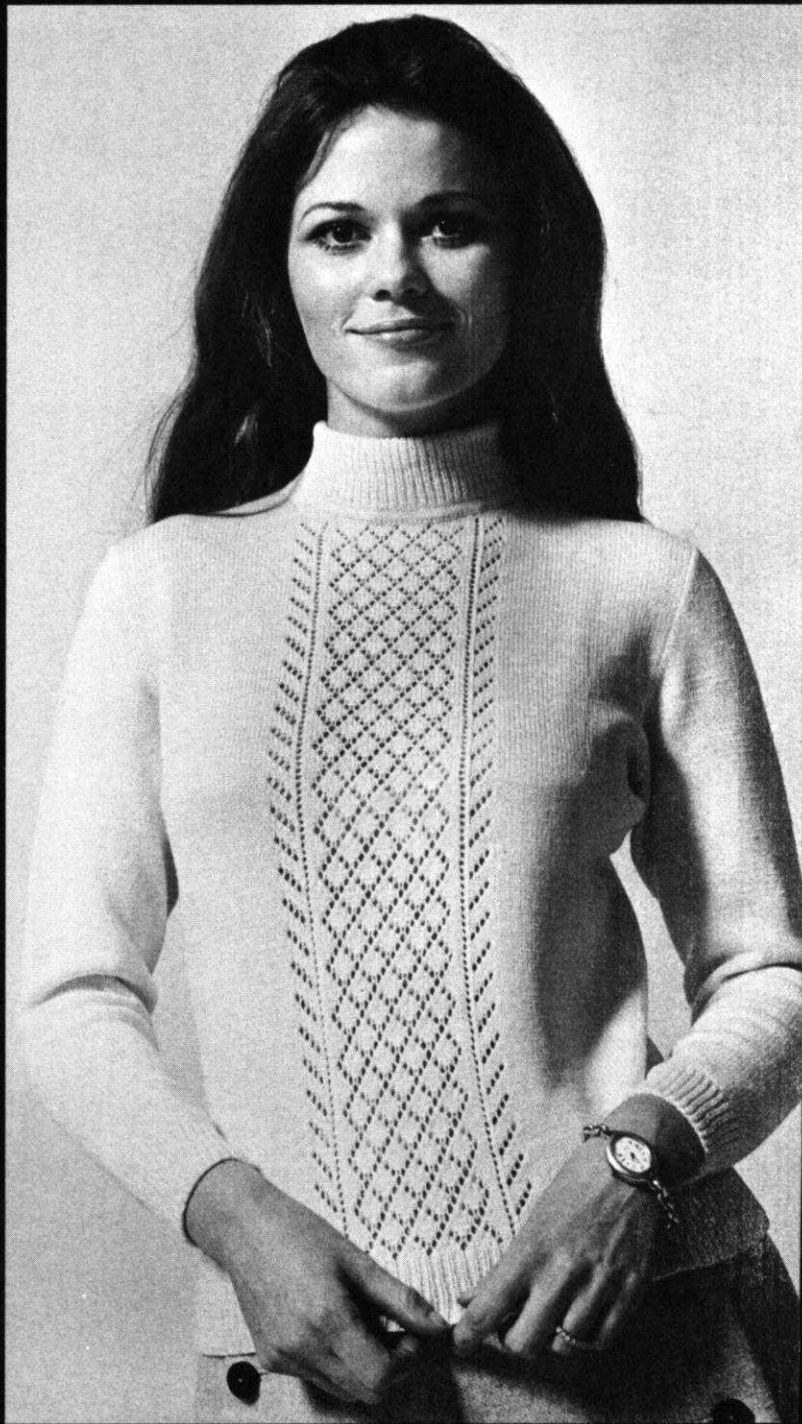

DP 7786

A high necked Pullover is knitted in Stockinette Stitch with a beautiful Eyelet Design down the front section. The high Neckband, lower edge and sleeve edges are in a 1 x 1 Rib. Wear it under Jumper DK 7785. Size 10/12. See page 18



DK 7783 DP 7784

Fashion Scoop! Mix or match colors for a complete wardrobe of knits . . . Skirt, Vest and turtleneck Pullover have Cable Stripes on front sections. Skirt and Vest are knitted with Subita 2 x 4 and the Pullover with Subita 2 x 3. Size 8/10. See page 16 and 21



DK 7770

Match Mates! Coat and Beret (wear them with Dress DK 7771) follow the "NOW" style of the long lean look. The pretty Cables down the front sections and sleeves are not difficult, and worth every minute of the extra time involved. Size 14/16. See page 17



DK 7771

A Smashing Success! You can't be without this lovely dress that softly skims the body. The attractive Cable down the front is the same as the one used for Coat DK 7770.

Size 14/16. See page 19



DP 7788

A very new style Blouse knitted in stockinette stitch has a flattering cross-over neckline. The snug fitting waist (elastic through hem does the trick) ties at side front.

Size 12/14 See page 15



HP 3590

Let him swagger around proudly wearing a Cardigan you knitted just for him. Superb tailoring and handy pockets will make this one his favorite. Size 40/42. See page 24

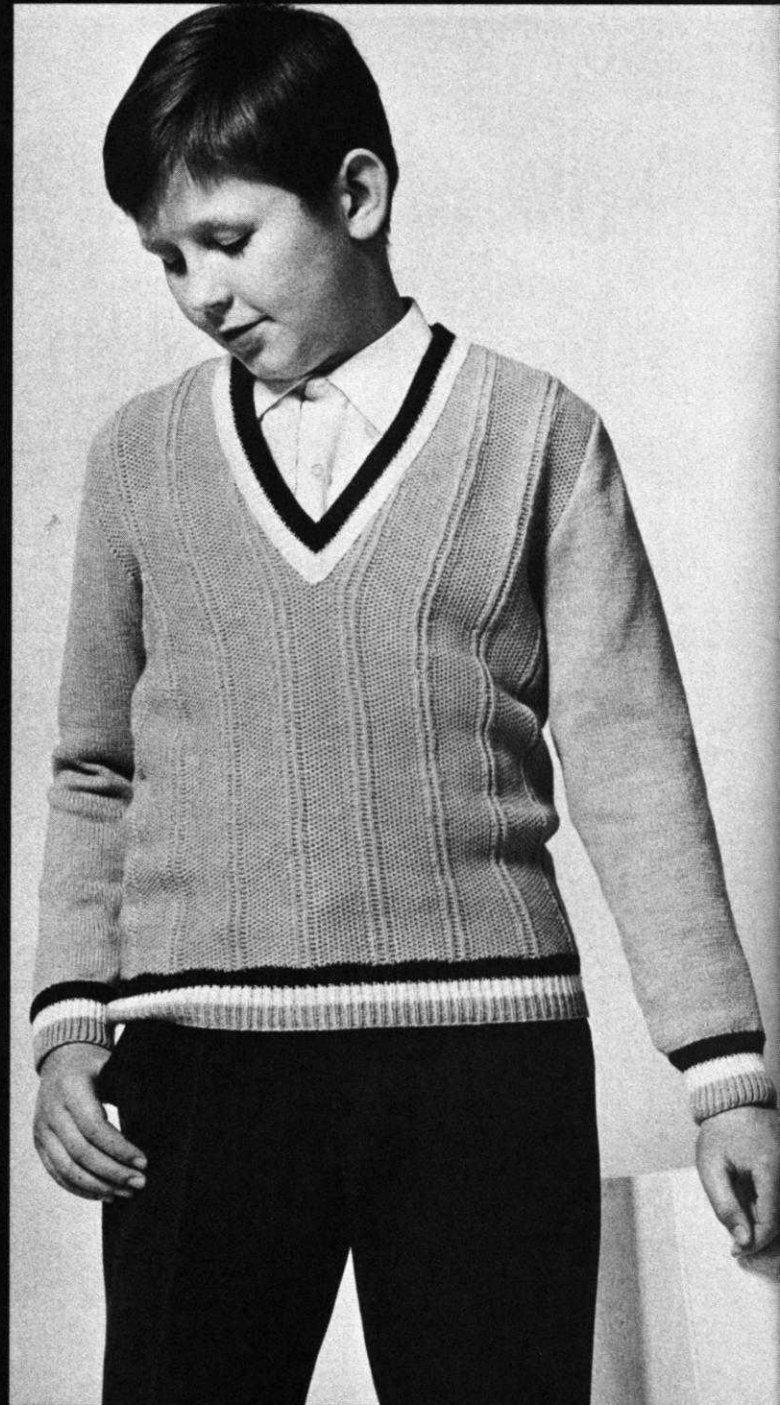

KK 5097

School Daze . . . Knit a young man this V-necked Pullover in 3 colors. The front and back sections are knitted in a pattern stitch and striped ribbing is used for the bands. Size 13-14. See page 29



KK 5082

Knit a Vest for a young boy that is styled exactly to his taste. It is knitted in Stockinette Stitch with Ribbed edges, has a Pocket and a front zippered closure.

Size 9–10. See page 22

HP 3581

A unique double breasted Vest for a Man is knitted in a Holding Position Design that follows a Chart. The Purl side is the right side.

Size 38/40. See page 28

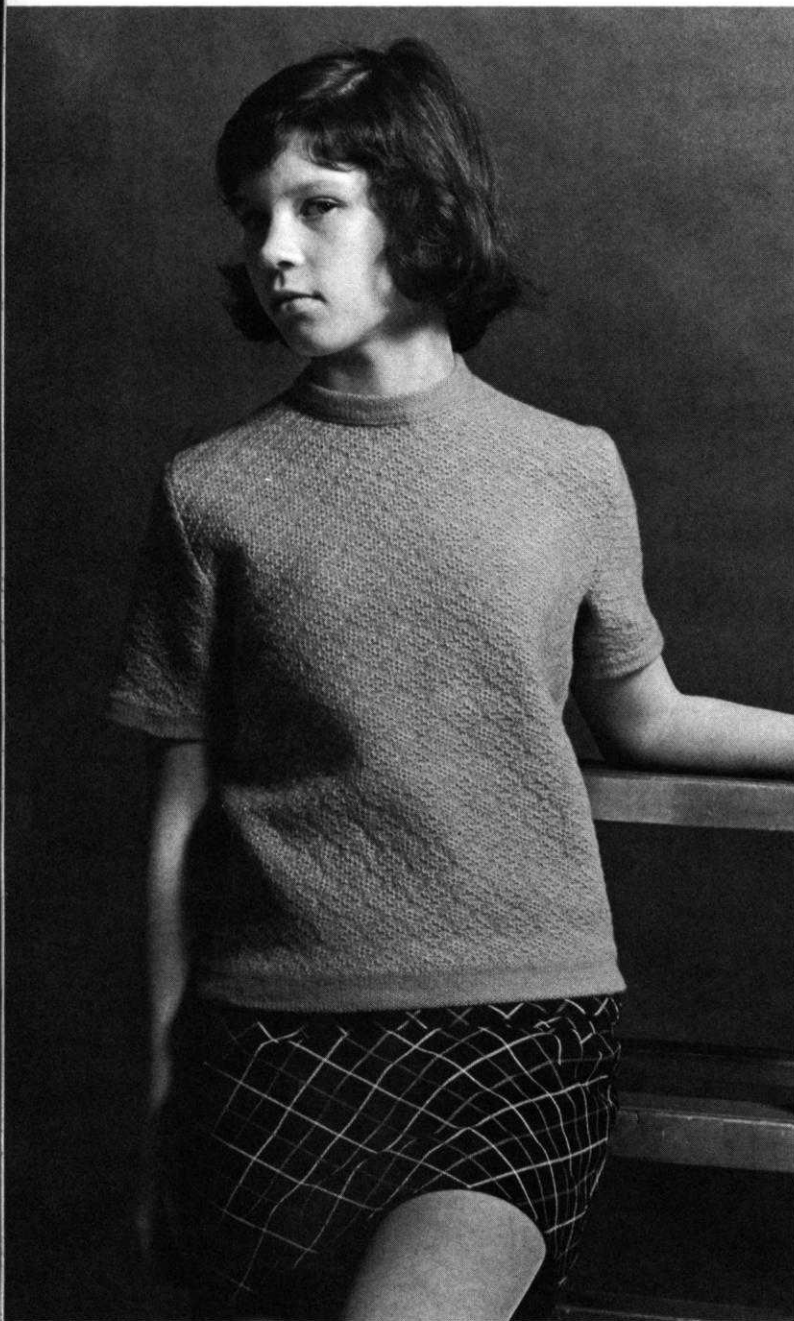

MK 5090

Jacquard Designs are beautiful and fun to knit as well . . . and here is your chance to use your JAC 40 (or you may follow the Chart) for an exquisite Pullover for a young girl. JAC 40 Pattern Card No. 53. Size 12-13. See page 30



MK 5084

A pretty Pullover for a pretty little girl is knitted in a simple to make Eyelet Design. Our Model is knitted in turquoise, the Collar and Neck opening white Subita Crepe 2 x 3. Size 7-8. See page 24

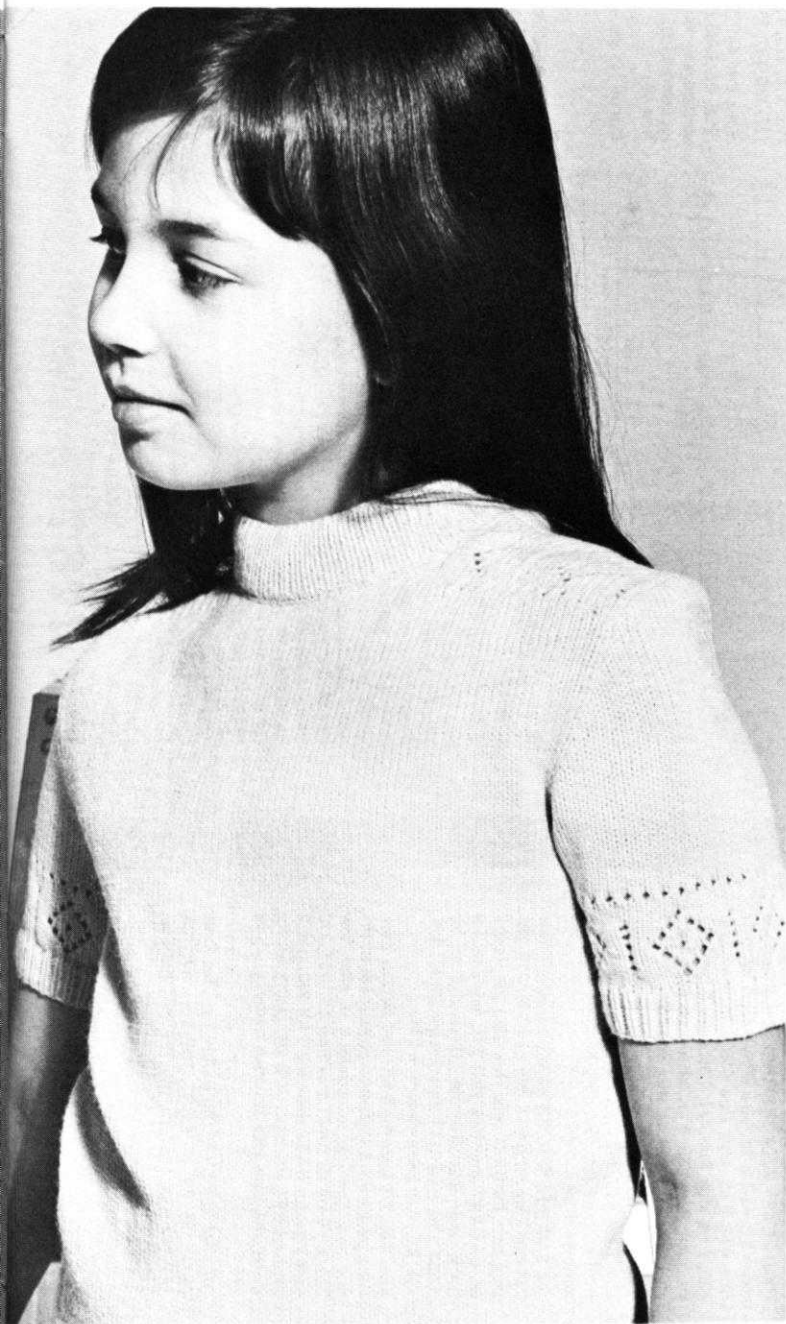

MK 5092

Subita Dralon 3-ply (the no-care yarn) is knitted into a dressy Pullover for a young lady. Stockinette Stitch with an Eyelet Design on the front Shoulders and Sleeves.

Size 10-11. See page 23

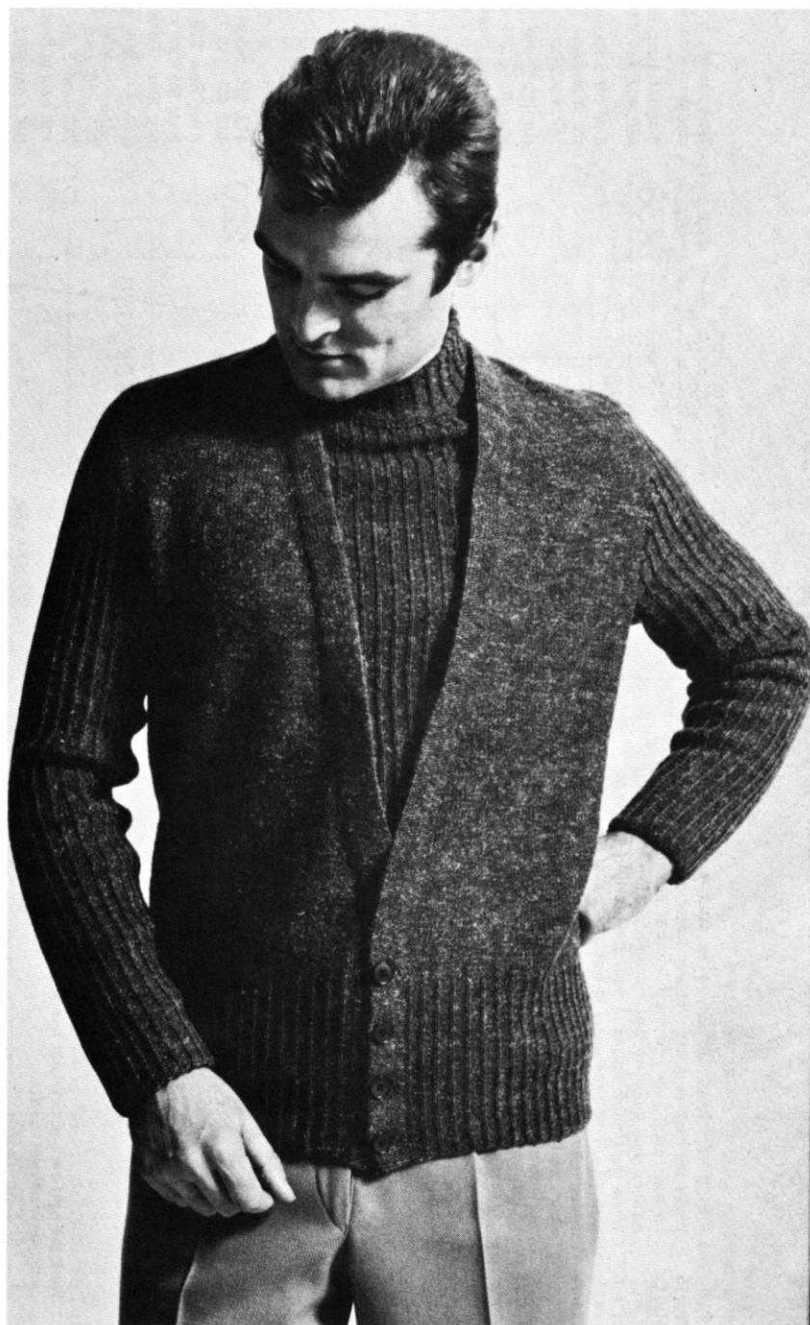

HP 3588

Double Bonus! A combination of Stockinette Stitch with a Ribbed Pattern is used for a Mans Pullover and Jacket. The Sleeves on the Pullover are in Stockinette Stitch, and the rest is a Ribbed Pattern. Reverse the procedure for the Jacket, with Sleeves and lower edge in Ribbed Pattern and the rest in Stockinette Stitch. Size 38/40. See page 27

DK 7780

SIZE: 10/12. MATERIAL: 22½ oz. (13 balls) red and 3½ oz. (2 balls) white KNITTING Subita Crepe 2 x 4, Color No. 15 and No. 4. TENSION: KNITTING 6 to 8. STITCH GAUGE: 16 sts. 2", 22 rows 2". PATTERN: Stockinette Stitch. ALL SHAPINGS for Side Seams, Back Seam, Front edge and Sleeve Seams are to be made full-fashioned. For ALL Decreases on the Front Edge, always hang the 4th st. onto the 3rd st., then move the end st. inward to fill the empty needle. For all decreases on Side and Back seam, always hang the 3rd st. onto the 2nd st., then move the end st. inward to fill the empty needle. The DARTS begin after Row 220. After hanging the sts. for the DART decreases together, move the end st. inward to fill the empty needles. All subsequent DART decreases, then increases lie directly above the first. Make the Increases for the side, back and sleeve seams by moving the 2nd end sts. 1 needle outward, then place the 3rd st. from the row below onto the empty needle. (ALWAYS ON EACH SIDE for the SLEEVES).

FINISHING: Block all sections to measurements given. Weave the back seam, then the side seams together, 1 st. in on each edge, easing in the fullness at bustline of front sections. Join shoulders. Weave sleeves together, then set in. Weave front and neckband to front and neckline, 1 st. in on each edge. Fold band under in half and sew to wrong side against seam. Fold collar in half and sew side edges, then attach to inside of neckline band. Fold bow band in half lengthwise and sew all edges together. Tie into bow, then sew bow onto right front section. Close with a large snap. Turn under 18 rows on lower edge and 9 rows on sleeve edges and hem to wrong side.

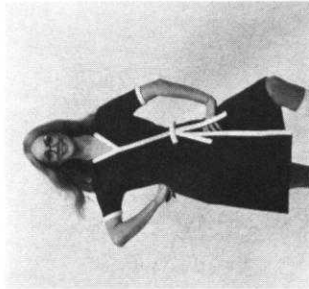

Work the right back section with reverse shapings, casting on from right to left.

Bind off 4 sts. after Row 428 (EVEN ROWS = SHOULDER SHAPING) 10 sts. after Row 429 (ODD ROWS = NECK SHAPING) 4 sts. after Rows 430, 431, 432; 3 sts. after Row 433; 4 sts. after Row 434; 3 sts. after Row 435; 4 sts. after Row 436; 2 sts. after Row 437; 4 sts. after Row 438; 2 sts. after Row 439; 4 sts. after Row 440; 2 sts. after Row 441; and 4 sts. after Row 442.

Bind off 5 sts. for Armhole after Row 344; 3 sts. after Rows 346, 348; 2 sts. after Rows 350, 352; 1 st. after Rows 354, 356, 358, 360, then knit even to Row 428.

ON CAM BOX SIDE INCREASE 1 st. after Rows 274 (and 2 sts. for DART after Row 274) 275, 284 (and 2 sts. for DART after Row 284) 294, (and 2 sts. for DART after Row 294) 304, (and 2 sts. for DART after Row 304) 305, 314 (and 2 sts. for DART after Row 314 - last time for DART) 324, 334, 335, then knit even to Row 344.

After Row 220 begin the DART and decrease 2 sts. Hang the 43rd and 45th sts. onto the 44th st. the first time. Continue to decrease 1 st. after Row 230 (and 2 sts. for DART after Row 230) 237, 240 (and 2 sts. for DART after Row 240) 250, (and 2 sts. for DART after Row 250) 260 (and 2 sts. for DART after Row 260) 261, then knit even to Row 274.

ON CAM BOX SIDE, DECREASE 1 st. after Rows 44, 45, 58, 69, 72, 86, 93, 100, 114, 117, 128, 141, 142, 156, 165, 170, 180, 189, 190, 200, 210, 213, 220.

Rows 0 to 44 knit even.

Cast on 96 sts. and work stockinette st.

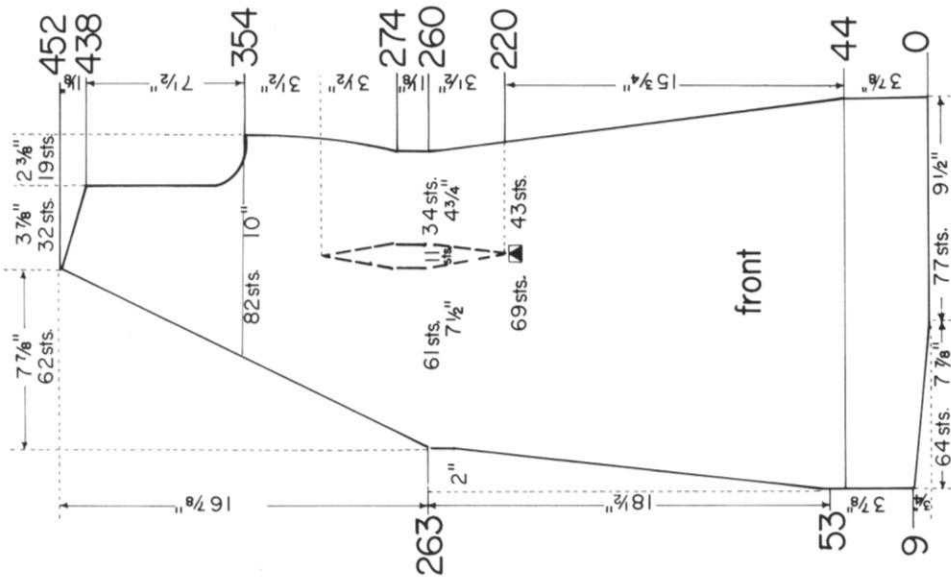

Work the left front section with reverse shapings, casting on from right to left.

Bind off 4 sts. for SHOULDER after Rows 438, 440, 442, 444, 446, 448, 450, 452.

Bind off 5 sts. for ARMHOLE after Row 354; 3 sts. after Rows 356, 358; 2 sts. after Rows 360, 362; 1 st. after Rows 364, 366, 368, 370.

INCREASE 1 st. for side seam and 2 sts. for DART after Rows 274, 284, 294, 304, 314 (dart is now completed). Increase 1 st. for side after Rows 324, 334.

Full-fashion decrease on LEFT SIDE (NOTE: ABOVE INSTRUCTIONS FOR SIDE SEAMS, DARTS, ARMHOLE and SHOULDER SHAPING take place AT THE SAME TIME) 1 st. after Rows 263, 266, 269, 272, 275, 278, 281, 284, 287, 290, 293, 296, 299, 302, 205, 308, 311, 314, 317, 320, 323, 326, 329, 332, 335, 338, 341, 344, 347, 350, 353, 356, 359, 362, 365, 368, 371, 374, 377, 380, 383, 386, 389, 392, 395, 398, 401, 404, 407, 410, 413, 416, 419, 422, 425, 428, 431, 434, 437, 440, 443, 446.

After Row 220 begin DART and decrease 2 sts. Hang the 43rd and 45th sts. onto the 44th st. the first time. Continue to decrease 1 st. after Rows 225, 230 (and 2 sts. for DART after Row 230) 237, 240 (and 2 sts. for DART after Row 240) 249, 250, (and 2 sts. for DART after Row 250) 260 (and 2 sts. for DART after Row 260) then knit even to Row 263.

ON CAM BOX SIDE Full-fashion decrease 1 st. after Rows 44, 53, 58, 67, 72, 81, 86, 95, 100, 109, 114, 123, 128, 137, 142, 151, 156, 165, 170, 177, 180, 189, 190, 200, 201, 210, 213, 220.

Rows 0 to 44: (Knit Short Rows) ON OPPOSITE SIDE OF CAM BOX, put 64 needles into holding position and knit 2 rows. Bring 16 needles back into work after Rows 2, 4, 6, 8, then knit even to Row 44.

Cast on 141 sts., work stockinette st.

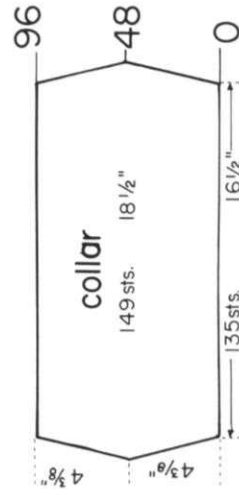

ON EACH SIDE Full-fashion decrease (3rd st. onto 2nd st.) 1 st. after Rows 54, 60, 66, 72, 78, 84, 90, then knit even to Row 96. Bind off all sts.

ON EACH SIDE Full-fashion increase (between 2nd-3rd st.) 1 st. after Rows 6, 12, 18, 24, 30, 36, 42, then knit even to Row 54 (Row 48 = CENTER)

Rows 0 to 6 knit even.

Cast on 135 sts. with red and work stockinette st.

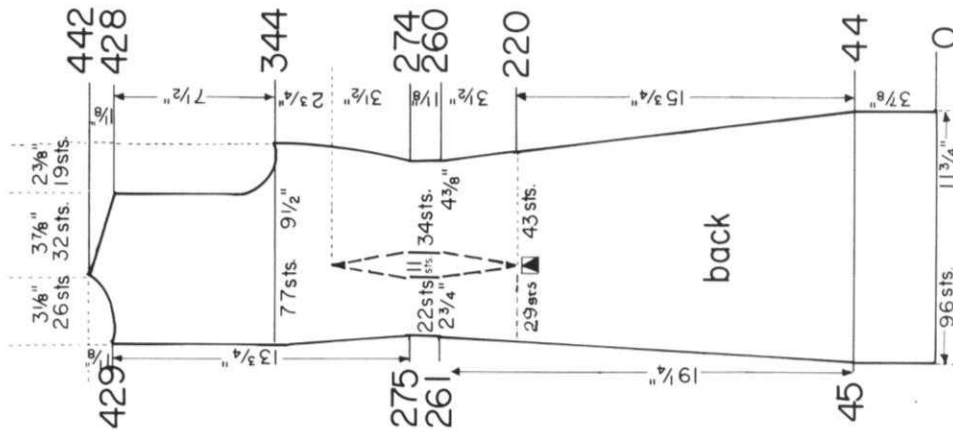

Bind off 4 sts. on CAM BOX SIDE after Rows 58, 59, 60, 61; 3 sts. after Rows 62, 63, 64, 65; 2 sts. after Rows 66, 67, 68, 69, 70, 71; ON EACH SIDE, bind off 1 st. after Rows 72, 74, 76, 78, 80, 82, 84, 86, 88, 90, 92, 94, 96, 98, 100, 102, 104. Bind off 2 sts. on CAM BOX SIDE after Rows 106, 107, 108, 109; 3 sts. after Row 110, 111; 4 sts. after Rows 112, 113; 13 sts. after Row 114.

ON EACH SIDE, Full-fashion increase 1 st. (between 2nd-3rd sts.) after Rows 18, 24, 30, 36, 42, 48, 54, then knit even to Row 58.

Rows 0 to 18, knit even then change to red.

Cast on 95 sts. with white and work stockinette st.

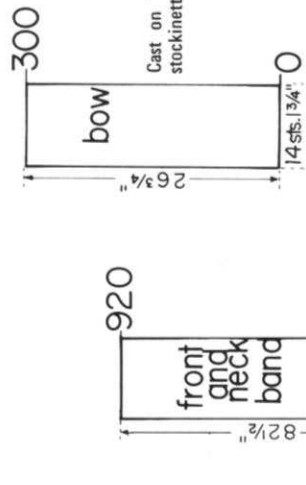
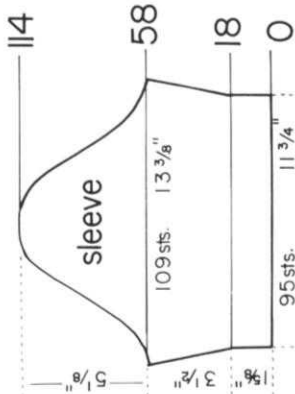

Cast on 14 sts. with white and knit 920 rows stockinette st., then bind off.

Cast on 14 sts. with white and knit 300 rows stockinette st. then bind off.

SIZE: 10/12. **MATERIAL:** DRESS 19 1/2 oz. (11 balls) white, VEST 14 oz. (8 balls) blue KNITTING Subita Crepe 2 x 3, Color No. 104 and 137. **TENSION:** KNITTING 3 to 5. **STITCH GAUGE:** 18 sts. 2", 26 rows 2". **PATTERN:** Stockinette Stitch with Cable Stripes on front sections of VEST and Dress SLEEVES. Sleeve EDGES, Dress NECK-BAND, upper edges of POCKETS and VEST BANDS: K1, P1, Ribbing. The skirt of the dress is knitted in 4 identical sections. Make full-fashion decreases by always hanging the 4th st. ON EACH SIDE onto the 3rd st., then move the end sts. inward to fill the empty needle. Make full-fashion increases for the side seams of the dress BODICE by always moving the 2 end sts. ON EACH SIDE 1 needle outward, then place the 3rd st. from the row below onto the empty needle. Make increases for sleeves in the same manner. Before beginning the increases on the sleeves, mark the needles over which the cable stripes will be worked. After hanging the sts. together for full-fashion decreases on front sections of vest, move the end sts. inward to fill the empty needles.

FINISHING: Block all sections to measurements given.

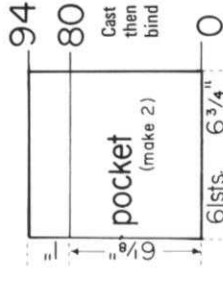
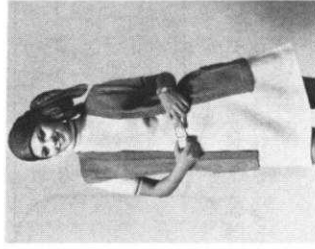

Cast on 61 sts. and work 80 rows stockinette st. then change to K1, P1, Ribbing, knit 14 rows and bind off all sts. the crochet method for ribbing.



Cast on 180 sts. with white and work K1, P1, Ribbing, 6 rows white, 6 rows blue and 48 rows white, then bind off all sts. the crochet method for ribbing.

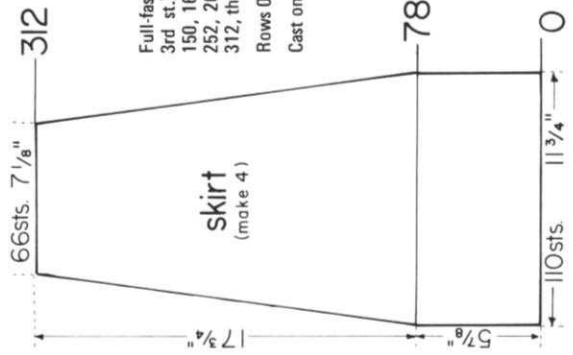

Full-fashion decrease ON EACH SIDE (4th st. onto 3rd st.) after Rows 78, 90, 102, 114, 126, 138, 150, 162, 172, 182, 192, 202, 212, 222, 232, 243, 252, 262, 272, 282, 292, 302. Knit even to Row 312, then bind off all 66 sts.

Rows 0 to 78 knit even.

Cast on 110 sts. and work stockinette st.

Bind off 6 sts. on CAM BOX SIDE after Rows 66, 67; 5 sts. after Rows 68, 69; 3 sts. after Rows 70, 71, 2 sts. after Rows 72, 73, 74, 75. ON EACH SIDE, bind off 1 st. after Rows 76, 78, 80, 82, 84, 86, 88, 90, 92, 94, 96, 98, 100, 102, 104, 106, 108, 110, 112, 114, 116, 118, 120, 122. Bind off 2 sts. ON CAM BOX SIDE after Rows 124, 125, 126, 127; 3 sts. after Rows 128, 129; 4 sts. after Rows 130, 131; 5 sts. after Rows 132, 133; 10 sts. after Row 134.

ON EACH SIDE full-fashion increase, 1 st. after Rows 24, 30. After Row 34, cross the Cable sts. for the first time (10 center sts.) then again every following 20th row and continue to increase 1 st. ON EACH SIDE after Rows 36, 42, 48, 54, 60, then knit even to Row 66.

Rows 0-24: knit 6 rows white, 6 rows blue and 12 rows white, then change to stockinette st., continue with white.

Cast on 112 sts. with white and work K1, P1, Ribbing.

Cast on 197 sts. and work 14 rows K1, P1, Ribbing, then bind off all sts. the crochet method for ribbing.

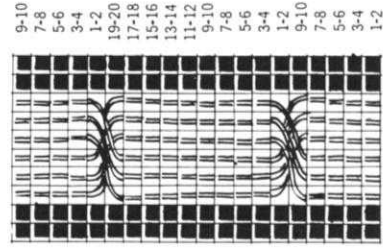

Cast on 119 sts. and work 14 rows K1, P1, Ribbing, then bind off all sts. the crochet method for ribbing.

Move CAM BOX to the LEFT side, turn Row Counter back to 178 and complete the left half. Follow instructions from *.

Bind off 4 sts. after Rows 204, 206, 208, 210, 212 (EVEN ROWS = SHOULDER SHAPING); 5 sts. after Rows 214, 216, 218, 220.

After Row 178 put 65 sts. on the LEFT side into holding position and complete the right half. *Bind off 9 sts. after Row 179 (ODD ROWS = NECK SHAPING); 3 sts. after Rows 181, 183; 2 sts. after Rows 185, 187; 1 st. after Rows 189, 191, 193, 195, 199, 203 (last time for neck).

Bind off 6 sts. on CAM BOX SIDE after Rows 110, 111; 5 sts. after Rows 112, 113; 3 sts. after Rows 114, 115; 2 sts. after Rows 116, 117, 118, 119; 1 st. after Rows 120, 121, 122, 123, then knit even to Row 178.

Increase 1st ON EACH SIDE after Row 16 and 2 sts. for each DART after Rows 16, 24; 1 st. ON EACH SIDE after Row 30 and 2 sts. for each DART after Rows 32, 40; 1 st. ON EACH SIDE after Row 44 and 2 sts. each DART after Rows 48, 56 (last time for darts); 1 st. ON EACH SIDE after Row 58, 72, 86 then knit even to Row 110.

Rows 0 to 8 knit even, then increase 2 sts. ON EACH SIDE between the 36th-37th-38th sts. for the DARTS. The next DART increases lie directly above.

Cast on 130 sts.

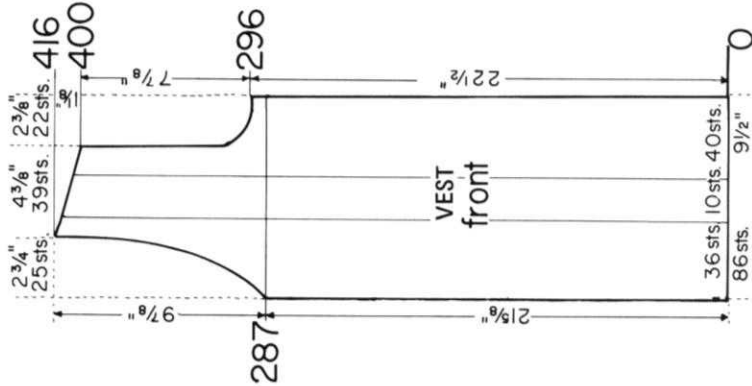
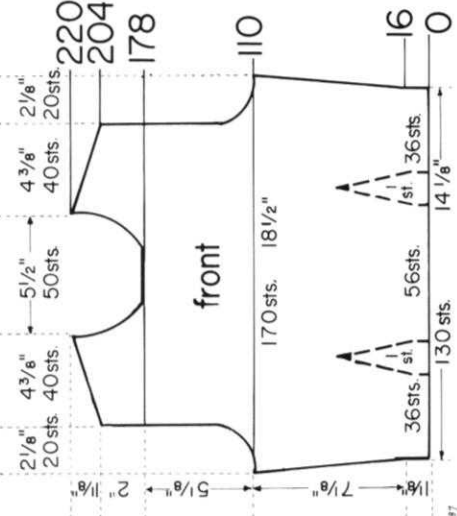

Work the left front section with reverse shapings, casting on from right to left.

Bind off (or decrease) 4 sts. after Rows 400, 402, (EVEN ROWS = SHOULDER SHAPING) 1 st. after Row 403; 4 sts. after Rows 404, 406, 408; 1 st. after Row 409 (last time for front shaping); 4 sts. after Row 410; 5 sts. after Rows 412, 414, 416.

Bind off (or decrease) 5 sts. after Row 296 (EVEN ROWS = ARMHOLE SHAPING); 4 sts. after Row 298; 1 st. after Row 299; 4 sts. after Row 300; 2 sts. after Row 302; 1 st. after Row 303; 2 sts. after Rows 304, 306; 1 st. after Rows 307, 308, 310, 311, 312 (last time for Armhole) 1 st. after Rows 315, 319, 323, 327, 331, 337, 343, 349, 355, 361, 367, 373, 379, 385, 391, 397.

Full-fashion decrease (3rd st. onto 2nd st.) 1 st on CAM BOX SIDE after Rows 287, 291, 295 (ODD ROWS = FRONT SHAPING)

Cast on 86 sts., work stockinette stitch and the Cable stripe over the sts. indicated on the diagram. Cross the sts. the first time after Row 10, then again after every following 20th row. Knit even to Row 287.

Move the Cam Box to the left side, turn Row Counter back to 194 and complete the left half. Follow instructions from *.

After Row 194, put 65 sts. on the left side into holding position and complete the right half. *Bind off 4 sts. after Row 194 (EVEN ROWS = SHOULDER SHAPING) 9 sts. after Row 195 (ODD ROWS = NECK SHAPING) 4 sts. after Rows 196, 197, 198; 3 sts. after Row 199; 4 sts. after Row 200; 3 sts. after Row 201; 4 sts. after Row 202; 2 sts. after Row 203; 5 sts. after Row 204; 2 sts. after Row 205; 5 sts. after Row 206; 2 sts. after Row 207; 5 sts. after Rows 208, 210.

Bind off 6 sts. on CAM BOX SIDE after Rows 100, 101; 5 sts. after Rows 102, 103; 3 sts. after Rows 104, 105; 2 sts. after Rows 106, 107, 108, 109; 1 st. after Rows 110, 111, 112, 113, then knit even to Row 194.

Increase 1 st. ON EACH SIDE after Row 16 and 2 sts. for each DART after Rows 16, 24; 1 st. ON EACH SIDE after Row 30 and 2 sts. for each DART after Rows 32, 40; 1 st. ON EACH SIDE after Row 44 and 2 sts. for each DART after Rows 48, 56 (last time for darts), 1 st. ON EACH SIDE after Rows 58, 72, 86, then knit even to Row 100.

Rows 0 to 8 knit even, then increase 2 sts. ON EACH SIDE between the 36th-37th-38th sts. for the DARTS. The next DART increases lie directly above.

Cast on 130 sts.

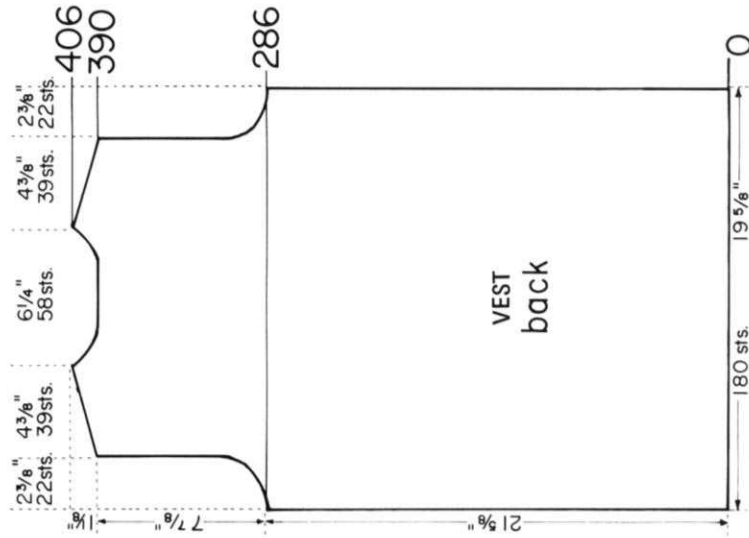
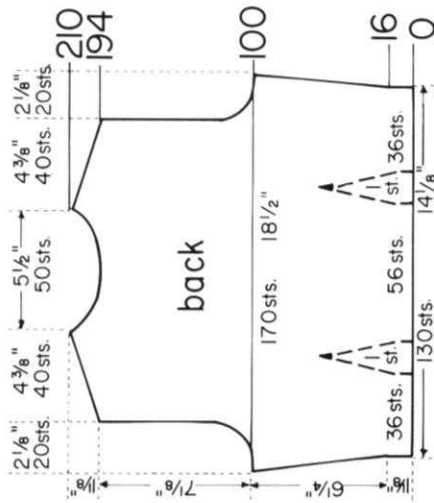

Move the CAM BOX to the left side, turn Row Counter back to 390 and complete the left half. Follow instructions from *.

After Row 390 put 68 sts. on the LEFT side into holding position and complete the right half. *Bind off 4 sts. after Row 390 (EVEN ROWS = SHOULDER SHAPING); 9 sts. after Row 391 (ODD ROWS = NECK SHAPING); 4 sts. after Row 392; 5 sts. after Row 393; 4 sts. after Row 394; 5 sts. after Row 395; 4 sts. after Row 396; 3 sts. after Row 397; 4 sts. after Row 398; 3 sts. after Row 399; 4 sts. after Row 400; 2 sts. after Row 401; 5 sts. after Row 402; 2 sts. after Row 403 (last time for neck); 5 sts. after Rows 404, 406.

Bind off 5 sts. on CAM BOX SIDE after Rows 286, 287; 4 sts. after Rows 288, 289, 290, 291; 2 sts. after Rows 292, 293, 294, 295, 296, 297; 1 st. after Rows 298, 299, 300, 301, 302, 303, then knit even to Row 390.

Rows 0 to 286, knit even.

Cast on 180 sts. and work stockinette st.

DP 7788

SIZE: 12/14. **MATERIAL:** 7 oz. (4 balls) KNITTING Subita Dralon 2-ply, Color No. 425. **TENSION:** Knit 1 to 2. **STITCH GAUGE:** 19 sts. 2", 27 rows 2". **PATTERN:** Stockinette Stitch. Make the first increase of 2 sts. for EACH DART over the sts. indicated, then the following increases lie directly above. Make full-fashion increases for the side seams and sleeve seams. After rows indicated, move the 2 end sts. (ON EACH SIDE for sleeves and back section, on side seam for front below) 1 needle out, then place the 3rd st. from the row below onto the empty needle. After hanging the sts. for Front Shaping together, always move the end sts. inward to fill the empty needle.

FINISHING: Block all sections to measurements given. Join front and back sections at sides and shoulders, easing in the fullness at bustline of front sections. Weave sleeves together and set in. Turn under 16 rows on lower edge and sleeve edges and hem to wrong side. Insert an elastic band into lower hem. Weave open sts. of facing together, then sew facing to neckline. Turn under 12 sts. around fronts and neckline and hem to wrong side. Fold bow band in half lengthwise and sew edges together, then tie into bow. Sew bow to right front section. Close with 2 large snaps.

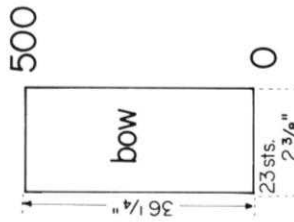
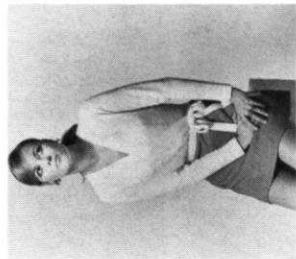

BOW

Cast on 23 sts. and work 500 rows stockinette st., then bind off.

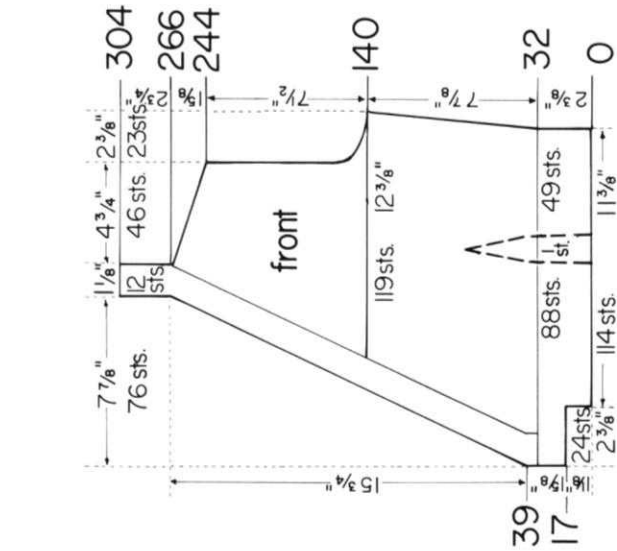

Move the Cam Box to the left side, turn Row Counter back to 250 and complete the left half. Follow the instructions from *.

*Bind off 4 sts. after Row 250 (EVEN ROWS = SHOULDER) 12 sts. after Row 251 (ODD ROWS = NECK); 4 sts. after Row 252; 8 sts. after Row 253; 4 sts. after Row 254; 6 sts. after Row 255; 4 sts. after Row 256.

Bind off 3 sts. on CAM BOX SIDE after Rows 234, 235, 236, 237; 4 sts. after Rows 238, 239, 240, 241, 242, 243, 244, 245, 246, 247, 248, 249. After Row 250 put 42 sts. on the left side into holding position and complete the right half.

Bind off 5 sts. on CAM BOX SIDE after Rows 130, 131; 4 sts. after Rows 132, 133; 3 sts. after Rows 134, 135, 136, 137; 2 sts. after Rows 138, 139, 140, 141; 1 st. after Rows 142, 143, 144, 145, 146, 147, 148, 149, then knit even to Row 234.

ON EACH SIDE after Row 32, increase 2 sts. for the DARTS (between 49th-50th-51st sts.) and 1 st. for the sides. Continue to increase on EACH SIDE, 2 sts. for the DARTS after Row 42, 1 st. for the sides after Row 44, 2 sts. for the DARTS after Row 52, 1 st. for the sides after Row 56, 2 sts. for the DARTS after Row 62, 1 st. for the sides after Row 68, 2 sts. for the DARTS after Rows 72 and 82 (last time for DARTS) 1 st. for the sides after Rows 82, 96, 110, then knit even to Row 130.

Rows 0 to 32 knit even.

Cast on 152 sts. and work stockinette st.

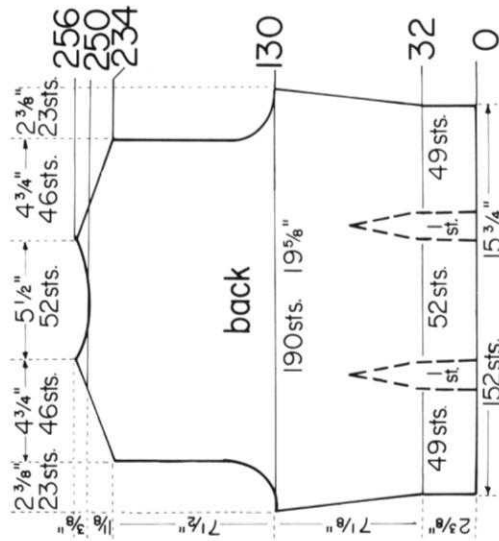

Work the left front section with reverse shapings, casting on from right to left.
Knit even over remaining 12 sts. for FACING.
After Row 304 put sts. on a stitch holder.

Continue to decrease 1 st. for the FRONT SHAPING and SHAPE SHOULDER AT THE SAME TIME after Rows indicated. Bind off 3 sts. for SHOULDER after Row 244 (245-front) Bind off 3 sts. for SHOULDER after Row 246, 4 sts. after Rows 248, (248-front) 250, (251-front) 252, 254, (254-front) 256, 258, 260, 262, 264, 266.

Continue to decrease 1 st. for the FRONT SHAPING and SHAPE ARMHOLE AT THE SAME TIME after Rows indicated. Bind off 5 sts. for ARMHOLE after Row 140, (140-front) 4 sts. after Row 142, (143-front) 3 sts. after Rows 144, 146, (146-front) 2 sts. after Row 148 (149-front) 2 sts. after Row 150, 1 st. after Rows 152 (152-front) 154, (155-front) 156, 158 (158-front) then continue front shaping only after Rows 161, 164, 167, 170, 173, 176, 179, 182, 185, 188, 191, 194, 197, 200, 203, 206, 209, 212, 215, 218, 221, 224, 227, 230, 233, 236, 239, 242.

ON CAM BOX SIDE, after Row 32, increase 2 sts. for DART (between 49th-50th-51st sts.) and 1 st. for SIDE seam, then knit even to Row 39. Decrease 1 st. (26th st. onto 25th st.) for the FRONT SHAPING after the following Rows but AT THE SAME TIME INCREASE 2 STS. FOR DART AND 1 ST. AT SIDE EDGE after the indicated rows. Rows 39, 41, (42-dart) 43, (44-side) 45, 47, 49, 51, (52-dart) 53, 55, (56-side) 57, 59, 62 (62-dart) 65, 68 (68-side) 71, (72-dart) 74, 77, 80, (82-dart and side) 83, 86, 89, 92, 95, (96-side) 98, 101, 104, 107, 110 (110-side) 113, 116, 119, 122, 125, 128, 131, 134, 137.

Rows 0-17 knit even, then cast on 24 sts. on CAM BOX SIDE. Knit even to Row 32.

Cast on 114 sts. and work stockinette st.

BIND OFF 5 sts. on CAM BOX SIDE after Rows 232, 233; 4 sts. after Rows 234, 235; 3 sts. after Rows 236, 237, 238, 239, 240, 241; 2 sts. after Rows 242, 243, 244, 245, 246, 247. ON EACH SIDE bind off 1 st. after Rows 248, 250, 252, 254, 256, 258, 260, 262, 264, 266, 268, 270, 272, 274, 276, 278, 280, 282, 284, 286, 288, 290. Bind off 2 sts. ON CAM BOX SIDE after Rows 292, 293, 294, 295; 3 sts. after Rows 296, 297; 4 sts. after Rows 298, 299, 300, 301; 14 sts. after Row 302.

ON EACH SIDE Full-fashion increase (between 2nd-3rd sts.) 1 st. after Rows 32, 38, 44, 50, 56, 62, 68, 74, 80, 86, 92, 98, 104, 110, 116, 122, 128, 134, 140, 146, 152, 158, 164, 170, 176, 182, 188, 194, 200, 206, 212, 218, 224, then knit even to Row 232.

Rows 0 to 32 knit even.

Cast on 70 sts. and work stockinette stitch.

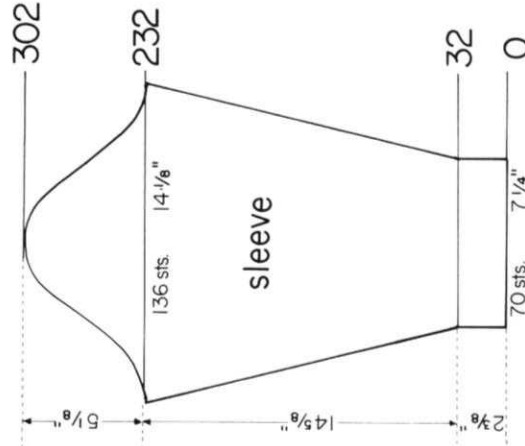

DK 7783

SIZE: 8/10. MATERIAL: 21 oz. (12 balls) red KNITTING Subita Crepe 2 x 4, Color No. 31. TENSION: KNITTING 6 to 8. STITCH GAUGE: 16 sts. 2", 22 rows 2". PATTERN: Stockinette Stitch with Cable Stripes on Skirt sections and Front sections of Vest. EDGES of VEST and POCKET: K1, P1, Ribbing.

Work the Cable Stripe over the sts. indicated on Skirt and Vest Front diagram. ALL decreases and increases of 1 st. are full-fashion. For the Skirt, ALWAYS hang the 4th st. ON EACH SIDE onto the 3rd st., then move the end sts. inward to fill the empty needles. For the Side Seams of the VEST ALWAYS move the 2 end sts. ON EACH SIDE 1 needle outward, then place the 3rd st. from the row below onto the empty needle. For the Armhole Shaping and Shoulder Shaping of Vest Back section ALWAYS hang the 5th st. ON EACH SIDE onto the 4th st. then move the end sts. inward to fill the empty needles. On the front section of the Vest, make NECKLINE SHAPINGS by ALWAYS hanging the 4th st. on Neckline side onto the 3rd st. then move the end sts. inward to fill the empty needle. Make Armhole decreases of 1 st. same as on the back section.

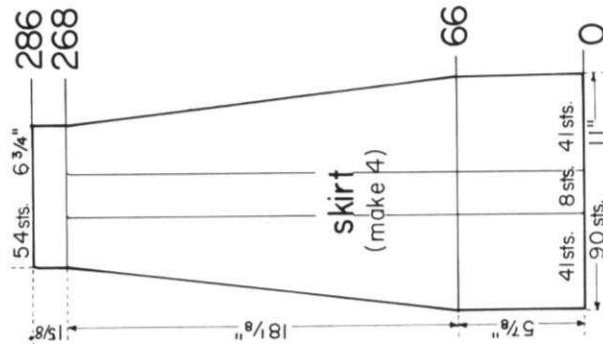

Knit even in stockinette stitch to Row 286, then bind off all 54 sts.

ON EACH SIDE Full-fashion decrease (4th st. onto 3rd st) 1 st. after Rows 66, 78, 90, 102, 114, 126, 138, 150, 162, 174, 186, 198, 210, 222, 234, 246, 258, 268.

Rows 0 to 66 knit even.

Cast on 90 sts., work stockinette st. and the Cable Stripe over the sts. indicated on Diagram. Cross the sts. the first time after Row 8, then again after every following 16th row.

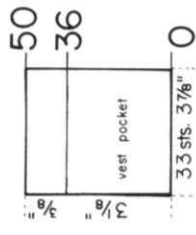

Cast on 33 sts. and work 36 rows stockinette st., change to K1, P1, Ribbing and knit 14 rows, then bind off the crochet method for ribbing.

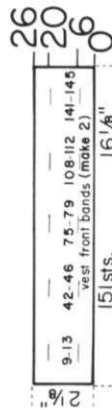

Cast on 151 sts. and work K1, P1, Ribbing. Make Buttonholes after Rows 6 and 20 over the needles indicated on chart. After Row 26, bind off the crochet method. Work the second front band without buttonholes.

FINISHING: Block all sections to measurements given. SKIRT: Weave skirt sections together, 1 st. in on each edge. Turn under 9 rows on upper edge and hem to wrong side. Insert an elastic band. Turn under 18 rows on lower edge and hem to wrong side. VEST: Weave the front and back sections together, 1 st. in on each edge, easing in the fullness at bustline of front section. Join shoulders. Sew pocket to vest (see picture). Join short ends of armbands, then sew 1 long edge to inside and 1 long edge to outside of armholes. Join neckbands at center back, then sew to front bands. Sew 1 edge of band to inside and 1 edge to outside of front and neckline having the buttonholes on the right front section. Finish buttonholes. Sew on buttons.

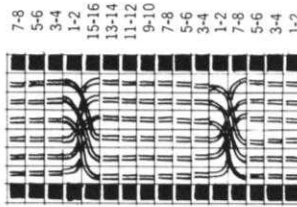
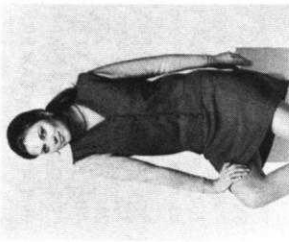

Of the 8 Cable sts., drop the 1st and 8th sts. from the needles, leave empty needles in work. With 2 Treble Transfer Tools, hang the 2nd, 3rd, and 4th sts. onto the 5th, 6th and 7th needles, then hang the 5th, 6th and 7th sts. onto the 2nd, 3rd and 4th needles. Cross the sts. the first time after 8 rows, then after every following 16th row. After each 30-40 rows, drop the 1st and 8th sts. from the needles, allow to run down, then latch up into knit sts.

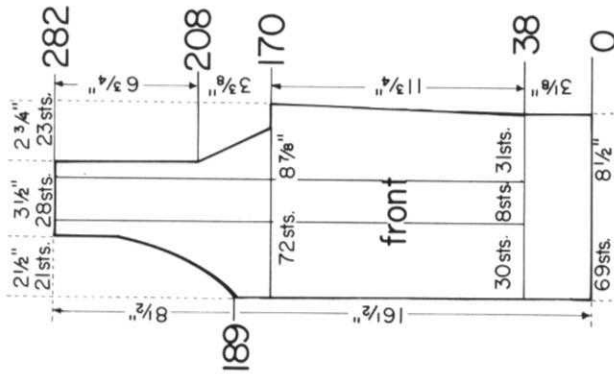

Work the left front section with reverse shapings, casting on from right to left.

Decrease 1 st. after Rows 209, 213, 217, 221, 225, 229, 237, 241, 249, 253, then knit even to row 282 and bind off all sts.

Bind off 6 sts. on CAM BOX SIDE after Row 170; 4 sts. after Row 172; 2 sts. after Rows 176, 180, 184, 188. Full-fashion decrease (4th st. onto 3rd st.) 1 st. ON CAM BOX SIDE after Rows 189, 191, (ODD ROWS = NECK SHAPING). Full-fashion decrease (5th st. onto 4th st.) 1 st. on CAM BOX SIDE after Row 192 (EVEN ROWS = ARMHOLE SHAPING) 1 st. after Rows 193, 195, 196, 197, 199, 200, 201, 203, 204, 205, 208 (last time for Armhole).

Change to stockinette st. and work the Cable Stripe over the sts. indicated on the diagram. Cross the sts. the first time after Row 46, then again after every following 16th row. Full-fashion increase (between 2nd-3rd sts.) 1 st. on CAM BOX SIDE after Rows 68, 98, 128, then knit even to Row 170.

Rows 0 to 38 knit even.

Cast on 69 sts. and work K1, P1, Ribbing.

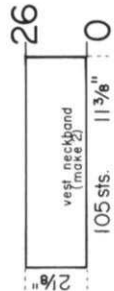

Cast on 105 sts. and work 26 rows K1, P1, Ribbing, then bind off the crochet method for ribbing.

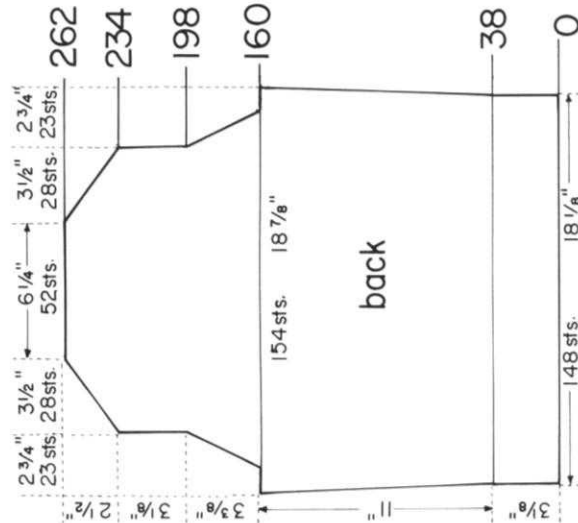

Bind off the remaining 52 sts. after Row 262.

ON EACH SIDE, Full-fashion decrease (5th st. onto 4th st.) 1 st. after Rows 234, 235, 236, 237, 238, 239, 240, 241, 242, 243, 244, 245, 246, 247, 248, 249, 250, 251, 252, 253, 254, 255, 256, 257, 258, 259, 260, 261.

Knit even to Row 234.

Bind off 6 sts. on CAM BOX SIDE after Rows 160, 161; 4 sts. after Rows 162, 163; 2 sts. after Rows 166, 167, 170, 171, 174, 175, 178, 179. ON EACH SIDE, Full-fashion decrease (5th st. onto 4th st.) 1 st. after Rows 182, 186, 190, 194, 198. ON EACH SIDE, Full-fashion increase (between 2nd-3rd sts.) 1 st. after Rows 68, 98, 128, then knit even to Row 160.

Rows 0 to 38 knit even, then change to stockinette st.

Cast on 148 sts. and work K1, P1, Ribbing.



KNITKING NEWS

September-October, 1969

SORRY, WE ARE LATE.....

This is the first time since we started publishing KNITKING MAGAZINE that it has not been in the mail on its way to subscribers by the first of the month... We were already running late when our art layout man goofed on the type to be used in the instructions and the entire instruction section had to be re-done... Sorry if you have been inconvenienced... we promise not to let it happen again...!!

THE BIG NEWS

The big news is very obviously the re-styled KNITKING MAGAZINE.... Our entirely new method of pattern presentation, designed so that anybody can easily and speedily knit the pattern of their choice... We tell you simply and concisely exactly what to do row by row.

In case you have not read the "Letter from the Publisher" at the front of this issue, we will explain again just how simple it is to knit the KNITKING MAGAZINE WAY... Turn to page 20 of this issue and see what we mean. Study the chart for the Back. As your knitting comes off your knitter, it will look the same as the chart...the cast on row is at the bottom of the chart so we start our instructions there.... The first paragraph at the bottom reads: Cast on 190 stitches and knit 194 rows even... got it okay? All you have to do is complete the instructions in each paragraph before proceeding to the paragraph above it. Check this in pattern No. DK 7771 and you will notice that instead of telling you to increase one stitch every so many rows so many times, we tell you on a row to row basis.

Unless we tell you otherwise, you will always start knitting from the right so that when the Cam Box is at the right, you will have even numbers showing on the Row Counter and when the Cam Box is at the left, it will show odd numbers... Only row numbers where some operation such as increasing or decreasing takes place, will specific instructions be given... at other times you will continue knitting even. For example, the second paragraph up from the bottom of Pattern No. DK 7771 reads: On each side, full fashion decrease (3rd st. onto 2nd st.) 1 st. after Rows 194, 202, 210, 218, 226, 234, 242, 250, 258, 266, 274, 282. Naturally, between these rows, you will knit even... simple isn't it...? A word of caution though for when you get to parts of a garment that have two areas of shaping (such as armholes and necklines) at the same time... we cannot always put those shapings into one paragraph so you will sometimes need to switch back and forth between two paragraphs in order to insure that all shapings are made in the correct spaces.

Make something up from this issue and you will see how simple it is to follow our new instruction method... If you have any problems at all in following them, we hope that you will take the time to write and tell us. We can only correct problems when we know they exist,

so please don't hesitate in writing if you have any.

There is a difference of opinion among the pattern experts at KNITKING in regard to the amount of information that should be given on the actual charts... As you will see when you study them, we eventually decided to keep this information to an absolute minimum and to give complete detailed instructions alongside each chart... The difference of opinion does, however still exist and it is this... We are endeavoring to write instructions so that even the most inexperienced knitter can understand them, but some of our experts feel that the truly experienced knitter who is used to working from a chart entirely may prefer a chart with more figures so that she can ignore the detailed instructions by the side of the charts.

Others of our experts feel that the inclusion of these extra numbers in the charts could confuse the inexperienced... We can include both if sufficient readers require them, so please write and tell us what you think... On the next page is a chart for Pattern No. DK 7771 which is the back section. It shows you how the chart would look if both instruction methods are included. Compare it with the chart on page 20.

Make certain that you understand the meaning of the various symbols used in the little charts included with any patterns that have fancy stitches... These symbols are explained in detail on the inside back cover of this magazine... they will be repeated with every issue so that you always have a ready reference.

Don't forget to make a sample swatch before you proceed with any garment... Unless you get the correct stitch and row gauge, you cannot expect to produce a garment to the correct size. Instructions for making the sample swatch are also included on the inside back cover of every issue.

GIFT AND HOUSEHOLD ITEMS

We are getting more and more requests for patterns for gift items and items such as afghans, cushion covers, etc., that can be used around the house... so starting with our next issue, we will endeavor to include at least two such items in every issue... The next issue will include a pattern for a very handsome Ripple Afghan and some cute indoor Slippers... just perfect for making up Christmas gifts.

KNITKING YARNS

With every delivery of mail at KNITKING we receive several letters from customers praising the quality and low price of beautiful KNITKING YARNS... If you haven't yet knitted something up in KNITKING YARNS, try something from this issue... all the garments in our magazines are made with KNITKING YARNS so if you want your knitting to look as good as those in KNITKING MAGAZINE, start off right and order yarns from KNITKING.... you cannot buy better yarn at any price.... The price of a big KNITKING YARN CATALOGUE with hundreds

of samples of gorgeous KNITTING YARNS in an unbelievable range of colors is only \$2.00 and you get your \$2.00 back on your first \$10.00 order at regular prices.

PRACTICAL KNITTING HINTS...

There is so much valuable information in the excellent textbook PRACTICAL KNITTING HINTS that it is difficult to believe that any machine knitter could afford to be without it... It certainly should be used in conjunction with KNITTING MAGAZINE as we cannot afford the space to explain in every pattern how to do the different types of bind-offs, how to do cable stitches, how to put your garments together so that they look perfect... Remember your garment will only look as good as your finishing.

PRACTICAL KNITTING HINTS also tells you how to block garments for perfect finishing... how to do full fashioning... embroider your knitting... make bands and edges, etc., etc.

It only costs \$2.95 plus 40¢ mailing costs (California residents must add 15¢ Sales Tax)... Order one before October 31st and we will include at no extra cost, the booklet INTERCHANGEABLE YARN CHART that lists nationally sold name brand yarns that can be used for KNITTING MAGAZINE patterns. This booklet normally sells for \$1.00.

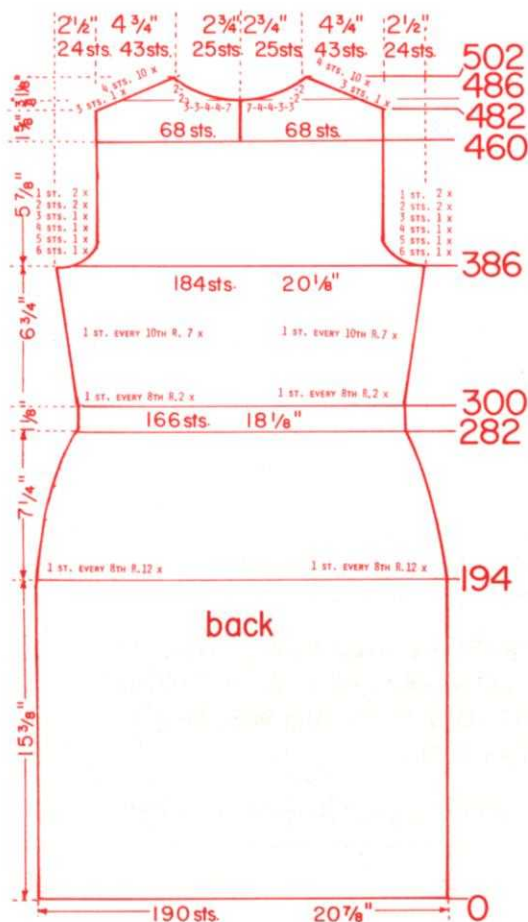

Move the CAM BOX to the left side, turn Row Counter back to 460 and complete the left half. Follow the instructions from *.

Bind off 3 sts. after Row 482 (EVEN ROWS = SHOULDER SHAPING); 4 sts. after Rows 484, 486; 7 sts. after Row 487 (ODD ROWS = NECK SHAPING); 4 sts. after Rows 488, 489, 490, 491, 492; 3 sts. after Row 493; 4 sts. after Row 494; 3 sts. after Row 495; 4 sts. after Row 496; 2 sts. after Row 497; 4 sts. after Row 498; 2 sts. after Row 499 (last time for Neck); 4 sts. after Rows 500, 502.

For the opening, put 68 sts. on the left side into holding position and complete the right half. *Rows 460 to 482, knit even.

Bind off 6 sts. on CAM BOX SIDE after Rows 386, 387; 5 sts. after Rows 388, 389; 4 sts. after Rows 390, 391; 3 sts. after Rows 392, 393; 2 sts. after Rows 394, 395, 396, 397; 1 st. after Rows 398, 399, 400, 401 then knit even to Row 460.

ON EACH SIDE, Full-fashion increase (between 2nd-3rd sts.) 1 st. after Rows 300, 308, 316, 326, 336, 346, 356, 366, 376, then knit even to Row 386.

Knit even to Row 300.

ON EACH SIDE, Full-fashion decrease (3rd st onto 2nd st.) 1 st. after Rows 194, 202, 210, 218, 226, 234, 242, 250, 258, 266, 274, 282.

Rows 0 to 194, knit even.

Cast on 190 sts. and work stockinette st.

EXTENSION OF SUMMER SALE

We received many letters from readers saying that they have not received this issue and were awaiting its arrival in order to decide what yarns to buy at our summer sale prices.... Because it is our fault that the magazine is late getting to you, we are extending the deadline for the sale until October 20th... so be sure to send your orders in speedily in order to take advantage of the SUMMER SALE low low prices.



ARE YOU UNHAPPY WITH YOUR PRESENT KNITTING MACHINE ?

DOES IT REFUSE TO KNIT FANCY DRESS YARNS?

DOES IT JAM UP WHEN YOU TRY TO KNIT LOOPED MOHAIR OR THICK AND THIN YARNS?

DOES IT DROP STITCHES ALL OVER THE PLACE?

ARE YOU CONTINUALLY HAVING TROUBLE WITH AWKWARD, CUMBERSOME WEIGHTS?

ARE YOU UNABLE TO MAKE A LARGE GARMENT WITH BULKY YARNS?

DO YOU HAVE TO SELECT PATTERN STITCHES MANUALLY?

DO YOU HAVE TO LATCH YOUR RIBBING BY HAND?

IF YOU ARE HAVING ANY OF THESE PROBLEMS YOU SHOULD TRADE UP TO A NEW FANTASTIC PUSH BUTTON KNITTING WITH COORDINATED RIBBER AND ENJOY KNITTING WITH THE WORLDS FINEST, MOST VERSATILE AND MOST AUTOMATIC KNITTER.

YOU WILL BE SURPRISED AT OUR GENEROUS TRADE-IN ALLOWANCE AND YOU CAN, IF YOU WISH, USE YOUR PRESENT MACHINE AS A DOWN-PAYMENT AND PURCHASE A COMPLETE KNITTING FOR JUST PENNIES A DAY. WRITE TODAY FOR FULL INFORMATION AND TELL US WHAT MACHINE YOU NOW OWN. THE ADDRESS IS:

KNITKING, Dept. T-1, 1128 Crenshaw Blvd., Los Angeles, Calif. - 90019

DK 7770

SIZE: 14/16. MATERIAL: 26% oz. (15 balls) brown KNITTING Subita Crepe 2 x 4, Color No. 27. TENSION: KNITTING 5 to 7 STITCH GAUGE: 16 sts. 2", 23 rows 2".
 PATTERN: Stockinette Stitch with Cable Stripes on Front sections, Pockets and Sleeves. FRONT and NECKBAND, upper POCKET EDGES, lower EDGE of BERET: K1, P1, Ribbing.

All decreases and increases for side seams, neckline and sleeve seams are full-fashion. After hanging sts. together for decreases, move the end sts. inward to fill the empty needles. To increase, move the 2 end sts. 1 needle outward, then place the 3rd sts. from the row below onto the empty needle. Work the Cable Stripes over the sts. indicated on the diagrams, cross the sts. the first time after Row 10, then after every following 20th row. Mark the back rail of needle bed for easy identification of the Cable and Knit sts.

FINISHING: Block all sections to measurements given. Join front and back sections at sides and shoulders, easing in the fullness at bustline of front sections. Sew sleeves together and set in. Sew pockets to Coat as illustrated. Join neckbands at center back then sew to front bands. Sew band around fronts and neckline. Finish buttonholes, sew on buttons. Weave the beret section together, 1 st. in on each edge.

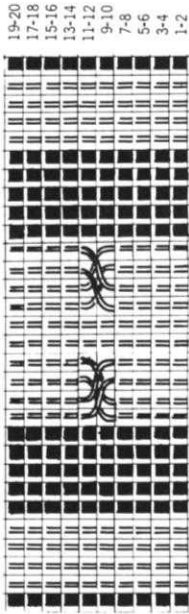
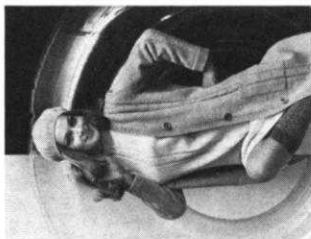

14 Cast on 139 sts. and work 14 rows K1, P1, Ribbing, then bind off the crochet method for ribbing.

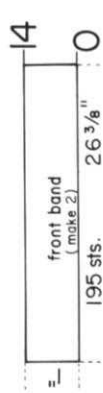
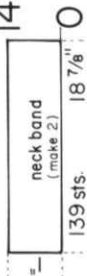

Cast on 195 sts. and work 14 rows K1, P1, Ribbing, then bind off the crochet method for ribbing.

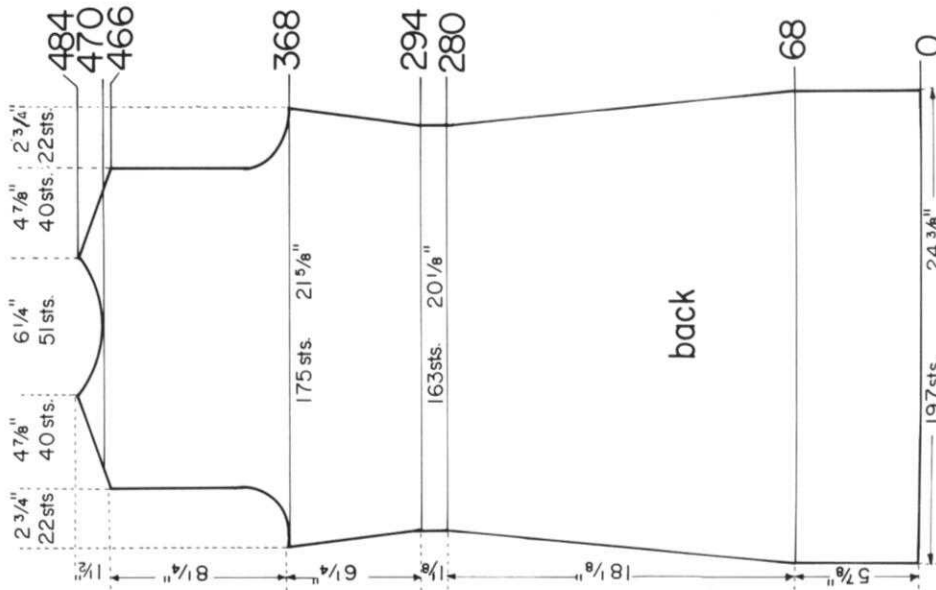
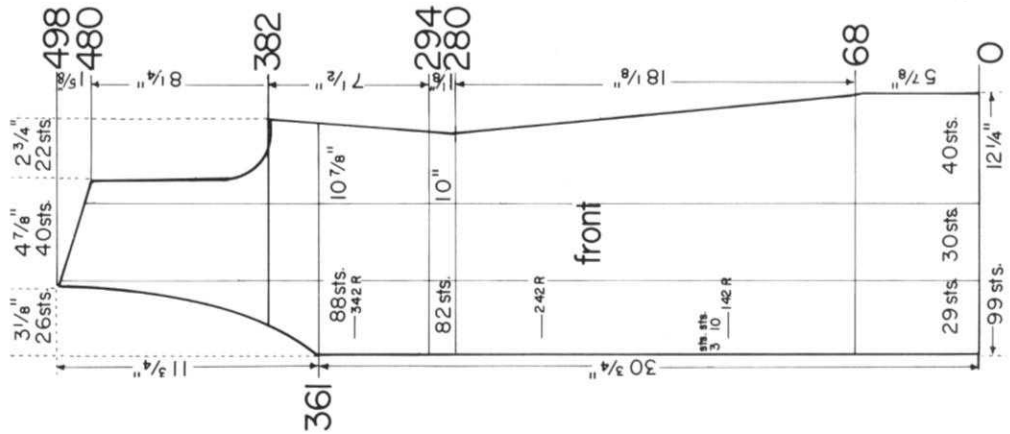

1. Of the 30 Cable Design Sts. drop the 10th st. counting from the right side, from the needle, leave empty needle in work. With 2 double Transfer Tools, hang the 11th and 12th sts. onto the 13th and 14th needles, then the 13th and 14th sts. onto the 11th and 12th needles.
2. Counting from the left side, repeat step 1.
3. Knit 20 rows.

Repeat steps 1 to 3 throughout. After Each 40-50 rows drop the 1st, 6th, 7th, 8th, 9th, and 10th st. counting from each side, allow them to run down and then latch up into knit sts. Cross the sts. the first time after Row 10, and allow sts. to run down to Row 0.

Work the left front section with reverse shaping, casing on from right to left. OMIT THE BUTTON-HOLES.

Bind off 4 sts. on CAM BOX SIDE after Row 480 (EVEN ROWS = SHOULDER SHAPING) 1 st. after Row 481; 4 sts. after Rows 482, 484, 486; 1 st. after Row 487; 4 sts. after Rows 488, 490, 492; 1 st. after Row 493 (last time for neck) 4 sts. after Rows 494, 496, 498.

Bind off 6 sts. on CAM BOX SIDE after Row 382 (EVEN ROWS = ARMHOLE SHAPING.) 4 sts. after Row 384; 1 st. after Row 385; 4 sts. after Row 386 and 2 sts. after Row 388; 1 st. after Row 389; 2 sts. after Rows 390, 392; 1 st. after Rows 393, 394, 396 (last time for Armhole) 397, 403, 409, 415, 421, 427, 433, 439, 445, 451, 457, 463, 469, 475.

ON CAM BOX SIDE, Full-fashion increase (between 2nd-3rd st.) 1 st. after Rows 294, 306, 318, 330, 342, (also MAKE BUTTONHOLE AFTER ROW 342) and increase 1 st. after Row 354, then knit even to Row 361. ON CAM BOX SIDE Full-fashion decrease, 1 st. (4 st. onto 3rd st.) after Rows 361, 365, 369, 373, 377, 381. (ODD ROWS = NECK SHAPING).

Knit even.

ON CAM BOX SIDE, Full-fashion decrease (3rd st. onto 2nd st.) 1 st. after Rows 68, 82, 96, 110, 124, 138, (MAKE BUTTONHOLE AFTER Row 142 over the 3rd-10th sts.) continue decreasing, 1 st. after Rows 152, 166, 180, 194, 208, 220, 232, (MAKE BUTTONHOLE AFTER Row 242) 244, 256, 268, 280.

Rows 0 to 68, knit even.

Cast on 99 sts. and work stockinette st. and the Cable Stripe over the sts. indicated on the diagram.

Continued on next page

DP 7786

SIZE: 10/12. **MATERIAL:** 14 oz. (8 balls) white KNITTING Subita Crepe 2 x 3. Color No. 104. **TENSION:** KNITTING 4 to 6. **STITCH GAUGE:** 17 sts. 2", 23 rows 2". **PATTERN:** Stockinette Stitch with Eyelet Design on the front section according to Chart. **EDGES and COLLAR:** K1, P1, Ribbing. To make the full-fashion increases, move the 2 end sts. ON EACH SIDE 1 needle outward then place the 3rd st. from the row below onto the empty needle.

FINISHING: Block all sections to measurements given. Join front and back section at sides and shoulders easing in the fullness at bustline of front section. Weave sleeves together and set in. Join short ends of collar, then sew cast-on edge of collar to inside and bound-off edge to outside of neckline, having the knit sts. on the right side.

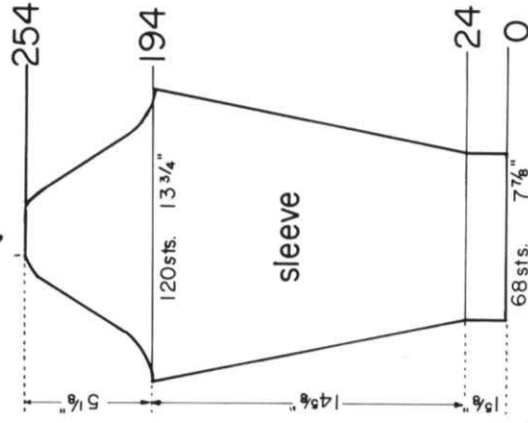
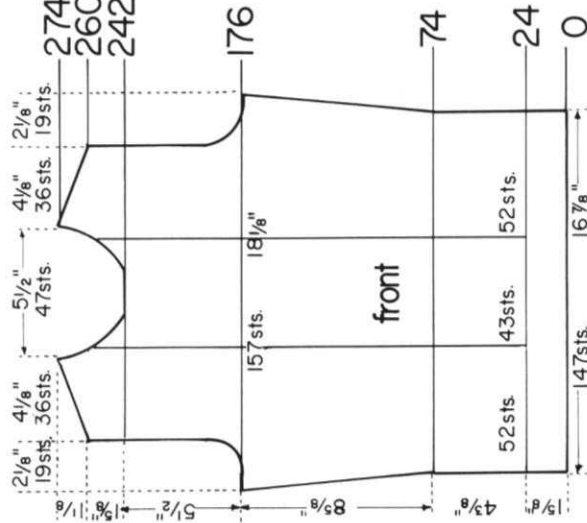

Bind off 6 sts. on CAM BOX SIDE after Rows 194, 195; 5 sts. after Rows 196, 197; 4 sts. after Rows 198, 199; 2 sts. after Rows 200, 201, 202, 203, 204, 205. ON EACH SIDE, bind off 1 st. after Rows 206, 208, 210, 212, 214, 216, 218, 220, 222, 224, 226, 228, 230, 232, 234, 236, 238, 240, 242, 244. Bind off 2 sts. on CAM BOX SIDE after Rows 246, 247; 3 sts. after Rows 248, 249, 250, 251; 5 sts. after Rows 252, 253; 12 sts. after Row 254.

ON EACH SIDE, Full-fashion increase (between 2nd-3rd sts.) 1 st. after Rows 24, 32, 40, 48, 56, 64, 72, 80, 88, 92, 98, 104, 110, 116, 122, 128, 134, 140, 146, 152, 158, 164, 170, 176, 182, 188, then knit even to Row 194.

Rows 0 to 24, knit even, then change to stockinette st. and knit even to Row 194.
Cast on 68 sts. and work K1, P1, Ribbing.

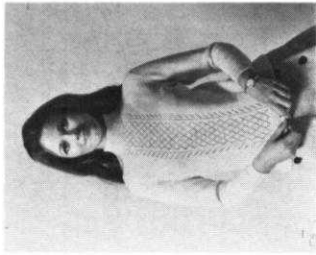

Move the Cam Box to the left side, turn the Row Counter back to 242 and complete the left half. Follow the instructions from *.
Bind off 4 sts. after Row 260 (EVEN ROWS = SHOULDER SHAPING); 1 st. after Row 261 (last time for neck); 4 sts. after Rows 262, 264, 266; 5 sts. after Rows 268, 270, 272, 274.

After Row 242 put 59 sts. on the left side into holding position and complete the right half. *Bind off 8 sts. (7 sts. for left half) after Row 243 (ODD ROWS = NECK SHAPING); 3 sts. after Rows 245, 247; 2 sts. after Rows 249, 251, 253; 1 st. after Rows 255, 257, 259.

Bind off 5 sts. on CAM BOX SIDE after Rows 176, 177, 178, 179; 4 sts. after Rows 180, 181; 2 sts. after Rows 182, 183, 184, 185; 1 st. after Rows 186, 187, then knit even to Row 242.

ON EACH SIDE, Full-fashion increase (between 2nd-3rd sts.) 1 st. after Rows 74, 92, 110, 128, 146, then knit even to Row 176.

Rows 0 to 24, Knit even, then change to stockinette st. and work the Eyelet Design over the center 43 sts. and knit even to Row 74.

Cast on 147 sts. and work K1, P1, Ribbing.

DK 7770

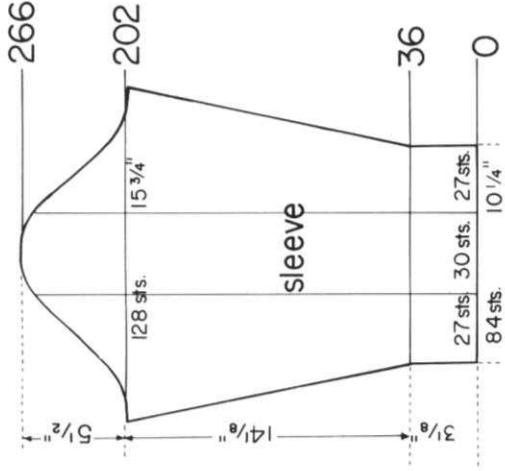

Bind off 6 sts. on CAM BOX SIDE after Rows 202, 203; 5 sts. after Rows 204, 205, 206, 207; 2 sts. after Rows 208, 209, 210, 211. ON EACH SIDE, bind off 1 st. after Rows 212, 214, 216, 218, 220, 222, 224, 226, 228, 230, 232, 234, 236, 238, 240, 242, 244, 246, 248, 250, 252, 254, 256. Bind off 2 sts. on CAM BOX SIDE after Rows 258, 259, 260, 261; 4 sts. after Rows 262, 263; 7 sts. after Rows 264, 265; 12 sts. after Row 266.

ON EACH SIDE, Full-fashion increase (between 2nd-3rd sts.) 1 st. after Rows 36, 42, 48, 54, 60, 66, 72, 80, 88, 96, 104, 112, 120, 128, 136, 144, 152, 160, 168, 176, 184, 192, then knit even to Row 202.

Rows 0 to 36, knit even.

Cast on 84 sts. knit stockinette st. and work the Cable Stripe over the center 30 sts.

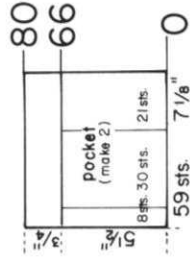

Change to K1, P1, Ribbing and knit to Row 80, then bind off the crochet method for Ribbing. Work the LEFT pocket by beginning the CABLE STRIPE with the 9th st.

Rows 0 to 66 Work stockinette st. and the CABLE STRIPE (begin Cable with the 22nd st.)
Cast on 59 sts.

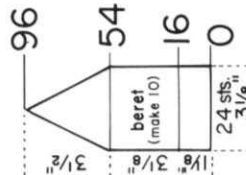

ON EACH SIDE, Full-fashion decrease (2nd st. onto 3rd st.) 1 st. after Rows 54, 58, 62, 66, 70, 74, 78, 82, 86, 90, 94. Bind off remaining 2 sts. after Row 96.

Rows 0 to 16, knit even, then change to stockinette st. and knit even to Row 54.

Cast on 24 sts. and work K1, P1, Ribbing, having 2 sts. on the right side on the main machine.

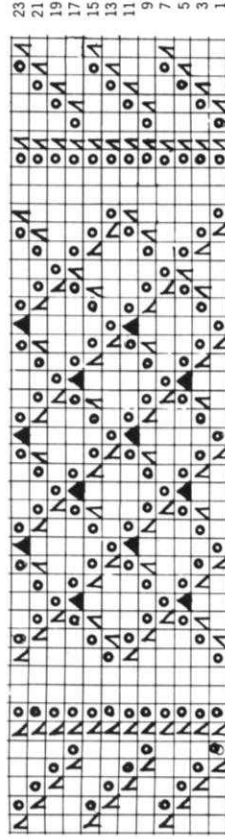

SIZE: 14/16. **MATERIAL:** 21 oz. (12 balls) beige (KNIT-KING Subita Crepe 2 x 3, Color No. 134. **TENSION:** KNITTING 3 to 5. **STITCH GAUGE:** 18 sts. 2"; 25 rows 2". **PATTERN:** Stockinette Stitch with Cable Stripe on front section. **NECKBAND** and **Sleeve Edges:** K1, P1, Ribbing. The cable design is the same as on DK 7770, see page 17

The decreases for side seams and increases for side seams and sleeve seams are full-fashion. After hanging the sts. together for decreases, move the end sts. inward to fill the empty needles. To increase, move the 2 end sts. ON EACH SIDE 1 needle outward, then place the 3rd st. from the row below onto the empty needle.

FINISHING: Block all sections to measurements given. Join front and back section at sides and shoulders, easing in the fullness at bustline of front section. Sew sleeves together and set in. Turn under 20 rows on lower edge and hem to wrong side. Sew neckband to neckline. Work 1 row of single crochet around opening. Work 3 loops on 1 side and sew 3 buttons to other side of opening.

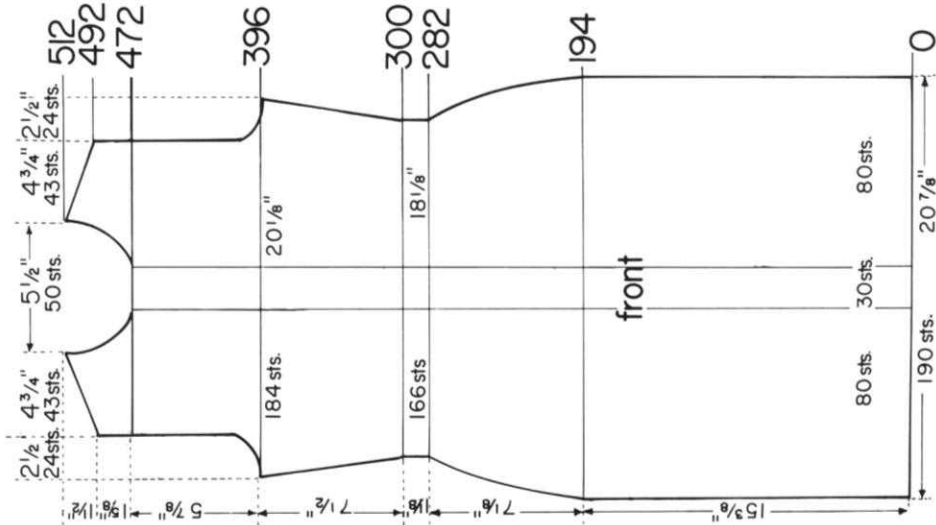

Move the CAM BOX to the left side, turn the Row Counter back to 472 and complete the left half. Follow instructions from *.

Bind off 3 sts. after Row 492; 4 sts. after Rows 494, 496, 498, 500, 502, 504, 506, 508, 510, 512.

On the left side put 68 sts. into holding position and complete the right half. *Bind off 7 sts. after Row 473 (ODD ROWS = NECK SHAPING); 4 sts. after Row 475; 3 sts. after Rows 477, 479; 2 sts. after Rows 481, 483, 485; 1 st. after Rows 487, 489 (last time for Neck) then knit even to Row 492.

Bind off 6 sts. on CAM BOX SIDE after Rows 396, 397; 5 sts. after Rows 398, 399; 4 sts. after Rows 400, 401; 3 sts. after Rows 402, 403; 2 sts. after Rows 404, 405, 406, 407; 1 st. after Rows 408, 409, 410, 411, then knit even to Row 472.

ON EACH SIDE, Full-fashion increase (between 2nd-3rd sts.) 1 st. after Rows 300, 308, 316, 326, 336, 346, 356, 366, 376, then knit even to Row 396.

Knit even to Row 300.

ON EACH SIDE, Full-fashion decrease (3rd st. onto 2nd st.) 1 st. after Rows 194, 202, 210, 218, 226, 234, 242, 250, 258, 266, 274, 282.

Rows 0 to 194, knit even.

Cast on 190 sts., work stockinette st. and the Cable Stripe over the center 30 sts., crossing the sts. the first time after Row 10, then after every following 20th row.



ROWS 0 to 60 K1, P1, Ribbing, then change to stockinette st. and knit 4 rows even. After row 64 bind off all sts. the crochet method. Cast on 144 sts.

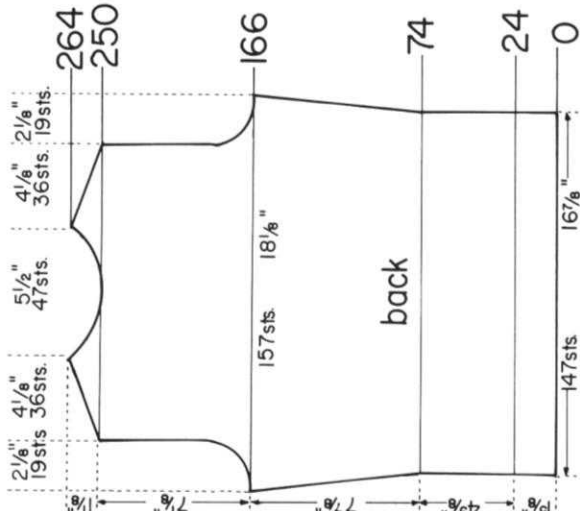

Move the Cam Box to the left side, turn the Row Counter back to 250 and complete the left half. Follow instructions from *.

After Row 250, put 59 sts. on the left side into holding position and complete the right half. *Bind off 4 sts. after Row 250 (EVEN ROWS = SHOULDER SHAPING); 9 sts. (8 sts. for left half) after Row 251 (ODD ROWS = NECK SHAPING); 4 sts. after Rows 252, 253, 254, 255, 256; 3 sts. after Row 257; 5 sts. after Row 258; 2 sts. after Row 259; 5 sts. after Row 260; 2 sts. after Row 261; 5 sts. after Rows 262, 264.

Bind off 5 sts. on CAM BOX SIDE after Rows 166, 167, 168, 169; 4 sts. after Rows 170, 171; 2 sts. after Rows 172, 173, 174, 175; 1 st. after Rows 176, 177, then knit even to Row 250.

ON EACH SIDE, Full-fashion increase (between 2nd-3rd sts.) 1 st. after Rows 74, 92, 110, 128, 146, then knit even to Row 166.

Rows 0 to 24, knit even, then change to stockinette st.

Cast on 147 sts. and work K1, P1, Ribbing.

Bind off 6 sts. on CAM BOX SIDE after Rows 56, 57; 4 sts. after Rows 58, 59, 60, 61; 3 sts. after Rows 62, 63; 2 sts. after Rows 64, 65, 66, 67, 68, 69. ON EACH SIDE bind off 1 st. after Rows 70, 72, 74, 76, 78, 80, 82, 84, 86, 88, 90, 92, 94, 96, 98, 100, 102, 104, 106, 108, 110, 112. Bind off 2 sts. on CAM BOX SIDE after Rows 114, 115; 3 sts. after Rows 116, 117; 4 sts. after Rows 118, 119, 120, 121; 14 sts. after Row 122.

ON EACH SIDE, Full-fashion increase (between 2nd-3rd sts.) 1 st. after Rows 16, 20, 24, 28, 32, 36, 40, 44, 48, 52, then knit even to Row 56.

Rows 0 to 16, knit even, then change to stockinette st.

Cast on 110 sts. and work K1, P1, Ribbing.

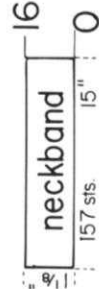

Cast on 157 sts. and work 16 rows K1, P1, Ribbing, then bind off the crochet method for ribbing.

DK 7771

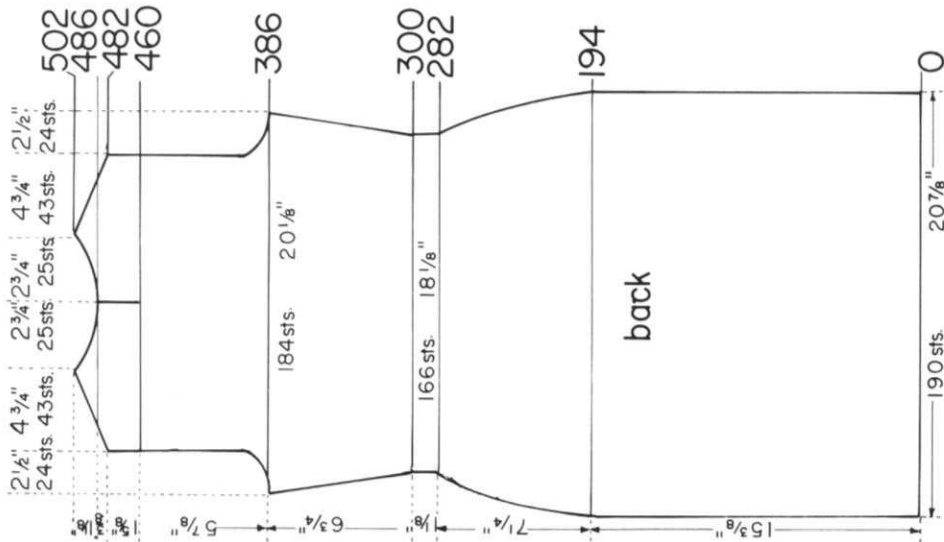

Move the CAM BOX to the left side, turn Row Counter back to 460 and complete the left half. Follow the instructions from *.

Bind off 3 sts. after Row 482 (EVEN ROWS = SHOULDER SHAPING); 4 sts. after Rows 484, 486; 7 sts. after Row 487 (ODD ROWS = NECK SHAPING); 4 sts. after Rows 488, 489, 491, 492; 3 sts. after Row 493; 4 sts. after Row 494; 3 sts. after Row 495; 4 sts. after Row 496; 2 sts. after Row 497; 4 sts. after Row 498; 2 sts. after Row 499 (last time for Neck); 4 sts. after Rows 500, 502.

For the opening, put 68 sts. on the left side into holding position and complete the right half.
*Rows 460 to 482, knit even.

Bind off 6 sts. on CAM BOX SIDE after Rows 386, 387; 5 sts. after Rows 388, 389; 4 sts. after Rows 390, 391; 3 sts. after Rows 392, 393; 2 sts. after Rows 394, 395, 396, 397; 1 st. after Rows 398, 399, 400, 401 then knit even to Row 460.

ON EACH SIDE, Full-fashion increase (between 2nd-3rd sts.) 1 st. after Rows 300, 308, 316, 326, 336, 346, 356, 366, 376, then knit even to Row 386.

Knit even to Row 300.

ON EACH SIDE, Full-fashion decrease (3rd st. onto 2nd st.) 1 st. after Rows 194, 202, 210, 218, 226, 234, 242, 250, 258, 266, 274, 282.

Rows 0 to 194, knit even.

Cast on 190 sts. and work stockinette st.

THE JAC 40 IS A MUST for fast easy knitting of Jaquard and Ski-sweater designs



Patterns are selected—row by row—through a pre-stamped card that is fed into the Jac. There are over 140 cards available and illustrations of them are included with each Jac. Jac 40's are made for most brands of machines (with the exception of Japanese machines). When ordering be sure to specify your brand of knitter as needle spacings vary. Simple to use and an essential tool for the modern knitter, Jac 40's are \$24.95 complete with 3 cards for practicing the 3 techniques, plus complete instructions.

Order from your dealer or direct from
JAC 40 KNITTING

1128 Crenshaw Boulevard, Los Angeles, Calif. 90019
Shipping Cost \$1.50—California residents add 5% sales tax.

DP 7782

SIZE: 12/14. MATERIAL: 15 1/4 oz. (9 balls) KNITTING Subita Crepe 2 x 3. Color No. 117. TENSION: KNITTING 4 to 6. STITCH GAUGE: Pattern Stitch 16 sts. 2", 29 rows 2". PATTERN: Holding Position Design according to Chart, worn on the purl side. Use Cam Wheel W 2 (New) and push in the right Retractor Button. EDGES: K1, P1, Ribbing.

When making the increases on the front and back section and on the sleeves, proceed as follows: After the Rows indicated in the instructions, place the end sts. ON EACH SIDE from the row below onto the empty neighboring needle, then RESET the DIAL to bring proper needles into holding position for PATTERN. Reset DIAL also after all Bind-offs. When working the right half of the sections, for Neck shaping, release the retractor Button and bring needles back into work manually.

FINISHING: Block all sections to measurements given. Join front and back section at sides and shoulders, easing in the fullness at bustline of front section. Sew sleeves together and set in. Join short ends of neckband, (the purl side is the right side) Sew bound-off edge of neckband to neckline.

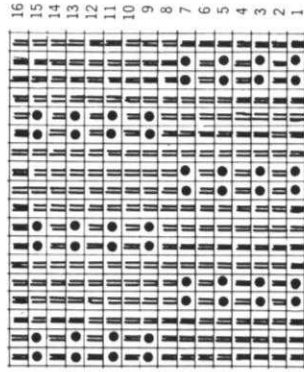

Change to stockinette st. and knit 4 rows even. Bind off the crochet method.

Cast on 139 sts. and work 12 rows K1, P1, Ribbing.

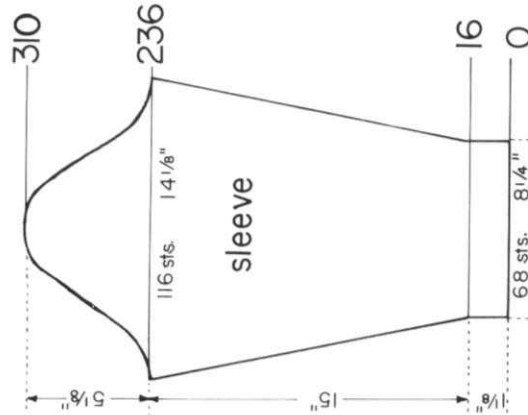

Bind off 5 sts. on CAM BOX SIDE after Rows 236, 237; 4 sts. after Rows 238, 239; 3 sts. after Rows 240, 241; 2 sts. after Rows 242, 243, 244, 245. ON EACH SIDE, bind off 1 st. after Rows 246, 248, 250, 252, 254, 256, 258, 260, 262, 264, 266, 268, 270, 272, 274, 276, 278, 280, 282, 284, 286, 288, 290, 292, 294, 296, 298, 300, 302. Bind off 2 sts. on CAM BOX SIDE after Rows 304, 305; 3 sts. after Rows 306, 307; 4 sts. after Rows 308, 309, 8 sts. after Row 310.

ON EACH SIDE, increase 1 st. after Rows 16, 26, 36, 46, 56, 66, 76, 86, 96, 106, 116, 126, 136, 146, 156, 164, 172, 180, 188, 196, 204, 212, 220, 228, then knit even to Row 236.

Rows 0 to 16 knit even, then change to stockinette st. and work the Holding Position Design. Cast on 68 sts. and work K1, P1, Ribbing.

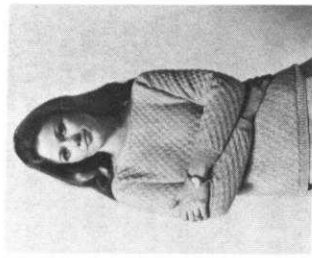

Bring the needles on the left side into working position according to the PATTERN, knit 1 row to the left side, turn the Row Counter back to 300 and complete the left half. Follow instructions from *.

Bind off 3 sts. after Rows 324, 326, 328, 330, 332 (EVEN ROWS = SHOULDER SHAPING); 4 sts. after Rows 334, 336, 338, 340, 342.

After Row 300 put 57 sts. on the left side into holding position and complete the right half. *Bind off 6 sts. after Row 301 (ODD ROWS = NECK SHAPING); 4 sts. after Row 303; 3 sts. after Rows 305, 307; 2 sts. after Rows 309, 311; 1 st. after Rows 313, 315 (last time for Neck), then knit even to Row 324.

Bind off 6 sts. on CAM BOX SIDE after Rows 220, 221; 4 sts. after Rows 222, 223, 224, 225; 2 sts. after Rows 226, 227, 228, 229; 1 st. after Rows 230, 231, 232, 233, 234, 235, then knit even to Row 300.

ON EACH SIDE, increase 1 st. after Rows 86, 110, 134, 158, 182, then knit even to Row 220.

Rows 0 to 16 knit even, then change to stockinette st. and work the Holding Position Design. Knit even to Row 86.

Cast on 146 sts. and work K1, P1, Ribbing.

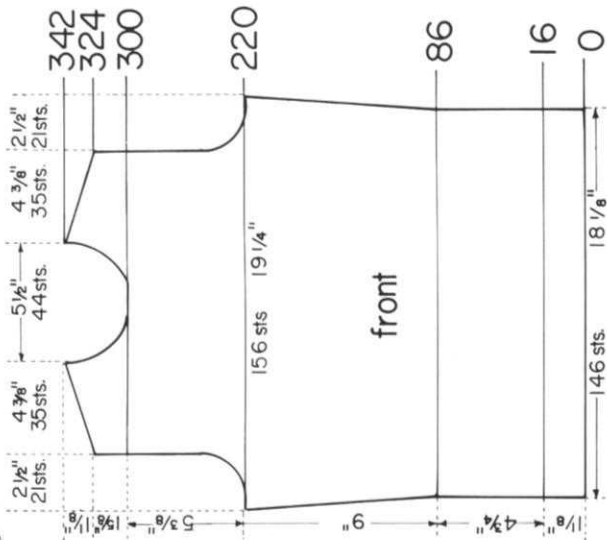

Bring the needles on the left side into working position according to the PATTERN, knit 1 row to the left side, turn the Row Counter back to 312 and complete the left half. Follow the instructions from *.

*Bind off 3 sts. after Row 312 (EVEN ROWS = SHOULDER SHAPING); 8 sts. after Row 313 (ODD ROWS = NECK SHAPING); 3 sts. after Row 314; 5 sts. after Row 315; 3 sts. after Row 316; 5 sts. after Row 317; 3 sts. after Row 318; 4 sts. after Row 319 (last time for Neck); 3 sts. after Row 320; 4 sts. after Rows 322, 324, 326, 328, 330.

Bind off 6 sts. on CAM BOX SIDE after Rows 208, 209; 4 sts. after Rows 210, 211, 212, 213; 2 sts. after Rows 214, 215, 216, 217; 1 st. after Rows 218, 219, 220, 221, 222, 223, then knit even to Row 312. After Row 312, put 57 sts. on the left side into holding position and complete the right half.

ON EACH SIDE, increase 1 st. after Rows 86, 110, 134, 158, 182 then knit even to Row 208.

Rows 0 to 16 knit even, then change to stockinette st. and work the Holding Position Design. Knit even to Row 86.

Cast on 146 sts. and work K1, P1, Ribbing.

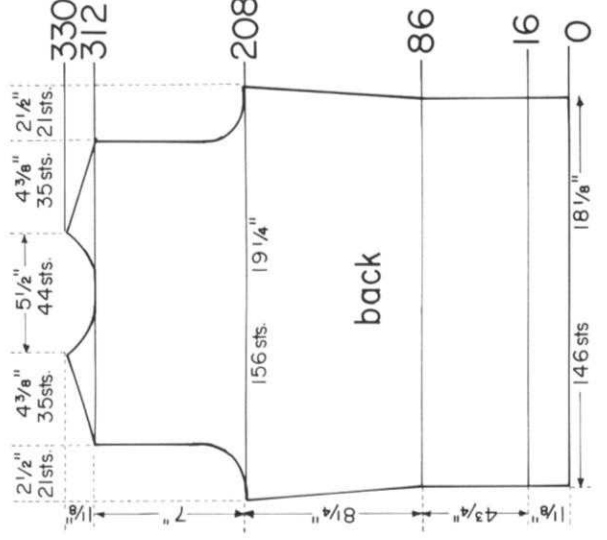

DP 7784

SIZE: 8/10. MATERIAL: 12 1/2 oz. (7 balls) yellow KNIT-KING Subita Crepe 2 x 3, Color No. 105. TENSION: KNOTTING 3 to 5. STITCH GAUGE: 17 sts. 2", 25 rows 2".

PATTERN: Stockinette Stitch with Cable Stripes on the Front section, EDGES and COLLAR: K1, P1, Ribbing.

Mark the needles for the 2 Cable Stripes on the front section before making the first increase. For ALL Full-fashion increases, move the 2 end sts. ON EACH SIDE 1 needle outward, then place the 3rd st. from the row below onto the empty needle.

FINISHING: Block all sections to measurements given. Weave front and back section together at sides, 1 st. in on each edge, easing in the fullness at bustline of front section. Join shoulders. Weave sleeves together, 1 st. in on each edge and set in. Join short ends of collar. Sew 1 long edge of collar to inside and 1 long edge to outside of neckline.

Of the 10 Cable Stitches, drop the 1st, 2nd, 9th, and 10th sts. from the needles, leave empty needles in work. With 2 Treble Transfer Tools hang the 3rd, 4th and 5th sts. onto the 6th, 7th and 8th needles, then the 6th, 7th and 8th sts. onto the 3rd, 4th and 5th needles. Cross the sts. the first time after 10 rows, then after every following 18th row. After each 30-40 rows drop the 1st, 2nd, 9th and 10 sts. from the needles and let run down, then latch up into knit sts.

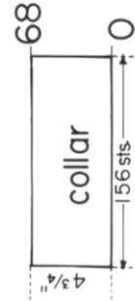
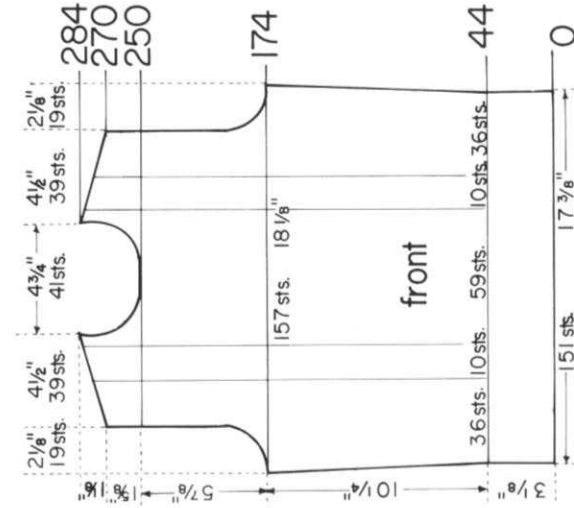
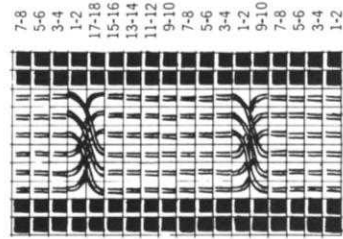
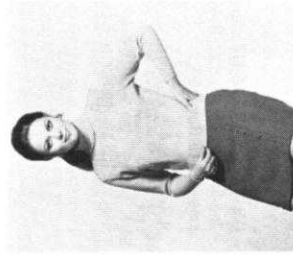

Move the Cam Box to the left side, turn the Row Counter back to 250 and complete the left half. Follow the instructions from *.

Bind off 4 sts. after Row 270 (EVEN ROWS = SHOULDER SHAPING) 5 sts. after Rows 272, 274, 276, 278, 280, 282, 284.

After Row 250, put 59 sts. on the left side into holding position and complete the right half. *Bind off 6 sts. (5 sts. for the left half) after Row 251 (ODD ROWS = NECK SHAPING); 3 sts. after Rows 253, 255; 2 sts. after Rows 257, 259; 1 st. after Rows 261, 263, 265, 267, 269 (last time for neck).

Bind off 5 sts. on CAM BOX SIDE after Rows 174, 175; 4 sts. after Rows 176, 177, 178, 179; 2 sts. after Rows 180, 181, 182, 183; 1 st. after Rows 184, 185, 186, 187, then knit even to Row 250.

Change to stockinette st. and work the Cable Stripes over the sts. indicated on the Diagram. (Cross the sts. the first time after Row 54, then every following 18th Row) ON EACH SIDE Full-fashion increase (between 2nd-3rd sts.) 1 st. after Rows 44, 84, 124, then knit even to Row 174.

Rows 0 to 44 knit even.

Cast on 151 sts. and work K1, P1, Ribbing.

Cast on 156 sts. and work 68 rows K1, P1, Ribbing, then bind off the crochet method for ribbing.

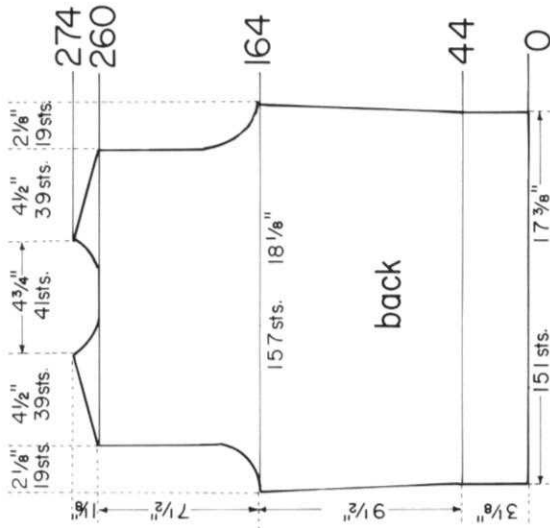

Move the Cam Box to the left side, turn the Row Counter back to 260 and complete the left half. Follow instructions from *.

After Row 260 put 59 sts. on the left side into holding position and complete the right half. *Bind off 4 sts. after Row 260 (EVEN ROWS = SHOULDER SHAPING); 9 sts. (8 sts. for left half) after Row 261 (ODD ROWS = NECK SHAPING); 5 sts. after Row 262; 3 sts. after Row 263; 5 sts. after Row 264; 3 sts. after Row 265; 5 sts. after Row 266; 2 sts. after Row 267; 5 sts. after Row 268; 2 sts. after Row 269; 5 sts. after Row 270; 1 st. after Row 271; 5 sts. after Row 272; 1 st. after Row 273; 5 sts. after Row 274.

Bind off 5 sts. on CAM BOX SIDE after Rows 164, 165; 4 sts. after Rows 166, 167, 168, 169; 2 sts. after Rows 170, 171, 172, 173; 1 st. after Rows 174, 175, 176, 177, then knit even to Row 260.

ON EACH SIDE, Full-fashion increase (between 2nd-3rd sts.) 1 st. after Rows 44, 84, 124, then knit even to Row 164.

Rows 0 to 44, knit even, then change to stockinette st.

Cast on 151 sts. and work K1, P1, Ribbing.

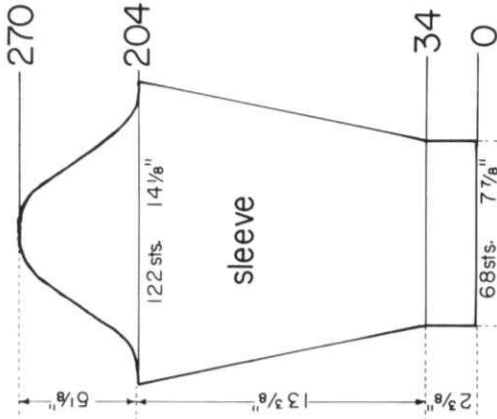

Bind off 5 sts. on CAM BOX SIDE after Rows 204, 205; 3 sts. after Rows 206, 207, 208, 209, 210, 211; 2 sts. after Rows 212, 213, 214, 215, 216, 217. ON EACH SIDE, bind off 1 st. after Rows 218, 220, 222, 224, 226, 228, 230, 232, 234, 236, 238, 240, 242, 244, 246, 248, 250, 252, 254, 256, 258, 260. Bind off 2 sts. on CAM BOX SIDE after Rows 262, 263, 264, 265; 4 sts. after Rows 266, 267; 5 sts. after Rows 268, 269; 12 sts. after Row 270.

ON EACH SIDE Full-fashion increase (between 2nd-3rd sts.) 1 st. after Rows 34, 40, 46, 52, 58, 64, 70, 76, 82, 88, 94, 100, 106, 112, 118, 124, 130, 136, 142, 148, 154, 160, 166, 172, 180, 188, 196, then knit even to Row 204.

Rows 0 to 34 knit even, then change to stockinette st.

Cast on 68 sts. and work K1, P1, Ribbing.

KK 5082



SIZE 9-10 (Chest 27"-28") MATERIAL: 5 1/4 oz. (3 balls) dark blue KNITTING Subita Dralon 3-ply, Color No. 417 and a 10" Jacket type Zipper. TENSION: KNITTING 4 to 6. STITCH GAUGE: 16 sts. 2", 21 rows 2". PATTERN: Stockinette Stitch. EDGES: K1, P1, Ribbing.

The front shaping decreases are full-fashion. Always hang the 4th st. counting from the front edge onto the 3rd st., then move the end st. inward to fill the empty needle.

FINISHING: Block all sections to measurements given. Join front and back sections at sides and shoulders. Join front Neck Bands at center back, then sew to front and neckline. Join short ends of armhole bands, then sew bands to armholes. Sew pocket to vest. (see picture). Sew in zipper.

Work 10 Rows K1, P1, Ribbing then bind off the crochet method for Ribbing.

Rows 0 to 30 stockinette st. then change to K1, P1, Ribbing.

Cast on 29 sts. and work stockinette st.

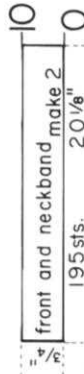
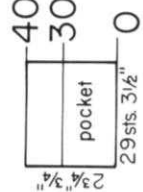

Cast on 195 sts. and work 10 rows K1, P1, Ribbing then bind off the crochet method for Ribbing.



Cast on 131 sts. and work 10 rows K1, P1, Ribbing, then bind off the crochet method for Ribbing.

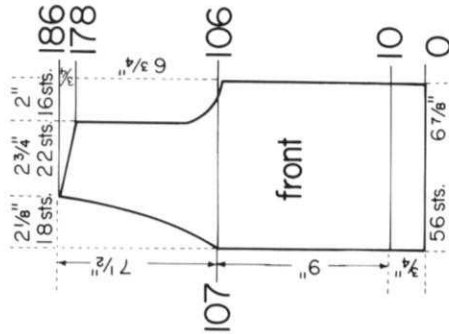

Work the left front section with reverse shapings, casting on from right to left.

Bind off 4 sts. after Rows 178, 180, 182 (EVEN ROWS = SHOULDER SHAPING) Decrease 1 st. after Row 183; Bind off 5 sts. after Rows 184, 186. Bind off 4 sts. after Row 106 (EVEN ROWS = ARMHOLE SHAPING); Full-fashion decrease (4th st. onto 3rd st.) 1 st. after Row 107 (ODD ROWS = FRONT SHAPING); Bind off 3 sts. after Rows 108, 110; Decrease 1 st. after Row 111; Bind off 2 sts. after Rows 112, 114; Decrease 1 st. after Row 115; Bind off 1 st. after Rows 116, 118 (last time for armhole) Decrease 1 st. after Rows 119, 123, 127, 131, 135, 139, 143, 147, 151, 155, 159, 165, 171, 177.

Rows 0 to 10, knit even, then change to stockinette st. and knit even to Row 106.

Cast on 56 sts. and work K1, P1, Ribbing.

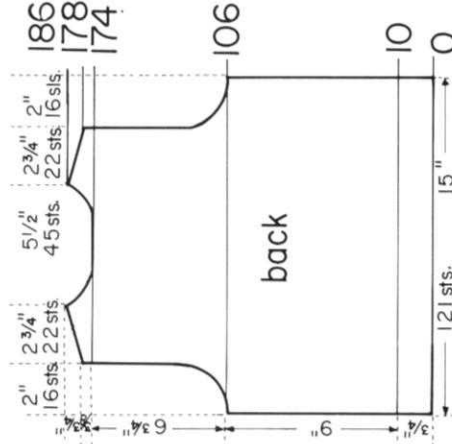

Now move the CAM BOX to the left side, turn Row Counter back to 174 and complete the left half. Follow instructions from *.

After Row 174 put 44 sts. on the left side into holding position and complete the right half. *Bind off 8 sts. (7 sts. for left half) after Row 175 (ODD ROWS = NECK SHAPING); 4 sts. after Row 177; 4 sts. after Row 178 (EVEN ROWS = SHOULDER SHAPING) 4 sts. after Rows 179, 180; 3 sts. after Row 181; 4 sts. after Row 182; 2 sts. after Row 183; 5 sts. after Row 184; 2 sts. after Row 185; 5 sts. after Row 186.

Bind off 4 sts. on CAM BOX SIDE after Rows 106, 107; 3 sts. after Rows 108, 109, 110, 111; 2 sts. after Rows 112, 113, 114, 115; 1 st. after Rows 116, 117, 118, 119, then knit even to Row 174.

Knit even to Row 106.

Rows 0 to 10 knit even then change to stockinette st.

Cast on 121 sts. and work K1, P1, Ribbing.

SIZE: 10-11 (Chest 28"-29") MATERIAL: 7 oz. (4 balls) turquoise KNITTING Subita Dralon 3-ply, Color No. 444. TENSION: KNITTING 4 to 6. STITCH GAUGE: 15 sts. 2". 22 Rows 2". PATTERN: Stockinette Stitch with Eyelet Design on Front Shoulders and Sleeves. EDGES and NECK-BAND: K1, P1, Ribbing.

The shoulders of the front section are shaped by knitting short rows before the Eyelet Design is worked. The Eyelet Design on the sleeves begins with Row 5 and ends after Row 24 of the chart.

FINISHING: Block all sections to measurements given. Join front and back section at sides and shoulders. Sew sleeves together and set in. Join short ends of neckband, then sew band to neckline.

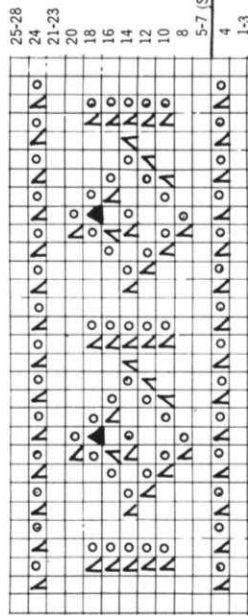
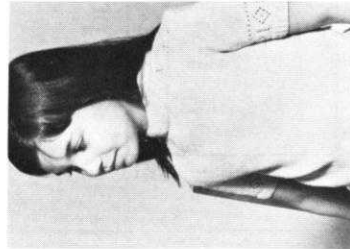

Bind off 3 sts. on CAM BOX SIDE after Rows 38, 39, 40, 41; 2 sts. after Rows 42, 43, 44, 45. ON EACH SIDE bind off 1 st. after Rows 46, 48, 50, 52, 54, 56, 58, 60, 62, 64, 66, 68, 70, 72, 74, 76, 78. Bind off 2 sts. on CAM BOX SIDE after Rows 80, 81, 82, 83; 3 sts. after Rows 84, 85; 10 sts. after Row 86.

Change to stockinette st. and work the Eyelet Design beginning the PATTERN at the underlined row of the chart. Increase 1 st. on CAM BOX SIDE after Rows 12, 13, 18, 19, 24, 25, 30, 31, then knit even to Row 38.

Row 0 to 12 knit even,

Cast on 70 sts. and work K1, P1, Ribbing.

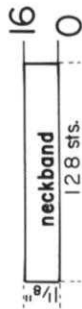
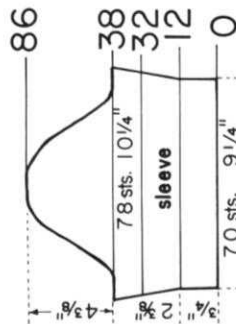

Cast on 128 sts. and work 16 rows K1, P1, Ribbing, then bind off the crochet method for Ribbing.

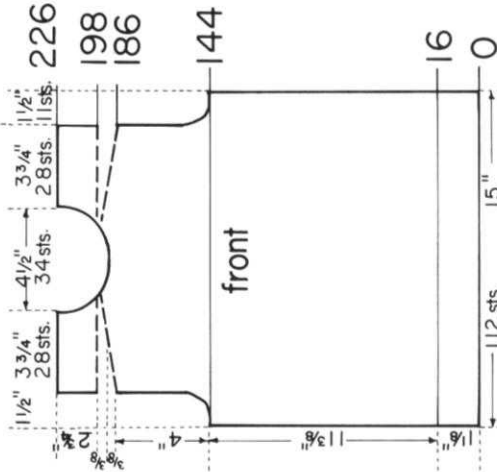
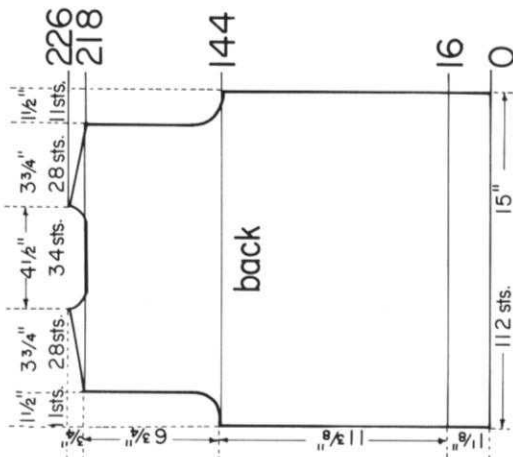

Move the Cam Box to the left side, turn Row Counter back to 218 and complete the left half. Follow instructions from *.

After Row 218, put 45 sts. on the left side into holding position and complete the right half. *Bind off 5 sts. on CAM BOX SIDE after Row 218 (EVEN ROWS = SHOULDER SHAPING); 6 sts. after Row 219 (ODD ROWS = NECK SHAPING); 5 sts. after Row 220; 4 sts. after Row 221; 6 sts. after Row 222; 4 sts. after Row 223; 6 sts. after Row 224; 3 sts. after Row 225; 6 sts. after Row 226.

Bind off 3 sts. on CAM BOX SIDE after Rows 144, 145, 146, 147; 2 sts. after Rows 148, 149; 1 st. after Rows 150, 151, 152, 153, 154, 155, then knit even to Row 218.

Change to stockinette st. and knit even to Row 144.

Rows 0 to 16 knit even.

Cast on 112 sts. and work K1, P1, Ribbing.

Move the Cam Box to the left side, turn Row Counter back to 198, bring the needles into working position and complete the left half. Follow the instructions from *.

After Row 198 put 45 sts. on the left side into holding position and complete the right half first. *Work the EYELET DESIGN for the next 28 rows AND bind off 6 sts. after Row 199 (ODD ROWS = NECK SHAPING); 3 sts. after Row 201; 2 sts. after Rows 203, 205; 1 st. after Rows 207, 209, 211, 213, then knit even to Row 226 and bind off the sts.

OPPOSITE CAM BOX, put 5 needles into holding position after Rows 186, 187, 188, 189; 6 needles after Rows 190, 191, 192, 193, 194, 195. Bring all needles opposite Cam Box back into working position after Rows 196, 197.

Bind off 3 sts. on CAM BOX SIDE after Rows 144, 145, 146, 147; 2 sts. after Rows 148, 149; 1 st. after Rows 150, 151, 152, 153, 154, 155, then knit even to Row 186.

Change to stockinette st. and knit even to Row 144.

Rows 0 to 16 knit even.

Cast on 112 sts. and work K1, P1, Ribbing.

A complete fifth volume of KNITTING MAGAZINES with a flexible, transparent plastic cover and specially bound so that it will stay open at any page, is available at the special price of \$6.95 (plus 85 cents mailing costs).

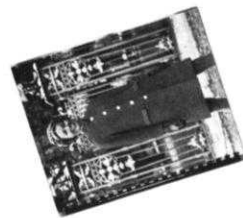

If purchased separately the magazines would cost a total of \$9.00.

The volume contains over 120 fully illustrated complete stylish patterns for all members of the family, together with many valuable, practical knitting hints.

There is a very limited number of these volumes available and it will undoubtedly become a collectors item.

If you already have the entire set it will almost certainly be well thumbed and marked. Why not purchase a perfect mint condition volume for your bookshelf and ready reference at any time.

• • •

Place your order today and avoid disappointment. Send it to **KNITTING MAGAZINE, 1128 Crenshaw Boulevard, Los Angeles, California 90019.**

MK 5084

SIZE: 7-8 (Chest 25"-26") **MATERIAL:** 7 oz. (4 balls) blue and 1 1/2 oz. (1 ball) white **KNITTING** Subita Crepe 2 x 3, Color Nos. 137 and 104 **TENSION:** KNITTING 3 to 5, **STITCH GAUGE:** Stockinette Stitch with Eyelet Design 16 sts. 2", 25 rows 2". Plain Stockinette Stitch 17 sts. 2", 25 rows 2". **PATTERN:** Stockinette Stitch with Eyelet Design. **EDGES:** K1, P1, Ribbing. Collar and Band: Stockinette Stitch.

There are 7 Eyelet Stripes in the front and back sections. Begin Eyelets on the front and back section by hanging the 8th st. counting from the right side onto the 9th st., then follow the Chart. There are 4 Eyelet Stripes in the Sleeves. Begin the Eyelets on the sleeves by hanging the 11th st. counting from the right side onto the 12th st. then follow the chart. The decreases for the front opening shaping and the increases for the sleeves are full-fashion.



FINISHING: Block all sections to measurements given. Join front and back section at sides and shoulders. Sew sleeves together and set in. Weave band to front opening, 1 st. in on each edge, then turn under half and hem on wrong side against seam. Fold collar in half and sew ends. Sew 1 edge of collar to inside and 1 edge of collar to outside of neckline. Work a loop on the right side and sew a button to the left side of opening.

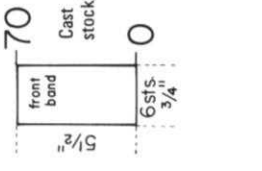
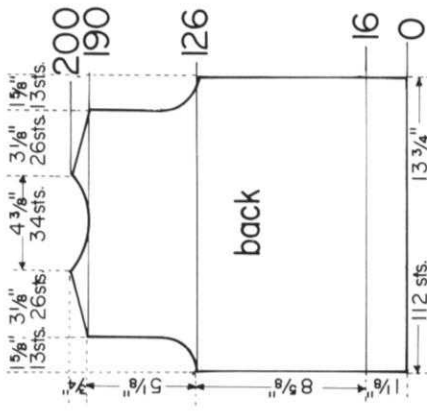

Move the CAM BOX to the left side, turn the Row Counter back to 190 and complete the left half. Follow instructions from *.

After Row 190 put 43 sts. on the left side into holding position and complete the right half. *Bind off 4 sts. after Row 190 (EVEN ROWS = SHOULDER SHAPING); 6 sts. after Row 191 (ODD ROWS = NECK SHAPING); 4 sts. after Rows 192, 193, 194, 195, 196; 3 sts. after Row 197 (last time for Neck shaping); 5 sts. after Rows 198, 200. Bind off 4 sts. on CAM BOX SIDE after Rows 126, 127; 3 sts. after Rows 128, 129; 2 sts. after Rows 130, 131, 132, 133; 1 st. after Rows 134, 135, 136, 137, then knit even to Row 190.

Change to stockinette stitch and work the Eyelet Design and knit even to Row 126. Rows 0 to 16 knit even. Cast on 112 sts. and work K1, P1, Ribbing.

Bind off 3 sts. on CAM BOX SIDE after Rows 30, 31; 2 sts. after Rows 32, 33, 34, 35, 36, 37; 1 st. ON EACH SIDE after Rows 38, 40, 42, 44, 46, 48, 50, 52, 54, 56, 58, 60, 62, 64, 66, 68; 2 sts. ON CAM BOX SIDE after Rows 70, 71; 3 sts. after Rows 72, 73, 74, 75; 10 sts. after Row 76.

Change to Stockinette Stitch and work the Eyelet Design. ON EACH SIDE Full-fashion increase (between 2nd-3rd sts.) 1 st. after Rows 12, 18, 24, then knit even to Row 30. Rows 0 to 10 knit even. Cast on 70 sts. and work K1, P1, Ribbing.

0	1	2	3	4	5	6	7	8	9	10	11
0	1	2	3	4	5	6	7	8	9	10	11
0	1	2	3	4	5	6	7	8	9	10	11
0	1	2	3	4	5	6	7	8	9	10	11
0	1	2	3	4	5	6	7	8	9	10	11
0	1	2	3	4	5	6	7	8	9	10	11

Move the Cam Box to the left side, turn Row Counter back to 136 and complete the left half. Follow instructions from *.

Bind off 4 sts. after Rows 190, 192, 194, 196 (EVEN ROWS = SHOULDER SHAPING); 5 sts. after Rows 198, 200. Bind off 5 sts. after Row 171 (ODD ROWS = NECK SHAPING); 3 sts. after Row 173; 2 sts. after Rows 175, 177; 1 st. after Rows 179, 181, 183, then knit even to Row 190.

After Row 136 put 44 sts. on the left side into holding position and complete the right half. *Bind off 1 st. after Row 136 (last time for Armhole). Full-fashion decrease (3rd st. onto 2nd st.) 1 st. ON CAM BOX SIDE after Rows 137, 139, then knit even to Row 171.

Bind off 4 sts. on CAM BOX SIDE after Rows 126, 127; 3 sts. after Rows 128, 129; 2 sts. after Rows 130, 131, 132, 133; 1 st. after Rows 134, 135.

Change to stockinette st., work the Eyelet Design and knit even to Row 126. Rows 0 to 16 knit even.

Cast on 112 sts. and work K1, P1, Ribbing.

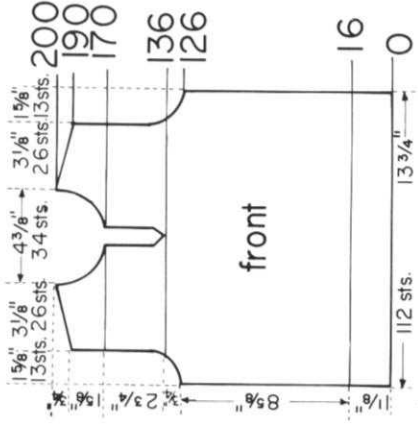

Cast on 6 sts. with white and work 70 rows stockinette st. then bind off.

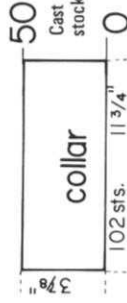

Cast on 102 sts. with white and work 50 rows stockinette st., then bind off.

HP 3590

SIZE: 40/42. **MATERIAL:** 23 1/2 oz. (13 balls) dark blue **KNITTING** Subita Crepe 2 x 4, Color No. 1. **TENSION:** KNITTING 5 to 7. **STITCH GAUGE:** 17 sts. 2", 22 rows 2". **PATTERN STITCH:** Stockinette Stitch.

Of the front sections, the left section is shown and knitted first. The Buttonholes are marked in this section. The increases on the sleeves are made full-fashion.

FINISHING: Block all sections to measurements given. Join front and back sections at sides and shoulders. Sew sleeves together and set in. Weave open sts. on center back facing together, then sew facing to neckline. Turn under 14 sts. around fronts and neckline and hem to wrong side. Turn under 15 rows on lower edge and sleeve edges and hem to wrong side. Turn under 3/4" on upper pockets and hem. Sew pockets to Cardigan (see picture). Finish buttonholes, sew on buttons.



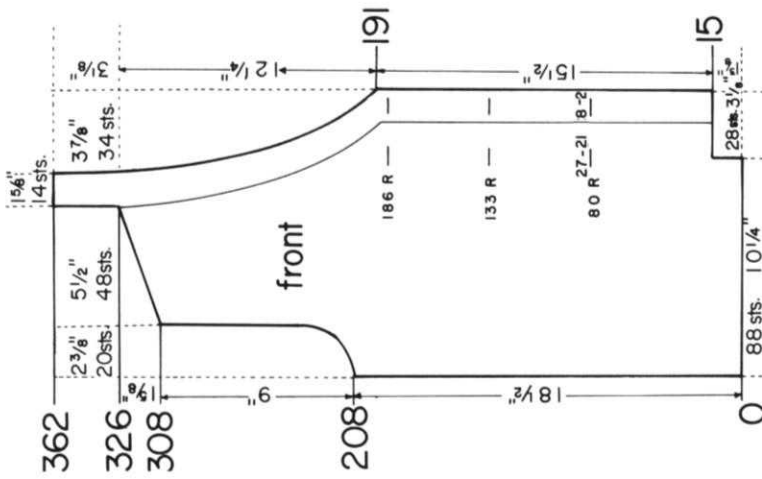

Work the second front section with reverse shapings, casting on from left to right and omit the buttonholes.

Knit even over 14 sts. to Row 362, then put the sts. on a stitch holder.

Bind off 4 sts. after Rows 308, 310 (EVEN ROWS = SHOULDER SHAPING) 1 st. after Row 311 (FRONT SHAPING); 5 sts. after Rows 312, 314, 316, 318, 320, 322, 324, 326.

Bind off 4 sts. after Row 208 (EVEN ROWS = ARMHOLE SHAPING); 1 st. after Row 209 (ODD ROWS = FRONT SHAPING); 3 sts. after Row 210; 1 st. after Row 211; 3 sts. after Row 212; 1 st. after Row 213; 2 sts. after Rows 214, 216; 1 st. after Row 217; 2 sts. after Row 218; 1 st. after Rows 220, 221, 222, 224, 225, 226; 1 st. after Rows 229, 233, 237, 241, 245, 249, 253, 257, 261, 265, 269, 273, 277, 281, 287, 293, 299, 305.

Full-fashion decrease (30 st. onto 29th st. counting from the right side) for FRONT SHAPING, 1 st. after Rows 191, 193, 195, 197, 199, 201, 203, 205, 207.

Make 2 buttonholes after Rows 80, 133 and 186 over the sts. indicated on the diagram. Knit to Row 191.

Row 0 to 15 knit even, then cast on 28 sts. on CAM BOX SIDE.

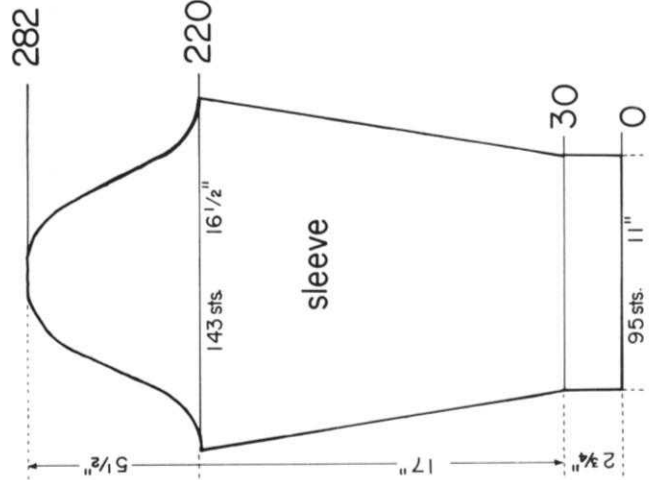

Bind off 5 sts. on CAM BOX SIDE after Rows 220, 221; 4 sts. after Rows 222, 223; 3 sts. after Rows 224, 225, 226, 227, 228, 229; 2 sts. after Rows 230, 231, 232, 233, 234, 235; 1 st. after Rows 236, 237, 238, 239; 2 sts. after Row 240, 241; 1 st. after Rows 242, 243, 244, 245; 2 sts. after Rows 246, 247; 1 st. after Rows 248, 249, 250, 251; 2 sts. after Rows 252, 253; 1 st. after Rows 254, 255, 256, 257; 2 sts. after Rows 258, 259; 1 st. after Rows 260, 261, 262, 263; 2 sts. after Rows 264, 265; 1 st. after Rows 266, 267, 268, 269; 2 sts. after Rows 270, 271, 272, 273, 274, 275; 3 sts. after Rows 276, 277; 4 sts. after Rows 278, 279; 5 sts. after Rows 280, 281; 15 sts. after Row 282.

ON EACH SIDE Full-fashion increase 1 st. after Rows 30, 38, 46, 54, 62, 70, 78, 86, 94, 102, 110, 118, 126, 134, 142, 150, 158, 166, 174, 182, 190, 198, 206, 214.

Rows 0 to 30 knit even.

Cast on 95 sts. and work stockinette stitch.

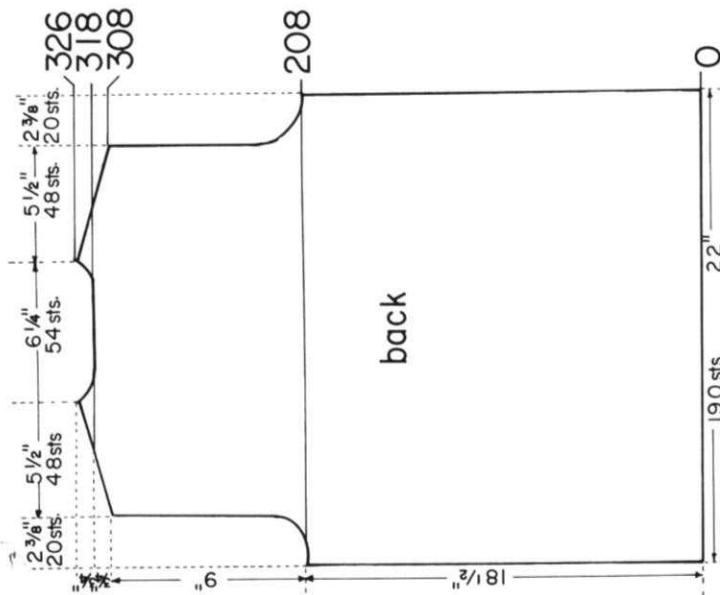

Move the Cam Box to the left side, turn Row Counter back to 318, bring needles on left side into working position and complete left half. Follow instructions from *.

After Row 318 put 52 sts. on the left side into holding position and complete the right half first. *Bind off 5 sts. after Row 318 (EVEN ROWS = SHOULDER SHAPING); 12 sts. after Row 319 (ODD ROWS = NECK SHAPING) 5 sts. after Row 320; 8 sts. after Row 321; 5 sts. after Row 322; 4 sts. after Row 323; 5 sts. after Row 324; 3 sts. after Row 325; 5 sts. after Row 326.

Bind off 4 sts. on CAM BOX SIDE for SHOULDERS after Rows 308, 309, 310, 311; 5 sts. after Rows 312, 313, 314, 315, 316, 317.

Bind off 4 sts. on CAM BOX SIDE after Rows 208, 209; 3 sts. after Rows 210, 211, 212, 213; 2 sts. after Rows 214, 215, 216, 217, 218, 219; 1 st. after Rows 220, 221, 222, 223, 224, 225, 226, 227, then knit even to Row 308.

Rows 0 to 208 knit even.

Cast on 190 sts. and work stockinette stitch.

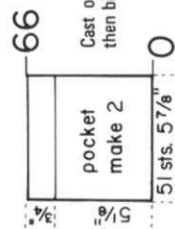

DK 7785

SIZE: 10/12. **MATERIAL:** 21 oz. (12 balls) turquoise **KNITTING** Subita Crepe 2 x 4, Color No. 45 and 1 1/2 yards Taffeta for facing the edges. **TENSION:** KNITTING 6 to 8. **STITCH GAUGE:** 16 sts. 2", 22 rows 2". **PATTERN:** Stockinette stitch.

ALL decreases of 1 st. are made full-fashion by hanging the 3rd st. on the appropriate side onto the 2nd st. then moving the end sts. inward to fill the empty needle. (Side Seam, Front Edge, Armhole and Neckline). The increases after ROW 268 (Side seam) are full-fashion and are made by moving the 2 end sts. on the appropriate side 1 needle outward, then placing the 3rd st. from the row below onto the empty needle. Because of the front decreases, the Buttonholes are NOT directly above each other but are always made over the 14th to 18th sts.

FINISHING: Block all sections to measurements given. Weave front and back sections together at sides, 1 st. in on each edge, easing in the fullness at bustline of front sections. Join shoulders (back stitch). Turn under a small amount on ALL edges and hem to wrong side. Finish all edges with Taffeta 2 1/2" wide. Turn under 10 rows on upper pocket edges, then sew pockets to Jumper (see picture). Finish buttonholes, sew on buttons.

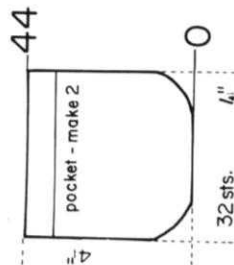
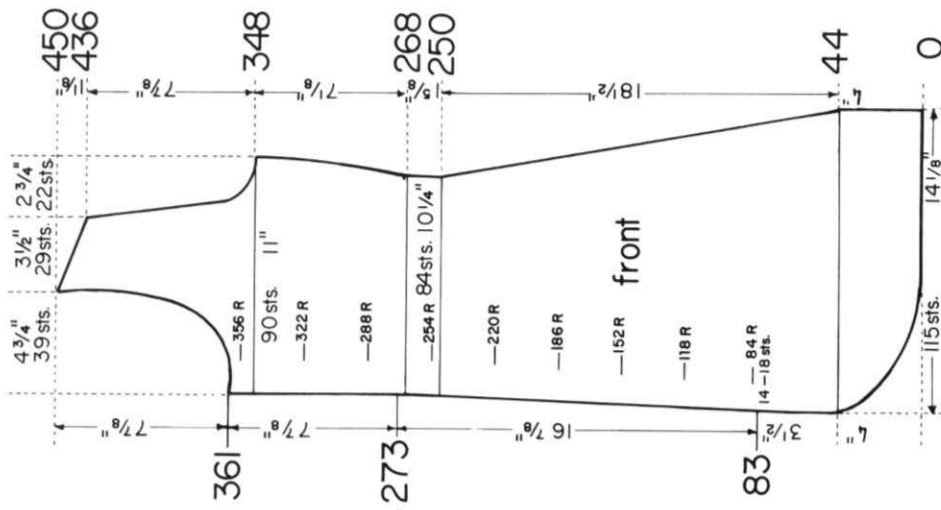
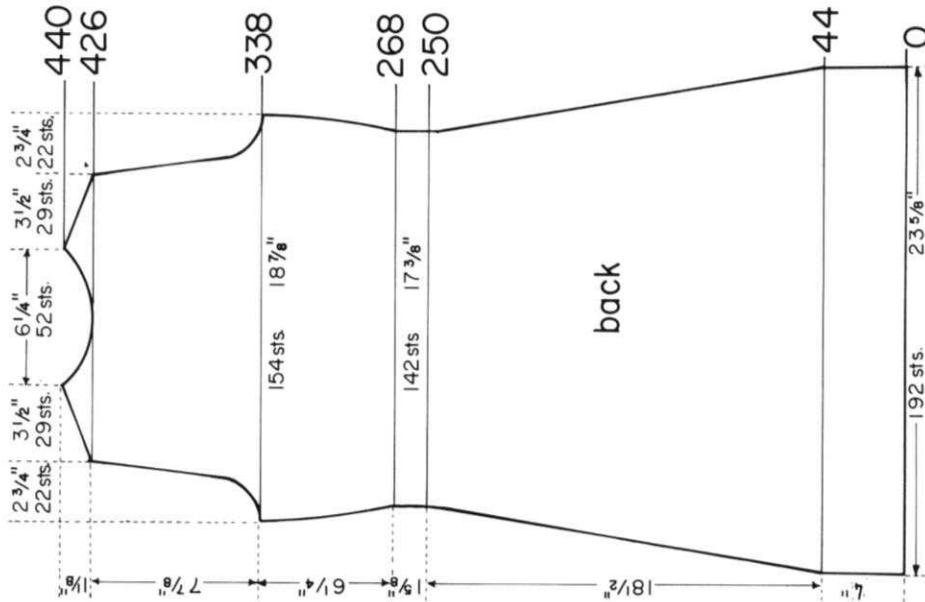
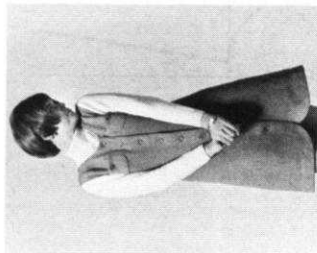

Work the left front section with reverse shapings, casting on from right to left. Omit the Buttonholes.

Bind off 3 sts. after Rows 436, 438, 440 (EVEN ROWS = SHOULDER SHAPING); 4 sts. after Rows 442, 444, 446, 448, 450.

Bind off 4 sts. after Rows 348, 350, (EVEN ROWS = ARMHOLE SHAPING; 3 sts. after Row 352; 2 sts. after Rows 354, 356 and make buttonhole after Row 356; 1 st. after Rows 358, 360; 13 sts. after Row 361 (ODD ROWS = NECK SHAPING); 3 sts. after Rows 363, 365; 2 sts. after Rows 367, 369, 371; 1 st. after Rows 372, 373, 375, 377, 379, 381, 384, 385, 389, 393, 396, 397, 401, 405, 408, 409, 413, 417, 420, then knit even to Row 436.

Full-fashion increase (between 2nd-3rd sts.) 1 st. after Row 268; decrease 1 st. after Row 273 (last decrease front); increase on 1 st. after Row 280 and make Buttonhole after Row 288; 1 st. after Rows 292, 304, 316 and make Buttonhole after Row 322; 1 st. after Row 328 (last increase for side seam) then knit even to Row 348.

Make Buttonhole after Row 254 then knit even to Row 288.

Full-fashion decrease (3rd st. onto 2nd st.) 1 st. after Rows 46, 56, 66, 76 (EVEN ROWS = SIDE SEAM SHAPING); 1 st. after Row 83 (ODD ROWS = FRONT SHAPING); make Buttonhole after Row 84 (always over the 14th-18 sts. counting from the left side). Decrease 1 st. after Rows 86, 96, 106, 114 and make Buttonhole after Row 118; 1 st. after Rows 121, 122, 130, 138, 146 and make Buttonhole after Row 152; 1 st. after Rows 154, 159, 162, 170, 178, 186 and make Buttonhole after Row 186; 1 st. after Rows 194, 197, 202, 210, 218, and make Buttonhole after Row 220; 1 st. after Rows 226, 234, 235, 242, 250.

Rows 0 to 44: Put 51 needles opposite CAM BOX into holding position and knit 2 rows. Bring 5 needles opposite CAM BOX back into work after Rows 2, 4, 6; 4 needles after Rows 8, 10; 3 needles after Rows 12, 14, 16; 2 needles after Rows 18, 20, 22, 24, 26; 1 needle after Rows 28, 30, 32, 34, 36, 38, 40, 42, 44.

Cast on 115 sts. and work Short Rows.

Rows 0 to 12 put 7 needles opposite CAM BOX into holding position, knit 1 row, put 7 needles opposite CAM BOX into holding position and knit 1 row. Bring 2 needles opposite CAM BOX back into work after Rows 2, 3, 4, 5; 1 st. after Rows 6, 7, 8, 9, 10, 11. After Row 12 knit even to Row 44, then bind off all sts.

Cast on 32 sts. and work Short Rows.

Move the Cam Box to the left side, turn the Row Counter back to 426 and complete the left half. Follow the instructions from *.

After Row 426 put 55 sts. on the left side into holding position and complete the right half. *Bind off 3 sts. after Row 426 (EVEN ROWS = SHOULDER SHAPING); 9 sts. after Row 427 (ODD ROWS = NECK SHAPING); 3 sts. after Row 428; 5 sts. after Row 429; 3 sts. after Row 430; 4 sts. after Rows 431, 432, 433, 434; 2 sts. after Row 435; 4 sts. after Row 436; 2 sts. after Row 437; 4 sts. after Rows 438, 440.

Bind off 4 sts. on CAM BOX SIDE after Rows 338, 339, 340, 341; 3 sts. after Rows 342, 343; 2 sts. after Rows 344, 345, 346, 347. ON EACH SIDE Full-fashion decrease 1 st. after Rows 348, 350, 362, 374, 386, 398, 410, then knit even to Row 426.

ON EACH SIDE, Full-fashion increase (between 2nd-3rd sts.) 1 st. after Rows 268, 280, 292, 304, 316, 328, then knit even to Row 338.

Knit even to Row 268.

ON EACH SIDE Full-fashion decrease (3rd st. onto 2nd st.) 1 st. after Rows 46, 56, 66, 76, 86, 96, 106, 114, 122, 130, 138, 146, 154, 162, 170, 178, 186, 194, 202, 210, 218, 226, 234, 242, 250.

Rows 0 to 44 knit even.

Cast on 192 sts.

SIZE: 38/40. MATERIAL: 38½ oz. (22 balls) brown KNITTING Subita Crepe 2 x 4, Color No. 27. TENSION: KNITTING 5 to 7. STITCH GAUGE: PATTERN STITCH 16 sts. 2", 24 rows 2". STOCKINETTE STITCH 15 sts. 2", 22 rows 2". PATTERN: PULLOVER: Front and back sections, sleeve edges and collar: Purl 3, knit 1 Ribbing. Sleeves Stockinette stitch. JACKET: Lower edge and sleeves: Purl 3, Knit 1 Ribbing. Bodice: Stockinette Stitch. All sections are worn on the purl side.

FINISHING: Block all sections to measurements given. PULLOVER: Join front and back section at sides and shoulders. Sew sleeves together and set in. Join short ends of collar. Sew 1 long edge of collar to inside and 1 long edge to outside of neckline.

JACKET: Join front and back sections at sides and shoulders. Sew sleeves together and set in. Weave open sts. of neck facing together and sew facing to neckline. Turn under 9 sts. around fronts, turn under facing and hem to wrong side. Finish buttonholes, sew on buttons.

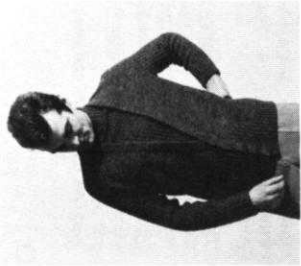
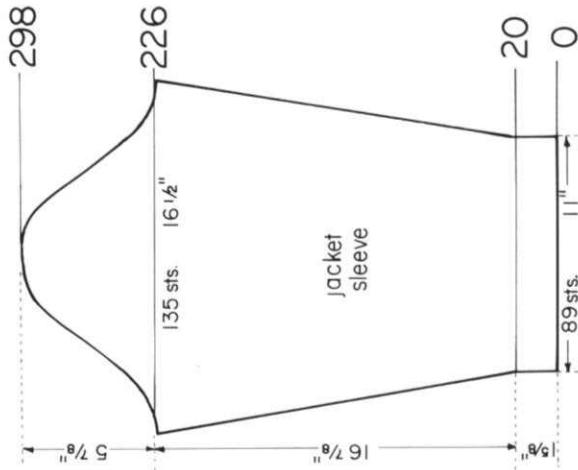
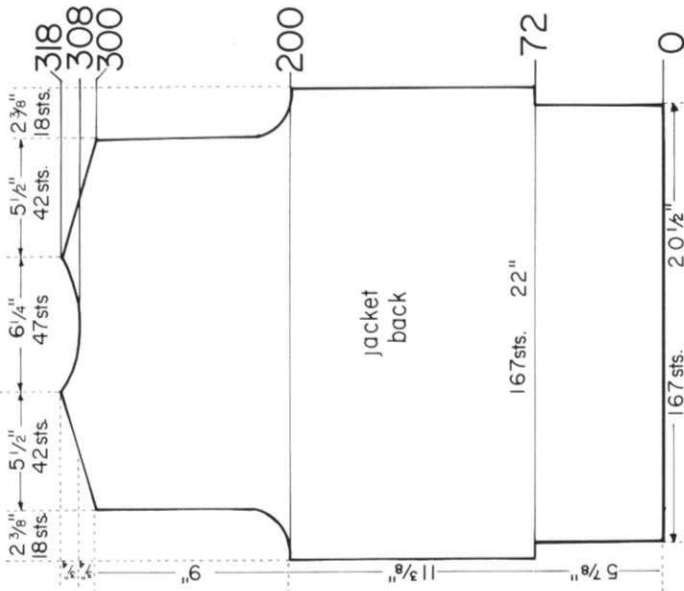
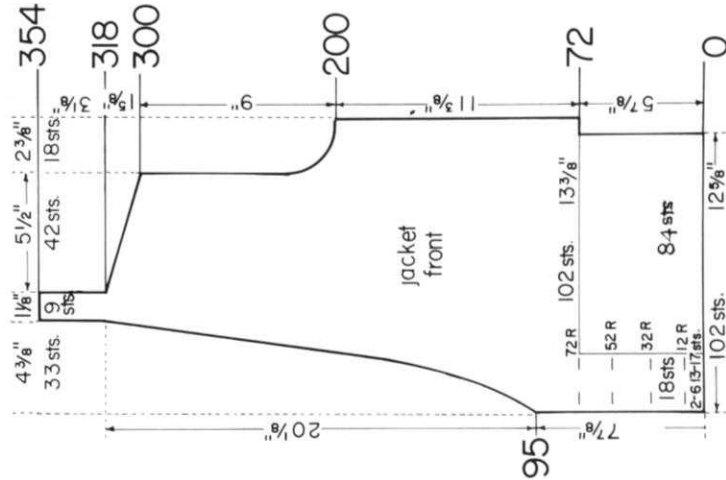
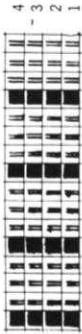

Work the right front section with reverse shapings, casting on from right to left, knitting 72 rows over the 84 sts. on the left side in PATTERN STITCH and over 18 sts. on the right side in Stockinette st. Omit the buttonholes.

Knit even over 9 sts. to Row 354 and put the 9 sts. on a stitch holder.

Bind off 4 sts. after Rows 300, 302, 304, 306 (EVEN ROWS = SHOULDER SHAPING); 1 st. after Row 307 (last time for front); 4 sts. after Rows 308, 310, 312, 314; 5 sts. after Rows 316, 318.

Bind off 6 sts. after Row 200 (EVEN ROWS = ARMHOLE SHAPING); 3 sts. after Row 202; 1 st. after Row 203 (ODD ROWS = FRONT SHAPING); 3 sts. after Row 204; 2 sts. after Rows 206, 208; 1 st. after Rows 209, 210, 212, (last time for Armhole), 215, 221, 227, 235, 243, 251, 259, 267, 275, 283, 291, 299.

ON CAM BOX SIDE, Full-fashion decrease (the 20th st. onto the 19th st.) 1 st. after Rows 95, 101, 107, 113, 119, 125, 131, 137, 143, 149, 155, 161, 167, 173, 179, 185, 191, 197, then knit to Row 200.

After Row 72 continue over all sts. with stockinette st. and knit even to Row 95.

Rows 0 to 72: Make Buttonholes after Rows 12, 32, 52, 72 over the sts. indicated.

Cast on 102 sts. and work 84 sts. on the right side in PATTERN STITCH and 18 sts. on the left side in STOCKINETTE STITCH.

Move the CAM BOX to the left side, turn Row Counter back to 308 and complete the left half. Follow instructions from *.

After Row 308 put 49 sts. on the left side in holding position and complete the right half first. *Bind off 4 sts. after Row 308, (EVEN ROWS = SHOULDER SHAPING) 9 sts. (8 sts. for left half) after Row 309; (ODD ROWS = NECK SHAPING); 4 sts. after Row 310; 5 sts. after Row 311; 4 sts. after Row 312; 5 sts. after Row 313; 4 sts. after Row 314; 3 sts. after Row 315; 5 sts. after Row 316; 2 sts. after Row 317; 5 sts. after Row 318.

Bind off 4 sts. on CAM BOX SIDE for SHOULDERS after Rows 300, 301, 302, 303, 304, 305, 306, 307.

Bind off 6 sts. on CAM BOX SIDE after Rows 200, 201; 3 sts. after Rows 202, 203, 204, 205; 2 sts. after Row 206, 207, 208, 209; 1 st. after Rows 210, 211, 212, 213; then knit even to Row 300.

Change to stockinette st. and knit even to Row 200.

Rows 0 to 72 knit even.

Cast on 167 sts. and work in PATTERN STITCH.

Bind off 6 sts. on CAM BOX SIDE after Row 226, 227; 3 sts. after Rows 228, 229, 230, 231, 232, 233; 2 sts. after Rows 234, 235, 236, 237, 238, 239; 1 st. ON EACH SIDE after Rows 240, 242, 244, 246, 248, 250, 252, 254, 256, 258, 260, 262, 264, 266, 268, 270, 272, 274, 276, 278, 280, 282, 284, 286; 2 sts. ON CAM BOX SIDE after Rows 288, 289, 290, 291; 3 sts. after Rows 292, 293, 294, 295; 5 sts. after Rows 296, 297; 15 sts. after Row 298.

ON EACH SIDE Full-fashion increase (between 1st-2nd sts.) 1 st. after Rows 20, 28, 36, 44, 52, 60, 68, 76, 84, 92, 100, 108, 116, 126, 136, 146, 156, 166, 176, 186, 196, 206, 216, then knit even to Row 226.

Rows 0 to 20 knit even.

Cast on 89 sts. and work in PATTERN STITCH.

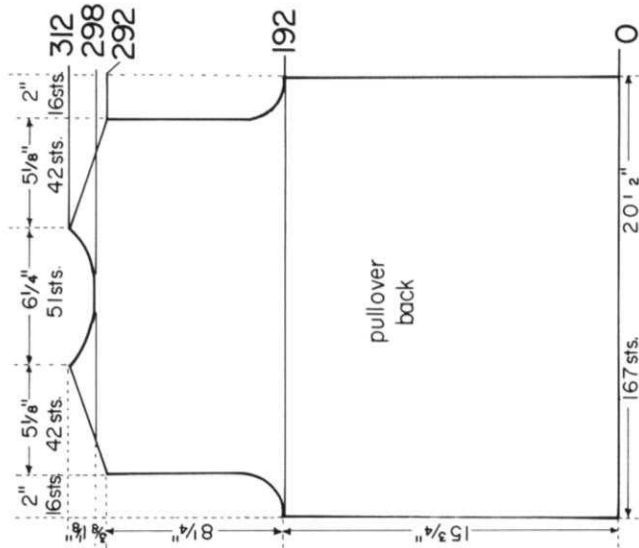
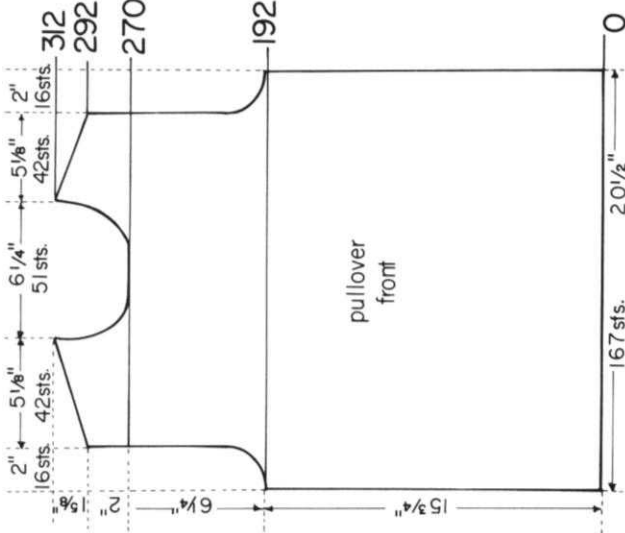

Move the CAM BOX to the left side, turn Row Counter back to 270 and complete the left half. Follow instructions from *.

Bind off 3 sts. after Rows 292, 294, (EVEN ROWS = SHOULDER SHAPING); 4 sts. after Rows 296, 298, 300, 302, 304, 306, 308, 310, 312.

After Row 270 put 67 sts. on the left side into holding position (transfer the ribber sts. first) and complete the right half first. *Bind off 8 sts. (7 sts. for left half) after Row 271 (ODD ROWS = NECK SHAPING); 4 sts. after Rows 273, 275; 2 sts. after Rows 277, 279, 281; 1 st. after Rows 283, 285, 287, 289 then knit even on neck side.

Bind off 4 sts. on CAM BOX SIDE after Rows 192, 193; 3 sts. after Rows 194, 195, 196, 197; 2 sts. after Rows 198, 199, 200, 201; 1 st. after Rows 202, 203, 204, 205, then knit even to Row 270.

Rows 0 to 192 knit even.

Cast on 167 sts. and work in PATTERN STITCH.

Move the Cam Box to the left side, turn Row Counter back to 298 and complete the left half. Follow instructions from *.

After Row 298 put 57 sts. on the left side into holding position (be sure to transfer Ribber sts. first) and complete the right half. *Bind off 4 sts. after Row 298 (EVEN ROWS = SHOULDER SHAPING); 10 sts. (9 sts. for left half) after Row 299 (ODD ROWS = NECK SHAPING); 4 sts. after Row 300; 8 sts. after Row 301; 4 sts. after Rows 302, 303, 304, 305 (last time for Neck), 306, 308, 310, 312.

Bind off 3 sts. on CAM BOX SIDE for Shoulders after Rows 292, 293, 294, 295; 4 sts. after Rows 296, 297.

Bind off 4 sts. on CAM BOX SIDE after Rows 192, 193; 3 sts. after Row 194, 195, 196, 197; 2 sts. after Rows 198, 199, 200, 201; 1 st. after Rows 202, 203, 204, 205, then knit even to Row 292.

Rows 0 to 192 knit even.

Cast on 167 sts. and work in PATTERN STITCH.

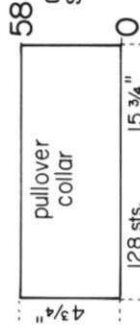
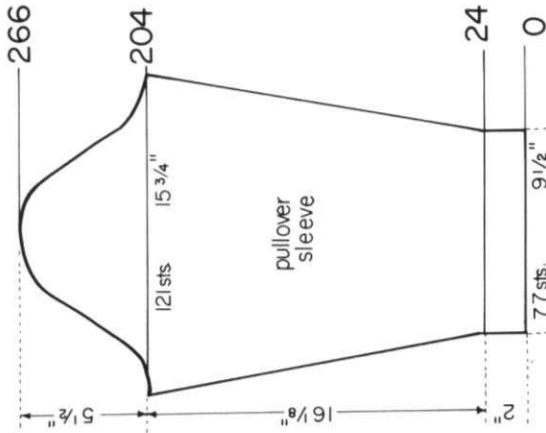

Cast on 128 sts. and work 58 rows in PATTERN STITCH, then bind off the crochet method.

Bind off 4 sts. on CAM BOX SIDE after Rows 204, 205, 206, 207; 3 sts. after Rows 208, 209, 210, 211; 2 sts. after Rows 212, 213, 214, 215, 216, 217; 1 st. ON EACH SIDE after Rows 218, 220, 222, 224, 226, 228, 230, 232, 234, 236, 238, 240, 242, 244, 246, 248, 250, 252, 254, 256; 2 sts. ON CAM BOX SIDE after Rows 258, 259; 3 sts. after Rows 260, 261; 4 sts. after Rows 262, 263, 264, 265; 15 sts. after Row 266.

ON EACH SIDE Full-fashion increase 1 st. after Rows 24, 32, 40, 48, 56, 64, 72, 80, 88, 96, 104, 112, 120, 128, 136, 144, 152, 160, 168, 176, 184, 192 then knit even to Row 204.

Rows 0 to 24 work even, then change to stockinette st.

Cast on 77 sts. and work in PATTERN STITCH.

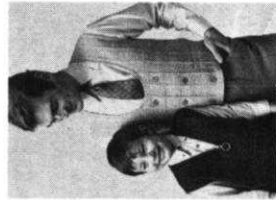

HP 3581

SIZE: 38/40. MATERIAL: 14 oz. (8 balls) beige KNITTING Subita Crepe 2 x 4, Color No. 34. TENSION: KNITTING 5 to 7. STITCH GAUGE: PATTERN STITCH 16 sts. 2", 30 rows 2". PATTERN: Holding Position Design according to chart, worn on the purl side.

The Gate Cam Release Lever of the Ribber is placed at the needle heels. Cast on as for stockinette st., then transfer the appropriate sts. to the Ribber.

FINISHING: Block all sections to measurements given. Join back and front sections at sides and shoulders. Turn under 1/2" around neckline and armholes and hem to wrong side. Turn under 12 Rows on Lower edge and hem to wrong side. Turn under 14 sts. on each front edge, matching first set of buttonholes and hem to wrong side. Sew Pockets to Vest. Finish buttonholes and sew on buttons.

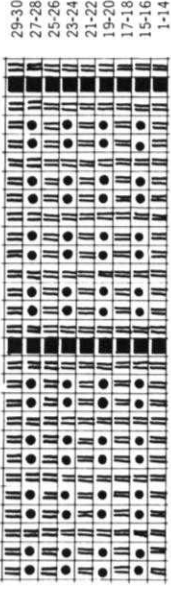

Leaving CAM BOX on RIGHT SIDE, bring needles on left side back into working position (IN PATTERN) and complete left half. (Turn Row Counter to 329 and knit to left side, then follow instructions from *.

After Row 330 put 57 sts. on the left side into holding position (Transfer Ribber sts. first) and complete the right half. *Bind off 2 sts. after Row 330 (EVEN ROWS = SHOULDER SHAPING); 9 sts. (8 sts. for left half) after Row 331 (ODD ROWS = NECK SHAPING); 3 sts. after Row 332; 6 sts. after Row 333; 3 sts. after Row 334; 6 sts. after Row 335; 3 sts. after Row 336; 4 sts. after Row 337; 3 sts. after Row 338; 2 sts. after Row 339; 3 sts. after Row 340; 2 sts. after Row 341; 3 sts. after Rows 342; 344, 346, 348.

Bind off 2 sts. on CAM BOX SIDE after Rows 324, 325, 326, 327, 328, 329.
Bind off 6 sts. on CAM BOX SIDE after Rows 192, 193; 5 sts. after Rows 194, 195, 196, 197; 2 sts. after Rows 198, 199, 200, 201; 1 st. after Rows 202, 203, then knit even to Row 324.

Increase 1 st. on CAM BOX SIDE after Rows 72, 73, 102, 103, 132, 133, 162, 163, then knit even to Row 192.

Rows 0 to 72 knit even.

Cast on 161 sts. and work in PATTERN STITCH.

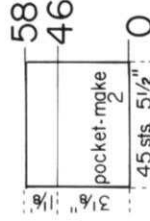
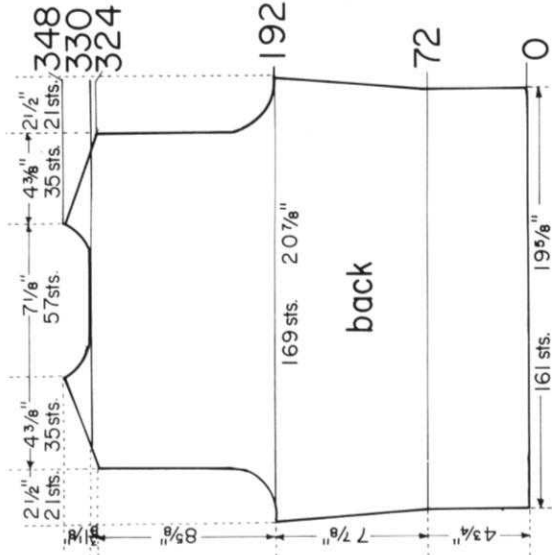

Change to K1, P1, Ribbing. After Row 58, bind off the crochet method for Ribbing.

Cast on 45 sts. and work in PATTERN STITCH to Row 46.

Work the second front section with reverse shapings and omit buttonholes. To follow instructions exactly, cast on the normal way, then knit 1 row from right to left and turn Row Counter to 0.

Bind off 2 sts. on CAM BOX SIDE after Rows 324, 326, 328, 330; 3 sts. after Rows 332, 334, 336, 338, 340, 342, 344, 346, 348.

Bind off 6 sts. after Row 192 (EVEN ROWS = ARMHOLE SHAPING); 1 st. after Row 193; 5 sts. after Row 194; 1 st. after Row 195; 5 sts. after Row 196; 1 st. after Row 197; 2 sts. after Rows 198, 200; 1 st. after Rows 201, 202, 205, 209, 213, 217, 221, then knit even to Row 324.

Increase 1 st. on CAM BOX SIDE after Rows 72, (Buttonholes, Row 94) 102, 132, (Buttonholes, Row 154) 162, then knit even to Row 181. Bind off 41 sts. on CAM BOX SIDE after Row 181 (ODD ROWS = FRONT SHAPING); 4 sts. after Row 183; 3 sts. after Rows 185, 187; 2 sts. after Rows 189, 191.

Rows 0 to 72: After Row 12, cast on 27 sts. on opposite side of CAM BOX. Make 3 Buttonholes after Row 34 over the sts. marked, then knit even to Row 72.

Cast on 89 sts. and work in PATTERN STITCH.

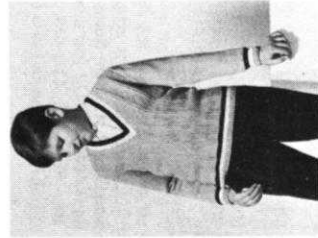
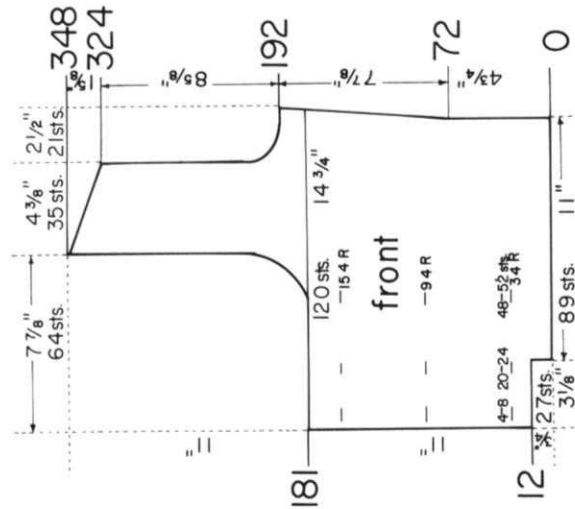

SIZE: 13-14 (Chest 31"-32") MATERIAL: 14 oz. (8 balls) light blue, 1 1/2 oz. (1 ball) white and 1 1/2 oz. (1 ball) dark blue KMITTING Subita Crepe 2 x 3, Color No. 103, No. 104, and No. 101. TENSION: KMITTING 3 to 5. STITCH GAUGE: Stockinette Stitch 17 st. 2", 25 rows 2". PATTERN: Stockinette Stitch after Rows 252, 253; 4 sts. after Rows 254, 255; 5 sts. after Rows 256, 257; 12 sts. after Row 258.

The Gate Cam Release Lever on the Ribber is placed at the needle heels. Set up Pattern according to chart manually, then change the needle position after ever 2 rows with the Needle Shifter. Sleeves: Stockinette Stitch worn on the knit side, EDGES and NECKBAND: K1, P1, Ribbing. After setting up Pattern Stitch for front and back section, be sure to place the Gate Cam Release Lever of the Ribber at the Needle Heels, then return the Lever after each section is completed.

FINISHING: Block each section to measurements given. Join front and back section at sides and shoulders. Sew sleeves together and set in. Join neckband at center back and front, then sew to neckline.

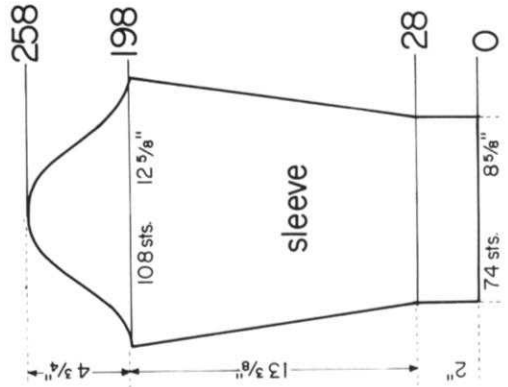

Bind off 5 sts. on CAM BOX SIDE after Rows 198, 199; 3 sts. after Rows 200, 201, 202, 203; 2 sts. after Rows 204, 205, 206, 207; ON EACH SIDE bind off 1 st. after Rows 208, 210, 212, 214, 216, 218, 220, 222, 224, 226, 228, 230, 232, 234, 236, 238, 240, 242, 244, 246, 248, 250; Bind off 2 sts. on CAM BOX SIDE after Rows 252, 253; 4 sts. after Rows 254, 255; 5 sts. after Rows 256, 257; 12 sts. after Row 258.

Change to Stockinette Stitch and light blue. ON EACH SIDE Full-fashion increase (between 2nd-3rd sts.) 1 st. after Rows 28, 38, 48, 58, 68, 78, 88, 98, 108, 118, 128, 138, 148, 158, 168, 178, 188, then knit even to Row 198.

Rows 0 to 28 Knit even, 12 rows light blue, 8 rows white and 8 rows dark blue.

Cast on 74 sts. with light blue and work K1, P1, Ribbing.

KK 5097

Bring the needles on the left side into working position according to the PATTERN, knit 1 row to the left side, turn the Row Counter back to 328 and complete the left half. Follow the instructions from *.

Bind off 1 st. after Row 592 (EVEN ROWS = SHOULDER SHAPING); 1 st. after Rows 593, 594, 596, 598, 600, 602, 604, 606; 2 sts. after Rows 608, 610; 1 st. after Row 611 (last time for Front); 2 sts. after Rows 612, 614, 616, 618, 620, 622, 624, 626, 628.

Bind off 4 sts. after Row 388 (EVEN ROWS = ARMHOLE SHAPING); 3 sts. after Row 392; 1 st. after Row 395; 2 sts. after Rows 396, 400; 1 st. after Rows 404, 408, 412 (last time for Armhole); 1 st. after Rows 413, 431, 449, 467, 485, 503, 521, 539, 557, 575 then knit even to Row 592.

Put 61 sts. on the left side into holding position (transfer Ribber sts. first) and complete the right half. *Decrease 1 st. after Rows 329, 345, 361, 377 (ODD ROWS = FRONT SHAPING).

Set up PATTERN and with light blue continue in PATTERN STITCH. Knit even to Row 328.

Rows 0 to 28 knit 12 rows light blue, 8 rows white and 8 rows dark blue.

With light blue, cast on 122 sts. placing the 2 end sts. ON THE LEFT SIDE on the Main Machine and work K1, P1, Ribbing.

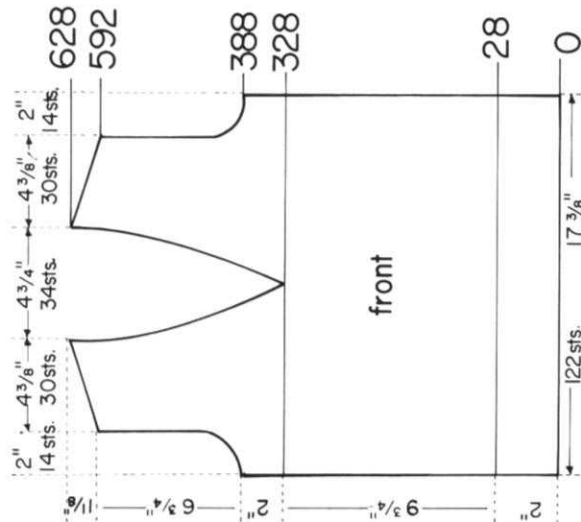

Bring the needles on the left side into working position according to the PATTERN, knit 1 row to the left side, turn Row Counter back to 592 and complete the left half. Follow instructions from *.

After Row 592 put 47 sts. on the left side in holding position (transfer Ribber sts. first) and complete the right half. *Bind off 1 st. after Row 592 (EVEN ROWS = SHOULDER SHAPING); 4 sts. after Row 593 (ODD ROWS = NECK SHAPING); 1 st. after Rows 594, 596; 3 sts. after Row 597; 1 st. after Rows 598, 600; 3 sts. after Row 601; 1 st. after Rows 602, 604; 2 sts. after Row 605; 1 st. after Row 606; 2 sts. after Rows 608, 609, 610, 612; 1 st. after 613; 2 sts. after Rows 614, 616; 1 st. after Rows 617; 2 sts. after Rows 618, 620; 1 st. after Row 621 (last time for Neck); 2 sts. after Rows 622, 624, 626, 628.

Bind off 4 sts. on CAM BOX SIDE after Rows 388, 389; 3 sts. after Rows 392, 393; 2 sts. after Rows 396, 397, 400, 401; 1 st. after Rows 404, 405, 408, 409, 412, 413, then knit even to Row 592.

Set up PATTERN and with light blue knit even to Row 388.

Rows 0 to 28 knit 12 rows light blue, 8 rows white and 8 rows dark blue.

With light blue, cast on 122 sts. placing the 2 end sts. ON THE LEFT SIDE on the Main Machine and work K1, P1, Ribbing.

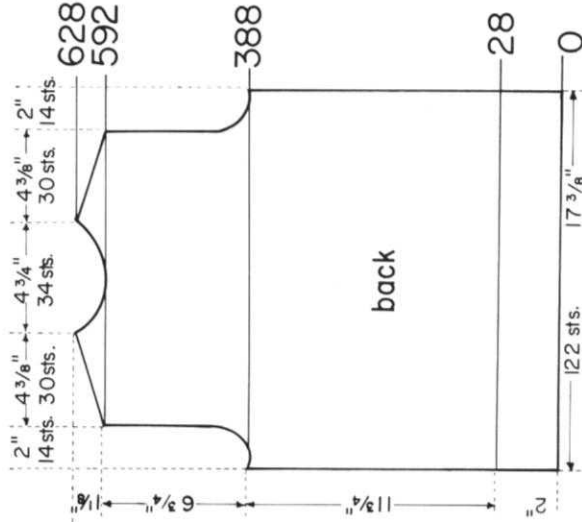

Cast on 115 sts. with white and work K1, P1, Ribbing (8 rows white and 8 rows dark blue) Bind off 2 sts. on CAM BOX SIDE after Rows 1, 3, 5, 7, 9, 11, 13, 15, and after Row 16 bind off all sts. the crocheted method for Ribbing. Work the second section with reverse shaping, casting on from right to left.

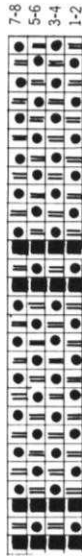

MK 5090

SIZE: 12-13. (Chest 30"-31") MATERIAL: 10 1/2 oz. (6 balls) red KNITKING Subita Crepe 2 x 3, Color No. 115. TENSION: KNITKING 4 to 6. STITCH GAUGE: PATTERN STITCH 16 sts. 2", 37 rows 2". PATTERN: Holding Position Design according to chart, or use JAC 40 and Pattern Card No. 53. The Purl side is the right side. EDGES and NECKBAND: Stockinette stitch, worn on the knit side.

To make the HEMS on the front and back sections and on the sleeves, knit to rows indicated, then hang the cast-on sts. back on the machine in FRONT of the latches, push the right Cam Control Button toward the back (machines prior to AM 3, pull the Control Knob up) and knit 2 rows without yarn. Now push the Control Button forward (or push down) turn the Row Counter back 2 rows and continue in Pattern Stitch. When working the Pattern Stitch, push in the left Retractor Button, which will automatically bring the needles back into working position. When dividing the work for the back opening and the front neckline, release the Retractor Button and bring the needles back into working position manually. Mark Row number of JAC card at point of dividing the work, then when knitting the left half of the sections, insert JAC CARD and turn to the marked row number.

FINISHING: Block all sections to measurements given. Join front and back sections at sides and shoulders. Sew sleeves together and set in. Sew 1 long edge of neckband to inside and 1 long edge to outside of neckline. (The knit side of band is the right side) Work 1 row of single crocheted around back opening. Work 3 loops on 1 side and sew 3 buttons to other side of opening.



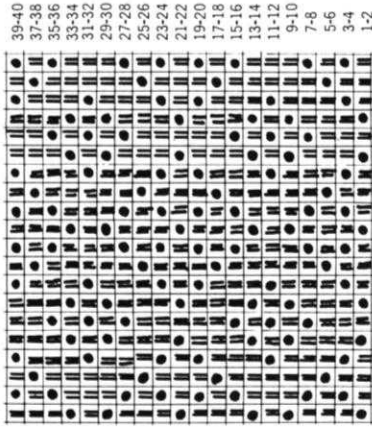

Bring the needles on the left side into working position according to the PATTERN, knit 1 row to the left side, turn the Row Counter back to 340 and complete the left half. Follow instructions from *

Bind off 2 sts. after Rows 370, 372 (EVEN ROWS = SHOULDER SHAPING); 1 st. after Row 373 (last time for Neck) 2 sts. after Row 374; 3 sts. after Rows 376, 378, 380, 382, 384, 386, 388, 390, 392.

After Row 340 put 52 sts. on the left side into holding position and complete the right half. *Bind off 6 sts. (5 sts. for the left half) after Row 341 (ODD ROWS = NECK SHAPING); 3 sts. after Rows 345, 349; 2 sts. after Rows 353, 357; 1 st. after Rows 361, 365, 369.

Bind off 4 sts. on CAM BOX SIDE after Rows 244, 245; 3 sts. after Rows 248, 249; 2 sts. after Rows 252, 253, 256, 257, 260, 261; 1 st. after Rows 264, 265, 268, 269, then knit even to Row 340.

Continue in PATTERN STITCH and knit even to Row 244.

Rows 0 to 30 knit even, then make hem.
Cast on 135 sts. and work stockinette st.

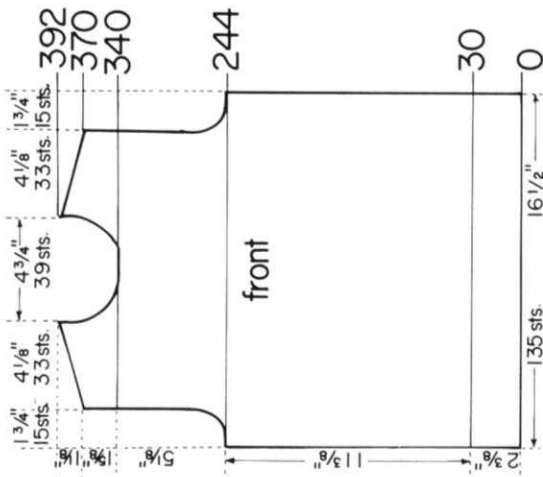

Cast on 95 sts. and work 20 rows stockinette st., then bind off the crochet method.



Bind off 4 sts. on CAM BOX SIDE after Rows 72, 73; 3 sts. after Rows 76, 77, 80, 81; 2 sts. after Rows 84, 85, 88, 89; 1 st. after Rows 92, 93; 2 sts. after Rows 96, 97; 1 st. after Rows 100, 101; 2 sts. after Rows 104, 105; 1 st. after Rows 108, 109; 2 sts. after Rows 112, 113; 1 st. after Rows 116, 117; 2 sts. after Rows 120, 121; 1 st. after Rows 124, 125; 2 sts. after Rows 128, 129; 1 st. after Rows 132, 133; 2 sts. after Rows 136, 137, 140, 141, 144, 145; 3 sts. after Rows 148, 149, 152, 153; 9 sts. after Row 156.

Increase 1 st. on CAM BOX SIDE after Rows 22, 23, 32, 33, 42, 43, 52, 53, 62, 63, then knit even to Row 72.

Rows 0 to 20 knit even, then make hem and continue in PATTERN STITCH.

Cast on 83 sts. and work stockinette st.

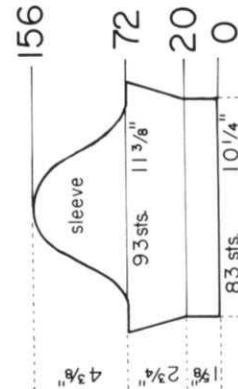

Bring the needles on the left side into working position according to the PATTERN, knit 1 row to the left side, Turn Row counter back to 334 and complete the left half. Follow instructions from *.

Bind off 2 sts. after Rows 370, 372, 374 (EVEN ROWS = SHOULDER SHAPING); 3 sts. after Rows 376, 378; 6 sts. (5 sts. on left half) after Row 379 (ODD ROWS = NECK SHAPING); 3 sts. after Row 380; 4 sts. after Row 381; 3 sts. after Row 382; 4 sts. after Row 383; 3 sts. after Rows 384, 385, 386, 387 (last time for Neck) 388, 390, 392.

*Knit even in PATTERN STITCH to Row 370.

Bind off 4 sts. on CAM BOX SIDE after Rows 244, 245; 3 sts. after Rows 248, 249; 2 sts. after Rows 252, 253, 256, 257, 260, 261; 1 st. after Rows 264, 265, 268, 269, then knit even to Row 334 and after Row 334, for the opening, put 52 sts. on the left into holding position and complete the right half.

Continue in PATTERN STITCH and knit even to Row 244.

Rows 0 to 30 knit even, then make hem.

Cast on 135 sts. and work stockinette st.

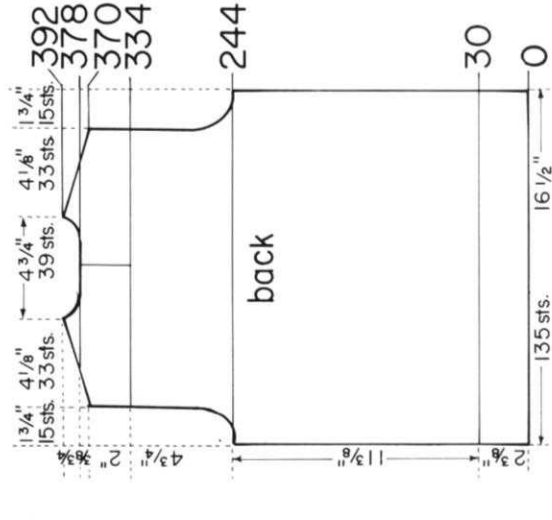

Knitking

Offers Complete Service To The Machine Knitter . . .



KNITKING KNITTING MACHINES — The finest and most versatile automatic knitters available anywhere in the world — KNITKING is the worlds most honored machine with five gold medals for excellence. KNITKING Push-Button knitters produce a range of patterns and knit a variety of yarns unequalled by other machines.

KNITKING MAGAZINE — Without a doubt the finest Knitting machine magazine in the English language published anywhere in the world. Twenty original patterns in each issue and for all members of the family. Stylish designs photographed on world famous models. High fashion garments, handsome sweaters, sports outfits, baby clothes, plus accessories and knitting machine hints. All available to you in KNITKING MAGAZINE.

KNITKING YARNS — We searched the world over for the finest yarns obtainable: Beautiful wools from Australia in a range of colors that will dazzle you. The finest quality yarns from West Germany including a new synthetic, soft as a feather pillow, yet able to withstand all the punishment your washing machine can give it, plus superb Satin-Cotton and Linen-Cotton. Excellent Shetlands, Bri-nylon and wools from world famous English mills.

If you want your garments to look as good as those in KNITKING MAGAZINE and keep their appearance through dozens of washes, you must knit them with gorgeous KNITKING yarns. KNITKING yarns are the finest quality obtainable anywhere and the prices cannot be beaten. Try them once and you will always use them.

Send \$2.00 for LARGE COMPLETE YARN CATALOGUE
(Refunded on your first \$10.00 order) to:

KNITKING YARNS, Dept. 19
1128 Crenshaw Boulevard
Los Angeles, California 90019

NOTES TO KNIT BY . . .

STITCH AND ROW GAUGE

KNIT A SAMPLE SWATCH . . . before you begin to knit any garment . . . for this is the **MOST IMPORTANT STEP** toward the correct size and the proper fit of any garment you wish to make. You **MUST** use the **SAME YARN** for your sample swatch that you will use to knit your garment and your sample swatch must be knitted large enough and using several different tension numbers on your machine. When you have done this, then you can determine the number of stitches and the number of rows in a two-inch measure. **KNITTING MAGAZINE PATTERNS** give you 3 tensions to try and one of them should give you the correct stitch and row gauge if you are using the yarn we recommend or a similar weight yarn. Here is the way to make your sample swatch.

Cast on over a sufficient number of needles to produce a swatch at least 4 inches wide. (If the pattern calls for 16 stitches to 2", then 16 x 2 = 32 stitches to cast on). Now knit 4 inches of rows at the first suggested tension number. (If the pattern calls for 22 rows to 2", 22 x 2 = 44 rows to knit). Knit 2 rows using a contrast color, change to the next higher tension and with garment yarn knit another 4", knit 2 rows with contrast color, change to the 3rd higher tension and knit another 4" and then bind off.



Roll the swatch into a cylinder over its length and pull on both ends, unroll it and stretch it diagonally by pulling on the four corners. Allow the swatch to rest and settle (preferably overnight) and then using a stitch gauge or a ruler, count the number of stitches over a 2" width, then the number of rows over a 2" length in **EACH** of the 3 tensions. Select the tension number that produces the stitches and rows called for in the pattern. If none of them are correct, you are most likely using the wrong weight of yarn.



READING OF CHARTS

You will notice the instructions start at the bottom of the Chart and work UP. Follow the charts exactly as written and providing your sample stitch and row gauge is correct, your garment will come out the right size. Please remember that the section of garment as it is knitted on the machine, faces

the same way as the Charts are in this magazine. Where two front pieces are needed, (or any other part of a garment that needs two sections) only one section is normally shown and the second section is sometimes made with reverse shaping. Set in sleeves are usually identical, but raglan sleeves have to be knitted with reverse shaping for the second sleeve.

READING OF SYMBOLS

Symbols are used on Line Drawings of Pattern stitches to show the position of the needles and the variety of stitches used for Pattern knitting. These Symbols are drawn and are to be read as you look at them while knitting the garment. For instance: if a Purl stitch faces you, the Purl stitch Symbol  is shown; if a knit stitch faces you (as when using the ribber) then this Symbol  is shown. The Line Drawings for pattern stitches are to be read and set up on your machine from **RIGHT to LEFT** unless otherwise stated in the individual instructions.

In **EYELET** design Patterns    specified stitches are transferred to an adjacent needle and the empty needles are returned to the working position. The drawings have row numbers on the **RIGHT** side. Missing Row Numbers are **ALWAYS** knitted straight or plain.

In **HOLDING POSITION DESIGNS**  selected needles are pushed into holding position for the stated number of rows. The numbers of rows appear at the right of the Line Drawings. Example: 1-4 means knit rows 1 to 4; 5-7 means knit rows 5 to 7; 8-12 means knit rows 8 to 12, etc. etc. (See below for more Pattern Stitch Symbols.)

BLOCKING and ASSEMBLING GARMENTS

Block each section of your knitting separately **BEFORE** assembling any garment. This not only makes putting your garment together much easier but gives it that professional look of perfection. For the correct assembly of garments and all other important information regarding machine knitting, refer to our book "Practical Knitting Hints."

PATTERN STITCH SYMBOLS

 = knit stitch

 = purl stitch

 = empty needle (leave in working position)

 = needle not used (in the out of work position)

 = needle in the holding position

 = 2 stitches on 1 needle - either transferred from the right side or the left side, then put the needle into holding position

 = needle holding 2 stitches. Stitch has been transferred from the **LEFT**

 = needle holding 2 stitches. Stitch has been transferred from the **RIGHT**

 = 3 stitches on 1 needle. The 1st and 3rd stitch in a group of 3 needles has been hung on the 2nd or center needle.

The diagrams (Line Drawings) for pattern work are followed just as they are shown and are to be read as you look at them while knitting the garment.

open darts



closed darts



Knitking makes it easy...



"YARNS BY KNITKING." No matter how you knit, by needle or automatically, you will want this wonderful catalog that shows actual samples of the world's most exciting yarns ... a brilliant array of gorgeous colors and fabulous textures ... you'll be thrilled to pieces ... handsome cable yarns and other 100% virgin wools awarded the International Wool Seal, superb Satin-Cotton and Linen-Cotton, luxurious tweeds, even a new "soft as a kitten" synthetic that can be machine washed and dried. We traveled the globe for the finest yarns and we import them from Australia, Great Britain, Germany and many other countries. We sell directly to you at big savings!

PRACTICAL HINTS

A completely new publication... A reference book written especially for the machine knitter... Complete detailed instructions on measuring, charting, knitting, assembling and finishing garments... How to do fashioning and shaping... How to make buttonholes and do decorative stitching... eyelet designs, Norwegian patterns, etc., etc. Absolutely indispensable to all owners of knitting machines.



KNITKING CHILDREN'S BOOK... over 50 beautiful patterns for infants and children to teens... boys and girls... buntings, blankets and baby outfits to cute dresses, skirts and cardigans ... a treasure chest of gift ideas!

KNITKING MAGAZINE... it's the only knitting machine magazine published in America... each issue has 20 or more up to the minute knitting patterns... something for every member of the family... fashions created by top designers and photographed on famous models, some in full color... and you receive a bi-monthly newsletter with your subscription... put KNITKING MAGAZINE on your must reading list and you'll be a fashion expert in no time!

