

knitking

magazine



may/june '70

Accessories

1. Treble Transfer-Tools. For rapid transfer of stitches and for cable stitch. \$1.50 pair plus 25c shipping.
2. Yarn Winder and Skein Holder. Heavy cast frame and nylon gears. \$15.95 plus \$1.00 shipping.
3. 33 Needle Multi-Transfer Tool. For decreasing in the middle of a row. \$3.25 plus 25c shipping.
4. Adjustable Needle Selector. For setting unevenly spaced pattern stitches. \$3.50 plus 25c shipping.

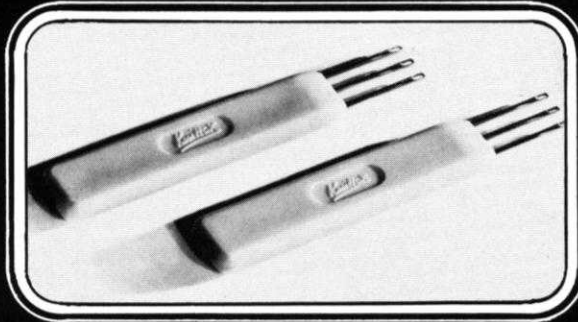

5. Reversing Bar. For easy hem turning or reversing of knitting. \$17.95 plus \$1.50 shipping.
6. Automatic Pattern Selector. For all KNITTING machines prior to Push Button. \$7.95 plus 35c shipping.
7. Converta Tape. For simple and speedy charting of custom knits. \$6.95 plus 30c shipping.

California residents add
5% sales tax.

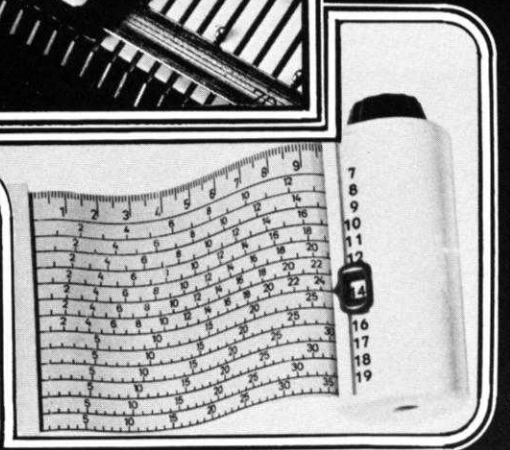
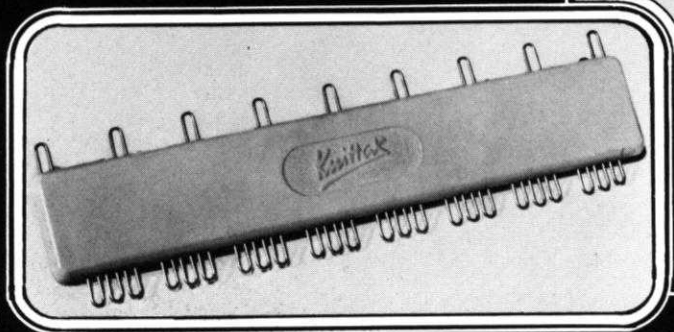
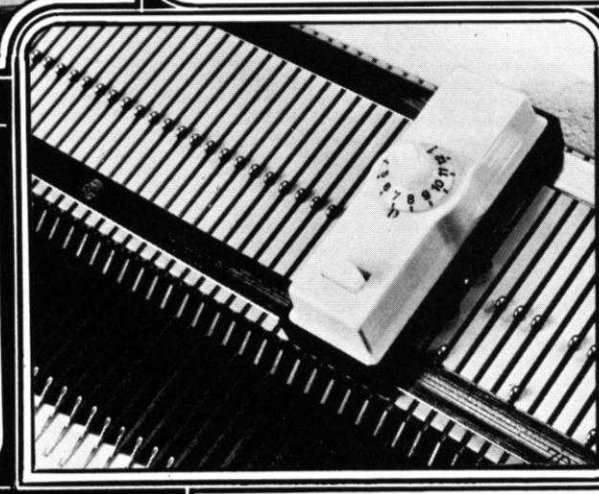
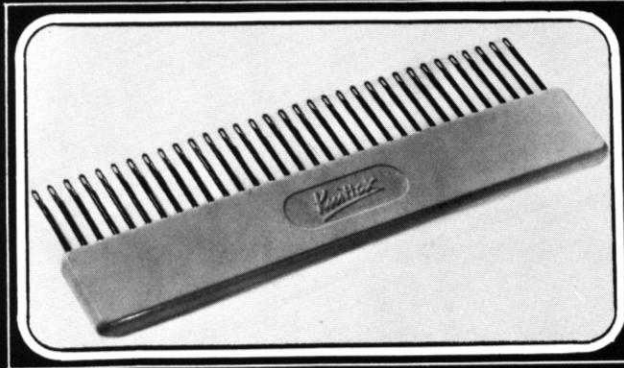
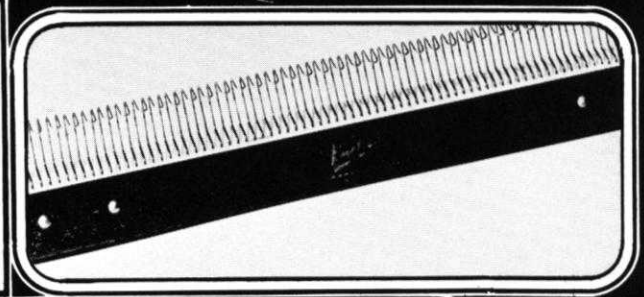
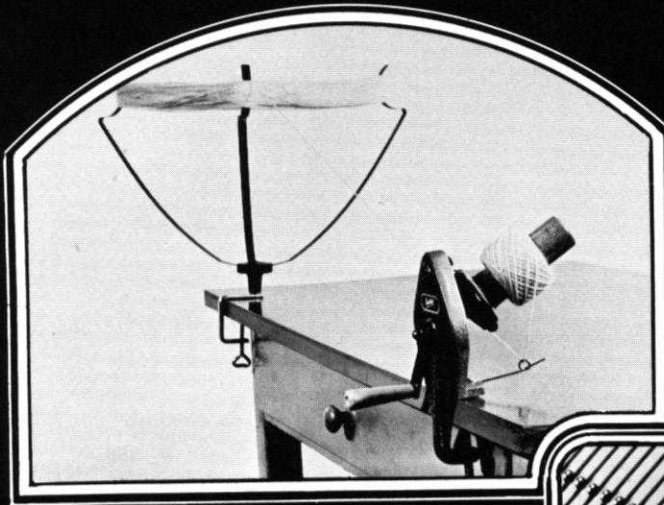

knitking

magazine

| INDEX | PAGE NO. |
|---|----------|
| DP 7801 Woman's Jacket | 14 |
| DK 7800 Woman's Slacks & Pullover | 15 |
| DK 7806 Woman's 2 piece Suit | 17 |
| DK 7992 Woman's Dress | 18 |
| DK 7805 Woman's Beach Coat | 19 |
| DP 7809 Woman's Bikini | 20 |
| DK 7804 Woman's Dress | 21 |
| MK 5205 Girl's Sun Dress | 22 |
| DK 7803 Woman's Beach Dress | 22 |
| DP 7802 Woman's Tunic | 24 |
| DP 7807 Woman's Pullover | 25 |
| HP 3595 Man's Vest | 26 |
| HP 3594 Man's Pullover | 27 |
| HP 3596 Man's Sport Shirt | 28 |
| MK 5206 Girl's Bathing Suit | 29 |
| MK 5207 Boy's Bathing Trunks | 30 |
| SK 5121 Girl's Dress | 30 |
| KG 1906 & KG 1907 Pillow Covers | 31 |
| KK 5204 Boy's Sport Shirt | 32 |



Stripe your way into fashion focus wearing KNITKING knits for any hour of the day or night . . . The sophisticated, smart and groovy selection of travel happy striped garments are designed for vacation or weekend trips . . . So . . . shape up . . . and knit up . . . in time for fun and frolic days ahead.

Publisher: KNITKING CORPORATION, 1128 Crenshaw Blvd., Los Angeles, Calif. 90019. Telephone: WEbster 8-2079. Published bi-monthly. Subscriptions: USA — \$6.00 annually, single copies \$1.50; Canada — \$7.00; other parts of the world — \$10.00. The entire contents of KNITKING MAGAZINE are copyright and must not be reproduced in any shape or form without the express permission, in writing of the publisher. COPYRIGHT © by KNITKING CORPORATION 1970.

Printed by George Rice & Sons, Los Angeles, California

knitking

magazine

Knit and crocheted vests are very popular at this time and in order to satisfy the many requests we have received from readers for instructions on how to make them we are including a bonus pattern in this issue.

The instructions are in KNITKING NEWS and when you study them you will notice that they cover a range of sizes but that the size is controlled by variations in the knitting tension . . . not by extra stitches and rows . . . and that the pattern stitch is lacy, allowing for blocking to most sizes.

Because the vest is so easy to make, we offer it to our readers as a lesson in size control through variations in stitch size, and we suggest that you experiment with the principle any time you wish to produce a KNITKING garment in a larger or smaller size than the instructions are written for.

As an example, we refer you to pattern DK 7804 in this issue . . . the width at the bottom of each section is 24½" . . . Allowing for seams, the finished circumference should be approximately 48". The instructions call for a yarn that produces 8 stitches to the inch, so 48 x 8 = 384 stitches . . . now if we set the tension control 1 tension higher (i.e. 6 to 7) the same yarn will knit at 7½ stitches to the inch and if you cast on the same number of stitches as called for in the instructions, the circumference at the bottom will be 384 ÷ 7.5 = 51" . . . 3" larger than if it were one tension lower.

The finished underarm circumference is 38" at 8 stitches to the inch. When you increase the tension and get 7½ stitches to the inch, the underarm measurement will increase to 40½" . . . a size 16 . . . Simple, isn't it?

Of course, if you want the garment to be smaller than called for in the instructions, you set your tension control so that you get 8½ stitches per inch . . . the circumference under the arms will then become 36" and at the bottom a little over 45".

By just changing the stitch gauge through tension control and otherwise knitting exactly as stated, we have shown how the size of a garment can be varied to fit from a size 10 through 16 . . . you must not however, lose sight of the fact that when you alter your tension, you will also increase or decrease the length of the garment and will need to make an adjustment in the length of hem you turn. This is relatively easy on pattern DK 7804 because you have 72 rows to play with. For simplicity in shortening or lengthening a garment, you should always make the adjustments before decreases and increases start. For example, if you want to make DK 7804 longer, you can knit more rows at the bottom between 0 and 72, then reset your counter to 72 and continue the instructions exactly as shown.

You are, of course, restricted in the amount you can increase or decrease the tension for specific yarns. Don't try to make a size 12 garment into a size 20 by increasing the tension from 6 to 10. If you do, you will make your knitting too loose and sloppy.

We will be introducing a new accessory in the next issue of KNITKING MAGAZINE . . . a very clever and easy to use Weaver that permits the weaving together into fancy stitch designs, yarns of varying weights and texture . . . the cover garment will be a 3-piece slack outfit with the cardigan made using the new Weaver . . . For the girls that have been asking, we are including a maxi dress plus an assortment of dresses, suits and cardigans . . . For the men, a cardigan and an original style zippered sweater . . . For the children, a group of the most charming clothes we have ever featured.

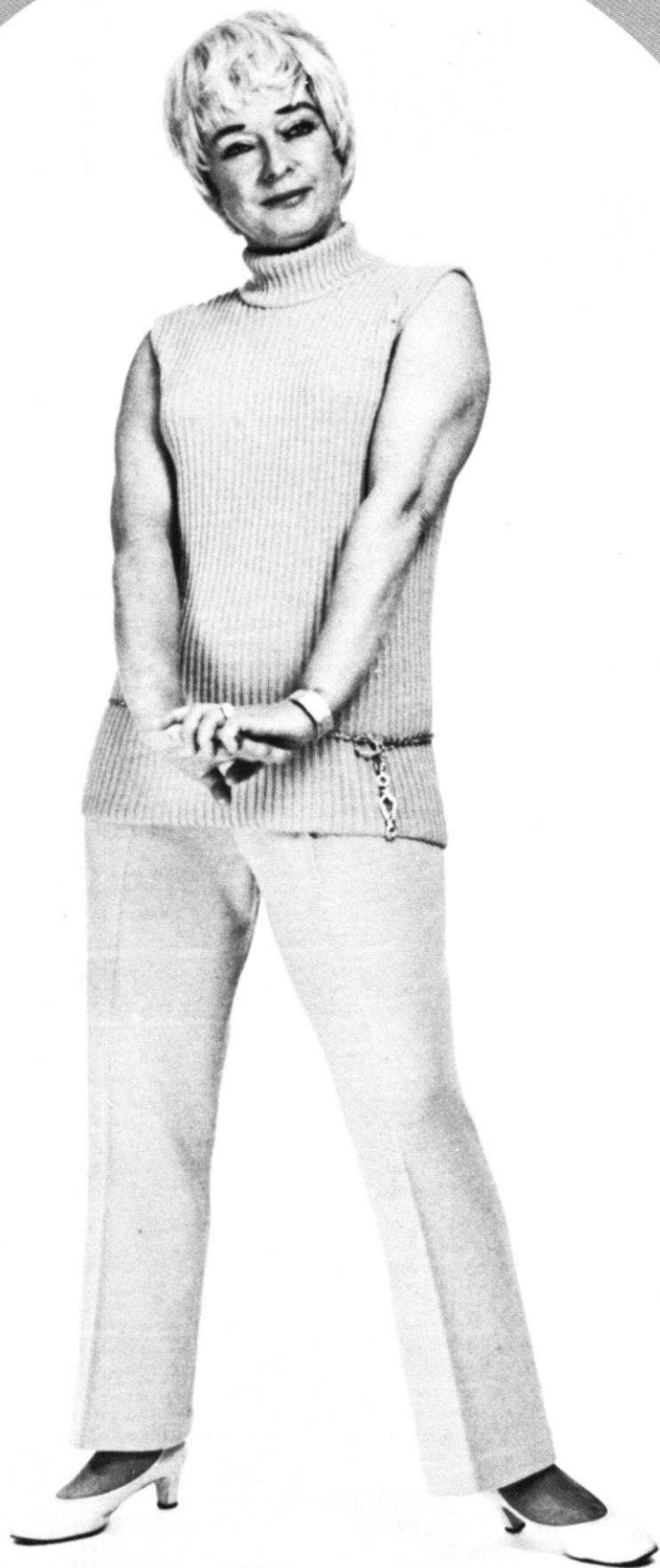

**...and
the
winner
is?**

DK 7800

The very new slightly flared Slacks team up with a Ribbed sleeveless Pullover that is knitted in KNIT-KING Subita 2 x 3. Wear a chain belt to complete the "Now" look. Size 12/14. See page 15.



DK 7806

Brightly striped colors in a short sleeved Jacket match up with a swinging Skirt for a spring and summer Suit. Knit it in KNITKING Subita 2 x 3 and be sure to order enough yarn for an extra top you can wear with the Skirt.

Size 10/12. See page 17.



DK 7792

Knitty pretty... for spring into summer... is our lovely sleeveless dress knitted with KNITKING Subita 2 x 3. Mostly stockinette stitch with a wide eyelet design that hugs the waistline.

Size 10/12. See page 18.



**glamour
at the
beach**

DP 7809

We got the message... for a Bikini... so here you are... an ultra Bikini to show off a pretty figure. Knit it with KNITKING Subita 2 x 3 in a simple holding position design. After blocking the sections (and before putting them together), it's a good idea to cut a paper pattern so that you can line it with nylon tricot. Size 10/12. See page 20.



DK 7805

The perfect Beach Coat to wear over your Bikini (or any bathing suit). Even if you don't care for the beach, it's nice enough to be worn over summer dresses anytime.

Size 10/12. See page 19.

DK 7804

Everything is coming up stripes . . . and you must have at least one boldly striped dress. KNITKING Subita Dralon 3-ply or Fatme Boucle in 4 colors is the perfect choice.

Size 12/14. See page 21.

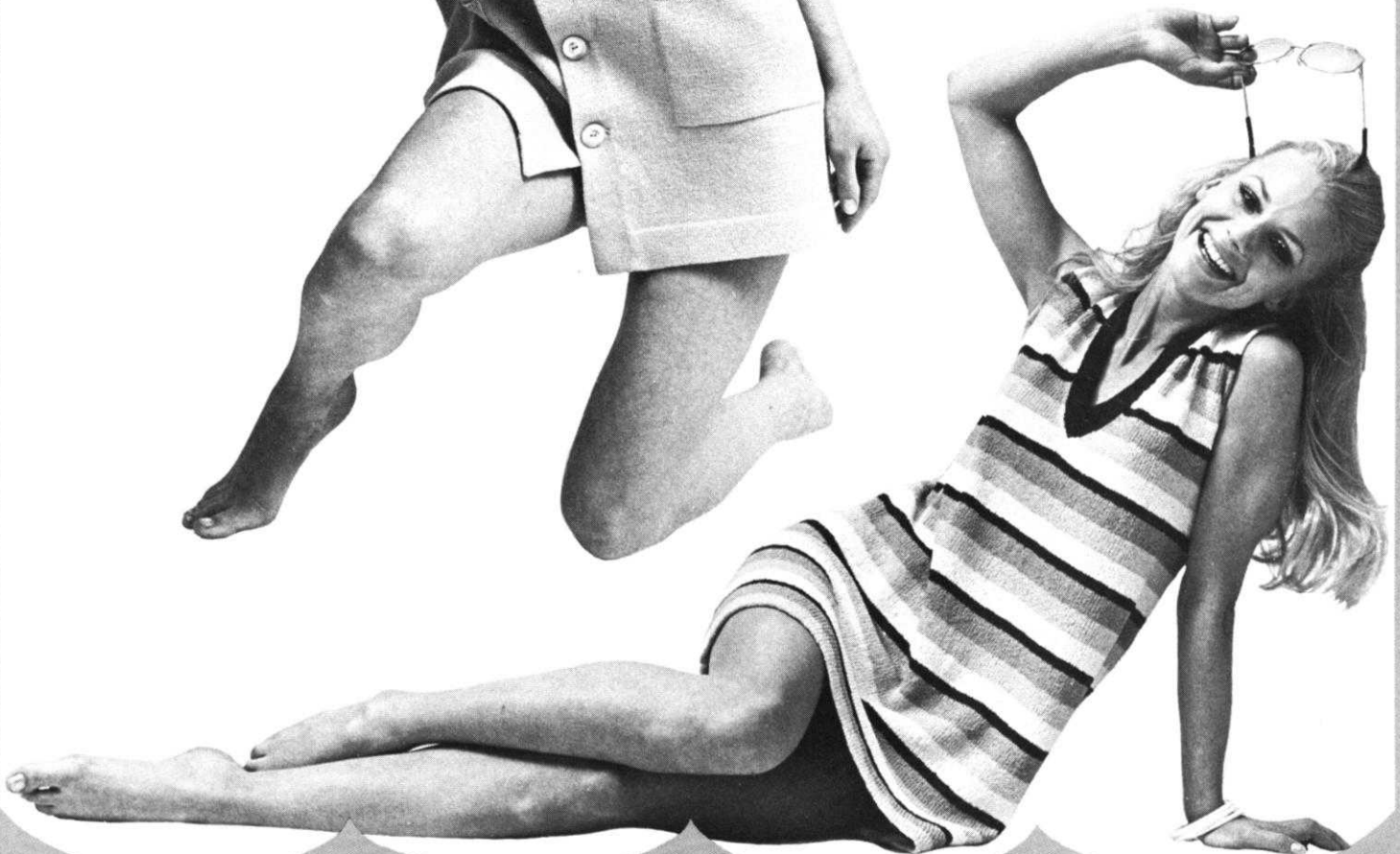



cover up

DK 7803

The Sale Yarn KNITKING Fatme Boucle is knitted into a casual Beach Dress. The side slits are new . . . the striped trim flattering. You may belt it or not . . . it's attractive either way.

Size 16/18. See page 22.



sand sprite

MK 5205

Sun days are fun days for any little girl, and especially when she is wearing a striped Sun Dress with matching long-line Panties. Knit it in KNITKING Subita Dralon 2-ply, the perfect wash and wear yarn.

Size 5-6. See page 22.



DP 7802

A waist hugging long Rib pattern shapes the very newest style Tunic. It's knitted with KNITKING Linen-Cotton and trimmed with Satin-Cotton. Perfect for wearing over long slim pants.

Size 12/14. See page 24.



DP 7807

A slim belted Pullover is knitted in a Rib stitch combined with an attractive holding position design. Bands and belt are a 1 x 1 Rib. KNITKING Subita 2 x 3.

Size 14/16. See page 25.



HP 3595

An important spring and summer Vest for your man has a zippered front closure. Easy to care for KNITKING Subita Dralon 2-ply is knitted in Fishermans Rib and a holding position design. All bands are a 1 x 1 rib.

Size 38/40. See page 26.

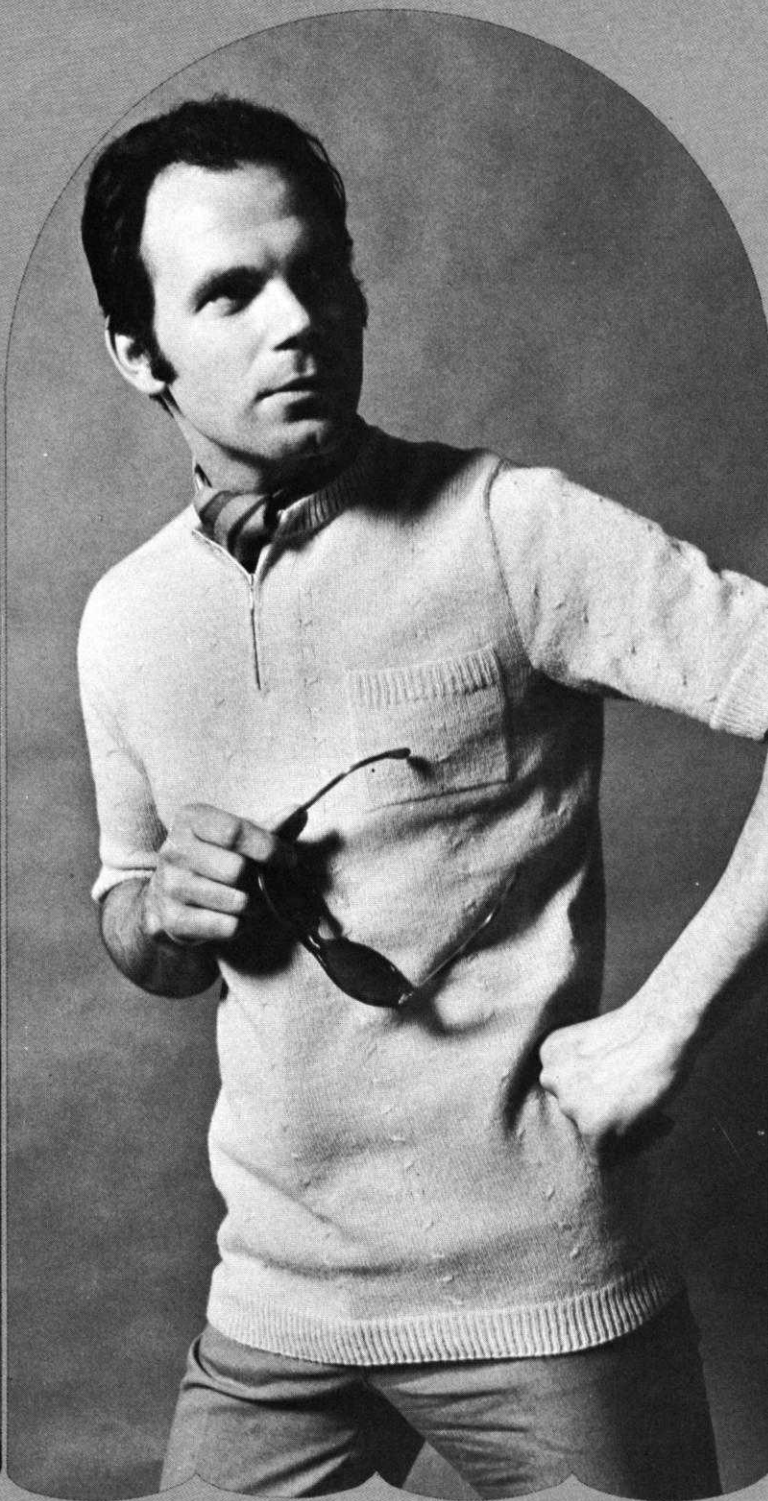

HP 3594

A small cable design is the interesting pattern stitch used to knit this man's Pullover in KNITKING Subita 2 x 3. Rib the bands, sew on a pocket and zip the neckline.

Size 36/38. See page 27.

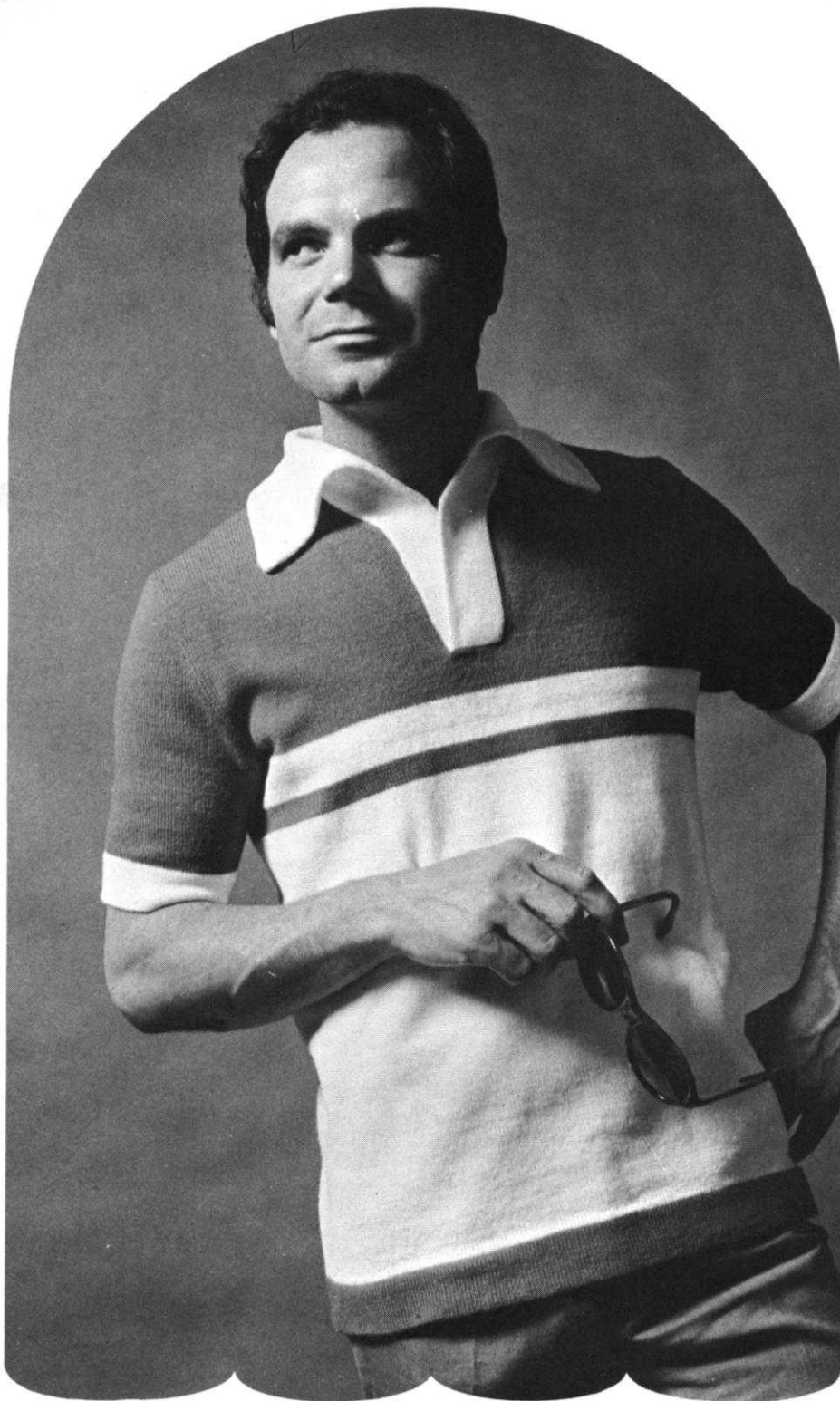

HP 3596

At home, or on summer trips, your man will wear this handsomely styled Sport Shirt with its casual open neckline and collar. Two colors of KNITKING Subita Dralon 2-ply are knitted into man pleasing stripes.

Size 38/40. See page 28.

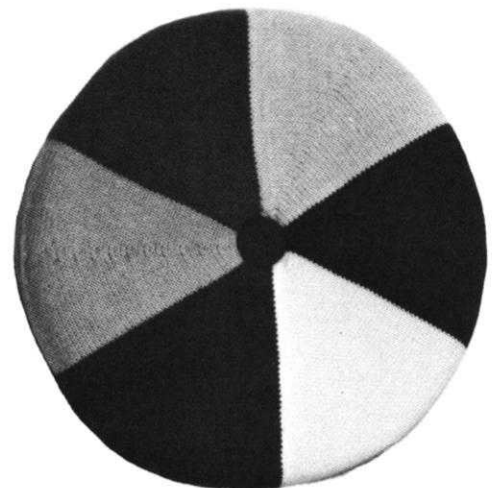

KG 1906 and KG 1907 ▲

Give any room a decorator lift with colorful Pillow Covers knitted with KNITKING Sonika Dralon. Two different styles; KG 1906 is made in 3 sections — front, back and edging with a zipper closure. KG 1907 is made all in one piece and then the open edges are woven right over a pillow form. You'll want to knit some for yourself and stash some away for future gifts.

See page 31.

**bright
and
easy**

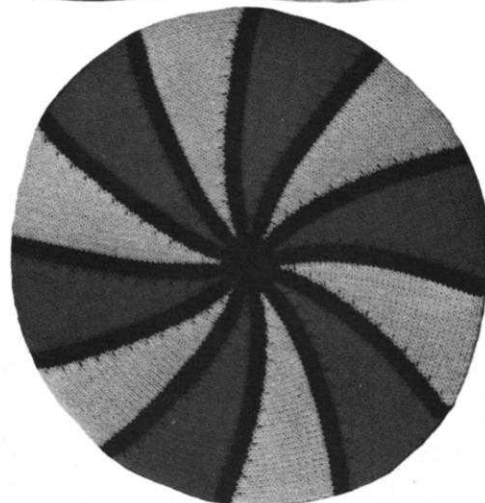

water baby



SK 5121

The sand box set will be happy to wear this darling sleeveless dress knitted in KNITKING Subita Dralon 3-ply, the wash and wear yarn. Be sure to sew an applique of her favorite animal on the oversized handy pocket.

Size 3-4. See page 30.

KK 5207

A young boy never has enough bathing trunks... Knit him the striped one as shown, then several more, varying the colors. The yarn is KNITKING Subita Dralon 3-ply.

Size 7-8. See page 30.

MK 5206

Let her build castles in the sand, dressed in a striped Bathing Suit. When it's knitted with KNITKING Subita Dralon 3-ply, it can take the water, sun and sand.

Size 5-6. See page 29.

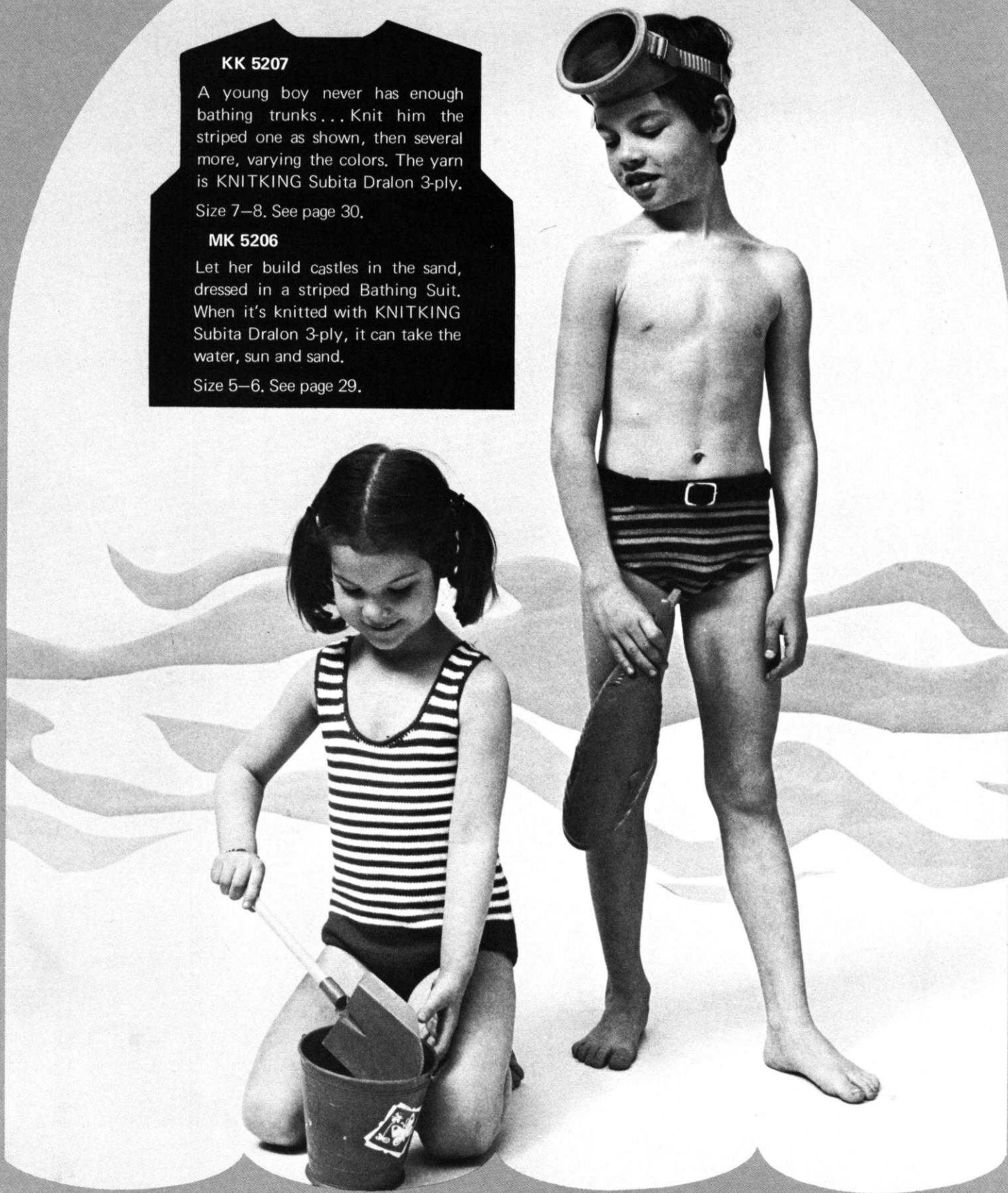



KK 5204

Comfort and quality is in this Striped Sport Shirt for a young man. He'll be delighted with it's light weight and soft texture . . . Knit it with KNITKING Subita Dralon 2-ply.

Size 14-16. See page 32.



SIZE: 12/14. **MATERIAL:** 24 1/2 oz. (14 balls) white KNITTING Subita Crepe 2 x 4, Color No. 4. **TENSION:** KNITTING 6 to 8. **STITCH GAUGE:** PATTERN: STITCH 14 sts. 2", 38 rows 2". **PATTERN:** Holding Position Design according to Line Drawing. The Gate Cam Release Lever of the Ribber is placed at the needle heels. **EDGES:** K1, P1, Ribbing. Be sure to replace the Lever of the Ribber after completing each section. **NECKLINE DECREASES:** After Rows indicated, hang the 1st st. ON NECK SIDE onto the 2nd st. **SLEEVE INCREASES:** After rows indicated, ON EACH SIDE place the 1st st. from the row below onto the next empty needle.

FINISHING: Block all sections to measurements given. Join front and back sections at sides and shoulders, easing in the fullness at bustline of front sections. Sew sleeves together and set in. Sew bands together, then sew bands to front edges and neckline. Sew pockets in place.

CENTER OF GARMENT SECTION

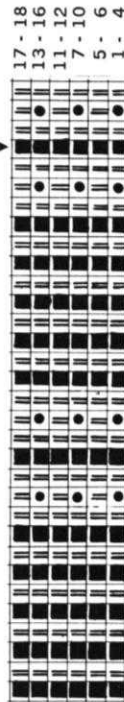

Bring the needles on the left side back into working position according to the PATTERN, knit 1 row to the left side, turn the Row Counter back to 516 and complete the left half. Follow the instructions from *. Count the extra Row for the Holding Position Design.

* ON CAM BOX SIDE, bind off 2 sts. after Row 516 (EVEN ROWS = SHOULDER SHAPING); 8 sts. (7 sts. for the left half) after Row 517 (ODD ROWS = NECK SHAPING); 2 sts. after Row 518; 3 sts. after Row 519; 2 sts. after Row 520; 3 sts. after Row 521; 2 sts. after Row 522, 523, 524, 525, 526, 527; 3 sts. after Row 528; 2 sts. after Row 529; 3 sts. after Row 530.

ON CAM BOX SIDE, bind off 2 sts. after Rows 500, 501, 502, 503, 504, 505, 506, 507, 508, 509, 510, 511, 512, 513, 514, 515, then knit to Row 516, put 39 needles on the left side into holding position (transfer the ribber sts.) and complete the right half first.

ON CAM BOX SIDE, bind off 4 sts. after Rows 348, 349; 3 sts. after Rows 352, 353, 356, 357; 2 sts. after Rows 360, 361, 364, 365, 368, 369; 1 st. after Rows 372, 373, 376, 377, then knit to Row 500.

ROWS 23 to 348: Knit even.

ROWS 0 to 22: Knit even, then set up for PATTERN, place the Gate Cam Release Lever of the Ribber at the needle heels and work the Holding Position Design.

Cast on 147 sts. and work K1, P1, Ribbing.

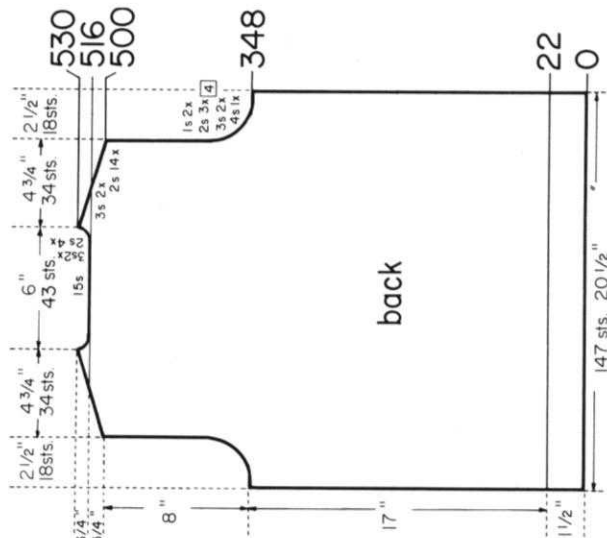

back

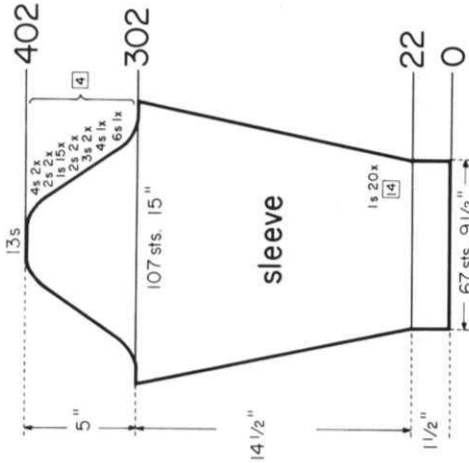

sleeve

Work the second front section with reverse shapings. Cast on the regular way. Knit 22 rows K1, P1, Ribbing, then transfer the appropriate ribber sts. to the main machine, place the Gate Cam Release Lever of the Ribber at the needle heels, knit 1 row to the left side, turn the Row Counter back to Row 22 and work the Holding Position Design. Follow the instructions from *.

ON CAM BOX SIDE, decrease 1 st. after Row 363 (ODD ROWS = NECK SHAPING), then decrease 1 st. ON CAM BOX SIDE after Rows in (. ON CAM BOX SIDE, bind off 4 sts. after Row 364 (EVEN ROWS = ARMHOLE SHAPING); 3 sts. after Rows 368, 372; (375), 2 sts. after Rows 376, 380, 384; (387), 1 st. after Rows 388, 392. The Armhole is now completed. Continue to decrease 1 st. for Neck Shaping after Rows 399, 411, 423, 435, 447, 459, 471, 483, 495, 507, then decrease 1 st. on NECK SIDE after Rows in (. Knit to Row 516. For SHOULDER, bind off 2 sts. after Rows 516, 518, (519), 520, 522, 524, 526, 528, 530, (531 last time for Neck), 532, 534, 536, 538, 540, 542; 3 sts. after Rows 544, 546. (Place the Lever of the Ribber back to the needle heads.)

* ROWS 23 to 363: Knit even.

ROWS 0 to 22: Knit even, then set up for PATTERN, place the Gate Cam Release Lever of the Ribber to the needle heels and work the Holding Position Design.

Cast on 67 sts. and work K1, P1, Ribbing.

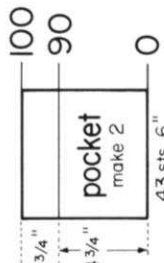

Cast on 43 sts, set up for PATTERN, place the Gate Cam Release Lever of the Ribber at the needle heels and work 90 rows in Holding Position Design, then transfer the appropriate sts. to the Ribber, replace the Ribber Lever and work 10 rows K1, P1, Ribbing. After Row 100 bind off all sts. the crochet method for ribbing.

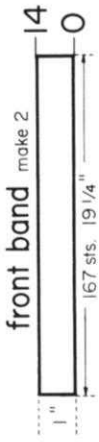

Cast on 167 sts. and work 14 rows K1, P1, Ribbing, then bind off all sts. the crochet method for ribbing.

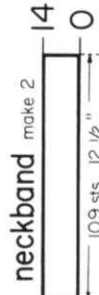

Cast on 109 sts. and work 14 rows K1, P1, Ribbing, then bind off all sts. the crochet method for ribbing.

DK 7800

SIZE: 12/14. **MATERIAL:** Slacks 15 1/2 oz. (9 balls) Shell 12 1/2 oz. (7 balls) red KNOTTING Subita Crepe 2 x 3. Color No. 115. **TENSION:** KNOTTING 3 to 5. **STITCH GAUGE:** Stockinette Stitch 18 sts. 2", 24 rows 2"; Pattern Stitch 20 sts. 2", 28 rows 2". **PATTERN:** Slacks Stockinette Stitch; Shell Purl 3, Knit 1, Ribbing according to Line Drawing. Make all shapings of 1 st. on the Slacks. Full-fashion. **DECREASES:** After Rows indicated, hang the 3rd st. on the appropriate sides onto the 2nd st., then move the end sts. inward to fill the empty needle. **INCREASES:** After Rows indicated, move the 2 end sts. on the appropriate side 1 needle outward, then place the 3rd st. from the row below onto the empty needle. Begin the DARTS by hanging together the sts. marked on the diagram, then move the end sts. inward to fill the empty needles. The following decreases for the Darts lie directly above. The finished length of the instep seam is 28 1/2".

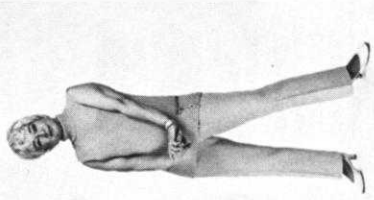

FINISHING: Block all sections to measurements given. **SLACKS:** Join front and back sections at sides. Sew leg seams together. Join sections at center back, then join center fronts about 4". Make a narrow hem around the opening. Sew in a zipper. Turn under 12 rows on upper edge and 20 rows on leg edges and hem to wrong side. Insert an elastic band into upper hem. Finish the button-hole, sew on a button. **SHELL:** Join front and back section at sides and shoulders, easing in the fullness at bustline of front section. Turn under a small amount around armholes and hem to wrong side. Join short ends of collar. Sew 1 edge of collar to inside and 1 edge to outside of neckline.

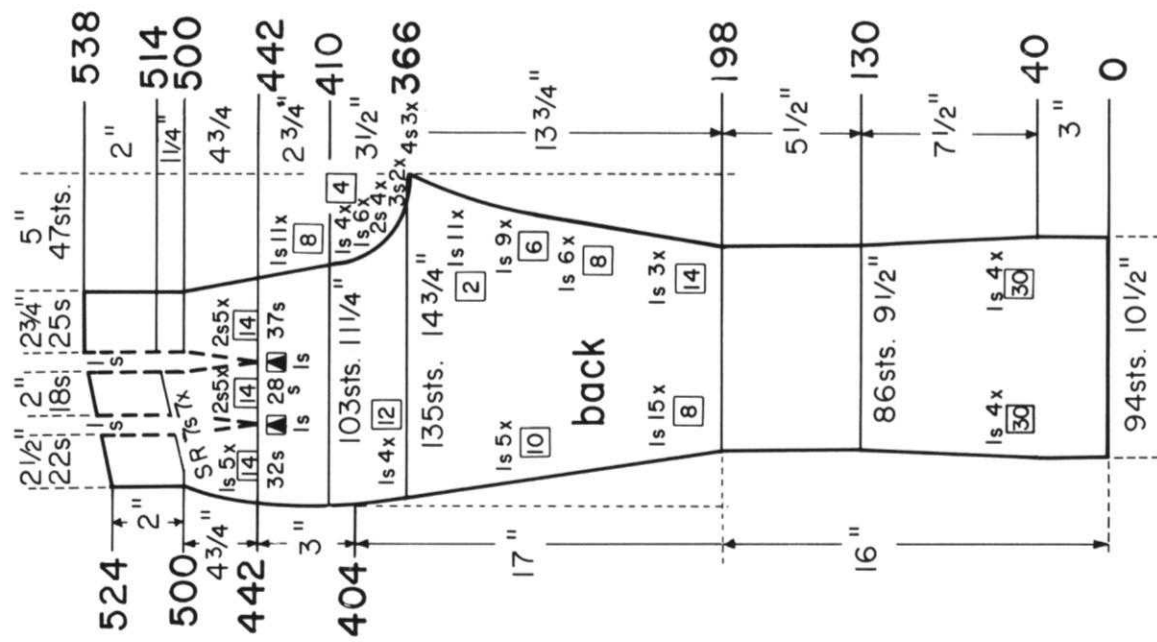

Work the second back section with reverse shapings, casting on from right to left. (Cam Box will be on the LEFT SIDE at Row 0).
Work Short Rows for the shaping of the back. ON OPPOSITE SIDE of CAM BOX, put into holding position 7 needles after Rows 500, 502, 504, 506, 508, 510, 512. After Row 514 bring all needles back into working position, knit even to Row 538, then bind off the remaining 67 sts.

ON OPPOSITE SIDE of CAM BOX decrease 1 st. for SIDE SEAM and 2 sts. for each DART after Row 442, then repeat these decreases after Rows in (). ON CAM BOX SIDE, decrease 1 st. after Rows 444, 452, (456), 460, 468, (470), 476, 484, (484), 492, (498), then knit to Row 500.

ON CAM BOX SIDE, bind off 4 sts. after Rows 366, 368, (363), 370; 3 sts. after Rows 372, 374, 2 sts. after Rows 376, 378, 380, (380), 382; 1 st. after Rows 384, 386, 388, 390, 392, (392), 394, 396, 400, 404, (404) INCREASE), 408, 412, 420, 428, 436, then knit to Row 442.

UP TO ROW 404, INCREASE 1 st. ON OPPOSITE SIDE of CAM BOX AFTER ROWS IN (). ON CAM BOX SIDE, increase 1 st. after Rows 198, (198), (206), 212, (214), (222) 226, (230), (238), 240, (246), 248, (254), 256, (262), 264, (270), 272, (278), 280, (286), 288, 294, (294), 300, (302), 306, (310), 312, 318, (318), 324, (328), 330, 336, (338), 342, 344, 346, 348, (348), 350, 352, 354, 356, 358, (358), 360, 362, then knit to Row 366.

ON EACH SIDE, decrease 1 st. after Rows 40, 70, 100, 130, then knit even to Row 198.

ROWS 0 to 40: Knit even.
Cast on 94 sts. and work stockinette st.

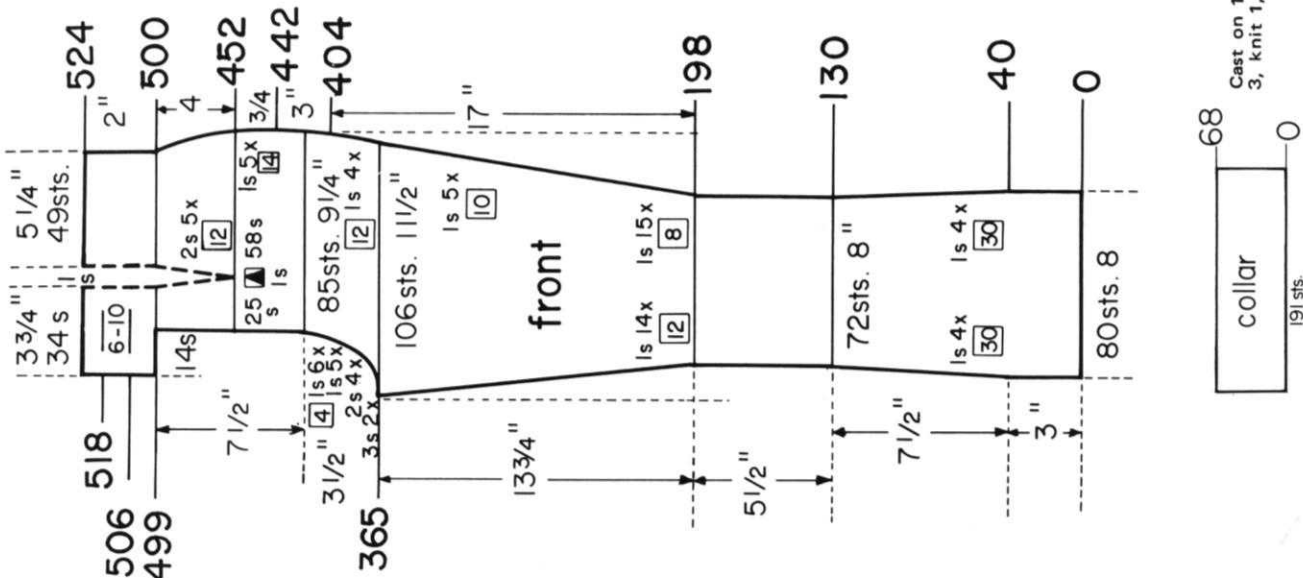
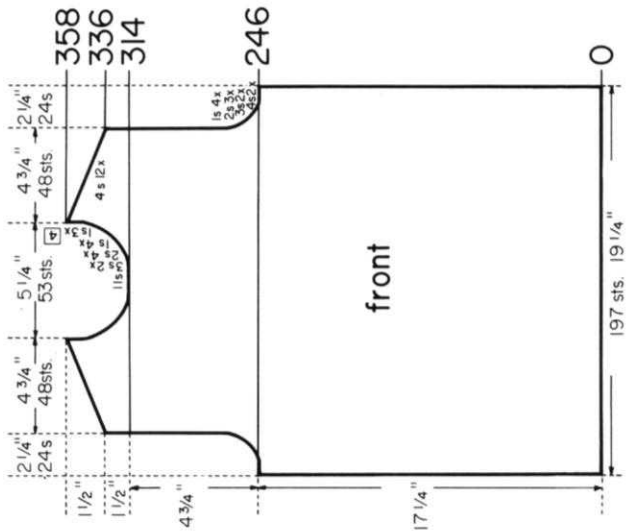
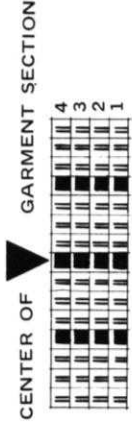
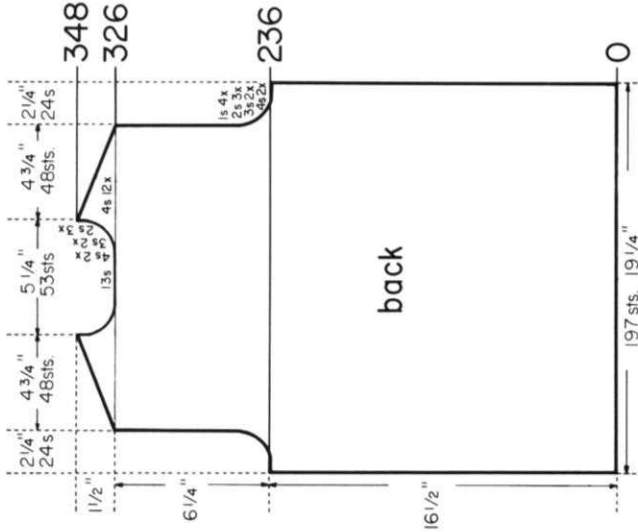

Move the Cam Box to the left side, turn the Row Counter back to 326 and complete the left half. Follow the instructions from *.

* ON CAM BOX SIDE, bind off 4 sts. after Row 326 (EVEN ROWS = SHOULDER SHAPING); 7 sts. (6 sts. for the left half) after Row 327 (ODD ROWS = NECK SHAPING); 4 sts. after Rows 328, 329, 330, 331, 332; 3 sts. after Row 333; 4 sts. after Row 334; 3 sts. after Row 335; 4 sts. after Row 336; 2 sts. after Row 337; 4 sts. after Row 338; 2 sts. after Row 339; 4 sts. after Row 340; 2 sts. after Row 341 (last time for Neck); 4 sts. after Rows 342, 344, 346, 348.

ON CAM BOX SIDE, bind off 4 sts. after Rows 236, 237, 238, 239; 3 sts. after Rows 240, 241, 242, 243; 2 sts. after Rows 244, 245, 246, 247, 248, 249; 1 st. after Rows 250, 251, 252, 253, 254, 255, 256, 257. Now knit even to Row 326, put 74 needles on the left side (transfer the ribber sts.) into holding position and complete the right half first.

ROWS 0 to 236: Knit even

Cast on 197 sts. and work Purl 3, Knit 1, Ribbing.

Move the Cam Box to the left side, turn the Row Counter back to 314 and complete the left half. Follow the instructions from *.

* ON CAM BOX SIDE, bind off 6 sts. (5 sts. for the left half) after Row 315 (ODD ROWS = NECK SHAPING); 3 sts. after Rows 317, 319; 2 sts. after Rows 321, 323, 325, 327; 1 st. after Rows 329, 331, 333, 335; 4 sts. after Row 336 (EVEN ROWS = SHOULDER SHAPING); 1 st. after Row 337; 4 sts. after Rows 338, 340; 1 st. after Row 341; 4 sts. after Rows 342, 344; 1 st. after Row 345; 4 sts. after Rows 346, 348; 1 st. after Row 349 (last time for Neck); 4 sts. after Rows 350, 352, 354, 356, 358.

ON CAM BOX SIDE, bind off 4 sts. after Rows 246, 247, 248, 249; 3 sts. after Rows 250, 251, 252, 253; 2 sts. after Rows 254, 255, 256, 257, 258, 259; 1 st. after Rows 260, 261, 262, 263, 264, 265, 266, 267. Now knit to Row 314, put 74 needles on the left side (transfer the ribber sts.) into holding position and complete the right half first.

ROWS 0 to 246: Knit even.

Cast on 197 sts. and work Purl 3, Knit 1, Ribbing.

Work the left front section with reverse shapings, casting on from right to left. (Cam Box will be on the LEFT SIDE at Row 0). Omit the buttonholes.

After Row 499 cast on 14 sts. ON CAM BOX SIDE, make a buttonhole after Rows 506 and 518 over the 6th-10th sts. After Row 524 bind off the remaining 84 sts.

Decrease 2 sts. for the DART after Rows in (). ON CAM BOX SIDE, decrease 1 st. after Rows 442, (450), 456, (462), 470, (474), 484, (486), 498, (498), then knit to Row 499.

CONTINUE to INCREASE 1 st. ON CAM BOX SIDE after Rows in (). ON CAM BOX SIDE, bind off 3 sts. after Rows 365, 367; (368), 2 sts. after Rows 369, 371, 373, 375; 1 st. after Rows 377, 379, (380), 381, 383, 385, 387, 391, (392), 395, 399, 403, (404 last INCREASE), 407, then knit even to Row 442.

INCREASE 1 st. ON OPPOSITE SIDE of CAM BOX after Rows in (). ON CAM BOX SIDE, increase 1 st. after Rows 198, (198), 206, (210), 214, 222, (222), 230, (234), 238, 246, (246), 254, (258), 262, 270, (270), 278, (282), 286, 294, (294), 302, (306), 310, 318, (318), 328, (330), 338, (342), 348, (354), 358, then knit to Row 365.

ON EACH SIDE decrease 1 st. after Rows 40, 70, 100, 130, then knit even to Row 198.

ROWS 0 to 40: Knit even.

Cast on 80 sts. and work stockinette st.

Cast on 191 sts. and work 68 rows Purl 3, knit 1, Ribbing, then bind off all sts.

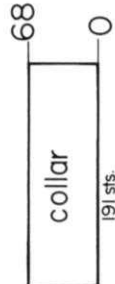

DK 7806

SIZE: 10/12. **MATERIAL:** Skirt 12 1/4 oz. (7 balls) white; Jacket 5 1/2 oz. (3 balls) white, 3 1/2 oz. (2 balls) purple and 3 1/2 oz. (2 balls) lilac **KNITTING** Subita Crepe 2 x 3. Color Nos. 104, 136 and 141. **TENSION:** KNITTING 4 to 6. **STITCH GAUGE:** 17 sts, 2", 24 rows 2". **PATTERN:** Stockinette. Stitch with repeated color stripes on the Jacket as marked in the diagram of the back section. **EDGES:** K1, P1, Ribbing. **SKIRT and NECKLINE DECREASES:** After Rows indicated, hang the 4th st. on the appropriate sides onto the 3rd st., then move the end sts. inward to fill the empty needle. **SLEEVE INCREASES:** After rows indicated, move the 2 and 3 sts. ON EACH SIDE 1 needle outward, then place the 3rd st. from the row below onto the empty needle. The finished length of the skirt is 20 3/4".

FINISHING: Block all sections to measurements given. **SKIRT:** Weave the sections together, 1st. in on each edge. Turn under 2" at lower edge and 1" at upper edge and hem to wrong side. Insert an elastic band into upper hem. **JACKET:** Join front and back sections at sides and shoulders. Sew sleeves together and set in. Sew bands together, then sew band to front edges and neckline. Finish buttonholes, sew on buttons.

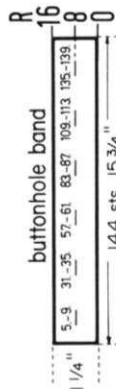
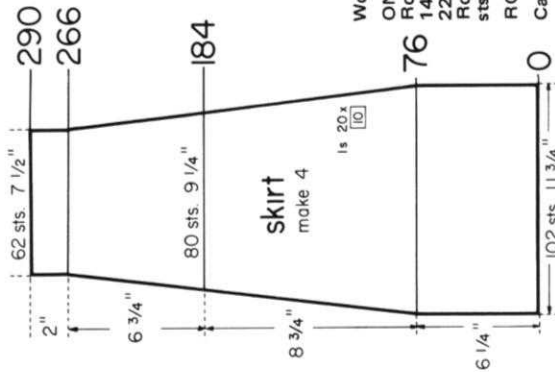

Cast on 144 sts. with white and work K1, P1, Ribbing. Make buttonholes after Row 8 over the sts. marked on the diagram. After Row 16 bind off all sts. Work the button band the same, but omit the buttonholes.

Work 3 more sections the same.

ON EACH SIDE, decrease 1 st. after Rows 76, 86, 96, 106, 116, 126, 136, 146, 156, 166, 176, 186, 206, 216, 226, 236, 246, 256, 266, then knit to Row 290 and bind off the remaining 62 sts.

ROWS 0 to 76: Knit even.

Cast on 102 sts. and work stockinette st.

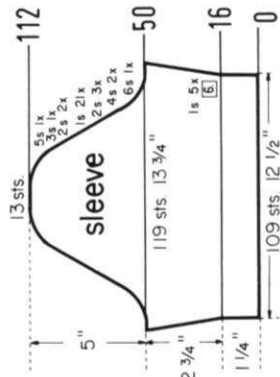

Move the Cam Box to the left side, turn the Row Counter back to 286 and complete the left half. Follow the instructions from *.

* ON CAM BOX SIDE, bind off 4 sts. after Row 286 (EVEN ROWS = SHOULDER SHAPING); 8 sts. (7 sts. for the left half) after Row 287 (ODD ROWS = NECK SHAPING); 4 sts. after Rows 288, 289, 290, 291; 5 sts. after row 292; 4 sts. after Row 293; 5 sts. after Row 294; 3 sts. after Row 295; 5 sts. after Row 296; 3 sts. after Row 297; 5 sts. after Rows 298, 300.

ON CAM BOX SIDE, bind off 5 sts. after Rows 194, 195; 4 sts. after Rows 196, 197, 198, 199; 2 sts. after Rows 200, 201, 202, 203; 1 st. after Rows 204, 205, 206, 207. Now knit to Row 286, then put 62 needles on the left side into holding position and complete the right half first.

ROWS 17 to 194: Knit even.

ROWS 0 to 16: Knit even, then transfer the ribber sts. to the main machine, change to purple and work the repeated color stripes.

Cast on 163 sts. with white and work K1, P1, Ribbing.

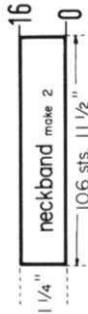
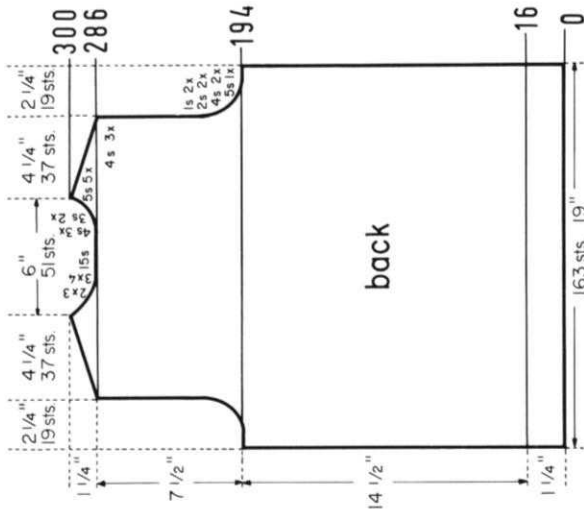

Cast on 106 sts. with white and work 16 rows K1, P1, Ribbing, then bind off all sts.

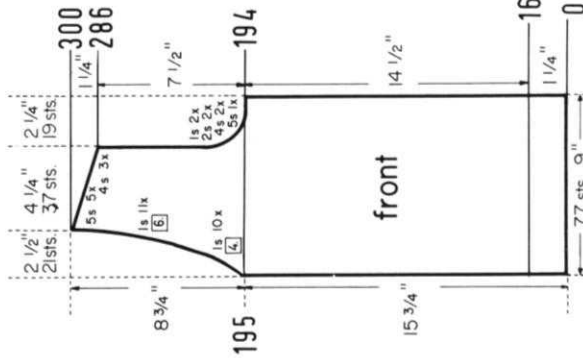

Work the second front section with reverse shapings, casting on from right to left. (Cam Box will be on the LEFT SIDE at Row 0.)

Decrease 1 st. ON CAM BOX SIDE for the NECK after Rows in (). ON CAM BOX SIDE, bind off 5 sts. after Row 194; (195), 4 sts. after Rows 196, 198; (199), 2 sts. after Rows 200, 202; (203), 1 st. after Rows 204, 206. The Armhole is now completed. Continue to decrease 1 st. ON CAM BOX SIDE after Rows 207, 211, 215, 219, 223, 227, 231, 235, 241, 247, 253, 259, 265, 271, 277, 283, then again 1 st. after Rows in (). For SHOULDER, bind off 4 sts. after Rows 286, 288, (289), 290; 5 sts. after Rows 292, 294, (295), 296, 298, 300.

ROWS 17 to 194: Knit even.

ROWS 0 to 16: Knit even, then transfer the ribber sts. to the main machine, change to purple and work the repeated color stripes.

Cast on 77 sts. with white and work K1, P1, Ribbing.

SIZE: 10/12. **MATERIAL:** 17½ oz. (10 balls) pink KNITTING Subita Crepe 2 x 3, Color No. 117. **TENSION:** KNITTING 3 to 5, STITCH GAUGE: Stockinette Stitch 17 sts., 2", 25 rows 2"; Pattern Stitch 17 sts., 2", 30 rows 2". **PATTERN:** Stockinette Stitch and an Eyelet Design according to Line Drawing. Make all shapings of 1 st. Full-fashion. **DECREASES:** After Rows indicated, hang the 4th st. on the appropriate sides onto the 3rd st., then move the end sts. inward to fill the empty needle. **INCREASES:** After Rows indicated, move the 2 end sts. ON EACH SIDE 1 needle outward, then place the 3rd st. from the row below onto the empty needle. The finished length of the Dress is 35½".

FINISHING: Block the sections to measurements given. Join front and back section at sides and shoulders, easing in the fullness at bustline of front section. Turn under 25 rows on lower edge and 3 sts. around armhole edges and hem to wrong side. Ease in the collar edges. Sew 1 edge of collar to inside and 1 edge to outside of neckline, fold in half toward outside. Work 1 row of single crochet around back opening. Work 4 loops on one side and sew 4 buttons to other side of opening. With tension 1, work a cord over 5 needles for the Belt. Knit 1080 rows (the empty rows are counted), then bind off.

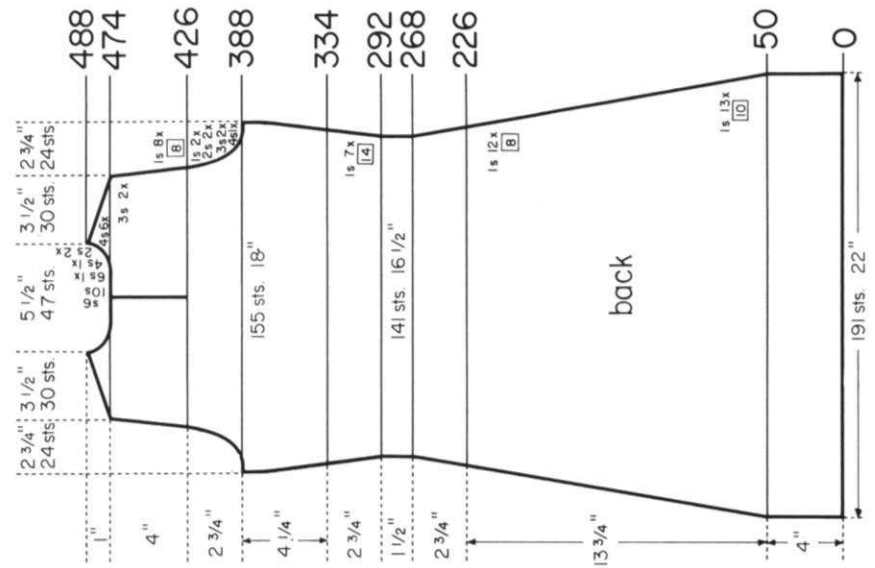

Move the Cam Box to the left side, turn the Row Counter back to 426 and complete the left half. Follow the instructions from *.

ON CAM BOX SIDE, bind off 3 sts. after Row 474 (EVEN ROWS = SHOULDER SHAPING); 10 sts. (9 sts. for the left half) after Row 475 (ODD ROWS = NECK SHAPING); 3 sts. after Row 476; 6 sts. after Row 477; 4 sts. after Row 478, 479, 480; 2 sts. after Row 481; 4 sts. after Row 482; 2 sts. after Row 483; 4 sts. after Rows 484, 486, 488.

* ON CAM BOX SIDE, decrease 1 st. after Rows 426, 434, 442, 450, 458, then knit to Row 474.

ON CAM BOX SIDE, bind off 4 sts. after Rows 388, 389; 3 sts. after Rows 390, 391, 392, 393; 2 sts. after Rows 394, 395, 396, 397; ON EACH SIDE, decrease 1 st. after Rows 398, 400, 402, 410, 418. Now knit to Row 426, put 58 needles on the left side into holding position and complete the right half first.

ON EACH SIDE, increase 1 st. after Rows 292, 306, 320. Now knit to Row 334, change to Stockinette st. AND continue to increase 1 st. ON EACH SIDE after Rows 334, 348, 362, 376, then knit to Row 388

ON EACH SIDE, decrease 1 st. after Rows 50, 60, 70, 80, 90, 100, 110, 120, 130, 140, 150, 160, 170, 180, 188, 196, 204, 212, 220, then knit to Row 226 and begin the Eyelet Design. Continue to decrease 1 st. ON EACH SIDE after Rows 228, 236, 244, 252, 260, 268, then knit even to Row 292.

ROWS 0 to 50: Knit even. Cast on 191 sts. and work stockinette st.

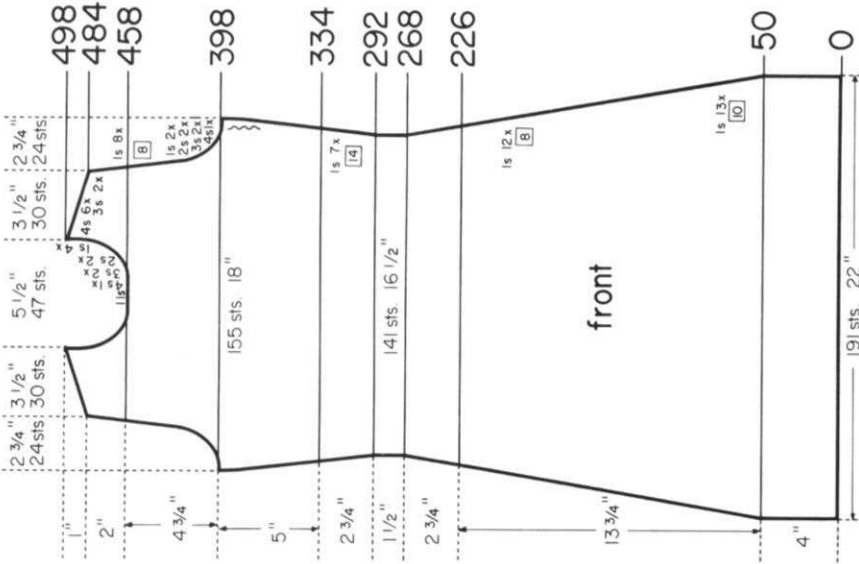

CENTER OF GARMENT SECTION

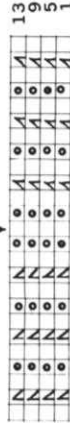

The triangle denotes the center of the garment section. On the right side, hang the sts. onto the right neighboring needles, then transfer the sts. which are to the left of the empty needle onto the empty needle. On the left side hang the sts. onto the left neighboring needles, then transfer the sts. which are to the right of the empty needles onto the empty needles.

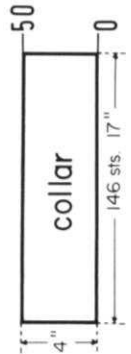

Cast on 146 sts. and work 50 rows Stockinette st., then bind off all sts. the crochet method.

Move the Cam Box to the left side, turn the Row Counter back to 458 and complete the left half. Follow the instructions from *.

* Continue to decrease 1 st. ON CAM BOX SIDE after Rows in (), ON CAM BOX SIDE, bind off 6 sts. (5 sts. for the left half) after Row 459 (ODD ROWS = NECK SHAPING); (460) 4 sts. after Row 461; 3 sts. after Rows 463, 465; 2 sts. after Rows 467, (468 last time for Armhole), 469; 1 st. after Rows 471, 473, 475, 477. For SHOULDER, bind off 3 sts. after Rows 484, 486; 4 sts. after Rows 488, 490, 492, 494, 496, 498.

ON CAM BOX SIDE, bind off 4 sts. after Rows 398, 399; 3 sts. after Rows 400, 401, 402, 403; 2 sts. after Rows 404, 405, 406, 407. ON EACH SIDE, decrease 1 st. after Rows 408, 410, 412, 420, 428, 436, 444, 452, then knit to Row 458, put 55 needles on the left side into holding position and complete the right half first.

ROWS 389 to 398: Knit even.

Work the FRONT SECTION the same as the BACK SECTION to Row 388.

DK 7805

SIZE: 10/12. MATERIAL: 15½ oz. (9 balls) light blue KNITTING Subito, Crepe 2 x 3. Color No. 103. TENSION: KNITTING 3 to 5. STITCH GAUGE: 17 sts, 2", 25 rows 2". PATTERN: Stockinette Stitch. POCKET EDGES: K1, P1, Ribbing. Make all decreases of 1 st. Full-fashion. SIDE SEAMS and ARMHOLES: After rows indicated, hang the 5th st. on the appropriate sides onto the 4th st., then move the end sts. inward to fill the empty needle. FRONT NECKLINE: After rows indicated, hang the 30th st. ON NECK SIDE onto the 29th st., then move the end sts. inward to fill the empty needle. The finished length of the garment is 29".

FINISHING: Block the sections to measurements given. Join front and back section at sides and shoulders. Weave the facing together, then sew the facing to back neckline. Turn under 14 sts. around fronts and neckline and hem to wrong side. Turn under 3 sts. around armholes and hem to wrong side. Sew pockets in place. Turn under 20 rows on lower edge and hem to wrong side. Finish buttonholes, sew on Buttons.

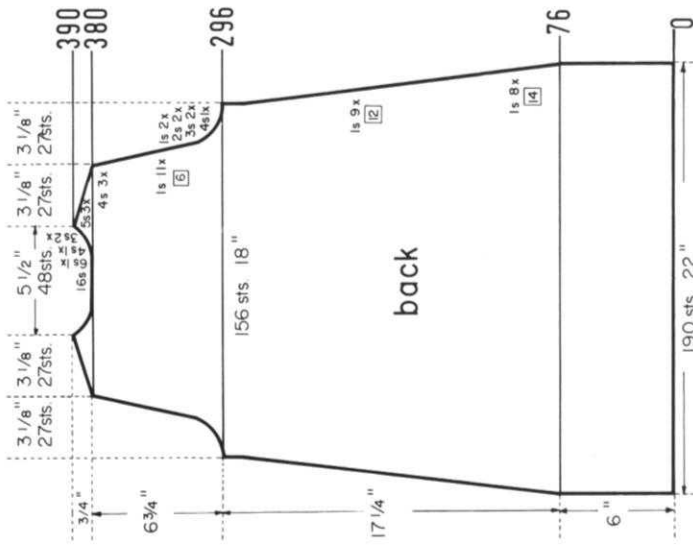

Cast on 59 sts. and work 66 rows stockinette st., then transfer every other st. to the Ribber and work 10 rows K1, P1, Ribbing. After Row 76 bind off all sts. the crochet method for ribbing.



Work the left front section with reverse shapings, casting on from right to left. (Cam Box will be on the LEFT SIDE at Row 0). Omit the buttonholes.

EVEN ROWS = ARMHOLE SHAPING. ON CAM BOX SIDE, bind off 6 sts. after Row 296; (297), 4 sts. after Row 298; (299), 3 sts. after Row 300; (301), 2 sts. after Rows 302, (303), 304. ON CAM BOX SIDE, decrease 1 st. after Rows 305, 306, 307, 308, 309, 310, 311, 315, 318, 319, 323, 326, 327, 331, 334, 335, 339, 342, 343, 347, 350, 351, 355, 358, 359, 363, 366 last time for armhole, 367, 371, 375, 379 last time for neck. For SHOULDER bind off 4 sts. after Rows 380, 382, 384; 5 sts. after Rows 386, 388, 390. Now knit to Row 426 over the remaining 14 sts., then put the sts. on a stitch holder.

ODD ROWS = NECK SHAPING. ON CAM BOX SIDE, decrease 1 st. after Rows 285, 287, 289, 291, 293, 295, then decrease 1 st. ON NECK SIDE after Rows in (.). Knit to Row 296.

Make buttonholes after Rows in () over the 3rd-9th and 20th-26th sts. on the left side. ON CAM BOX SIDE, decrease 1 st. after Rows 76, 90, (90), 104, 118, 132, (134), 146, 160, 174, (178), 188, 200, 212, (222), 224, 236, 248, 260, (266 last buttonholes), 272, 284, then knit to Row 285.

ROWS 21 to 76: Knit even.

ROWS 0 to 20: Knit even, then cast on 28 sts. ON OPPOSITE SIDE of CAM BOX (Use a separate length of yarn).

Cast on 88 sts. and work stockinette st.

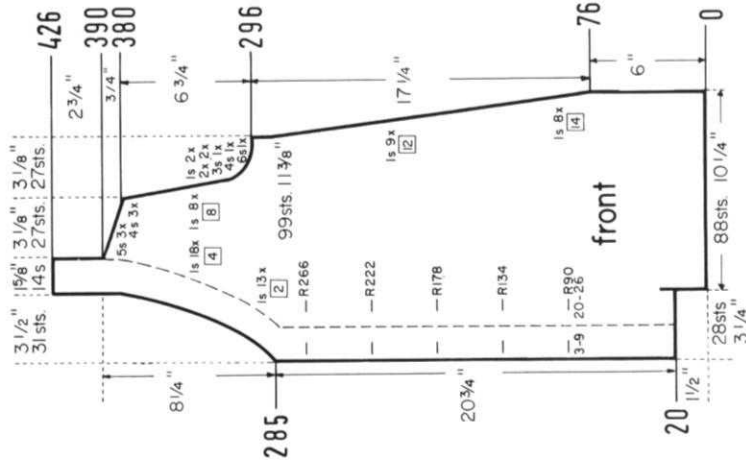

Move the Cam Box to the left side, turn the Row Counter back to Row 380 and complete the left half. Follow the instructions from *.

* ON CAM BOX SIDE, bind off 4 sts. after Row 380 (EVEN ROWS = SHOULDER SHAPING); 8 sts. after Row 381 (ODD ROWS = NECK SHAPING); 4 sts. after Row 382; 6 sts. after Row 383; 4 sts. after Rows 384, 385; 5 sts. after Row 386; 3 sts. after Row 387; 5 sts. after Row 388; 3 sts. after Row 389; 5 sts. after Row 390.

ON CAM BOX SIDE, bind off 4 sts. after Rows 296, 297; 3 sts. after Rows 298, 299, 300, 301; 2 sts. after Rows 302, 303, 304, 305. ON EACH SIDE, decrease 1 st. after Rows 306, 308, 310, 316, 322, 328, 334, 340, 346, 352, 358, 364, 370. Now knit to Row 380, put 51 needles on the left side into holding position and complete the right half first.

ON EACH SIDE, decrease 1 st. after Rows 76, 90, 104, 118, 132, 146, 160, 174, 188, 200, 212, 224, 236, 248, 260, 272, 284, then knit to Row 296.

ROWS 0 to 76: Knit even.

Cast on 190 sts. and work stockinette st.

A complete fifth volume of KNITTING MAGAZINES with a flexible, transparent plastic cover and specially bound so that it will stay open at any page, is available at the special price of \$6.95 (plus 85 cents mailing costs).

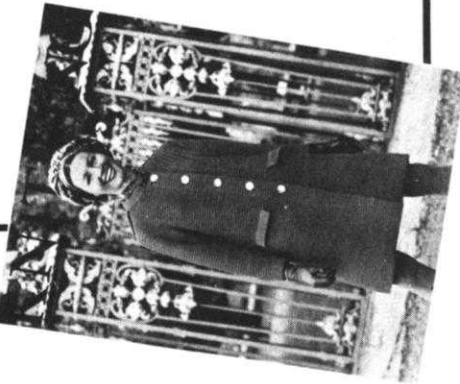

If purchased separately the magazines would cost a total of \$9.00.

The volume contains over 120 fully illustrated complete stylish patterns for all members of the family, together with many valuable, practical knitting hints.

There is a very limited number of these volumes available and it will undoubtedly become a collectors item.

If you already have the entire set it will almost certainly be well thumbed and marked. Why not purchase a perfect mint condition volume for your bookshelf and ready reference at any time.

Place your order today and avoid disappointment. Send it to **KNITTING MAGAZINE, 1128 Crenshaw Boulevard, Los Angeles, California 90019.**

DP 7809

SIZE: 10/12. **MATERIAL:** 8% oz. (5 balls) light blue KNITTING Subita Crepe 2 x 3, Color No. 103. **TENSION:** KNITTING 4 to 6. **STITCH GAUGE:** 16 sts, 2" 35 rows 2". **PATTERN:** Holding Position Design according to Line Drawing. **KNITTING Machines** use Wheel No. 3 and push in the left Retractor Button. Remember to change number setting when increasing and decreasing.

FINISHING: Block all sections to measurements given. **PANTS:** With running stitch, gather side edges of back section to 4". Back stitch front and back section together. Join sections at crotch. Turn under a small amount at upper edge and leg edges, hem to wrong side and insert elastic bands into hems. **BRA:** Join front and back sections at sides and shoulders. Turn under a small amount at armhole and neckline edges, hem to wrong side and insert elastic bands into hems. Adjust bands to fit. Fold right front edge over left front edge, overlapping edges about 2", then sew in place. Form 3 small pleats to each side of the overlap and baste in place. Turn under 3/4" on back edges and hem to wrong side. Sew band to lower edge, fold to wrong side and hem. Insert an elastic band into hem. Make 3 loops on one side of back opening and sew 3 buttons to other side.

Cast on 13 sts. and work 490 rows in Holding Position Design, then bind off all sts.

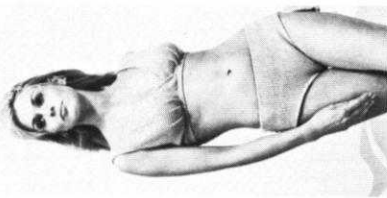
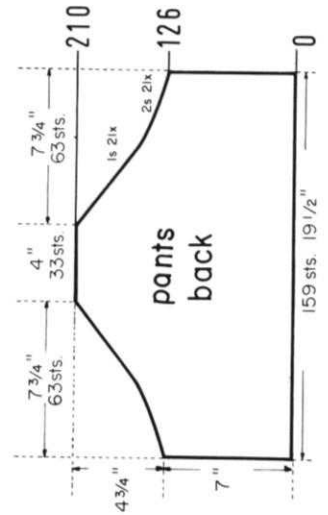
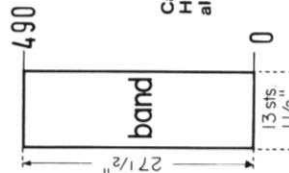

CENTER OF GARMENT SECTION

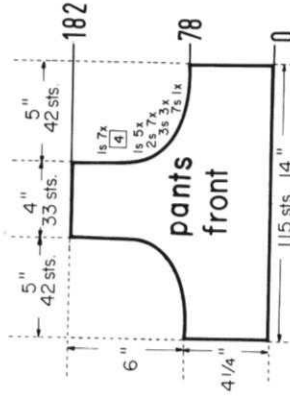
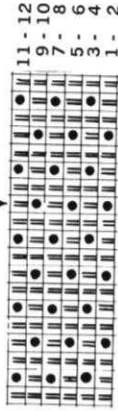

ON CAM BOX SIDE, bind off 2 sts. after Rows 126, 127, 128, 129, 130, 131, 132, 133, 134, 135, 136, 137, 138, 139, 140, 141, 142, 143, 144, 145, 146, 147, 148, 149, 150, 151, 152, 153, 154, 155, 156, 157, 158, 159, 160, 161, 162, 163, 164, 165, 166, 167. **ON EACH SIDE,** hang the 1st st. onto the 2nd st. after Rows 168, 170, 172, 174, 176, 178, 180, 182, 184, 186, 188, 190, 192, 194, 196, 198, 200, 202, 204, 206, 208. After Row 201 bind off the remaining 33 sts.

ROWS 0 to 126: Knit even.

Cast on 159 sts. and work the Holding Position Design

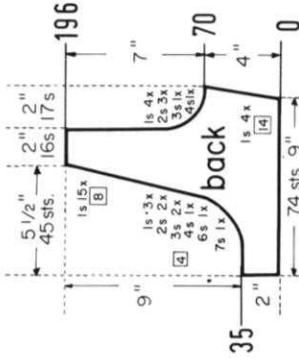

ON CAM BOX SIDE, bind off 7 sts. after Rows 78, 79; 3 sts. after Rows 80, 81, 82, 83, 84, 85; 2 sts. after Rows 86, 87, 88, 89, 90, 91, 92, 93, 94, 95, 96, 97, 98, 99. **ON EACH SIDE,** hang the 1st st. onto the 2nd st. after Rows 100, 102, 104, 106, 108, 110, 114, 118, 122, 126, 130, 134. Now knit to Row 182, then bind off the remaining 33 sts.

ROWS 0 to 78: Knit even.

Cast on 115 sts. and work the Holding Position Design.

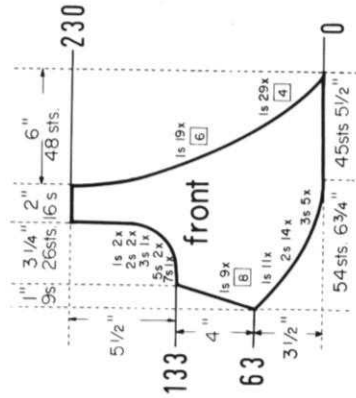

Work the second back section with reverse shapings. Cast on the regular way, then knit 1 row (IN PATTERN) to the left side. Turn the Row Counter to 0 and follow the instructions.

Continue to decrease 1 st. **ON CAM BOX SIDE** after Rows in (). **ON CAM BOX SIDE,** bind off 4 sts. after Row 70; (71), 3 sts. after Row 72; 2 sts. after Rows 74, (75), 76, 78; 1 st. after Rows 80, 82, (83), 84, 86. The armhole is now completed. Continue to decrease 1 st. **ON CAM BOX SIDE** after Rows 91, 99, 107, 115, 123, 131, 139, 147, 155, 163, 171, 179, 187. Now knit to Row 196, then bind off the remaining 16 sts.

Continue to **INCREASE** 1 st. **ON CAM BOX SIDE** after Rows in (). **ON CAM BOX SIDE,** bind off 7 sts. after Row 35; 6 sts. after Row 39; (42), 4 sts. after Row 43; 3 sts. after Rows 47, 51; 2 sts. after Rows 55, (56 last time for Side Seam), 59; 1 st. after Rows 63, 67, then knit to Row 70.

ON CAM BOX SIDE, INCREASE 1 st. after Rows 14, 28, then knit to Row 35. Cast on 74 sts. and work the Holding Position Design. **EVEN ROWS = SIDE SEAM,** then **ARMHOLE SHAPING;** **ODD ROWS = NECK SHAPING.**

Work the second front section with reverse shapings. Cast on the regular way, then knit 1 row (IN PATTERN) to the left side. Turn the Row Counter to 0 and follow the instructions.

Decrease 1 st. **ON CAM BOX SIDE** after Rows in (). **ON CAM BOX SIDE,** bind off 7 sts. after Row 133; 5 sts. after Rows 135, (136), 137; 3 sts. after Row 139; 2 sts. after Rows 141, (142), 143; 1 st. after Rows 145, 147. The armhole is now completed. Continue to decrease 1 st. **ON CAM BOX SIDE** after Rows 148, 154, 160, 166, 172, 178, 184, 190, 196, 202, 208, 214, 220, 226. After Row 230 bind off the remaining 16 sts.

ON CAM BOX SIDE, decrease 1 st. after Rows 63, 66, 70, 74, 78, 79, 82, 86, 87, 90, 94, 95, 98, 102, 103, 106, 110, 111, 114, 118, 119, 124, 127, 130, then knit to Row 133.

Decrease 1 st. **ON CAM BOX SIDE** after Rows in (). **ON CAM BOX SIDE,** cast on 3 sts. after Rows 1, (2), 3, 5, (6), 7, 9; (10), 2 sts. after Rows 11, 13, (14), 15, 17, (18), 19, 21, (22), 23, 25, (26), 27, 29, (30), 31, 33, (34), 35, 37; (38), 1 st. after Rows 39, 41, (42), 43, 45, (46), 47, 49, (50), 51, 53, (54), 55, 57, (58), 59, (62), then knit to Row 63. The increases for the lower edge are now completed.

Cast on 45 sts. and work the Holding Position Design. **EVEN ROWS = NECKLINE SHAPING;** **ODD ROWS = LOWER EDGE,** then **SIDE SEAM,** then **ARMHOLE SHAPING.**

DK 7804

SIZE: 12/14. **MATERIAL:** 5¼ oz. (3 balls) white, 5¼ oz. (3 balls) yellow, 5¼ oz. (3 balls) green and 3½ oz. (2 balls) dark blue **KNITTING** Subita Dralon 3 ply or **KNITTING** Fatme Boucle. **Dralon** Color Nos. 401, 425, 426, 437. **TENSION:** **KNITTING** 4 to 6. **STITCH GAUGE:** 16 sts, 2", 24 rows 2". **PATTERN:** Stockinette Stitch with repeated color stripes as marked in the diagram of the back section. **SIDE SEAM** and **NECKLINE DECREASES:** After rows indicated, hang the 4th st. on the appropriate sides onto the 3rd st. then move the end sts. inward to fill the empty needle. The finished length of the dress is 33".

FINISHING: Block the sections to measurements given. Join front and back section at sides and shoulders. Turn under 3 sts. around armholes and hem to wrong side. Turn under 14 rows on lower edge and hem to wrong side. Join neckband sections, then sew 1 edge to inside and 1 edge to outside of neckline.

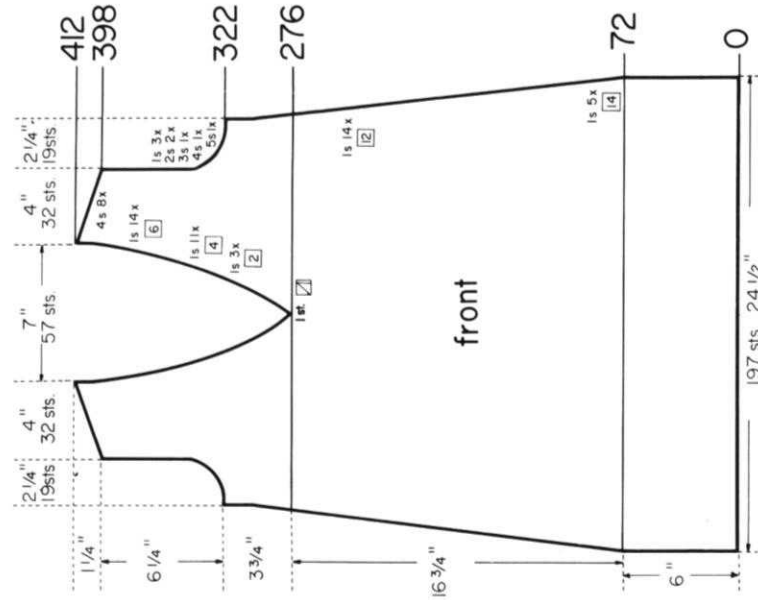

front

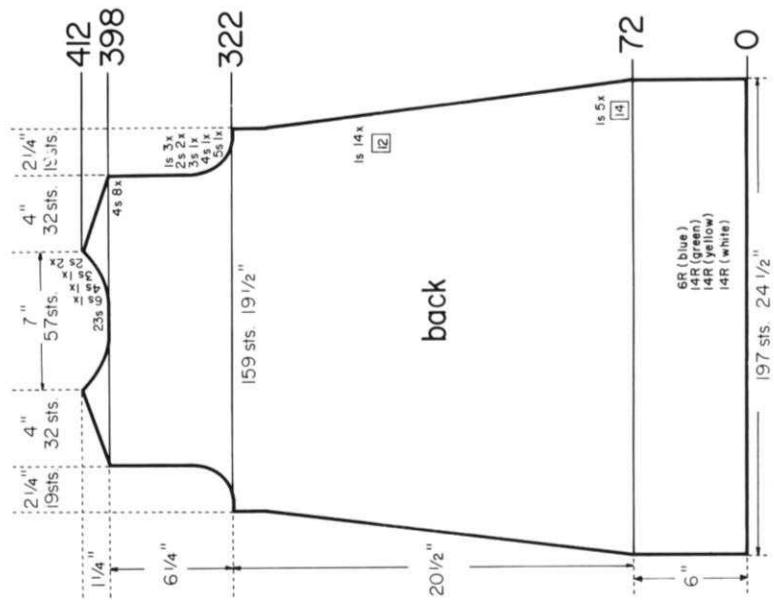

back

6R (blue)
1AR (green)
1AR (yellow)
1AR (white)

Move the Cam box to the left side, turn the Row Counter back to 276 and in-complete the left half. Follow the in-structions from *.

ON CAM BOX SIDE, bind off 5 sts. after Row 322; 4 sts. after Row 324; (325), 3 sts. after Row 326; 2 sts. after Rows 328, (329), 330; 1 st. after Rows 332, 334, (335), 336. The Armhole is now completed. Continue to decrease 1 st. **ON CAM BOX SIDE** after Rows 341, 347, 353, 359, 365, 371, 377, 383, 389, 395, then after Rows in (). For **SHOULDER,** bind off 4 sts. after Rows 398, 400, (401), 402, 404, 406, (407), 408, 410, 412.

* Continue to decrease 1 st. **ON CAM BOX SIDE** after Rows in (). **ON CAM BOX SIDE,** decrease 1 st. after Rows 279, 281, 283, 285, (286), 289, 293, 297, (298) 301, 305, 309, 313, 317, 321, then decrease 1 st. **ON CAM BOX SIDE** after Rows in (). Knit to Row 322.

ON EACH SIDE, decrease 1 st. after Rows 72, 86, 100, 114, 128, 142, 154, 166, 178, 190, 202, 214, 226, 238, 250, 262, 274. Now knit to Row 276, hang the center st. onto the neighboring needle, put the needles on the left side into holding position and complete the right half first.

ROWS 0 to 72: Knit even.

Cast on 197 sts. with white, work stockinette st. and the repeated color stripes.

Move the Cam Box to the left side, turn the Row Counter back to 398 and complete the left half. Follow the in-structions from *.

* **ON CAM BOX SIDE,** bind off 4 sts. after Row 398 (**EVEN ROWS = SHOULDER SHAPING**); 12 sts. (11 sts. for the left half) after Row 399 (**ODD ROWS = NECK SHAPING**); 4 sts. after Row 400; 6 sts. after Row 401; 4 sts. after Rows 402, 403, 404; 3 sts. after Row 405; 4 sts. after Row 406; 2 sts. after Row 407; 4 sts. after Row 408; 2 sts. after Row 409; 4 sts. after Rows 410, 412.

ON CAM BOX SIDE, bind off 5 sts. after Rows 322, 323; 4 sts. after Rows 324, 325; 3 sts. after Rows 326, 327; 2 sts. after Rows 328, 329, 330, 331; 1 st. after Rows 332, 333, 334, 335, 336, 337, then knit to Row 398, put 60 needles on the left side into holding position and complete the right half first.

ON EACH SIDE, decrease 1 st. after Rows 72, 86, 100, 114, 128, 142, 154, 166, 178, 190, 202, 214, 226, 238, 250, 262, 274, 286, 298, then knit to Row 322.

ROWS 0 to 72: Knit even.

Cast on 197 sts. with white, work stockinette st. and the repeated color stripes.

Cast on 104 sts. with blue and work stockinette st. **ON OPPOSITE SIDE** of **CAM BOX,** decrease 1 st. after Rows 2, 4, 6, 8, 10, 12, 14, then increase 1 st. after Rows 16, 18, 20, 22, 24, 26, 28. After Row 30 bind off all sts. the crochét method. Work the second section with reverse shaping.



CANADIAN READERS

Please note that **KNITTING** dealers based in the U.S.A. are unable to sell machines and accessories to residents of Canada. They are also unable to sell parts and service. Would all Canadian readers please contact the following appointed **KNITTING** dealer.

KNITTING Sales and Service
2243 Danforth Ave.
Toronto 13, Ontario

SIZE: 16/18. MATERIAL: 14 oz. (8 balls) green, 3 1/2 oz. (2 balls) white and 1 1/2 oz. (1 ball) red KNITTING Fatme Boucle. TENSION: KNITTING 3 to 5, STITCH GAUGE: 16 sts, 2", 24 rows 2". PATTERN: Stockinette Stitch and color stripes on lower edge and neckline. The purl side is the right side. On lower edge and neckband the knit side is right side. Make ALL decreases of 1 st. Full-fashion. After rows indicated, hang the 4th st. on the appropriate sides onto the 3rd st., then move the end sts. inward to fill the empty needle. The finished length of the Tunic is 32 3/4".

FINISHING: Block the sections to measurements given. Leaving 8 1/2" at the lower edges open for the slits, join front and back section at sides and shoulders. Fold over 22 rows on lower edge and hem to right side. With purl sides together, sew slit facings to slit edges, then turn to wrong side and hem in place. Finish hem side edges. Join neckband sections. Sew 1 edge of neckband to inside and 1 edge to outside of neckline. Turn under 3 sts. around armholes and hem to wrong side.

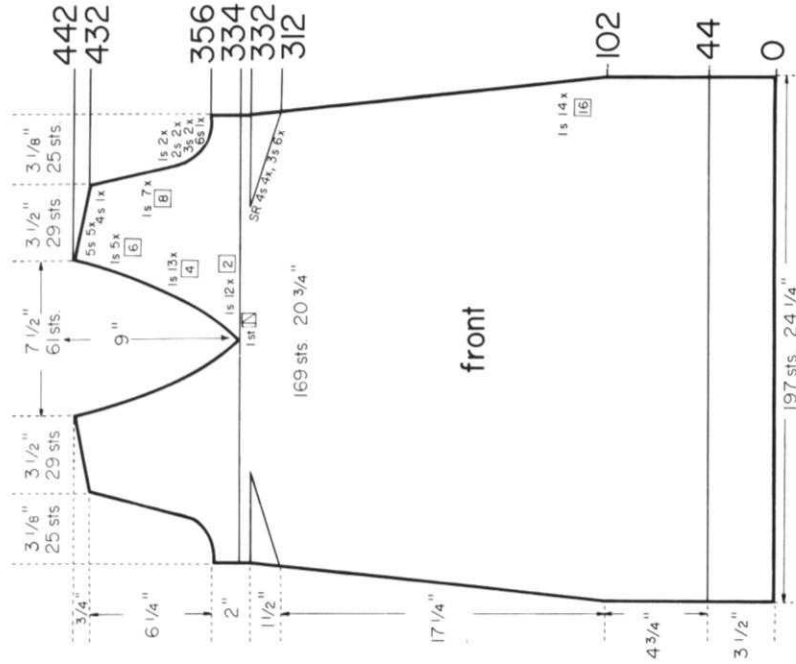

Move the Cam Box to the left side, turn the Row Counter back to 334 and complete the left half. Follow the instructions from *.

ON CAM BOX SIDE, bind off 6 sts. after Row 356; (356), 3 sts. after Rows 358, (358), 360; (360), 2 sts. after Rows 362, 364; (364), 1 st. after Rows 366, 368; (368), 370, (372), (376), 378, (380), (384), 386, (388), (392), 394, (396), (400), 402, (404), (408), 410, (412), 418 last time for Armhole, (418), (424), (430), AND for SHOULDER, bind off 4 sts. after Row 432; 5 sts. after Rows 434, 436, (436 last time for Neck), 438, 440, 442.

* ON OPPOSITE SIDE of CAM BOX decrease 1 st. after Rows 336, 338, 340, 342, 344, 346, 348, 350, 352, 354, then continue to decrease 1 st. ON NECK SIDE after ALL Rows in (). Knit to Row 356.

FOR THE BUST DARTS work Short Rows. ON OPPOSITE SIDE of CAM BOX put into holding position 4 needles after Rows 312, 313, 314, 315, 316, 317, 318, 319; 3 needles after Rows 320, 321, 322, 323, 324, 325, 326, 327, 328, 329, 330, 331. ON OPPOSITE SIDE of CAM BOX bring all needles back into working position after Rows 332, 333. Now knit to Row 334, then hang the center st. onto the neighboring needle, put the 84 needles on the left side into holding position and complete the right half first.

ON EACH SIDE, decrease 1 st. after Rows 102, 118, 134, 150, 166, 182, 198, 214, 230, 246, 262, 278, 294, 310, then knit to Row 312.

ROWS 45 to 102: Knit even.

ROWS 0 to 44: Knit even, then change to green.

Cast on 197 sts. with white, work stockinette st. and the color stripes as marked in the diagram of the back section.

SIZE: 5-6. (Chest 23"-24"), MATERIAL: 3 1/2 oz. (2 balls) turquoise, 3 1/2 oz. (2 balls) yellow and 1 1/2 oz. (1 ball) blue KNITTING Subita Dralon 2 ply, Color Nos. 444, 425 and 437. TENSION: KNITTING 1 to 2. STITCH GAUGE: 19 sts, 2", 30 rows 2". PATTERN: Stockinette Stitch and repeated color stripes as marked in the diagram. INCREASES for PANTS and CROTCH: After rows indicated, move the 2 and end sts. ON EACH SIDE 1 needle outward, then place the 3rd st. from the row below onto the empty needle. DECREASES for DRESS and CROTCH: After rows indicated, hang the 3rd st. ON EACH SIDE onto the 2nd st., then move the end sts. inward to fill the empty needle.

FINISHING: Block all sections to measurements given. DRESS: Join front and back section at sides. Turn under 1 1/2" at lower edge and hem to wrong side. Beginning at armhole edges, join shoulders about 3/4". With blue, work 2 rows of single crochet around armhole, neck and shoulder edges. Work 3 loops on each front shoulder and sew 3 buttons to each back shoulder. PANTS: Join pants sections at front and back center. Sew in crotch, then join short ends of leg edges. Turn under 9 rows on upper edge, hem to wrong side and insert an elastic band.

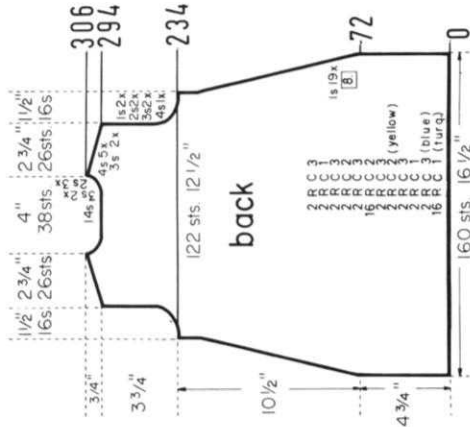

Move the Cam Box to the left side, turn the Row Counter back to 294 and complete the left half. Follow the instructions from *.

* ON CAM BOX SIDE, bind off 3 sts. after Row 294 (EVEN ROWS = SHOULDER SHAPING); 7 sts. after Row 295 (ODD ROWS = NECK SHAPING); 3 sts. after Rows 296, 297, 4 sts. after Row 298; 3 sts. after Row 299; 4 sts. after Row 300; 2 sts. after Row 301; 4 sts. after Row 302; 2 sts. after Row 303, 4 sts. after Row 304; 2 sts. after Row 305; 4 sts. after Row 306.

ON CAM BOX SIDE, bind off 4 sts. after Rows 234, 235; 3 sts. after Rows 236, 237, 238, 239; 2 sts. after Rows 240, 241, 242, 243; 1 st. after Rows 244, 245, 246, 247. Now knit to Row 294, then put 45 needles on the left side into holding position and complete the right half first.

ON EACH SIDE, decrease 1 st. after Rows 72, 88, 96, 104, 112, 120, 128, 136, 144, 152, 160, 168, 176, 184, 192, 200, 208, 216, then knit to 234.

ROWS 0 to 72: Knit even.

Cast on 160 sts. with turquoise, work stockinette st. and the repeated color stripes.

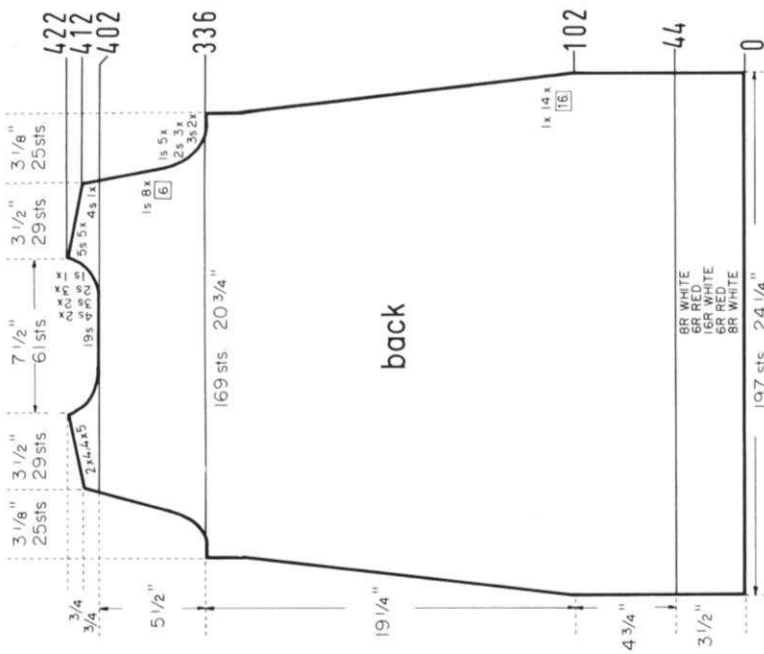

back

BR WHITE
BR RED
BR RED
BR WHITE

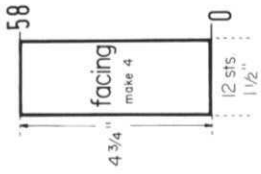

Cast on 12 sts. with green and work 58 rows stockinette st., then bind off all sts.

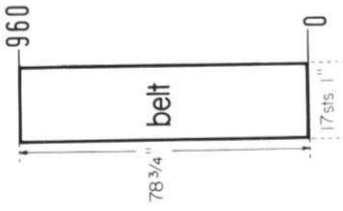

Cast on 17 sts. with green and work 960 rows K1, P1, Ribbing, then bind off all sts.



Cast on 113 sts. with white, work stockinette st. and the color stripes as marked in the diagram of the back section. ON CAM BOX SIDE, bind off 2 sts. after Rows 1, 3, 5, 7, 9, 11, 13, 15, 17, 19, 21, then cast on 2 sts. after Rows 23, 25, 27, 29, 31, 33, 35, 37, 39, 41, 43. After Row 44, bind off all sts. the crochet method. Work the second section with reverse shaping, casting on from right to left. Cam Box will be on the LEFT SIDE at Row 0.

Move the Cam Box to the left side, turn the Row Counter back to 402 and complete the left half. Follow the instructions from *.

* ON CAM BOX SIDE, bind off 10 sts. (9 sts. for the left half) after Row 403. (ODD ROWS = NECK SHAPING); 4 sts. after Rows 405, 407; 3 sts. after Rows 409, 411; 4 sts. after Row 412 (EVEN ROWS = SHOULDER SHAPING); 2 sts. after Row 413; 5 sts. after Row 414; 2 sts. after Row 415; 5 sts. after Row 416; 2 sts. after Row 417; 5 sts. after Row 418; 1 st. after Row 419; 5 sts. after Row 420; 422.

ON CAM BOX SIDE, bind off 3 sts. after Rows 336, 337, 338, 339; 2 sts. after Rows 340, 341, 342, 343, 344, 345. ON EACH SIDE, decrease 1 st. after Rows 346, 348, 350, 352, 354, 356, 362, 368, 374, 380, 386, 392, 398. Now knit to Row 402, put 59 needles on the left side into holding position and complete the right half first.

ON EACH SIDE, decrease 1 st. after Rows 102, 118, 134, 150, 166, 182, 198, 214, 230, 246, 262, 278, 294, 310, then knit to Row 336.

ROWS 45 to 102: Knit even.

ROWS 0 to 44: Knit even, then change to green.

Cast on 197 sts. with white, work stockinette st. and the color stripes as marked in the diagram.

Move the Cam Box to the left side, turn the Row Counter back to 276 and complete the left half. Follow the instructions from *.

* ON CAM BOX SIDE, bind off 5 sts. after Row 277 (ODD ROWS = NECK SHAPING); 3 sts. after Rows 279, 281; 2 sts. after Rows 283, 285, 287; 1 st. after Rows 289, 291. For SHOULDER, bind off 3 sts. after Rows 294, 296; 4 sts. after Rows 298, 300, 302, 304, 306.

ON CAM BOX SIDE, bind off 4 sts. after Rows 234, 235; 3 sts. after Rows 236, 237, 238, 239; 2 sts. after Rows 240, 241, 242, 243; 1 st. after Rows 244, 245, 246, 247. Now knit to Row 276, then put 45 needles on the left side into holding position and complete the right half first.

ON EACH SIDE, decrease 1 st. after Rows 72, 80, 88, 96, 104, 112, 120, 128, 136, 144, 152, 160, 168, 176, 184, 192, 200, 208, 216, then knit to Row 234.

ROWS 0 to 72: Knit even.

Cast on 160 sts. with turquoise, work stockinette st. and repeated color stripes as marked in the diagram of the back section.

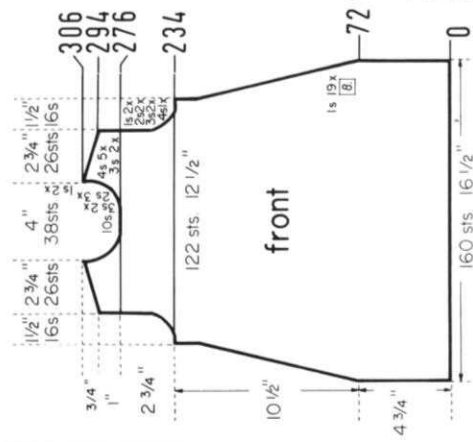

front

crotch

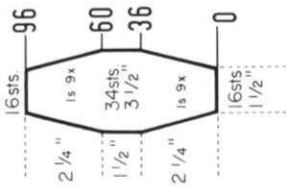

Cast on 16 sts. with turquoise and work stockinette st. ON EACH SIDE, increase 1 st. after Rows 4, 8, 12, 16, 20, 24, 28, 32, 36. ON EACH SIDE, decrease 1 st. after Rows 60, 64, 68, 72, 76, 80, 84, 88, 92. After Row 96 bind off all 16 sts.

Work the second section with reverse shapings, casting on from right to left. (Cam Box will be on the LEFT SIDE at Row 0).

Work Short Rows for the shaping of the back. ON OPPOSITE SIDE of CAM BOX put into holding position 30 needles after Row 132; 8 needles after Rows 134, 136, 138, 140, 142, 144, 146, 148. After Row 150 bring all needles back into working position. Knit even to Row 168, then bind off all 115 sts.

ON EACH SIDE, increase 1 st. after Row 24. After Row 26 change to turquoise and work the repeated color stripes as marked in the diagram of the back section of the dress. Continue to increase 1 st. ON EACH SIDE after Rows 30, 36, 42, 48, 54, 60, 62, 64, 66, 68, 70, then knit even to Row 132.

ROWS 0 to 24: Work 12 rows yellow, 2 rows blue and 10 rows yellow. After Row 24 bind off 12 sts. ON OPPOSITE SIDE of CAM BOX. (Use a separate length of yarn). Now transfer the remaining ribber sts. to the main machine, change to blue and work stockinette st.

Cast on 103 sts. with yellow and work K1, P1, Ribbing

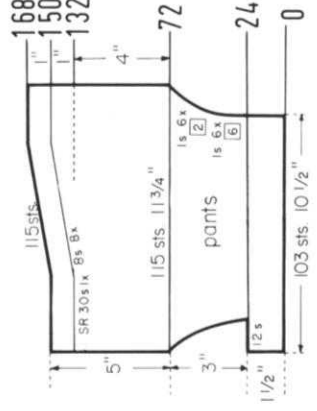

SIZE: 12/14. **MATERIAL:** 12½ oz. (7 balls) natural KNITTING Linen-Cotton and small amounts of red and green KNITTING Satin-Cotton 2 x 8, Color Nos. 7105, 730 and 733. **TENSION:** KNITTING 3 to 5 STITCH GAUGE: Stockinette Stitch 16 sts. 2", 24 rows 2"; K1, P1, Ribbing 16 sts. 2", 28 rows 2". **PATTERN:** Stockinette Stitch with K1, P1, Ribbing at the waistline. The puri side is the right side. **ARMHOLE** and **NECKLINE** EDGES: Single crochet. Make shapings of 1 st. at armholes full-fashion. After rows indicated, hang the 4th st. on the appropriate sides onto the 3rd st., then move the end sts. inward to fill the empty needle.

FINISHING: Block the sections to measurements given. Join front and back section at sides and shoulders, easing in the fullness at bustline of front section. Turn under 20 rows at lower edge and hem to wrong side. Work 8 rows of single crochet (2 rows natural, 2 rows red, 2 rows natural and 2 rows green) around armholes, neckline and on upper pocket edges. Sew pockets to shell. (See picture)

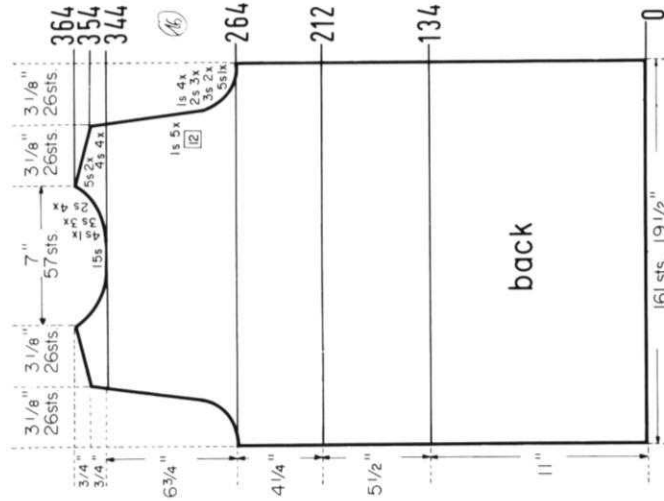
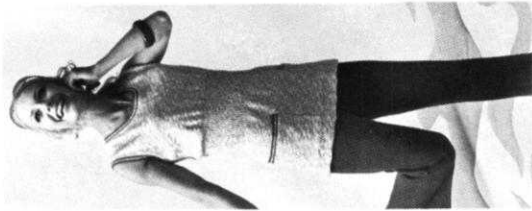

Cast on 55 sts. and work 78 rows stockinette st., then bind off all sts.

Move the Cam Box to the left side, turn the Row Counter back to 344 and complete the left half. Follow the instructions from *.

* ON CAM BOX SIDE, bind off 8 sts. (7 sts. for the left half) after Row 345 (ODD ROWS = NECK SHAPING); 4 sts. after Row 347; 3 sts. after Row 349, 351, 353; 4 sts. after Row 354 (EVEN ROWS = SHOULDER SHAPING); 2 sts. after Row 355; 4 sts. after Row 356; 2 sts. after Row 357; 4 sts. after Row 358; 2 sts. after Row 359; 4 sts. after Row 360; 2 sts. after Row 361; 5 sts. after Row 362, 364.

ON CAM BOX SIDE, bind off 5 sts. after Rows 264, 265; 3 sts. after Rows 266, 267, 268, 269; 2 sts. after Rows 270, 271, 272, 273, 274, 275. ON EACH SIDE, decrease 1 st. after Rows 276, 278, 280, 282, 284, 296, 308, 320, 332. Now knit even to Row 344, put 54 needles on the left side into holding position and complete the right half first.

ROWS 213 to 264: Knit even.

ROWS 135 to 212: Knit even, then transfer the Ribber sts. back to the main machine and continue with stockinette st.

ROWS 0 to 134: Knit even, then transfer every other st. to the Ribber and work K1, P1, Ribbing.

Cast on 161 sts. and work stockinette st.

Move the Cam Box to the left side, turn the Row Counter back to 298 and complete the left half. Follow the instructions from *.

* Continue to decrease 1 st. ON CAM BOX SIDE after Rows in (). ON CAM BOX SIDE, bind off 8 sts. (7 sts. for the left half) after Row 299 (ODD ROWS = NECK SHAPING); 3 sts. after Rows 301, 303, 2 sts. after Rows 305, (306), 307, 309; 1 st. after Rows 311, 313, 315, 317, (318), 319, 321, 325, 329, (330), 333, (342). For SHOULDER bind off 4 sts. after Rows 364, 366, 368, 370; 5 sts. after Rows 372, 374.

ON CAM BOX SIDE, bind off 5 sts. after Rows 274, 275; 3 sts. after Rows 276, 277, 278, 279; 2 sts. after Rows 280, 281, 282, 283, 284, 285. ON EACH SIDE, decrease 1 st. after Rows 286, 288, 290, 292, 294. Now knit to Row 298, put 58 needles on the left side into holding position and complete the right half first.

ROWS 213 to 274: Knit even.

ROWS 135 to 212: Knit even, then transfer the Ribber sts. back to the main machine and continue with stockinette st.

ROWS 0 to 134: Knit even, then transfer every other st. to the Ribber and work K1, P1, Ribbing.

Cast on 161 sts. and work stockinette st.

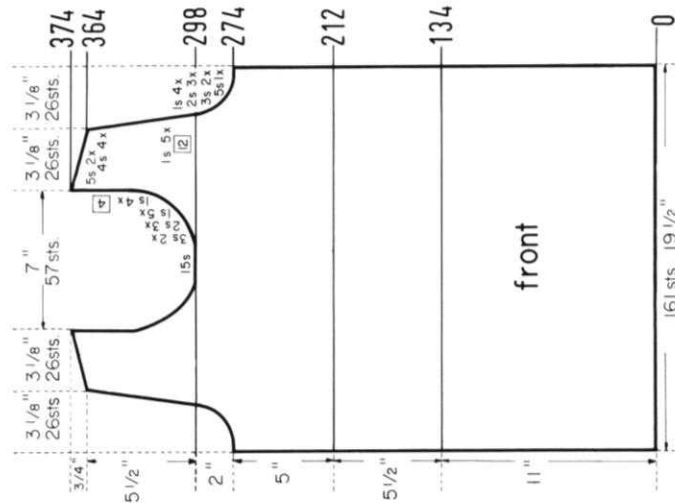

KNITKINGS' INTERCHANGEABLE YARN CHART
ALLOWS YOU TO SUBSTITUTE NATIONALLY SOLD
YARNS. PRICE \$1.00 PLUS 12c POSTAGE. CALIF.
RESIDENTS 5c SALES TAX.

DP 7807

SIZE: 14/16. **MATERIAL:** 15½ oz. (9 balls) yellow KNITTING Subita Crepe 2 x 3, Color No. 105. **TENSION:** KNITTING 4 to 6. **STITCH GAUGE:** 19 sts, 2", 27 rows 2" PATTERN: Holding Position Design according to Line Drawing. **EDGES:** K1, P1, Ribbing. **FOR FRONT SHAPING,** always hang the 3rd st. **ON NECK SIDE** onto the 2nd st., then move the end sts. inward to fill the empty needle. Transfer the ribber sts. to the main machine before putting the needles on the left side into holding position. Bind off the ribbed sections the crochet method for ribbing.

FINISHING: Block sections to measurements given. Weave front and back section together at sides, 1½ sts. in on each edge, easing in the fullness at bustline of front section. Join shoulders. Join neckbands at center front and back, then sew to neckline. Join armhole bands at short ends, then sew to armholes. Sew a buckle to the belt.

CENTER OF GARMENT SECTION

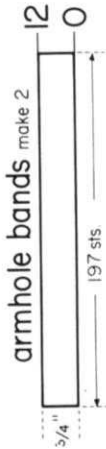
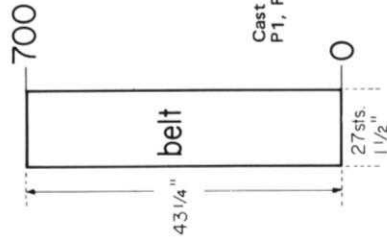
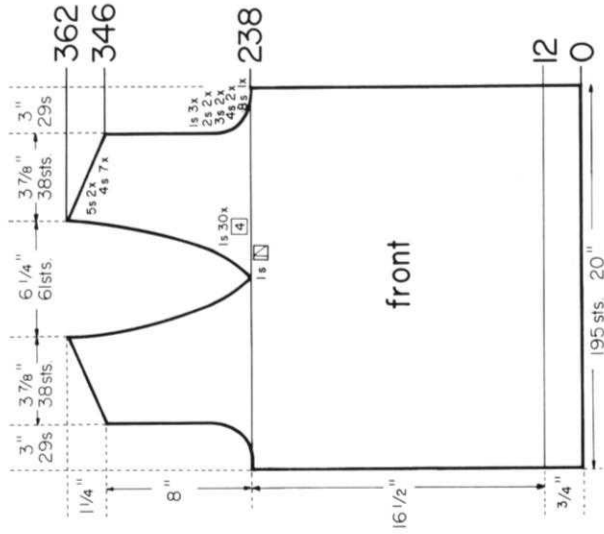
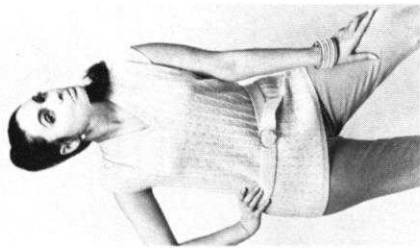
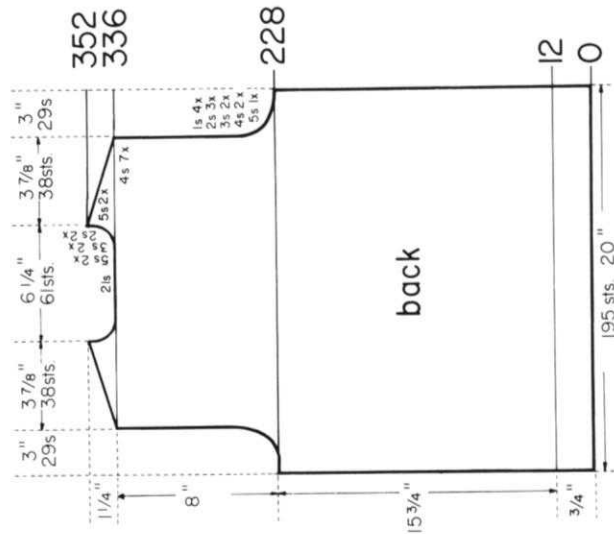
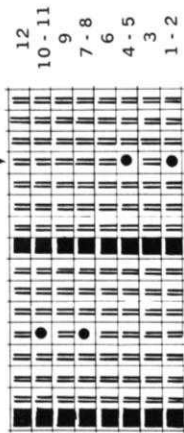

Move the Cam Box to the left side, turn the Row Counter back to 238 and complete the left half. Follow the instructions from *.

* Decrease 1 st. on NECK SIDE after Rows in (). ON CAM BOX SIDE, bind off 8 sts. after Row 238; 4 sts. after Rows 240, 242; (242), 3 sts. after Rows 244, 246; (246), 2 sts. after Rows 248, 250; (250), 1 st. after Rows 252, 254, (254), 256. The armhole is now completed. Continue to decrease 1 st. ON NECK SIDE after Rows 258, 262, 266, 270, 274, 278, 282, 286, 290, 294, 298, 302, 306, 310, 314, 318, 322, 326, 330, 334, 338, 342, then 1 st. after Rows in (). For SHOULDER, bind off 4 sts. after Rows 346, (346), 348, 350, (350), 352, 354, (354), 356, 358; (358 last time for Neck), 5 sts. after Rows 360, 362.

ROWS 13 to 238: Knit even, then transfer the center st. to the neighboring needle, put the 97 needles on the left side into holding position and complete the right half first.

ROWS 0 to 12: Knit even, then set up for PATTERN and continue in Holding Position Design.

Cast on 195 sts. and work K1, P1, Ribbing.

Cast on 131 sts. and work K1, P1, Ribbing. ON OPPOSITE SIDE of CAM BOX put into holding position 3 needles after Rows 2, 4, 6, 8, 10. After Row 12 bring all needles back into working position and bind off all sts. Work the second neckband section with reverse shaping, casting on from right to left. (Cam Box will be on the LEFT SIDE at Row 0).

Cast on 27 sts. and work 700 rows K1, P1, Ribbing, then bind off all sts.

Cast on 197 sts. and work 12 rows K1, P1, Ribbing, then bind off all sts.

Move the Cam Box to the left side, turn the Row Counter back to 336 and complete the left half. Follow the instructions from *.

* ON CAM BOX SIDE, bind off 4 sts. after Row 336 (EVEN ROWS = SHOULDER SHAPING); 11 sts. (10 sts. for the left half) after Row 337 (ODD ROWS = NECK SHAPING); 4 sts. after Row 338; 5 sts. after Row 339; 4 sts. after Row 340; 5 sts. after Row 341; 4 sts. after Row 342; 3 sts. after Row 343; 4 sts. after Row 344; 3 sts. after Row 345; 4 sts. after Row 346; 2 sts. after Row 347; 4 sts. after Row 348; 2 sts. after Row 349; 5 sts. after Rows 350, 352.

ON CAM BOX SIDE, bind off 5 sts. after Rows 228, 229; 4 sts. after Rows 230, 231, 232, 233; 3 sts. after Rows 234, 235, 236, 237; 2 sts. after Rows 238, 239, 240, 241, 242, 243; 1 st. after Rows 244, 245, 246, 247, 248, 249, 250, 251. Now knit even to Row 226, then put 68 needles on the left side into holding position and complete the right half first.

ROWS 13 to 228: Knit even.

ROWS 0 to 12: Knit even, then set up for PATTERN and continue in Holding Position Design.

Cast on 195 sts. and work K1, P1, Ribbing.

SIZE: 38/40. **MATERIAL:** 10½ oz. (6 balls) gray KNIPTING Subita Dralon 2 ply, Color No. 492 and a 20" Jacket type Zipper. **TENSION:** KNIT-KING 1 to 2. **STITCH GAUGE:** Pattern Stitch 18 sts., 2", 42 rows 2". **PATTERN:** Fisherman's Rib and Holding Position Design according to Line Drawing. The Purl side is the right side. **EDGES:** K1, P1, Ribbing. When working the Fisherman's Rib, the Gate Cam Release Lever of the Main Machine is placed at the needle heels and when working the Holding Position Design Rows the Lever is placed at the needle heads. To decrease for the front shaping, hang the 1st st. ON NECK SIDE onto the 2nd st. Bind off the ribbed bands the crochet method for ribbing.

FINISHING: Block the sections to measurements given. Join front and back sections at sides and shoulders. Join armhole band sections, then sew bands to armholes. Join neckband sections, then sew to neckline. Sew in zipper.

CENTER OF GARMENT SECTION

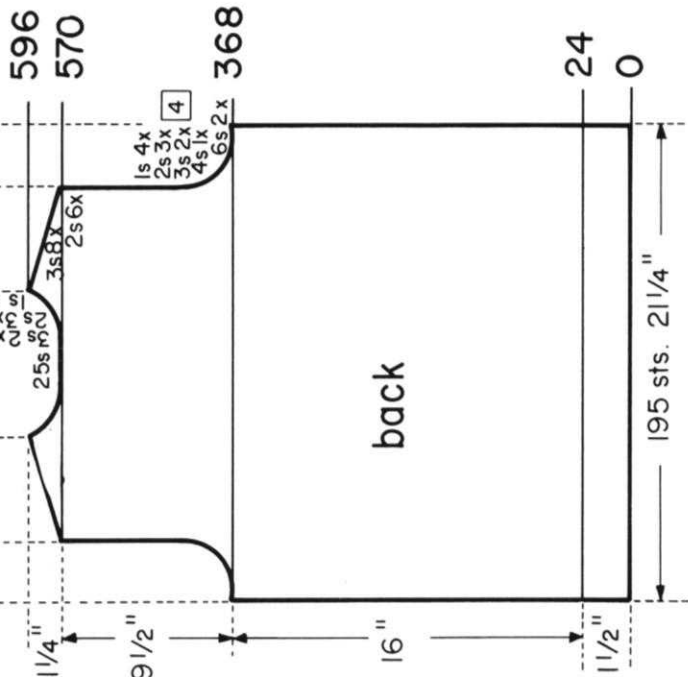
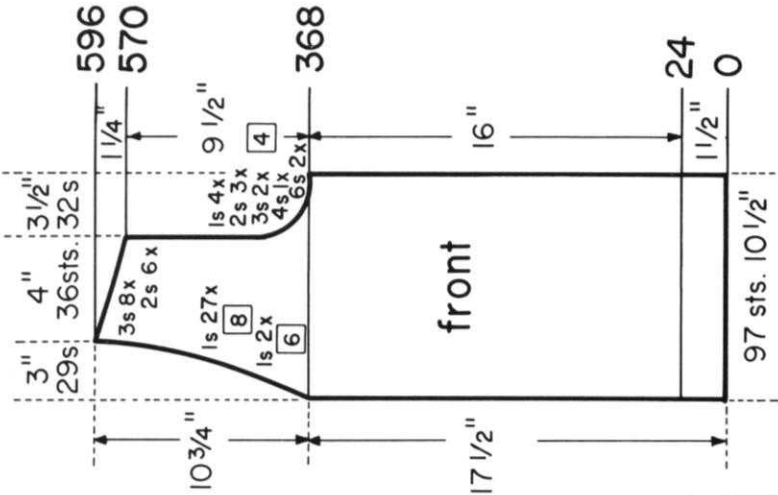
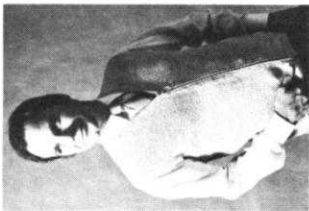
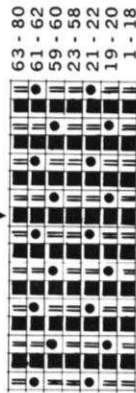

Bring the needles on the left side into working position according to the PATTERN, knit 1 row to the left side, turn the Row Counter back to 570 and complete the left half. (Count the extra row in your PATTERN ROWS). Follow the instructions from *.

* ON CAM BOX SIDE, bind off 2 sts. after Row 570 (EVEN ROWS = SHOULDER SHAPING); 13 sts. (12 sts. for the left half) after Row 571 (ODD ROWS = NECK SHAPING); 2 sts. after Row 572; 3 sts. after Row 573; 2 sts. after Row 574; 3 sts. after Row 575; 2 sts. after Rows 576, 577, 578, 579, 580, 581; 3 sts. after Row 582; 1 st. after Row 583; 3 sts. after Row 584; 1 st. after Row 585; 3 sts. after Row 586; 1 st. after Row 587; 3 sts. after Row 588; 1 st. after Row 589; 3 sts. after Row 590; 1 st. after Row 591; 3 sts. after Rows 592, 594, 596.

ON CAM BOX SIDE, bind off 6 sts. after Rows 368, 369, 372, 373; 4 sts. after Rows 376, 377; 3 sts. after Rows 380, 381, 384, 385; 2 sts. after Rows 388, 389, 392, 393, 396, 397; 1 st. after Rows 400, 401, 404, 405, 408, 409, 412, 413. Now knit to Row 570, put 65 needles on the left side (transfer the ribber sts.) into holding position and complete the right half first.

ROWS 25 to 368: Knit even.

ROWS 0 to 24: Knit even, then place the Gate Cam Release Lever of the main machine to the needle heels and work the Pattern Stitch. (Reset the Lever before and after the Holding Position Rows)

Cast on 195 sts. and work K1, P1, Ribbing

Work the second front section with reverse shapings. Cast on the regular way. Work 24 rows K1, P1, Ribbing, then place the Gate Cam Release Lever of the main machine to the needle heels, knit 1 row to the left side, turn the Row Counter back to 24 and follow the instructions.

ON OPPOSITE SIDE OF CAM BOX, decrease 1 st. after Rows in (). ON CAM BOX SIDE, bind off 6 sts. after Rows 368, (368), 372; (374), 4 sts. after Row 376; 3 sts. after Rows 380, (380), 384; 2 sts. after Rows 388, (388), 392, 396; (396), 1 st. after Rows 400, 404, (404), 408, 412. The Armhole is now completed. Continue to decrease 1 st. ON NECK SIDE after Rows 412, 420, 428, 436, 444, 452, 460, 468, 476, 484, 492, 500, 508, 516, 524, 532, 540, 548, 556, 564, then again after Rows in (). For SHOULDER bind off 2 sts. after Rows 570, 572, (572), 574, 576, 578, 580; (580), 3 sts. after Rows 582, 584, 586, 588, (588), 590, 592, 594, 596. ROWS 25 to 368: Knit even.

ROWS 0 to 24: Knit even, then place the Gate Cam Release Lever of the main machine at the needle heels and work the Pattern Stitch. (Reset the Lever before and after the Holding Position Rows).

Cast on 97 sts. and work K1, P1, Ribbing.

Cast on 157 sts. and work K1 P1, Ribbing. ON OPPOSITE SIDE OF CAM BOX put into holding position 2 needles after Rows 2, 4, 6, 8, 10, 12, 14, 16. After Row 18 bring all needles back into working position, then bind off all sts.

Work the second section with reverse shaping, casting on from right to left.

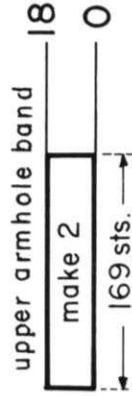
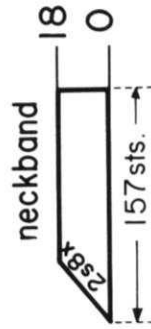

Cast on 169 sts. and work 18 rows K1, P1, Ribbing, then bind off all sts.

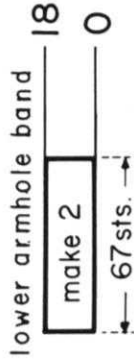

Cast on 67 sts. and work 18 rows K1, P1, Ribbing, then bind off all sts.

HP 3594

SIZE: 36/38. **MATERIAL:** 15% oz. (9 balls) light blue **KNITTING** Subita Crepe 2 x 3, Color No. 118. **TENSION:** **KNITTING** 3 to 5. **STITCH GAUGE:** 17 sts, 2", 26 rows 2". **PATTERN:** Stockinette Stitch with a Cable Design according to Line Drawing. **EDGES:** K1, P1, Ribbing. **SLEEVE INCREASES:** After rows indicated, move the 2 end sts. ON EACH SIDE 1 needle outward, then place the 3rd st. from the row below onto the empty needle.

FINISHING: Block all sections to measurements given. Join front and back section at sides and shoulders. Sew sleeves together and set in. Sew pocket in place. Sew neckband to neckline. Sew in zipper.

CENTER OF GARMENT SECTION

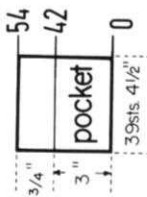
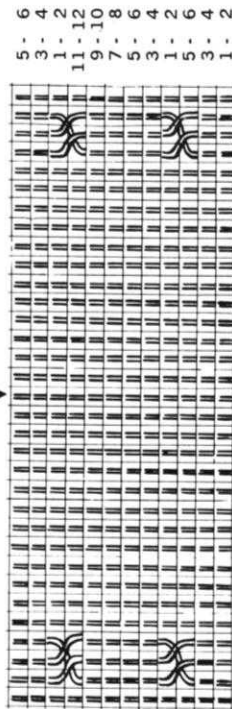

Cast on 39 sts. Work 42 rows stockinette st. AND the Cable Design over the center 3 sts. After Row 42 transfer every other st. to the Ribber and work 12 rows K1, P1, Ribbing. After Row 54 bind off all sts. the crochet method for ribbing.

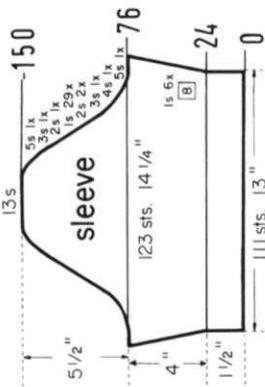

Each Cable is worked over 3 needles. Using a single and a double transfer tool and counting from the right side, hang the 3rd st. onto the 1st needle, then the 1st and 2nd sts. onto the 2nd and 3rd needles. Cross the sts. the first time after 6 rows stockinette st. (Row 30 on the Row Counter), then after every following 12th row. There are 25 plain sts. between each 3 Cable sts. The triangle on the Line Drawing marks the center of the section to be knitted.



Cast on 155 sts. and work 14 rows K1, P1, Ribbing, then bind off all sts. the crochet method for ribbing.

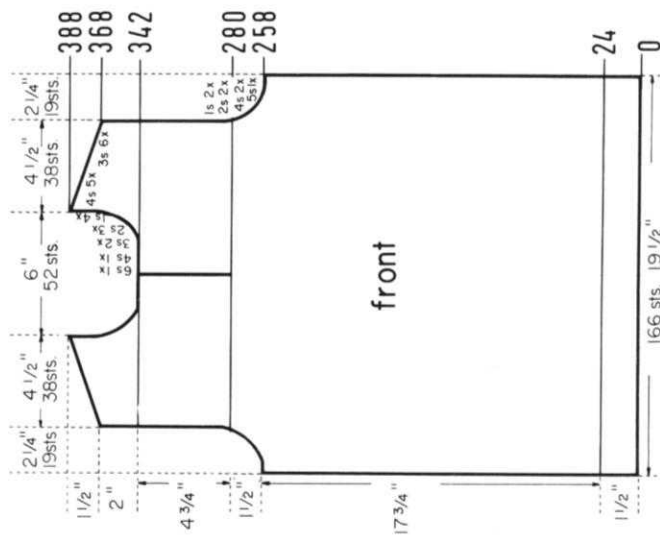

Move the Cam Box to the left side, turn the Row Counter back to 280 and complete the left half. Follow the instructions from *.

ON CAM BOX SIDE, bind off 6 sts. after Row 343 (ODD ROWS = NECK SHAPING); 4 sts. after Row 345; 3 sts. after Rows 347, 349; 2 sts. after Rows 351, 353, 355; 1 st. after Rows 357, 359, 361, 363. For SHOULDER bind off 3 sts. after Rows 368, 370, 372, 374, 376, 378; 4 sts. after Rows 380, 382, 384, 386, 388.

* ROWS 281 to 343: Knit even.

ON CAM BOX SIDE, bind off 5 sts. after Rows 258, 259; 4 sts. after Rows 260, 261, 262, 263; 2 sts. after Rows 264, 265, 266, 267; 1 st. after Rows 268, 269, 270, 271. Now knit to Row 280, then put 64 needles on the left side into holding position and complete the right half first.

ROWS 25 to 258: Knit even.

ROWS 0 to 24: Knit even, then transfer the ribber sts. to the main machine, continue with stockinette st. and work the Cable Design.

Cast on 166 sts. and work K1, P1, Ribbing.

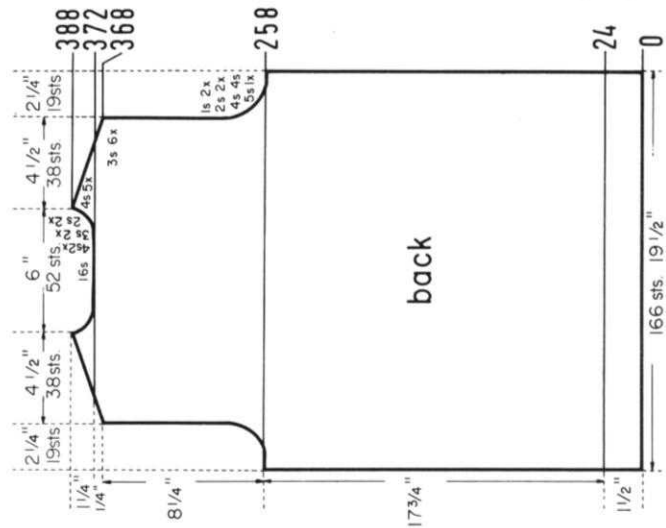

Move the Cam Box to the left side, turn the Row Counter back to 372 and complete the left half. Follow the instructions from *.

* ON CAM BOX SIDE, bind off 3 sts. after Row 372 (EVEN ROWS = SHOULDER SHAPING); 8 sts. after Row 373 (ODD ROWS = NECK SHAPING); 3 sts. after Row 374; 4 sts. after Row 375; 3 sts. after Row 376; 4 sts. after Row 377; 3 sts. after Rows 378, 379; 4 sts. after Row 380; 3 sts. after Row 381; 4 sts. after Row 382; 2 sts. after Row 383; 4 sts. after Row 384; 2 sts. after Row 385; 4 sts. after Rows 386, 388.

ON CAM BOX SIDE, bind off 3 sts. after Rows 368, 369, 370, 371. Now knit to Row 372, put 58 needles on the left side into holding position and complete the right half first.

ON CAM BOX SIDE, bind off 5 sts. after Rows 258, 259; 4 sts. after Rows 260, 261, 262, 263; 2 sts. after Rows 264, 265, 266, 267; 1 st. after Rows 268, 269, 270, 271, then knit to Row 368.

ROWS 25 to 258: Knit even.

ROWS 0 to 24: Knit even, then transfer the ribber sts. to the main machine, continue with stockinette st. and work the Cable Design.

Cast on 166 sts. and work K1, P1, Ribbing.

SIZE: 38/40. **MATERIAL:** 5¼ oz. (3 balls) white and 3½ oz. (2 balls) blue **KNITTING** Subita Dralon 2 ply, Color Nos. 410 and 401. **TENSION:** **KNITTING** 1 to 2: **STITCH GAUGE:** 18 sts. 2", 29 rows 2". **PATTERN:** Stockinette Stitch. **INCREASES:** After rows indicated, move the 2 end sts. on the appropriate sides 1 needle outward, then place the 3rd st. from the row below onto the empty needle. **DECREASES:** After rows indicated, hand the 3rd st. on the appropriate sides onto the 2nd st., then move the end sts. inward to fill the empty needle. To form the hems hang the cast-on sts. back on the machine behind the latches. (Knit the following row with 1 tension setting higher).

FINISHING: Block all sections to measurements given. (Subtract the hem depth.) Join front and back section at sides and shoulders. Sew sleeves together and set in. With puri sides facing each other, weave the outer and the inner collar section together around outer edges, 1 st. in from each edge. Sew 1 edge of open edge to inside and 1 edge to outside of neckline.

Move the Cam Box to the left side, turn the Row Counter back to 428 and complete the left half. Follow the instructions from *.

* ON CAM BOX SIDE, bind off 4 sts. after Row 428 (EVEN ROWS = SHOULDER SHAPING); 10 sts. (9 sts. for the left half) after Row 429 (ODD ROWS = NECK SHAPING); 4 sts. after Row 430; 6 sts. after Row 431; 4 sts. after Row 432; 3 sts. after Row 433; 4 sts. after Row 434; 3 sts. after Row 435; 4 sts. after Row 436; 2 sts. after Row 437; 4 sts. after Row 438; 2 sts. after Row 439; 4 sts. after Row 440.

ON CAM BOX SIDE, bind off 3 sts. after Rows 418, 419; 4 sts. after Rows 420, 421, 422, 423, 424, 425, 426, 427. Now knit to Row 428, put 53 needles on the left side into holding position and complete the right half first.

ON CAM BOX SIDE, bind off 6 sts. after Rows 290, 291; 5 sts. after Rows 292, 293, 294, 295; 3 sts. after Rows 296, 297; 2 sts. after Rows 298, 299, 300, 301; 1 st. after Rows 302, 303, 304, 305, then knit to Row 418.

ROWS 269 to 290: Knit even then change to blue.

ROWS 257 to 268: Knit even, then change to white.

ROWS 47 to 256: Knit even, then change to blue.

ROWS 0 to 46: Knit even, then form the hem and change to white.

Cast on 195 sts. with blue and work stockinette st.

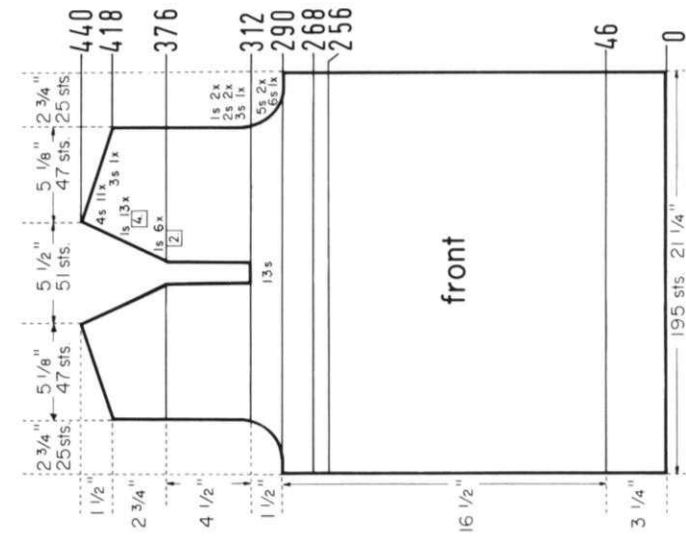
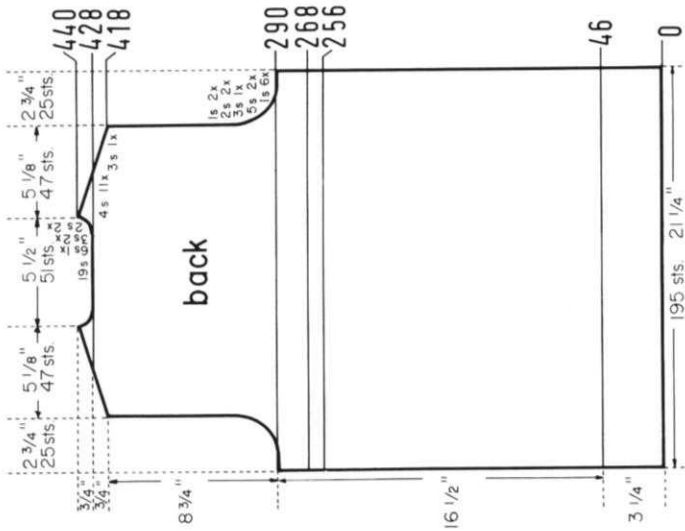

Move the Cam Box to the left side, turn the Row Counter back to Row 312 and complete the left half. Follow the instructions from *.

* Knit even to Row 376. ON OPPOSITE SIDE OF CAM BOX (NECK SIDE) decrease 1 st. after Rows 376, 378, 380, 382, 384, 386, 388, 392, 396, 400, 404, 408, 412, 416, then decrease 1 st. on NECK SIDE after Rows in (. For SHOULDER, bind off 3 sts. after Row 418; 4 sts. after Rows 420, (420), 422, 424, (424), 426, 428, (428), 430, 432, (432), 434, 436, (436), 438, 440.

ON CAM BOX SIDE, bind off 6 sts. after Rows 290, 291; 5 sts. after Rows 292, 293, 294, 295; 3 sts. after Rows 296, 297; 2 sts. after Rows 298, 299, 300, 301; 1 st. after Rows 302, 303, 304, 305. Now knit to Row 312, bind off the center 13 sts., put 66 needles on the left side into holding position and complete the right half first.

ROWS 269 to 290: Knit even, then change to blue.

ROWS 257 to 268: Knit even then change to white.

ROWS 47 to 256: Knit even, then change to blue.

ROWS 0 to 46: Knit even, then form the hem and change to white.

Cast on 195 sts. with blue and work stockinette st.



Work the second collar section the same. ON EACH SIDE, increase 1 st. after Rows 128, 132, 136, 140, 144, 148, 152, 156, 160, then knit to Row 164. Now work Short Rows. ON OPPOSITE SIDE OF CAM BOX, put into holding position 4 needles after Rows 164, 165, 166, 167, 168, 169, 170, 171; 5 needles after Rows 172, 173, 174, 175, 176, 177, 178, 179; 6 needles after Rows 180, 181, 182, 183, 184, 185. After Row 186 bring all needles back into working position, knit 1 row over all sts., then bind off.

ODD ROWS = INNER SHAPING, EVEN ROWS = OUTER SHAPING. ON CAM BOX SIDE, increase 1 st. after Rows 61, 65, 69, 73, 77, 81, 85, 89, 92, 93, 97, 98, 101, 104, 105, 109, 110, 113, 116, 117, 121, 122, 125, then knit to Row 128 and put these 41 needles into holding position. Move the Cam Box to the left side, bring the 18 needles into working position, turn the Row Counter back to 0 and repeat Rows 0 to 128 for the left side section. After Row 128 put the 41 needles on the left side into holding position, move the Cam Box to the right side, cast on sts. over the remaining 52 center needles, turn the Row Counter back to 128 and continue working over all 134 sts.

ROWS 0 to 60: Knit even. Leave the center 86 needles free, then cast on 18 sts. to the right and 18 sts. to the left of these 86 needles. (For the left side cast on from right to left). Put the 18 needles on the left side into holding position and work the right side section first.

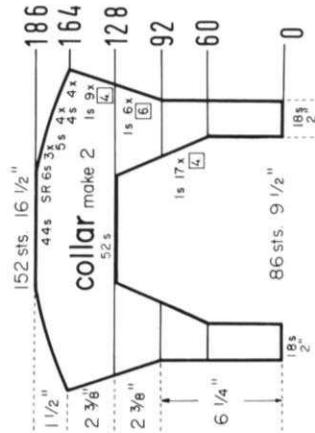

SIZE 5-6, (Chest 23"-24") Suit fits snugly. MATERIAL: 3½ oz. (2 balls) red and 1¾ oz. (1 ball) white KNOTTING Subita Dralon 3 ply, Color Nos. 413 and 401. TENSION: KNOTTING 4 to 6. STITCH GAUGE: 16 sts, 2" 24 rows 2", PATTERNS: Stockinette Stitch, with repeated color stripes of 4 rows white and 4 rows red on bodice section. INCREASES of 1 stitch: After Rows indicated, move the 2 end sts. on the appropriate sides 1 needle outward, then place the 3rd st. from the row below onto the empty needle. DECREASES of 1 stitch: After rows indicated, hang the 3rd st. on the appropriate sides onto the 2nd st., then move the end sts. inward to fill the empty needle.

FINISHING: Block the sections to measurements given. Join front and back section at sides, shoulders and at crotch. Turn under a small amount at leg edges, hem to wrong side and insert elastic bands. With red, work 2 rows of single crochet around neckline and armholes.



ON CAM BOX SIDE, bind off 6 sts. after Rows 98, 99; 5 sts. after Rows 100, 101; 4 sts. after Row 102, 103; 3 sts. after Rows 104, 105; 2 sts. after Rows 106, 107, 108, 109. ON EACH SIDE, hang the 1st st. onto the 2nd st. after Rows 110, 112, 114, 116, 118, 120, 122, 124, 126, 128, 130, 132, 134, 136, 138, 140, 142, 144, 146, 148, 150, 152, 154, 156, 158, 160, 162, 164, 166, 168. ON CAM BOX SIDE, bind off 2 sts. after Rows 170, 171; 3 sts. after Rows 172, 173, 174, 175; 4 sts. after Rows 176, 177, 178, 179; 10 sts. after Row 180.

ON EACH SIDE, increase 1 st. after Rows 50, 56, 62, 68, 74, 80, 86, 92, then knit to Row 98.

ON EACH SIDE, decrease 1 st. after Rows 2, 8, 14, 20, then increase 1 st. ON EACH SIDE after Rows 26, 32, 38, 44. After Row 46 form the hem, then change to blue and knit to Row 50.

Cast on 130 sts. with white and work stockinette st.

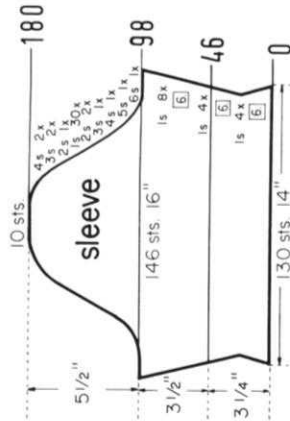

Move the Cam box to the left side, turn the Row Counter back to 190 and complete the left half. Follow the instructions from *.

* ON CAM BOX SIDE, bind off 4 sts. after Row 190 (EVEN ROWS = ARM-HOLE SHAPING); 5 sts. after Row 191 (ODD ROWS = NECK SHAPING); 3 sts. after Rows 192, 193, 194, 195; 2 sts. after Rows 196, 197, 198, 199, 200; 1 st. after Rows 201, 202, 203, 204, 205, 206, 207. Now knit even to Row 270, then bind off the remaining 10 sts.

ON EACH SIDE, increase 1 st. after Rows 126, 146, 166, then knit even to Row 190, put 48 needles on the left side into holding position and complete the right half first.

ON EACH SIDE, decrease 1 st. after Rows 58, 66, 74. Now knit to Row 82, change to white and work the repeated color stripes. Continue to decrease 1 st. ON EACH SIDE after Rows 82, 90, 98, then knit even to Row 126.

ON EACH SIDE, increase 1 st. after Rows 24, 26, 28, 30, 32, 34. ON CAM BOX SIDE, cast on 2 sts. after Rows 36, 37, 38, 39, 40, 41, 42, 43; 3 sts. after Rows 44, 45, 46, 47, 48, 49, 50, 51, 52, 53, 54, 55; 6 sts. after Rows 56, 57, then knit to Row 58.

ROWS 0 to 24: Knit even.

Cast on 26 sts. with red and work stockinette st.

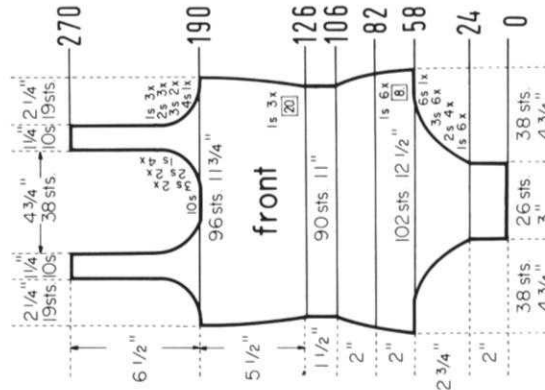

Move the Cam Box to the left side, turn the Row Counter back to 214 and complete the left half. Follow the instructions from *.

* ON CAM BOX SIDE, bind off 5 sts. after Row 215 (ODD ROWS = NECK SHAPING); 3 sts. after Rows 217, 219; 2 sts. after Rows 221, 223; 1 st. after Rows 225, 227, 229, 231. Now knit to Row 270, then bind off the remaining 10 sts.

ON CAM BOX SIDE, bind off 4 sts. after Rows 190, 191; 3 sts. after Rows 192, 193, 194, 195; 2 sts. after Rows 196, 197, 198, 199, 200, 201; 1 st. after Rows 202, 203, 204, 205, 206, 207. Now knit to Row 214, then put 29 sts. on the left side into holding position and complete the right half first.

ON EACH SIDE, increase 1 st. after Rows 126, 146, 166, then knit to Row 190.

ON EACH SIDE, decrease 1 st. after Rows 58, 66, 74. Now knit to Row 82, change to white and work the repeated color stripes. Continue to decrease 1 st. ON EACH SIDE after Rows 82, 90, 98, then knit even to Row 126.

ON EACH SIDE, increase 1 st. after Rows 2, 4, 6, 8, 10, 12, 14, 16, 18, 20, 22, 24, 26, 28, 30, 32, 34, 36. ON CAM BOX SIDE, cast on 2 sts. after Rows 38, 39, 40, 41, 42, 43, 44, 45, 46, 47, 48, 49, 50, 51, 52, 53, 54, 55, 56, 57, then knit to Row 58.

Cast on 26 sts. with red and work stockinette st.

SIZE: 7-8. **MATERIAL:** 1½ oz. (1 ball) blue, 1¾ oz. (1 ball) gold and 1½ oz. (1 ball) red **KNIT-KING** Subita Dralon 3 ply, Color Nos. 417, 435 and 427. **TENSION:** **KNITTING** 4 to 6. **STITCH GAUGE:** 16 sts. 2", 24 rows 2". **PATTERN:** Stockinette Stitch and repeated color stripes as marked in the diagram. **BELT and LOOPS:** K1, P1, Ribbing. To form the hem, hang the cast-on sts. back on the machine behind the latches, then knit the following row with 2 tension settings higher.

FINISHING: Block the sections to measurements given. (Subtract the hem depth). Join front and back section at sides and weave the sts. for the crotch together. Turn under a small amount at leg edges, hem to wrong side and insert elastic bands. Insert an elastic band into upper hem. Sew loops in place.

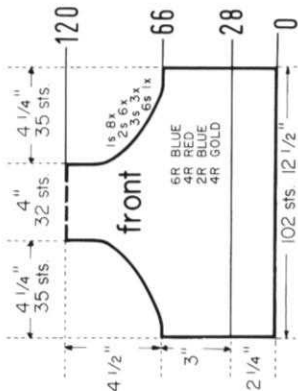

SIZE: 3-4. (Chest 22"-23"). **MATERIAL:** 5½ oz. (3 balls) red **KNITTING** Subita Dralon 3 ply, Color No. 436. **TENSION:** 4 to 6. **STITCH GAUGE:** 16 sts. 2", 23 rows 2". **PATTERN:** Stockinette Stitch. Make all decreases of 1 st. Full-fashion. After Rows indicated, hang the 3rd st. on the appropriate side onto the 2nd st., then move the end sts. inward to fill the empty needle.

FINISHING: Block the sections to measurements given. Join front and back section at sides. Turn under 2" on lower edge and hem to wrong side. Work 2 rows of single crochet around all upper edges. Sew a large snap to each shoulder for closure. Sew a button to the shaped ends of back straps. Turn under 3/4" on upper edge of pocket and hem to wrong side. Sew an animal figure to pocket, then sew pocket to center of dress (see picture).



Cast on 55 sts. and work 50 rows stockinette st., then bind off all sts.



Cast on 9 sts. with blue and work 12 rows K1, P1, Ribbing, then bind off all sts.

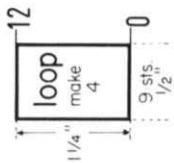

Cast on 15 sts. with blue and work 240 rows K1, P1, Ribbing, then bind off all sts.

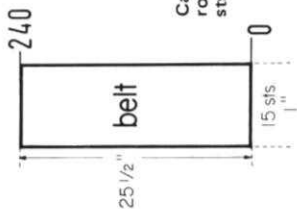

ON CAM BOX SIDE, bind off 6 sts. after Rows 66, 67; 3 sts. after Rows 68, 69, 70, 71, 72, 73; 2 sts. after Rows 74, 75, 76, 77, 78, 79, 80, 81, 82, 83, 84, 85; 1 st. after Rows 86, 87, 88, 89, 90, 91, 92, 93, 94, 95, 96, 97, 98, 99, 100, 101. Now knit to Row 120, then put the remaining 32 sts. on a stitch holder.

ROWS 29 to 66: Knit even.

ROWS 0 to 28: Knit even to Row 27, then form the hem and knit 1 row. After Row 28 change to gold and work the repeated color stripes as marked in the diagram.

Cast on 102 sts. with blue and work stockinette st.

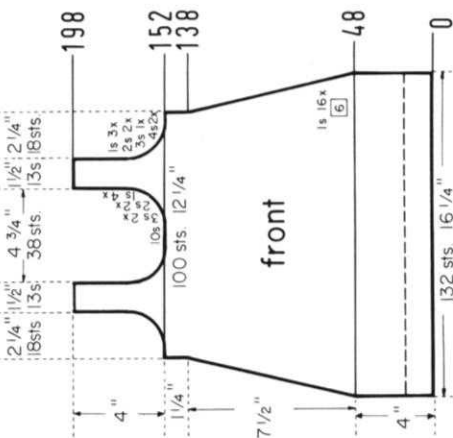
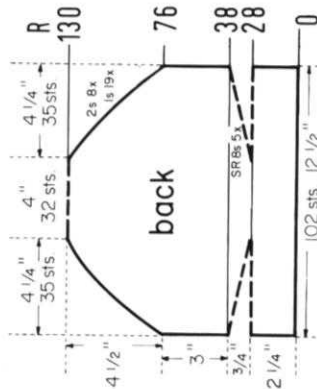

Move the Cam Box to the left side, turn the Row Counter back to 152 and complete the left side. Follow the instructions from *.

* **ON CAM BOX SIDE,** bind off 4 sts. after Row 152 (**EVEN ROWS = ARM-HOLE SHAPING**); 5 sts. after Row 153 (**ODD ROWS = NECK SHAPING**); 4 sts. after Row 154; 3 sts. after Rows 155, 156, 157; 2 sts. after Rows 158, 159, 160, 161, 1 st. after Rows 162, 163, 164, 165, 166, 167, 169. Now knit to Row 198, then bind off the remaining 13 sts.

ON EACH SIDE, decrease 1 st. after Rows 48, 54, 60, 66, 72, 78, 84, 90, 96, 102, 108, 114, 120, 126, 132, 138. Now knit to Row 152, put 50 needles on the left side into holding position and complete the right half-first.

ROWS 0 to 48: Knit even. Cast on 132 sts. and work stockinette st.

KG 1906

Material: 1 1/4 oz. (1 ball) each of 3 colors; main color, contrast color and black KNITTING Sonika Dralon. 12" diameter Pillow Form, 3 inches thick; 12" zipper. Tension: 7 or 8. Gauge: 14 sts., 19 rows 2".

FINISHING: Weave together the sections held on contrast waste yarn, then remove waste yarn. Pull pieces into shape. Put the black edging around the outside edge of Pillow form then pin zipper in smoothly. Remove the edging and sew the zipper in with straight edge against the zipper, the other side with 3 extra stitches overlapping the zipper to cover it. Catch down the 3 sts. held on stitch holder. Put the black edges back onto pillow form and smooth evenly. Pin the top sections to the black edging on each side making sure it is even, then weave together 1 st. in from each edge. Run a strand of yarn around center edges and pull up tightly and secure. Make a flower to put on the plain side.

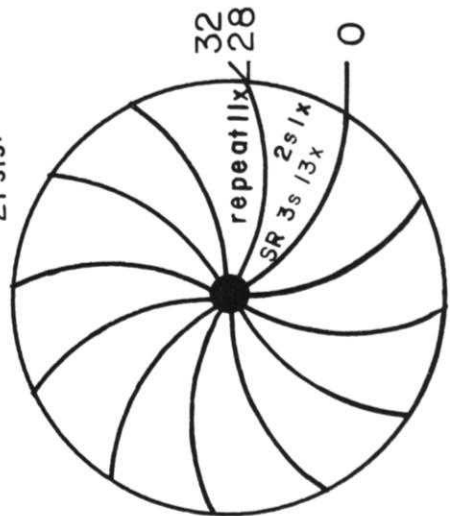
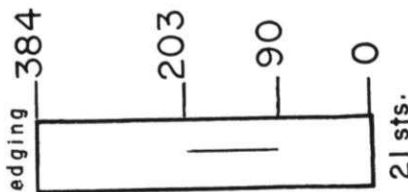
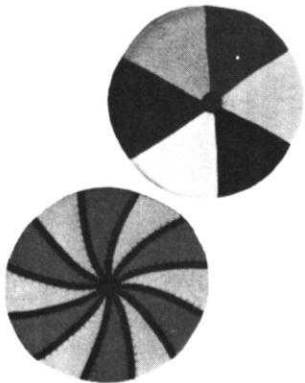

cast on 43 sts.
make 2

ROWS 204-384: Put all needles into work and knit even. Remove on contrast waste yarn.

ROWS 91-203: After ROW 91 cast on 3 sts. To do this, put 3 sts. from left section onto a stitch holder then cast on. Now knit even. After ROW 203, put Row Counter back to 90, all needles on the right side into holding position. Put all needles on the left into working position, put the 3 sts. held on stitch holder back on machine by removing 3 sts. on right side to a stitch holder and knit even to Row 203.

ROWS 1-90: Knit even, then put 11 sts. on the left side into holding position and knit the right side first.

EDGING: Open cast on 21 sts., then change to black yarn.

ROWS 33-383: Change to contrast color and REPEAT ROWS 1-32 11 times more, changing color after each section but ending with only 3 rows of black at the end of the last section instead of 4. Leave a long strand for weaving and break yarn. Knit several rows with waste yarn and remove work from machine. Make a second section the same as above using MAIN COLOR ONLY.

ROWS 29-32: Change to black and put all needles into working position, then knit even.

ROWS 1-28: On the LEFT side and on EVERY OTHER ROW, put 3 needles into holding position 13 x and 2 needles 1 x. DO NOT WRAP THE YARN around the needles in holding position — the hole is part of design.

Cast-on 43 sts. using contrast waste yarn. After knitting several rows end with Cam Box on the left side, then knit 1 row to the right with a ravel cord. Change to main color.

Move the Cam Box to the left side, turn the Row Counter back to 180 and complete the left half. Follow the instructions from *.

* ON CAM BOX SIDE, bind off 5 sts. after Row 181 (ODD ROWS = NECK SHAPING); 3 sts. after Rows 183, 185; 2 sts. after Rows 187, 189; 1 st. after Rows 191, 193, 195, 197. ON EACH SIDE, decrease 1 st. after Rows 218, 220, 222, 224. After Row 226 bind off the remaining 5 sts.

ON CAM BOX SIDE, bind off 4 sts. after Rows 152, 153, 154, 155; 3 sts. after Rows 156, 157; 2 sts. after Rows 158, 159, 160, 161. ON EACH SIDE, decrease 1 st. after Rows 162, 164, 166. Now knit even to Row 180, then put 32 needles on the left side into holding position and complete the right half first.

ON EACH SIDE, decrease 1 st. after Rows 48, 54, 60, 66, 72, 78, 84, 90, 96, 102, 108, 114, 120, 126, 132, 138, then knit to Row 152.

ROWS 0 to 48: Knit even.

Cast on 132 sts. and work stockinette st.

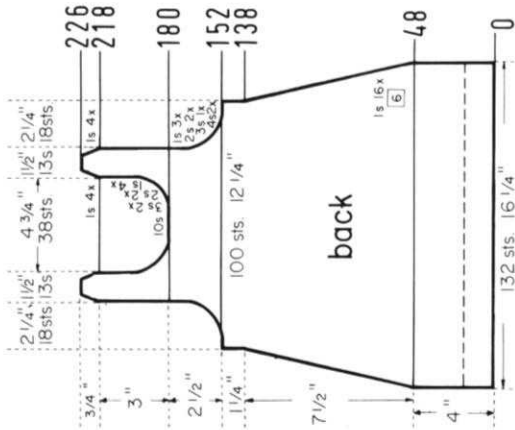

KG 1907

Material: 1 1/4 oz. each of 6 different colors (6 balls) KNITTING Sonika Dralon, 1 Pillow Form 12" diameter, 2 inches thick. Tension: 7 or 8. Gauge: 14 sts. 19 rows 2".

FINISHING: Weave together the sts. held on contrast yarn a little more than half way across, then put in the pillow form and complete the weaving of sts. Run a strand of yarn around each center and pull up. Make a covered button or a flower for each center and attach.

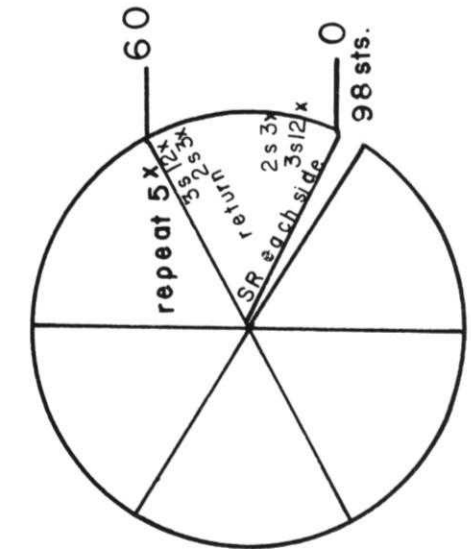

CHANGE COLOR and REPEAT ROWS 1-60 5 times more (6 sections) each time changing color after 60 rows. Knit several rows with contrast waste yarn and remove work from machine.

ROWS 37-60: Put 3 sts. opposite Cam Box back into working position beginning each row.

ROWS 31-36: Put 2 sts. opposite Cam Box back into working position beginning each row.

ROWS 25-30: Put 2 sts. opposite Cam Box into holding position beginning each row.

ROWS 1-24: Put 3 sts. opposite Cam Box into holding position beginning each row (short rows — be sure to wrap the yarn around end needle in holding position).

Cast-on 98 sts. (See KG 1904) then change to main yarn.



SIZE 14-16. (Chest 32"-34"). **MATERIAL:** 3 1/2 oz. (2 balls) dark blue, 1 1/2 oz. (1 ball) medium blue, 1 1/2 oz. (1 ball) light blue and 1 1/2 oz. (1 ball) white **KNITTING** Subita Dralon 2 ply, Color Nos. 416, 410, 406 and 401. **TENSION:** **KNITTING** 1 to 2. **STITCH GAUGE:** 19 sts., 2", 30 rows 2". **PATTERN:** Stockinette Stitch and repeated color stripes as marked in the diagram. **NECKBAND:** K1, P1, Ribbing. To form the hems, hang the cast-on sts. back on the machine behind the latches. (Knit the following row with 2 tension settings higher). **SLEEVE INCREASES:** After rows indicated, move the 2 end sts. **ON EACH SIDE** 1 row below onto the empty needle.

FINISHING: Block all sections to measurements given. (Subtract the hem depth). Join front and back section at sides and shoulders. Sew sleeves together and set in. Join neckband sections at short ends. Sew 1 edge of neckband to inside and 1 edge to outside of neckline, matching front and back section.

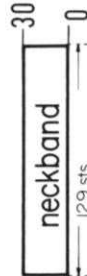

Cast on 129 sts. with dark blue and work 30 rows K1, P1, Ribbing, then bind off the crochet method for ribbing.

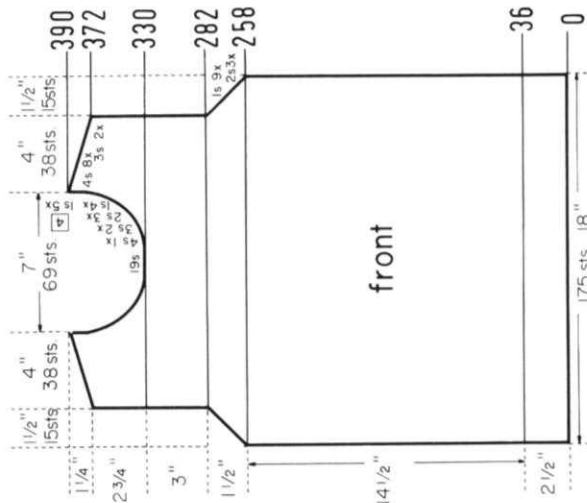

Move the Cam Box to the left side, turn the Row Counter back to 330 and complete the left half. Follow the instructions from *.

* **ON CAM BOX SIDE**, bind off 10 sts. (9 sts. for the left half) after Row 331 (ODD ROWS = NECK SHAPING); 4 sts. after Row 333; 3 sts. after Rows 335, 337; 2 sts. after Rows 339, 341, 343; 1 st. after Rows 345, 347, 349, 351, 355, 359, 363, 367, 371. For **SHOULDER** bind off 3 sts. after Rows 372, 374; 4 sts. after Rows 376, 378, 380, 382, 384, 386, 388, 390.

ON CAM BOX SIDE, bind off 2 sts. after Rows 258, 259, 260, 261, 262, 263. **ON EACH SIDE**, hang the 1st st. onto the 2nd st. after Rows 264, 266, 268, 270, 272, 274, 276, 278, 280. Now knit to Row 330, then put 72 needles on the left side into holding position and complete the right half first.

ROWS 37 to 258: Knit even.

ROWS 0 to 36: Knit even, then form the hem. Change to white and continue with the repeated color stripes as marked in the diagram of the back section.

Cast on 175 sts. with dark blue and work stockinette st.

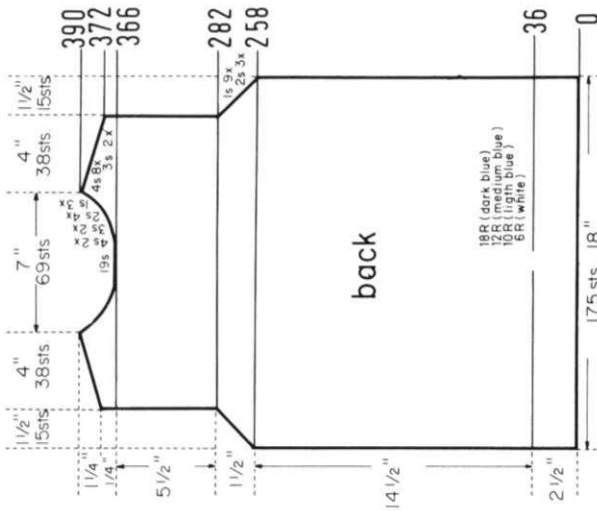

Cast on 83 sts. with dark blue and work 30 rows K1, P1, Ribbing, then bind off the crochet method for ribbing.

ON EACH SIDE, hang the 1st st. onto the 2nd st. after Rows 96, 98, 100, 102, 104, 106, 108, 110, 112, 114, 116, 118, 120. **ON CAM BOX SIDE**, bind off 2 sts. after Rows 122, 123, 124, 125, 126, 127, 128, 129, 130, 131, 132, 133, 134, 135; 3 sts. after Rows 136, 137, 138, 139, 140, 141, 142, 143, 144, 145, 146, 147, 148, 149; 38 sts. after Row 150.

ON EACH SIDE, increase 1 st. after Rows 36, 42, 48, 54, 60, 66, 72, 78, 84, 90, then knit to Row 96.

ROWS 0 to 36: Knit even, then form the hem. Change to white and continue with the repeated color stripes as marked in the diagram of the back section.

Cast on 114 sts. with dark blue and work stockinette st.

Move the Cam Box to the left side, turn the Row Counter back to 366 and complete the left half. Follow the instructions from *.

* **ON CAM BOX SIDE**, bind off 10 sts. (9 sts. for the left half) after Row 367 (ODD ROWS = NECK SHAPING); 4 sts. after Rows 369, 371; 3 sts. after Rows 372 (EVEN ROWS = SHOULDER SHAPING), 373, 374, 375; 4 sts. after Row 376; 2 sts. after Row 377; 4 sts. after Row 378; 2 sts. after Row 379; 4 sts. after Row 380; 2 sts. after Row 381; 4 sts. after Row 382; 2 sts. after Row 383; 4 sts. after Row 384; 1 st. after Row 385; 4 sts. after Row 286; 1 st. after Row 387; 4 sts. after Row 388; 1 st. after Row 389; 4 sts. after Row 390.

ON CAM BOX SIDE, bind off 2 sts. after Rows 258, 259, 260, 261, 262, 263. **ON EACH SIDE**, hang the 1st st. onto the 2nd st. after Rows 264, 266, 268, 270, 272, 274, 276, 278, 280. Now knit to Row 366, then put 72 needles on the left side into holding position and complete the right half first.

ROWS 37 to 258: Knit even.

ROWS 0 to 36: Knit even, then form the hem. Change to white and continue with the repeated color stripes as marked in the diagram.

Cast on 175 sts. with dark blue and work stockinette st.



KNITTING NEWS

May/June, 1970

OUR READERS WRITE

"I never know what SIZE garment to knit. Nothing is ever exactly my size and I don't know how to change directions to fit me!!!"

You are not alone.... No one is really a perfect size 10 or 12 or 14.... You might be a size 10 upstairs, and a size 14 downstairs...or the sizes might be in reverse... What can you do?

The garment and pattern industries comply to Standards for Body Measurements... The amount of ease allowed on their garments will vary and depend on several things... the material used such as heavy or light, soft or stiff... whether it will be an outer garment such as a Jacket or Cardigan or a Pullover Sweater, Blouse, Dress, etc., etc.

You are indeed fortunate when you can knit your own garments and made the necessary changes so that it will really fit you no matter what size you wear. When you knit a garment from KNITTING MAGAZINE, you can change the measurements easily. We cannot give directions for making each garment in many sizes because it is not possible to include all the figures for shaping, fashioning, etc., in each chart. Our new Charts make it very easy to alter the size. At a glance you can see the actual number of stitches to bind off at Armhole, Shoulder and Neckline as well as the number of rows between points of shaping. The measurements shown on the Charts are the actual blocking measurements.

One of the best ways to decide what size to knit is to compare the measurements shown on KNITTING MAGAZINE Charts with the measurements taken from a dress or a sweater or a jacket that you own and that fits you well. Again we repeat... our measurements on the Charts are BLOCKING MEASUREMENTS. If there is only a slight difference between the actual measurements shown and your own measurements taken from your dress or sweater, you can go ahead and knit that garment providing of course that you have made a stitch and row gauge sample and it complies with the stitch and row gauge given in our pattern. Please make a rough sketch of the chart and put in YOUR measurements... If there is a difference of 1" on the front and 1" on the back, you can cast on 1" MORE of stitches for a LARGER size, or 1" LESS stitches for a SMALLER size. Make the necessary adjustments by dividing the extra amounts of stitches for a larger size between the armholes, shoulders and if necessary the neckline. Bind off the extra stitches at the armhole by knitting 1 or 2 extra bind-off rows. Bind off the extra stitches at shoulders by adding them to the last shoulder bind-off. If you have extra stitches at neckline, take them off at the first neck bind-off. For the smaller size... reverse the procedure. You will bind off LESS stitches at armhole, shoulder and neckline.

Make all shapings up to the armhole as given in the instructions. Change your length if you like, by subtracting or adding rows where there is EVEN KNITTING, then ALWAYS put your Row Counter to the row where shapings begin, thus making it easy for you to make your shapings on the rows as given in the pattern.

Some people think that because they have the same yarn the pattern calls for, they can sit down and make a garment without making a test sample swatch ... NEVER under any circumstances do this... the most important part of your knitting is your sample swatch. We give you several tensions to try out because machine tensions will vary and the dye used in yarns can make a difference so that one color will give you the stitch and row gauge on one tension, while another color will give you the stitch and row gauge on another tension...so don't forget, if you want perfect garments, making a sample swatch using 3 different tensions is the most important part of your knitting.

So the RULE IS:... You must get the EXACT stitch and row gauge as shown in our patterns if you want them to turn out exactly to the measurements shown (the blocked measurements) and if our sample garment was made with Tension 5 and gives 16 sts. to 2" and 21 rows to 2", but you get the same stitch and row gauge on Tension 6 or perhaps 7, use whatever tension (for that particular garment) that will give you the number of stitches and rows called for in the pattern regardless of what tension number you get it on...

For a simple method of increasing or reducing the sizes of garments in KNITTING MAGAZINE, be sure to read the "Letter from the Publisher" in this issue.

PRACTICAL KNITTING HINTS

When working a Pattern with a Holding Position Design, it takes a specific number of rows to obtain a Pattern Set. When working a Pattern in Fisherman's Rib, one has to knit 2 rows - from right to left, then from left to right, to obtain 1 visible row. As you know, all our Line Drawings for Holding Position Designs are written to be set up and be started from right to left. When knitting a garment that has 2 front sections such as Jackets or Dresses with a front closure, the second front section has to be worked with reverse shapings.

To enable you to follow the instructions as written, we make you start this section on the left side (Cam Box on the left side and Row Counter at 0). To obtain the same pattern picture (Holding Position Designs) as on the first section, you have to cast on from left to right, the same as for the first section. If the garment has a ribbed or plain band, knit the band then set up your needles for your specific pattern stitch and knit 1 row in PATTERN STITCH to the left side.

Now you must turn your Row Counter back 1 row so your Row Counter shows even numbers when you are on the left side. This extra row will not make any difference in the length of the section, but must be counted as one row in your pattern stitch set. ALWAYS knit the pattern from right to left and set your needle positions from right to left. ...This also applies when finishing the left half of a section.

KNITTED LACE VEST

Size: Small (fits Bust 32 - 34), Medium (fits Bust 36 - 38), Large (fits Bust 40 - 42). Material: Small and Medium 7 oz. (4 balls); Large 8 3/4 oz. (5 balls) KNITKING Sonika Dralon. Tension: Small: Tension 7 to 8; Medium: Tension 8 to 9; Large: Tension 9 to 10. Gauge: Tension 7 to 8: 14 sts. 2", 20 rows 2". The higher tension setting will produce a looser stitch which can then be blocked into the larger sizes. Pattern: Holding Position Design with omitted needles according to Line Drawing. The purl side is the right side. The omitted needles in the pattern are counted as stitches in the Stitch Gauge and Instructions. Empty needles are counted as sts. when shaping. When binding off be sure to make 2 chain sts. where there are empty needles.

FINISHING: Pin each section to measurements, then dampen and let dry (do not use iron). Join front and back sections at sides and shoulders. Work 1 row of single crochet around all edges and armholes, then one row as follows: Chain 1, *single crochet in next 5 single crochets, chain 4, slip stitch into top of single crochet where chain 4 is (picot made). REPEAT from * around. Make cord for tie.

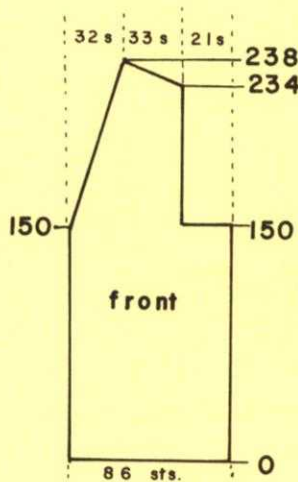
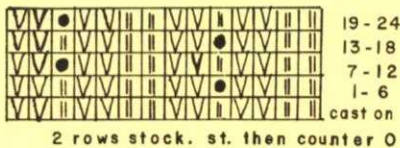
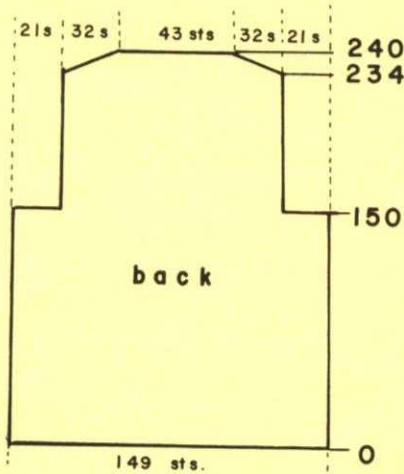

BONUS PATTERN



ON CAM BOX SIDE, bind off 14 sts. after Rows 234, 235; 11 sts. after Rows 236, 237; 7 sts. after Rows 238, 239. After Row 240 bind off remaining 43 sts.

ON CAM BOX SIDE, bind off 21 sts. after Rows 150, 151, then knit to Row 234.

ROWS 0 to 150: Knit even.

Bring 149 needles into working position, then set up according to the Line Drawing, knit 2 rows stockinette st., turn the Row Counter back to 0 and work the Holding Position Design.

Work the second front section with reverse shaping, casting on from right to left. (Cam Box will be on the LEFT side at Row 0) Begin Pattern by putting second single needle on the left side into holding position.

On OPPOSITE SIDE OF CAM BOX (Neck side), decrease 1 st. after Rows 150, 152, 154, 156, 158, 160, 162, 164, 166, 168, 170, 172, 174, 176, 178, 180, 182, 184, then continue to decrease 1 st. ON NECK SIDE after Rows 187, 190, 193, 196, 199, 202, 205, 208, 211, 214, 217, 220, 223, 226. For SHOULDER, bind off 14 sts. after Row 234; 11 sts. after Row 236; 8 sts. after Row 238.

ROWS 0 to 150: Knit even, then bind off 21 sts. ON CAM BOX SIDE for armhole.

Bring 86 needles into working position, then set up according to Line Drawing, knit 2 rows stockinette st., turn the Row Counter back to 0 and work the Holding Position Design. Begin pattern by putting the second single needle on the right into holding position first.

NOTES TO KNIT BY . . .

STITCH AND ROW GAUGE

KNIT A SAMPLE SWATCH . . . before you begin to knit any garment . . . for this is the MOST IMPORTANT STEP toward the correct size and the proper fit of any garment you wish to make. You MUST use the SAME YARN for your sample swatch that you will use to knit your garment and your sample swatch must be knitted large enough and using several different tension numbers on your machine. When you have done this, then you can determine the number of stitches and the number of rows in a two-inch measure. KNITTING MAGAZINE PATTERNS give you 3 tensions to try and one of them should give you the correct stitch and row gauge if you are using the yarn we recommend or a similar weight yarn. Here is the way to make your sample swatch.

Cast on over a sufficient number of needles to produce a swatch at least 4 inches wide. (If the pattern calls for 16 stitches to 2", then 16 x 2 = 32 stitches to cast on). Now knit 4 inches of rows at the first suggested tension number. (If the pattern calls for 22 rows to 2", 22 x 2 = 44 rows to knit). Knit 2 rows using a contrast color, change to the next higher tension and with garment yarn knit another 4", knit 2 rows with contrast color, change to the 3rd higher tension and knit another 4" and then bind off.



Roll the swatch into a cylinder over its length and pull on both ends, unroll it and stretch it diagonally by pulling on the four corners. Allow the swatch to rest and settle (preferably overnight) and then using a stitch gauge or a ruler, count the number of stitches over a 2" width, then the number of rows over a 2" length in EACH of the 3 tensions. Select the tension number that produces the stitches and rows called for in the pattern. If none of them are correct, you are most likely using the wrong weight of yarn.



READING OF CHARTS

You will notice the instructions start at the bottom of the Chart and work UP. Follow the charts exactly as written and providing your sample stitch and row gauge is correct, your garment will come out the right size. Please remember that the section of garment as it is knitted on the machine, faces

the same way as the Charts are in this magazine. Where two front pieces are needed, (or any other part of a garment that needs two sections) only one section is normally shown and the second section is sometimes made with reverse shaping. Set in sleeves are usually identical, but raglan sleeves have to be knitted with reverse shaping for the second sleeve.

READING OF SYMBOLS

Symbols are used on Line Drawings of Pattern stitches to show the position of the needles and the variety of stitches used for Pattern knitting. These Symbols are drawn and are to be read as you look at them while knitting the garment. For instance: if a Purl stitch faces you, the Purl stitch Symbol  is shown; if a knit stitch faces you (as when using the ribber) then this Symbol  is shown. The Line Drawings for pattern stitches are to be read and set up on your machine from RIGHT to LEFT unless otherwise stated in the individual instructions.

In EYELET design Patterns    specified stitches are transferred to an adjacent needle and the empty needles are returned to the working position. The drawings have row numbers on the RIGHT side. Missing Row Numbers are ALWAYS knitted straight or plain.

In HOLDING POSITION DESIGNS  selected needles are pushed into holding position for the stated number of rows. The numbers of rows appear at the right of the Line Drawings. Example: 1-4 means knit rows 1 to 4; 5-7 means knit rows 5 to 7; 8-12 means knit rows 8 to 12, etc. etc. (See below for more Pattern Stitch Symbols.)

BLOCKING and ASSEMBLING GARMENTS

Block each section of your knitting separately BEFORE assembling any garment. This not only makes putting your garment together much easier but gives it that professional look of perfection. For the correct assembly of garments and all other important information regarding machine knitting, refer to our book "Practical Knitting Hints."

PATTERN STITCH SYMBOLS



= knit stitch



= purl stitch



= empty needle (leave in working position)



= needle not used (in the out of work position)



= needle in the holding position



= 2 stitches on 1 needle - either transferred from the right side or the left side, then put the needle into holding position



= needle holding 2 stitches. Stitch has been transferred from the LEFT



= needle holding 2 stitches. Stitch has been transferred from the RIGHT



= 3 stitches on 1 needle. The 1st and 3rd stitch in a group of 3 needles has been hung on the 2nd or center needle.

The diagrams (Line Drawings) for pattern work are followed just as they are shown and are to be read as you look at them while knitting the garment.

open darts



closed darts



Knitking makes it easy...



"YARNS BY KNITKING." No matter how you knit, by needle or automatically, you will want this wonderful catalog that shows actual samples of the world's most exciting yarns ... a brilliant array of gorgeous colors and fabulous textures ... you'll be thrilled to pieces ... handsome cable yarns and other 100% virgin wools awarded the International Wool Seal, superb Satin-Cotton and Linen-Cotton, luxurious tweeds, even a new "soft as a kitten" synthetic that can be machine washed and dried. We traveled the globe for the finest yarns and we import them from Australia, Great Britain, Germany and many other countries. We sell directly to you at big savings!

PRICE: \$2.00. DEDUCTIBLE FROM FIRST \$10 ORDER
(CAL. RES. ADD 10¢ TAX)

PRACTICAL HINTS

A completely new publication... A reference book written especially for the machine knitter... Complete detailed instructions on measuring, charting, knitting, assembling and finishing garments... How to do fashioning and shaping... How to make buttonholes and do decorative stitching... eyelet designs, Norwegian patterns, etc., etc. Absolutely indispensable to all owners of knitting machines.



PRICE: \$3.35 INCL. POSTAGE
(CAL. RES. ADD 15¢ TAX)



KNITKING CHILDREN'S BOOK ... over 50 beautiful patterns for infants and children to teens ... boys and girls ... buntings, blankets and baby outfits to cute dresses, skirts and cardigans ... a treasure chest of gift ideas!

PRICE: \$3.35 INCL. POSTAGE
(CAL. RES. ADD 15¢ TAX)

KNITKING MAGAZINE ... it's the only knitting machine magazine published in America ... each issue has 20 or more up to the minute knitting patterns ... something for every member of the family ... fashions created by top designers and photographed on famous models, some in full color ... and you receive a bi-monthly newsletter with your subscription ... put KNITKING MAGAZINE on your must reading list and you'll be a fashion expert in no time!



YEAR'S SUBSCRIPTION. (6 ISSUES)
\$6.00 IN U.S.A. \$7.00 IN CANADA