

knitking

magazine

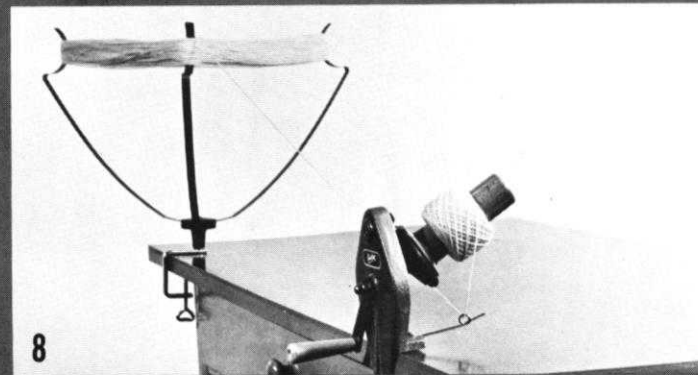

may/june '71

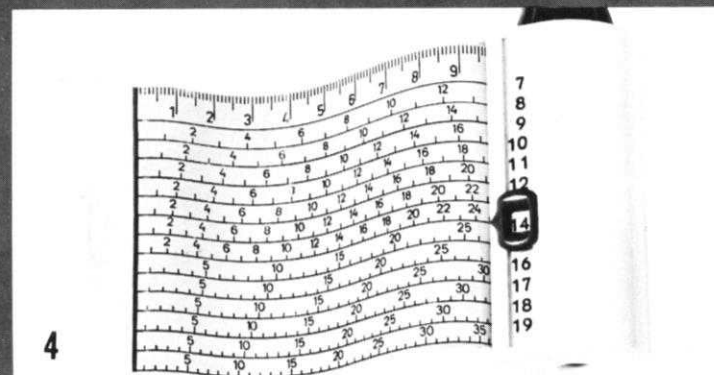
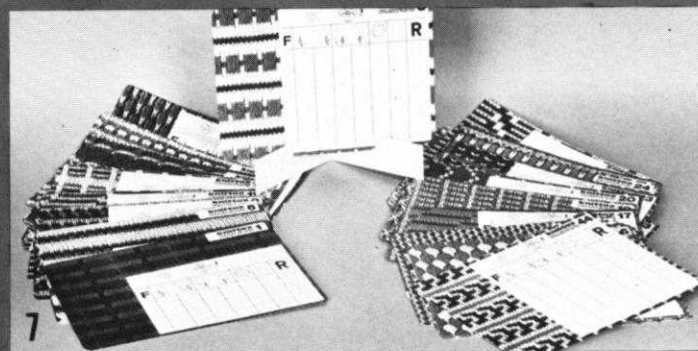
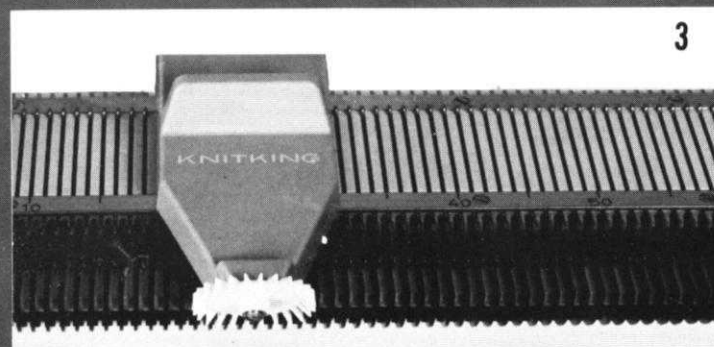
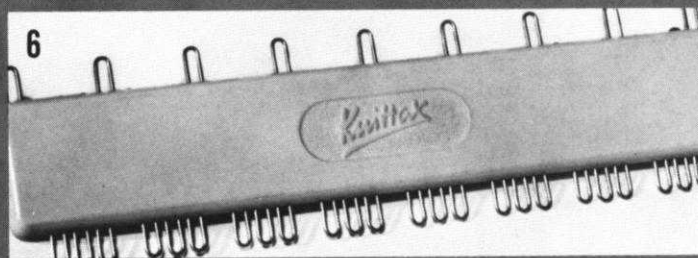
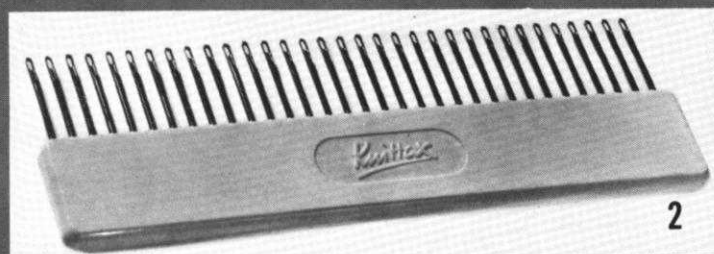
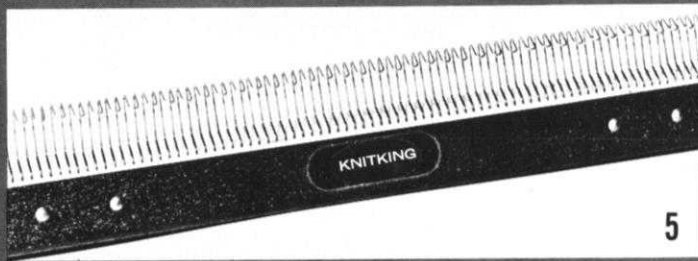

1. Treble Transfer Tools for rapid transfer of stitches and for Cable Stitch. \$1.50 pair plus 25¢ shipping.

2. 33 Needle Multi-Transfer Tool. For decreasing in the middle of a row. \$3.25 plus 25¢ shipping.

3. KNITKING Weaving Accessory (for AM 3 machine). Weaves an additional thread into your knitting and produces patterns with a woven appearance. \$6.95 plus 30¢ shipping.

4. Converta Tape. For simple and speedy charting of custom knits. \$6.95 plus 30¢ shipping.

accessories

5. Reversing Bar. For easy hem turning or reversing of knitting. \$17.95 plus \$1.50 shipping.

6. Adjustable Needle Selector. For setting unevenly spaced pattern stitches. \$3.50 plus 25¢ shipping.

7. KNITKING Pattern Stitch Cards (for AM 3 machine only). 48 Pattern Cards with 96 beautiful patterns in color and black and white. Simple row by row instructions. \$9.50 plus 95¢ shipping.

8. Yarn Winder and Skein Holder. Heavy cast frame and nylon gears. \$15.95 plus \$1.00 shipping. Without Skein Holder \$12.95 plus \$1.00 shipping.

California residents add 5% Sales Tax

KNITKING • 1128 Crenshaw Blvd., Los Angeles, California 90019

knitking

magazine

INDEX		PAGE NO.
DV 7040	Woman's Poncho	13
DK 7918	Woman's Pants, Tunic and Top	14
DP 7923	Woman's Pullover	16
DP 7931	Woman's Pullover	17
DP 7924	Woman's Pullover	18
DK 7921	Woman's Dress	19
DK 7919	Woman's Dress	20
DK 7922	Woman's 2-piece Dress (Skirt and Shell)	21
DK 7811	Woman's 2-piece Dress	22
DK 7920	Woman's Tunic	23
HP 3631	Man's Jacket	24
KK 5268	Boy's Jacket	25
HP 3629	Man's Pullover	26
HP 3630	Man's Pullover Shirt	27
MK 5270	Girl's Tunic and 2-piece Bathing Suit	28
MK 5273	Girl's Dress	29
KK 5272	Boy's Suit	30
MK 5271	Girl's Skirt and Shell	31
KG 1924	Man's Tie	32
KG 1925	Woman's Hat	32

knitking

magazine



Zero in on sun and fun places in KNITKING Fashion Knits of today... You need no special occasion to wear any of our beautifully designed dresses, pantsuits and pullovers. Knits for Men gain momentum and bright colors... bright stripes are on display everywhere... Knit the lovely Cover

Garment Pullover DP 7931 in KNITKING Amoretta with trim of Dralon 3-ply. Size 20/22. See page 17.

Make it a family affair... Sister and Brother are wearing matching outfits knitted with KNITKING Crocus Crepe. The darling Dress and smart Boy's Suit attracted a great deal of admiration at the Los Angeles County Fair in the fall of 1970.

MK 5273 - Size 7 to 8. See page 29.

KK 5272 - Size 6. See page 30.

Publisher: KNITKING CORPORATION, 1128 Crenshaw Blvd., Los Angeles, Calif. 90019. Telephone: WEBster 8-2079. Published bi-monthly. Subscriptions: USA - \$6.00 annually, single copies \$1.50; Canada - \$7.00; other parts of the world - \$10.00. The entire contents of KNITKING MAGAZINE are copyright and must not be reproduced in any shape or form without the express permission, in writing of the publisher. COPYRIGHT © by KNITKING CORPORATION 1971.

Printed by George Rice & Sons, Los Angeles, California

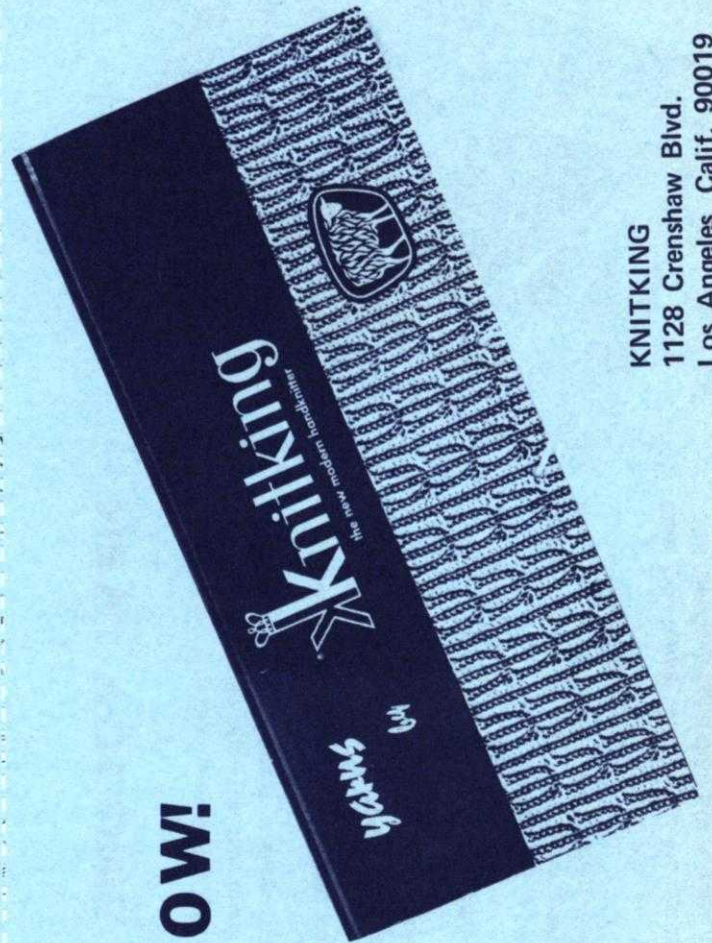

KNITKING
1128 Crenshaw Blvd.
Los Angeles, Calif. 90019

ORDER IT NOW!

Every reader of KNITKING
MAGAZINE needs the new big
beautiful KNITKING YARN
CATALOGUE with 329 actual
yarn samples... the finest
from around the world in an
unbelievable range of colors.

I enclose one dollar
Please RUSH my beautiful new
KNITKING YARN CATALOGUE to me at:

Name _____

Address _____

City _____ State _____ Zip _____



NEW VOLUME AVAILABLE NOW

A complete sixth volume of **KNITKING MAGAZINES** with a flexible, transparent plastic cover and specially bound so that it will stay open at any page, is available at the special price of \$6.95 (plus 85 cents mailing costs).

If purchased separately the magazines would cost a total of \$9.00.

The volume contains over 120 fully illustrated complete stylish patterns for all members of the family together with many valuable, practical knitting hints.

There is a very limited number of these volumes available and it will undoubtedly become a collectors item.

If you already have the entire set it will almost certainly be well thumbed and marked. Why not purchase a perfect mint condition volume for your bookshelf and ready reference at any time.

Place your order today and avoid disappointment. Send it to **KNITKING MAGAZINE, 1128 Crenshaw Boulevard, Los Angeles, California 90019.**

BOOKS by KNITKING

KNITKING CHILDREN'S BOOK

The Big, beautiful book of children's patterns. Over 50 complete and lovely patterns for infants and children to teenage. Buntings, Blankets and Baby outfits, cute Dresses, Leotites, Skirts, Suits, Pull-overs, Cardigans, Stockings, Trousers, etc. . . . The only Children's Book for the machine knitter published in the U.S.A. It sells for **\$2.95**

40 cents mailing
Calif. residents add 5% Sales Tax



PRACTICAL KNITTING HINTS

We call this book the **TEXT BOOK** for machine knitters because it answers the many questions that occur in machine knitting, from preparing to knit, taking measurements, shaping, making button-holes, special effects, bindings, bands and edges, etc., through finishing and blocking. It sells for **\$2.95**

40 cents mailing
Calif. residents add 5% Sales Tax



COLLECTING FILE

Keep your valuable **KNITKING MAGAZINES** in mint condition in a Collecting File. Each file holds twelve issues. **\$2.95**

75 cents mailing
Calif. residents add 5% Sales Tax

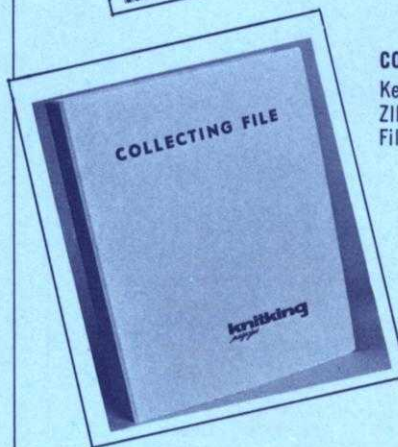

I enclose \$7.80

Please **RUSH** my bound Sixth Volume of **KNITKING MAGAZINE** to me at:

Name _____

Address _____

City _____ State _____ Zip _____

knitking

magazine

We have been following, with great interest, a series of articles in the Japan Sewing Machine Trade News, under the heading "Knitting Industry Faces Problems."

The articles refer to problems within the Japanese industry and it endeavors to analyze the reasons for them... It really is surprising that a country producing over 1,000,000 knitting machines a year for the past few years, should encounter such serious problems... many of them so insurmountable that some of the pioneer Japanese manufacturers have gone bankrupt.

The writers of the articles place the bulk of the blame for the falling off of sales in Japan, to the lack of service after sales and the failure of manufacturers to provide their customers with illustrated and charted patterns for use with their machines... They refer to the difficulties experienced by machine knitters in charting their own patterns and in overcoming the mathematical calculations necessary in the charting of garments. They say that many of the problems of the Japanese knitting machine industry would be overcome if they could produce well developed patterns as in Europe and America.

As the only American producer of illustrated and charted knitting machine patterns, we are pleased that the substantial Japanese knitting machine industry should use us as an example of correct procedures, especially when you take into consideration the comparatively poor market for knitting machines in America... Countries like South Africa, England, Korea, Taiwan, India, Australia and even Viet-Nam are selling more machines than the U.S.A.

Although the market for knitting machines will continue to grow in affluent America, we doubt that it will ever become a major industry here... We are certain that if we fail to provide services in the form of patterns, and practical advice, business will deteriorate just as it has in Japan. At KNITKING we continue to work at catering to the needs of every individual customer and to help every machine knitter obtain satisfaction in using her machine.

We are introducing in KNITKING NEWS in this issue, a new design Stitch & Row Calculator that will certainly make it easier for you to chart your own knits... and although similar calculators normally sell for \$4.95, we are offering ours free for a two-years subscription to KNITKING MAGAZINE.

Watch for the next issue of KNITKING MAGAZINE... We will be increasing our range of sizes in many garments... This will be of special interest to the larger size woman... Our cover will feature a two-piece summer Suit in a large size and inside we have a very varied (both in size and style) collection of Dresses, Suits and Pullovers for the Women, a good looking Pantsuit for teenage Girls... some cute outfits for the youngsters and some good looking Shirts for the Men.



LETTER
from the
PUBLISHER



DK 7918

Three to get ready . . . Wear the Crop Top over matching Slacks . . . both with striped borders . . . Tie a striped Sash low at the waist . . . Wear the Tunic over the Slacks, with or without a blouse . . . as a beach cover-up or even a Mini Dress. Your choice will always be right. Knitted with KNITKING Subita Crepe 2 x 3. Size 10/12. See page 14.



DP 7923

A long torso Pullover has wide border stripes and a high ribbed neckline. It can easily be knitted into a dress by adding extra rows at the lower edge. Purchase a leather belt to match the dark stripes. KNITKING Subita Crepe 2 x 4. Size 12/14. See page 16.



DP 7924

A delicate and feminine Holding Position Design is made with needles out of work and turns into a lovely short sleeved Pullover. Make it with KNITKING Fortissima. All bands are a 1 x 1 Rib. Size 8/10. See page 18.



DK 7921 Look ahead to Summer and knit this figure flattering sleeveless Dress with KNITKING Subita Crepe 2 x 3. The Skirt is knitted in 4 sections for a soft moving flare. The bodice is a Holding Position Design with Eyelets. Follow the Line Drawing or use JAC 40 and Pattern No. 406. Size 12/14. See page 19.



DK 7919 Cover bare shoulders with Cap Sleeves knitted as part of the back and front sections of a lovely summer Dress. KNITKING Amore is the yarn and a simple but beautiful Eyelet Design follows the Line Drawing. Size 14/16. See page 20.



DK 7922

From sunshine to moonlight you can wear this lovely two piece dress . . . The skirt is knitted in stockinette stitch, the sleeveless Shell in a two color Holding Position Design. Follow the Line Drawing or use JAC 40 and Pattern No. 432. KNITKING Subita Crepe 2 x 3. Size 12/14. See page 21.

DK 7811

A slimming trim 2-piece Dress for the larger sized woman has a vertical stripe pattern knitted sideways on the machine for the center of front section of the Blouse. Knit it with KNITKING 2 x 4. Size 26½ to 28½. See page 22.

DK 7920

Take off for resort living or dash to your favorite weekend spot. Wear a bright Tunic slashed high at the sides. Knit it with KNITKING Linen Cotton and Subita Dralon 2-ply. It's a holding position Design that follows the line drawing or use your JAC 40 and Pattern No. 70. Size 12/14. See page 23.

HP 3629

He'll want to spend the entire summer wearing this handsome crew neck Pullover. Knit it with KNITKING Crocus Crepe and stripe the neckline, pocket and sleeves with two contrasting colors. Size 38/40. See page 26.

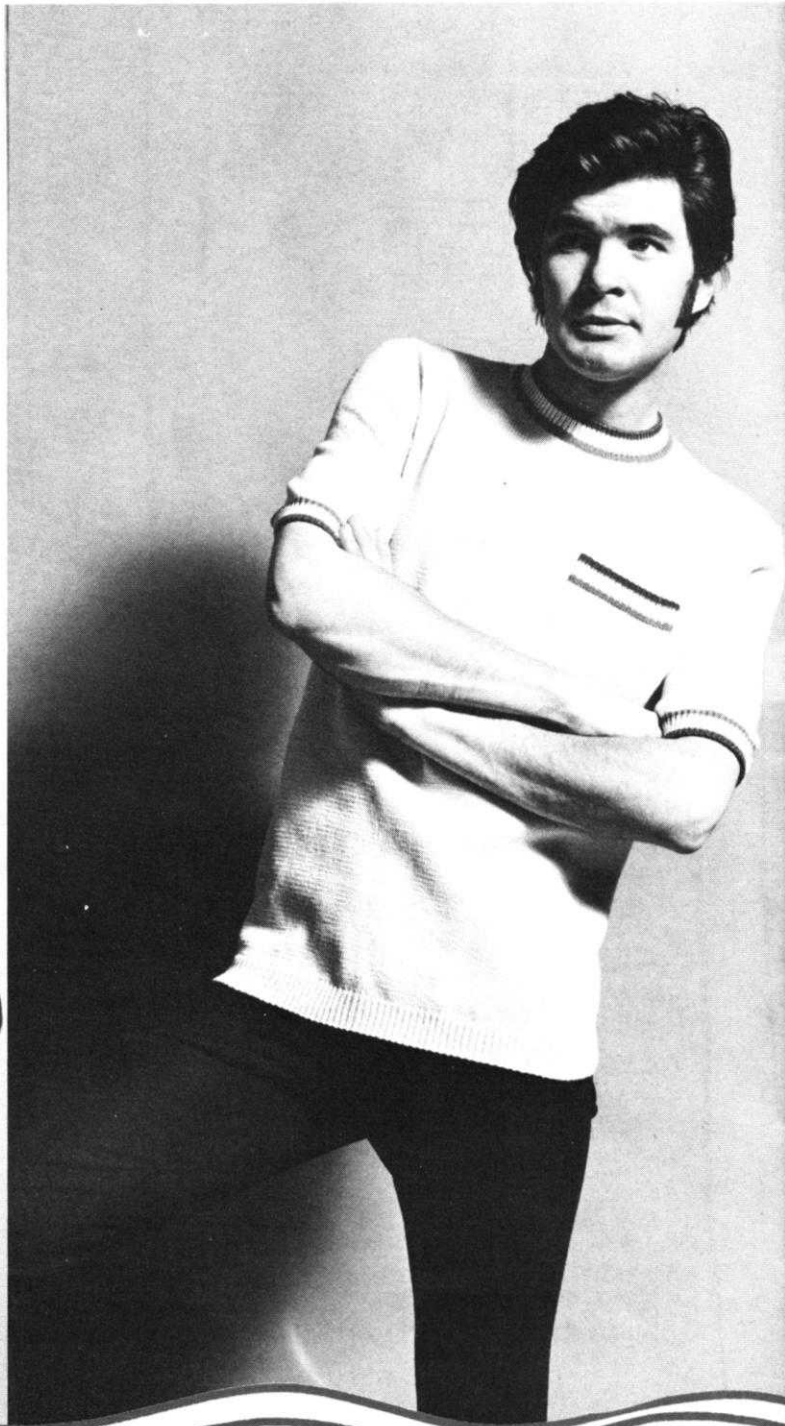

HP 3631 and KK 5268

Father and Son wear smartly styled zippered Jackets knitted with 2 colors of KNITKING Crocus Crepe. Striped Ribbing at Neckline, sleeve cuffs and lower edge.

HP 3631 — Size 36/38. See page 24.

KK 5268 — Size 8 to 10. See page 25.



HP 3630

Feather light! Wrinkle free! Wash and tumble dry!
... everything he wants in a summer Sport Shirt
knitted with KNITKING Subita Dralon 2-ply. A
small amount of contrasting color is used for the
stripe trim on pocket and neckline. We'll bet he
will order a supply of these ... Size 38/40.
See page 27.





MK 5270

She'll catch a Sunbeam dressed in the perfect 3-piece Beach outfit . . . Striped Trunks, Top and a gaily fringed Tunic are knitted in KNITKING Subita Dralon 3-ply . . . the wash 'n wear yarn. Size 7 to 8. See page 28.

MK 5271

She's ahead of the game wearing a flared suspender Skirt knitted in 4 sections. The striped Pullover has flattering Cap Sleeves. Knit it with KNITKING Subita Crepe 2 x 3. Size 9 to 10. See page 31.



KG 1924 and KG 1925

The most in fashion . . . A handsome wide Tie for him and a jaunty Hat for her . . . You can knit the tie in plain stockinette stitch or stripe it with colorful stripes. It's knitted with KNITKING Amore and if you line the ends with a wash and wear fabric, you can throw it in your washer and dryer.

You can wear the Hat to all the hat places you go. Turn the brim up and tack on a flower . . . Wear the brim down and use your imagination for a trim. It's easy to knit in one straight piece. Stockinette stitch for the lining . . . Fisherman's Rib to form the brim and a pretty holding position design over the lining. Use KNITKING Excelsior. Size 21" to 23" head size. See page 32.



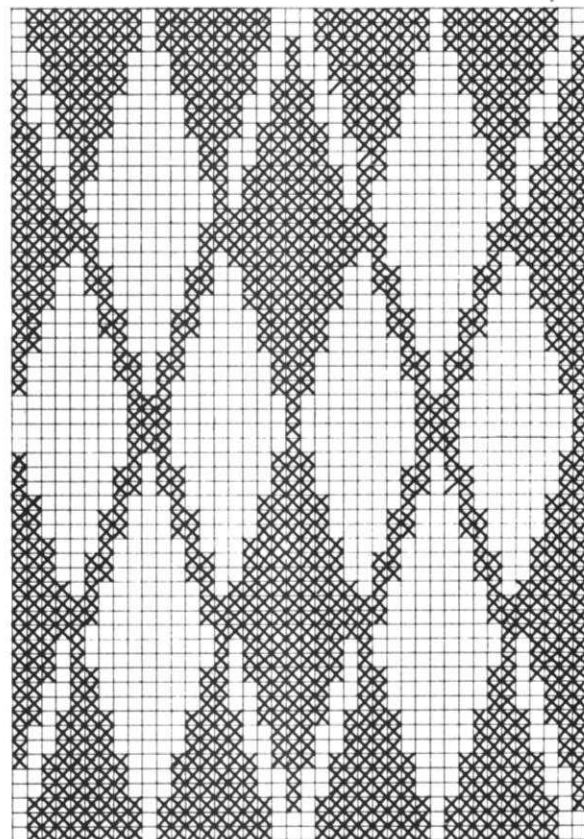

DV 7040

Wrap yourself in a swinging Poncho! You would not believe the requests we've had for a versatile Poncho . . . and this one will fit almost everyone. It's beautiful when knitted with KNITKING Double Knitting and has a Norwegian Border Design that follows the line drawing or you may use your JAC 40 and Pattern No. 116.

Work the second front section with reverse shapings, casting on from right to left. (Cam Box will be on the LEFT side at Row 0).

Continue to decrease 2 sts. on the right side (LEFT side for second front section) after Rows in (). For NECK, bind off 12 sts. after Row 235; 8 sts. after Row 237; (237), 5 sts. after Row 239; (240), 4 sts. after Row 241; 3 sts. after Rows 243, (243), 245.

ON THE RIGHT SIDE, (LEFT SIDE for second front section) decrease 2 sts. and on the left side (RIGHT side for second front section) decrease 1 st. after Rows 216, 219, 222, 225, 228, 231, 234, then knit to Row 235.

Work the front section the same as the back section to ROW 216.



Cast on 163 sts. with brown and with 2 tension settings lower work 70 rows K1, P1, Ribbing. After Row 70 bind off all sts. the crochet method for ribbing.

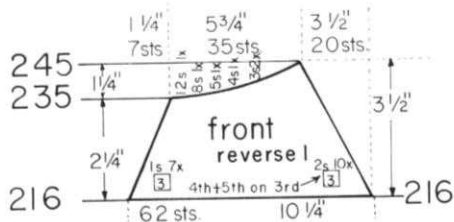

DV 7040

One Size fits all. MATERIAL: 35 oz. (20 balls) red and 8 3/4 oz. (5 balls) pale yellow KNITKING Double Knitting. TENSION: KNITKING 9 to 10. GAUGE: 12 sts. 2", 17 rows 2". PATTERN: Stockinette Stitch and a Norwegian Design according to Line Drawing, or use JAC 40 and Pattern No. 116. In the instructions each row in the Norwegian Design is counted as 1 row, but several movements of the Cam Box are needed to complete 1 row. COLLAR: K1, P1, Ribbing. Decreases of 1 stitch: After rows indicated, hang the 4th st. on the appropriate sides onto the 3rd st., then move the end sts. inward to fill the empty needle. Decreases of 2 stitches: After rows indicated, hang the 4th and 5th sts. on the appropriate side onto the 3rd st., then move the end sts. inward to fill the empty needles. Increases: After rows indicated, move the 2 end sts. on each side 1 needle outward, then place the 3rd st. from the row below onto the empty needle.

FINISHING: Block all sections to measurements given. Weave the sections together, 1 st. in from each edge. Turn under 2" at lower edge and hem to wrong side. Join short ends of collar, sew collar to neckline and fold over half to outside.

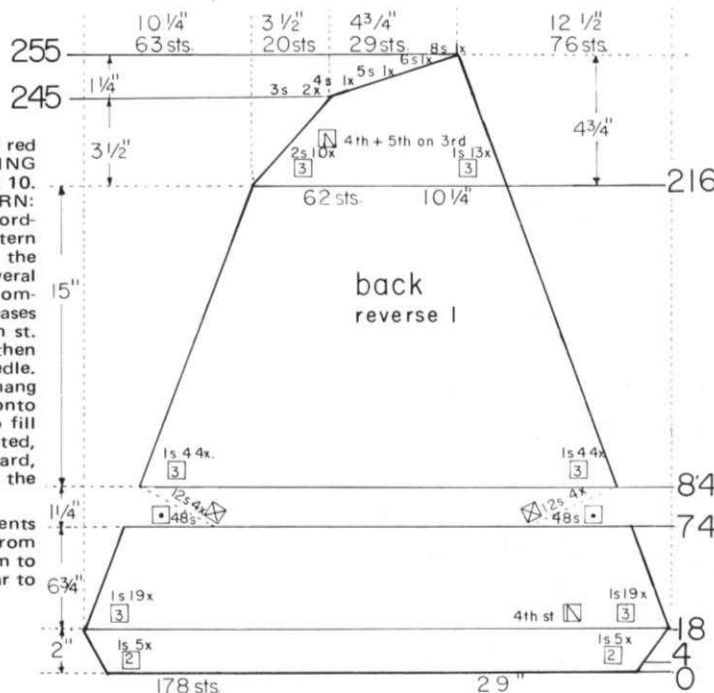

Work the second back section with reverse shapings, casting on from right to left. (Cam Box will be on the LEFT side at Row 0).

Continue to decrease 1 st. on the right side, (LEFT side for second back section) after Rows in (). For NECK bind off 3 sts. after 245, (246), 247; 4 sts. after Row 249; (249), 5 sts. after Row 251; (252), 6 sts. after Row 253; 8 sts. after Row 255.

ON THE LEFT SIDE (RIGHT SIDE for second back section) decrease 2 sts. and on the right side (LEFT side for second back section) decrease 1 st. after Rows 216, 219, 222, 225, 228, 231, 234, 237, 240, 243. The Shoulder is now completed.

ON EACH SIDE, decrease 1 st. after Rows 84, 87, 90, 93, 96, 99, 102, 105, 108, 111, 114, 117, 120, 123, 126, 129, 132, 135, 138, 141, 144, 147, 150, 153, 156, 159, 162, 165, 168, 171, 174, 177, 180, 183, 186, 189, 192, 195, 198, 201, 204, 207, 210, 213, then knit to Row 216.

Work Short Rows. ON OPPOSITE SIDE of CAM BOX put into holding position 48 needles after Rows 74, 75. ON OPPOSITE SIDE of CAM BOX bring back into working position 12 needles after Rows 76, 77, 78, 79, 80, 81, 82, 83, then knit to Row 84.

ON EACH SIDE, decrease 1 st. after Rows 18, 21, 24, 27, 30, 33, 36, 39, 42, 45, 48, 51, 54, 57, 60, 63, 66, 69, 72, then knit to Row 74, and continue working stockinette st. with red.

ROWS 0 to 16: ON EACH SIDE, increase 1 st. after Rows 4, 6, 8, 10, 12. Now knit to Row 16, begin the Norwegian Design and knit to Row 18.

Cast on 178 sts. with red and work stockinette st.

DK 7918

SIZE: 10/12. **MATERIAL:** TUNIC: 7 oz. (4 balls) white, 3 1/2 oz. (2 balls) medium blue, 3 1/2 oz. (2 balls) red and 3 1/2 oz. (2 balls) gold KNOTTING Subita Crepe 2 x 3; PANTS and TOP: 21 oz. (12 balls) white, 3 1/2 oz. (2 balls) medium blue, 1 1/2 oz. (1 ball) red and 1 1/2 oz. (1 ball) gold KNOTTING Subita Crepe 2 x 3. **White = Color 1, blue = Color 2, red = Color 3 and gold = Color 4. TENSION:** KNOTTING 3 to 5. **GAUGE:** 18 sts. 2", 24 rows 2". **PATTERN:** Stockinette Stitch with Color Stripes as marked in the diagrams. Make ALL shapings of 1 st. Full-fashion, DECREASES: After Rows indicated, hang the 3rd st. on the appropriate sides onto the 2nd st., then move the end sts. inward to fill the empty needle. **INCREASES:** After rows indicated, move the 2 end sts. on the appropriate sides 1 needle outward, then place the 3rd st. from the row below onto the empty needle. Begin the Pants Darts by hanging the sts. together as marked on the diagram, then move the end sts. inward to fill the empty needles. The following decreases for the darts lie directly above.

FINISHING: Block all sections to measurements given. **TUNIC:** Join front and back section at sides and shoulders. Turn under 18 rows on lower edge and hem to wrong side. With white, work 2 rows of single crochet around neckline and armhole edges. **TOP:** Join front and back sections at sides and shoulders. Sew sleeves together and set in. Turn under 10 rows on sleeve edges and hem to wrong side. Turn under 12 rows on lower edge, hem to wrong side and insert an elastic band. Fasten band on front edges, then turn under a small amount on front edges and hem to wrong side. With white, work 2 rows of single crochet around entire neckline, keeping work flat. Work 5 loops on the right front edge. Sew 2 snaps at hem line of left front edge. Try on, then sew buttons and other half of snaps in place. **PANTS:** Join front sections to back sections at sides. Close leg seams, then join sections at center front and center back. Turn under 19 rows on upper edge and leg edges and hem to wrong side. Insert an elastic band into upper hem. Sew loops in the open. (See picture). With gold weave together the open sts. of the belt. Remove the waste yarn. Fold the belt in half lengthwise and join long edges. Refold the belt, having the seam line at center back, then sew the open edges at each end.

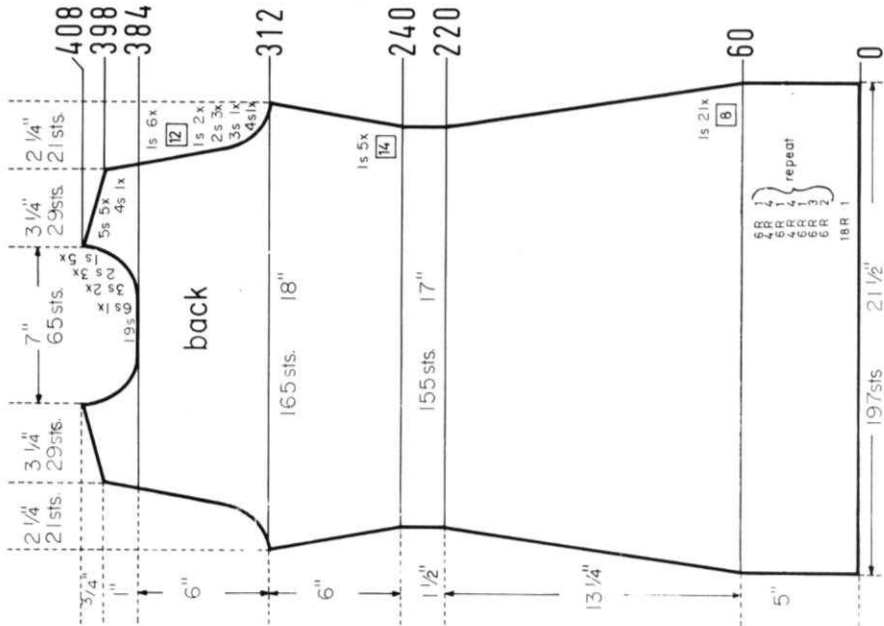
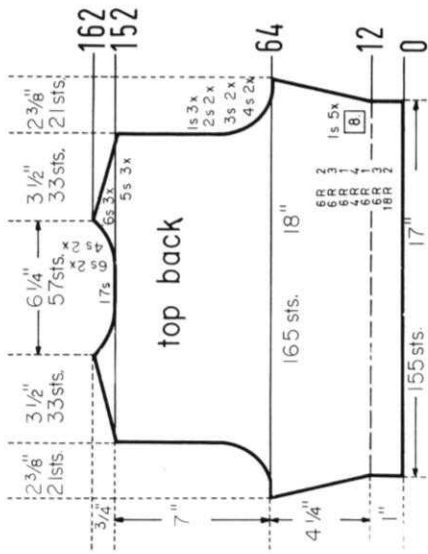

Work the second front section with reverse shapings, casting on from right to left. (Cam Box will be on the LEFT side at Row 0).

ON CAM BOX SIDE, bind off 4 sts. after Row 74 (EVEN ROWS = ARM-HOLE SHAPING); 2 sts. after Row 75 (ODD ROWS = FRONT SHAPING); 4 sts. after Row 76; 2 sts. after Row 77; 3 sts. after Row 78; 1 st. after Row 79; 3 sts. after Row 80; 1 st. after Row 81; 2 sts. after Row 82; 1 st. after Row 83; 2 sts. after Row 84; 1 st. after Row 85; 86, 87, 88, 89, 90. The Armhole Shaping is now completed. Continue to decrease 1 st. on FRONT EDGE after Rows 93, 97, 101, 105, 109, 113, 119, 125, 131, 137, 143, 148. For SHOULDER bind off 5 sts. after Rows 162, 164, 166; 6 sts. after Rows 168, 170, 172.

The FRONT SHAPING and the BUST DART begin at the same row. ON OPPOSITE SIDE of CAM BOX put 8 needles into holding position after Rows in (). ON CAM BOX SIDE, bind off 6 sts. after Rows 53, (53), 55, (55), 4 sts. after Rows 57, (57), 59, (59), 61, (61). Knit to Row 63, then bring all DART needles back into working position. ON CAM BOX SIDE, continue to bind off, 3 sts. after Rows 63, 65, 67; 2 sts. after Rows 69, 71, 73, then knit to Row 74. ON CAM BOX SIDE, increase 1 st. after Rows 12, 20, 28, 36, 44, then knit to Row 52 and continue with white. Knit to Row 53.

ROWS 0 to 12: Knit even. Cast on 110 sts. with blue, work stockinette st. and the color stripes as marked in the diagram.

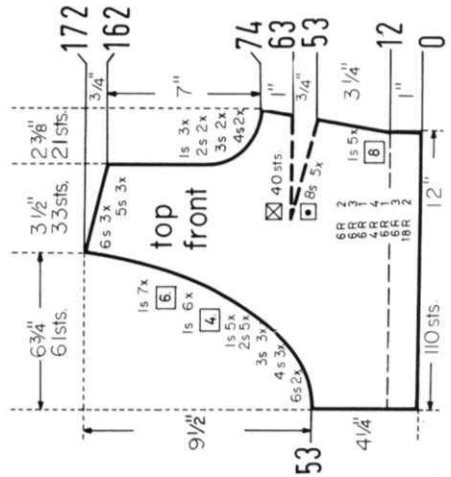

Move the Cam Box to the left side, turn the Row Counter back to 152 and complete the left half. Follow the instructions from *.

* ON CAM BOX SIDE, bind off 5 sts. after Row 152 (EVEN ROWS = SHOULDER SHAPING); 6 sts. after Row 153 (ODD ROWS = NECK SHAPING); 5 sts. after Row 154; 6 sts. after Row 155; 5 sts. after Row 156; 4 sts. after Row 157; 6 sts. after Row 158; 4 sts. after Row 159; 6 sts. after Rows 160, 162.

ON CAM BOX SIDE, bind off 4 sts. after Rows 64, 65, 66, 67; 3 sts. after Rows 68, 69, 70, 71; 2 sts. after Rows 72, 73, 74, 75; 1 st. after Rows 76, 77, 78, 79, 80, 81, then knit to Row 152, bind off the center 17 sts., put the needles on the left side into holding position and complete the right half first.

ON EACH SIDE, increase 1 st. after Rows 12, 20, 28, 36, 44, then knit to Row 52, continue with white and knit to Row 64.

ROWS 0 to 12: Knit even.

Cast on 155 sts. with blue, work stockinette st. and the color stripes as marked in the diagram.

Move the Cam Box to the left side, turn the Row Counter back to 384 and complete the left half. Follow the instructions from *.

* Decrease 1 more st. ON CAM BOX SIDE after Row in (). ON CAM BOX SIDE, bind off 6 sts. after Row 385 (ODD ROWS = NECK SHAPING); (386), 3 sts. after Rows 387, 389; 2 sts. after Rows 391, 393, 395; 1 st. after Row 397; 4 sts. after Row 398 (EVEN ROWS = SHOULDER SHAPING); 1 st. after Row 399; 5 sts. after Row 400; 1 st. after Row 401; 5 sts. after Row 402; 1 st. after Row 403; 5 sts. after Row 404; 1 st. after Row 405; 5 sts. after Rows 406, 408.

ON CAM BOX SIDE, bind off 4 sts. after Rows 312, 313; 3 sts. after Rows 314, 315; 2 sts. after Rows 316, 317, 318, 319, 320, 321. (For FRONT SECTION knit to Row 322). ON EACH SIDE, decrease 1 st. after Rows 322, 324, 326, 328, 330, 362, 374, then knit to Row 384, bind off the center 19 sts., put the needles on the left side into holding position and complete the right half first.

ON EACH SIDE, increase 1 st. after Rows 240, 254, 268, 282, 296, then knit to Row 312.

ON EACH SIDE, decrease 1 st. after Rows 60, 68, 76, 84, 92, 100, 108, 116, 124, 132, 140, 148, 156, 164, 172, 180, 188, 196, 204, 212, 220, then knit to Row 240

ROWS 19 to 60: Knit even.

ROWS 0 to 18: Knit even, then change to blue and work the repeated color stripes as marked in the diagram.

Cast on 197 sts. with white and work stockinette st.

DP 7923

SIZE: 12/14. **MATERIAL:** 14 oz. (8 balls) white = Color 1, 3 1/2 oz. (2 balls) blue = Color 2 and 1 3/4 oz. (1 ball) red = Color 3 **KNITTING** Subita Crepe 2 x 4. **TENSION:** KNITTING 7 to 9. **GAUGE:** 15 sts, 20 rows 2". **PATTERN:** Stockinette Stitch and Color Stripes as marked in the diagrams. **COLLAR:** K1, P1, Ribbing. **DECREASES:** After rows indicated, hang the 3rd st. on the appropriate sides onto the 2nd st., then move the end sts. inward to fill the empty needle, **INCREASES:** After rows indicated, move the 2 end sts. on each side 1 needle outward, then place the 3rd st. from the row below onto the empty needle. To form the hems, hang the cast-on sts. back onto the machine behind the latches, then knit the following row with 2 tension settings higher.

FINISHING: Block all sections to measurements given. (Subtract the hems). Join front and back sections at sides. Sew the sleeves together, then weave the sleeves to front and back section, 1 st. in from each edge. Join short ends of collar, then sew collar to neckline.

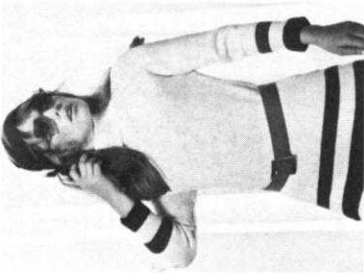

Move the Cam Box to the left side, turn the Row Counter back to 280 and complete the left half. Follow the instructions from *.

* Decrease 1 st. for RAGLAN after Row 280, then again after Rows in (). ON CAM BOX SIDE bind off 3 sts. after Rows 281, (282), 283; (284), 2 sts. after Rows 285, (286), 287; (288), 1 st. after Rows 289, (290), 291, (292), 293, (294), 295, (296), 297, (298). After Row 300 bind off the remaining 2 sts.

Work the front section the same as the back section to ROW 280, then bind off the center 10 sts., put the needles on the left side into holding position and complete the right half first.

Move the Cam Box to the left side, turn the Row Counter back to 288 and complete the left half. Follow the instructions from *.

* Decrease 1 st. for RAGLAN after Row 288, then again after Rows in (). ON CAM BOX SIDE bind off 4 sts. after Row 289 (ODD ROWS = NECK SHAPING); (290), 2 sts. after Rows 291, (292), 293; (294), 1 st. after Rows 295, (296), 297, (298). After Row 300 bind off the remaining 2 sts.

ON EACH SIDE, decrease 1 st. after Rows 200, 202, 204, 206, 208, 210, 212, 214, 216, 218, 220, 222, 224, 226, 228, 230, 232, 234, 236, 238, 240, 242, 244, 246, 248, 250, 252, 254, 256, 258, 260, 262, 264, 266, 268, 270, 272, 274, 276, 278, 280, 282, 284, 286 then knit to Row 288, bind off the center 20 sts., put the needles on the left side into holding position and complete the right half first. (For the FRONT SECTION make decreases after Row 278, then knit to Row 280).

ROWS 37 to 200: Work 16 rows white, 14 rows red, then continue with white and knit even to Row 200.

ROWS 0 to 36: Knit even, then form the hem.

Cast on 144 sts. with blue and work stockinette st.

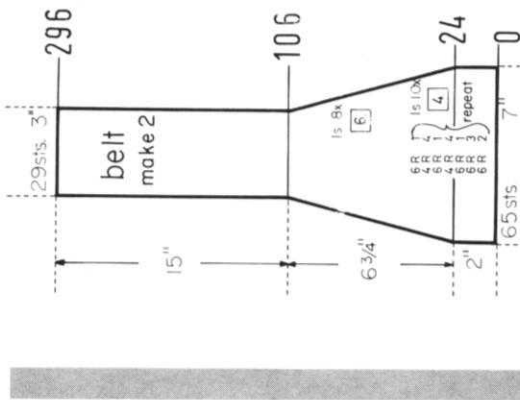
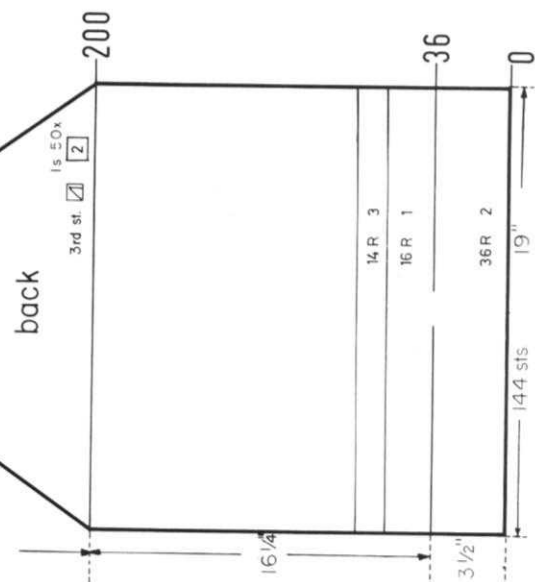
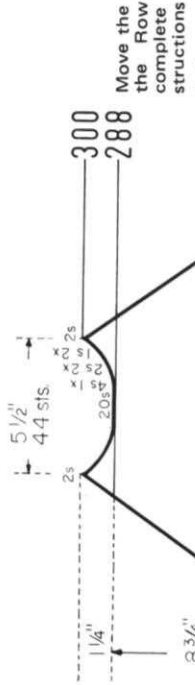
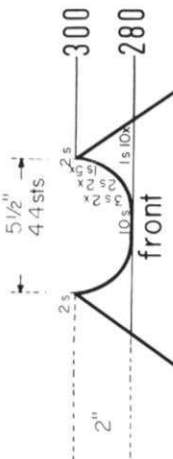

Work the second belt, the same to Row 295, (ending with 1 row gold) then knit several rows with contrast waste yarn and remove work from the machine.

ON EACH SIDE, decrease 1 st. after Rows 24, 28, 32, 36, 40, 44, 48, 52, 56, 60, 64, 70, 76, 82, 88, 94, 100, 106, then knit to Row 296, (ending with 2 rows of gold) knit several rows with contrast waste yarn, then remove work from the machine. (Knit 1 row without yarn).

ROWS 0 to 24: Knit even.

Cast on 65 sts. with blue, work stockinette st. and the repeated color stripes as marked in the diagram.

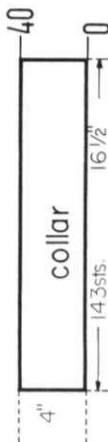

Cast on 143 sts. with white and work 40 rows K1, P1, Ribbing, then bind off all sts. the crochet method for ribbing.

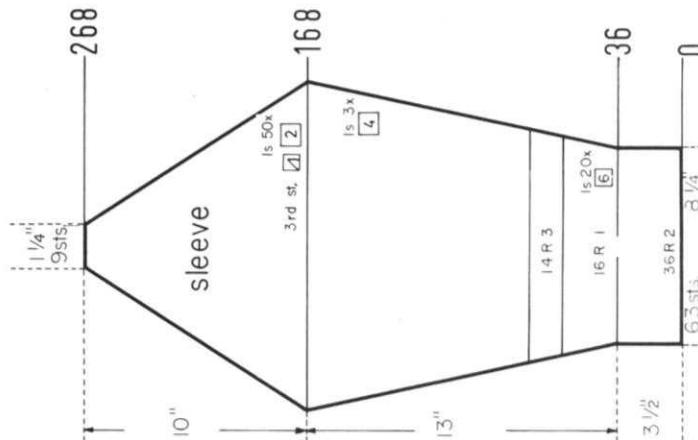

Work the second sleeve the same.

ON EACH SIDE, decrease 1 st. after Rows 168, 170, 172, 174, 176, 178, 180, 182, 184, 186, 188, 190, 192, 194, 196, 198, 200, 202, 204, 206, 208, 210, 212, 214, 216, 218, 220, 222, 224, 226, 228, 230, 232, 234, 236, 238, 240, 242, 244, 246, 248, 250, 252, 254, 256, 258, 260, 262, 264, 266, then knit to Row 268 and bind off the remaining 9 sts.

ON EACH SIDE, increase 1 st. after Rows 36, 42, 48, 54, 60, 66, 72, 78, 84, 90, 96, 102, 108, 114, 120, 126, 132, 138, 144, 150, 156, 160, 164, then knit to Row 168.

ROWS 0 to 36: Knit even, then form the hem, change to white and work the color stripes as marked in the diagram.

Cast on 63 sts. with blue and work stockinette st.

DP 7931

SIZES: 20/22 (Bust 42"-44"). **MATERIAL:** 12 1/2 oz. (7 balls) blue KNITTING Amoretta and 1 1/2 oz. (1 ball) white KNITTING Subita Dralon 3 ply. **TENSION:** KNITTING 6 to 8 GAUGE: 15 sts, 2", 23 rows 2". **PATTERN:** Stockinette Stitch worn on the purl side. **LOWER EDGE:** K1, P1, Ribbing. **BAND and SLEEVE EDGES:** Stockinette Stitch worn on the knit side. **NECK DECREASES:** After rows indicated, hang the 3rd st. **ON NECK SIDE** onto the 2nd st., then move the end sts inward to fill the empty needle. **SLEEVE INCREASES:** After rows indicated, move the 2 end sts. on each side 1 needle outward, then place the 3rd st. from the row below onto the empty needle.

FINISHING: Wet block all sections to measurements given. Join front and back section at sides and shoulders. Sew sleeves together and set in. Fold sleeve edges in half and hem to right side. Beginning at the left side at center of front neckline, weave 1 edge of band to outside and 1 edge to inside of neckline, then continue weaving the band to the front as illustrated. Crochet around foldline of the band and sleeve edges as follows: Attach yarn to first st. * 1 double crochet, chain 1, 1 double crochet, chain 1, 1 double crochet in next st., chain 1, skip 3, 1 single crochet in next st., chain 1, skip 3. Repeat from *. Sew buttons to pullover as illustrated.

knit
magazine

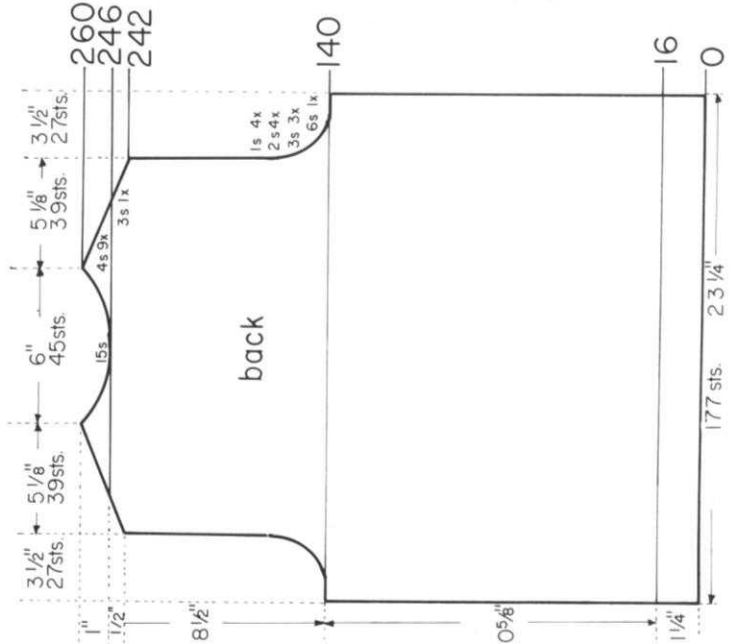
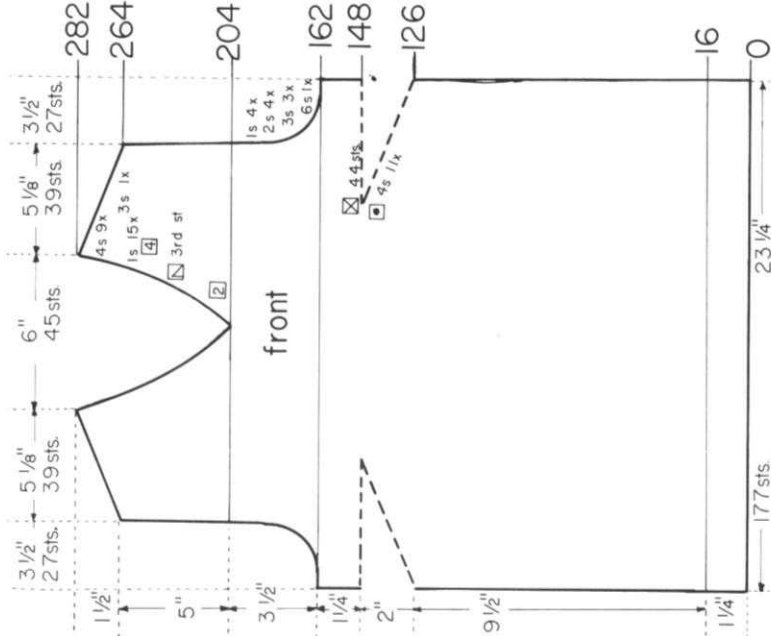

Move the Cam Box to the left side, turn the Row Counter back to 246 and complete the left half. Follow the instructions from *.

* ON CAM BOX SIDE, bind off 4 sts. after Row 246 (EVEN ROWS = SHOULDER SHAPING); 5 sts. after Row 247 (ODD ROWS = NECK SHAPING); 4 sts. after Row 248; 3 sts. after Row 249; 4 sts. after Row 250; 3 sts. after Row 251; 4 sts. after Row 252; 2 sts. after Row 253; 4 sts. after Row 254; 2 sts. after Row 255; 4 sts. after Rows 256, 258, 260.

ON CAM BOX SIDE, bind off 3 sts. after Rows 242, 243; 4 sts. after Rows 244, 245, then knit to Row 246, bind off the center 15 sts., put the needles on the left side into holding position and complete the right half first.

ON CAM BOX SIDE, bind off 6 sts. after Rows 140, 141; 3 sts. after Rows 142, 143, 144, 145, 146, 147; 2 sts. after Rows 148, 149, 150, 151, 152, 153, 154, 155; 1 st. after Rows 156, 157, 158, 159, 160, 161, 162, 163, then knit to Row 242.

ROWS 17 to 140: Knit even.
ROWS 0 to 140: Knit even, then change to stockinette st.
Cast on 177 sts. with blue and work K1, P1, Ribbing.

Move the Cam Box to the left side, turn the Row Counter back to 204 and complete the left half. Follow the instructions from *.

* Decrease 1 st. ON NECK SIDE after Rows 206, 208, 210, 212, 214, 216, 218, 220, 224, 228, 232, 236, 240, 244, 248, 252, 256, 260, then continue to decrease 1 st. ON NECK SIDE after Rows in (.). For SHOULDER bind off 3 sts. after Row 264; (264), 4 sts. after Rows 266, 268, (268), 270, 272, (272), 274, 276, (276), 278, 280, 282.

ON CAM BOX SIDE, bind off 6 sts. after Rows 162, 163; 3 sts. after Rows 164, 165, 166, 167, 168, 169; 2 sts. after Rows 170, 171, 172, 173, 174, 175, 176, 177; 1 st. after Rows 178, 179, 180, 181, 182, 183, 184, 185, then knit to Row 204, hang the center st. onto the neighboring needle, put the needles on the left side into holding position and complete the right half first.

Work Short Rows for the DARTS. ON OPPOSITE SIDE of CAM BOX put into holding position 4 needles after Rows 126, 127, 128, 129, 130, 131, 132, 133, 134, 135, 136, 137, 138, 139, 140, 141, 142, 143, 144, 145, 146, 147. ON OPPOSITE SIDE of CAM BOX bring all needles back into working position after Rows 148, 149, then knit to Row 162.

ROWS 17 to 126: Knit even.
ROWS 0 to 16: Knit even, then change to stockinette st.
Cast on 177 sts. and work K1, P1, Ribbing.

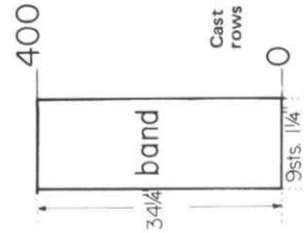

Cast on 9 sts. with white and work 400 rows stockinette st., then bind off all sts.

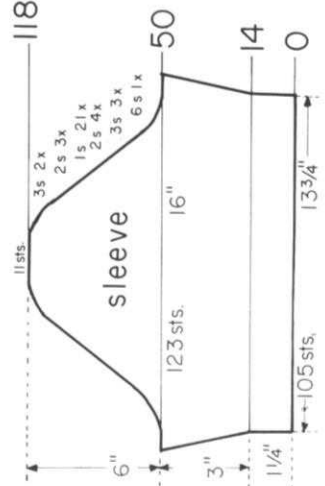

ON CAM BOX SIDE, bind off 6 sts. after Rows 50, 51; 3 sts. after Rows 52, 53, 54, 55, 56, 57; 2 sts. after Rows 58, 59, 60, 61, 62, 63, 64, 65. ON EACH SIDE, hang the 1st st. onto the 2nd st. after Rows 66, 68, 70, 72, 74, 76, 78, 80, 82, 84, 86, 88, 90, 92, 94, 96, 98, 100, 102, 104, 106. ON CAM BOX SIDE, bind off 2 sts. after Rows 108, 109, 110, 111, 112, 113; 3 sts. after Rows 114, 115, 116, 117; 11 sts. after Row 118. ON EACH SIDE, increase 1 st. after Rows 14, 18, 22, 26, 30, 34, 38, 42, 46, then knit to Row 50.
ROWS 0 to 14: Knit even, then change to blue.
Cast on 105 sts. with white and work stockinette st.

DP 7924

SIZE: 8/10. MATERIAL: 10½ oz. (6 balls) white KNITTING Fortissima. TENSION: KNITTING 5 to 7. GAUGE: Pattern Stitch 16 sts, 2", 23 rows 2". PATTERN: Holding Position Design with omitted needles according to Line Drawing, worn on the purl side. The omitted sts. in the pattern do count as sts. in the gauge and instructions. EDGES: K1, P1. Ribbing. INCREASES: After rows indicated, move the 2 end sts. on each side 1 needle outward then place the 3rd st. from the row below onto the empty needle. When binding off, or decreasing, be sure to count the empty spaces as sts.

FINISHING: Block all sections to measurements given. Weave front and back sections together at sides, 1 st. in from each edge, easing in the fullness at bustline of front section. Join shoulders. Sew sleeves together and set in. Sew 1 edge of collar to inside and 1 edge to outside of neckline. Work 1 row of single crochet around back opening, then sew in a zipper.

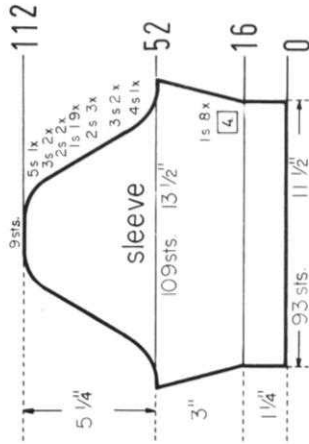
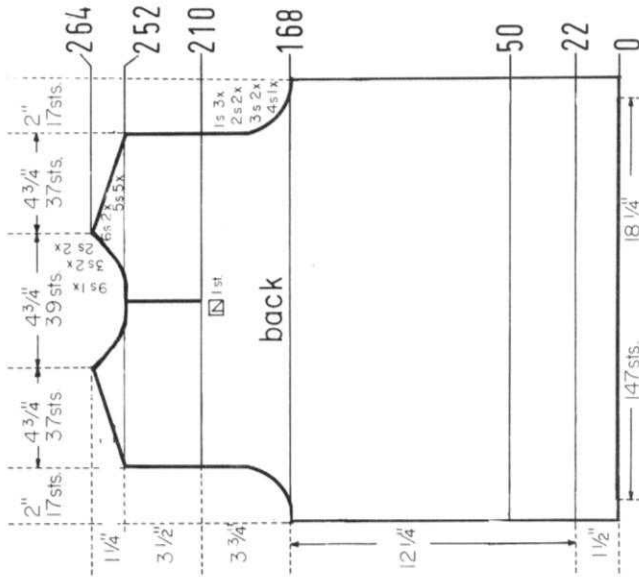
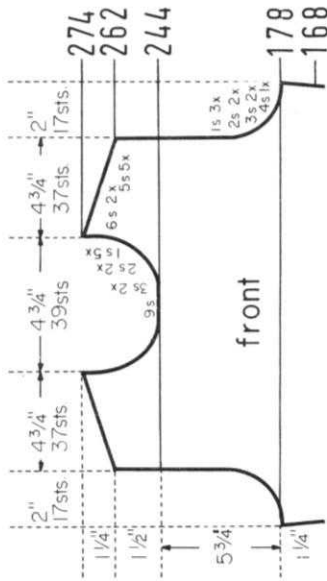
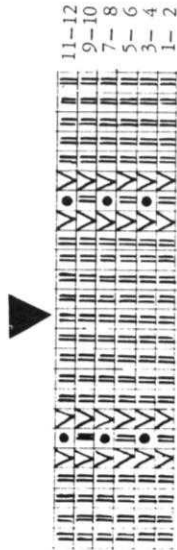

ON CAM BOX SIDE, bind off 4 sts. after Rows 52, 53; 3 sts. after Rows 54, 55, 56, 57; 2 sts. after Rows 58, 59, 60, 61, 62, 63. ON EACH SIDE, hang the 1st st. onto the 2nd st. after Rows 64, 66, 68, 70, 72, 74, 76, 78, 80, 82, 84, 86, 88, 90, 92, 94, 96, 98, 100. ON CAM BOX SIDE, bind off 2 sts. after Rows 102, 103, 104, 105; 3 sts. after Rows 106, 107, 108, 109; 5 sts. after Rows 110, 111; 9 sts. after Row 112.

The increases are made without having empty needles. ON EACH SIDE, increase 1 st. after Rows 16, 20, 24, 28, 32, 36, 40, 44, then knit to Row 52.

ROWS 0 to 16: Knit even, then transfer the ribber sts. to the main machine, hang the appropriate sts. to the neighboring needles, put the empty needles into the non-working position and work the Holding Position Design.

Cast on 93 sts. and work K1, P1, Ribbing.

Bring the needles on the left side into working position, knit 1 row in PATTERN to the left side, turn the Row Counter back to 244 and complete the left half. Follow the instructions from *.

* ON CAM BOX SIDE, bind off 3 sts. after Rows 245, 247 (ODD ROWS = NECK SHAPING); 2 sts. after Rows 249, 251; 1 st. after Rows 253, 255, 257, 259, 261. For SHOULDER bind off 5 sts. after Rows 262, 264, 266, 268, 270; 6 sts. after Rows 272, 274.

ON CAM BOX SIDE, bind off 4 sts. after Rows 178, 179; 3 sts. after Rows 180, 181, 182, 183; 2 sts. after Rows 184, 185, 186, 187; 1 st. after Rows 188, 189, 190, 191, 192, 193, then knit to Row 244, bind off the center 9 sts., put the needles on the left side into holding position and complete the right half first.

ROWS 169 to 178: Knit even. Work the front section the same as the back section to ROW 168.

Bring the needles on the left side into working position, knit 1 row in PATTERN to the left side, turn the Row Counter back to 210 and complete the left half. Follow the instructions from *.

ON CAM BOX SIDE, bind off 5 sts. after Row 252 (EVEN ROWS = SHOULDER SHAPING; 9 sts. after Row 253 (ODD ROWS = NECK SHAPING); 5 sts. after Row 254; 3 sts. after Row 255; 5 sts. after Row 256; 3 sts. after Row 257; 5 sts. after Row 258; 2 sts. after Row 259; 5 sts. after Row 260; 2 sts. after Row 261; 6 sts. after Rows 262, 264.

* ROWS 211 to 252: Knit even.

ON CAM BOX SIDE, bind off 4 sts. after Rows 168, 169; 3 sts. after Rows 170, 171, 172, 173; 2 sts. after Rows 174, 175, 176, 177; 1 st. after Rows 178, 179, 180, 181, 182, 183, then knit to Row 210, hang the center st. onto the neighboring needle, put the needles on the left side into holding position and complete the right half first.

ROWS 23 to 168: Knit even.

ROWS 0 to 22: Knit even, then transfer the ribber sts. to the main machine, hang the appropriate sts. to the neighboring needles, put the empty needles in the non-working position and work the Holding Position Design.

Cast on 147 sts. and work K1, P1, Ribbing.

Cast on 125 sts. and work K1, P1, Ribbing. After Row 38 bind off all sts. the crochet method for ribbing.

BE SURE TO NOTIFY US IMMEDIATELY OF ANY CHANGE OF ADDRESS. THE POST OFFICE WILL NOT FORWARD YOUR MAGAZINE TO YOU.

DK 7921

SIZE: 12/14. **MATERIAL:** 15% oz. (9 balls) green and 1 1/2 oz. (1 ball) white KNITTING Subita Crepe 2 x 3. **TENSION:** KNITTING 3 to 5. **GAUGE:** Stockinette Stitch 17 sts., 2", 23 rows, 2"; Pattern Stitch 17 sts., 30 rows 2". **PATTERN:** SKIRT: Stockinette Stitch worn on the knit side; BODICE: Holding Position Design with Eyelets and omitted needles according to Line Drawing, or use JAC 40 and Pattern No. 406. The purl side is the right side. The omitted needles in the Holding Position Design do count as sts. in the gauge and instructions. **NECK EDGE and ARMHOLE EDGES:** Single and Double Crochet. **DECREASES:** After rows indicated, hang the 3rd st. on each side onto the 2nd st., then move the end sts. inward to fill the empty needle. The finished length of the dress is about 34".

FINISHING: Block all sections to measurements given. Weave the skirt sections together, 1 st. in from each edge. Join front and back section of bodice at sides and shoulders, easing in the fullness at bustline of front section. Join bodice to skirt. Crochet around front opening, neckline and armholes as follows: **ROW 1:** Single crochet with green keeping work flat. Chain 1, turn, then continue with white. **ROW 2:** Single crochet into each st. of the previous row, chain 3 and turn. **ROW 3:** *Skip 2 sts., double crochet in next st. REPEAT from *. Close front opening with 3 buttons.

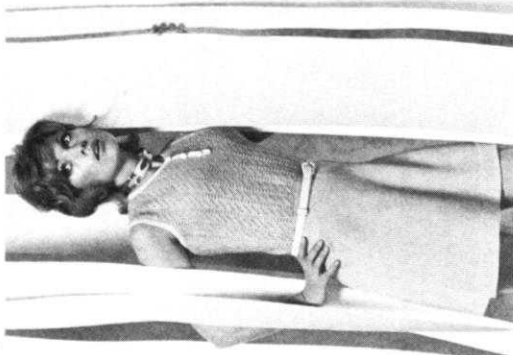
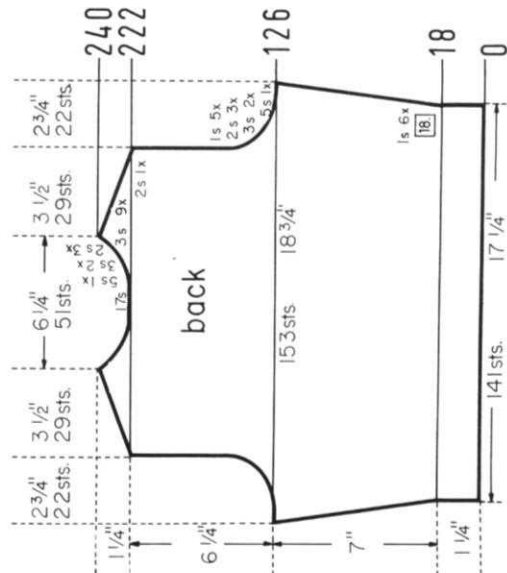
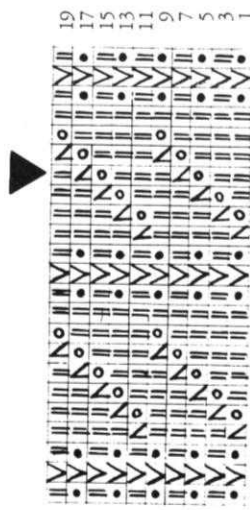

Bring the needles on the left side into working position, knit 1 row in PAT-TERN to the left side, turn the Row Counter back to 222 and complete the left half. Follow the instructions from *.

* ON CAM BOX SIDE, bind off 2 sts. after Row 222 (EVEN ROWS = SHOULDER SHAPING); 5 sts. after Row 223 (ODD ROWS = NECK SHAPING); 3 sts. after Rows 224, 225, 226, 227, 228; 2 sts. after Row 229; 3 sts. after Row 230; 2 sts. after Row 231; 3 sts. after Row 232; 2 sts. after Row 233; 3 sts. after Rows 234, 236, 238, 240.

ON CAM BOX SIDE, bind off 5 sts. after Rows 126, 127; 3 sts. after Rows 128, 129, 130, 131; 2 sts. after Rows 132, 133, 134, 135, 136, 137; 1 st. after Rows 138, 139, 140, 141, 142, 143, 144, 145, 146, 147, then knit to Row 222, bind off the center 17 sts., put the needles on the left side into holding position and complete the right half first.

ON CAM BOX SIDE, increase 1 st. after Rows 18, 19, 36, 37, 54, 55, 72, 73, 90, 91, 108, 109, then knit to Row 126. (For the FRONT SECTION knit to Row 120).

ROWS 0 to 18: Knit even.

Cast on 141 sts., knit 2 rows, turn Row Counter back to 0, hang the sts. to be omitted onto the neighboring needles, put the empty needles into the non-working position and work the Eyelet and Holding Position Design.

Bring the needles on the left side into working position, knit 1 row in PAT-TERN to the left side, turn the Row Counter back to 120 and complete the left half. Follow the instructions from *.

ON CAM BOX SIDE, bind off 6 sts. after Row 187 (ODD ROWS = NECK SHAPING); 3 sts. after Rows 189, 191; 2 sts. after Rows 193, 195, 197; 1 st. after Rows 199, 201, 203, 205, 207, 209, 211. For SHOULDER bind off 2 sts. after Row 234; 3 sts. after Rows 236, 238, 240, 242, 244, 246, 248, 250, 252.

ON CAM BOX SIDE, bind off 5 sts. after Row 138; 3 sts. after Rows 140, 142; 2 sts. after Rows 144, 146, 148; 1 st. after Rows 150, 152, 154, 156, 158, then knit to Row 187.

* ROWS 121 to 138: Knit even.

Work the front section the same as the back section to ROW 120, then hang the center st. onto the neighboring needle, put the needles on the left side into holding position and complete the right half first.

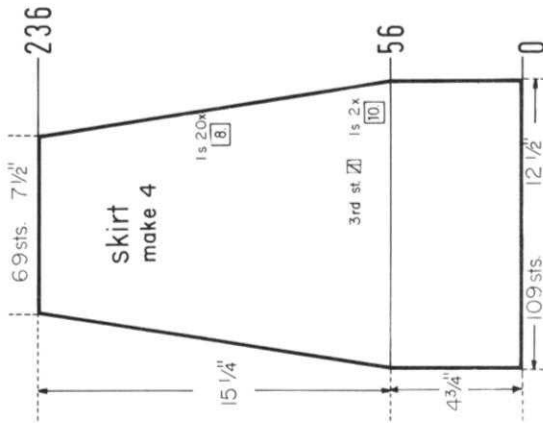
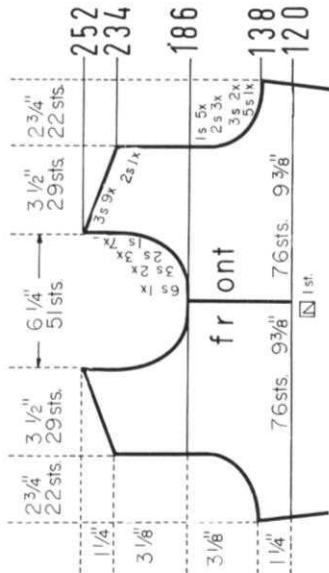

Work 3 more sections the same.

ON EACH SIDE, decrease 1 st. after Rows 56, 66, 76, 84, 92, 100, 108, 116, 124, 132, 140, 148, 156, 164, 172, 180, 188, 196, 204, 212, 220, 228, then knit to Row 236 and bind off the remaining 65 sts.

ROWS 0 to 56: Knit even.

Cast on 109 sts. and work stockinette st.

CANADIAN READERS

Please note that KNITTING dealers based in the U.S.A. are unable to sell machines and accessories to residents of Canada. They are also unable to sell parts and service. Would all Canadian readers please contact the following appointed KNITTING dealer.

KNITTING Sales and Service
2243 Danforth Ave.
Toronto 13, Ontario

DK 7922

SIZE: 12/14. **MATERIAL:** 14 oz. (8 balls) beige and 5 1/4 oz. (3 balls) rust KNOTTING Subita Crepe 2 x 3. **TENSION:** KNOTTING 3 to 5. **GUAGE:** Stockinette Stitch 18 sts. 2", 25 rows 2"; Pattern Stitch 16 sts. 2", 41 rows 2". **PATTERN:** SKIRT and BANDS: Stockinette Stitch; **SHELL:** Holding Position Design according to Line Drawing, or use JAC 40 and Pattern No. 432. **KNITTING MACHINES:** push in the left Retractor Button. **SKIRT DECREASES:** After rows indicated, hang the 3rd st. on each side onto the 2nd st., then move the end sts. inward to fill the empty needle. The finished length of the skirt is about 22".

FINISHING: Block all sections to measurements given. **SKIRT:** Weave all sections together at sides, 1 st. in from each edge. Turn under 20 rows on lower edge and 15 rows on upper edge and hem to wrong side. Insert an elastic band into upper hem. **SHELL:** Join front and back section at sides and shoulders, easing in the fullness at bustline of front section. Join short ends of neckband and armhole bands. Sew 1 edge of neckband to inside and 1 edge to outside of neckline. Sew armhole bands to armholes in the same manner. Turn under 1" at lower edge and hem to wrong side. Fold pocket flap in half lengthwise, then sew flap to shell. (See picture).

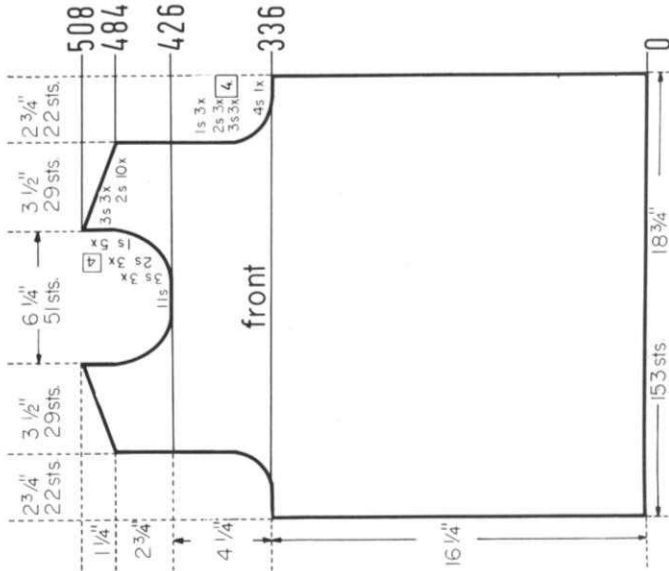
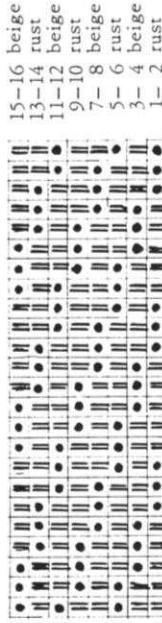

Bring the needles on the left side into working position, knit 1 row in PATTERN to the left side, turn the Row Counter back to 426 and complete the left half. Follow the instructions from *.

* ON CAM BOX SIDE, bind off 3 sts. after Rows 429, 433, 437 (ODD ROWS = NECK SHAPING); 2 sts. after Rows 441, 445, 449; 1 st. after Rows 453, 457, 461, 465, 469. For SHOULDER bind off 2 sts. after Rows 484, 486, 488, 490, 492, 494, 496, 498, 500, 502; 3 sts. after Rows 504, 506, 508.

ON CAM BOX SIDE, bind off 4 sts. after Rows 336, 337; 3 sts. after Rows 340, 341, 344, 345, 348, 349; 2 sts. after Rows 352, 353, 356, 357, 360, 361; 1 st. after Rows 364, 365, 368, 369, 372, 373, then knit to Row 426, bind off the center 11 sts., put the needles on the left side into holding position and complete the right half first. (While working the right half, bring pattern needles back into working position manually).

ROWS 0 to 336: Knit even.

Cast on 153 sts. with rust and work the Holding Position Design.

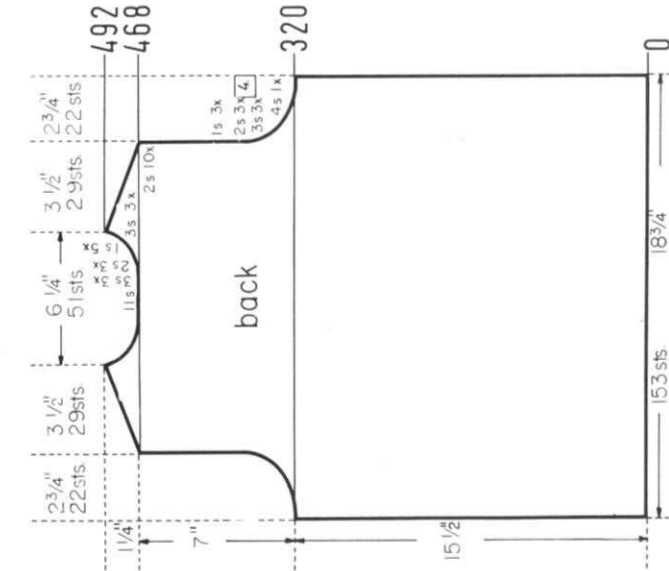

Bring the needles on the left side into working position, knit 1 row in PATTERN to the left side, turn the Row Counter back to 468 and complete the left half. Follow the instructions from *.

* ON CAM BOX SIDE, bind off 2 sts. after Row 468 (EVEN ROWS = SHOULDER SHAPING); 3 sts. after Row 469 (ODD ROWS = NECK SHAPING); 2 sts. after Row 470; 3 sts. after Row 471; 2 sts. after Row 472; 3 sts. after Row 473; 2 sts. after Rows 474, 475, 476, 477, 478, 479, 480; 1 st. after Row 481; 2 sts. after Row 482; 1 st. after Row 483; 2 sts. after Row 484; 1 st. after Row 485; 2 sts. after Row 486; 1 st. after Row 487; 3 sts. after Row 488; 1 st. after Row 489; 3 sts. after Row 490, 492.

ON CAM BOX SIDE, bind off 4 sts. after Rows 320, 321; 3 sts. after Rows 324, 325, 328, 329, 332, 333; 2 sts. after Rows 336, 337, 340, 341, 344, 345; 1 st. after Rows 348, 349, 352, 353, 356, 357, then knit to Row 468, bind off the center 11 sts., put the needles on the left side into holding position and complete the right half first. (While working the right half, bring pattern needles back into working position manually).

ROWS 0 to 320: Knit even.

Cast on 153 sts. with rust and work the Holding Position Design.



Cast on 47 sts. with beige and work 32 rows stockinette st., then bind off all sts. the crochet method.

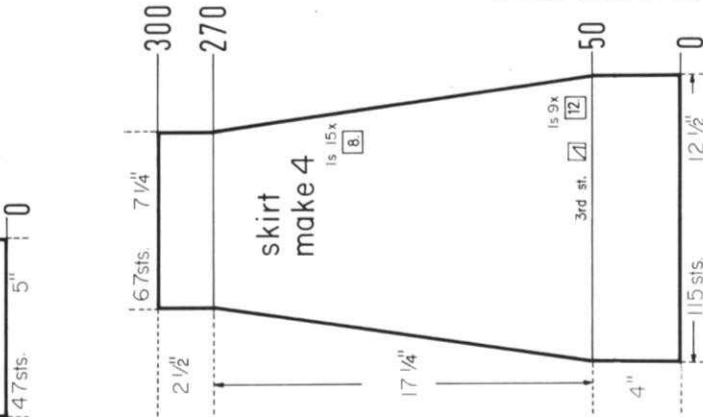

Cast on 151 sts. with beige and work 16 rows stockinette st., then bind off all sts. the crochet method.

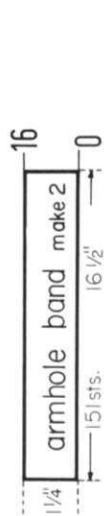

Cast on 166 sts. with beige and work 16 rows stockinette st., then bind off all sts. the crochet method.



Work 3 more sections the same.

ON EACH SIDE, decrease 1 st. after Rows 50, 62, 74, 86, 98, 110, 122, 134, 146, 158, 166, 174, 182, 190, 198, 206, 214, 222, 230, 238, 246, 254, 262, 270, then knit to Row 300 and bind off the remaining 67 sts.

ROWS 0 to 50: Knit even.

Cast on 115 sts. with beige and work stockinette st.

DK 7811

SIZE: 26½–28½ (Bust 49"–51"). **MATERIAL:** SKIRT 17½ oz. (10 balls) blue; BLOUSE 15½ oz. (9 balls) blue, 1½ oz. (1 ball) red and 1½ oz. (1 ball) white KNITTING Subita Crepe 2 x 4, a Zipper and lining for the skirt and a 14" zipper for the back opening of the blouse. **TENSION:** KNITTING 6 to 8. **GAUGE:** 16 sts. 2", 22 rows 2". **PATTERN:** Stockinette Stitch. **CENTER SECTION OF BLOUSE:** Repeated stripes of 6 rows red, 6 rows white and 6 rows blue. The center section of the blouse is knitted sideways. **DECREASES:** After rows indicated, hang the 4th st. on the appropriate sides onto the 3rd st., then move the end sts. inward to fill the empty needle. **INCREASES:** After rows indicated, move the 2 end sts. on each side 1 needle outward, then place the 3rd st. from the row below onto the empty needle. The finished length of the skirt is about 26".

FINISHING: Block all sections to measurements given. **SKIRT:** Weave the sections together, 1 st. in from each edge, leaving an opening on 1 seam for the zipper. Make a narrow hem around the opening. Turn under 22 rows on lower edge and 13 rows on upper edge and hem to wrong side. Insert an elastic band into upper hem. Sew in the zipper, then line the skirt. **BLOUSE:** Sew hem section to center section, then join center section to side sections. Weave back sections together, 1 st. in from each edge, leaving a 14" opening for the zipper. Make a narrow hem around the opening. Join front and back section at sides and shoulders, easing in the fullness at bustline of front section. Turn under 13 rows on lower edge and sleeve edges and hem to wrong side. With right sides together, sew facing to neckline, then turn to wrong side and hem. Sew in the zipper.

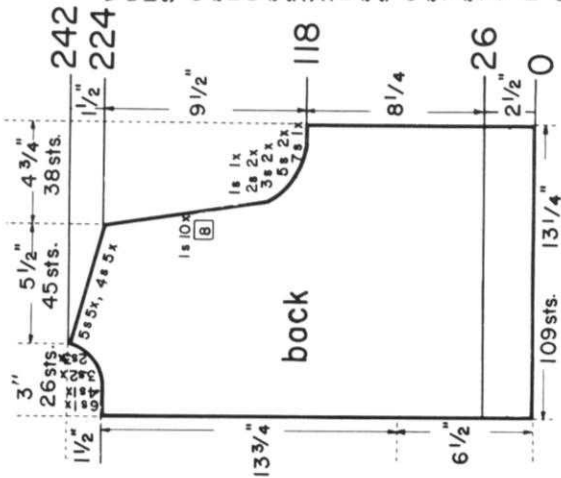
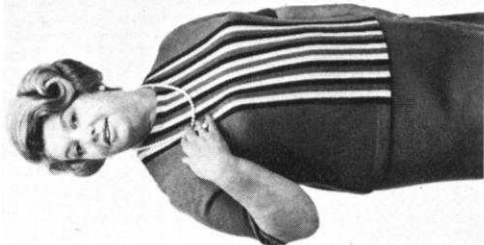

Work the second side section with reverse shapings, casting on from right to left (CAM BOX will be on the LEFT SIDE at Row 0).

ON CAM BOX SIDE, bind off 4 sts. after Rows 268, 270, 272, 274, 276; 5 sts. after Rows 278, 280, 282.

ON CAM BOX SIDE, bind off 7 sts. after Row 162; 5 sts. after Rows 164, 166; 3 sts. after Rows 168, 170; 2 sts. after Rows 172, 174; 1 st. after Rows 176, 178, 186, 194, 202, 210, 218, 226, 234, 242, 250, then knit to Row 268.

For the Bust Dart work Short Rows. ON OPPOSITE SIDE of CAM BOX put into holding position 3 needles after Rows 101, 103, 105, 107, 109, 111, 113, 115, 117, 119, 121, 123; 2 needles after Rows 125, 127, 129, 131, 133, 135. After Row 137 bring all needles back into working position, then knit even to Row 162.

ROWS 0 to 101: Knit even.

Cast on 73 sts. and work stockinette st.

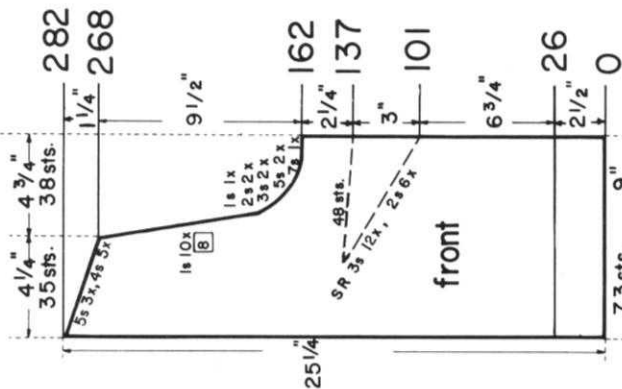

Work 5 more sections the same.

ON EACH SIDE, decrease 1 st. after Rows 74, 88, 102, 116, 130, 144, 158, 172, 186, 200, 214, 228, 242, 256, 270, 282, 294. Now knit even to Row 322, then bind off the remaining 65 sts.

ROWS 0 to 74: Knit even.

Cast on 99 sts. and work stockinette st.

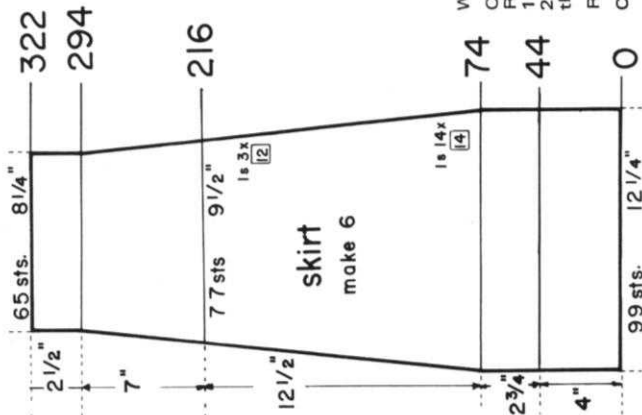

Work the second back section with reverse shapings, casting on from right to left (CAM BOX will be on the LEFT SIDE at Row 0).

ON CAM BOX SIDE, bind off 4 sts. after Row 224 (EVEN ROWS = SHOULDER SHAPING); 6 sts. after Row 225 (ODD ROWS = NECK SHAPING); 4 sts. after Rows 226, 227, 228, 229, 230; 3 sts. after Row 231; 4 sts. after Row 232; 3 sts. after Row 233; 5 sts. after Row 234; 2 sts. after Row 235; 5 sts. after Row 236; 2 sts. after row 237; 5 sts. after Row 238; 2 sts. after Row 239; 5 sts. after Rows 240, 242.

ON CAM BOX SIDE, bind off 7 sts. after Row 118; 5 sts. after Rows 120, 122; 3 sts. after Rows 124, 126; 2 sts. after Rows 128, 130; 1 st. after Rows 132, 134, 142, 150, 158, 166, 174, 182, 190, 198, 206, then knit to Row 224.

ROWS 0 to 118: Knit even.

Cast on 109 sts. and work stockinette st.



Cast on 138 sts. with blue and work 8 rows stockinette st., then bind off all sts. the crochet method.

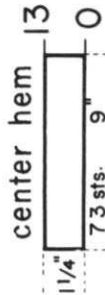

Cast on 73 sts. with blue and work 13 rows stockinette st., then bind off all sts. the crochet method.

ON CAM BOX SIDE, decrease 1 st. after Rows 90, 94, 98. After Row 102 bind off all 194 sts. the crochet method.

ON CAM BOX SIDE, increase 1 st. after Rows 64, 66, 68, 70; 2 sts. after Rows 72, 74; 3 sts. after Rows 76, 78; 4 sts. after Rows 80, 82; 7 sts. after Row 84, then knit to Row 86.

ON CAM BOX SIDE, bind off 7 sts. after Row 16; 4 sts. after Rows 18, 20; 3 sts. after Rows 22, 24; 2 sts. after Rows 26, 28; 1 st. after Rows 30, 32, 34, 36, then knit even to Row 64.

ON CAM BOX SIDE, increase 1 st. after Rows 4, 8, 12, then knit to Row 16.

Cast on 194 sts. with red, work stockinette st. and the striped pattern of 6 rows red, 6 rows white and 6 rows blue.

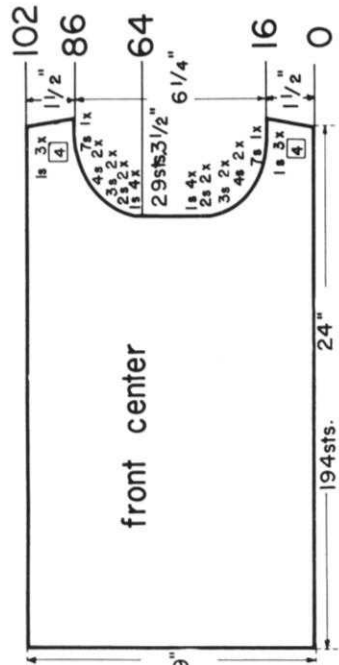

DK 7920

SIZE: 12/14. **MATERIAL:** 8 3/4 oz. (5 balls) KNITTING Linen with Cotton and 3 1/2 oz. (2 balls) red KNITTING Subita Dralon 2 ply. **TENSION:** red KNITTING 3 to 5. **GAUGE:** Pattern Stitch 16 sts. 2", 39 rows 2". **PATTERN:** Holding Position Design according to Line Drawing, or use JAC 40 and Pattern No. 70 but always knit 4 rows of each color instead of 2 rows. The knit side is the right side. **KNITTING** Machines push in the left Retractor Button before knitting each 4th row, then release the Button after the row is completed. When working the right side neck shapings bring the needles back into working position manually. **DECREASES:** After rows indicated, hang the 1st st. on the appropriate sides onto the 2nd st.

FINISHING: Block the sections to measurements given. Leaving 12" open for the slit on both lower side edges, join front and back section at sides and shoulders. Work 2 rows of single crochet around ALL edges, keeping work flat.

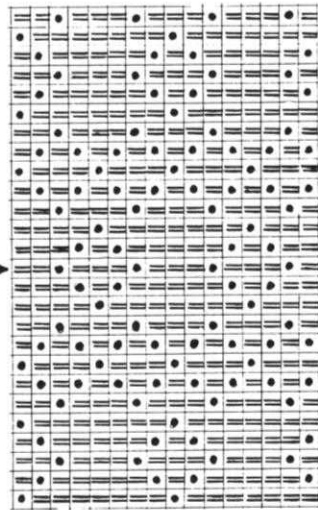

- 61-64 beige
- 57-60 red
- 53-56 beige
- 49-52 red
- 45-48 beige
- 41-44 red
- 37-40 beige
- 33-36 red
- 29-32 beige
- 25-28 red
- 21-24 beige
- 17-20 red
- 13-16 beige
- 9-12 red
- 5-8 beige
- 1-4 red

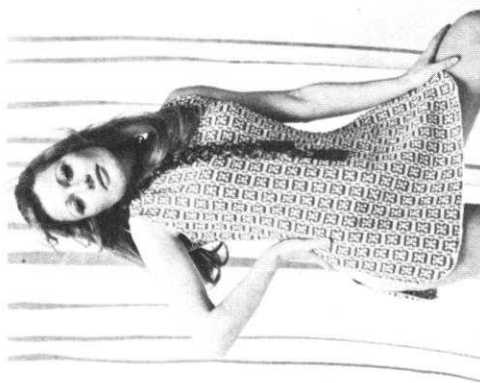

Bring the needles on the left side into working position, knit 1 row in PAT-TURN to the left side, turn the Row Counter back to 538 and complete the left half. Follow the instructions from *.

* Decrease 1 st. ON CAM BOX SIDE after Row 538, then again after rows in (). ON CAM BOX SIDE, bind off 4 sts. after Row 539 (ODD ROWS = NECK SHAPING); 3 sts. after Rows 541, 543; 2 sts. after Rows 545, 547, (548), 549; 1 st. after Rows 551, 553, 555, 557, (558), 559, 561, 565, (568), 569, 573, 577, (578). For SHOULDER, bind off 2 sts. after Rows 594, 596; 3 sts. after Rows 598, 600, 602, 604, 606.

ROWS 531 to 538: Knit even, then bind off the center 13 sts., put the needles on the left side into holding position and complete the right half first.

Work the front section the same as the back section to ROW 530.

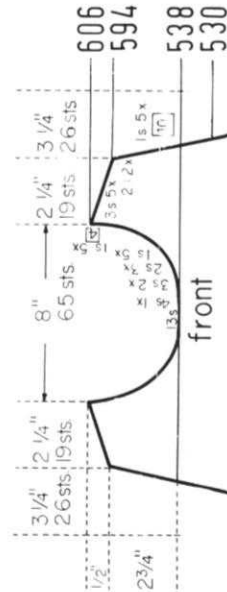

Bring the needles on the left side into working position, knit 1 row in PAT-TURN to the left side, turn the Row Counter back to 538 and complete the left half. Follow the instructions from *.

* Decrease 1 st. ON CAM BOX SIDE after Row 538, then again after rows in (). ON CAM BOX SIDE, bind off 4 sts. after Row 539 (ODD ROWS = NECK SHAPING); 3 sts. after Rows 541, 543; 2 sts. after Rows 545, 547, (548), 549; 1 st. after Rows 551, 553, 555, 557, (558), 559, 561, 565, (568), 569, 573, 577, (578). For SHOULDER, bind off 2 sts. after Rows 594, 596; 3 sts. after Rows 598, 600, 602, 604, 606.

ROWS 531 to 538: Knit even, then bind off the center 13 sts., put the needles on the left side into holding position and complete the right half first.

Work the front section the same as the back section to ROW 530.

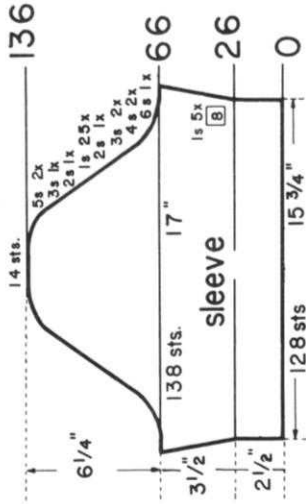

ON CAM BOX SIDE, bind off 6 sts. after Rows 66, 67; 4 sts. after Rows 68, 69, 70, 71; 3 sts. after Rows 72, 73, 74, 75; 2 sts. after Rows 76, 77. ON EACH SIDE, hang the 1st st. onto the 2nd st. after Rows 78, 80, 82, 84, 86, 88, 90, 92, 94, 96, 98, 100, 102, 104, 106, 108, 110, 112, 114, 116, 118, 120, 122, 124, 126. ON CAM BOX SIDE, bind off 2 sts. after Rows 128, 129; 3 sts. after Rows 130, 131; 5 sts. after Rows 132, 133, 134, 135; 14 sts. after Row 136.

ON EACH SIDE, increase 1 st. after Rows 26, 34, 42, 50, 58, then knit to Row 66.

ROWS 0 to 26: Knit even.

Cast on 128 sts. and work stockinette st.

Bring the needles on the left side into working position, knit 1 row in PAT-TURN to the left side, turn the Row Counter back to 562 and complete the left half. Follow the instructions from *.

* Continue to decrease 1 st. ON CAM BOX SIDE after Rows in (). ON CAM BOX SIDE, bind off 3 sts. after Rows 562, 563, 565, 567 (ODD ROWS = NECK SHAPING); (568), 2 sts. after Rows 569, 571, 573; 1 st. after Rows 575, 577, (578), 579, 581, 583, 585, 589, 593; 2 sts. after Rows 594, 596 (EVEN ROWS = SHOULDER SHAPING); 1 st. after Row 597; 3 sts. after Rows 598, 600, 602, 604, 606.

ON CAM BOX SIDE, bind off 4 sts. after Rows 460, 461, 3 sts. after Rows 464, 465, 468, 469; 2 sts. after Rows 472, 473, 476, 477. ON EACH SIDE, decrease 1 st. after Rows 480, 484, 488, 498, 508, 518, 528. (For FRONT SECTION knit to ROW 530) 538, 548, 558, then knit to Row 562, bind off the center 19 sts., put the needles on the left side into holding position and complete the right half first.

ON CAM BOX SIDE, increase 1 st. after Rows 336, 337, 354, 355, 372, 373, 390, 391, 408, 409, 426, 427, 444, 445, then knit to Row 460.

ON EACH SIDE, decrease 1 st. after Rows 78, 104, 130, 156, 182, 208, 234, 258, 282, 306, then knit to Row 336.

ON CAM BOX SIDE, cast on 5 sts. after Rows 2, 3; 4 sts. after Rows 4, 5, 6, 7; 2 sts. after Rows 8, 9, 10, 11, 12, 13, 14, 15; 1 st. after Rows 16, 17, 18, 19, 20, 21, 22, 23, 24, 25, 26, 27, 30, 31, 34, 35, 38, 39, 42, 43, 46, 47, then knit to Row 78.

Cast on 97 sts. with red and work the Holding Position Design.

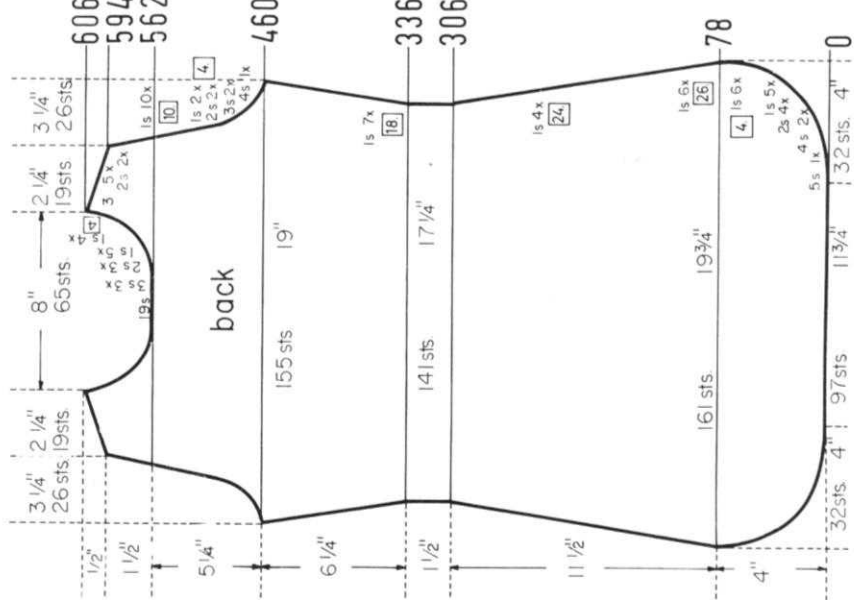

HP 3631

SIZE: 36/38. **MATERIAL:** 17 1/2 oz. (10 balls) light gray = Color 1 and 1 1/2 oz. (1 ball) medium gray = Color 2. **KNITTING:** Crocus Crepe and a 22" Jacket Type Zipper. **TENSION:** KNITTING 6 TO 8. **GAUGE:** 15 sts, 2", 21 rows 2". **PATTERN:** Stockinette Stitch, EDGES: K1, P1. **RIBBING** with Color Stripes as marked in the diagrams. **INCREASES:** After rows indicated, move the 2 end sts. on each side 1 needle outward, then place the 3rd st. from the row below onto the empty needle. When working Short Rows on the Collar, transfer the appropriate ribber sts. to the main machine, then hang the sts. back onto the ribber needles before binding off. **FINISHING:** Block all sections to measurements given. Join back and front sections at sides and shoulders. Sew sleeves together and set in. Turn under 6 sts. on each front edge and hem to wrong side. Sew bound-off edge of collar to neckline. Sew in the zipper.

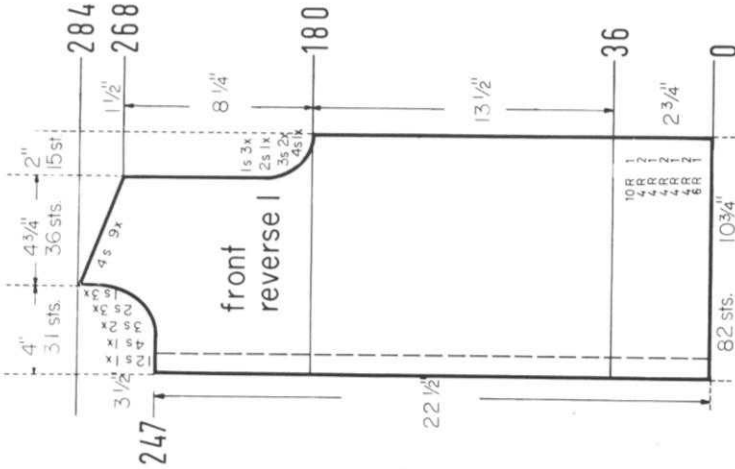

Work the second front section with reverse shapings, casting on from right to left. (Cam Box will be on the LEFT side at Row 0).
ON CAM BOX SIDE (NECK SIDE), bind off 12 sts. after Row 247; 4 sts. after Row 249; 3 sts. after Rows 251, 253; 2 sts. after Rows 255, 257, 259; 1 st. after Rows 261, 263, 265. For SHOULDER bind off 4 sts. after Rows 268, 270, 272, 274, 276, 278, 280, 282, 284.

ON CAM BOX SIDE, bind off 4 sts. after Row 180; 3 sts. after Rows 182, 184; 3 sts. after Row 186; 1 st. after Rows 188, 190, 192, then knit to Row 247.

ROWS 37 to 180: Knit even.
ROWS 0 to 36: Knit even then change to stockinette st.

Cast on 82 sts. with light gray work K1, P1. Ribbing and the color stripes as marked in the diagram.

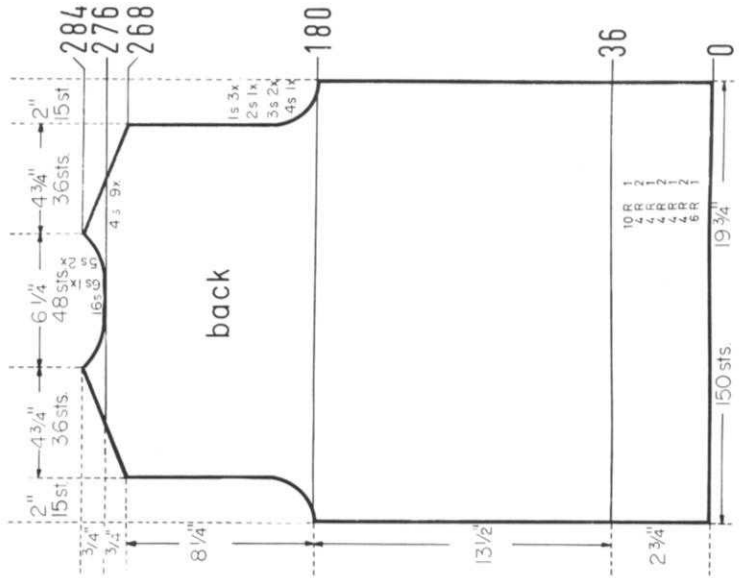

Move the Cam Box to the left side, turn the Row Counter back to 276 and complete the left half. Follow the instructions from *.

* ON CAM BOX SIDE, bind off 4 sts. after Row 276 (EVEN ROWS = SHOULDER SHAPING); 6 sts. after Row 277 (ODD ROWS = NECK SHAPING); 4 sts. after Row 278, 5 sts. after Row 279; 4 sts. after Row 280; 5 sts. after Row 281; 4 sts. after Rows 282, 284.

ON CAM BOX SIDE, bind off 4 sts. after Rows 268, 269, 270, 271, 272, 273, 274, 275, then knit to Row 276, bind off the center 16 sts., put the needles on the left side into holding position and complete the right half first.

ON CAM BOX SIDE, bind off 4 sts. after Rows 180, 181; 3 sts. after Rows 182, 183, 184, 185; 2 sts. after Rows 186, 187; 1 st. after Rows 188, 189, 190, 191, 192, 193, then knit to Row 268.

ROWS 37 to 180: Knit even.
ROWS 0 to 36: Knit even, then change to stockinette st.

Cast on 150 sts. with light gray, work K1, P1. Ribbing and the color stripes as marked in the diagram.

ON OPPOSITE SIDE of CAM BOX put into holding position 2 needles after Rows 4, 5, 6, 7, 8, 9; 4 needles after Rows 10, 11, 12, 13, 14, 15, 16, 17, 18, 19. After Row 20 break the yarn, bring all needles back into working position and with new strand of yarn bind off all sts. the crochet method for ribbing.
ROWS 0 to 4: Knit even.

Cast on 163 sts. with light gray, work K1, P1. Ribbing and the color stripes as marked in the diagram.

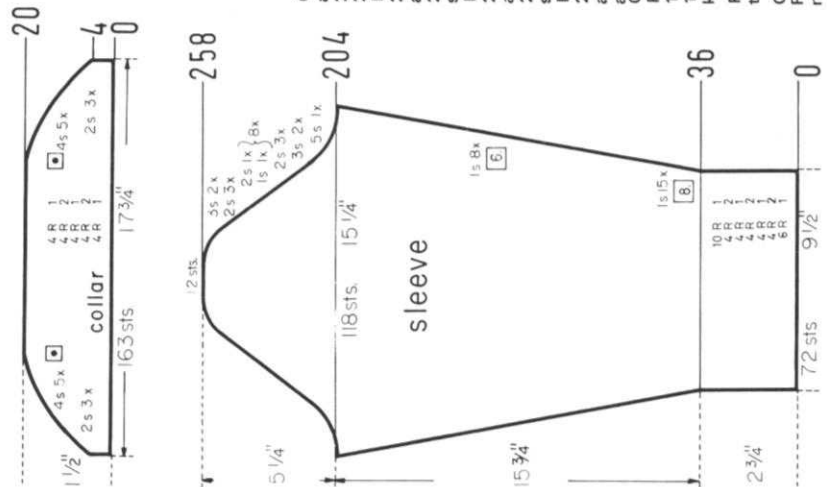

ON CAM BOX SIDE, bind off 5 sts. after Rows 204, 205; 3 sts. after Rows 206, 207, 208, 209; 2 sts. after Rows 210, 211, 212, 213, 214, 215; 1 st. after Rows 216, 217; 2 sts. after Rows 218, 219; 1 st. after Rows 220, 221; 2 sts. after Rows 222, 223; 1 st. after Rows 224, 225; 2 sts. after Rows 226, 227; 1 st. after Rows 228, 229; 2 sts. after Rows 230, 231; 1 st. after Rows 232, 233; 2 sts. after Rows 234, 235; 1 st. after Rows 236, 237; 2 sts. after Rows 238, 239; 1 st. after Rows 240, 241; 2 sts. after Rows 242, 243; 1 st. after Rows 244, 245; 2 sts. after Rows 246, 247, 248, 249, 250, 251, 252, 253; 3 sts. after Rows 254, 255, 256, 257; 12 sts. after Row 258.
ON EACH SIDE, increase 1 st. after Rows 36, 44, 52, 60, 68, 76, 84, 92, 100, 108, 116, 124, 132, 140, 148, 156, 162, 168, 174, 180, 186, 192, 198, then knit to Row 204.

ROWS 0 to 36: Knit even, then change to stockinette st.
Cast on 72 sts. with light gray, work K1, P1. Ribbing and the color stripes as marked in the diagram.

KK 5268

SIZE: 8-10 (Chest 26"-28"). **MATERIAL:** 10½ oz. (6 balls) light gray = Color 1 and 1¼ oz. (1 ball) medium gray = Color 2 **KNITTING** Crocus Crepe and a 16" Jacket Type Zipper. **TENSION:** KNIT-KING 6 to 8. **GAUGE:** 15 sts. 2", 21 rows 2". **PATTERN:** Stockinette Stitch. **EDGES:** K1, P1, Ribbing with Color Stripes as marked in the diagrams. **INCREASES:** After rows indicated, move the 2nd st. on each side 1 needle outward, then place the 3rd st. from the row below onto the empty needle. When working Short Rows on the collar, transfer the appropriate ribber sts. to the main machine, then hang the sts. back onto the ribber before binding off.

FINISHING: Block all sections to measurements given. Join back and front sections at sides and shoulders. Sew the sleeves together and set in. Turn under 6 sts. on each front edge and hem to wrong side. Sew bound-off edge of collar to neckline. Sew in the zipper.

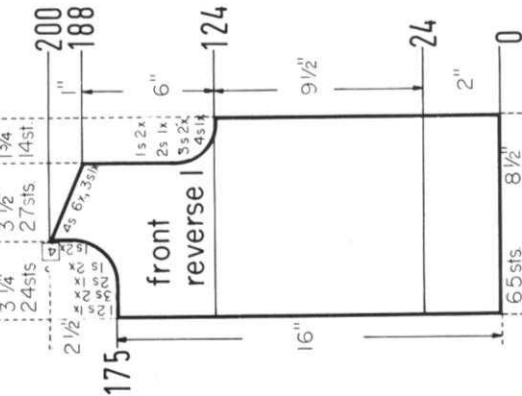

Work the second front section with reverse shapings, casting on from right to left. (Cam Box will be on the LEFT side at Row 0).

ON CAM BOX SIDE (NECK SIDE), bind off 12 sts. after Row 175; 3 sts. after Rows 177, 179; 2 sts. after Row 181; 1 st. after Rows 183, 185, 187; 3 sts. after Row 188 (EVEN ROWS = SHOULDER SHAPING); 4 sts. after Row 190; 1 st. after Row 191 (Last time for Neck); 4 sts. after Rows 192, 194, 196, 198, 200.

ON CAM BOX SIDE, bind off 4 sts. after Row 124; 3 sts. after Rows 126, 128; 2 sts. after Row 130; 1 st. after Rows 132, 134, then knit to Row 175. **ROWS 25 to 124:** Knit even.

ROWS 0 to 24: Knit even, then change to stockinette st.

Cast on 65 sts. with light gray, work K1, P1, Ribbing and the color stripes as marked in the diagram of the back section.

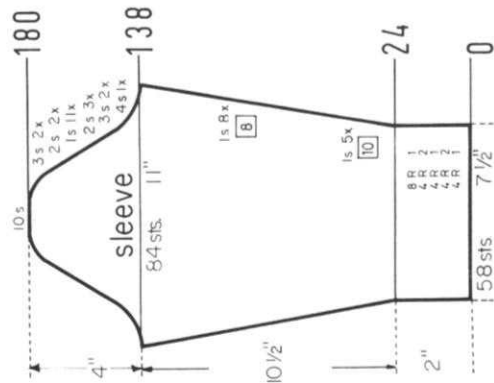

ON CAM BOX SIDE, bind off 4 sts. after Rows 138, 139; 3 sts. after Rows 140, 141, 142, 143; 2 sts. after Rows 144, 145, 146, 147, 148, 149. **ON EACH SIDE,** hang the 1st st. onto the 2nd st. after Rows 150, 152, 154, 156, 158, 160, 162, 164, 166, 168, 170. **ON CAM BOX SIDE,** bind off 2 sts. after Rows 172, 173, 174, 175; 3 sts. after Rows 176, 177, 178, 179; 10 sts. after Row 180.

ON EACH SIDE, increase 1 st. after Rows 24, 34, 44, 54, 64, 74, 82, 90, 98, 106, 114, 122, 130, then knit to Row 138.

ROWS 0 to 24: Knit even, then change to stockinette st.

Cast on 58 sts. with light gray, work K1, P1, Ribbing and the color stripes as marked in the diagram.

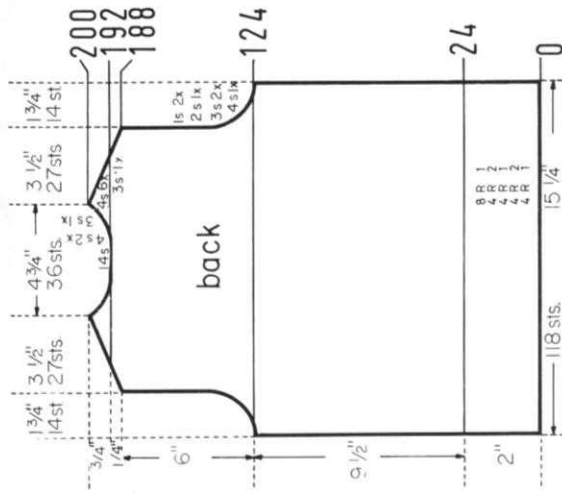

ON OPPOSITE SIDE of CAM BOX put into holding position 2 needles after Rows 4, 5, 6, 7; 4 needles after Rows 8, 9, 10, 11, 12, 13. After Row 14 break the yarn, bring all needles back into working position and with new strand of yarn bind off all sts. the crochet method for ribbing.

ROWS 0 to 4: Knit even.

Cast on 115 sts. with light gray, work K1, P1, Ribbing and the color stripes as marked in the diagram.

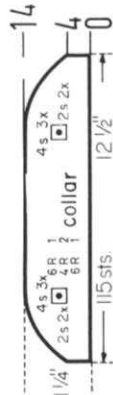

for fast easy knitting of Jaquard and Ski-sweater designs

Patterns are selected—row by row—through a pre-stamped card that is fed into the Jac.

There are over 140 cards available and illustrations of them are included with each Jac.

Jac 40's are made for most brands of machines. When ordering be sure to specify your brand of knitter as needle spacings vary. Simple to use and an essential tool for the modern knitter, Jac 40's are \$24.95 complete with 3 cards for practicing the 3 techniques, plus complete instructions.

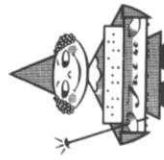

Order from your dealer or direct from

KNITKING

1128 Crenshaw Boulevard, Los Angeles, Calif. 90019

Shipping Cost \$1.50—California residents add 5% sales tax.



HP 3629



SIZE: 38/40. **MATERIAL:** 15 3/4 oz. (9 balls) beige = Color 1 and small amounts of brown = Color 2 and tan = Color 3 **KNITTING** Crocus Crepe. **TENSION:** KNITTING 5 to 7; GAUGE: 16 sts, 2", 23 rows 2". **PATTERN:** Stockinette Stitch, EDGES: K1, P1, Ribbing with Color Stripes as marked in the diagrams. **SLEEVE INCREASES:** After rows indicated, move the 2 end sts. on each side 1 needle outward, then place the 3rd st. from the row below onto the empty needle.

FINISHING: Block all sections to measurements given. Join front and back section at sides and shoulders. Sew sleeves together and set in. Sew pocket in place. Join short ends of neckband, then sew band to neckline.

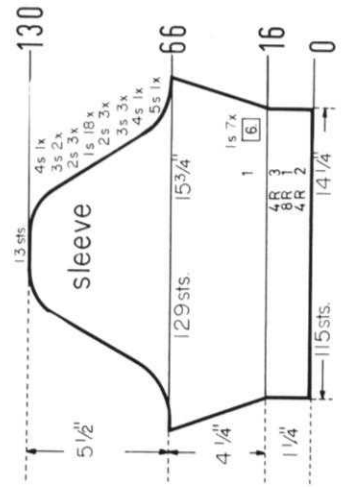
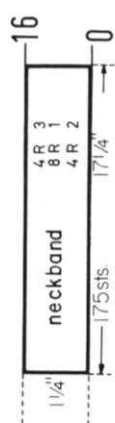

Cast on 175 sts. with brown, work K1, P1, Ribbing and the color stripes as marked in the diagram. After Row 16 bind off all sts. the crochet method for ribbing.

ON CAM BOX SIDE, bind off 5 sts. after Rows 66, 67; 4 sts. after Rows 68, 69; 3 sts. after Rows 70, 71, 72, 73, 74, 75; 2 sts. after Rows 76, 77, 78, 79, 80, 81. **ON EACH SIDE,** hang the 1st st. onto the 2nd st. after Rows 82, 84, 86, 88, 90, 92, 94, 96, 98, 100, 102, 104, 106, 108, 110, 112, 114, 116. **ON CAM BOX SIDE,** bind off 2 sts. after Rows 118, 119, 120, 121, 122, 123; 3 sts. after Rows 124, 125, 126, 127; 4 sts. after Rows 128, 129; 13 sts. after Row 130.

ON EACH SIDE, increase 1 st. after Rows 16, 22, 28, 34, 40, 46, 52, then knit to Row 66.

ROWS 0 to 16: Knit even, then change to stockinette st. and continue with beige.

Cast on 115 sts. with brown, work K1, P1, Ribbing and the color stripes as marked in the diagram.

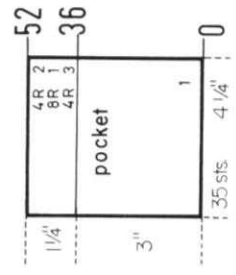
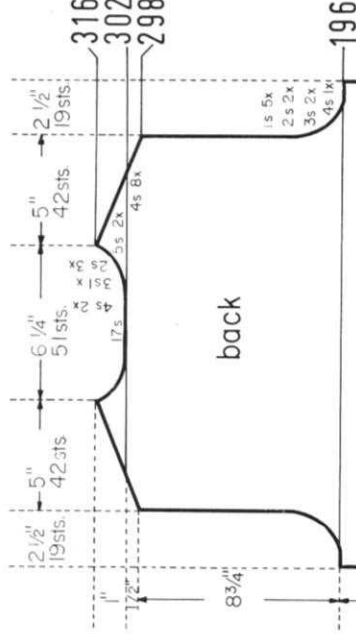
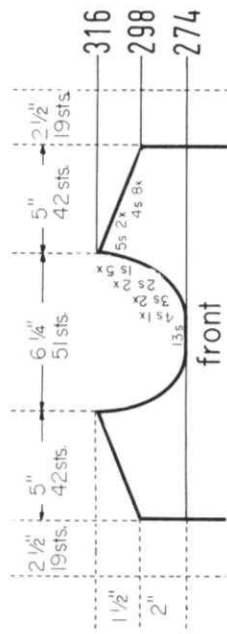

Cast on 35 sts. with beige and work stockinette st. After Row 36 transfer every other st. to the ribber, work K1, P1, ribbing and the color stripes as marked in the diagram. After Row 52 bind off all sts. the crochet method for ribbing.

Move the Cam Box to the left side, turn the Row Counter back to 274 and complete the left half. Follow the instructions from *.

* **ON CAM BOX SIDE,** bind off 4 sts. after Row 275 (ODD ROWS = NECK SHAPING); 3 sts. after Rows 277, 279; 2 sts. after Rows 281, 283; 1 st. after Rows 285, 287, 289, 291, 293. For **SHOULDER** bind off 4 sts. after Rows 298, 300, 302, 304, 306, 308, 310, 312; 5 sts. after Rows 314, 316.

Work the front section the same as the back section to Row 274, then bind off the center 13 sts., put the needles on the left side into holding position and complete the right half first.

Move the Cam Box to the left side, turn the Row Counter back to 302 and complete the left half. Follow the instructions from *.

* **ON CAM BOX SIDE,** bind off 4 sts. after Rows 302 (EVEN ROWS = SHOULDER SHAPING), 303 (ODD ROWS = NECK SHAPING), 304, 305, 306; 3 sts. after Row 307; 4 sts. after Row 308; 2 sts. after Row 309; 4 sts. after Row 310; 2 sts. after Row 311; 4 sts. after Row 312; 2 sts. after Row 313; 5 sts. after Rows 314, 316.

ON CAM BOX SIDE, bind off 4 sts. after Rows 298, 299, 300, 301, then knit to Row 302, bind off the center 17 sts., put the needles on the left side into holding position and complete the right half first.

ON CAM BOX SIDE, bind off 4 sts. after Rows 196, 197; 3 sts. after Rows 198, 199, 200, 201; 2 sts. after Rows 202, 203, 204, 205; 1 st. after Rows 206, 207, 208, 209, 210, 211, 212, 213, 214, 215, then knit to Row 298. (For the **FRONT SECTION** knit to Row 274).

ROWS 21 to 196: Knit even.

ROWS 0 to 20: Knit even, then change to stockinette st.

Cast on 173 sts. with beige and work K1, P1, Ribbing.

MK 5270

SIZE: 7-8 (Chest 25"-26"), **MATERIAL:** 10 1/2 oz. (6 balls) yellow = Color 1, 1 3/4 oz. (1 ball) white = Color 2, 1 1/4 oz. (1 ball) dark blue = Color 3 and 1 1/4 oz. (1 ball) turquoise = Color 4 **KNITTING** Subita Dralon 3 ply, **TENSION:** KNITTING 5 to 7. **GAUGE:** 16 sts, 2", 23 rows 2". **PATTERN:** TUNIC: Stockinette Stitch, worn on the purl side; **BATHING SUIT:** Stockinette st. with repeated Color Stripes as marked in the diagrams, worn on the knit side. **BANDS** and **POCKET EDGE:** K1, P1, Ribbing. **DECREASES:** After rows indicated, hang the 3rd st. on each side onto the 2nd st. then move the end sts. inward to fill the empty needle. Bind off the ribbed edges the crochet method for ribbing.

FINISHING: Block all sections to measurements given. (DO NOT PRESS). **TUNIC:** Join front and back section at sides and shoulders. Join short ends of neckband and armhole bands. Sew 1 edge of neckband to inside and 1 edge to outside of neckline. Sew armhole bands to armholes in the same manner. Sew pocket in place. Knot fringe into lower edge. (See picture). **SHORTS:** Join front and back section at sides. Weave the open sts. together. Remove waste yarn. Turn under 9 rows on upper edge and hem to wrong side. Insert an elastic band. Join short ends of leg bands, then sew 1 edge of leg band to inside and 1 edge to outside of leg edges. **TOP:** Join front and back section at sides and shoulders. Turn under 9 rows on lower edge and hem to wrong side. Join short ends of neckband and armhole bands. Sew 1 edge of neckband to inside and 1 edge to outside of neckline. Sew armhole bands to armholes in the same manner.

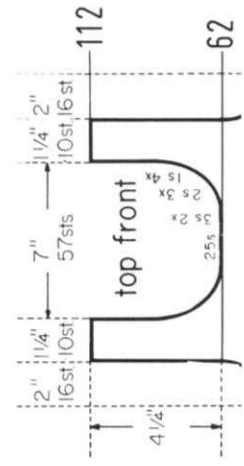
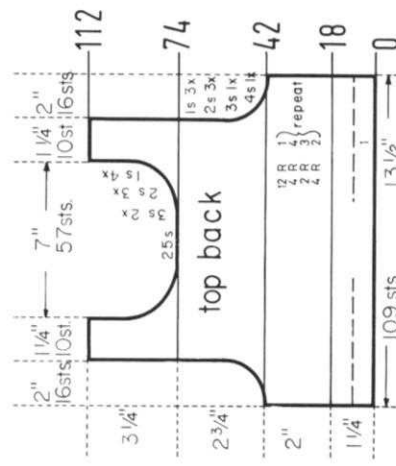

Move the Cam Box to the left side, turn the Row Counter back to 202 and complete the left half. Follow the instructions from *.

* ON CAM BOX SIDE, bind off 3 sts. after Row 203 (ODD ROWS = NECK SHAPING); 2 sts. after Rows 205, 207, 209; 1 st. after Rows 211, 213, 215, 217. For SHOULDER bind off 5 sts. after Rows 244, 246; 6 sts. after Row 248.

Work the front section the same as the back section to ROW 202, then bind off the center 24 sts., put the needles on the left side into holding position and complete the right half first.

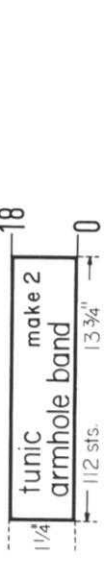
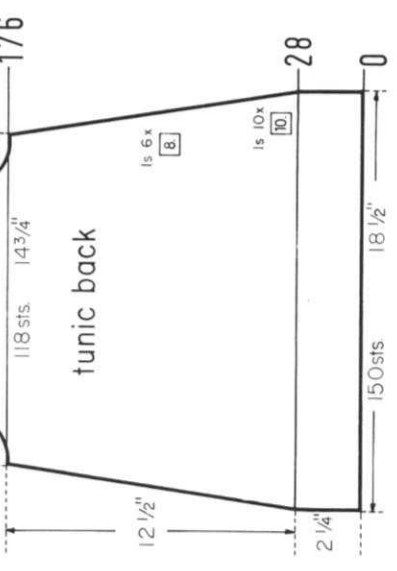
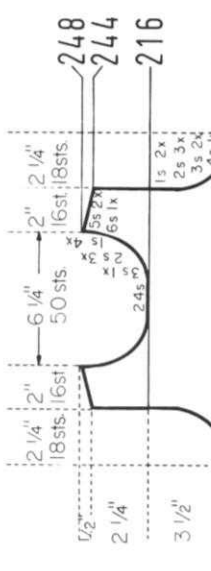
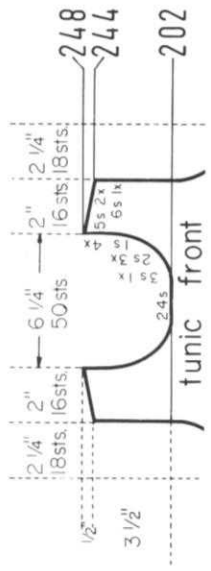

Cast on 112 sts. with yellow and work 18 rows K1, P1, Ribbing, then bind off all sts.

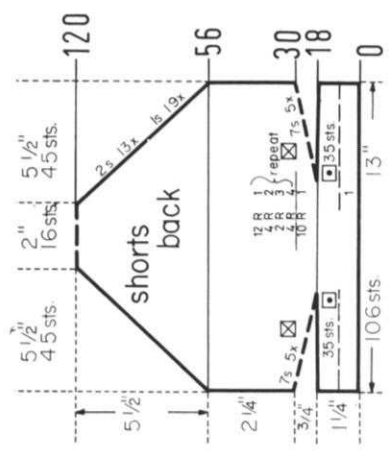

Move the Cam Box to the left side, turn the Row Counter back to 216 and complete the left half. Follow the instructions from *.

* ON CAM BOX SIDE, bind off 3 sts. after Row 217 (ODD ROWS = NECK SHAPING); 2 sts. after Rows 219, 221, 223; 1 st. after Rows 225, 227, 229, 231. For SHOULDER bind off 5 sts. after Rows 244, 246; 6 sts. after Row 248.

ON CAM BOX SIDE, bind off 4 sts. after Rows 176, 177; 3 sts. after Rows 178, 179, 180, 181; 2 sts. after Rows 182, 183, 184, 185, 186, 187; 1 st. after Rows 188, 189, 190, 191, then knit to Row 216, bind off the center 24 sts., put the needles on the left side into holding position and complete the right half first. (For FRONT SECTION knit to Row 202).

ON EACH SIDE, decrease 1 st. after Rows 28, 38, 48, 58, 68, 78, 88, 98, 108, 118, 128, 136, 144, 152, 160, 168, then knit to Row 176.

Cast on 150 sts. with yellow and work stockinette st.

ON EACH SIDE, hang the 1st st. onto the 2nd st. after Rows 56, 58, 60, 62, 64, 66, 68, 70, 72, 74, 76, 78, 80, 82, 84, 86, 88, 90, 92. ON CAM BOX SIDE, bind off 2 sts. after Rows 94, 95, 96, 97, 98, 99, 100, 101, 102, 103, 104, 105, 106, 107, 108, 109, 110, 111, 112, 113, 114, 115, 116, 117, 118, 119, then knit to Row 120, knit several rows with contrast waste yarn, then remove work from the machine. (Knit 1 row without yarn).

Work Short Rows. ON OPPOSITE SIDE of CAM BOX put into holding position 35 needles after Rows 18, 19. ON OPPOSITE SIDE of CAM BOX bring back into working position 7 needles after Rows 20, 21, 22, 23, 24, 25, 27, 28, 29, then knit over all needles to Row 56.

ROWS 0 to 18: Knit even, then change to stockinette st. and work the repeated color stripes as marked in the diagram. Cast on 106 sts. with yellow and work K1, P1, Ribbing.

SIZE: 6 (Chest 24"-25"). **MATERIAL:** 12 1/4 oz. (7 balls) white = Color 1, 1 1/2 oz. (1 ball) red = Color 2 and 1 1/2 oz. (1 ball) blue = Color 3 **KNITTING** Crocus Crepe. **TENSION:** KNITTING 6 to 8. **GAUGE:** 16 sts., 2 1/4". 21 rows 2", PAT-TERN: Stockinette Stitch with Color Stripes as marked in the diagrams. **EDGES:** K1, P1, Ribbing. **INCREASES:** After rows indicated, move the 2 end sts. on the appropriate sides 1 needle outward, then place the 3rd st. from the row below onto the empty needle. **DECREASES:** After rows indicated, hang the 3rd st. on the appropriate sides onto the 2nd st., then move the end sts. inward to fill the empty needle.

FINISHING: Block all sections to measurements given. **PULLOVER:** Join front and back section at sides and shoulders, leaving the left shoulder open for 2". Turn under a small amount around the opening and hem to wrong side. Sew neckband to neckline. Make 5 loops on one side and sew 5 buttons to other side of opening. Sew sleeves together and set in. Turn under 13 rows on lower edge and hem to wrong side. Turn under 8 rows on upper edge of pocket and hem to wrong side. Sew pocket in place. (See picture). **PANTS:** Join front and back sections at sides. Close leg seams, then join sections at center back and center front. Turn under 13 rows on leg edges and 8 rows on upper edge and hem to wrong side. Insert an elastic band into upper hem.

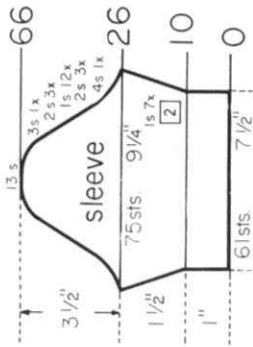
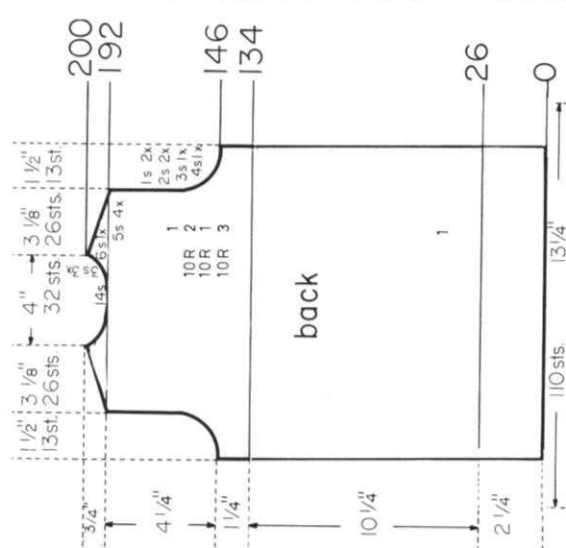
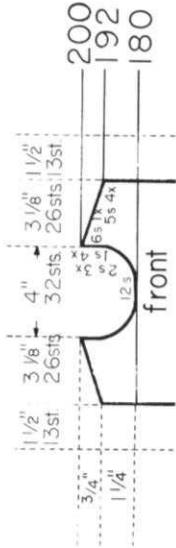

Move the Cam Box to the left side, turn the Row Counter back to 180 and complete the left half. Follow the instructions from *.

* ON CAM BOX SIDE, bind off 2 sts. after Rows 181, 183, 185 (ODD ROWS = NECK SHAPING); 1 st. after Rows 187, 189, 191; 5 sts. after Row 192 (EVEN ROWS = SHOULDER SHAPING); 1 st. after Row 193; 5 sts. after Row 194, 196, 198; 6 sts. after Row 200.

Work the front section the same as the back section to Row 180, then bind off the center 12 sts., put the needles on the left side into holding position and complete the right half first.

Move the Cam Box to the left side, turn the Row Counter back to 192 and complete the left half. Follow the instructions from *.

* ON CAM BOX SIDE, bind off 5 sts. after Row 192 (EVEN ROWS = SHOULDER SHAPING); 3 sts. after Row 193 (ODD ROWS = NECK SHAPING); 5 sts. after Row 194; 3 sts. after Row 195; 5 sts. after Row 196; 3 sts. after Row 197; 5 sts. after Row 198; 6 sts. after Row 200.

ON CAM BOX SIDE, bind off 4 sts. after Rows 146, 147; 3 sts. after Rows 148, 149; 2 sts. after Rows 150, 151, 152, 153; 1 st. after Rows 154, 155, 156, 157, then knit to Row 192, bind off the center 14 sts., put the needles on the left side into holding position and complete the right half first. (For the FRONT SECTION knit to Row 180).

ROWS 135 to 146: Knit even.

ROWS 0 to 134: Knit even, then change to blue and work the color stripes as marked in the diagram.

Cast on 110 sts. with white and work stockinette st.

ON CAM BOX SIDE, bind off 4 sts. after Rows 26, 27; 2 sts. after Rows 28, 29, 30, 31, 32, 33. ON EACH SIDE, hang the 1st st. onto the 2nd st. after Rows 34, 36, 38, 40, 42, 44, 46, 48, 50, 52, 54, 56. ON CAM BOX SIDE, bind off 2 sts. after Rows 58, 59, 60, 61, 62, 63; 3 sts. after Rows 64, 65; 13 sts. after Row 66.

ON EACH SIDE, increase 1 st. after Rows 10, 12, 14, 16, 18, 20, 22, then knit to Row 26.

ROWS 0 to 10: Knit even, then change to stockinette st.

Cast on 61 sts. with white and work K1, P1, Ribbing.

Work the second front section with reverse shapings, casting on from right to left. (Cam Box will be on the LEFT side at Row 0).

ON OPPOSITE SIDE of CAM BOX put into holding position 22 needles after Row 114; 16 needles after Row 116. After Row 118 bring all needles back into working position, then knit to Row 134 and bind off the remaining 54 sts.

ON CAM BOX SIDE (SIDE SEAM), decrease 1 st. after Rows 88, 96, 104, 112, then knit to Row 114.

Continue to increase 1 st. ON CAM BOX SIDE (SIDE SEAM), after Rows in (). ON CAM BOX SIDE, bind off 2 sts. after Rows 49, (50), 51, 53; 1 st. after Rows 55, 57, (58), 59, 61, (66), 67, 73, 79, 85, then knit to Row 88.

ON CAM BOX SIDE (SIDE SEAM), increase 1 st. after Rows in (). ON OPPOSITE SIDE of CAM BOX (INNER SEAM), increase 1 st. after Rows 26, 30, 34, (34), 38, 42, (42), 46, then knit to Row 49.

ROWS 0 to 26: Knit even.
Cast on 61 sts. and work stockinette st.

Work the second back section with reverse shapings, casting on from right to left. (Cam Box will be on the LEFT side at Row 0).

ON OPPOSITE SIDE of CAM BOX put into holding position 9 needles after Row 120; (120), 7 needles after Rows 122, 124, 126, 128, (128), 130. After Row 132 bring all needles back into working position, then knit to Row 146 and bind off the remaining 51 sts.

Continue to increase 1 st. ON OPPOSITE SIDE of CAM BOX (SIDE SEAM), after Rows in (). ON CAM BOX SIDE, bind off 2 sts. after Rows 48, 50, 52, (52), 54, 56, 58, (58), 60, 62; 1 st. after Rows 64, (64), 66, 68, 70, (70), 72, (76), 80, (82). Last increase 88, 96, 104, 112, then continue to decrease 1 st. ON CAM BOX SIDE after Rows in (). Knit to Row 120.

ON OPPOSITE SIDE of CAM BOX (SIDE SEAM) increase 1 st. after Rows in (). ON CAM BOX SIDE (INNER SEAM) increase 1 st. after Rows 26, 30, 34, (34), 38, (40), 42, 46, (46), then knit to Row 56.

ROWS 0 to 26: Knit even.
Cast on 64 sts. and work stockinette st.

KG 1924



MATERIAL: 3½ oz. (2 balls) for single color tie — KNOTTING Amore. If you want stripes, you will need 1 ball of each color. The photographed Tie was knitted with 1 ball each of Red, White and Blue. Small amount of light weight wash and wear fabric to line the ends of tie and the interlining from an old tie (optional). **TENSION:** KNOTTING 2 or 3. **GAUGE:** 19 sts., 28 rows 2".

FINISHING: Pull up the cast-on edge. Use the wet method for blocking the tie (do not use iron) to measurements given being sure to keep it on the bias as knitted. Cut a lining for each end of tie (on the bias). If you use the interlining from an old tie, on the wrong side, sew one edge of tie down center of interlining with big basting stitches (as in the old tie). With right sides together, pin lining, then sew 1/4" in around the points. Turn lining to inside. Fold edges of tie together down center back (right side facing each other), pin then blind stitch edges together using nylon thread. It is a good idea to work on a table or flat surface so that you do not stretch or pull up the edges... they must be very flat and neat. Cut a cardboard in the shape of each end and long enough to extend inside the tie approximately 20" for the big end and 12" for the small end. Cover cardboard with Saran wrap, then insert inside of tie. Be sure seam is centered on the back side. Wet block by placing tie between a folded wet bath towel (put a sheet of plastic underneath so your board won't get wet), and press with your hands until tie is damp. Remove towel and allow tie to dry flat.



KG 1925

SIZE: 21" to 23" head size. **MATERIAL:** 5½ oz. (3 balls) KNOTTING Excelsior (8¾ oz. [5 balls] will make 2 hats). **TENSION:** KNOTTING 5 to 7 stockinette st. and 7 to 9 Fisherman's Rib and Pattern stitch. **GAUGE:** Stockinette st. 14 sts., 22 rows 2".

FINISHING: Make a paper pattern for the brim following the measurements shown on diagram and be sure to mark the center. Cut the brim from a piece of flexible plastic transferring the center marking. (You can use a bleach bottle for the brim — cut the top and bottom off the bottle and flatten it by placing a wet cloth over the plastic and press with hot iron.) Protect your ironing board with piece of old sheeting because any printing on bottle will come off on board. Make holes along the inner curve of brim. You can do this by inserting a large needle into a cork, hold the needle over flame on stove and when red hot, put it into the plastic. Make the holes about 1/2 inch apart. Slide the brim in between the ribbing, matching center markings and pull into shape. Pin the doubled ribbing in place, then open it up enough to sew the brim to the inside top of ribbing. Pin the doubled ribbing together and back stitch across the top through both thicknesses (inside curve). Weave the long back seam from the right side, then fold the lining to the inside. Pull up the cast-on edge and the sts. taken off on yarn and tack the two securely together. Trim in any way you wish. If necessary, you can run elastic through the back ribbing.

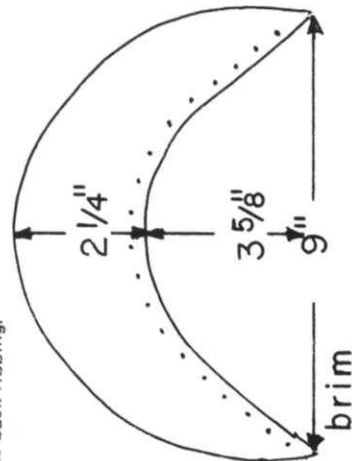

PATTERN: IMPORTANT... The tie is knitted in stockinette stitch on the BIAS. To make a true bias, you must INCREASE on the RIGHT side and DECREASE on the LEFT side. The bias begins at Row 92 and stops at Row 492. Work the bias as follows: When Counter reads 92, * hang the left end stitch onto the neighboring needle to the right and cast on 1 st. on the right side by bringing a new needle into holding position, cast on over the needle shank (do not bring the yarn under the sinker), then put the needle into working position. Knit 2 rows and REPEAT from *. This means that every time your Cam Box is on the right side, you will decrease 1 st. on the left side and increase 1 st. on the right side until Row 492 when the bias stops. At the SAME TIME, you will be shaping the tie, by decreasing (or increasing) 3 sts. in on each side. For decreasing, take your 3 needle transfer tool and pick up the 3 end sts. on one side and move them over 1 st. in (hanging the 3rd st. on the 4th needle). Do the same on the other side. When increasing, move the 3 end sts. out and pick up a stitch from the row below. Always make your de-

crease or increase FIRST, then make the bias. Your knitting will move over to the right end of your machine so that when you have used up most of the needles on the machine, you must then take the knitting off onto contrast waste yarn and hang the sts. back onto the needles on the extreme left.

To the extreme left of the machine, cast on 63 sts. Knit 2 rows. Increase 1 st. on the right side only, after Row 2 and again every 4th row 19 times more and every 2nd row 4 times. After Row 92, begin the bias. At the SAME TIME, decrease 1 st. ON EACH SIDE after Row 94 and every 8th row 21 times more and every 6th row 2 times, then continue bias ONLY until Counter reads 450. After Row 450, increase 1 st. ON EACH SIDE and again every 10th row 4 times more. After Row 492, stop the bias and on the left side only, decrease 1 st. and again every 6th row 3 times more and every 4th row 8 times. After Row 548, bind off 37 sts. the crochet method.

To make the Red, White and Blue Tie, * knit 30 rows Blue, 4 rows Red, 2 rows White, 4 rows Red, then REPEAT from *.

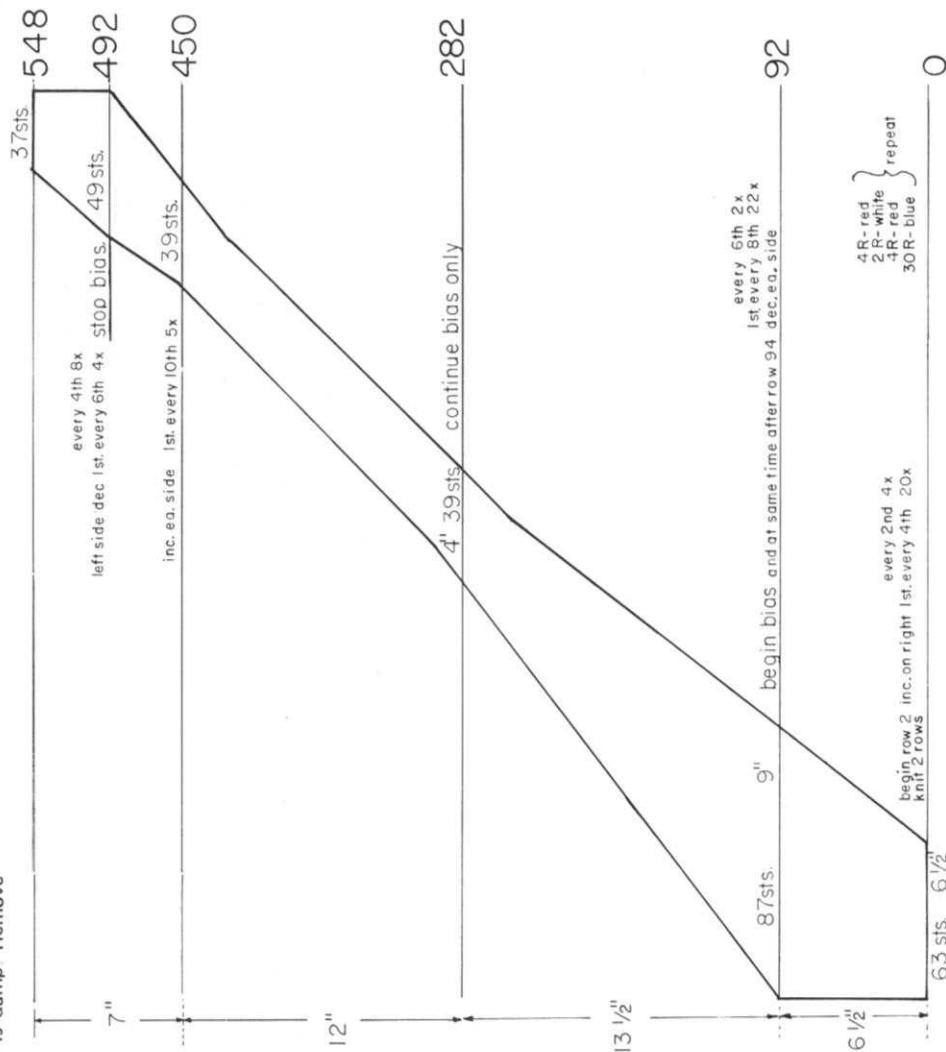

Use the open cast-on method (See KNOTTING Practical Knitting Hints book page 12. Tension 6. Cast on 141 sts. Rows 1-72: Knit even in stockinette st. Change to tension 8 and attach Ribber, then transfer every other st. to the Ribber. Put the Gate Cam Release Lever of the knitter and the ribber to the needle heels. Rows 73-152: Knit in Fisherman's Rib then return the Gate Cam Release Levers to the needle heads. Transfer the rib stitches to main machine and remove ribber. Mark the center needle by hanging a small piece of contrast yarn onto it. Knit 1 row to the LEFT side, then set up the Pattern as follows: Push every 6th needle into holding position. Transfer 1 st. on each side of these needles to the neighboring needles and push the empty needles out of work. Return the needles in holding position to working position. Knit 1 row to the right side. Rows 155-224: * Put every single needle into holding position and knit 4 rows. Return needles to working position and knit 2 rows. REPEAT from * to Row 224. After Row 224, break yarn leaving a long end. Thread tapestry needle with end of yarn and remove the sts. one at a time onto yarn.

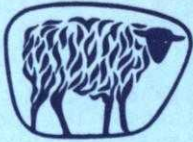

KNITTING NEWS

May/June, 1971

OUR READERS WRITE

"I do not like to sew a seam in the shoulders of my knits... Tell me please, if there is a way to knit them together on the machine....?"

We prefer to sew a seam in the shoulders of our garments, but you can knit them together on the machine if you want to, and here is the way it is done.

KNITTING SHOULDERS TOGETHER ON THE MACHINE

When knitting your garment, use short rows (made on every 2nd row) for the shoulder shaping. For instance, when knitting the Back section, if the pattern says to bind off 6 st. 5x and 7 sts. 2x (for the shoulder shaping) and you are working the right side shoulder first.... your Cam Box will be on the left side when you begin the short rows for the shoulder shaping. Put 6 needles at the right end into holding position, knit across, wrap the yarn around the inside needle to prevent a hole and knit back to the left side. Now put 6 more needles on the right into holding position and knit across, wrap yarn and knit back. Continue to put 6 needles 3x more (5x in all) into holding position until you have 30 needles in holding, then put 7 needles into holding position 1x. There will be 7 shoulder sts. left in work. Now bring all the shoulder sts. which are in holding position back into working position. Knit 1 row to the right side over 44 needles. Knit several rows with contrast waste yarn and remove work from machine. Work the left shoulder shaping in the same manner. When you are knitting the FRONT section (or sections) and all the shoulder needles are in holding position, put them into work and TURN THE TENSION UP 1 or 2 numbers, then knit 1 row and take the sts. off with contrast waste yarn.

Now you are ready to hang the sts. back onto the machine. With the KNIT SIDE (right side) of back facing you, hang the stitches on the right onto the machine and put the sts. behind the latches. With PURL side (wrong side) of Front facing you, hang the stitches on the right onto the same needles in FRONT of the latches (2 sts. on each needle). Remove waste yarn. Now one at a time pull the front shoulder sts. through the back sts. (you are actually knitting the stitches by hand... Owners of KNITTING machines can push in the Right Cam Control Button and knit 2 rows without yarn then release button) Turn the tension up 4 or 5 numbers higher than the tension used for knitting the garment, knit 1 row, then bind off the crochet method. If you cannot turn the tension up higher, knit this one row loosely by hand, then bind off the crochet method.

With the KNIT side facing you (right side) hang the shoulder stitches on the left of BACK section onto the machine. With PURL side (wrong side) facing you, hang the shoulder sts. on the left of FRONT section onto the same needles.... and work the second shoulder in the same way as the first.

KNITTING IN RAGLAN SLEEVES

In the last issue of KNITTING MAGAZINE, we told you now to knit the Raglan Sleeves into Dress DK 7892. One of our Instructors has come up with

an additional good idea which we are passing on to you.... When you hang the Raglan stitches of the front and back onto the machine (preparing to knit the sleeve) DO NOT REMOVE THE WASTE YARN... Complete your sleeve first and then remove the waste yarn. The idea is - should you make a mistake, you can rip back and reknit the sleeve without losing the stitches of the front and back.... great...!

KNITTING MAGAZINE COVER GARMENTS

Because they are in color, our Cover Garments usually look more attractive than the garments illustrated in black and white inside the magazine.... We wish that it were possible to show all garments in color, but the costs would be prohibitive unless we were able to at least triple our circulation.

The classic simplicity of the garment we used on the Cover of our January/February 1971 issue was obviously enhanced by the beautiful Amoretta Orlon yarn we used in making it... As a result, it proved to be one of the most popular covers ever..

Peggy Taylor of Wrightwood, California made it in Amoretta, the same color as the Cover... It looked so beautiful when finished that she entered it in the Annual Art Festival - California Chapter of the National Federation of Women's Clubs.... There were approximately 400 entrants in the Art Festival... many of them outstandingly beautiful.. but the judges chose Peggy's KNITTING Cover Garment as the most beautiful of all and awarded her First Prize... Congratulations Peggy Taylor...!

NEW KNITTING PATTERN STITCH CARDS

When we introduced the Pattern Stitch Cards in the January/February issue, we offered them at a special \$2.00 discount... and we were sold out of the first shipment before many subscribers in the East received their copies of the magazine... So...in order to insure that we do not have any unhappy customers, we are putting them (they are illustrated on the inside front cover of this issue) on special once more... Each card measures 6" x 8 1/2" and the pattern stitch illustrations are in color and black and white... Please note that although many of the cards can be used with the AM 2, they are designed for use with the AM 3 KNITTING machine... They are not suitable at all for other brands of machines...

SPECIAL OFFER

One set of 48 cards illustrating 96 pattern stitches... \$7.50 (California residents add 38¢ tax)... plus 95¢ shipping costs. Order direct from KNITTING, 1128 Crenshaw Blvd., Los Angeles, California 90019. This offer expires June 30th, 1971.

KNITTING WEAVING ACCESSORY

We goofed in our Christmas Sale.... We said that the new Weaving Accessory (for the AM 3 KNITTING only) was on Special and then we failed to include it on the price list order form. So, here it is... until the end of June... at a \$1.00 savings (the Weaver is illustrated on the inside front cover of this issue).

With the Weaver, you can knit an additional

thread (of a different size and texture to the main thread, if you wish) into your basic knitting and obtain patterns with a woven appearance. The KNITKING Weaver is a very clever, useful accessory... Its special price until June 30th... \$5.95 (California residents add 30¢ tax)... plus 30¢ shipping costs.

FREE...! FREE...! FREE...!

Instant Stitch and Row Calculator designed specifically with you in mind.... To make it easier for you to chart your own knits.... Perfect for hand or machine knitting.

You have seen a similar stitch calculator advertised in McCall's Needlework & Crafts magazine (and other knitting publications) for \$4.95.... Our new Instant Stitch and Row Calculator does all of your arithmetic for you... All you do is make a sample swatch for the yarn you intend using for your garments... We have provided a 2" and 4" stitch gauge measure in the slides of the calculator. You just place the slide over your sample swatch and when you have counted the stitches and rows within two or four inches, you place the slide back on your calculator and you can immediately read the number of stitches and rows you need for any measurement.

The Calculator is made of heavy unbreakable plastic. All figures are stamped in so that they cannot rub out and in order to make the Calculator

easy to read, the Calculator body is printed in black ink and the slide in red... It measures approximately nine inches by six inches (which of course, makes the numerals much larger than in the illustration below).

The back of the Calculator lists all of the standard (American standard in inches) body measurements for women, men and children and complete operating instructions are included.

The Instant Stitch and Row Calculator is a marvelous knitting accessory that you will rapidly discover to be indispensable... We will send one FREE and postage paid to every subscriber who places a subscription for two years to KNITKING MAGAZINE.

If you already have a subscription that has not expired, you can extend it for an additional two years by sending \$12.00 to KNITKING MAGAZINE at 1128 Crenshaw Blvd., Los Angeles, California 90019 and you will automatically receive the calculator. If you have subscribed since March 1st of this year, you can obtain a Calculator by sending an additional \$6.00 stating that you wish to extend your subscription and obtain the Calculator free... If you do not wish to take advantage of this very generous offer and would prefer to purchase the Calculator, it will sell for \$4.95 postage paid anywhere in North America. (California residents must add 25¢ Sales Tax).

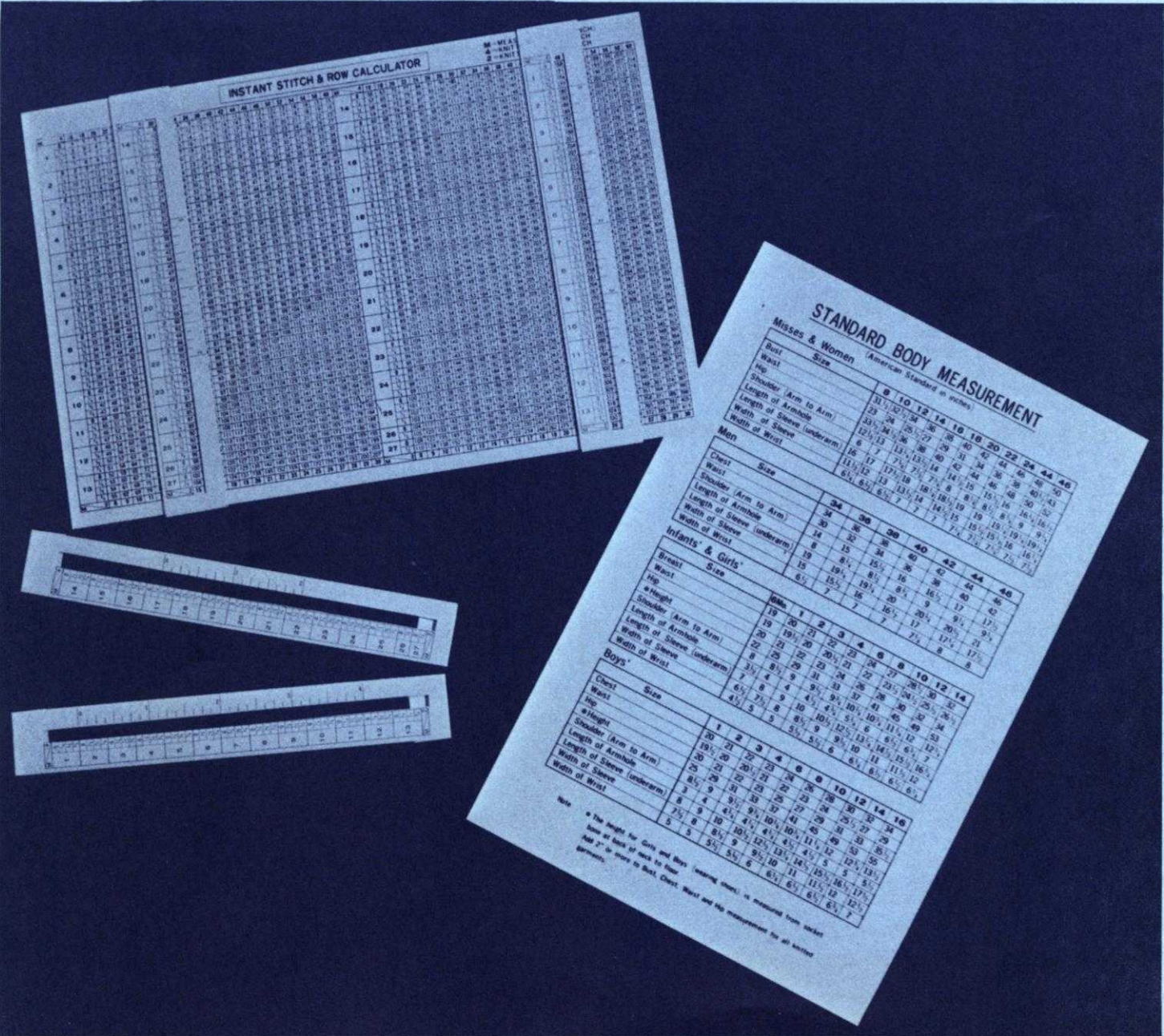

INSTANT STITCH & ROW CALCULATOR

STANDARD BODY MEASUREMENT

Misses & Women

Size	8	10	12	14	16	18	20	22	24	26	28	30
Bust	31 1/2	32 1/2	34	35 1/2	37	38 1/2	40	42	44	46	48	50
Waist	23	24	25 1/2	27	29	31	33	35	37	39	41	43
Hip	33 1/2	34 1/2	36	37 1/2	39	41	43	45	47	49	51	53
Shoulder (Arm to Arm)	12 1/2	13	13 1/2	14	14 1/2	15	15 1/2	16	16 1/2	17	17 1/2	18
Length of Armhole	6	7	7 1/2	8	8 1/2	9	9 1/2	10	10 1/2	11	11 1/2	12
Length of Sleeve	17	17 1/2	18	18 1/2	19	19 1/2	20	20 1/2	21	21 1/2	22	22 1/2
Width of Sleeve (underarm)	11 1/2	12	12 1/2	13	13 1/2	14	14 1/2	15	15 1/2	16	16 1/2	17
Width of Wrist	6 1/2	6 3/4	6 3/4	7	7 1/4	7 1/4	7 1/2	7 1/2	7 3/4	7 3/4	8	8 1/4

Men

Size	34	36	38	40	42	44	46
Chest	34	36	38	40	42	44	46
Waist	24	26	28	30	32	34	36
Shoulder (Arm to Arm)	14	15	16	17	18	19	20
Length of Armhole	6	6 1/2	7	7 1/2	8	8 1/2	9
Length of Sleeve	17	17 1/2	18	18 1/2	19	19 1/2	20
Width of Sleeve	11 1/2	12	12 1/2	13	13 1/2	14	14 1/2
Width of Wrist	6 1/2	6 3/4	6 3/4	7	7 1/4	7 1/4	7 1/2

Infants & Girls

Size	0-1	1	2	3	4	5	6	7	8	9	10	11	12	13	14
Bust	19	19 1/2	20	20 1/2	21	21 1/2	22	22 1/2	23	23 1/2	24	24 1/2	25	25 1/2	26
Waist	13	13 1/2	14	14 1/2	15	15 1/2	16	16 1/2	17	17 1/2	18	18 1/2	19	19 1/2	20
Hip	15 1/2	16	16 1/2	17	17 1/2	18	18 1/2	19	19 1/2	20	20 1/2	21	21 1/2	22	22 1/2
Shoulder (Arm to Arm)	11	11 1/2	12	12 1/2	13	13 1/2	14	14 1/2	15	15 1/2	16	16 1/2	17	17 1/2	18
Length of Armhole	5 1/2	5 3/4	6	6 1/4	6 1/2	6 3/4	7	7 1/4	7 1/2	7 3/4	8	8 1/4	8 1/2	8 3/4	9
Length of Sleeve	10 1/2	10 3/4	11	11 1/4	11 1/2	11 3/4	12	12 1/4	12 1/2	12 3/4	13	13 1/4	13 1/2	13 3/4	14
Width of Sleeve	7 1/2	7 3/4	8	8 1/4	8 1/2	8 3/4	9	9 1/4	9 1/2	9 3/4	10	10 1/4	10 1/2	10 3/4	11
Width of Wrist	5 1/2	5 3/4	5 3/4	5 3/4	5 3/4	5 3/4	5 3/4	5 3/4	5 3/4	5 3/4	5 3/4	5 3/4	5 3/4	5 3/4	5 3/4

Boys

Size	1	2	3	4	5	6	7	8	9	10	11	12	13	14	15	16
Chest	20	21	22	23	24	25	26	27	28	29	30	31	32	33	34	35
Waist	13	14	15	16	17	18	19	20	21	22	23	24	25	26	27	28
Hip	15 1/2	16	16 1/2	17	17 1/2	18	18 1/2	19	19 1/2	20	20 1/2	21	21 1/2	22	22 1/2	23
Shoulder (Arm to Arm)	11	11 1/2	12	12 1/2	13	13 1/2	14	14 1/2	15	15 1/2	16	16 1/2	17	17 1/2	18	19
Length of Armhole	5 1/2	5 3/4	6	6 1/4	6 1/2	6 3/4	7	7 1/4	7 1/2	7 3/4	8	8 1/4	8 1/2	8 3/4	9	9 1/4
Length of Sleeve	10 1/2	10 3/4	11	11 1/4	11 1/2	11 3/4	12	12 1/4	12 1/2	12 3/4	13	13 1/4	13 1/2	13 3/4	14	14 1/4
Width of Sleeve	7 1/2	7 3/4	8	8 1/4	8 1/2	8 3/4	9	9 1/4	9 1/2	9 3/4	10	10 1/4	10 1/2	10 3/4	11	11 1/4
Width of Wrist	5 1/2	5 3/4	5 3/4	5 3/4	5 3/4	5 3/4	5 3/4	5 3/4	5 3/4	5 3/4	5 3/4	5 3/4	5 3/4	5 3/4	5 3/4	5 3/4

Note: * The height for Girls and Boys (measuring shoes) is measured from waist.
 * The height for Boys (measuring shoes) is measured from waist.
 * The height for Girls and Boys (measuring shoes) is measured from waist.
 * The height for Boys (measuring shoes) is measured from waist.

NOTES TO KNIT BY . . .

STITCH AND ROW GAUGE

KNIT A SAMPLE SWATCH . . . before you begin to knit any garment . . . for this is the MOST IMPORTANT STEP toward the correct size and the proper fit of any garment you wish to make. You MUST use the SAME YARN for your sample swatch that you will use to knit your garment and your sample swatch must be knitted large enough and using several different tension numbers on your machine. When you have done this, then you can determine the number of stitches and the number of rows in a two-inch measure. KNITTING MAGAZINE PATTERNS give you 3 tensions to try and one of them should give you the correct stitch and row gauge if you are using the yarn we recommend or a similar weight yarn. Here is the way to make your sample swatch.

Cast on over a sufficient number of needles to produce a swatch at least 4 inches wide. (If the pattern calls for 16 stitches to 2", then $16 \times 2 = 32$ stitches to cast on). Now knit 4 inches of rows at the first suggested tension number. (If the pattern calls for 22 rows to 2", $22 \times 2 = 44$ rows to knit). Knit 2 rows using a contrast color, change to the next higher tension and with garment yarn knit another 4", knit 2 rows with contrast color, change to the 3rd higher tension and knit another 4" and then bind off.



Roll the swatch into a cylinder over its length and pull on both ends, unroll it and stretch it diagonally by pulling on the four corners. Allow the swatch to rest and settle (preferably overnight) and then using a stitch gauge or a ruler, count the number of stitches over a 2" width, then the number of rows over a 2" length in EACH of the 3 tensions. Select the tension number that produces the stitches and rows called for in the pattern. If none of them are correct, you are most likely using the wrong weight of yarn.



READING OF CHARTS

You will notice the instructions start at the bottom of the Chart and work UP. Follow the charts exactly as written and providing your sample stitch and row gauge is correct, your garment will come out the right size. Please remember that the section of garment as it is knitted on the machine, faces the same way as the Charts are in this magazine. Where two front pieces are needed, (or any other part of a garment that needs two sections) only one section is normally shown and the second section is usually made with reverse shaping. Set in sleeves are usually identical, but raglan sleeves have to be knitted with reverse shaping for the second sleeve.

READING OF SYMBOLS

To simplify Pattern Knitting, we use Symbols in the Line Drawings and the Chart Diagrams. In the Line Drawings the symbols are shown and are to be read as you look at them while knitting a garment. For instance, if

a Purl stitch faces you, the Purl stitch Symbol  is shown; if a knit stitch faces you (as when using the Ribber) then this Symbol  is shown. The Symbol  at the top of the Line Drawing is the center of the garment section and you use this as a guide for setting up the needles.

The following Symbols    are used for Eyelet Designs in the Line Drawings and also for Full Fashion shaping on the Charts. The Line Drawings have row numbers on the right side. Missing Row numbers are always knitted straight or plain.

In Holding Position Designs  selected needles are pushed into holding position for the stated number of rows. The numbers of rows appear at the right of the Line Drawings; Example: 1-4 means knit Rows 1 to 4; 5 to 7 means knit Rows 5 to 7, etc. This same Symbol is also shown on the Charts and is used for putting needles into holding position for Short Rows. The

Symbol  on the Charts is used to put needles back into working position when knitting Short Rows.

A number in a box stands for the number of rows to be knitted between shapings. Make shaping first, then knit the necessary number of rows. If for instance it reads:

1 st. 8 x



1 st. 10 x



As you will be reading the instructions from the bottom up, here is the way you will follow them: . . . Decrease or increase (depending on the direction of the garment outline) 1 st. at the row where the shaping begins, then knit 8 rows, make the next decrease, then knit 8 rows, until you have decreased (or increased) 1 st. 10 x and you have knitted 8 rows after each decrease (or increase) (1 st. 10 x + 8 rows 10 x). Now begin the first decrease (or increase) for the shaping (which has to be made 8 x) in every 6th row. Decrease (or increase) 1 st. first, then knit 6 rows until you have decreased 1 st. 6 x and after each decrease (or increase) have knitted 6 rows (1 st. 8 x + 6 rows 8 x).

Where shapings are given without a boxed number as on most armholes, necklines, etc., make the shapings on every second row (on each side of course).

(See below for more Pattern Stitch Symbols.)

PATTERN STITCH SYMBOLS



= knit stitch



= purl stitch



= empty needle (leave in working position)



= needle not used (in the out of work position)



= needle in the holding position



= Needles back into working position.



= 2 stitches on 1 needle - either transferred from the right side or the left side, then put the needle into holding position



= needle holding 2 stitches. Stitch has been transferred from the LEFT



= needle holding 2 stitches. Stitch has been transferred from the RIGHT



= 3 stitches on 1 needle. The 1st and 3rd stitch in a group of 3 needles has been hung on the 2nd or center needle.



= Center of Garment Section.



= Number of rows to be knitted between shapings.

The diagrams (Line Drawings) for pattern work are followed just as they are shown and are to be read as you look at them while knitting the garment.

open darts



closed darts



