

# knitking

*magazine*

sept/oct '71

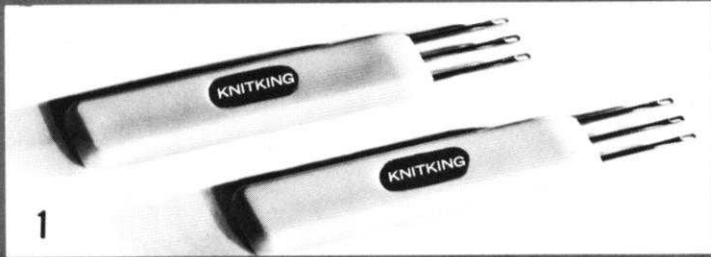



1

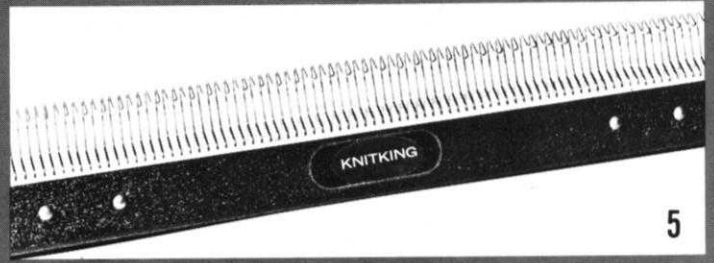

5

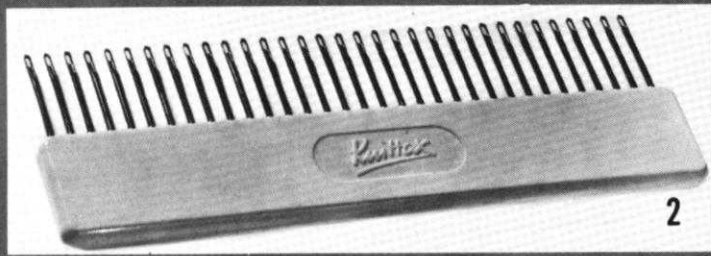

2

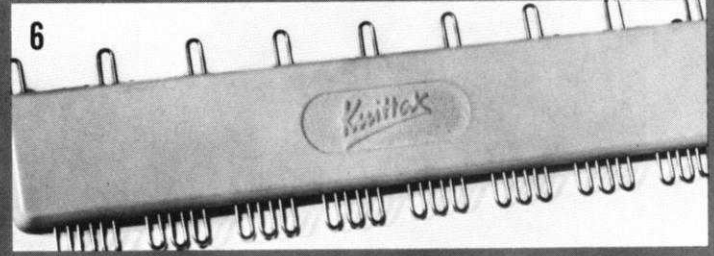

6

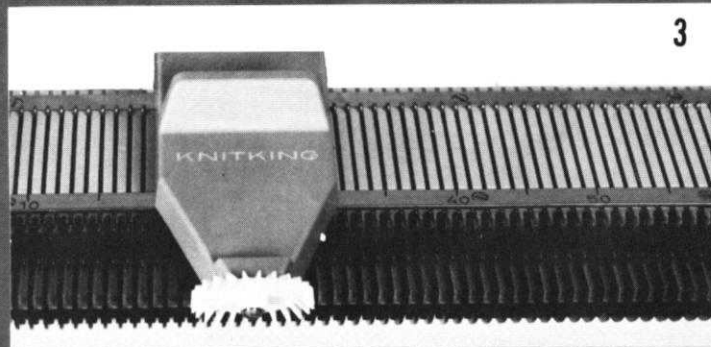

3

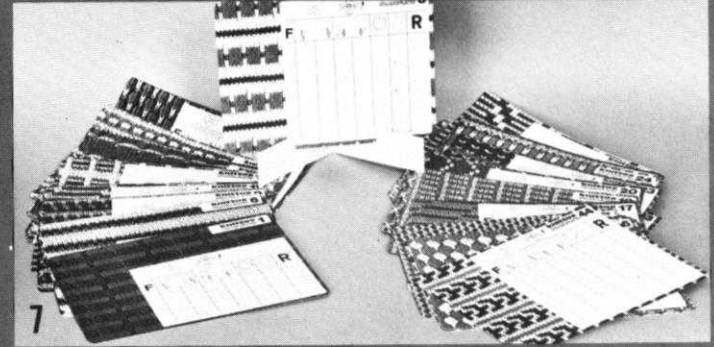

7

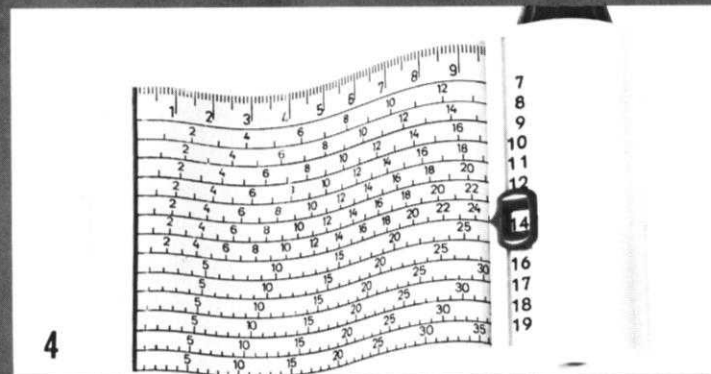

4

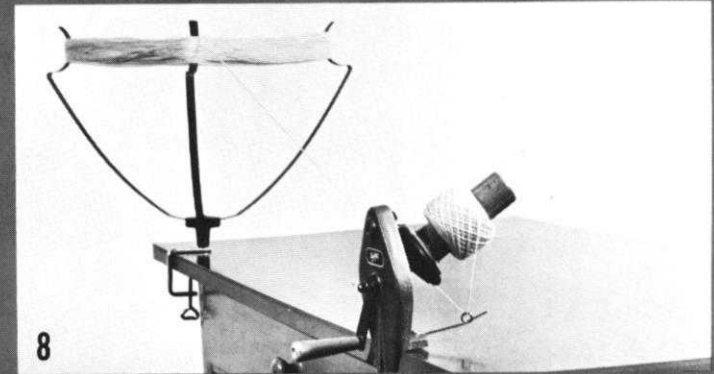

8

# accessories

1. Treble Transfer Tools for rapid transfer of stitches and for Cable Stitch. \$1.50 pair plus 25¢ shipping.

2. 33 Needle Multi-Transfer Tool. For decreasing in the middle of a row. \$3.25 plus 25¢ shipping.

3. KNITKING Weaving Accessory (for AM 3 machine). Weaves an additional thread into your knitting and produces patterns with a woven appearance. \$6.95 plus 30¢ shipping.

4. Converta Tape. For simple and speedy charting of custom knits. \$6.95 plus 30¢ shipping.

5. Reversing Bar. For easy hem turning or reversing of knitting. \$17.95 plus \$1.50 shipping.

6. Adjustable Needle Selector. For setting unevenly spaced pattern stitches. \$3.50 plus 25¢ shipping.

7. KNITKING Pattern Stitch Cards (for AM 3 machine only). 48 Pattern Cards with 96 beautiful patterns in color and black and white. Simple row by row instructions. \$9.50 plus 95¢ shipping.

8. Yarn Winder and Skein Holder. Heavy cast frame and nylon gears. \$15.95 plus \$1.00 shipping. Without Skein Holder \$12.95 plus \$1.00 shipping.

California residents add 5% Sales Tax

**KNITKING • 1128 Crenshaw Blvd., Los Angeles, California 90019**

# knitking magazine

INDEX	PAGE NO
DK 7993	Woman's Pantsuit . . . . . 14
DK 8020	Woman's Hotpants Jumpsuit & Coat 16
DK 7992	Woman's Knicker Suit & Pullover 17
DK 7999	Woman's Dress . . . . . 19
DK 7997	Woman's Suit . . . . . 21
DK 7991	Woman's Mid-Calf Pants & Pullover 22
DK 7990	Woman's Sleeveless Coat . . . . . 23
HP 3653	Man's Pullover . . . . . 24
DP 7998	Woman's Pullover . . . . . 24
HP 3650	Man's Pullover . . . . . 26
MK 5326	Girl's Pullover . . . . . 27
MK 5324	Child's Pullover . . . . . 28
MK 5323	Girl's Pullover and Skirt . . . . . 28
KK 5325	Boy's Pullover . . . . . 29
KK 5327	Boy's Pullover . . . . . 30
KG 1927	Bridal Group . . . . . 31



### FRONTPIECE

We're on the beam . . . ! and flying into our 8th year of publication with the greatest fashions ever . . . . You'll love our selection

of knitted garments to wear through the last breath of Summer into Fall . . . . Knit our Cover Model Pantsuit DK 7993 (the size range is terrific) in a Norwegian Design that follows the Line Drawing . . . or use JAC 40 and Pattern No. 447. Size 8/10 and 12/14 are knitted with KNITKING Subita Crepe 2 x 4; Size 16/18, Crocus Crepe. See page

Publisher: KNITKING CORPORATION, 1128 Crenshaw Blvd., Los Angeles, Calif. 90019. Telephone: WEbster 8-2079. Published bi-monthly. Subscriptions: USA - \$6.00 annually, single copies \$1.50; Canada - \$7.00; other parts of the world - \$10.00. The entire contents of KNITKING MAGAZINE are copyright and must not be reproduced in any shape or form without the express permission, in writing of the publisher. COPYRIGHT © by KNITKING CORPORATION 1971.

Printed by George Rice & Sons, Los Angeles, California



KNITKING  
1128 Crenshaw Blvd.  
Los Angeles, Calif. 90019

## ORDER IT NOW!

Every reader of KNITKING MAGAZINE needs the new big beautiful KNITKING YARN CATALOGUE with 329 actual yarn samples . . . the finest from around the world in an unbelievable range of colors.

I enclose one dollar . . . .  
Please RUSH my beautiful new  
KNITKING YARN CATALOGUE to me at:

Name \_\_\_\_\_

Address \_\_\_\_\_

City \_\_\_\_\_ State \_\_\_\_\_ Zip \_\_\_\_\_



## NEW VOLUME AVAILABLE NOW

A complete seventh volume of **KNITKING MAGAZINES** with a flexible, transparent plastic cover and specially bound so that it will stay open at any page, is available at the special price of \$6.95 (plus 95 cents mailing costs).

If purchased separately the magazines would cost a total of \$9.00.

The volume contains over 120 fully illustrated complete stylish patterns for all members of the family together with many valuable, practical knitting hints.

There is a very limited number of these volumes available and it will undoubtedly become a collectors item.

If you already have the entire set it will almost certainly be well thumbed and marked. Why not purchase a perfect mint condition volume for your bookshelf and ready reference at any time.

Place your order today and avoid disappointment. Send it to **KNITKING MAGAZINE**, 1128 Crenshaw Boulevard, Los Angeles, California 90019.

I enclose \$7.90

Please **RUSH** my bound Seventh Volume of **KNITKING MAGAZINE** to me at:

Name \_\_\_\_\_

Address \_\_\_\_\_

City \_\_\_\_\_ State \_\_\_\_\_ Zip \_\_\_\_\_

## BOOKS by KNITKING

### KNITKING CHILDREN'S BOOK

The Big, beautiful book of children's patterns. Over 50 complete and lovely patterns for infants and children to teenage. Buntings, Blankets and Baby outfits, cute Dresses, Leotites, Skirts, Suits, Pull-overs, Cardigans, Stockings, Trousers, etc. . . . The only Children's Book for the machine knitter published in the U.S.A. It sells for **\$2.95**

40 cents mailing  
Calif. residents add 5% Sales Tax



### PRACTICAL KNITTING HINTS

We call this book the **TEXT BOOK** for machine knitters because it answers the many questions that occur in machine knitting, from preparing to knit, taking measurements, shaping, making button-holes, special effects, bindings, bands and edges, etc., through finishing and blocking. It sells for **\$2.95**

40 cents mailing  
Calif. residents add 5% Sales Tax



### COLLECTING FILE

Keep your valuable **KNITKING MAGAZINES** in mint condition in a Collecting File. Each file holds twelve issues.

**\$2.95**  
75 cents mailing  
Calif. residents add 5% Sales Tax



# knitking

*magazine*

This issue of KNITKING MAGAZINE marks the beginning of our eighth year of publication . . . and as you can see, Tony, our Art Layout Man, decided to celebrate the occasion with Flowers and Birds . . . He likes the nice things readers say about KNITKING MAGAZINE and he takes pride in producing art work that is new and original for each issue.

It isn't easy to fit all the needed material into each edition and we sometimes have to do quite a bit of juggling, but it is all part of the fun . . . Everybody at KNITKING takes pride in our magazine and each does his or her part in the continuing effort to 'top' the previous issue.

We believe that Volume Seven was far and away our finest to date . . . To improve upon it is quite a challenge . . . So, watch out for us . . . We have some plans for 1972 that we think will please our readers . . . KNITKING MAGAZINE still operates at a financial loss, but our steadily increasing list of subscribers added to the many loyal charter subscribers is gradually pushing the circulation up to where the magazine can be self-supporting . . . which brings us to the following observations:

Some readers write and ask why we do not recommend brands of yarn other than KNITKING for our patterns and why KNITKING Pattern Instructions are not given for all brands of machines . . . The answer is . . . if we did not sell KNITKING Yarns, KNITKING Machines and other KNITKING products, KNITKING MAGAZINE could not exist . . . Profit made on the sale of KNITKING merchandise helps pay the high production and printing costs of this quality magazine . . . The revenue from subscriptions for the first 6 years of publication did not pay half our production costs . . . It costs just as much to design garments, to layout and set up to print 10 copies as it does to print 10,000 or 100,000, so obviously, the more we print, the lower the cost per copy becomes.

We publish KNITKING MAGAZINE as a service to our customers because we believe that a knitting machine without patterns is about as much good as an automobile without gasoline . . . We thank our many subscribers and KNITKING customers whose confidence in our products and business integrity makes it possible for us to provide complete service to the knitting machine owner.

We have a stunning assortment of patterns ready for the next issue and again it will take a jig-saw expert to fit everything in . . . The Cover will feature a Pantsuit with a Tunic top that can be worn as a Mini Dress . . . Inside, we will have several original design outfits for the girls including a four piece mix and match Suit with a Skirt that buttons down the front . . . A glamorous sleeveless full length (you can make it shorter if you wish) Evening Dress for the many readers who have been asking for it . . . A maxi long sleeved Dress in a new Jac Design and a cuffed Pantsuit with a fashionable midi length sleeveless Coat to wear over a favorite Sweater . . . Your men will get really excited over the handsome new design Jacquard Sweaters for them, especially the one that includes a reverse Design sleeveless zipped Jacket that fits over the top of the Sweater.

Our Designers really go overboard for the Youngsters in the next issue with up to date styling in a Pantsuit, Leotight Suit, Jumper Suit and Sweaters, etc. . . . The Gift section will have a magnificent Afghan designed and made by Mary Davis, our head Teacher in Los Angeles . . . Ruth Williams is in charge of the Magazine Department and she loves to make up Gift items for the Magazine. She made the Doll outfits in this issue and promises some easy to make, interesting Gift items for the forthcoming issue.

LETTER  
from the  
PUBLISHER



**DK 8020**

Wow . . !! Create a fashion commotion in a kinky Hotpants Jumpsuit that shows off a pretty figure. It's knitted in Stockinette Stitch, zips in the back and the Heart Motif on the front is a Duplicate Stitch. Pull multi-color cords through the belt carriers . . . The long sleeveless Coat is knitted with 3 colors. Size 10, use KNITKING Crocus Crepe; Size 12, Amore. See page 16

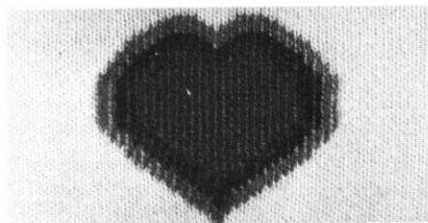

**DK 7992**

Match it — mix it . . . any way you make the scene, admiring eyes will follow you. Tuck the kooky Knickers into high Boots . . . wear the scoopy matching top over the long sleeved Pullover. Knit any one . . . or all three fabulous Patterns. You can follow the Line Drawing for the Norwegian Design or use JAC 40 and Pattern No. 448. Size 12 is knitted with KNITTING Subita Crepe 2 x 4; Size 14, Subita Dralon 3-ply. For the Pullover, both sizes are knitted in Subita Crepe 2 x 3. See page 17

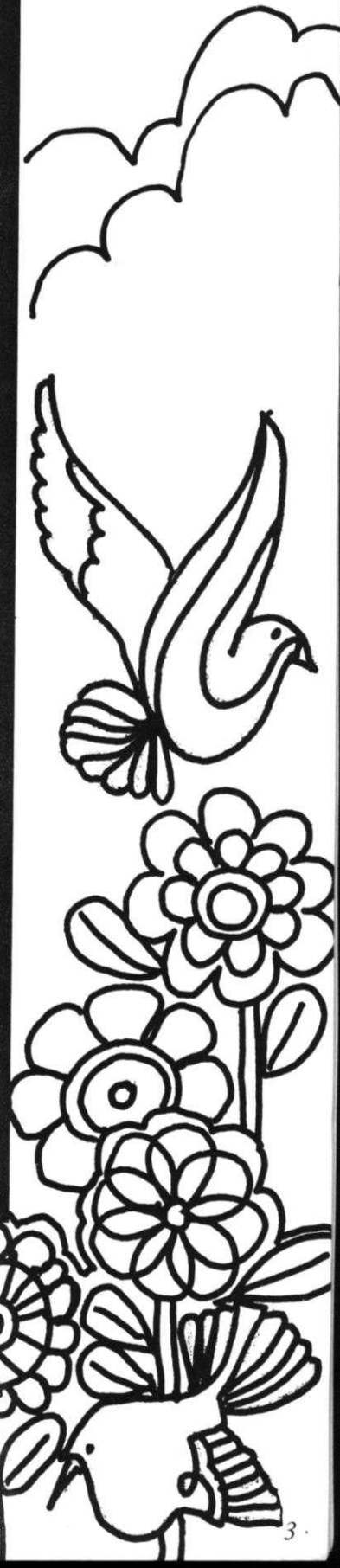

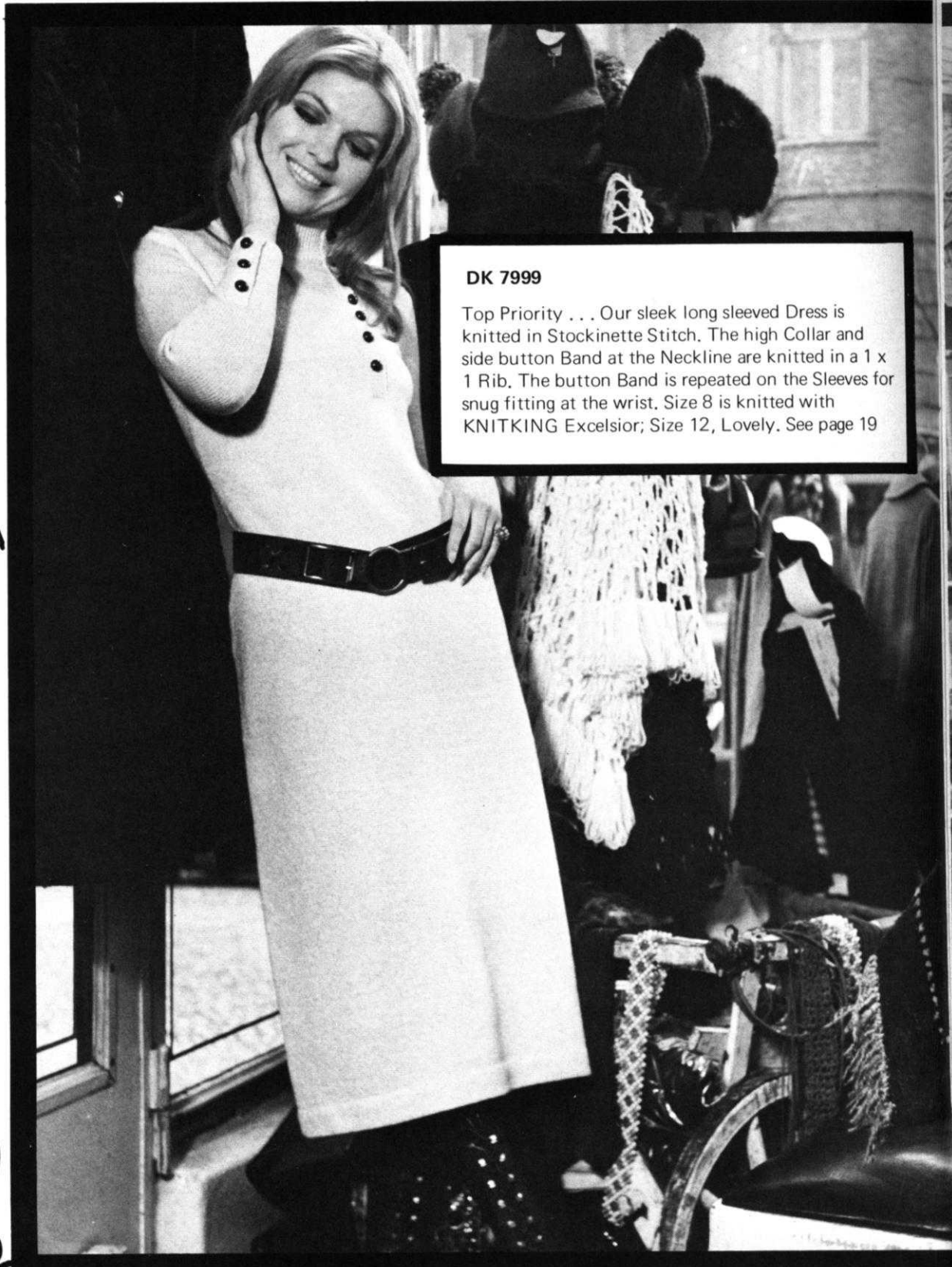

**DK 7999**  
Top Priority . . . Our sleek long sleeved Dress is knitted in Stockinette Stitch. The high Collar and side button Band at the Neckline are knitted in a 1 x 1 Rib. The button Band is repeated on the Sleeves for snug fitting at the wrist. Size 8 is knitted with KNITKING Excelsior; Size 12, Lovely. See page 19



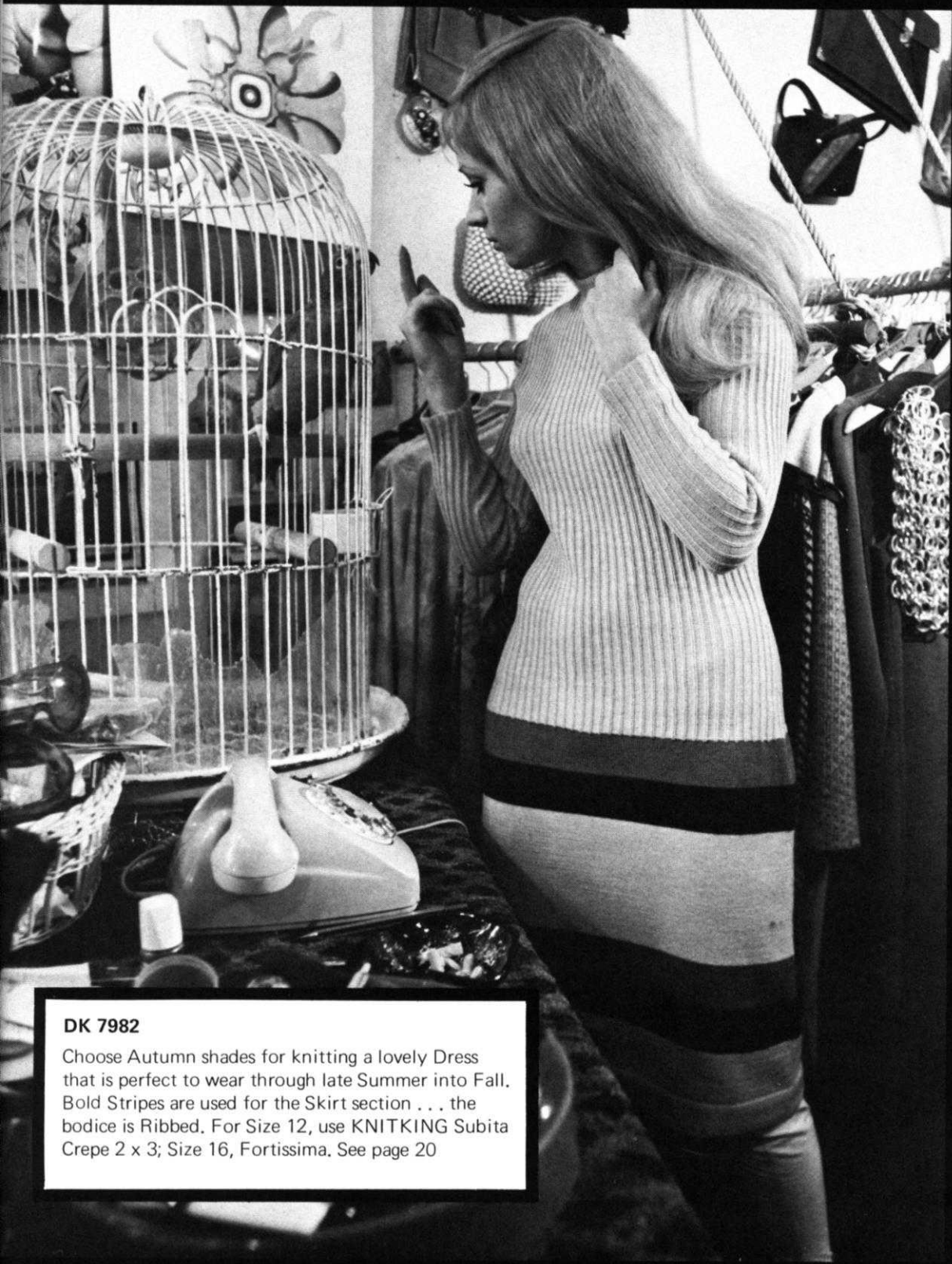

**DK 7982**

Choose Autumn shades for knitting a lovely Dress that is perfect to wear through late Summer into Fall. Bold Stripes are used for the Skirt section . . . the bodice is Ribbed. For Size 12, use KNITKING Subita Crepe 2 x 3; Size 16, Fortissima. See page 20

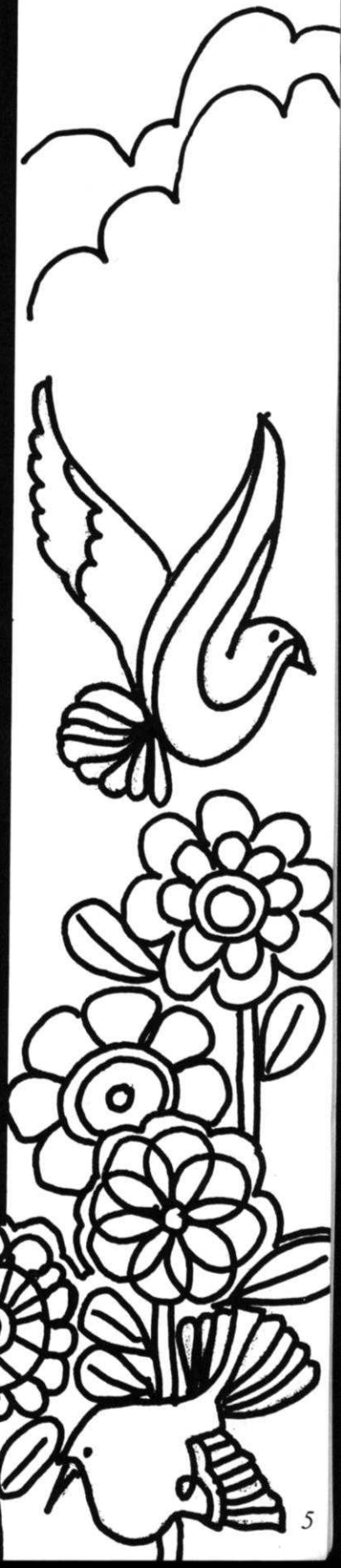



**DK 7997**

Include a button front Skirt and Jacket in your plans for a Fall Wardrobe. Very easy to knit in Stockinette Stitch. Three sizes are given. . . Size 10 and Size 12 are knitted with KNITKING Subita Crepe 2 x 3; Size 14 in Crocus Crepe. See page 21

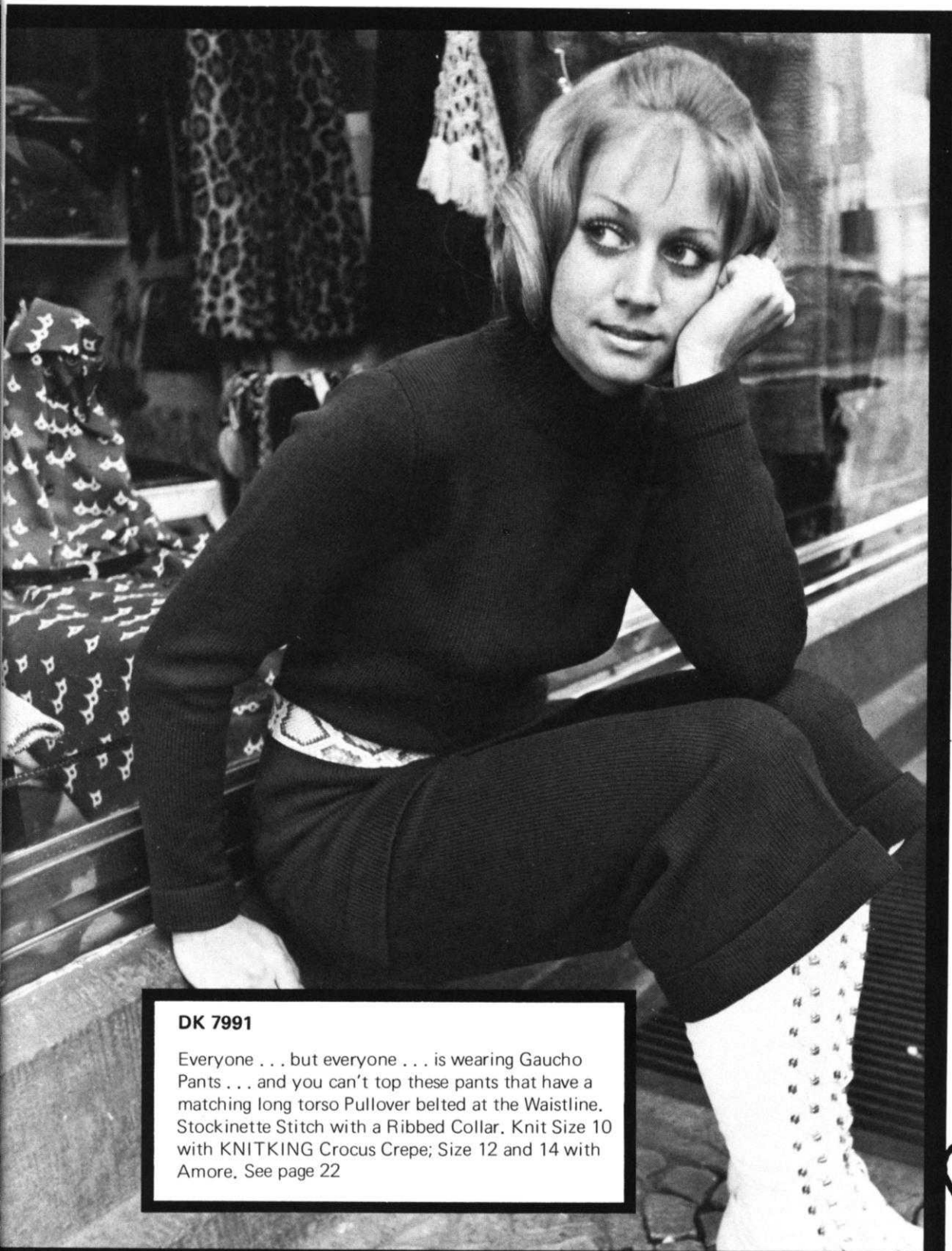

**DK 7991**

Everyone . . . but everyone . . . is wearing Gaucho Pants . . . and you can't top these pants that have a matching long torso Pullover belted at the Waistline. Stockinette Stitch with a Ribbed Collar. Knit Size 10 with KNITKING Crocus Crepe; Size 12 and 14 with Amore. See page 22



**DK 7990**

A long, sleeveless Coat has tremendous possibilities . . . particularly when it is knitted quickly in Stockinette Stitch. You can make it as is, or shorter to any length you prefer. Trim the Coat with a purchased Braid as shown, but if you want to knit your own Braid, you will find one in our Newsletter at the back of this magazine. Be sure to order 2 extra balls of yarn for the trim. Knit Size 10 with KNITKING Crocus Crepe; Size 12 with Excelsior; Size 14 with Sonika Dralon. See page 23





**HP 3653**

Your busy Executive will appreciate a new Pattern for a Pullover knitted in a Holding Position Design. KNITKING machine owners can use Weaving Wheel No. W2. The Bands and Collar are Ribbed. Knit Size 38 with KNITKING Subita Dralon 3-ply; Size 40 with Subita Crepe 2 x 4. See page 24.

**DP 7998**

Ribbed Pullovers are still dear to the heart of the College Girl and she wants one in every color . . . Knit this one in a 3 x 1 Rib in a Size 10 or 12 using KNITKING Subita Crepe 2 x 3. See page 24

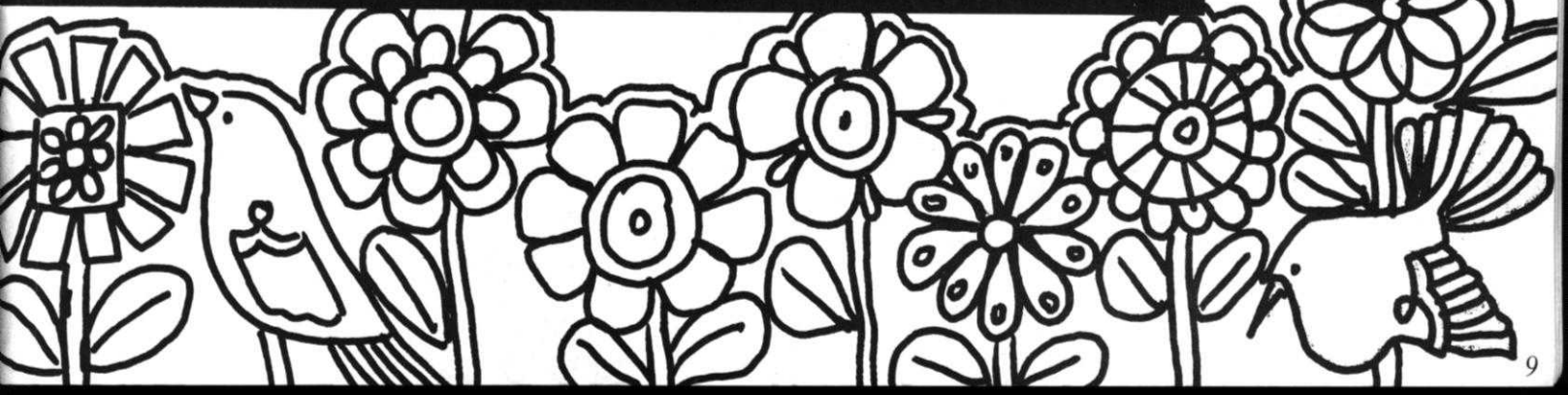
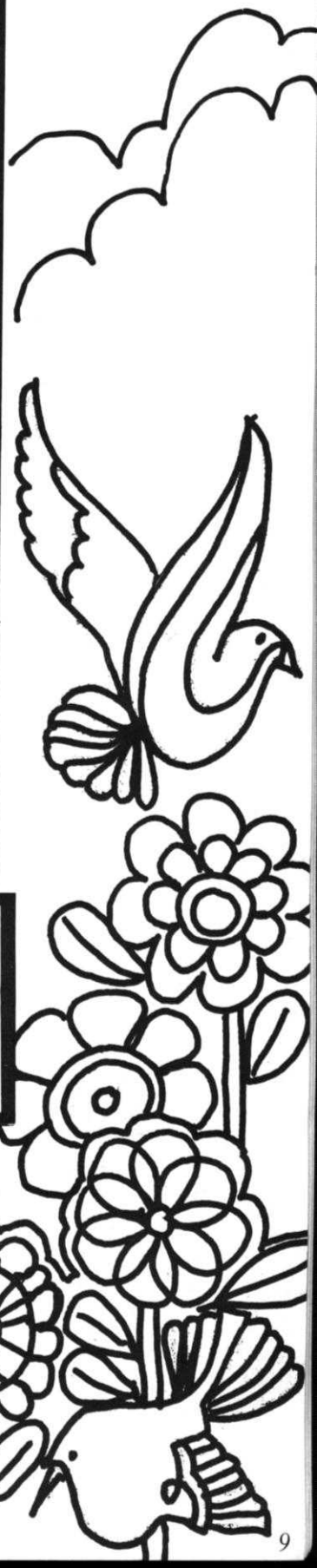

**HP 3650**

Our brand new styling for a Man's Pullover is knitted in a Ribbed Pattern. Buttons across the shoulder and side front Band simulate an opening. For Size 38, use KNITTING Subita Crepe 2 x 3; for Size 40, 2 x 4. See page 26

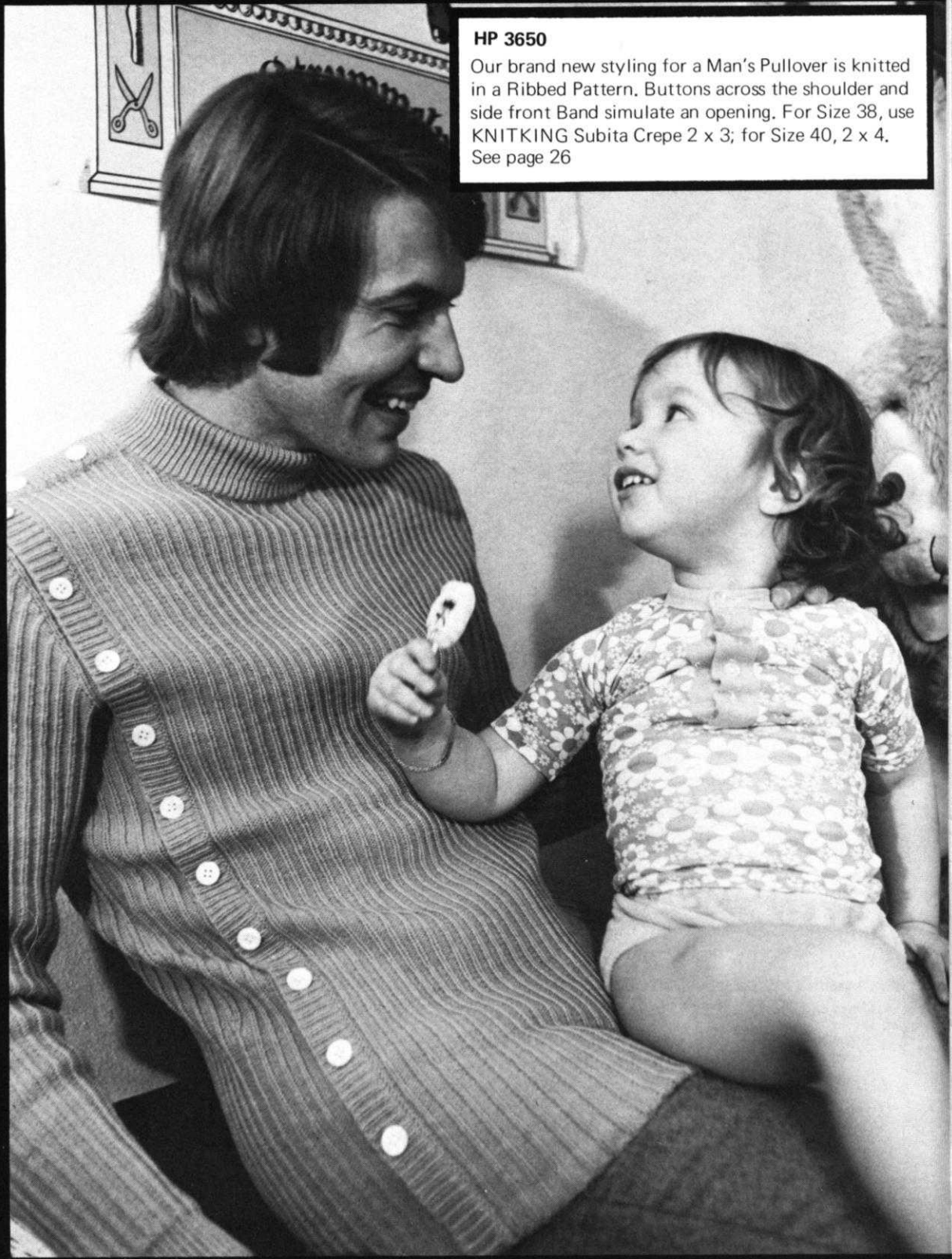

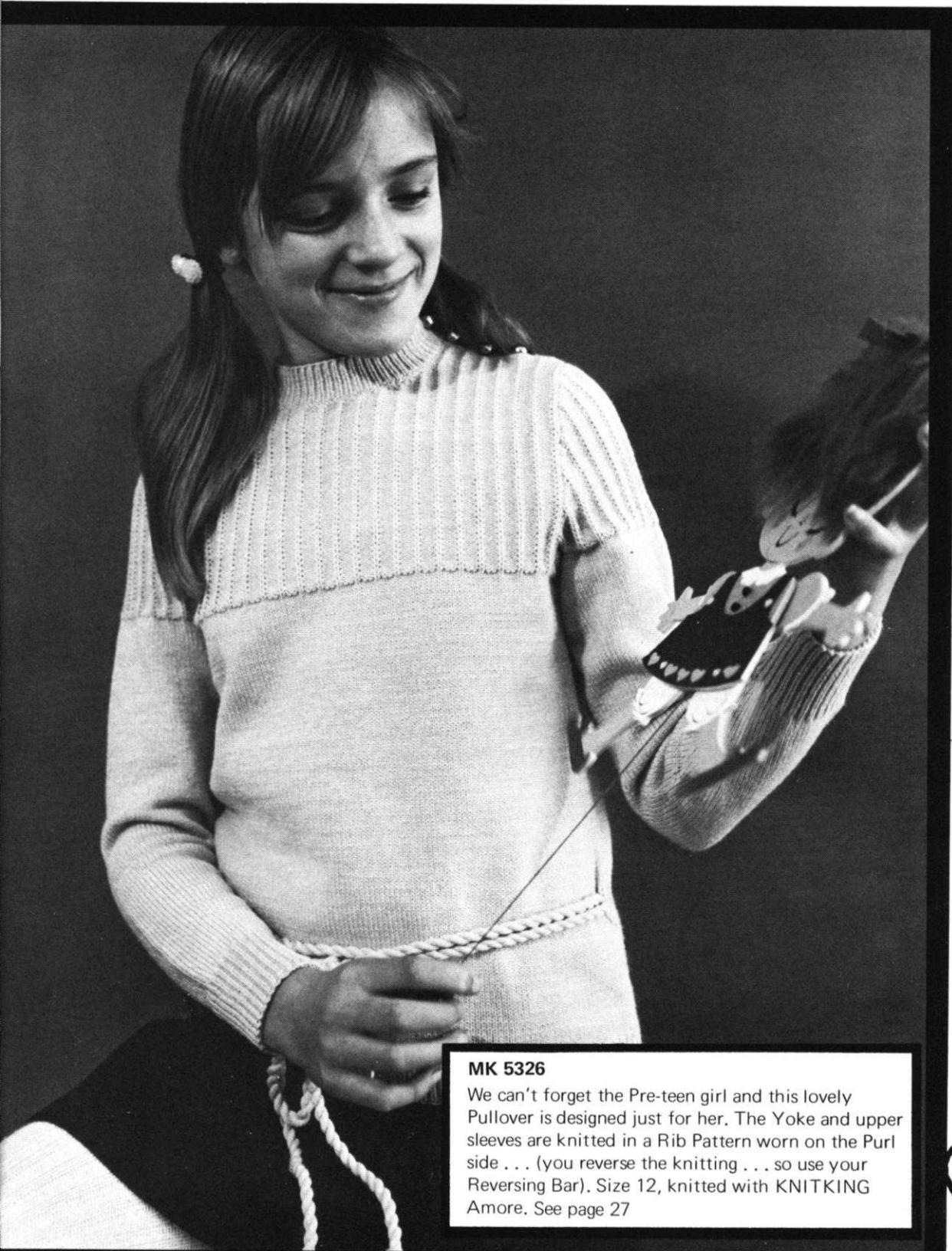

**MK 5326**

We can't forget the Pre-teen girl and this lovely Pullover is designed just for her. The Yoke and upper sleeves are knitted in a Rib Pattern worn on the Purl side . . . (you reverse the knitting . . . so use your Reversing Bar). Size 12, knitted with KNITKING Amore. See page 27





**KK 5324**

A warm, cozy Pullover for a child is made with an all over Cable Design. Bands are Ribbed and it zips at the Neckline. Use KNITKING Crocus Crepe for Size 4. See page 28

**MK 5323**

Pert and Pretty are the words for this small Girl's two-piece Dress. The Skirt is knitted sideways on the machine; the Pullover is made with a Norwegian Border Design. It buttons at the Shoulder. Use KNITKING Subita Crepe 2 x 3, but you may also use Amore if you order 6 balls of the main color instead of 5. Size 3 to 4. See page 28

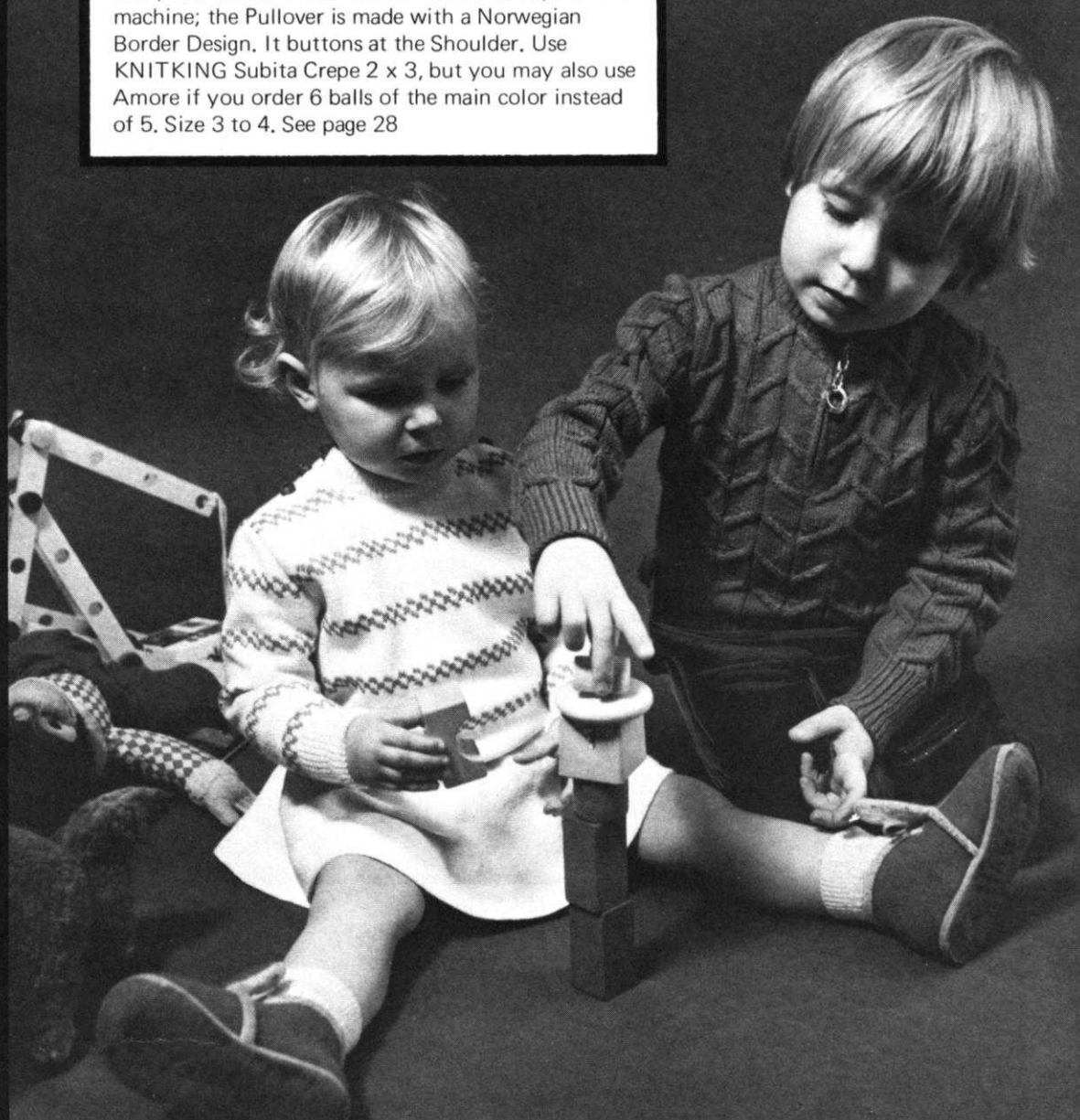



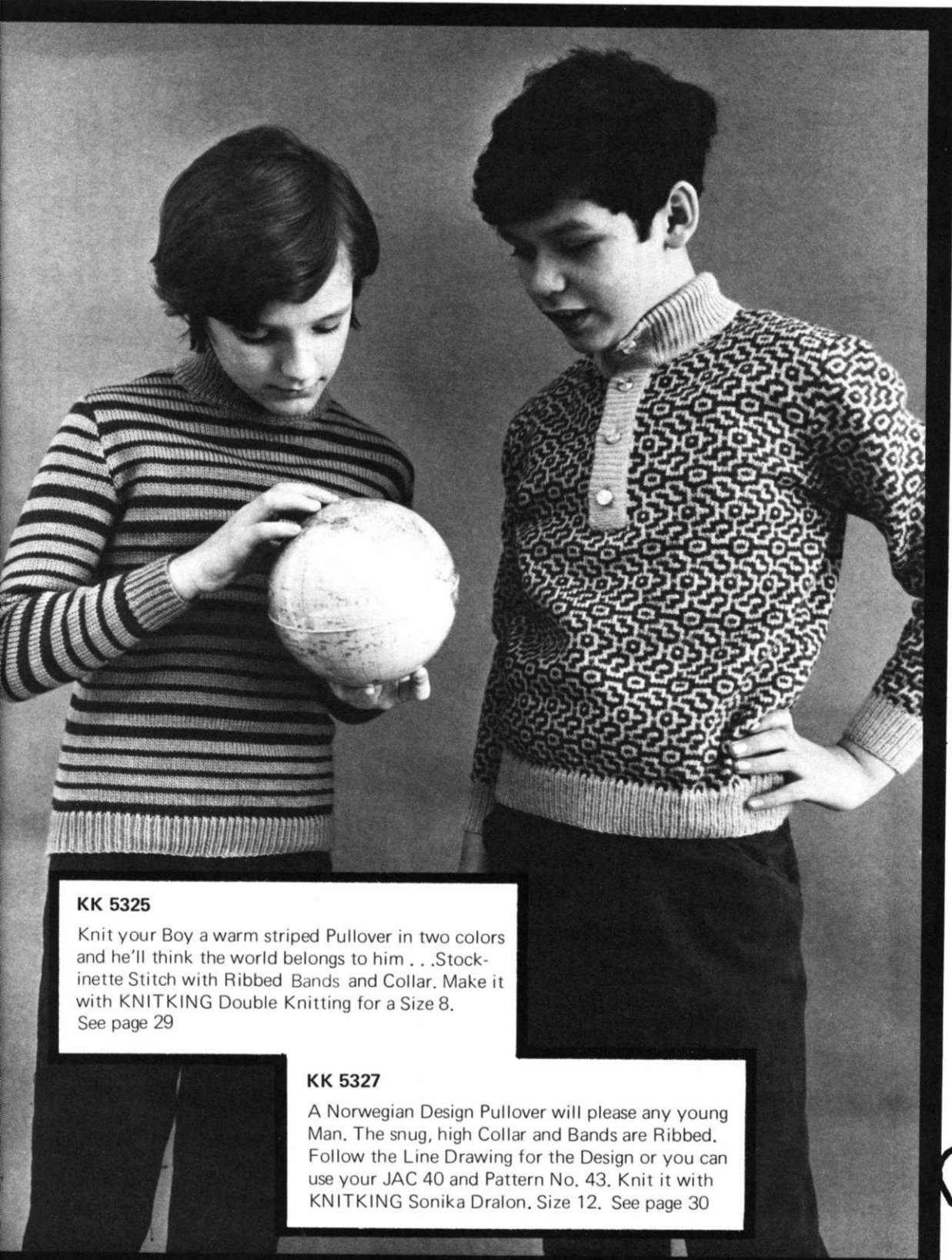

**KK 5325**

Knit your Boy a warm striped Pullover in two colors and he'll think the world belongs to him . . . Stock-inette Stitch with Ribbed Bands and Collar. Make it with KNITKING Double Knitting for a Size 8. See page 29

**KK 5327**

A Norwegian Design Pullover will please any young Man. The snug, high Collar and Bands are Ribbed. Follow the Line Drawing for the Design or you can use your JAC 40 and Pattern No. 43. Knit it with KNITKING Sonika Dralon. Size 12. See page 30

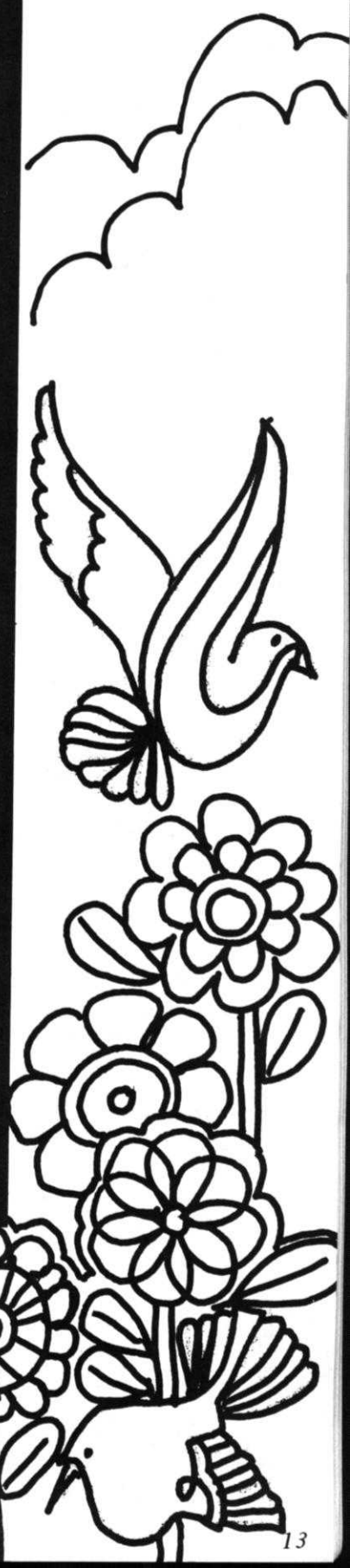

# DK 7993

SIZE 8/10 (Bust 31 1/2"-32 1/2"), SIZE 12/14 (Bust 34"-36"), SIZE 16/18 (Bust 38"/40").  
 MATERIAL: SIZE 8/10: 14-50 gr. balls Color 1 and 12-50 gr. balls Color 2. **KNITTING** Subita and 12-50 gr. balls Color 2. **GAUGE:** Pattern Stitch 15 sts. 2", 37 rows 2", Stockinette Stitch 15 sts. 2", 21 rows 2". **SIZE 12/14:** 14-50 gr. balls Color 1 and 12-50 gr. balls Color 2. **KNITTING** Subita Crepe 2 x 4. **TENSION:** 5 to 7. **GAUGE:** Pattern Stitch 14 sts. 3", 35 rows 2", Stockinette Stitch 14 sts. 2", 20 rows 2". **SIZE 16/18:** 17-50 gr. balls Color 1 and 14-50 gr. balls Color 2. **KNITTING** Crocus Crepe. **TENSION:** 7 to 9. **GAUGE:** Pattern Stitch 13 sts. 2", 34 rows 2", Stockinette Stitch 13 sts. 2", 19 rows 2". The instructions are the same for all sizes. **PATTERN:** 2 Color Holding Position Design according to Line Drawing or use JAC 40 and Pattern No. 447. **FACING** and **BELT:** Stockinette Stitch. **DECREASES:** After rows indicated, hang the 1st st. on the appropriate sides, onto the 2nd st. **INCREASES:** On the appropriate sides, after rows indicated, place the end st. from the row below onto the next empty needle.

**FINISHING:** Block all sections. **TOP:** Join front and back section at sides and shoulders, easing in the fullness at bustline of front section. Sew sleeves together and set in. Turn under 16 rows on lower edge and sleeve edges and hem to wrong side. Work 1 row of single crochet around front opening. Join hood sections. Sew hood to neckline, leaving about 1 1/2" on the front edges free. Line the front edges and the hood with taffeta. Work 7 loops on right and sew 7 buttons to left front edge. **PANTS:** Join sections at center back and center front, leaving about 7" on the center front open for the zipper. Turn under a small amount around the opening and hem to wrong side. Sew the leg seams together. Turn under 16 rows on lower leg edges and hem to wrong side. On wrong side, sew an elastic band to waist. Sew in the zipper and sew hooks and eyes in place. **BELT:** Sew the belt to an 2" wide elastic band, then line with taffeta. Buttonhole stitch around 4 small rings and sew 2 rings to each short end of the belt. With tension 1 and over 3 needles work 2 cords 600 rows long and 1 cord 700 rows long. (The empty rows do count. See **KNITTING** Practical Knitting Hints Book page 58 for knitting a round cord). Lace the long cord through the rings and tie. Knot a short cord into each lower ring. (See picture).

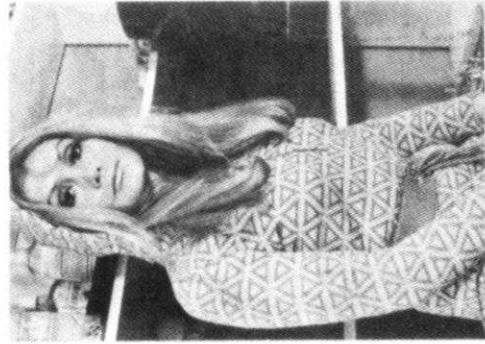

51	Color 1
49	Color 2
47	Color 1
46	Color 2
45	Color 1
43	Color 2
41	Color 1
39	Color 2
37	Color 1
35	Color 2
33	Color 1
31	Color 2
29	Color 1
27	Color 2
25	Color 1
23	Color 2
21	Color 1
19	Color 2
17	Color 1
15	Color 2
13	Color 1
11	Color 2
9	Color 1
7	Color 2
5	Color 1
3	Color 2
1	Color 1

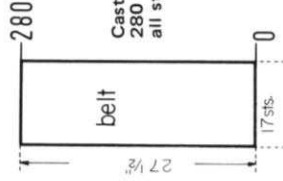
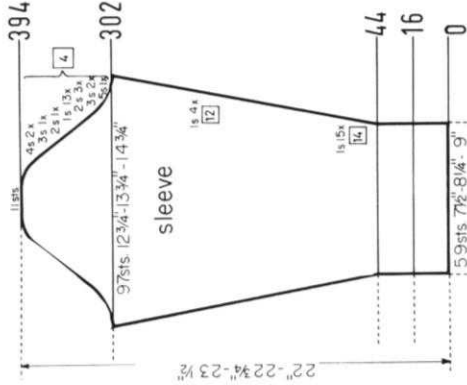

Cast on 17 sts. with Color 2 and work 280 rows stockinette st., then bind off all sts.

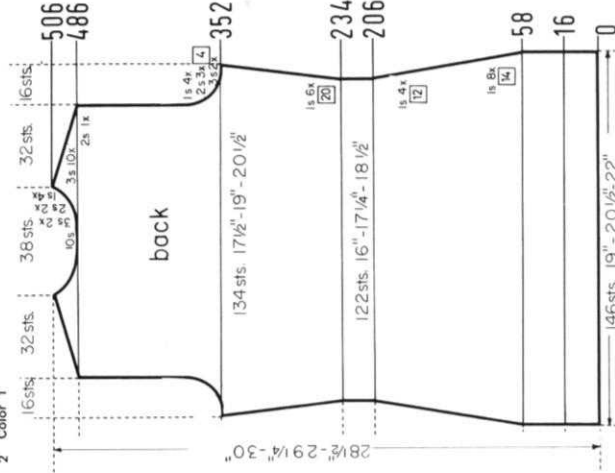

Bring the needles on the left side into working position, knit 1 row in PATTERN to the left side, turn the row counter back to 290 and complete the left half. Follow the instructions from\*.

ON CAM BOX SIDE, bind off 3 sts. after Rows 487, 489, 491 (ODD ROWS = NECK SHAPING); 2 sts. after Rows 493, 495, 497; 1 st. after Row 499; 2 sts. after Row 500 (EVEN ROWS = SHOULDER SHAPING); 1 st. after Row 501; 3 sts. after Row 502; 1 st. after Row 503; 3 sts. after Row 504; 1 st. after Row 505; 3 sts. after Rows 506, 508, 510, 512, 514, 516, 518, 520.

ON CAM BOX SIDE, bind off 3 sts. after Rows 366, 370; 2 sts. after Rows 374, 378, 382; 1 st. after Rows 386, 390, 394, 398, then knit to Row 487.

\*ON CAM BOX SIDE increase 1 st. after Rows 294, 314, 334, then knit to Row 366.

Work the front section the same as the back section to Row 290, then put 64 needles on the left side into holding position and complete the right half first.

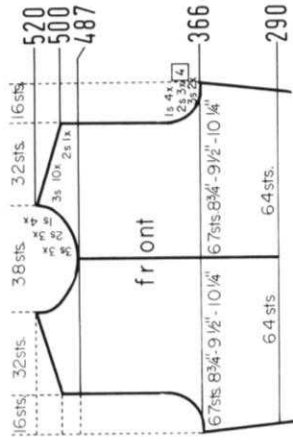

ON CAM BOX SIDE, bind off 5 sts. after Rows 302, 303; 3 sts. after Rows 306, 307, 310, 311; 2 sts. after Rows 314, 315, 318, 319, 322, 323. ON EACH SIDE, hang the 1st st. onto the 2nd st. after Rows 326, 330, 334, 338, 342, 346, 350, 354, 358, 362, 366, 370, 374. ON CAM BOX SIDE, bind off 2 sts. after Rows 378, 379; 3 sts. after Rows 382, 383; 4 sts. after Rows 386, 387, 390, 391; 11 sts. after Row 394.

ON EACH SIDE, increase 1 st. after Rows 44, 58, 72, 86, 100, 114, 128, 142, 156, 170, 184, 198, 212, 226, 240, 254, 266, 278, 290, then knit to Row 302.

ROWS 17 to 44: Knit even.

ROWS 0 to 16: Knit even, then work the Holding Position Design.

Cast on 59 sts. with Color 1 and work stockinette st.

Bring the needles on the left side into working position, knit 1 row in PATTERN to the left side, turn the Row Counter back to 486 and complete the left half. Follow the instructions from\*.

\*ON CAM BOX SIDE, bind off 2 sts. after Row 486 (EVEN ROWS = SHOULDER SHAPING); 3 sts. after Rows 487, 489, 490; 2 sts. after Row 491; 3 sts. after Row 492; 2 sts. after Row 493; 3 sts. after Row 494; 1 st. after Row 495; 3 sts. after Row 496; 1 st. after Row 497; 3 sts. after Row 498; 1 st. after Row 499; 3 sts. after Row 500; 1 st. after Row 501; 3 sts. after Rows 502, 504, 506.

ON CAM BOX SIDE, bind off 3 sts. after Rows 352, 353, 356, 357; 2 sts. after Rows 360, 361, 364, 365, 368, 369; 1 st. after Rows 372, 373, 376, 377, 380, 381, 384, 385, then knit to Row 486, bind off the center 10 sts, put the needles on the left side into holding position and complete the right half first.

ON EACH SIDE, increase 1 st. after Rows 234, 254, 274, 294, 314, 334, then knit to Row 352. (For the FRONT SECTION make the increases after Row 274, then knit to Row 290).

ON EACH SIDE, decrease 1 st. after Rows 58, 72, 86, 100, 114, 128, 142, 156, 170, 182, 194, 206, then knit to Row 234.

ROWS 17 to 58: Knit even.

ROWS 0 to 16: Knit even, then work the Holding Position Design.

Cast on 146 sts. with Color 1 and work stockinette st.



SIZE 10 (Bust 32 1/2"), SIZE 12 (Bust 34"). MATE-  
 RIAL: SIZE 10: JUMPSUIT: 11-50 gr. balls KNIT-  
 KING Crocus Crepe. TENSION: 5 to 7. GAUGE:  
 16 sts., 2", 23 rows 2". COAT: 12-50 gr. balls  
 Color 1, 3-50 gr. balls Color 2 and 3-50 gr. balls  
 Color 3 KNITTING Crocus Crepe. TENSION: 7 to  
 9. GAUGE: 15 sts., 2", 21 rows 2". SIZE 12:  
 JUMPSUIT: 10-50 gr. balls KNITTING Amore.  
 TENSION: 7 to 9. GAUGE: 15 sts., 2", 23 rows  
 2". COAT: 11-50 gr. balls Color 1, 3-50 gr. balls  
 Color 2 and 3-50 gr. balls Color 3 KNITTING  
 Amore. TENSION: 8 to 10. GAUGE 14 sts., 2", 21  
 rows 2". The instructions are the same for both  
 sizes. PATTERN: Stockinette Stitch. JUMPSUIT:  
 Design on front section worked in duplicate st. ac-  
 cording to Line Drawing. COAT: Color changes as  
 marked in the diagrams. INCREASES: After rows  
 indicated, move the 2 end sts. on the appropriate  
 sides 1 needle outward, then place the 3rd st. from  
 the row below onto the empty needle. Begin the  
 DART increases by moving the sts. outward as  
 marked on the diagram. The following increases for  
 the darts lie directly above. DECREASES: After  
 rows indicated, hang the 4th st. on the appropriate  
 sides onto the 3rd st., then move the end sts. in-  
 ward to fill the empty needle. The finished length  
 of the coat is about 43".

FINISHING: JUMPSUIT: With duplicate st. work  
 the Design into front section of bodice. Sew leg  
 seams together. Join pants sections at center front  
 and center back, leaving about 2 1/2" at upper back  
 and open. Turn under 12 rows on leg edges and hem to  
 wrong side. Join front and back sections of bodice  
 at sides and shoulders. Sew sleeves together and set  
 in. Turn under 9 rows on sleeve edges and hem to  
 wrong side. Join bodice to pants. Sew 1 edge of  
 neckband to inside and 1 edge to outside of neck-  
 line. Work 1 row of slip st. crochet around back  
 opening, then sew in the zipper. Sew belt loops in  
 place. For the belt work 5 twisted cords, 2 with  
 color 1, 2 with color 3 and 1 with color 2. COAT:  
 Join front and back sections at sides and shoulders.  
 Turn under 3 sts. around armhole edges and 18  
 rows on lower edge and hem to wrong side. Weave  
 the band to fronts and around neckline, 1 st. in  
 from each edge, then fold band under in half and  
 hem to wrong side. Finish buttonholes, sew on but-

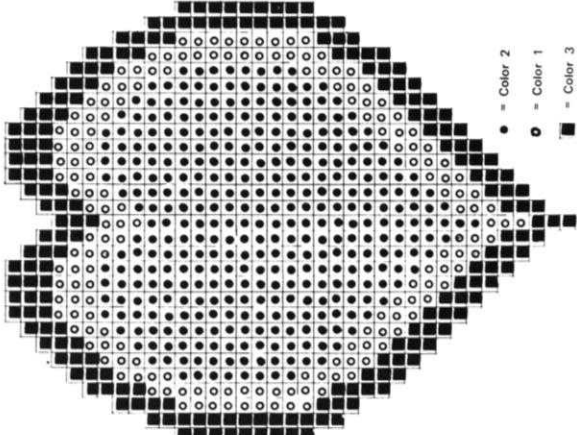

ON CAM BOX SIDE, bind off 4 sts.  
 after Rows 46, 47, 48, 49; 3 sts. after  
 Rows 50, 51, 52, 53; 2 sts. after Rows  
 54, 55, 56, 57. ON EACH SIDE, hang  
 the 1st st. onto the 2nd st. after Rows  
 58, 60, 62, 64, 66, 68, 70, 72, 74, 76,  
 78, 80, 82, 84, 86. ON CAM BOX SIDE,  
 bind off 2 sts. after Rows 88, 89; 3 sts.  
 after Rows 90, 91, 92, 93; 4 sts. after  
 Rows 94, 95; 12 sts. after Row 96.

ON EACH SIDE, increase 1 st. after  
 Rows 18, 24, 30, 34, 38, 42, then knit  
 to Row 46.  
 ROWS 0 to 18: Knit even.

Cast on 90 sts. and work stockinette st.

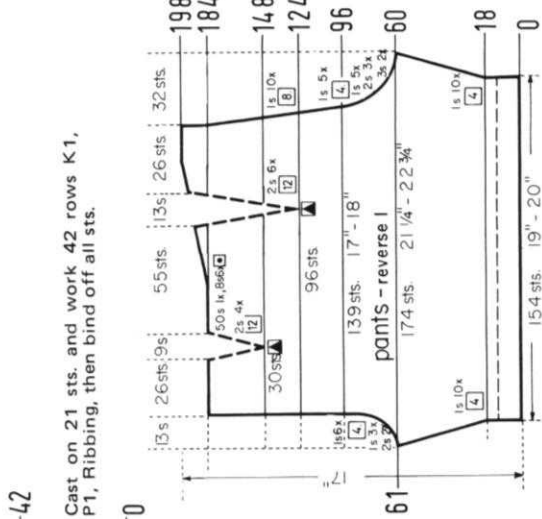

Cast on 21 sts. and work 42 rows K1,  
 P1, Ribbing, then bind off all sts.

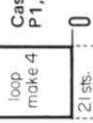

Cast on 128 sts. and work 14 rows stock-  
 inette st., then bind off all sts.

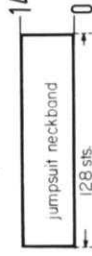

Work the second pants section with re-  
 verse shapings, casting on from right to  
 left. (Cam Box will be on the LEFT side  
 at Row 0).

Decrease 2 sts. for the DART after Rows  
 in (. Continue to decrease 1 st. ON  
 CAM BOX SIDE after Rows 124, (124),  
 132, (136) 140, then decrease 2 sts. for  
 EACH DART after Rows in (. Con-  
 tinue to decrease 1 st. ON CAM BOX  
 SIDE after Rows 148, (148), 156, (160),  
 164, 172, (172), (184) but do not knit  
 after last decreases. Work Short Rows.  
 ON OPPOSITE SIDE of CAM BOX put  
 into holding position 50 needles after  
 Row 184; 8 needles after Rows 186,  
 188, 190, 192, 194, 196. After Row 198  
 bring all needles back into working posi-  
 tion, then bind off the remaining 109  
 sts.

ON CAM BOX SIDE, bind off 3 sts.  
 after Row 60 (EVEN ROWS = CENTER  
 BACK SHAPING); 2 sts. after Row 61  
 (ODD ROWS = CENTER FRONT  
 SHAPING); 3 sts. after Row 62; 2 sts.  
 after Rows 63, 64; 1 st. after Row 65; 2  
 sts. after Row 66; 1 st. after Row 67; 2  
 sts. after Row 68; 1 st. after Rows 69,  
 70, 71, 72, 74, 75, 76, 78, 79, 80, 83,  
 84, 87, 88, 91, 92, 95, 96, 100, 108,  
 116, then knit to Row 124.

ON EACH SIDE, increase 1 st. after  
 Rows 18, 22, 26, 30, 34, 38, 42, 46, 50,  
 54, then knit to Row 60.

ROWS 0 to 18: Knit even.

Cast on 154 sts. and work stockinette st.

Work the second back section with re-  
 verse shapings, casting on from right to  
 left. (Cam Box will be on the LEFT side  
 at Row 0).

ON CAM BOX SIDE, bind off 12 sts.  
 after Row 179 (ODD ROWS = NECK  
 SHAPING); 3 sts. after Rows 180  
 (EVEN ROWS = SHOULDER SHAP.  
 ING), 181, 182, 183, 184; 2 sts. after  
 Row 185; 4 sts. after Row 186; 2 sts.  
 after Row 187; 4 sts. after Row 188; 2  
 sts. after Row 189; 4 sts. after Row 190;  
 2 sts. after Row 191; 4 sts. after Rows  
 192, 194.

ON CAM BOX SIDE, bind off 3 sts.  
 after Rows 102, 104; 2 sts. after Rows  
 106, 108; 1 st. after Rows 110, 112,  
 114, 116, then knit to Row 179.

Increase 2 sts. for the DART after Rows  
 in (. ON CAM BOX SIDE, increase 1  
 st. after Rows 10 (10), (22), 26, (34),  
 42, (46), 58, (58), 74, 88, then knit to  
 Row 102.

ROWS 0 to 10: Knit even.

Cast on 53 sts. and work stockinette st.

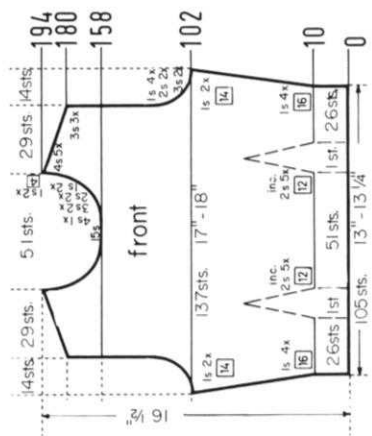

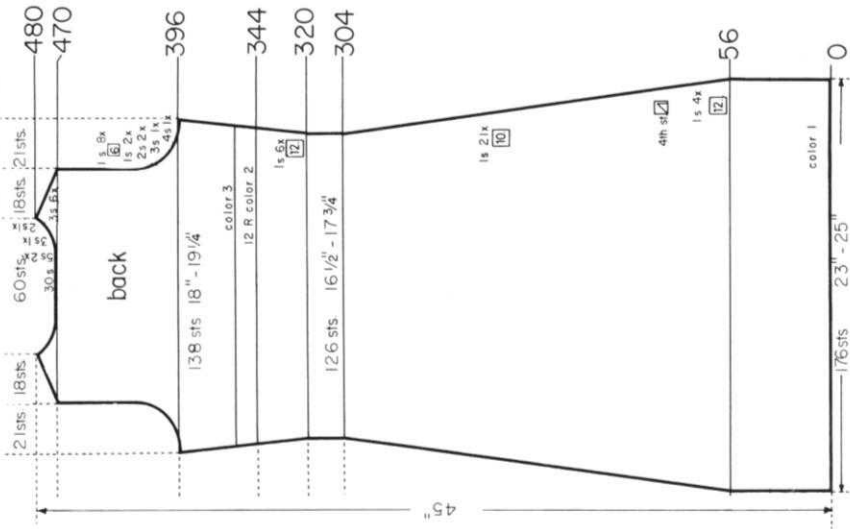

Move the Cam Box to the left side, turn the Row Counter back to 470 and complete the left half. Follow the instructions from\*.

\*ON CAM BOX SIDE, bind off 3 sts. after Row 470 (EVEN ROWS = SHOULDER SHAPING); 5 sts. after Row 471 (ODD ROWS = NECK SHAPING); 3 sts. after Row 472; 5 sts. after Row 473; 3 sts. after Rows 474, 475, 476; 2 sts. after Row 477; 3 sts. after Rows 478, 480.

ON CAM BOX SIDE, bind off 4 sts. after Rows 396, 397; 3 sts. after Rows 398, 399; 2 sts. after Rows 400, 401, 402, 403. ON EACH SIDE, decrease 1 st. after Rows 404, 406, 408, 414, 420, 426, 432, 438, 444, 450, then knit to Row 470, bind off the center 30 sts, put the needles on the left side into holding position and complete the right half first.

ON EACH SIDE, increase 1 st. after Rows 320, 332, 344 and change to Color 2, 356 and change to Color 3, 368, 380, then knit to Row 396.

ON EACH SIDE, decrease 1 st. after Rows 56, 68, 80, 92, 104, 114, 124, 134, 144, 154, 164, 174, 184, 194, 204, 214, 224, 234, 244, 254, 264, 274, 284, 294, 304, then knit to Row 320.

ROWS 0 to 56: Knit even.  
Cast on 176 sts. with Color 1 and work stockinette st.

# DK 7992

SIZE 12 (Bust 34"), SIZE 14 (Bust 36"). MATERIAL: SIZE 12: SUIT 11-50 gr. balls Color 1 and 11-50 gr. balls Color 2 KNITTING Subita Crepe 2 x 4. TENSION: 6 to 8. GAUGE: 15 sts, 2", 37 rows 2"; PULLOVER 7-50 gr. balls KNITTING Subita Crepe 2 x 3. TENSION: 3 to 5. GAUGE 18 sts, 2", 25 rows 2". SIZE 14: 10-50 gr. balls Color 1 and 10-50 gr. balls Color 2 KNITTING Subita Dralon 3 ply. TENSION: 7 to 9. GAUGE: 14 sts, 2", 35 rows 2"; PULLOVER 8-50 gr. balls KNITTING Subita Crepe 2 x 3. TENSION: 4 to 6. GAUGE: 17 sts, 2", 24 rows 2". The instructions are the same for both sizes. PATTERN: SUIT: A 2 Color Holding Position Design according to Line Drawing, or use JAC 40 and Pattern No. 448. LEG EDGES: K1, P1, Ribbing. PULLOVER: Stockinette Stitch. EDGES: K1, P1, Ribbing. SUIT DECREASES: After rows indicated, hang the 1st st. on the appropriate sides onto the 2nd st. SUIT INCREASES: On the appropriate sides after Rows indicated, hang the 1st st. from the row below onto the next empty needle. PULLOVER DECREASES: After rows indicated, hang the 3rd st. on each side onto the 2nd st., then move the end sts. inward to fill the empty needle. PULLOVER INCREASES: After rows indicated, move the 2 end sts. on each side 1 needle outward, then place the 3rd st. from the row below onto the empty needle.



FINISHING: Block all sections. PULLOVER: Join front and back section at sides and shoulders. Sew sleeves together and set in. Join short ends of collar, then sew 1 edge of collar to inside and 1 edge to outside of neckline. KNICKERS: Close the darts. Join sections at center back and center front, leaving about 5" on the center front open for the zipper. Turn under a small amount around the opening and hem to wrong side. Sew leg seams together. On wrong side, sew an elastic band to waist. Sew in the zipper. Sew hooks and eyes in place. Turn under 25 rows on lower leg edges and hem to wrong side. Insert elastic bands. TOP: Join front and back section at sides and shoulders, easing in the fullness at bustline of front section. Turn under 20 rows on lower edge and hem to wrong side. Work 2 rows of single crochet around neckline and armholes, keeping work flat.

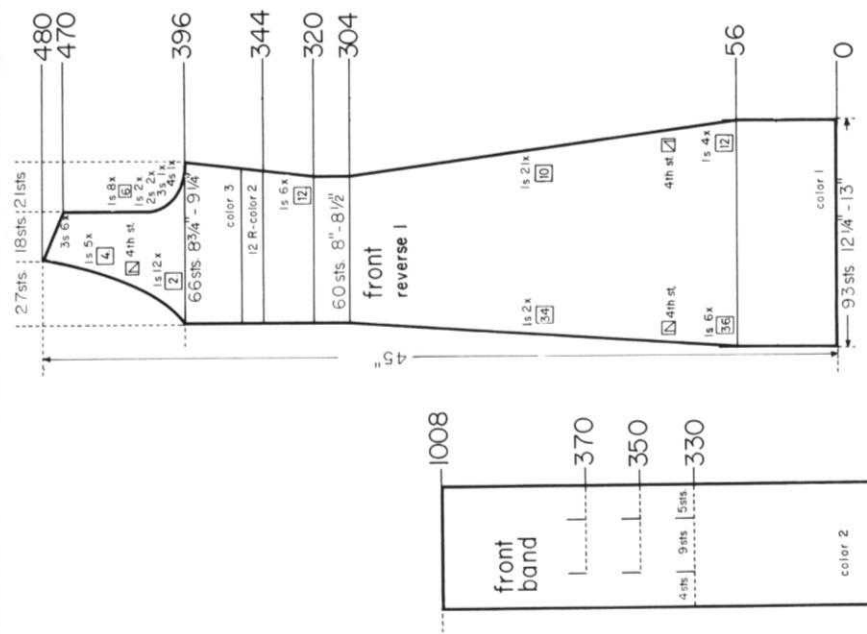

Cast on 18 sts. with Color 2 and work stockinette st. Make buttonholes after Rows 330, 350 and 370 by dividing the knitting each time over the sts. marked on the diagram, then knit for 5 rows in 3 sections. (See Practical Knitting Hints Book, Page 35). After Row 1008 bind off all sts.

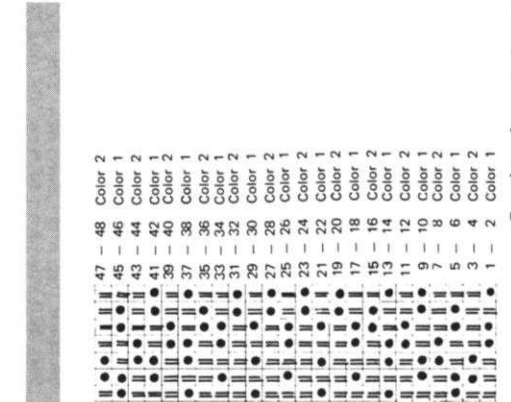

Cast on 169 sts. and work 78 rows K1, P1, Ribbing, then bind off all sts. the crochet method for ribbing.

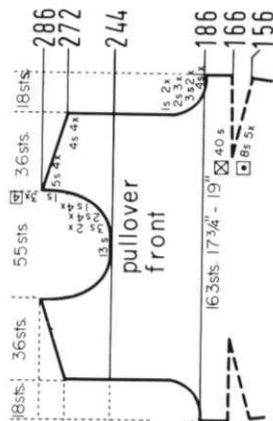
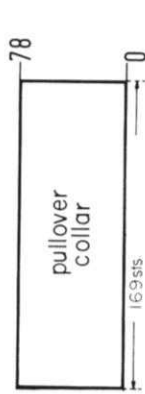

Move the Cam Box to the left side, turn the Row Counter back to 244 and complete the left half. Follow the instructions from\*.

\*ON CAM BOX SIDE, bind off 3 sts. after Rows 245, 247 (ODD ROWS = NECK SHAPING); 2 sts. after Rows 249, 251, 253, 255; 1 st. after Rows 257, 259, 261, 263, 265, 269; 4 sts. after Rows 272 (EVEN ROWS = SHOULDER SHAPING); 1 st. after Row 173; 4 sts. after Rows 274, 276, 278; 5 sts. after Row 280, 282, 284, 286.

ON CAM BOX SIDE, bind off 4 sts. after Rows 186, 187; 3 sts. after Rows 188, 189, 190, 191; 2 sts. after Rows 192, 193, 194, 195, 196, 197; 1 st. after Rows 198, 199, 200, 201, then knit to Row 244, bind off the center 13 sts, put the needles on the left side into holding position and complete the right half first.

Work Short Rows for the DARTS. ON OPPOSITE SIDE of CAM BOX put into holding position 8 needles after Rows 156, 157, 158, 159, 160, 161, 162, 163, 164, 165. Bring all needles back into working position after Rows 166, 167. ON EACH SIDE, increase 1 st. after Row 174, then knit to Row 186.

Work the front section the same as the back section to Row 156.

Move the Cam Box to the left side, turn the Row Counter back to 262 and complete the left half. Follow the instructions from\*.

\*ON CAM BOX SIDE, bind off 4 sts. after Rows 262 (EVEN ROWS = SHOULDER SHAPING), 263 (ODD ROWS = NECK SHAPING), 264, 265, 266; 3 sts. after Row 267; 4 sts. after Row 268; 3 sts. after Row 269; 5 sts. after Row 270; 2 sts. after Row 271; 5 sts. after Row 272; 2 sts. after Row 273; 5 sts. after Rows 274, 276.

ON CAM BOX SIDE, bind off 4 sts. after Rows 176, 177; 3 sts. after Rows 178, 179, 180, 181; 2 sts. after Rows 182, 183, 184, 185, 186, 187; 1 st. after Rows 188, 189, 190, 191, then knit to Row 262, bind off the center 19 sts, put the needles on the left side into holding position and complete the right half first.

ON EACH SIDE, increase 1 st. after Rows 90, 100, 110, 120, 130, 140, 152, 164, then knit to Row 176. (For the FRONT SECTION make the decreases after Row 152, then knit to Row 156).

ON EACH SIDE, decrease 1 st. after Rows 22, 30, 38, 46, 52, 58, 64, 70, then knit to Row 90.

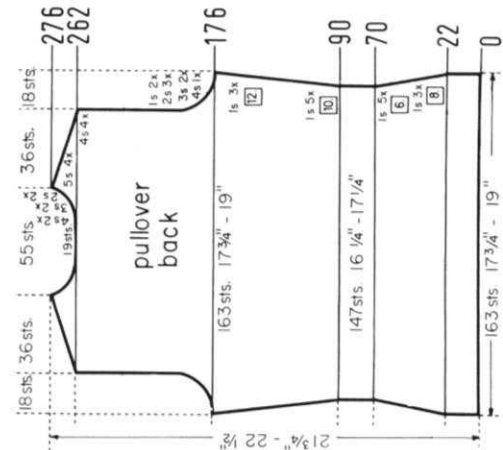

ON CAM BOX SIDE, bind off 4 sts. after Rows 206, 207; 3 sts. after Rows 208, 209, 210, 211; 2 sts. after Rows 212, 213, 214, 215, 216, 217, 218, 219; 1 st. after Rows 220, 221, 222, 223; 2 sts. after Rows 224, 225; 1 st. after Rows 226, 227, 228, 229; 2 sts. after Rows 230, 231; 1 st. after Rows 232, 233, 234, 235; 2 sts. after Rows 236, 237; 1 st. after Rows 238, 239, 240, 241; 2 sts. after Rows 242, 243; 1 st. after Rows 244, 245, 246, 247; 2 sts. after Rows 248, 249; 1 st. after Rows 250, 251, 252, 253; 2 sts. after Rows 254, 255, 256, 257, 258, 259; 3 sts. after Row 260, 261, 262, 263; 15 sts. after Row 264.

ON EACH SIDE, increase 1 st. after Rows 34, 40, 46, 52, 58, 64, 70, 76, 82, 88, 94, 100, 106, 112, 118, 124, 130, 136, 142, 148, 154, 160, 166, 174, 182, 190, 198, then knit to Row 206.

ROWS 0 to 34: Knit even, then change to stockinette st.  
Cast on 65 sts. and work K1, P1, Ribbing.

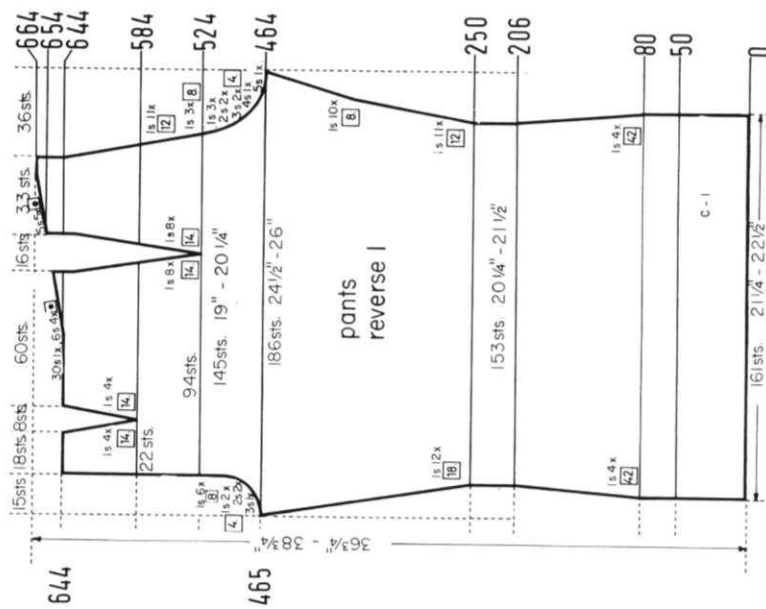
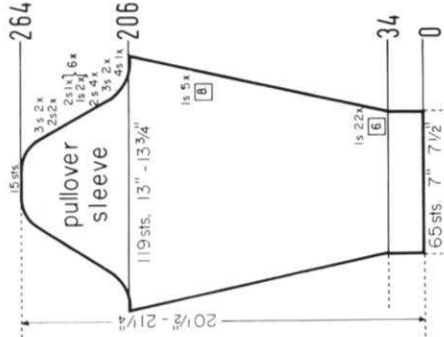

Work the second section with reverse shapings, casting on from right to left. (Cam Box will be on the LEFT side at Row 0).

Bring the remaining 22 needles into working position according to the PATTERN, turn the Row Counter back to 584. ON CAM BOX SIDE, decrease 1 st. after Rows 584, 598, 612, 626, then knit to Row 644 and bind off the remaining 18 sts.

ON OPPOSITE SIDE of CAM BOX decrease 1 st. after Row 584, then again after Rows in ( ). ON CAMB BOX SIDE, decrease 1 st. after Rows 594, (598, 608, 612), 622, (626), then knit to Row 644 and work Short Rows. ON OPPOSITE SIDE of CAM BOX put into holding position 30 needles after Row 644; 6 needles after Rows 646, 648, 650, 652. After Row 654 bring all needles back into working position, then bind off the remaining 60 sts.

ON OPPOSITE SIDE of CAM BOX bring all needles into working position according to the PATTERN, turn the Row Counter to 524. ON CAMB BOX SIDE, decrease 1 st. after Rows 524, 538, 552, 566, 580, then knit to Row 584, put 22 needles ON OPPOSITE SIDE of CAM BOX into holding position and complete the center.

To work the DART, put 94 needles on the left side (Right side for second section) into holding position and complete the right side (Left side for second section) first. ON OPPOSITE SIDE of CAM BOX decrease 1 st. after Row 524, then again after Rows in ( ). ON CAM BOX SIDE, decrease 1 st. after Rows 536, (538), 548, (552), 560, (566), 572, (580), 584, (594), 596, 608, (608), 620, (622), 632, 644, then knit to Row 654 and work Short Rows. ON OPPOSITE SIDE of CAM BOX put into holding position 5 needles after Rows 654, 656, 658, 660, 662. After Row 664 bring all needles back into working position, then bind off the remaining 33 sts.

ON CAM BOX SIDE, bind off 5 sts. after Row 464 (EVEN ROWS = CENTER BACK); 3 sts. after Row 465 (ODD ROWS = CENTER FRONT); 4 sts. after Row 468; 2 sts. after Row 469; 3 sts. after Row 472; 2 sts. after Row 473; 3 sts. after Row 476; 1 st. after Row 477; 2 sts. after Row 480; 1 st. after Row 481; 2 sts. after Row 484; 1 st. after Row 485, 488, 492, 493, 496, 500, 501, 508, 509, 516, 517 and 1 st. ON EACH SIDE after Row 524, BUT DO NOT KNIT.

ON OPPOSITE SIDE of CAM BOX increase 1 st. after Rows in ( ). ON CAM BOX SIDE, increase 1 st. after Rows 250, (250), 262, (268), 274, 286, (286), 298, (304), 310, 322, (322), 334, (340), 346, 358, (358), 370, (376), 382, 390, (394), 398, 406, (412), 414, 422, 430, (430), 438, 446, (448), 454, then knit to Row 464.

ON EACH SIDE, decrease 1 st. after Rows 80, 122, 164, 206, then knit to Row 250.

ROWS 51 to 80: Knit even.

ROWS 0 to 50: Knit even, then transfer the ribber sts. to the main machine and work the Holding Position Design. Cast on 161 sts. with Color 1 and work K1, P1, Ribbing.

# DK 7999

**SIZE 8** (Bust 31 1/2"-32 1/2"), **SIZE 12** (Bust 34"-35"), **MATERIAL:** TENSION 8: 15-50 gr. balls **KNITTING** Excelsior, TENSION 6 to 8: GAUGE: 15 sts, 2", 21 rows 2", **SIZE 12:** 22-50 gr. balls **KNITTING** Lovely, TENSION: 8 to 10: GAUGE: 14 sts, 2", 20 rows 2". The instructions are the same for both sizes. **PATTERN:** Stockinette **Stitch, BUTTON BANDS and COLLAR:** K1, P1, Ribbing. **DECREASES:** After rows indicated, hang the 3rd st. on each side onto the 2nd st., then move the end sts. inward to fill the empty needle. **INCREASES:** After rows indicated, move the 2 end sts. on each side 1 needle outward, then place the 3rd st. from the row below onto the empty needle. Finished length: **SIZE 8** about 45", **SIZE 12** about 47".

**FINISHING:** Block all sections. Joint front and back section at sides and shoulders. Sew sleeves together and set in. Turn under about 2" on lower edge and on sleeve edges and hem to wrong side. Joint short ends of collar, then sew 1 edge of collar to inside and 1 edge to outside of neckline. Sew button bands to sleeves and to front section, using the broken lines on the diagrams as a guide line. See picture.



Cast on 145 sts. and work 68 rows K1, P1, Ribbing, then bind off all sts. the crochet method for ribbing.

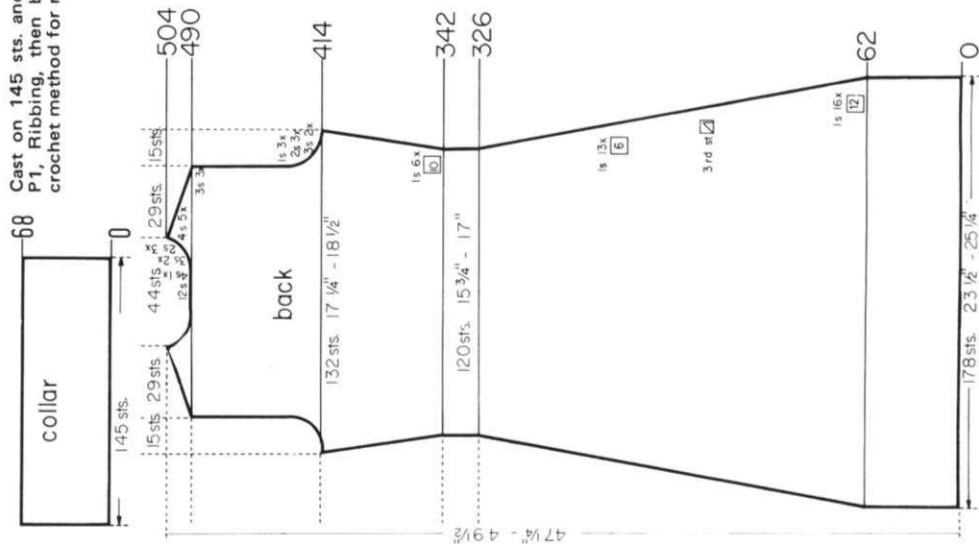

Cast on 121 sts. and work 14 rows K1, P1, Ribbing, then bind off all sts. the crochet method for ribbing.

Move the Cam Box to the left side, turn the Row Counter back to 490 and complete the left half. Follow the instructions from\*.

\*ON CAM BOX SIDE, bind off 3 sts. after Row 490 (EVEN ROWS = SHOULDER SHAPING); 4 sts. after Row 491 (ODD ROWS = NECK SHAPING); 3 sts. after Row 492, 493, 494, 495; 4 sts. after Row 496; 2 sts. after Row 497; 4 sts. after Row 498; 2 sts. after Row 499; 4 sts. after Row 500; 2 sts. after Row 501; 4 sts. after Rows 502, 504.

ON CAM BOX SIDE, bind off 3 sts. after Rows 414, 415, 416, 417; 2 sts. after Rows 418, 419, 420, 421, 422, 423; 1 st. after Rows 424, 425, 426, 427, 428, 429, then knit to Row 490, bind off the center 12 sts., put the needles on the left side into holding position and complete the right half first. (For the FRONT SECTION knit to Row 464.)

ON EACH SIDE, increase 1 st. after Row 342, 352, 362, 372, 382, 392, then knit to Row 414.

ON EACH SIDE, decrease 1 st. after Rows 62, 74, 86, 98, 110, 122, 134, 146, 158, 170, 182, 194, 206, 218, 230, 242, 254, 266, 278, 284, 290, 296, 302, 308, 314, 320, 326, then knit to Row 342.

ROWS 0 to 62: Knit even.

Cast on 178 sts. and work stockinette st.

Continued on next page

Bring the needles on the left side into working position, knit 1 row in PATTERN to the left side, turn the Row Counter back to 494 and complete the left half. Follow the instructions from\*.

\*ON NECK SIDE, bind off 4 sts. after Rows 495, 499; 3 sts. after Rows 503, 507; 2 sts. after Rows 511, 515, 519; 1 st. after Rows 523, 527, then knit to Row 538 and bind off the remaining 18 sts.

ON CAM BOX SIDE, bind off 4 sts. after Rows 390, 391; 3 sts. after Rows 394, 395, 398, 399; 2 sts. after Rows 402, 403, 406, 407. ON EACH SIDE, decrease 1 st. after Rows 410, 414, 418, 422, 426, then knit to Row 494, bind off the center 23 sts., put the needles on the left side into holding position and complete the right half first.

ON EACH SIDE, increase 1 st. after Rows 264, 284, 304, 324, 344, 364, then knit to Row 390.

ON EACH SIDE, decrease 1 st. after Rows 80, 92, 104, 114, 124, 134, 144, 154, 164, 174, 184, 194, 204, 214, 224, 234, then knit to Row 264.

ROWS 21 to 80: Knit even.

ROWS 0 to 20: Knit even, then work the Holding Position Design.

Cast on 161 sts. with Color 1 and work stockinette st.

Bring the needles on the left side into working position, knit 1 row in PATTERN to the left side, turn the Row Counter back to 404 and complete the left half. Follow the instructions from\*.

\*ON CAM BOX SIDE, bind off 4 sts. after Rows 404 (EVEN ROWS = ARM-HOLE SHAPING), 405 (ODD ROWS = NECK SHAPING); 3 sts. after Row 408, 4 sts. after Row 409; 3 sts. after Rows 412, 413; 2 sts. after Row 416; 3 sts. after Row 417; 2 sts. after Rows 420, 421; 1 st. after Row 424; 2 sts. after Row 425; 1 st. after Rows 428, 429, 432, 433, 436, 437, 440, 441, 449, 457, 465, 473, then knit to Row 552 and bind off the remaining 18 sts.

ROWS 391 to 404: Knit even, then bind off the center 15 sts., put the needles on the left side into holding position and complete the right half first.

Work the front section the same as the back section to Row 390.

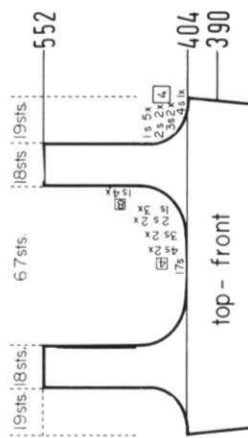
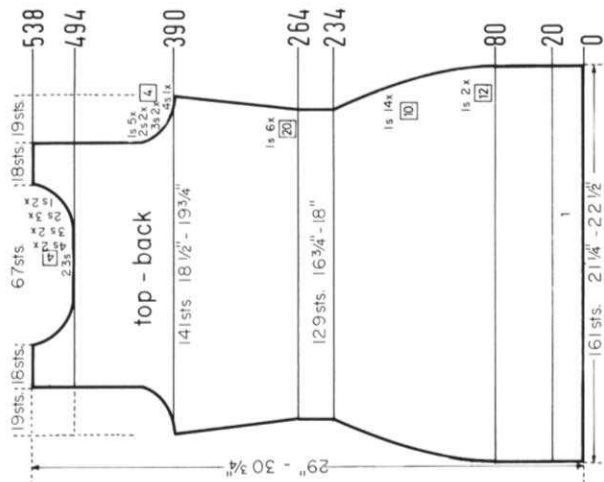

**BE SURE TO NOTIFY US IMMEDIATELY OF ANY CHANGE OF ADDRESS. THE POST OFFICE WILL NOT FORWARD YOUR MAGAZINE TO YOU.**

**SIZE 12** (Bust 34"-35"), **SIZE 16** (Bust 37"-38").  
**MATERIAL:** **SIZE 12:** 12-50 gr. balls Color 1, 1-50 gr. ball Color 2 and 1-50 gr. ball Color 3 **KITTING Subita Crepe 2 x 3. TENSION:** 4 to 6. **GAUGE:** Stockinette Stitch 18 sts. 2" = 24 rows 2"; Pattern Stitch 18 sts. 2" = 25 rows 2". **SIZE 16:** 15-50 gr. balls Color 1, 2-50 gr. balls Color 2 and 2-50 gr. balls Color 3 **KITTING Fortissima. TENSION:** 5 to 7. **GAUGE:** Stockinette Stitch: 17 sts. 2" = 23 rows 2"; Pattern Stitch: 17 sts. 2" = 24 rows 2". The instructions are the same for both sizes.  
**PATTERN:** Skirt Section: Stockinette Stitch with Color Stripes as marked in the diagram. The knit side is the right side; Bodice and Sleeves: K1, P3. Ribbing according to Line Drawing (3 sts. on the main machine and 1 st. on the ribber). The purl side is the right side. **NECKBAND:** K1, P1, Ribbing. **DECREASES:** After rows indicated, hang the 1st st. on each side onto the 2nd st. **INCREASES:** On each side, after rows indicated, place the end st. from the row below onto the next empty needle. To turn the knitting, knit several rows with contrast waste yarn, then remove the knitting from the machine (knit 1 row without yarn). Turn the knitting over then hang the garment sts. back onto the machine. Remove the waste yarn. When putting needles into holding position, transfer the appropriate ribber sts. to the main machine. The finished length of the dress is about 40½", (42½").

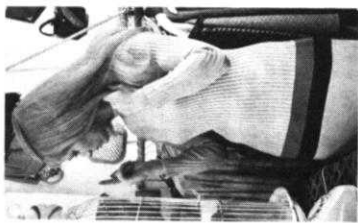

**FINISHING:** Block all sections. Join front and back section at sides and shoulders, easing in the fullness at bustline of front section. Sew sleeves together and set it. Sew 1 edge of neckband to inside and 1 edge to outside of neckline. Work 1 row of single crochet around back opening, then sew in a zipper. Turn under 19 rows on lower edge and hem to wrong side.

Bring the needles on the left side into working position, knit 1 row in PAT-TERN to the left side, turn the Row Counter back to 480 and complete the left half. Follow the instructions from\*.

**ON CAM BOX SIDE, bind off 4 sts.** after Row 510 (EVEN ROWS = SHOULDER SHAPING); 9 sts. (8 sts. for the left half) after Row 511 (ODD ROWS = NECK SHAPING); 4 sts. after Row 512; 3 sts. after Row 513; 4 sts. after Row 514; 3 sts. after Row 515; 4 sts. after Row 516; 3 sts. after Row 517; 4 sts. after Row 518; 2 sts. after Row 519; 4 sts. after Row 520; 2 sts. after Row 521; 4 sts. after Row 522; 2 sts. after Row 523; 5 sts. after Row 524; 2 sts. after Row 525; 5 sts. after Row 526.

\*ROWS 481 to 510: Knit even.

**ON CAM BOX SIDE, bind off 4 sts.** after Rows 414, 415, 416, 417; 3 sts. after Rows 418, 419, 420, 421; 2 sts. after Rows 422, 423, 424, 425; 1 st. after Rows 426, 427, 428, 429, 430, 431, then knit to Row 480, put 63 needles on the left side into holding position and complete the right half first.

**ON EACH SIDE, increase 1 st.** after Rows 334, 344, 354, 364, 374, 384, 394, 404, then knit to Row 414.

Change color and **ON EACH SIDE, decrease 1 st.** after Rows 90, 104, (change color after Row 114), 118, 132, 146, 160, 174, 186, (change color after Row 186), 198, 210, (change color after Row 210), 222, then knit to Row 234, turn the knitting and work the K1, P3 ribbed pattern with color 1. Continue to decrease 1 st. **ON EACH SIDE** after Rows 234, 242, 250, 258, 266, 274, 282, 290, 298, 306, 314, then knit to Row 334.

**ROWS 0 to 90:** Knit even. (Change color after Row 66).

Cast on 197 sts. with color 1, work stockinette st. and the color stripes as marked in the diagram.

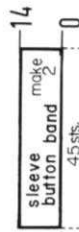
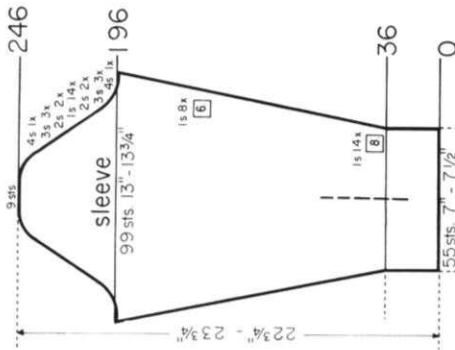
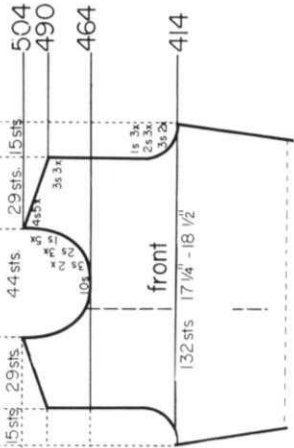

Cast on 45 sts. and work 14 rows K1, P1. Ribbing, then bind off all sts. the crochet method for ribbing.



Cast on 137 sts. and work 24 rows K1, P1. Ribbing, then bind off all sts. the crochet method for ribbing.

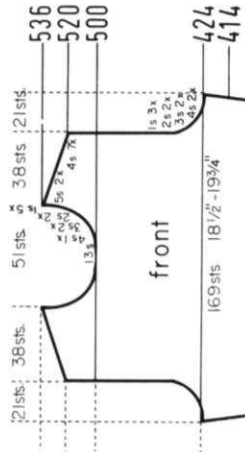

**ROWS 415 to 424:** Knit even. Work the front section the same as the back section to Row 414.

Move the Cam Box to the left side, turn the Row Counter back to 464 and complete the left half. Follow the instructions from\*.

\***ON CAM BOX SIDE, bind off 3 sts.** after Rows 465, 467; 2 sts. after Rows 469, 471, 473; 1 st. after Rows 475, 477, 479, 481, 483. For **SHOULDER** bind off 3 sts. after Rows 490, 492, 494; 4 sts. after Rows 496, 498, 500, 502, 504.

Work the front section the same as the back section the Row 464, then bind off the center 10 sts., put the needles on the left side into holding position and complete the right half first.

**ON CAM BOX SIDE, bind off 4 sts.** after Rows 196, 197; 3 sts. after Rows 198, 199, 200, 201, 202, 203; 2 sts. after Rows 204, 205, 206, 207. **ON EACH SIDE, hang the 1st st.** onto the 2nd st. after Rows 208, 210, 212, 214, 216, 218, 220, 222, 224, 226, 228, 230, 232, 234. **ON CAM BOX SIDE, bind off 2 sts.** after Rows 236, 237, 238, 239; 3 sts. after Rows 240, 241, 242, 243; 4 sts. after Rows 244, 245; 9 sts. after Row 246.

**ON EACH SIDE, increase 1 st.** after Rows 36, 44, 52, 60, 68, 76, 84, 92, 100, 108, 116, 124, 132, 140, 148, 154, 160, 166, 172, 178, 184, 190, then knit to Row 196.

**ROWS 0 to 36:** Knit even.

Cast on 55 sts. and work stockinette st.

Bring the needles on the left side into working position, knit 1 row in PAT-TERN to the left side, turn the Row Counter back to 500 and complete the left half. Follow the instructions from\*.

\***ON CAM BOX SIDE, bind off 4 sts.** after Row 501; 3 sts. after Rows 503, 505; 2 sts. after Rows 507, 509; 1 st. after Rows 511, 513, 515, 517, 519. For **SHOULDER** bind off 4 sts. after Rows 520, 522, 524, 526, 528, 530, 532, 534, 536.

**ON CAM BOX SIDE, bind off 4 sts.** after Rows 424, 425, 426, 427; 3 sts. after Rows 428, 429, 430, 431; 2 sts. after Rows 432, 433, 434, 435; 1 st. after Rows 436, 437, 438, 439, 440, 441, then knit to Row 500, bind off the center 13 sts., put the needles on the left side into holding position and complete the right half first.

**ROWS 415 to 424:** Knit even. Work the front section the same as the back section to Row 414.



# DK 7997

**SIZE 10** (Bust 32½"-33½"), **SIZE 12** (Bust 34"-35"), **SIZE 14** (Bust 36"-37"). **MATERIAL:** **SIZE 10:** SKIRT 9-50 gr. balls, JACKET 8-50 gr. balls, KNITTING Subita Crepe 2 x 3. **TENSION:** 3 to 5. **GAUGE:** 18 sts, 2", 25 rows 2". **SIZE 12:** SKIRT: 10-50 gr. balls, JACKET 9-50 gr. balls, KNITTING Subita Crepe 2 x 3. **TENSION:** 4 to 6. **GAUGE:** 17 sts, 2", 24 rows 2". **SIZE 14:** SKIRT: 14-50 gr. balls, JACKET 13-50 gr. balls, KNITTING Crocus Crepe. **TENSION:** 5 to 7. **GAUGE:** 16 sts, 2", 23 rows 2". The instructions are the same for all sizes. **PATTERN:** Stockinette Stitch. **DECREASES:** After rows indicated, hang the 4th st. on each side onto the 3rd st., then move the end sts. inward to fill the empty needle. **INCREASES:** After rows indicated, move the 2 end sts. on the appropriate sides 1 needle outward, then place the 3rd st. from the row below onto the empty needle. Begin in the JACKET DARTS by moving the sts. marked on the diagram 2 needles outward, then place the appropriate sts. from the row below on each side of the center dart needle. The following increases for the darts lie directly above. The approximate finished length of the skirt: **SIZE 10:** 32", **SIZE 12:** 33½", **SIZE 14:** 34½".



**FINISHING:** Block all sections. **JACKET:** Join front and back sections at sides and shoulders. Sew sleeves together and set in. Turn under 2" at lower edge, front edges and sleeve edges and hem to wrong side. Join upper and lower collar at side edges and bound-off edges. Sew cast-on edge of lower collar to outside and cast-on edge of upper collar to inside of neckline, leaving 2" on each front edge free. Finish free edges of neckline. Finish buttonholes, sew on buttons. **SKIRT:** Weave the skirt sections together, 1 st. in front each edge. Turn under 2" on front edges and 20 rows on lower edge and hem to wrong side. Turn under 25 rows on upper edge, hem to wrong side and insert an elastic band. Finish buttonholes, sew on buttons. Skirt may be lined with taffeta.

Move the Cam Box to the left side, turn the Row Counter back to 240 and complete the left half. Follow the instructions from \*.

\*ON CAM BOX SIDE, bind off 4 sts. after Row 240 (EVEN ROWS = SHOULDER SHAPING); 3 sts. after Row 241 (ODD ROWS = NECK SHAPING); 5 sts. after Row 242; 3 sts. after Row 243; 5 sts. after Row 244; 3 sts. after Row 245; 5 sts. after Row 246; 2 sts. after Row 247; 5 sts. after Row 248; 2 sts. after Row 249; 5 sts. after Row 250; 2 sts. after Row 251; 5 sts. after Row 252; 2 sts. after Row 253; 5 sts. after Row 254.

ON CAM BOX SIDE, bind off 4 sts. after Rows 140, 141; 3 sts. after Rows 142, 143; 2 sts. after Rows 144, 145, 146, 147, 148, 149; 1 st. after Rows 150, 151, 152, 153, 154, 155, 156, 157, 158, 159, then knit to Row 240, bind off the center 17 sts., put the needles on the left side into holding position and complete the right half first.

Increase 2 sts. for each DART and 1 st. ON EACH SIDE after Rows 50, 64, 78, 92, 106. The darts are now completed. Increase 1 st. ON EACH SIDE after Row 120, then knit to Row 140.

ROWS 0 to 50: Knit even.

CAST on 133 sts. and work stockinette st.

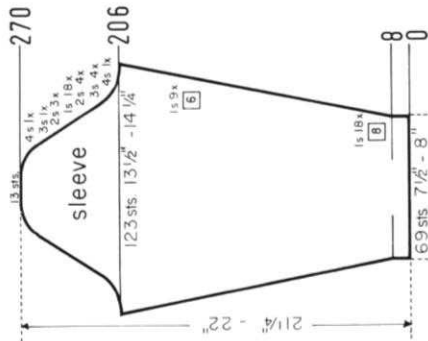

ON CAM BOX SIDE, bind off 4 sts. after Rows 206, 207; 3 sts. after Rows 208, 209, 210, 211, 212, 213, 214, 215; 2 sts. after Rows 216, 217, 218, 219, 220, 221, 222, 223. ON EACH SIDE, hang the 1st st. onto the 2nd st. after Rows 224, 226, 228, 230, 232, 234, 236, 238, 240, 242, 244, 246, 248, 250, 252, 254, 256, 258. ON CAM BOX SIDE, bind off 2 sts. after Rows 260, 261, 262, 263, 264, 265; 3 sts. after Rows 266, 267; 4 sts. after Rows 268, 269; 13 sts. after Row 270.

ON EACH SIDE, increase 1 st. after Rows 8, 16, 24, 32, 40, 48, 56, 64, 72, 80, 88, 96, 104, 112, 120, 128, 136, 144, 152, 158, 164, 170, 176, 182, 188, 194, 200, then knit to Row 206.

ROWS 0 to 8: Knit even.

Cast on 69 sts. and work Knit 1, Purl 3 Ribbing.

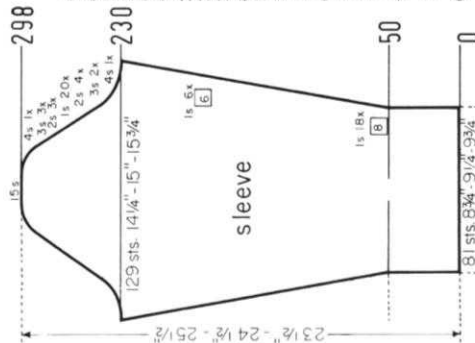

ON CAM BOX SIDE, bind off 4 sts. after Rows 230, 231; 3 sts. after Rows 232, 233, 234, 235; 2 sts. after Rows 236, 237, 238, 239, 240, 241, 242, 243. ON EACH SIDE, hang the 1st st. onto the 2nd st. after Rows 244, 246, 248, 250, 252, 254, 256, 258, 260, 262, 264, 266, 268, 270, 272, 274, 276, 278, 280, 282. ON CAM BOX SIDE, bind off 2 sts. after Rows 284, 285, 286, 287, 288, 289; 3 sts. after Rows 290, 291, 292, 293, 294, 295; 4 sts. after Rows 296, 297; 15 sts. after Row 298.

ON EACH SIDE, increase 1 st. after Rows 50, 58, 66, 74, 82, 90, 98, 106, 114, 122, 130, 138, 146, 154, 162, 170, 178, 186, 194, 200, 206, 212, 218, 224, then knit to Row 230.

ROWS 0 to 50: Knit even.

Cast on 81 sts. and work stockinette st.

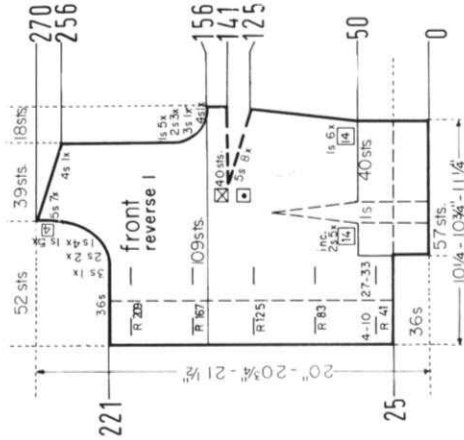

ON CAM BOX SIDE, bind off 4 sts. after Rows 156, 162, 164; 1 st. after Rows 166, (167), 168, 170, 172, 174. Make buttonholes after Row 209, then knit to Row 221.

Make buttonholes after Row in ( ). ON CAM BOX SIDE bind off 4 sts. after Row 156; 3 sts. after Row 158; 2 sts. after Rows 160, 162, 164; 1 st. after Rows 166, (167), 168, 170, 172, 174. Make buttonholes after Row 209, then knit to Row 221.

Make buttonholes after Row in ( ). Increase 2 sts. for the DART and 1 st. ON CAM BOX SIDE after Rows 50, 64, 78, (83), 92, 106. The dart is now completed. ON CAM BOX SIDE, increase 1 st. after Row 120, then knit to Row 125, make buttonholes, but do NOT knit. Work Short Rows for the DARTS. ON OPPOSITE SIDE of CAM BOX put into holding position 5 needles after Rows 125, 127, 129, 131, 133, 135, 137, 139. After Row 141 bring all needles back into working position, then knit to Row 156.

Knit even to Row 25, then cast on 36 sts. ON CAM BOX SIDE. Knit to Row 41, make buttonholes over the 4th-10th and 27th-33rd sts. counting from the left side, then knit to Row 50.

Cast on 57 sts. and work stockinette st.

# DK 7991

SIZE 10 (Bust 32"-32 1/2"), SIZE 12 (Bust 34"-35"), SIZE 14 (Bust 36"-37"). MATERIAL: SIZE 10: PULLOVER 13-50 gr. balls, PANTS 13-50 gr. balls KNITTING Crocus Crepe. TENSION: 5 to 7 GAUGE: 16 sts. 2", 23 rows 2". SIZE 12: PULLOVER 12-50 gr. balls, PANTS 12-50 gr. balls KNITTING Amore. TENSION: 6 to 8 GAUGE: 15 sts. 2", 23 rows 2". SIZE 14: PULLOVER 13-50 gr. balls, PANTS 13-50 gr. balls KNITTING Amore. TENSION: 7 to 9 GAUGE: 14 sts. 2", 22 rows 2". The instructions are the same for all sizes. PATTERN: Stockinette Stitch. COLLAR: K1, P1, Ribbing. DECREASASES: After rows indicated, hang the 3rd st. on the appropriate sides onto the 2nd st., then move the end sts. inward to fill the empty needle. INCREASES: After rows indicated, move the 2 end sts. on the appropriate sides 1 needle outward, then place the 3rd st. from the row below onto the empty needle. Begin the PANTS DARTS by hanging the sts. together as marked on the diagram, then move the end sts. inward to fill the empty needles. The following decreases for the darts lie directly above.

FINISHING: Block all sections. PULLOVER: Join front and back section at sides and shoulders. Sew sleeves together and set in. Turn under 19 rows on lower edge and sleeve edges and hem to wrong side. Join short ends of collar, then sew 1 edge of collar to inside and 1 edge to outside of neckline. PANTS: Join sections at center back and center front. Sew leg seams together. Turn under 19 rows on upper edge, hem to wrong side and insert an elastic band. Turn under 19 rows on leg edges and hem to wrong side. To form cuffs, separate the 2 layers on the hems and fold up, having the hem seam line at the inner center of the hem. Press cuffs, then fasten in place at the leg seams.

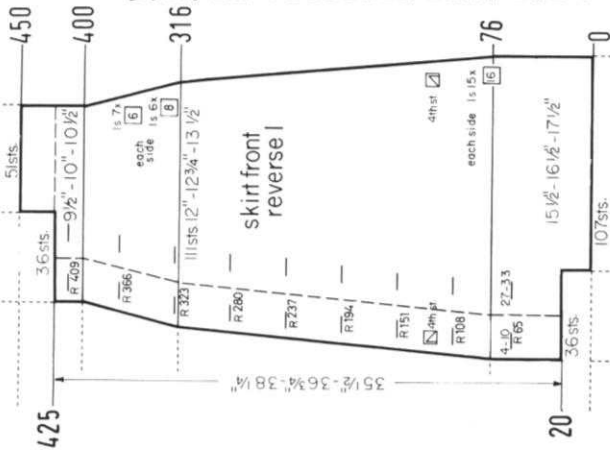
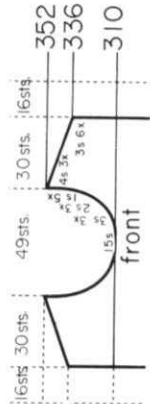

Work the second front section with reverse shapings, casting on front right to left. (Cam Box will be on the LEFT side at Row 0).

Make buttonholes after Rows in ( ). ON EACH SIDE, decrease 1 st. after Rows 76, 92, 108, (108), 124, 140, (151), 156, 172, 188, (194), 204, 220, 236, (237), 252, 268, (280), 284, 300, 316, (323), 324, 332, 340, 348, 356, 364, (366), 370, 376, 382, 388, 394, 400, (409), then knit to Row 425 and bind off 36 sts. ON CAM BOX SIDE: Knit to Row 450, then bind off the remaining 51 sts.

ROWS 21 to 65: Knit even, then work buttonholes over the 4th-10th and 27th-33rd sts. counting from the left side. Knit to Row 76.

ROWS 0 to 20: Knit even, then cast on 36 sts. ON OPPOSITE SIDE of CAM BOX. (Use a separate length of yarn). Cast on 107 sts. and work stockinette st.

Move the Cam Box to the left side, bring all needles into working position, turn the Row Counter back to 60 and complete the left side. Follow the instructions from \*\*, then after Row 80 bring all needles back into working position and bind off all 190 sts.

\*\*ON THE RIGHT SIDE (LEFT side for left half) increase 1 st. after Rows in ( ). Work Short Rows. ON OPPOSITE SIDE of CAM BOX put into holding position 133 needles (139 needles when working the left half) after Row 60; 5 needles after Rows 62, (63), 64, 66, (66), 68, (69), 70, 72, (72), 74, (75), 76, 78, (78). After Row 80 put the remaining 6 needles into holding position. Break the yarn.

\*ON EACH SIDE, increase 1 st. after Rows 12, 15, 18, 21, 24, 27, 30, 33, 36, 39, 42, 45, 48, 51, 54, 57 and 60, but do not knit after Row 60.

Cast on 144 sts., work stockinette st. and Short Rows. ON OPPOSITE SIDE of CAM BOX put into holding position 44 needles after Rows 0, 1. ON OPPOSITE SIDE of CAM BOX bring back into working position 11 needles after Rows 2, 3, 4, 5, 6, 7, 8, 9. After Row 10 all needles are back into working position.

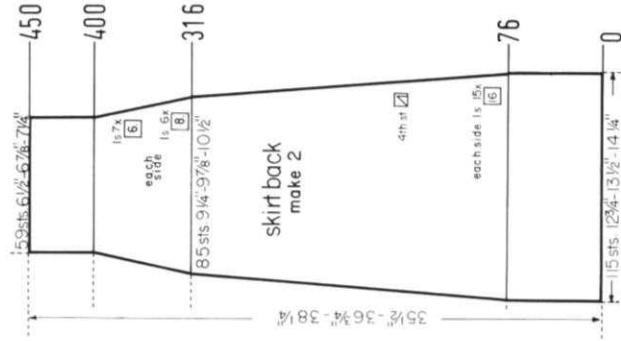
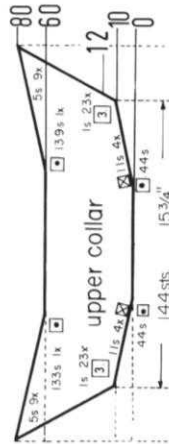

Cast on 144 sts. and work stockinette st. Turn the Row Counter to 10 and follow the instructions from\* of the upper collar. (Rows 10 to 80).

Work the second back section the same.

ON EACH SIDE, decrease 1 st. after Rows 76, 92, 108, 124, 140, 156, 172, 188, 204, 220, 236, 252, 268, 284, 300, 316, 324, 332, 340, 348, 356, 364, 370, 376, 382, 388, 394, 400, then knit to Row 450 and bind off the remaining 59 sts.

ROWS 0 to 76: Knit even.

Cast on 115 sts. and work stockinette st.



Cast on 149 sts. and work 60 rows K1, P1, Ribbing, then bind off all sts. the crocheted method for ribbing.

Move the Cam Box to the left side, turn the Row Counter back to 310 and complete the left half. Follow the instructions from\*.

ON CAM BOX SIDE, bind off 3 sts. after Rows 311, 313; 2 sts. after Rows 315, 317, 319; 1 st. after Rows 321, 323, 325, 327, 329. For SHOULDER bind off 3 sts. after Rows 336, 338, 340, 342, 344, 346; 4 sts. after Rows 348, 350, 352.

Work the front section the same as the back section to ROW 310, then bind off the center 15 sts., put the needles on the left side into holding position and complete the right half first.

Move the Cam Box to the left side, turn the Row Counter back to 336 and complete the left half. Follow the instructions from\*.

\*ON CAM BOX SIDE, bind off 3 sts. after Row 336 (EVEN ROWS = SHOULDER SHAPING), 337 (ODD ROWS = NECK SHAPING) 338, 339, 340, 341, 342; 2 sts. after Row 343; 3 sts. after Row 344; 2 sts. after Row 345; 3 sts. after Row 346; 2 sts. after Row 347; 4 sts. after Row 348; 2 sts. after Row 349; 4 sts. after Rows 350, 352.

ON CAM BOX SIDE, bind off 4 sts. after Row 256, 257; 3 sts. after Rows 258, 259; 2 sts. after Rows 260, 261, 262, 263, 264, 265; 1 st. after Rows 266, 267, 268, 269, 270, 271, then knit to Row 336, bind off the center 15 sts., holding the needles on the left side into half first. (For the FRONT SECTION knit to Row 310).

ON EACH SIDE, increase 1 st. after Rows 174, 186, 198, 210, 222, 234, then knit to Row 256.

ON EACH SIDE, decrease 1 st. after Rows 52, 60, 68, 76, 84, 92, 100, 108, 116, 124, 132, 140, 148, 156, then knit to Row 174.

ROWS 0 to 52: Knit even.

Cast on 157 sts. and work stockinette st.

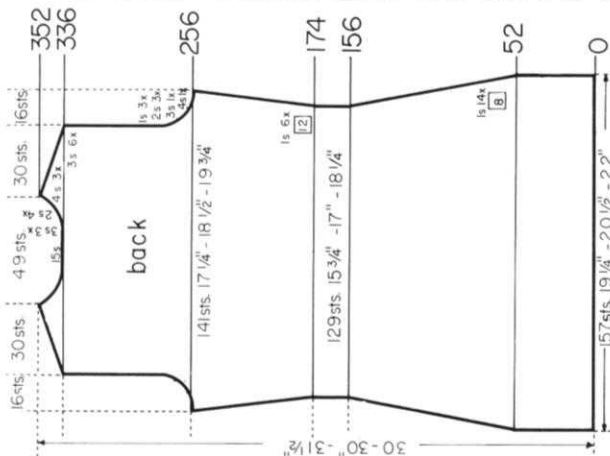

Work the second section with reverse shapings, casting on from right to left. (Cam Box will be on the LEFT side at Row 0).

Decrease 2 sts. for EACH DART after Row 336, then again after Rows in ( ), ON CAM BOX SIDE, decrease 1 st. after Rows 340, 348, (348), 356, (360), 364, 372, (372), then knit to Row 374 and work Short Rows. ON OPPOSITE SIDE of CAM BOX put into holding position 44 needles after Row 374; 3 needles after Rows 376, 378, 380, 382, 384, 386, 388. After Row 390 bring all needles back into working position, then knit to Row 428 and bind off the remaining 112 sts.

ON CAM BOX SIDE, bind off 4 sts. after Row 266 (EVEN ROWS = CENTER BACK SHAPING); 3 sts. after Row 267 (ODD ROWS = CENTER BACK SHAPING); 4 sts. after Row 268; 2 sts. after Row 269; 3 sts. after Row 270; 2 sts. after Row 271; 3 sts. after Row 272; 1 st. after Row 273; 2 sts. after Row 274; 1 st. after Row 275; 2 sts. after Row 276; 1 st. after Row 277; 2 sts. after Row 278; 1 st. after Row 279; 2 sts. after Row 280; 1 st. after Rows 281, 282, 283, 284, 286, 287, 288, 291, 292, 295, 296, 300, 304, 308, 316, 324, 332, then knit to Row 336.

ON OPPOSITE SIDE of CAM BOX increase 1 st. after Rows in ( ). ON CAM BOX SIDE increase 1 st. after Rows 136, (136), 142, 148, (148), 154, 160, (160), 166, 172, (172), 178, 184, (184), 190, 196, (196), 202, (206), 208, 214, (216), 220, 226, (226), 232, (236), 238, 244, (246), 250, 256, (256), 262, then knit to Row 266.

ON EACH SIDE, decrease 1 st. after Rows 38, 58, 78, 98, 118, then knit to Row 136.

ROWS 0 to 38: Knit even.

Cast on 167 sts. and work stockinette st.

ON CAM BOX SIDE, bind off 4 sts. after Rows 212, 213; 3 sts. after Rows 214, 215, 216, 217; 2 sts. after Rows 218, 219, 220, 221, 222, 223, 224, 225. ON EACH SIDE, hang the 1st st. onto the 2nd st. after Rows 226, 228, 230, 232, 234, 236, 238, 240, 242, 244, 246, 248, 250, 252, 254, 256, 258. ON CAM BOX SIDE, bind off 2 sts. after Rows 260, 261, 262, 263; 3 sts. after Rows 264, 265; 4 sts. after Rows 266, 267; 13 sts. after Row 268.

ON EACH SIDE, increase 1 st. after Rows 38, 46, 54, 62, 70, 78, 86, 94, 102, 110, 118, 126, 134, 142, 150, 158, 166, 174, 182, 190, 198, 206, then knit to Row 212.

ROWS 0 to 38: Knit even.

Cast on 61 sts. and work stockinette st.

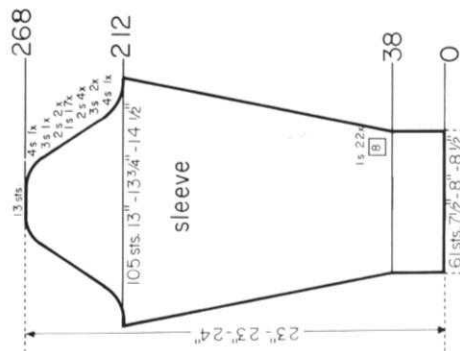

Move the Cam Box to the left side, turn the Row Counter back to 336 and complete the left half. Follow the instructions from\*.

\*ON CAM BOX SIDE, bind off 3 sts. after Row 336 (EVEN ROWS = SHOULDER SHAPING), 337 (ODD ROWS = NECK SHAPING) 338, 339, 340, 341, 342; 2 sts. after Row 343; 3 sts. after Row 344; 2 sts. after Row 345; 3 sts. after Row 346; 2 sts. after Row 347; 4 sts. after Row 348; 2 sts. after Row 349; 4 sts. after Rows 350, 352.

ON CAM BOX SIDE, bind off 4 sts. after Row 256, 257; 3 sts. after Rows 258, 259; 2 sts. after Rows 260, 261, 262, 263, 264, 265; 1 st. after Rows 266, 267, 268, 269, 270, 271, then knit to Row 336, bind off the center 15 sts., holding the needles on the left side into half first. (For the FRONT SECTION knit to Row 310).

ON EACH SIDE, increase 1 st. after Rows 174, 186, 198, 210, 222, 234, then knit to Row 256.

ON EACH SIDE, decrease 1 st. after Rows 52, 60, 68, 76, 84, 92, 100, 108, 116, 124, 132, 140, 148, 156, then knit to Row 174.

ROWS 0 to 52: Knit even.

Cast on 157 sts. and work stockinette st.

## DK 7990

SIZE 10 (Bust 32½"), SIZE 12: (Bust 34"), SIZE 14 (Bust 36"). MATERIAL: SIZE 10: 11-50 gr. balls KNITTING Crocus Crepe. TENSION: 6 to 8. GAUGE: 16 sts. 2", 21 rows 2". SIZE 12: 12-50 gr. balls KNITTING Excelsior. TENSION: 7 to 9. GAUGE: 15 sts. 2", 20 rows 2". SIZE 14: 10-50 gr. balls KNITTING Sonika Draion. TENSION: 7 to 9. GAUGE: 14 sts. 2", 19 rows 2". ALL SIZES: 6 yards matching trim. The instructions are the same for all sizes. PATTERN: Stockinette Stitch. DECREASES: After rows indicated, hang the 3rd st. on the appropriate sides onto the 2nd st., then move the end sts. inward to fill the empty needle. INCREASES: After rows indicated, move the 2 end sts. on the appropriate sides 1 needle outward, then place the 3rd st. from the row below onto the empty needle. FINISHED LENGTH: SIZE 10: 43", SIZE 12: 45", SIZE 14: 47½".

FINISHING: Block the sections. Weave the back sections together, 1 st. in from each edge. Join front and back sections at sides and shoulders. Turn under about ½" around armhole edges and hem to wrong side. Sew the trim around all edges. (See picture).



Continued on next page

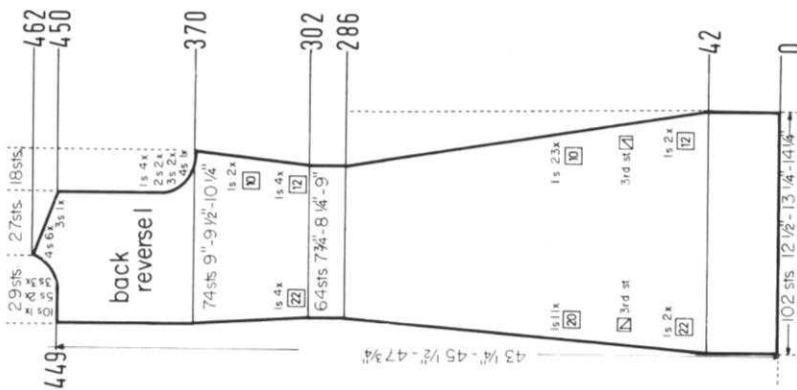

Work the second back section with reverse shapings, casting on from right to left. (Cam Box will be on the LEFT side at Row 0).

ON CAM BOX SIDE, bind off 10 sts. after Row 449 (ODD ROWS = NECK SHAPING); 3 sts. after Row 450 (EVEN ROWS = SHOULDER SHAPING); 5 sts. after Row 451; 4 sts. after Row 452; 5 sts. after Row 453; 4 sts. after Row 454; 3 sts. after Row 455; 4 sts. after Row 456; 3 sts. after Row 457; 4 sts. after Row 458; 3 sts. after Row 459; 4 sts. after Row 460, 462.

ON CAM BOX SIDE, bind off 4 sts. after Row 370; 3 sts. after Rows 372, 374; 2 sts. after Rows 376, 378; 1 st. after Rows 380, 382, 384, 386, then knit to Row 449.

ON OPPOSITE SIDE of CAM BOX increase 1 st. after Rows in ( ). ON CAM BOX SIDE increase 1 st. after Rows 302, (302), 314, (324), 326, 338, (346), 350, 360, (368), then knit to Row 370.

ON OPPOSITE SIDE of CAM BOX decreases 1 st. after Rows in ( ). ON CAM BOX SIDE decrease 1 st. after Rows 42 (42), 54, (64), 66, 76, 86, (96), 106, (106), 116, 126, (126), 136, 146, (146), 156, 166, (166), 176, 186, (186), 196, 206, (206), 216, 226, (226), 236, 246, (246), 256, 266, (266), 276, 286, (286), then knit to Row 302.

ROWS 0 to 42: Knit even.

Cast on 102 sts. and work stockinette st.



Cast on 167 sts. and work 42 rows K1, P1, Ribbing, then bind off all sts. the crochet method for ribbing.

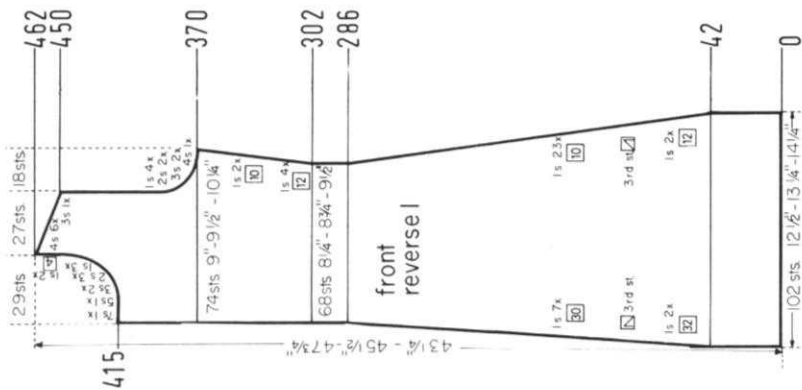

Work the second front section with reverse shapings, casting on from right to left. (Cam Box will be on the LEFT side at Row 0).

ON CAM BOX SIDE, bind off 7 sts. after Row 415; 5 sts. after Row 417; 3 sts. after Rows 419, 421; 2 sts. after Rows 423, 425, 427; 1 st. after Rows 429, 431, 433, 435, 439. For SHOULDER bind off 3 sts. after Row 450; 4 sts. after Rows 452, 454, 456, 458, 460, 462.

ON CAM BOX SIDE, bind off 4 sts. after Row 370; 3 sts. after Rows 372, 374; 2 sts. after Rows 376, 378; 1 st. after Rows 380, 382, 384, 386, then knit to Row 415.

ON CAM BOX SIDE, increase 1 st. after Rows 302, 314, 326, 338, 350, 360, then knit to Row 370.

ON OPPOSITE SIDE of CAM BOX decrease 1 st. after Rows in ( ). ON CAM BOX SIDE decrease 1 st. after Rows 42 (42), 54, 66, (74), 76, 86, 96, 106, (106), 116, 126, 136, (136), 146, 156, 166, (166), 176, 186, 196, (196), 206, 216, 226, (226), 236, 246, 256, (256), 266, 276, 286, (286), then knit to Row 302.

ROWS 0 to 42: Knit even.

Cast on 102 sts. and work stockinette st.



Cast on 197 sts. and work 84 rows Knit 1, Purl 3 Ribbing, then bind off all sts.

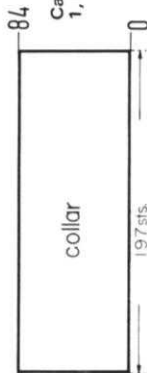

# DP 7998

SIZE 10 (Bust 32 1/2"-33"), SIZE 12 (Bust 34"-35"). MATERIAL: 9-50 gr. balls KNITTING Subita Crepe 2 x 3. SIZE 10: TENSION: 3 to 5. GAUGE: 19 sts. 2", 26 rows 2". SIZE 12: TENSION: 4 to 6. GAUGE: 18 sts. 2", 25 rows 2". The instructions are the same for both sizes. PATTERN: K1, P3, Ribbing according to Line Drawing. (3 sts. on the main machine and 1 st. on the ribber). The purl side is the right side. SLEEVE INCREASES: On each side, after rows indicated, place the end st. from the row below onto the next empty needle. When putting needles into holding position, transfer the appropriate ribber sts. to the main machine.

FINISHING: Join front and back section at sides and shoulders. Sew sleeves together and set in. Join short ends of collar, then sew 1 edge of collar to inside and 1 edge to outside of neckline.

# HP 3653

SIZE 38 (Chest 37"-38"), SIZE 40 (Chest 39"-40"). MATERIAL: 10-50 gr. balls KNITTING Subita Dralon 3 ply. TENSION: 5 to 7. GAUGE: 15 sts. 2", 38 rows 2". SIZE 40: 12-50 gr. balls KNITTING Subita Crepe 2 x 4. TENSION: 6 to 8. GAUGE: 14 sts. 2", 36 rows 2". The instructions are the same for both sizes. PATTERN: Holding Position Design according to Line Drawing. The purl side is the right side. KNITTING AM3 machines use Wheel W2 and push in the right Retractor Button. (When working the right half for the neck shaping, release the retractor button and bring the needles back into working position manually). EDGES: K1, P1, Ribbing. INCREASES: After rows indicated, on each side, place the end st. from the row below onto the next empty needle.

FINISHING: Block all sections. Join front and back section at sides and shoulders. Sew sleeves together and set in. Join short ends of collar, then sew 1 edge of collar to inside and 1 edge to outside of neckline.

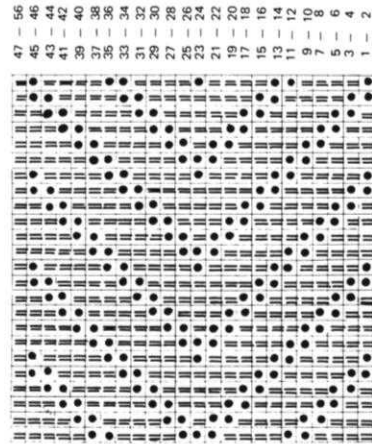

Bring the needles on the left side into working position, knit 1 row in PATTERN to the left side, turn the Row Counter back to 428 and complete the left half. Follow the instructions from\*.

\*ON CAM BOX SIDE, bind off 3 sts. after Row 431, 435, 439 (ODD ROWS = NECK SHAPING); 2 sts. after Rows 443, 447; 1 st. after Rows 451, 455, 459, 463; 2 sts. after Rows 464, 466 (EVEN ROWS = SHOULDER SHAPING); 1 st. after Row 467; 2 sts. after Rows 472, 474, 476, 478, 480; 3 sts. after Rows 482, 484, 486, 488, 490, 492.

Work the front section the same as the back section to Row 428, then bind off the center 9 sts., put the needles on the left side into holding position and complete the right half first.

Bring the needles on the left side into working position, knit 1 row in PATTERN to the left side, turn the Row Counter back to 470 and complete the left half. Follow the instructions from\*.

\*ON CAM BOX SIDE, bind off 2 sts. after Row 470 (EVEN ROWS = SHOULDER SHAPING); 3 sts. after Row 471 (ODD ROWS = NECK SHAPING); 2 sts. after Row 472; 3 sts. after Row 473; 2 sts. after Row 474; 3 sts. after Row 475; 2 sts. after Rows 476, 477, 478, 479, 480; 1 st. after Row 481; 3 sts. after Row 482; 1 st. after Row 483; 3 sts. after Row 484; 1 st. after Row 485; 3 sts. after Row 486; 1 st. after Row 487; 3 sts. after Row 488; 1 st. after Row 489; 3 sts. after Rows 490, 492.

ON CAM BOX SIDE, bind off 2 sts. after Rows 464, 465, 466, 467, 468, 469, then knit to Row 470, bind off the center 9 sts., put the needles on the left side into holding position and complete the right half first.

ON CAM BOX SIDE, bind off 4 sts. after Rows 306, 307; 3 sts. after Rows 310, 311, 314, 315; 2 sts. after Rows 318, 319, 322, 323; 1 st. after Rows 326, 327, 330, 331, 334, 335, then knit to Row 464. (For the FRONT SECTION knit to Row 428).

ROWS 27 to 306: Knit even.

ROWS 0 to 26: Knit even, then transfer the ribber sts. to the main machine and work the Holding Position Design.

Cast on 151 sts. and work K1, P1, Ribbing.

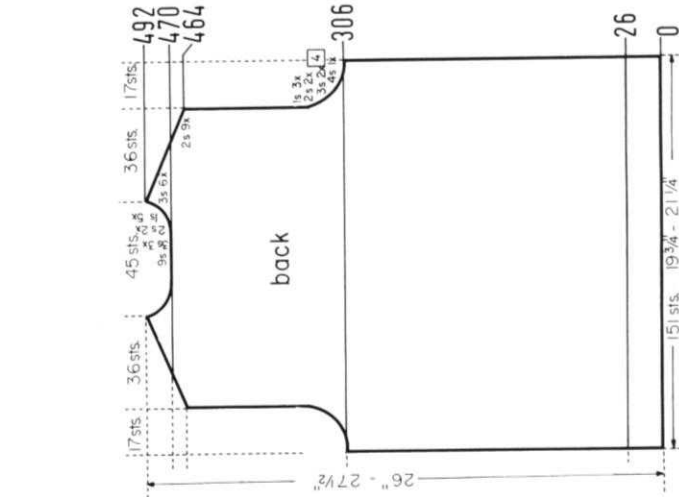
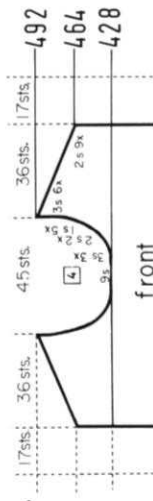

Bring the needles on the left side into working position, knit 1 row in PATTERN to the left side, turn the Row Counter back to 312 and complete the left half. Follow the instructions from\*.

\*ON CAM BOX SIDE, bind off 3 sts. after Row 312 (EVEN ROWS = SHOULDER SHAPING); 4 sts. after Row 313 (ODD ROWS = NECK SHAPING); 3 sts. after Row 314; 4 sts. after Rows 315, 316; 3 sts. after Row 317; 4 sts. after Row 318; 3 sts. after Row 319; 4 sts. after Row 320; 2 sts. after Row 321; 4 sts. after Row 322; 2 sts. after Row 323; 4 sts. after Row 324; 2 sts. after Row 325; 4 sts. after Row 326; 2 sts. after Row 327; 4 sts. after Row 328.

ON CAM BOX SIDE, bind off 4 sts. after Rows 218, 219; 3 sts. after Rows 220, 221, 222, 223; 2 sts. after Rows 224, 225, 226, 227; 1 st. after Rows 228, 229, 230, 231, 232, 233, 234, 235, 236, 237, then knit to Row 312, bind off the center 17 sts., put the needles on the left side into holding position and complete the right half first. (For the FRONT SECTION knit to Row 270).

ROWS 0 to 218: Knit even.

Cast on 167 sts. and work Knit 1, Purl 3 Ribbing.

Bring the needles on the left side into working position, knit 1 row in PATTERN to the left side, turn the Row Counter back to 270 and complete the left half. Follow the instructions from\*.

\*ON CAM BOX SIDE, bind off 4 sts. after Rows 271, 273; 3 sts. after Rows 275, 277; 2 sts. after Rows 279, 281; 1 st. after Rows 283, 285, 287, 289, 293, 297. For SHOULDER Bind off 3 sts. after Rows 312, 314; 4 sts. after Rows 316, 318, 320, 322, 324, 326, 328.

Work the front section the same as the back section to Row 270, then bind off the center 13 sts., put the needles on the left side into holding position and complete the right half first.

ON CAM BOX SIDE, bind off 4 sts. after Rows 218, 219, 220, 221; 3 sts. after Rows 222, 223, 224, 225, 226, 227; 2 sts. after Rows 228, 229, 230, 231. ON EACH SIDE, hang the 1st st. onto the 2nd st. after Rows 232, 234, 236, 238, 240, 242, 244, 246, 248, 250, 252, 254, 256, 258, 260, 262, 264, 266, 268. ON CAM BOX SIDE, bind off 2 sts. after Rows 270, 271; 3 sts. after Rows 272, 273, 274, 275; 4 sts. after Rows 276, 277, 278, 279; 13 sts. after Row 280.

ON EACH SIDE, increase 1 st. after Rows 8, 16, 24, 32, 40, 48, 56, 64, 72, 80, 88, 96, 104, 112, 120, 128, 136, 144, 152, 160, 168, 176, 182, 188, 194, 200, 206, 212, then knit to Row 218.

ROWS 0 to 8: Knit even.

Cast on 69 sts. and work Knit 1, Purl 3 Ribbing.

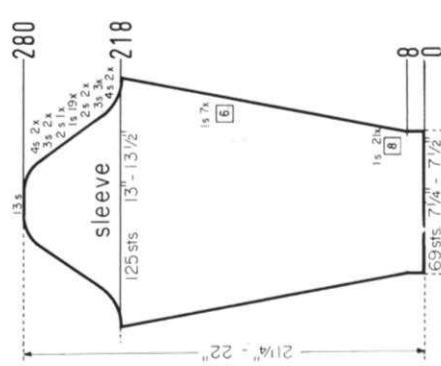
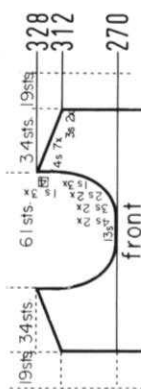
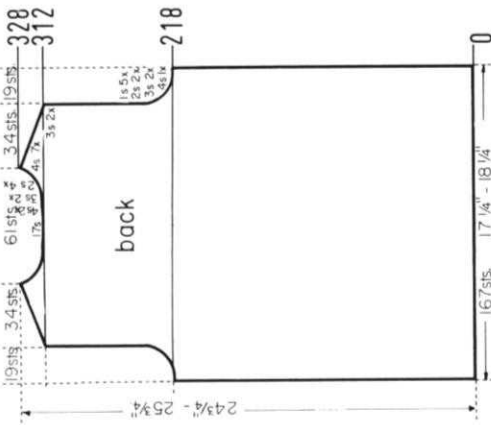

**SIZE 38** (Chest 37"-38"), **SIZE 40** (Chest 39"-40"), **SIZE 42** (Chest 42"-43"). **MATERIAL:** **SIZE 38:** 13-50 gr. balls KNOTTING Subita Crepe 2 x 3. **TENSION:** 4 to 6. **GAUGE:** 19 sts, 2", 24 rows 2". **SIZE 40:** 15-50 gr. balls KNOTTING Subita Crepe 2 x 4. **TENSION:** 5 to 7. **GAUGE 18** sts, 2", 23 rows 2". **SIZE 42:** 16-50 gr. balls KNOTTING Subita Crepe 2 x 4. **TENSION:** 6 to 8. **GAUGE:** 17 sts, 2", 22 rows 2". The instructions are the same for all sizes. **PATTERN:** K1, P3 Ribbing according to Line Drawing. (3 sts. on the main machine and 1 st. on the ribber). The puri side is the right side. **SLEEVE EDGES, COLLAR and BANDS:** K1, P1, Ribbing. **INCREASES:** After rows indicated, move the end st. on each side 1 needle outward, then place the 2nd st. from the row below onto the empty needle. When putting needles into holding position, transfer the appropriate ribber sts. to the main machine. Bind off the Collar and the bands the crochet method for ribbing.

**FINISHING:** Join front and back section at sides and shoulders. Sew sleeves together and set in. Join short ends of collar, then sew 1 edge of collar to inside and 1 edge to outside of neckline. Join shoulder band to front band, then sew band to right shoulder and down on right side of front. Sew on buttons. (See picture).



Cast on 183 sts. and work 54 rows K1, P1, Ribbing, then bind off all sts.

Bring the needles on the left side into working position, knit 1 row in PATTERN to the left side, turn the Row Counter back to 318 and complete the left half. Follow the instructions from\*.

\*ON CAM BOX SIDE bind off 4 sts. after Rows 318 (EVEN ROWS = SHOULDER SHAPING), 319 (ODD ROWS = NECK SHAPING), 320, 3 sts. after Row 321; 4 sts. after Row 322; 3 sts. after Row 323; 5 sts. after Row 324; 3 sts. after Row 325; 5 sts. after Row 326; 2 sts. after Row 327; 5 sts. after Row 328; 2 sts. after Row 329; 5 sts. after Row 330; 2 sts. after Row 331; 5 sts. after Row 332; 2 sts. after Row 333; 5 sts. after Rows 334, 336.

ON CAM BOX SIDE bind off 4 sts. after Rows 212, 213; 3 sts. after Rows 214, 215, 216, 217; 2 sts. after Rows 218, 219, 220, 221, 222, 223; 1 st. after Rows 224, 225, 226, 227, 228, 229, 230, 231, 232, 233, then knit to Row 318, bind off the center 19 sts., put the needles on the left side into holding position and complete the right half first. (For the FRONT SECTION knit to ROW 294).

ON EACH SIDE, increase 1 st. after Rows 96, 120, 144, 168, 192, then knit to Row 212.

ROWS 0 to 96: Knit even.  
Cast on 187 sts. and work K1, P3, Ribbing.

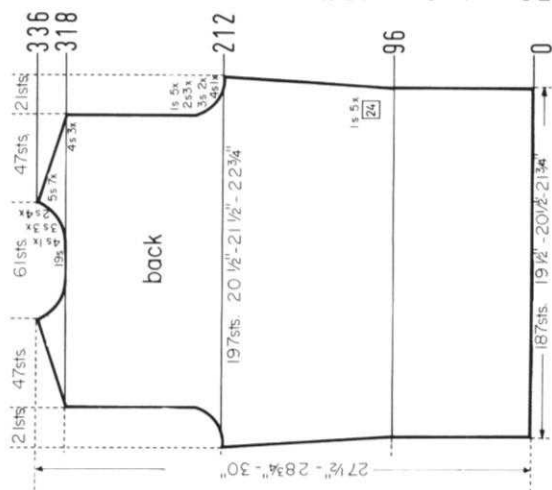

ON CAM BOX SIDE, bind off 4 sts. after Rows 322, 323; 3 sts. after Rows 326, 327, 330, 331, 334, 335; 2 sts. after Rows 338, 339, 342, 343; 1 st. after Rows 346, 347; 2 sts. after Rows 350, 351; 1 st. after Rows 354, 355; 2 sts. after Rows 358, 359; 1 st. after Rows 362, 363; 2 sts. after Rows 366, 367; 1 st. after Rows 370, 371; 2 sts. after Rows 374, 375; 1 st. after Rows 378, 379; 2 sts. after Rows 382, 383; 1 st. after Rows 386, 387; 2 sts. after Rows 390, 391; 1 st. after Rows 394, 395; 2 sts. after Rows 398, 399; 1 st. after Rows 402, 403; 2 sts. after Rows 406, 407; 3 sts. after Rows 410, 411, 414, 415; 4 sts. after Rows 418, 419; 13 sts. after Row 422.

ON EACH SIDE, increase 1 st. after Rows 26, 40, 54, 68, 82, 96, 110, 124, 138, 152, 166, 180, 194, 208, 222, 236, 250, 262, 274, 286, 298, 310, then knit to Row 322.

ROWS 0 to 26: Knit even, then transfer the ribber sts. to the main machine and work the Holding Position Design.

Cast on 71 sts. and work K1, P1, Ribbing.

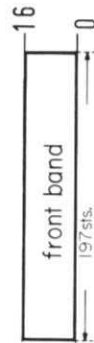
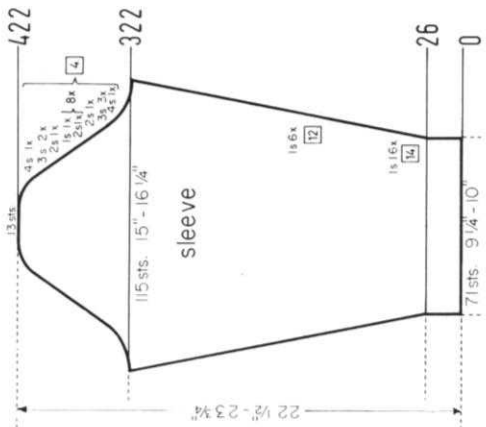

Cast on 197 sts. and work 16 rows K1, P1, Ribbing, then bind off all sts.



Cast on 41 sts. and work 16 rows K1, P1, Ribbing, then bind off all sts.

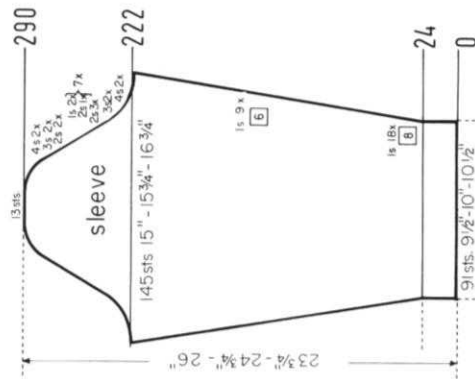

ON CAM BOX SIDE bind off 4 sts. after Rows 222, 223, 224, 225; 3 sts. after Rows 226, 227, 228, 229; 2 sts. after Rows 230, 231, 232, 233, 234, 235, 236, 237; 1 st. after Rows 238, 239, 240, 241; 2 sts. after Rows 242, 243; 1 st. after Rows 244, 245, 246, 247; 2 sts. after Rows 248, 249; 1 st. after Rows 250, 251, 252, 253; 2 sts. after Rows 254, 255; 1 st. after Rows 256, 257, 258, 259; 2 sts. after Rows 260, 261; 1 st. after Rows 262, 263, 264, 265; 2 sts. after Rows 266, 267; 1 st. after Rows 268, 269, 270, 271; 2 sts. after Rows 272, 273; 1 st. after Rows 274, 275, 276, 277; 2 sts. after Rows 278, 279, 280, 281; 3 sts. after Rows 282, 283, 284, 285; 4 sts. after Rows 286, 287, 288, 289; 13 sts. after Rows 290.

ON EACH SIDE increase 1 st. after Rows 24, 32, 40, 48, 56, 64, 72, 80, 88, 96, 104, 112, 120, 128, 136, 144, 152, 160, 168, 174, 180, 186, 192, 198, 204, 210, 216, then knit to Row 222.

ROWS 0 to 24: Knit even, then transfer the appropriate ribber sts. to the main machine and work K1, P3, Ribbing.

Cast on 91 sts. and work K1, P1, Ribbing.

# MK 5326

**SIZE:** 12 (Chest 29"-30"). **MATERIAL:** 7-50 gr. balls KNITTING Amore. **TENSION:** 7 to 9. **GAUGE:** Stockinette Stitch 15 sts. 2", 23 rows 2"; Pattern Stitch 15 sts. 2", 28 rows 2". **PATTERN:** BODICE: Stockinette Stitch worn on the knit side; YOKE and UPPER SLEEVES: K1, P3 Ribbing (3 sts. on the main machine and 1 st. on the ribber) worn on the purl side. The Gate Cam Release Lever of the ribber is placed at the needle heels. Follow the Line Drawing to set up the pattern. To turn the knitting, knit several rows with contrast waste yarn, then remove the knitting from the machine (knit 1 row without yarn), turn the knitting over, then hang the garment sts. back onto the machine. Remove waste yarn and turn the Row Counter back to the proper row. When putting needles in holding position, transfer the ribber sts. to the main machine. **EDGES:** K1, P1, Ribbing. **INCREASES:** After rows indicated, move the 2 end sts. on each side 1 needle outward, then place the 3rd st. from the row below onto the empty needle. **FINISHING:** Block all sections. Join front and back section at sides and right shoulder. Join 1" of left shoulder, turn under a small amount on remaining shoulder edges and hem to wrong side. Sew sleeves together and set in. Sew neckband to neckline. Close the shoulder opening with 4 loops and 4 buttons. For the belt, work a twisted cord using 10 strands of yarn. (See Practical Knitting Hints Book, Page 58)



Bring the needles on the left side into working position, knit 1 row in PATTERN to the left side, turn the Row Counter back to 294 and complete the left half. Follow the instructions from\*.

\*ON CAM BOX SIDE bind off 3 sts. after Rows 295, 297 (ODD ROWS = NECK SHAPING); 2 sts. after Rows 299, 301, 303; 1 st. after Rows 305, 307, 309, 311, 313, 317; 4 sts. after Rows 318, 320 (EVEN ROWS = SHOULDER SHAPING); 1 st. after Row 321; 4 sts. after Row 322; 5 sts. after Row 324; 1 st. after Row 325; 5 sts. after Rows 326, 328; 1 st. after Row 329; 5 sts. after Rows 330, 332, 334, 336.

Work the front section the same as the back section to Row 294, then bind off the Center 19 sts., put the needles on the left side into holding position and complete the right half first.

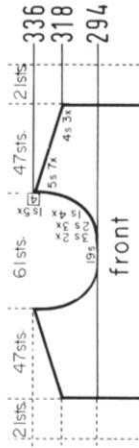

Bring the needles on the left side into working position, knit 1 row in PATTERN to the left side, turn the Row Counter back to 226 and complete the left half. Follow the instructions from\*.

\*ON CAM BOX SIDE, bind off 3 sts. after Rows 227, 229; 2 sts. after Rows 231, 233; 1 st. after Rows 235, 337, 239, 241. For SHOULDER bind off 3 sts. after Rows 244, 246, 248, 250, 252, 254, 256, 258; 4 sts. after Row 260.

Work the front section the same as the back section to ROW 226, then bind off the center 11 sts., put the needles on the left side into holding position and complete the right half first.

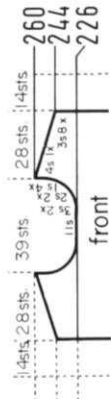

ON CAM BOX SIDE, bind off 4 sts. after Rows 184, 185, 188, 189; 3 sts. after Rows 192, 193; 2 sts. after Rows 196, 197, 200, 201; 1 st. after Rows 204, 205; 2 sts. after Rows 208, 209; 1 st. after Rows 212, 213; 2 sts. after Rows 216, 217; 1 st. after Rows 220, 221; 2 sts. after Rows 224, 225; 1 st. after Rows 228, 229; 2 sts. after Rows 232, 233; 3 sts. after Rows 236, 237, 240, 241; 4 sts. after Rows 244, 245; 13 sts. after Row 248.

ON EACH SIDE, increase 1 st. after Rows 28, 40, 52, 64, 76, 88, 100, 112, 124, 136, 148, 160, 172, then knit to Row 184, turn the knitting, transfer the appropriate sts. to the ribber, place the Gate Cam Release Lever of the ribber to the needle heels and work the K1, P3 Pattern.

ROWS 0 to 28: Knit even, then change to stockinette st. Cast on 61 sts. and work K1, P1, Ribbing.

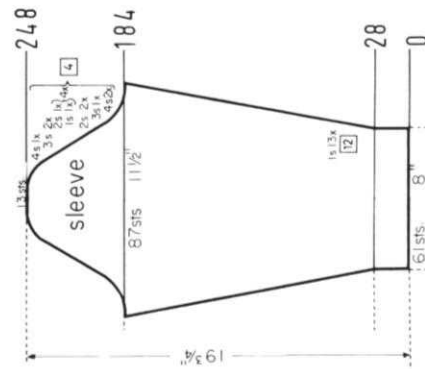

Bring the needles on the left side into working position, knit 1 row in PATTERN to the left side, turn the Row Counter back to 244 and complete the left half. Follow the instructions from\*.

\*ON CAM BOX SIDE, bind off 3 sts. after Rows 244 (EVEN ROWS = SHOULDER SHAPING), 245 (ODD ROWS = NECK SHAPING), 246, 247, 248; 2 sts. after Row 249; 3 sts. after Row 250; 2 sts. after Row 251; 3 sts. after Row 252; 2 sts. after Row 253; 3 sts. after Row 254; 2 sts. after Row 255; 3 sts. after Rows 256, 258; 4 sts. after Row 260.

ON CAM BOX SIDE, bind off 4 sts. after Rows 154, 155; 3 sts. after Rows 158, 159, 162, 163; 2 sts. after Rows 166, 167; 1 st. after Rows 170, 171, 174, 175, then knit to Row 244, bind off the center 11 sts., put the needles on the left side into holding position and complete the right half first. (For the FRONT SECTION knit to Row 226).

ROWS 17 to 154: Knit even, then turn the knitting, transfer the appropriate sts. to the ribber, place the Gate Cam Release Lever of the ribber to the needle heels and work the K1, P3 Pattern.

ROWS 0 to 16: Knit even, then change to stockinette st.

Cast on 123 sts. and work K1, P1, Ribbing.

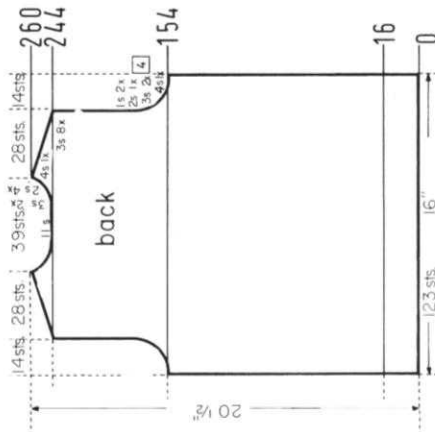

Cast on 115 sts. and work 16 rows K1, P1, Ribbing, then bind off all sts. the crochet method for ribbing.



# MK 5324

**SIZE** 4 (Chest 23"-24"). **MATERIAL:** 5-50 gr. balls KNITTING Crocus Crepe. **TENSION:** 7 to 9. **Gauge:** Pattern Stitch 17 sts. 2", 22 rows 2". **PATTERN:** Stockinette Stitch with Cable Design and latched up sts. according to Line Drawing. **EDGES:** K1, P1, Ribbing. Before crossing the sts. let the appropriate sts. (black squares on Line Drawing) slide off the needles, cross the sts., then bring the empty needles back into working position. After each 30 to 40 rows latch up the dropped sts. into knit sts.

**FINISHING:** Join front and back section at sides and shoulders. Sew sleeves together and set in. Sew neckband to neckline. Work 1 row of single crochet around the front opening, then sew in a zipper.

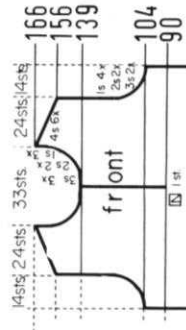
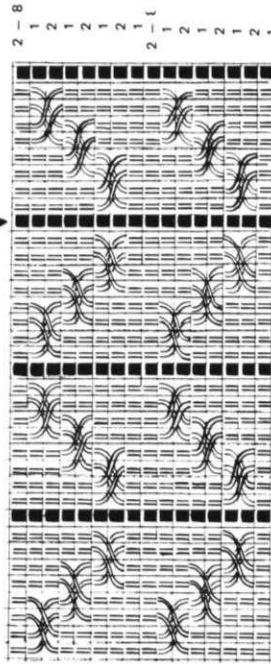

# MK 5323

**SIZE** 3-4 (Chest 22"-23"). **MATERIAL:** 5-50 gr. balls Color 1 and 1-50 gr. ball Color 2 KNITTING Subtle Crepe 2 x 3. **TENSION:** 3 to 5. **Gauge** 18 sts. 2", 25 rows 2". **PATTERN:** SKIRT: Stockinette Stitch and Short Rows. The Skirt is knitted sideways. **PULLOVER:** Stockinette Stitch and a Norwegian Design according to Line Drawing. In the directions, each row in the Norwegian Design is counted as 1 row, but several movements of the Cam Box are needed to complete 1 row. **EDGES:** K1, P1, Ribbing. **INCREASES:** After rows indicated, move the 2 end sts. on each side 1 needle outward, then place the 3rd st. from the row below onto the empty needle.

**FINISHING:** Block all sections. **PULLOVER:** Join front and back section at sides. Sew 1" on each shoulder together, turn under a small amount on the remainder of the shoulder edges and hem to wrong side. Sew 1 edge of back neckband to inside and 1 edge to outside of back neckline. Sew the front neckband to front neckline in the same manner. Work 3 loops and sew 3 buttons to each shoulder opening. **SKIRT:** Weave together the sts. held on contrast yarn. Remove contrast yarn. Turn under 15 sts. on lower edge and 1" on upper edge and hem to wrong side. Insert an elastic band into upper hem.

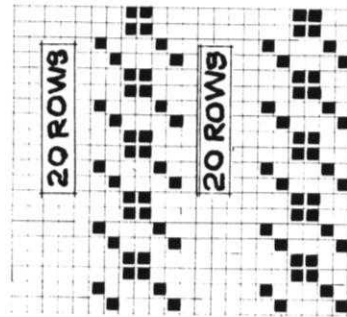

**ON CAM BOX SIDE,** bind off 3 sts. after Rows 118, 119, 120, 121, 122, 123, 127, 128, 129. **ON EACH SIDE,** hang the 1st st. onto the 2nd st. after Rows 130, 132, 134, 136, 138, 140, 142, 144, 146. **ON CAM BOX SIDE** bind off 2 sts. after Rows 148, 149; 4 sts. after Row 150, 151, 152, 153; 11 sts. after Row 154.

**ON CAM BOX SIDE,** increase 1 st. after Rows 30, 31, 44, 45, 58, 59, 70, 71, 82, 83, 94, 95, 106, 107, then knit to Row 118.

**ROWS 0 to 30:** Knit even, then transfer the ribber sts. to the main machine and work the Cable Design. Cross the sts. the first time after Row 32.

Cast on 65 sts. and work K1, P1, Ribbing.

Move the Cam Box to the left side, turn the Row Counter back to 90 and complete the left half. Follow the instructions from\*.

**ON CAM BOX SIDE,** bind off 3 sts. after Rows 139, 141, 143; 2 sts. after Rows 145, 147; 1 st. after Rows 149, 151, 153. For **SHOULDER** bind off 4 sts. after Rows 156, 158, 160, 162, 164, 166.

**ON CAM BOX SIDE,** bind off 3 sts. after Rows 104, 106; 2 sts. after Rows 108, 110; 1 st. after Rows 112, 114, 116, 118, then knit to Row 139.

\***ROWS 91 to 104:** Knit even.

Work the front section the same as the back section to Row 90, then hang the center st. onto the neighboring needle, put the needles on the left side into holding position and complete the right half first.



Cast on 99 sts. and work 16 rows K1, P1, Ribbing, then bind off all sts.



Cast on 67 sts. with Color 1 and work 20 rows K1, P1, Ribbing, then bind off all sts. the crochet method for ribbing.

Move the Cam Box to the left side, turn the Row Counter back to 156 and complete the left half. Follow the instructions from\*.

\***ON CAM BOX SIDE,** bind off 4 sts. after Rows 156 (EVEN ROWS = **SHOULDER SHAPING**), 157 (ODD ROWS = **NECK SHAPING**), 158, 159, 160; 3 sts. after Row 161; 4 sts. after Rows 162, 164, 166.

**ON CAM BOX SIDE,** bind off 3 sts. after Rows 104, 105, 106, 107; 2 sts. after Rows 108, 109, 110, 111; 1 st. after Rows 112, 113, 114, 115, 116, 117, 118, 119, then knit to Row 156, bind off the center 11 sts., put the needles on the left side into holding position and complete the right half first.

**ROWS 21 to 104:** Knit even. (For the **FRONT SECTION** knit even to Row 90).

**ROWS 0 to 20:** Knit even, then transfer the ribber sts. to the main machine and work the Cable Design. Cross the sts. the first time after Row 22.

Cast on 109 sts. and work K1, P1, Ribbing.

Repeat **ROWS -0 to 62-9** x more, ending the **LAST** repeat after Row 61 with the Cam Box on the **LEFT** side. (The missing row will be made up when weaving the skirt together). Knit several rows with contrast waste yarn, then remove the knitting from the machine.

**Work Short Rows. ON OPPOSITE SIDE** of CAM BOX put into holding position 67 needles after Row 16. Knit 2 rows. **ON OPPOSITE SIDE** of CAM BOX bring back into working position 7 needles after Rows 18, 20, 22, 24, 26, 28, 30. (18 needles remain in hold). **ON OPPOSITE SIDE** of CAM BOX put 7 needles into holding position after Rows 32, 34, 36, 38, 40, 42, 44. After Row 46 bring all 67 needles back into working position, then knit even to Row 62.

**ROWS 0 to 16:** Knit even.

Cast on 97 sts. with contrast waste yarn, knit several rows ending with the Cam Box on the right side. Turn the Row Counter to 0 and change to garment yarn.

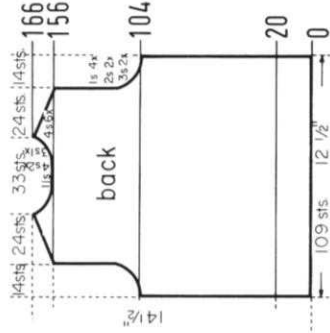

Cast on 39 sts. with Color 1 and work 20 rows K1, P1, Ribbing, then bind off all sts. the crochet method for ribbing.

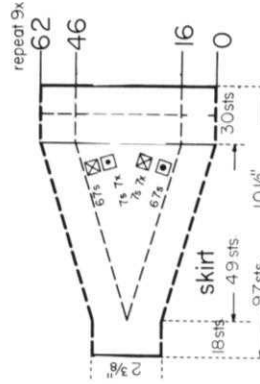





Move the Cam Box to the left side, turn the Row Counter back to 152 and complete the left half. Follow the instructions from\*.

\*ON CAM BOX SIDE, bind off 4 sts. after Row 152 (EVEN ROWS = SHOULDER SHAPING); 3 sts. after Row 153 (ODD ROWS = NECK SHAPING); 4 sts. after Row 154; 3 sts. after Row 155; 4 sts. after Row 156; 2 sts. after Row 157; 4 sts. after Row 158; 2 sts. after Row 159; 4 sts. after Row 160; 5 sts. after Row 162.

ON CAM BOX SIDE, bind off 3 sts. after Rows 96, 97, 98, 99; 2 sts. after Rows 100, 101, 102, 103; 1 st. after Rows 104, 105, 106, 107, 108, 109, then knit to Row 152, bind off the center 15 sts., put the needles on the left side into holding position and complete the right half first. (For the FRONT SECTION knit to Row 136).

ROWS 17 to 96: Knit even.

ROWS 0 to 16: Knit even, then change to stockinette st. and work the Norwegian Design.

Cast on 111 sts. with Color 1 and work K1, P1, Ribbing.

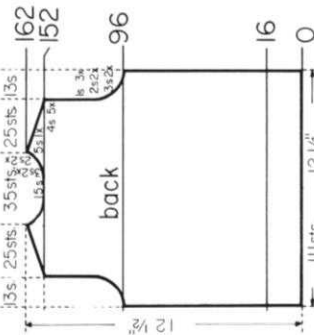

## KK 5325

SIZE 8 (Chest 25"-26"), SIZE 10 (Chest 27"-28").  
 MATERIAL: SIZE 8: 5-50 gr. balls Color 1 and 2-50 gr. balls Color 2 KNITTING Double Knitting.  
 TENSION: 8 to 9. GAUGE: 14 sts. 2", 19 rows 2".  
 SIZE 10: 6-50 gr. balls Color 1 and 3-50 gr. balls Color 2 KNITTING Double Knitting. TENSION 9 to 10. GAUGE: 13 sts. 2", 18 rows 2".  
 The instructions are the same for both sizes. PATERN: Stockinette Stitch with Color Stripes as marked in the diagrams. EDGES: K1, P1, Ribbing. INCREASES: After row indicated, move the 2 end sts. on each side 1 needle outward, then place the 3rd st. from the row below onto the empty needle.

FINISHING: Block all sections. Join front and back section at sides and shoulders. Sew sleeves together and set in. Join short ends of collar, then sew 1 edge of collar to inside and 1 edge to outside of neckline.

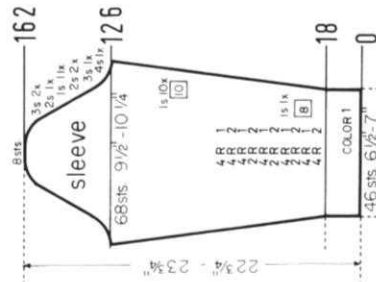

ON CAM BOX SIDE, bind off 4 sts. after Rows 126, 127; 3 sts. after Rows 128, 129; 2 sts. after Rows 130, 131, 132, 133. ON EACH SIDE, hang the 1st st. onto the 2nd st. after Rows 134, 136, 138, 140, 142, 144, 146, 148, 150, 152, 154. ON CAM BOX SIDE, bind off 2 sts. after Rows 156, 157; 3 sts. after Rows 158, 159, 160, 161; 8 sts. after Row 162.

ON EACH SIDE, increase 1 st. after Rows 18, 26, 36, 46, 56, 66, 76, 86, 96, 106, 116, then knit to Row 126.

ROWS 0 to 18: Knit even, then change to stockinette st. and work the striped pattern as marked in the diagram.

Cast on 46 sts. with color 1 and work K1, P1, Ribbing.

ON CAM BOX SIDE, bind off 3 sts. after Rows 116, 117, 118, 119; 2 sts. after Rows 120, 121, 122, 123, 124, 125. ON EACH SIDE, hang the 1st st. onto the 2nd st. after Rows 126, 128, 130, 132, 134, 136, 138, 140, 142. ON CAM BOX SIDE, bind off 2 sts. after Rows 144, 145, 146, 147; 3 sts. after Rows 148, 149; 4 sts. after Rows 150, 151; 11 sts. after Row 152.

ON EACH SIDE, increase 1 st. after Rows 26, 36, 46, 56, 66, 76, 86, 96, 106, then knit to Row 116.

ROWS 0 to 26: Knit even, then change to stockinette st. and work the Norwegian Design.

Cast on 57 sts. with Color 1 and work K1, P1, Ribbing.

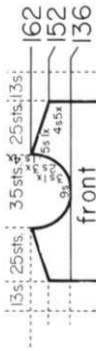

Move the Cam Box to the left side, turn the Row Counter back to 180 and complete the left half. Follow the instructions from\*.

\*ON CAM BOX SIDE, bind off 3 sts. after Rows 180 (EVEN ROWS = SHOULDER SHAPING); 181 (ODD ROWS = NECK SHAPING); 4 sts. after Row 182; 3 sts. after Row 183; 4 sts. after Row 184; 2 sts. after Row 185; 4 sts. after Row 186; 2 sts. after Row 187; 4 sts. after Rows 188, 190.

ON CAM BOX SIDE, bind off 3 sts. after Rows 126, 127, 128, 129; 2 sts. after Rows 130, 131; 1 st. after Rows 132, 133, 134, 135, 136, 137, then knit to Row 180, bind off the center 11 sts., put the needles on the left side into holding position and complete right half first. (For the FRONT SECTION knit to Row 170).

ROWS 19 to 126: Knit even.

ROWS 0 to 18: Knit even, then change to stockinette st. and work the striped pattern as marked in the diagram.

Cast on 99 sts. with color 1 and work K1, P1, Ribbing.

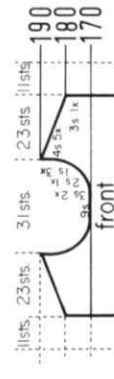

Move the Cam Box to the left side, turn the Row Counter back to 136 and complete the left half. Follow the instructions from\*.

\*ON CAM BOX SIDE, bind off 3 sts. after Row 137 (ODD ROWS = NECK SHAPING); 2 sts. after Rows 139, 141, 143; 1 st. after Rows 145, 147, 149, 151. For SHOULDER bind off 4 sts. after Rows 152, 154, 156, 158, 160; 5 sts. after Row 162.

Work the front section the same as the back section to Row 136, then bind off the center 9 sts., put the needles on the left side into holding position and complete the right half first.

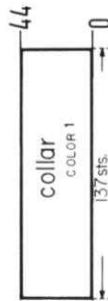

Cast on 137 sts. with color 1 and work 44 rows K1, P1, Ribbing, then bind off all sts. the crochet method of ribbing.

Move the Cam Box to the left side, turn the Row Counter back to 170 and complete the left half. Follow the instructions from\*.

\*ON CAM BOX SIDE, bind off 3 sts. after Rows 171, 173 (ODD ROWS = NECK SHAPING); 2 sts. after Row 175; 1 st. after Rows 177, 179; 3 sts. after Row 180 (EVEN ROWS = SHOULDER SHAPING); 1 st. after Row 181; 4 sts. after Rows 182, 184, 186, 188, 190.

Work the front section the same as the back section to Row 170, then bind off the center 9 sts., put the needles on the left side into holding position and complete the right half first.

SIZE 12 (Chest 30"-31"). MATERIAL: 4-50 gr. balls Color 1 and 3-50 gr. balls Color 2 KNOTTING Sonika Dralon. TENSION: 7 to 9. GAUGE: Pattern Stitch 14 sts. 2", 27 rows 2". PATTERN: 2 Color Holding Position Design according to Line Drawing, or use JAC 40 and Pattern No. 43. The knit side is the right side. EDGES: K1, P1, Ribbing.

FINISHING: Join front and back section at sides and shoulders. Sew sleeves together and set in. Sew 1 edge of collar to inside and 1 edge to outside of neckline. Sew 1 edge of buttonhole band to inside and 1 edge to outside of left front opening edge and collar edge. Sew buttonband to left side in the same manner. Finish buttonholes, sew on buttons.



Bring the needles on the left side into working position, knit 1 row in PATTERN to the left side, turn the Row Counter back to 278 and complete the left half. Follow the instructions from\*.

\*ON CAM BOX SIDE, bind off 3 sts. after Rows 278 (EVEN ROWS = SHOULDER SHAPING), 279 (ODD ROWS = NECK SHAPING), 280, 281, 282; 2 sts. after Row 283; 3 sts. after Row 284; 2 sts. after Row 285; 3 sts. after Row 286; 2 sts. after Row 287; 3 sts. after Rows 288, 290, 292, 294.

ON CAM BOX SIDE, bind off 3 sts. after Rows 186, 187, 190, 191; 2 sts. after Rows 194, 195, 198, 199; 1 st. after Rows 202, 203, 206, 207, then knit to Row 278, bind off the center 15 sts., put the needles on the left side into holding position and complete the right half first.

ROWS 25 to 186: Knit even.

ROWS 0 to 24: Knit even, then transfer the ribber sts. to the main machine and work the Holding Position Design.

Cast on 117 sts. with Color 1 and work K1, P1, Ribbing.

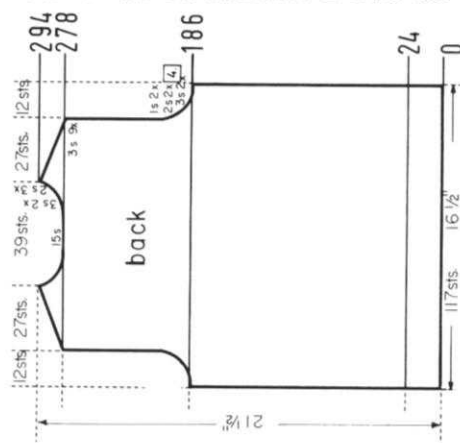

Bring the needles on the left side into working position, knit 1 row in PATTERN to the left side, turn the Row Counter back to 170 and complete the left half. Follow the instructions from\*.

ON CAM BOX SIDE, bind off 3 sts. after Row 257; 2 sts. after Rows 259, 261; 1 st. after Rows 263, 265, 267, 269, 271, 273, 275, 277. For SHOULDER, bind off 3 sts. after Rows 278, 280, 282, 284, 286, 288, 290, 292, 294.

ON CAM BOX SIDE, bind off 3 sts. after Rows 186, 190; 2 sts. after Rows 194, 198; 1 st. after Rows 202, 206, then knit to Row 257.

\*ROWS 171 to 186: Knit even. ROWS 25 to 170: Knit even, then bind off the center 9 sts., put the needles on the left side into holding position and complete the right half first.

ROWS 0 to 24: Knit even, then transfer the ribber sts. to the main machine and work the Holding Position Design.

Cast on 117 sts. with Color 1 and work K1, P1, Ribbing.

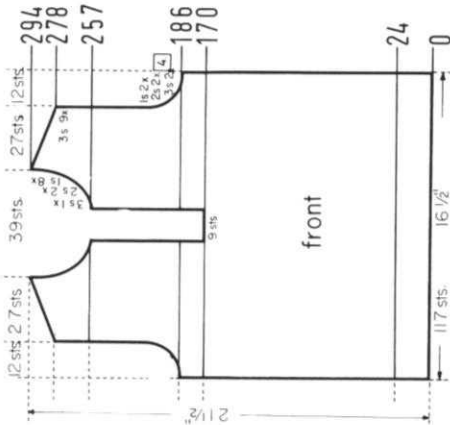

Cast on 73 sts. with Color 1 and work K1, P1, Ribbing. Make buttonholes after Rows 8 and 24 over the 9th-13th, 27th-31st, 45th-49th and 63rd-67th sts. counting from the left side. After Row 32 bind off all sts. Work the Button Band the same, but omit the buttonholes.

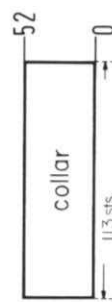

ON CAM BOX SIDE, bind off 3 sts. after Rows 208, 209, 212, 213; 2 sts. after Rows 216, 217, 220, 221, 224, 225, 228, 229, 232, 233, 236, 237, 240, 241, 244, 245, 248, 249, 252, 253, 256, 257, 260, 261, 264, 265; 3 sts. after Rows 268, 269, 272, 273; 8 sts. after Row 276.

ON CAM BOX SIDE, increase 1 st. after Rows 24, 25, 38, 39, 52, 53, 66, 67, 80, 81, 94, 95, 108, 109, 122, 123, 136, 137, 150, 151, 164, 165, 178, 179, 192, 193, then knit to Row 208.

ROWS 0 to 24: Knit even, then transfer the ribber sts. to the main machine and work the Holding Position Design.

Cast on 58 sts. with Color 1 and work K1, P1, Ribbing.

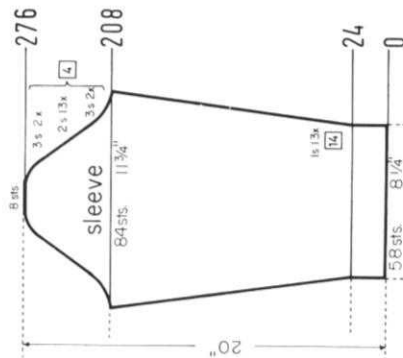

# jac40 is a must

for fast easy knitting of  
Jaquard and Ski-sweater  
designs

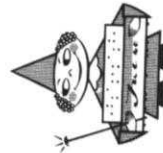
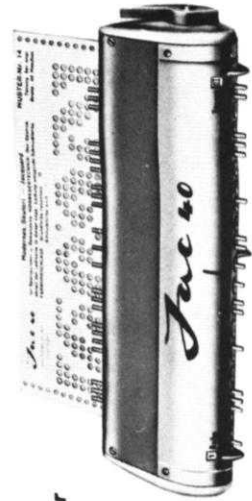

# KG 1927 BRIDAL GROUP

**MATERIAL:** Crochet Cotton No. 30 in colors of your choice (large ball will make 2 dresses). Dolls: 10½ to 11" for Bride and Bridesmaids; 9" for Jr. Bridesmaid; 6" for Flower Girl. Small amounts of Taffeta for slips. **TENSION:** 1 to 3. **GAUGE:** 14 sts., 40 rows 2" in Pattern stitch.

**FINISHING:** Spray all pieces with spray starch, pin out on ironing board and cover with piece of old sheet and press till dry. Sew back seams of all skirts with an overcast stitch so seams will be flat. Sew skirt to bodice of Flower Girl dress, easing to fit and with skirt seam at back. Sew ¼" for shoulder width on Bridesmaid dresses. Sew Skirt of Brides dress to bodice, forming a small pleat each side of hip and making a deep pleat on each side of back seam (to cover seam). Single crochet around arm-holes, necklines and back openings, pulling in if necessary. Sew tiny snaps to back openings and cover with bead for button. Sew Pearls down back of Brides bodice. Run thread elastic (doubled) around waistline of Bridesmaid dresses and tie in to fit. Trim all dresses as shown in Photograph, using ¼" ribbon for sashes and headbands. Cut Veil for Bride and attach to flower headpiece and sew sequin and bead to center, then attach to head with pin. Pin flower headpieces to head of Bridesmaids. Make Taffeta slips (strapless) for each doll, making sure bodice fits snugly. Use tiny snaps for closure on slips.

**BRIDES DRESS: PATTERN:** \*Put 4th, then every 4th needle into holding position, knit 4 rows. Return all needles to work. Put 2nd, then every 4th needle into holding position, knit 4 rows. Return all needles to work and REPEAT from \* for Pattern. (KNITTING machine owners may use Wheel No. 3).

**SKIRT:** Cast on 87 sts. Knit in Pattern to Row 128, then bind off all sts. the crochet method.

**BODICE:** Cast on 15 sts. Knit 2 rows stockinette st., put Counter at 0 and continue in Pattern. Knit 8 rows. Increase 1 st. beginning next 2 rows and again ON EACH SIDE every 4th row 4 x more. (25 sts.) Cast on 3 sts. beginning next 10 rows (55 sts.). Knit even to Row 48. Put 23 needles on the left side into holding position, bind off the center 9 sts. for neck and work the right side first. (Watch Pattern and set needles by hand). \*Knit even to Row 58. After Rows 59 and 61, cast on 3 sts. (neck-side). Bind off 3 sts. after Rows 62, 64, 66, 68, 70. Decrease 1 st. after Rows 74, 78, 82, 86, 90, then knit even to Row 100 (9 sts.) Knit 2 rows stockinette

stitch over all needles and bind off the crochet method. Complete the left side, following instructions from \* and remember to keep in pattern and make increases for neck on EVEN Row numbers and decreases for Sleeve and Bodice on ODD Row numbers.

**FLOWER GIRL (6" doll), PATTERN**  
Stitch for Skirt: \*Put the 2nd, then every 2nd needle into holding position, knit 4 rows. Put all needles in work knit 4 rows. Put the 1st, then every 2nd needle into holding position, knit 4 rows. All needles in work, knit 4 rows. REPEAT from \* for Pattern. (KNITTING machine owners may use Wheel No. 6).

**SKIRT:** Cast on 61 sts. Knit 8 rows stockinette st. with Tension 1, Change to Tension 2 and continue in Pattern. After Row 16, hang each cast on st. back onto machine behind the latches (2 sts. on each needle) to form the hem. Knit in Pattern to Row 96. Bind off tightly the crochet method.

**BODICE:** Stockinette stitch with Tension 1. Cast on 13 sts. Knit 4 rows. In-

crease 1 st. beginning next 6 rows. Cast on 2 sts. beginning next 2 rows. Knit 8 rows. Put 8 needles opposite Cam Box into holding position beginning next 2 rows. Bind off the center 7 sts. for neck and put all needles on the RIGHT side into holding position while you complete the left side. Knit 1 row to the left. \*Put 1 needle opposite Cam Box (neck side) into holding position and again every other row 5 x more. Bring all needles into work, knit 2 rows. Put 6 needles opposite Cam Box into holding position and knit 2 rows over 2 needles. Bring 1 needle back into work every other row till all are in work. Knit 2 rows ending with Cam Box on the right side. Cast on 2 sts. neck edge and again on the following 2nd row. Knit 4 rows. Bind off 2 sts. arm side, then decrease 1 st. arm side every 2nd row 3 x. Knit 4 rows and bind off the crochet method. Put Cam Box on the right side and follow instructions from \* reversing the sides for shaping.

**BRIDESMAID:** Instructions for 9" doll, with 10½" to 11" doll in ( ). **PATTERN:** \*Put the 3rd, then every 3rd needle into holding position, knit 2 rows. All needles in work, knit 2 rows. REPEAT from \* for Pattern. (KNITTING machine owners may use Wheel No. 4).

**SKIRT:** Cast on 57 (69) sts. Knit in Pattern to Row 80 (120) Knit several rows using contrast waste cotton and remove work from machine.

**BODICE:** Hang the sts. of Skirt section back onto 36 (44) needles, doubling the 2 rows stockinette stitch then Put Counter at 0 and continue in Pattern to Row 16 (24). ON EACH SIDE, hang the 10th st. on 9th needle (11th on 10th), put all but the 9 (10) needles on the right side into holding position and knit the right back (set pattern by hand and watch to be sure you keep in pattern). \*Knit to Row 32 (40), then bind off the crochet method. Put center 16 (22) needles into work, Row Counter back to 16 (24) and follow instructions from \*. Put the last 9 (10) needles into work, Counter to 16 (24) and REPEAT from \*.

**HEADPIECE for Bride and Bridesmaids.** Cast on 36 sts. Knit 2 rows. Put the 1st, then every 6th needle into holding position and knit 7 rows. All needles in work, knit 2 rows. Break cotton leaving a long end. Tie this end to cast on end up close to knitting, then thread tapestry needle with long end and take each st. off onto cotton. Pull up and tie into flower shape.

The Bridal Group . . . . Displayed in our Los Angeles Store for sometime, customers have repeatedly asked for the patterns . . . so here you are . . . . Knit up the complete Bridal Party to surprise your daughter or granddaughter. All dresses are knitted with Coats and Clarks Crochet Cotton No. 30. (We do not sell it).





# knitking

*Offers Complete Service To The Machine Knitter . . .*



**KNITKING KNITTING MACHINES** — The finest and most versatile automatic knitters available anywhere in the world — KNITKING is the worlds most honored machine with five gold medals for excellence. KNITKING Push-Button knitters produce a range of patterns and knit a variety of yarns unequalled by other machines.

**KNITKING MAGAZINE** — Without a doubt the finest Knitting machine magazine in the English language published anywhere in the world. Twenty original patterns in each issue and for all members of the family. Stylish designs photographed on world famous models. High fashion garments, handsome sweaters, sports outfits, baby clothes, plus accessories and knitting machine hints. All available to you in KNITKING MAGAZINE.

**KNITKING YARNS** — We searched the world over for the finest yarns obtainable and one look inside our catalogue will prove that we found them. A complete range of beautiful crepe machine washable 100% wool yarns . . . luxurious mohairs . . . handsome tweeds . . . pretty mixtures and luscious synthetics that are machine washable . . . easy to care for . . . and yet, can be knitted into the most glamorous of garments.

If you want your garments to look as good as those in KNITKING MAGAZINE and keep their appearance through dozens of washes, you must knit them with gorgeous KNITKING yarns. KNITKING yarns are the finest quality obtainable anywhere and the prices cannot be beaten. Try them once and you will always use them.

---

Send \$1.00 for LARGE COMPLETE YARN CATALOGUE  
(Refunded on your first \$10.00 order) to:

**KNITKING YARNS, Dept. 19**  
1128 Crenshaw Boulevard  
Los Angeles, California 90019



# KNITTING NEWS

September/October, 1971

## OUR READERS WRITE

Mrs. Mikel Shilling of Montrose, Colorado ( and others) have written requesting help in putting together garments that have extra rows knitted in the bodice of the front section in place of Bust Darts... so here we go...

## EASING the FULLNESS at the BUSTLINE

Sometimes we use Short Rows for bustline darts in our KNITTING MAGAZINE Patterns, but other times we use the method where we knit extra rows on the front section, then EASE these extra rows into the back section when putting the garment together. This method is used when a garment has a Pattern Stitch or a Ribbed Design because it is easier than knitting Short Rows when working a design. It is important that you put the EASE into the proper place and that you do not bunch up the extra rows in too small a space. The extra rows must be eased at the bustline and NOT under the arms. We will use the Dress DK 7982 in this issue of KNITTING MAGAZINE as an example and tell you how to ease the 10 extra rows on the front section into the back section.

Block the sections of your Dress before putting it together. Remember that the front section is 10 rows longer than the back and make sure you block it that way. When the garment sections are dry, and with wrong sides of pieces together, pin the sides beginning at the top armhole edge (we weave our sections together from the right side, so we put the wrong sides together). Match the rows and pin from the armhole down approximately 1 1/2" to 2 1/2" below the armhole. If a person has a small high bustline, pin it for 1 1/2"... for a full bust, pin for 2 1/2". The depth of a bust dart is usually between 3/4" to 2"...so measure down 1" to 2" from your last pin and put a pin on the back section ONLY. Now begin at the bottom of your garment and pin the sections together from the bottom on up to the pin on the back section. Match the rows carefully and do not stretch the pieces. When you have reached the pin on the back section, you should have 10 extra rows on the front section to EASE into the area between the back pin and the pin that is holding the two sections together above. Thread a tapestry needle (we prefer to use the double eyed ribber transfer needle) with the yarn that you will use for weaving. You can thread it with a fairly long strand of yarn. Begin to weave from just below the fullness for the bustline, taking one pin out at a time, and working up to the armhole, (hint... allow half or more of your strand of yarn to hang free so that you can pick it up and weave the other way later) easing the 10 extra rows between the pin on the back section and the first pin above the fullness, by going under 2 rows on the front section instead of 1 as needed. When you have reached the armhole, secure the yarn on the wrong side and cut off. Now pick up the strand you left hanging at the beginning and thread it into your needle, then weave down to the bottom of the dress, matching the rows and the stripes.

If you want to know more about weaving your garments together and Bustline Darts, please refer to our "Practical Knitting Hints" book, pages 18, 19, and 29.

## NECK SHAPING WITH NORWEGIAN DESIGNS

When working the Neckline shaping on a Norwegian Design garment, we tell you to bind off the center stitches, then to put the needles on the left side into holding position. When knitting a Norwegian Design, you can knit both halves at the same time. Use separate balls of yarn for each side. Each time you set up the needles for the right side, set up the needles for the left side too. Lay the yarn for the right side over the needles, then lay the yarn from the separate ball over the left side needles. (Fasten yarn on the right yarn fastener for the first two rows). Hold both ends of yarn in your hand and slide the Cam Box over the needle bed. Return the Cam Box for the second step. Set up the needles on both sides, lay the second color over the right side needles, then using a separate ball, lay the yarn over the left side needles. Again, hold both ends of yarn in your hand and knit all the way across. When the row is completed, and the Cam Box is on the left side, make the necessary bind-offs for the left shoulder and right half of the neckline. After the following row is completed and the Cam Box is on the right side, make the necessary bind-offs on the right shoulder and left half of the neckline. When working the neckline shaping in this manner, the knitting time is cut in half. The same method of working both sides at the same time can be used when knitting garments in a Holding Position Design using two colors. Use separate balls of yarn for each side.

## TRIM for COAT DK 7990

For CROCUS and EXCELSIOR: Tension 5 to 7. Bring into working position 11 needles, then push the 4th and 8th needle back to the out of work position. Cast on over the remaining 9 needles. Knit 2 rows. \*Bring the center needle of each group of 3 into holding position, and knit 6 rows. Return all needles to working position, knit 2 rows. REPEAT from \* for approximately as long as you need, then take off onto contrast yarn so that you may rip back if too long.

For SONIKA DRALON: Tension 5 or 6. Cast on 7 sts. over every other needle. Knit 2 rows, then \*Put the 2nd, 4th, 6th needles into holding position and knit 6 rows. Return all needles to working position, knit 2 rows. REPEAT from \* for approximately as long as you need, then take the sts. off onto contrast yarn so that you may rip back if too long.

We have many requests for Trims, so we are including 2 more... have fun...!!

BUBBLE ROPE TRIM - Tension 4 with KNITTING Subita Crepe 2 x 3. Pull the knitting down to form into rope.

Bring 11 needles into working position, then put back to the out of work position, the 4th and the 8th needle. Cast on over the remaining 9 needles. \*Bring the center needle of each group of

3 into holding position, knit 4 rows. Return all needles to working position, knit 2 rows. Put needles 3, 4, 6, 7 into holding position, knit 4 rows. Return all needles to working position, knit 2 rows. REPEAT from \* for as long as you need.

ECCENTRICITY TRIM - Tension 4 with KNITKING Subita Crepe 2 x 3. Either side can be the right side.

Cast on 10 stitches, knit 2 rows. \*Put 6 needles on the left side into holding position, knit 8 rows over 4 needles on the right. Return 5 end needles on the left side to working position, knit 3 rows. Put 6 needles on the right side into holding position, knit 8 rows over 4 needles on the left. Return 5 end needles on the right to working position, knit 3 rows. REPEAT from \* for as long as you want.

#### LOS ANGELES COUNTY FAIR

On September 17th, the Los Angeles County Fair starts its 17 day run and as usual, we will have a gorgeous display of KNITKING garments in our large booth (it's in the Home Building). Dresses.. Coats... Suits... Sweaters... Pants... Childrens garments, etc., and the lovely Afghan we refer to in the Letter from the Publisher in this issue.

If you can be one of the more than million people that will visit the Fair, be sure to drop by and say "Hello"..! We always look forward to seeing old friends and making new ones.

#### STITCH AND ROW CALCULATOR

We still have the \$4.95 Stitch and Row Calculator free to all subscribers who place a two year subscription (\$12.00 in U.S. - \$14.00 in Canada, but Canadian subscribers have to place their subscriptions direct with the head office in Los Angeles as the Calculator is not available in Canada).

If you already have a subscription that has not expired, you can extend it for an additional two years by sending \$12.00 to KNITKING MAGAZINE, 1128 Crenshaw Blvd., Los Angeles California, 90019 and you will automatically receive the Calculator. If you have subscribed since July 1st of this year you can obtain a Calculator by sending in an additional \$6.00 stating that you wish to extend your subscription and obtain the Calculator free.

#### KNITKING PATTERN STITCH CARDS

Every owner of an AM 3 KNITKING should have a set of KNITKING Pattern Stitch Cards (they are illustrated on the inside front Cover of this magazine). Buy them now (until October 31st) and save \$2.00. Special price \$7.50 (California residents add 5% Sales Tax)... plus 95¢ mailing costs.

#### PRICE FREEZE and the IMPORT SURTAX

President Nixon really put the 'Cat among the Pigeons' when he announced on August 15th, his plans for balancing the economy....

A re-evaluation of the American Dollar - German Mark - and the Japanese Yen will undoubtedly result in an increase in the price of imports.... Couple the re-evaluation of currency with a 10% import surtax (which may or may not be taken off at the end of the 90 day period) and our costs for imported goods could increase as much as 20%.

While present stocks last, we will not increase the prices, but it does seem that price increases on imported Home Knitting Machines (there are no Home Knitting Machines made in the U.S.A) and accessories are inevitable...

All KNITKING MAGAZINE subscribers recently received an announcement of our 'Special Summer Sale' and the low, low prices on our machines, accessories and yarns... If you are considering the purchase of any of our products, we urge you to do it now, because it does not seem that the low prices can be repeated in the future.

## **ARE YOU UNHAPPY WITH YOUR PRESENT KNITTING MACHINE ?**

**DOES IT REFUSE TO KNIT FANCY DRESS YARNS?**

**DOES IT JAM UP WHEN YOU TRY TO KNIT LOOPED MOHAIR OR THICK AND THIN YARNS?**

**DOES IT DROP STITCHES ALL OVER THE PLACE?**

**ARE YOU CONTINUALLY HAVING TROUBLE WITH AWKWARD, CUMBERSOME WEIGHTS?**

**ARE YOU UNABLE TO MAKE A LARGE GARMENT WITH BULKY YARNS?**

**DO YOU HAVE TO SELECT PATTERN STITCHES MANUALLY?**

**DO YOU HAVE TO LATCH YOUR RIBBING BY HAND?**

**IF YOU ARE HAVING ANY OF THESE PROBLEMS YOU SHOULD TRADE UP TO A NEW FANTASTIC PUSH BUTTON KNITKING WITH COORDINATED RIBBER AND ENJOY KNITTING WITH THE WORLDS FINEST, MOST VERSATILE AND MOST AUTOMATIC KNITTER.**

**YOU WILL BE SURPRISED AT OUR GENEROUS TRADE-IN ALLOWANCE AND YOU CAN, IF YOU WISH, USE YOUR PRESENT MACHINE AS A DOWN-PAYMENT AND PURCHASE A COMPLETE KNITKING FOR JUST PENNIES A DAY. WRITE TODAY FOR FULL INFORMATION AND TELL US WHAT MACHINE YOU NOW OWN. THE ADDRESS IS:**

**KNITKING, Dept. T-1, 1128 Crenshaw Blvd., Los Angeles, Calif. - 90019**

# NOTES TO KNIT BY . . .

## STITCH AND ROW GAUGE

KNIT A SAMPLE SWATCH . . . before you begin to knit any garment . . . for this is the MOST IMPORTANT STEP toward the correct size and the proper fit of any garment you wish to make. You MUST use the SAME YARN for your sample swatch that you will use to knit your garment and your sample swatch must be knitted large enough and using several different tension numbers on your machine. When you have done this, then you can determine the number of stitches and the number of rows in a two-inch measure. KNITTING MAGAZINE PATTERNS give you 3 tensions to try and one of them should give you the correct stitch and row gauge if you are using the yarn we recommend or a similar weight yarn. Here is the way to make your sample swatch.

Cast on over a sufficient number of needles to produce a swatch at least 4 inches wide. (If the pattern calls for 16 stitches to 2", then  $16 \times 2 = 32$  stitches to cast on). Now knit 4 inches of rows at the first suggested tension number. (If the pattern calls for 22 rows to 2",  $22 \times 2 = 44$  rows to knit). Knit 2 rows using a contrast color, change to the next higher tension and with garment yarn knit another 4", knit 2 rows with contrast color, change to the 3rd higher tension and knit another 4" and then bind off.



Roll the swatch into a cylinder over its length and pull on both ends, unroll it and stretch it diagonally by pulling on the four corners. Allow the swatch to rest and settle (preferably overnight) and then using a stitch gauge or a ruler, count the number of stitches over a 2" width, then the number of rows over a 2" length in EACH of the 3 tensions. Select the tension number that produces the stitches and rows called for in the pattern. If none of them are correct, you are most likely using the wrong weight of yarn.



## READING OF CHARTS

You will notice the instructions start at the bottom of the Chart and work UP. Follow the charts exactly as written and providing your sample stitch and row gauge is correct, your garment will come out the right size. Please remember that the section of garment as it is knitted on the machine, faces the same way as the Charts are in this magazine. Where two front pieces are needed, (or any other part of a garment that needs two sections) only one section is normally shown and the second section is usually made with reverse shapings. Set in sleeves are usually identical, but raglan sleeves have to be knitted with reverse shapings for the second sleeve.

## READING OF SYMBOLS

To simplify Pattern Knitting, we use Symbols in the Line Drawings and the Chart Diagrams. In the Line Drawings the symbols are shown and are to be read as you look at them while knitting a garment. For instance, if

a Purl stitch faces you, the Purl stitch Symbol  is shown; if a knit stitch faces you (as when using the Ribber) then this Symbol  is shown. The Symbol  at the top of the Line Drawing is the center of the garment section and you use this as a guide for setting up the needles.

The following Symbols    are used for Eyelet Designs in the Line Drawings and also for Full Fashion shaping on the Charts. The Line Drawings have row numbers on the right side. Missing Row numbers are always knitted straight or plain.

In Holding Position Designs  selected needles are pushed into holding position for the stated number of rows. The numbers of rows appear at the right of the Line Drawings; Example: 1-4 means knit Rows 1 to 4; 5 to 7 means knit Rows 5 to 7, etc. This same Symbol is also shown on the Charts and is used for putting needles into holding position for Short Rows. The

Symbol  on the Charts is used to put needles back into working position when knitting Short Rows.

A number in a box stands for the number of rows to be knitted between shapings. Make shapings first, then knit the necessary number of rows. If for instance it reads:

1 st. 8 x

 6

1 st. 10 x

 8

As you will be reading the instructions from the bottom up, here is the way you will follow them: . . . Decrease or increase (depending on the direction of the garment outline) 1 st. at the row where the shaping begins, then knit 8 rows, make the next decrease, then knit 8 rows, until you have decreased (or increased) 1 st. 10 x and you have knitted 8 rows after each decrease (or increase) (1 st. 10 x + 8 rows 10 x). Now begin the first decrease (or increase) for the shaping (which has to be made 8 x) in every 6th row. Decrease (or increase) 1 st. first, then knit 6 rows until you have decreased 1 st. 6 x and after each decrease (or increase) have knitted 6 rows (1 st. 8 x + 6 rows 8 x).

Where shapings are given without a boxed number as on most armholes, necklines, etc., make the shapings on every second row (on each side of course).

(See below for more Pattern Stitch Symbols.)

### PATTERN STITCH SYMBOLS



= knit stitch



= purl stitch



= empty needle (leave in working position)



= needle not used (in the out of work position)



= needle in the holding position



= Needles back into working position.



= 2 stitches on 1 needle - either transferred from the right side or the left side, then put the needle into holding position



= needle holding 2 stitches. Stitch has been transferred from the LEFT



= needle holding 2 stitches. Stitch has been transferred from the RIGHT



= 3 stitches on 1 needle. The 1st and 3rd stitch in a group of 3 needles has been hung on the 2nd or center needle.



= Center of Garment Section.



= Number of rows to be knitted between shapings.

The diagrams (Line Drawings) for pattern work are followed just as they are shown and are to be read as you look at them while knitting the garment.

open darts



closed darts



*Available in many wood finishes*



## **KNITTING DESK . . .**

A knitting machine cabinet that automatically lifts your machine into the knitting position just by pulling a lever. The cabinet converts in seconds into a handsome desk suitable for any decor or any room in your house. Beautifully made in a variety of woods by craftsmen in West Germany.



Order from your local dealer or direct from **KNITKING**, 1128 Crenshaw Blvd., Los Angeles, California 90019