

11-3-  
**knitking**

*magazine*

march/april '75

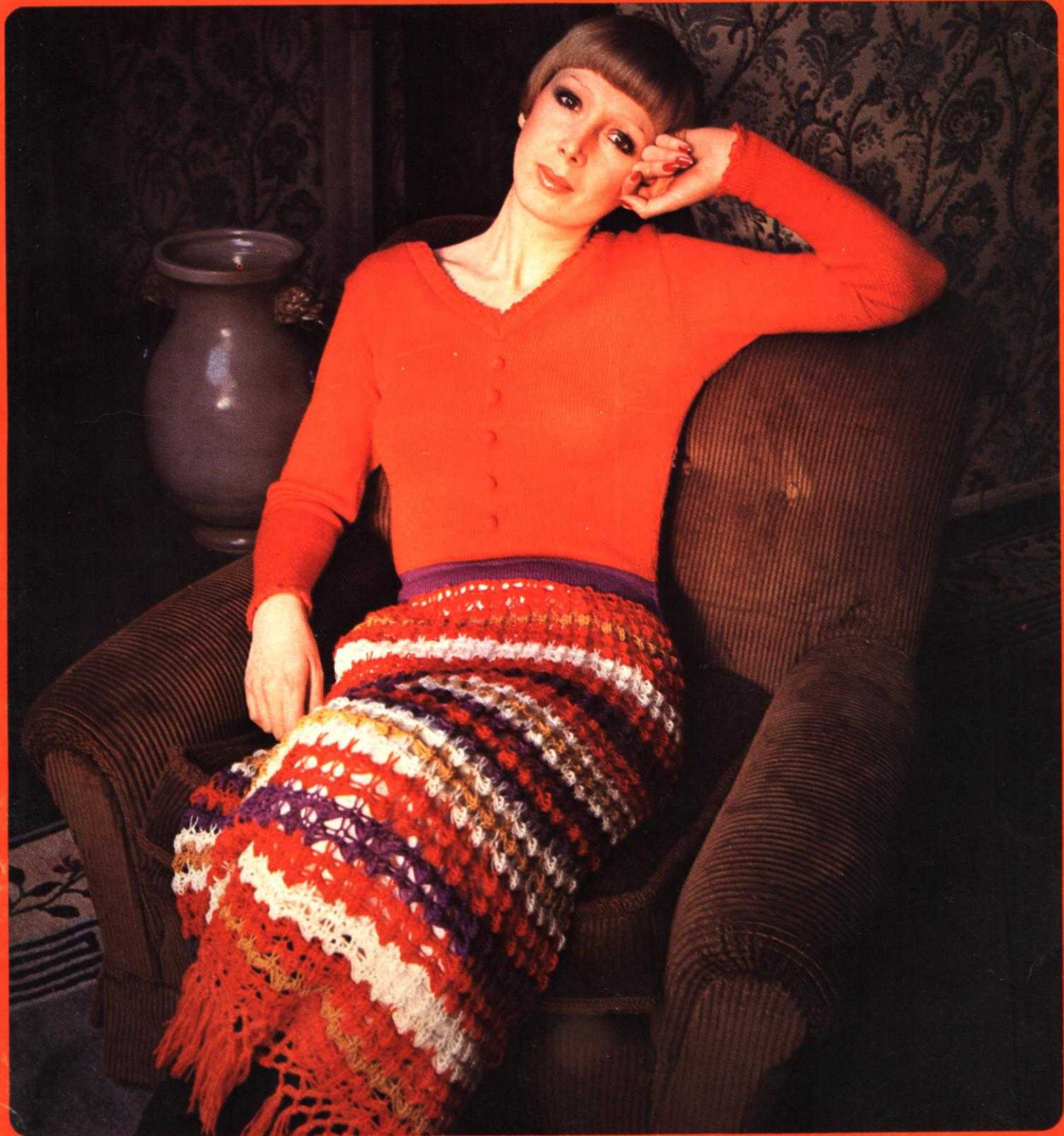







DK 45  
DK 46  
DK 47

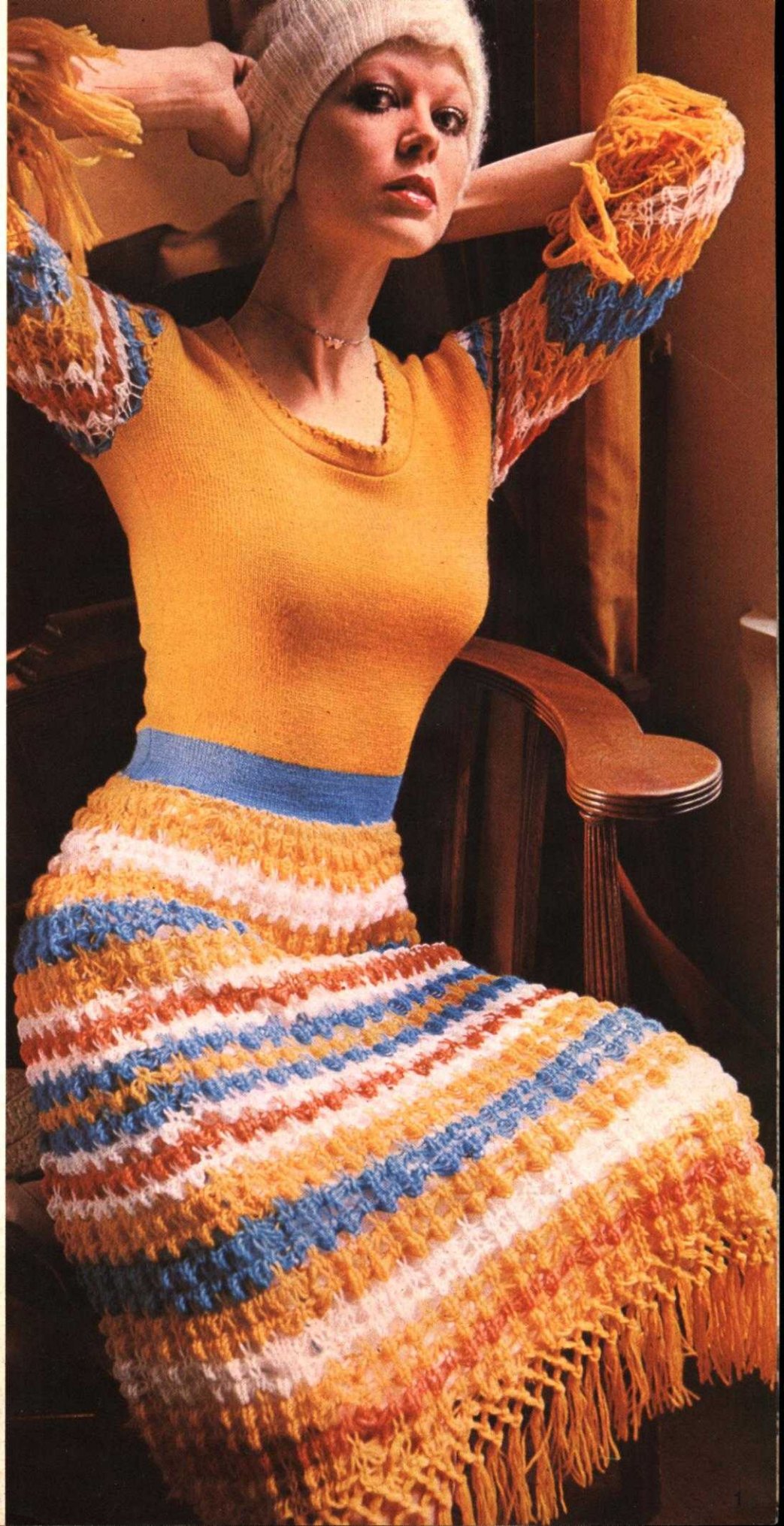





DK42

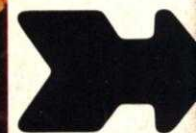
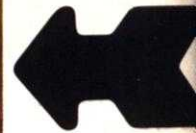

DK33

DK34









  
DK48  
DK49











DK50



DK44







DK37

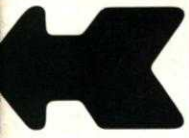

DK35





DK40



DK36









  
DK 41





# KnitKING News

## PRACTICAL KNITTING HINTS

### SELECTING NEEDLES FOR HOLDING POSITION DESIGNS

A number of Patterns in this issue of KNITKING MAGAZINE are made with out of work needles and a Holding Position Design. Because of the unusual spacing of the needles for these Patterns, it is necessary to select the needles by hand, or if you own a KNITKING Machine, you can use the Adjustable Needle Selector in the following manner.

Our example will be DK 31 in this issue. Begin as follows:

Bring 164 needles into working position and using the Line Drawing as your guide, start on the left edge and push every 4th needle back to the out of work position. Cast on over the remaining needles.

Look at the Line Drawing and you will see that every 8th needle is placed in holding position, so beginning with the first Pin on the Adjustable Needle Selector, push it to the opposite side, then push every 8th pin out in the same way. There will be 5 pins ready for selecting the needles.

Look at the Line Drawing again and you will see that beginning with the 6th needle on the left (remember we always count the out of work needles) hold the Selector in front of you and hook the 5 pins onto the open needles on the machine. Don't let the pins slide behind the latches but keep them in front with the Selector held horizontally in front of you. Pull the Selector towards you until the selected needles are in the holding position. Lift the Selector off the needles and move to the next group of needles being careful to keep in Pattern. Continue across the machine until all the correct needles are in holding position.

Knit 5 rows (the Cam Box will end on the LEFT side), push in the LEFT Retractor Button and knit to the right side. RELEASE the Retractor Button. Knit 2 plain rows.

Follow the Line Drawing to set up the next Pattern Rows (alternate center needles of the groups of 3 will now go into holding) and knit 5 rows. Push in the LEFT Retractor Button, knit 1 row to the right, RELEASE Retractor Button and knit 2 plain rows.

Continue in the above manner for knitting the Pattern.

### BUTTON AND BUTTONHOLE BANDS

When a Button and Buttonhole band is knitted right along with the front section of a garment, sometimes there is a problem with the front edge of the folded band rippling after the garment is completed.

There are several ways to counteract this. You can slip stitch crochet down the folded edge AFTER the garment is completed... or, you can, when knitting the section, work a slip stitch right in with the knitting. The band MUST have an UNEVEN number of stitches - so - if your Pat-

tern shows an even number of stitches for the band, you must add 1 extra stitch (be sure to take this into consideration and place the inside buttonhole over 1 needle toward the center of garment so it will meet the outside buttonhole). This center stitch will be the FOLD LINE of the band. As you knit, place this center stitch into holding position on every 2nd row and into knitting position on the alternate rows. KNITKING machine owners can use their Retractor Button. If you are bringing the center needle into holding position when your Cam Box is on the LEFT side, push in the LEFT Retractor Button and leave it there. Remember, this method should be used only when the band is in Stockinette stitch.

### EDGES OF HOLDING POSITION DESIGNS

When you knit a Holding Position Design, sometimes the edges are not very neat and you do not like the looks of the finished seams. If you have this problem, work a single crochet along the edges of each section BEFORE assembling the garment. The seams will go together nicely and have that expensive professional look.

## General Instructions

### GENERAL INSTRUCTIONS FOR THIS ISSUE

#### FULL FASHION DECREASING AND INCREASING

For Stockinette stitch, always use the Full Fashion method for decreasing or increasing.

TO DECREASE: Hang the 3rd stitch onto the 2nd stitch, then move the stitches in to fill the empty needle.

TO INCREASE: Move the 2 end stitches 1 needle outward, then pick up the 3rd stitch from the row below and hang it onto the empty needle.

#### NORWEGIAN DESIGNS

In the instructions, each row of the Norwegian Design is counted as 1 row but several movements of the Cam Box are needed to complete 1 row.

#### NORWEGIAN DESIGN WHEN USING THE PATTERN READER

When you use the Pattern Reader and knit a Norwegian Design using several colors, it is necessary to move the trip control lever so that only 1 row registers.

#### TO MAKE FRINGE

Cut yarn DOUBLE the length of fringe desired (wind around a cardboard or book). Using 2 or more strands of yarn (depending on weight of yarn) fold in half and with a crochet hook, draw folded loop through knitting from the wrong side. Pull strands through loop and tighten.

To make an additional row of knots on fringe, take half the strands from 1 group and half from the next group, then knot together approximately 1" to 2" below and continue across.



### FINISHING:

Block all sections.

**FOR PULLOVERS, JACKETS AND DRESSES:** Join front to back at sides and shoulders. Sew sleeves together and set in. Hem lower edge and sleeve edges if needed. For a double neckband or armhole band, sew 1 edge to the inside and 1 to the outside of neck or armhole. For a single ribbed band, sew 1 edge to the outside of neck or armhole edge. For a Cardigan or Jacket with buttonholes, finish buttonholes and sew on buttons.

**PANTS:** Join front to back at sides. Sew inside leg seams, then join center, front and back. Make hem at waistline and insert elastic. Hem lower edge of pants legs.

### THE SAMPLE SWATCH

Before you begin to knit any garment, you will need to knit a sample piece using the yarn you have chosen for your garment, so that you can check the stitch and row gauge which must measure the correct number of stitches and rows in 2 inches (5 cm).

For each Pattern in KNITKING MAGAZINE, we give you 3 Tension Numbers to work from and if you use the specified yarn for the garment, you should be able to get the correct stitch and row gauge using one of these numbers. Here is a very easy way to make your sample swatch and count the stitches and rows WITHOUT actually counting, by using our KNITKING CONVERTA TAPE.

Supposing the Tension Numbers for the Stitch and Row Gauge are given as 5 to 7. Set the Tension Dial to the first number which is 5. With contrast waste yarn, and using the quick cast-on method, cast on 60 stitches and knit 10 rows. Change to garment yarn and turn the Row Counter to 0. Knit 30 rows. Counting from each end, knit the 10th stitch on each side by hand with a small piece of contrast yarn. Leave the needles in working position and knit 30 rows (Row 60), then knit 4 rows with contrast waste yarn. Turn the Row Counter to 0 and the Tension Dial to 6 and with garment yarn, knit 30 rows. Mark the 10th stitch on each side as you did before, knit 30 rows, then 4 rows with contrast waste yarn. Turn the Row Counter to 0 and with Tension 7, repeat the above once more ending with 10 rows of contrast waste yarn, then remove the work from the machine by passing the Slide across the needles without yarn (sometimes called 'dropping').

Pull and stretch the sample piece both lengthwise and diagonally from corner to corner, then lengthwise again. Do not count the stitches and rows immediately, but allow the sample to rest for several hours or even over night. This will allow the stitches and rows to return to their basic form.

When your sample has rested and you are ready to count the stitches and rows, the KNITKING CONVERTA TAPE will do the figuring for you without any counting on your part. Use the Tape as follows:

To measure the stitches, pull out the Tape to measure BETWEEN the 40 stitches in the center that you marked by hand knitting with contrast yarn. Push the red marker on the Tape so that it points to 40 stitches on the Tape. Your stitch gauge to 2 inches will show in the red window on the tape. To find the number of rows in 2 inches, place the tape to measure over 60 rows, push the red marker to 60 on the tape and your row gauge for two inches will show in the red window.... Easy...? If you do not get the correct stitch

and row gauge in the first part of your sample, then try the other two.

If you do not own a KNITKING CONVERTA TAPE, you must mark a 2 inch square in the center of the knitting, then count the number of stitches and rows within the square.

### CROCHET LOOP STITCH for PATTERNS DK 37, DK 41, DK 32, DK 36 - IN THIS ISSUE.

There are no instructions given for the Crochet Loop Stitch Hats shown in the illustrations; however, if you wish to make one of the Hats, begin with a chain long enough to go around your head. Work the Loop Stitch, going back and forth and begin decreasing on each side after about 2 inches until it is deep enough to cover your head. Sew up the back seam and pull up the top (See picture).

### ALWAYS USE DOUBLED YARN

Make a chain as long as required (see Charts shown for specific sections).

Work 1 row single crochet into each stitch.

**ROW 1:** LOOP ROW: Single crochet into first stitch. \*Put hook into next stitch and place your middle finger OVER the yarn in BACK, yarn over hook and pull through (slip stitch). Chain 1, REPEAT from \* to end, chain 1, turn.

**ROW 2:** Hold loops down with your left thumb and single crochet into stitch BETWEEN each group of loops, chain 1, turn.

REPEAT ROWS 1 and 2 for Pattern.

If you prefer longer loops, place 2 fingers over yarn in back instead of 1 finger.







## General Instructions

### Full Fashion decreasing and increasing

For Stockinette stitch, always use the Full Fashion method for decreasing or increasing.

**TO DECREASE:** Hang the 3rd stitch onto the 2nd stitch then move the stitches in to fill the empty needle.

**TO INCREASE:** Move the 2 end stitches 1 needle outward then pick up the 3rd stitch from the row below and hang it onto the empty needle.

### Norwegian Designs

In the instructions, each row of the Norwegian Design is counted as 1 row but several movements of the Cam Box are needed to complete 1 row.

### To make fringe

Cut yarn **DOUBLE** the length of fringe desired (wind around a cardboard or book). Using 2 or more strands of yarn (depending on weight of yarn), fold in half and with a crochet hook, draw folded loop through knitting from the wrong side. Pull strands through loop and tighten.

To make an additional row of knots on fringe, take half the strands from 1

group and half from the next group then knot together approximately 1" to 2" below and continue across.

### Finishing

Block all sections.



























For Pullovers, Jackets and Dresses: Join front to back at sides and shoulders. Sew sleeves together and set in. Hem lower edge and sleeve edges if needed. For a double neckband or armhole band, sew 1 edge to the inside and 1 to the outside of neck or armhole. For a single ribbed band, sew 1 edge to the outside of neck or armhole edge. For a Cardigan or Jacket with buttonholes, finish buttonholes and sew on buttons.



















**PANTS:** Join front to back at sides. Sew inside leg seams then join center front and back. Make hem at waistline and insert elastic. Hem lower edge of pants legs.





# PATTERN SYMBOLS

-  1 Cast on
-  2 Stockinette stitch - worn on the Knit side
-  3 Stockinette stitch - worn on the purl side
-  4 Knit 1, Purl 1, Ribbing
-  5 Ribbing Pattern - worn on the Purl side
-  6 Ribbing Pattern - worn on the Knit side
-  7 Put on a stitch holder
-  8 Pattern Stitch
-  9 Knit Stitch
-  10 Purl Stitch
-  11 Needles back into working position
-  12 Empty needle (leave in working position)
-  13 Needle not used (in the out of work position)
-  14 Needle in holding position
-  15 Two stitches on 1 needle - either transferred from the right side or the left side, then put into holding position
-  16 Needle holding 2 stitches. Stitch has been transferred from the LEFT
-  17 Needle holding 2 stitches. Stitch has been transferred from the RIGHT
-  18 3 stitches on 1 needle. The 1st and 3rd stitch in a group of 3 needles has been hung on the 2nd or center needle
-  M 19 Stitch
-  R 20 Row
-  4. 21 Number of rows to be knitted between shapings
-  22 Bind off
-  E 23 Tension
-  P 24 Gauge
-  25 Reverse one section
-  26 On every other needle

-  OV 27 & 28. Open Dart
-  29 3 stitches on 3 needles. For increasing hang the 3 stitches with transfer tool on to the next exterior needles and put 3 additional needles into working position at the outside.
-  30 Increase
-  31 Short Row increase or decrease, for instance on flared skirt knitted sideways
-  32 Pattern stitch - worn on the Knit side
-  33 Pattern stitch - worn on the Purl side
-  34 Center of garment section
-  Gr. 35 2nd size (Gr. 16/18) 3rd size (Gr. 20/22)
-  36 Turn to the wrong side and hem
-  37 Ease
-  38 Match numbers on sections for assembling
-  H 39 Hem
-  40 Fold line
-  F 1 41 Color number (1st color = example)
-  A 42 Model for beginners
-  S 43 Pattern Reader
-  44 Repeat
-  \* RN 45 After the first knitting phase of Norwegian Pattern please release the lever of the Pattern Reader and turn it on again after having finished the following different phases in one row.

4.

First please do the required number of decreases and increases and afterwards knit the corresponding number of rows; e.g. 3 x 1 S 4 = decrease 1 S, knit 4R, decrease 1S, then knit again 4R and so on. All decreasing and increasing without numbering of rows (e.g. 4) has to be done on every 2nd R.

- I = Front
- II = Back
- III = Sleeve
- IV = Skirt Front
- V = Skirt Back
- VI = Collar
- VII = Pocket
- VIII = Band
- IX = Belt
- X = Cuff
- XI = Trousers Front
- XII = Trousers Back



# DK 31

## WOMAN'S DRESS AND COAT

SIZE: 8/10 (12/14) [16/18]

YARN: Beatrice

50 gr. balls: 17 (18) [19]

**E** TENSION: 5 to 7

**P** GAUGE:

Stock:  
16 sts. 22 rows = 5 cm (2") 

Pattern:  
13 sts. 20 rows = 5 cm (2") 

Stockinette stitch and a Holding Position Design with out of work needles that ARE COUNTED in the Stitch Gauge and instructions. Follow the Line Drawing. The Purl side of Pattern is the right side, the knit side for Stockinette stitch. Use the Adjustable Needle Selector for Pattern.

FINISHING: See General Instructions. Work 2 rows single crochet around armholes of Dress, turn to the inside and sew in place. Make a cord over 5 needles using Tension 1 or 2 and knit as many rows as needed for the length you prefer. Tie cord in a bow and sew to neckline of dress. See picture.

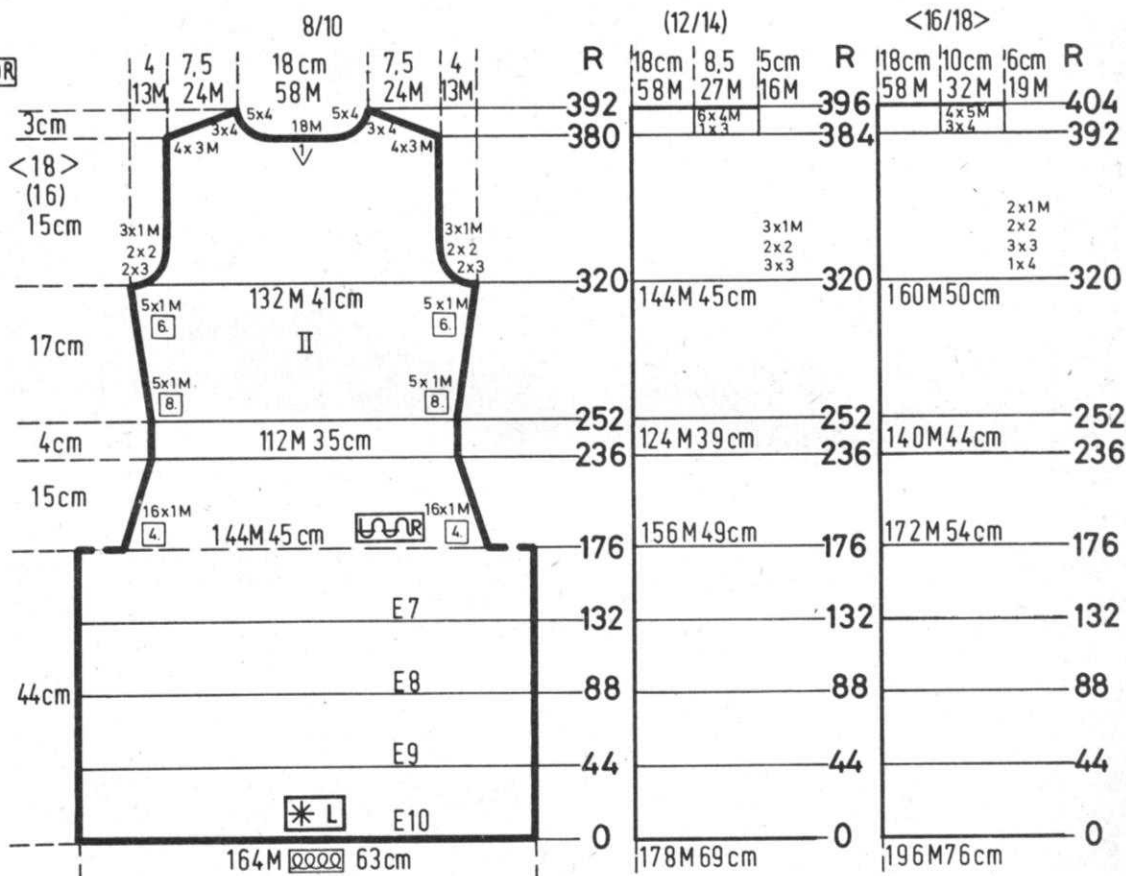

### DRESS BACK: II

Bring 164 (178) [196] needles into working position then set into pattern with every 4th needle out of work. Cast on. Work in Pattern. With Tension 10 knit to Row 44; with Tension 9 knit to Row 88; with Tension 8 knit to Row 132; with Tension 7 knit to Row 176 then remove the sts. onto contrast waste yarn.

Hang the sts. back onto the machine with the Knit Side facing you, decreasing to 144 (156) [172] sts. (doubling every 7th and 8th st.) Continue in Stockinette stitch with Tension 7.

ON EACH SIDE, decrease 1 st. every 4 th row 16x. Knit to Row 252. ON EACH SIDE, increase 1 st. every 8 th row 5x, every 6th row 5x. Knit to Row 320.

#### SHAPE ARMHOLE:

ON EACH SIDE bind off 3 sts. 2x, 2 sts. 2x, 1 st. 3x (3 sts. 3x, 2 sts. 2x, 1 st. 3x)

[4 sts. 1x, 3 sts. 3x, 2 sts. 2x, 1 st. 2x] Knit to Row 380 (384) [392]

Bind off the center 18 sts. put the needles on the left side into holding position and complete the right half first.

\* SHAPE SHOULDER AND NECK AT THE SAME TIME Bind off

#### FOR SHOULDER

3 sts. 4x, 4 sts. 3x (3 sts. 1x, 4 sts. 6x) [4 sts. 3x, 5 sts. 4x]

#### FOR NECK

4 sts. 5x Same as above Same as above

Bring the needles on the left into working position, knit 1 row in Pattern to the left side, turn the Row Counter back to 380 (384) [392] and complete the left half. Follow the instructions from \*

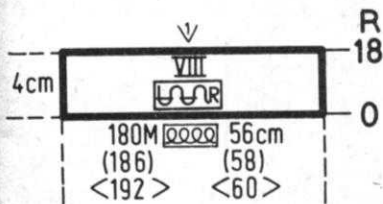

### DRESS NECKBAND: VIII

Cast on 180 (186) [192] sts. and knit 18 rows Stockinette stitch, then bind off.



# DK 31

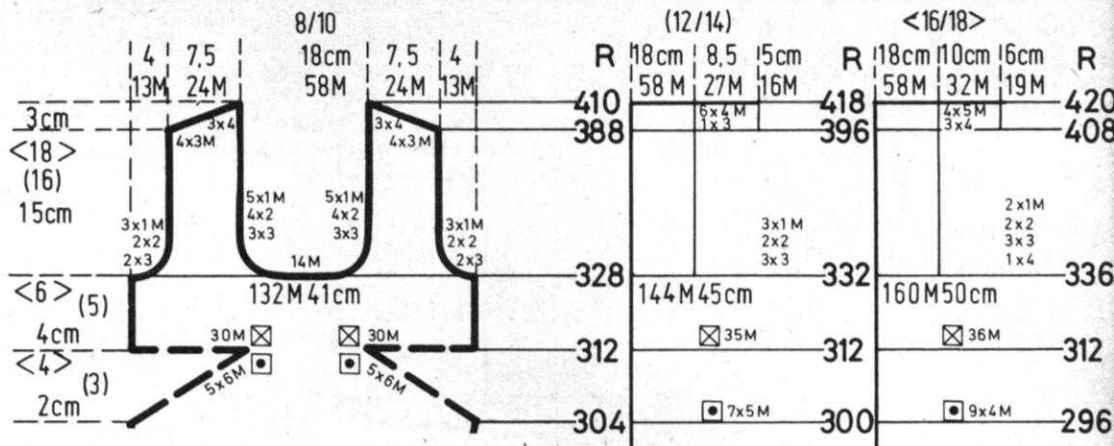

## DRESS FRONT: I

Work the front the same as the back to Row 304 (300) [296] then work Short Rows for the BUST DARTS and continue the side increases.

ON OPPOSITE SIDE OF CAM BOX, put into holding position 6 sts. 5x ON EACH SIDE; (5 sts. 7x ON EACH SIDE) [4 sts. 9x ON EACH SIDE]. Bring all the needles back into working position before knitting the next 2 rows. Make 1 more increase ON EACH SIDE after Row 314 then knit to Row 328 (332) [336], bind off the center 14 sts., put the needles on the left side into holding position and complete the right half first.

\* SHAPE ARMHOLE AND NECK

AT THE SAME TIME

Bind off

## FOR ARMHOLE

3 sts. 3x, 2 sts. 4x, 1 st. 5x  
(3 sts. 3x, 2 sts. 2x, 1 st. 3x)  
[4 sts. 1x, 3 sts. 3x, 2 sts. 2x, 1 st. 2x]

## FOR NECK

3 st. 3x, 2 sts. 4x, 1 st. 5x  
Same as above  
Same as above

Knit to Row 388 (396) [408]

Bind off for Shoulder

3 sts. 4x, 4 sts. 3x  
(3 sts. 1x, 4 sts. 6x)  
[4 sts. 3x, 5 sts. 4x]

Bring the needles on the left into working position, knit 1 row in Pattern to the left side, turn the Row Counter back to 328 (332) [336] and complete the left half. Follow the instructions from \*.

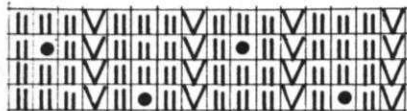

15-16  
9-14  
7-8  
1-6

## COAT BACK: II

Bring 134 (144) [156] needles into working position then set into pattern with every 4th needle out of work. Cast on. Knit in Pattern.

With Tension 10, knit to Row 60. Change to Tension 9 and ON EACH SIDE decrease 1 st. every 14 rows 6x (change to Tension 8 after Row 120). After Row 180, change to Tension 7 and ON EACH SIDE decrease 1 st. every 8 th row 4x, every 6th row 6x. Knit to Row 264. ON EACH SIDE increase 1 st. every 12th row 5x.

SHAPE ARMHOLE after Row 328 ON EACH SIDE BIND OFF

3 sts. 1x, 2 sts. 3x, 1 st. 3x  
(3 sts. 2x, 2 sts. 2x, 1 st. 4x)  
[3 sts. 3x, 2 sts. 2x, 1 st. 3x]

Knit to Row 396 (400) [404]  
Bind off the center 16 sts., put the needles on the left side into holding position and complete the right half first.

\* SHAPE SHOULDER AND NECK AT THE SAME TIME

Bind off  
3 sts. 2x, 4 sts. 5x  
(4 sts. 6x, 5 sts. 1x)  
[4 sts. 2x, 5 sts. 5x]

## FOR NECK

2 sts. 5x  
Same as above

Bring the needles on the left into working position, knit 1 row in Pattern to the left side, turn the Row Counter back to 396 (400) [404] and complete the left half. Follow the instructions from \*.

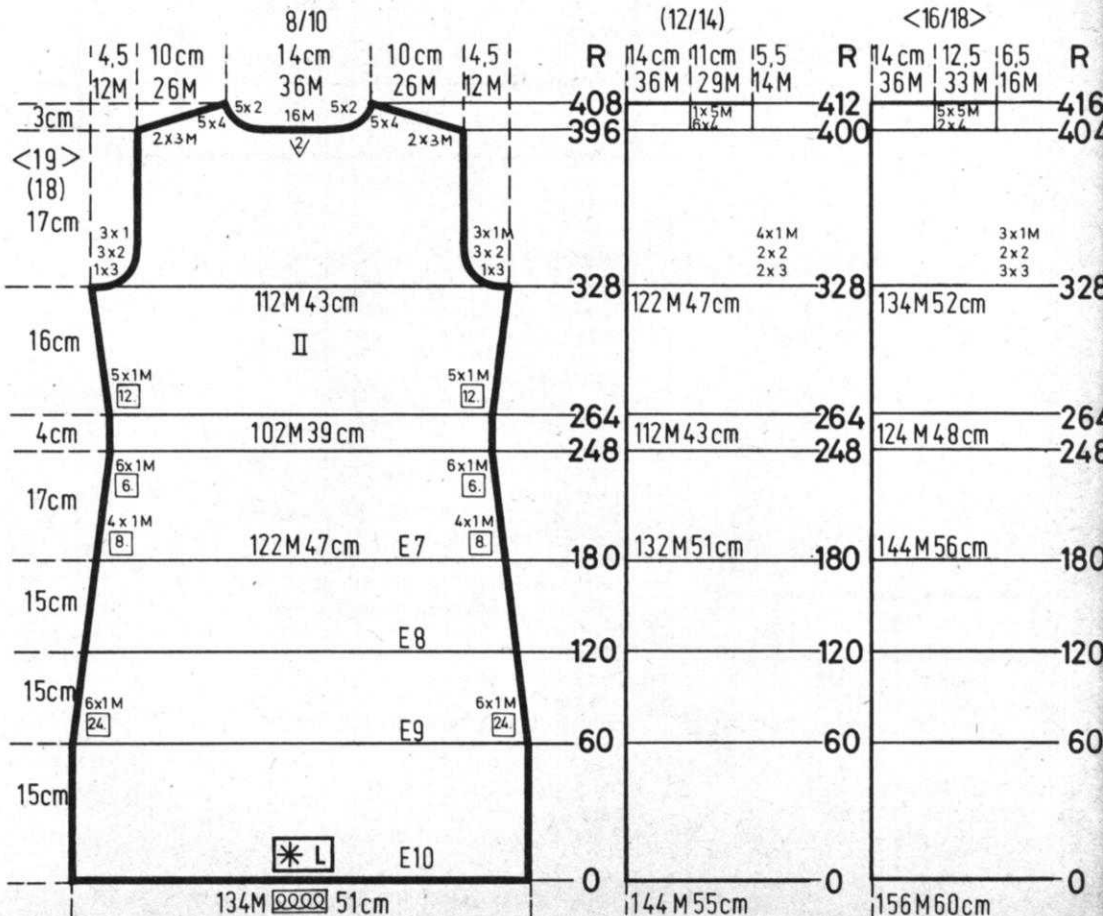



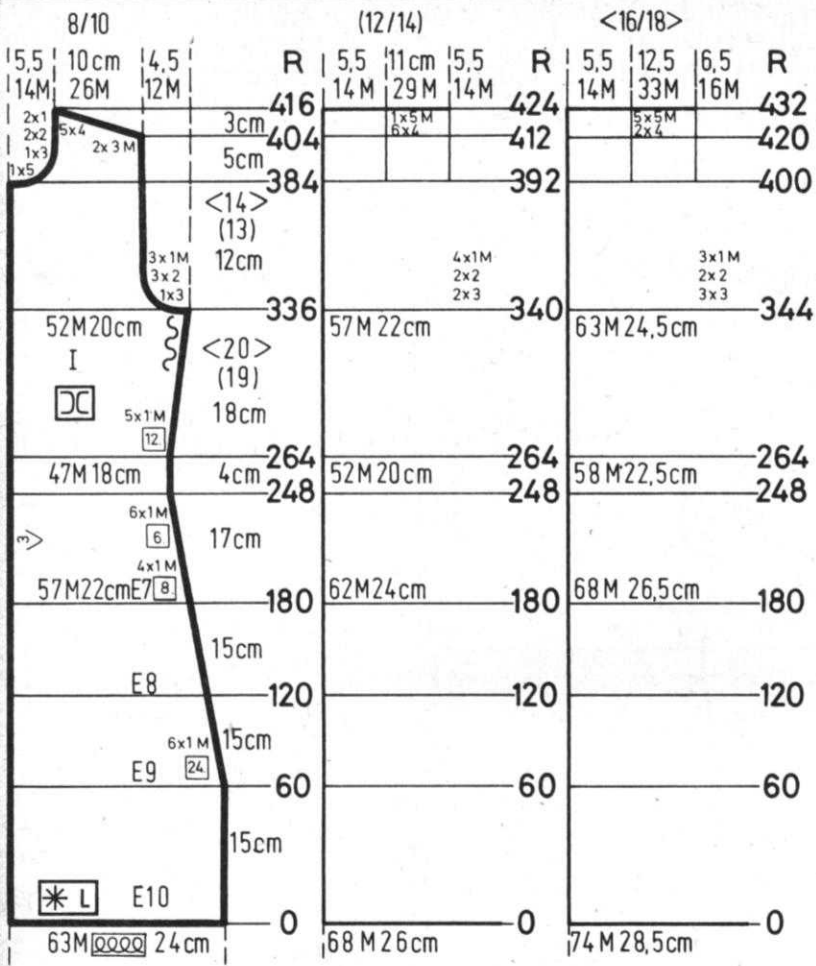

**COAT FRONT: I**

Bring 63 (68) [74] needles into working position then set into Pattern with every 4th needle out of work. Cast on. Knit in Pattern.  
 With Tension 10 knit to Row 60. Change to Tension 9. ON CAM BOX SIDE, decrease 1 st. every 24th row 6x and change to Tension 8 after Row 120. Change to Tension 7 after Row 180 and ON CAM BOX SIDE, decrease 1 st. every 8th row 4x, every 6th row 6x. Knit to Row 264. On CAM BOX SIDE, increase 1 st. every 12th row 5x.  
 Knit to Row 336 (340) [344]  
**SHAPE ARMHOLE:**  
 ON CAM BOX SIDE bind off  
 3 sts. 1x, 2 sts. 3x, 1 st. 3x  
 (3 sts. 2x, 2 sts. 2x, 1 st. 4x)  
 [3 sts. 3x, 2 sts. 2x, 1 st. 3x]  
 Knit to Row 385, (393) [401]  
**SHAPE NECK:** Bind off 5 sts. 1x, 3 sts. 1x, 2 sts. 2x, 1 st. 2x  
**SHAPE SHOULDER** after Row 404 (412) [420]  
 Bind off  
 3 sts. 2x, 4 sts. 5x  
 (4 sts. 6x, 5 sts. 1x)  
 [4 sts. 2x, 5 sts. 5x]  
 Knit the second section with reverse shaping.

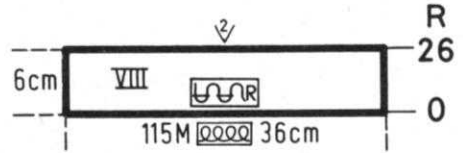

**COAT NECK BAND: VIII**

Cast on 115 sts. and work 26 rows Stockinette stitch then bind off.

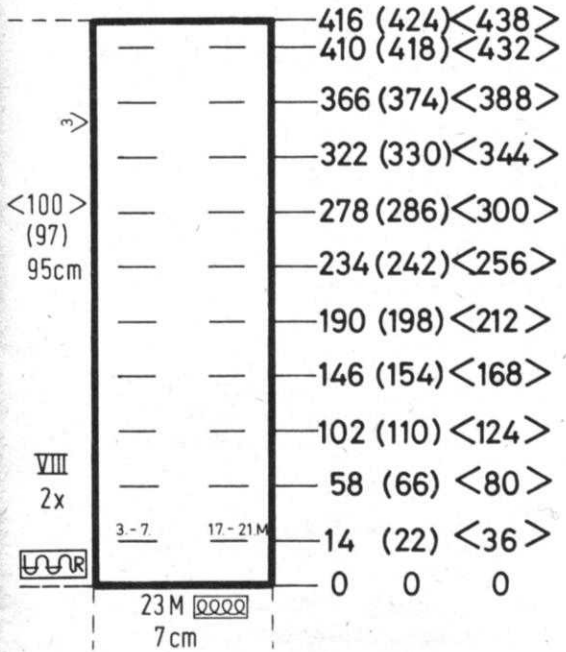

**COAT BUTTONHOLE BAND:**  
 Cast on 23 sts. and work Stockinette stitch. Make Buttonholes over needles 3 to 7 and 17 to 21 counting from the left after Rows (for your size) shown on the Chart. After Row 416 (424) [438], bind off. Make Button Band the same but omit the Buttonholes.

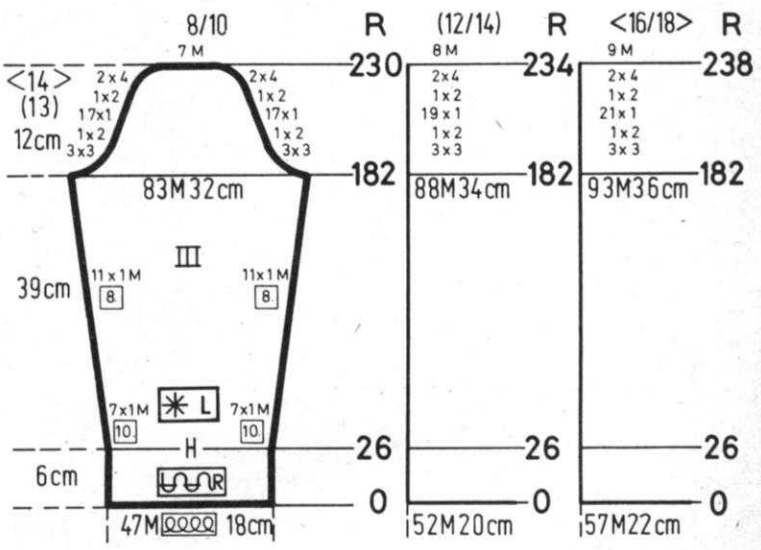

**COAT SLEEVE: III**

Cast on 47 sts. and knit 26 rows Stockinette stitch. Hang the hem, then set into Pattern with every 4th needle out of work. Continue in Pattern. ON EACH SIDE, increase 1 st. every 10th row 7x, every 8th row 11x. Knit to Row 182.

**SHAPE CAP:**

ON EACH SIDE bind off  
 3 sts. 3x, 2 sts. 1x, 1 st. 17x, 2 sts. 1x, 4 sts. 2x  
 (3 sts. 3x, 2 sts. 1x, 1 st. 19x, 2 sts. 1x, 4 sts. 2x)  
 [3 sts. 3x, 2 sts. 1x, 1 st. 21x, 2 sts. 1x, 4 sts. 2x]  
 Bind off the remaining 7 (8) [9] sts.



# DK 32

## WOMAN'S COAT WITH HOOD, PANTS AND PULLOVER

SIZE: 7/8 (10/12) [14/16]

YARN: Flamingo Dralon

50 gr. balls: color 1 30 (31) [32]  
color 2 3 (3) [3]

**E** TENSION: 8 to 10

**P** GAUGE:

Pattern:

16 sts. 18 rows = 5 cm (2")



Mock Rib with every 4th needle out of work that ARE COUNTED in the Stitch Gauge and Instructions. Front trim on Pullover is Stockinette stitch. Crochet loop trim for Hood and Cuffs of Coat. Worn on the knit side.

FINISHING: See General Instructions. Leave 7 cm open on the left shoulder of Pullover. Single crochet around opening and make loops on 1 side, sew buttons to the other side. Mitre the upper and lower corners of band trim for Pullover then sew in place (see picture). Sew Hood together then make the crochet loop trim (See General Instructions), cut the loops and brush the yarn. Sew Hood onto Coat. Make Cuffs for Coat sleeves in the same way.

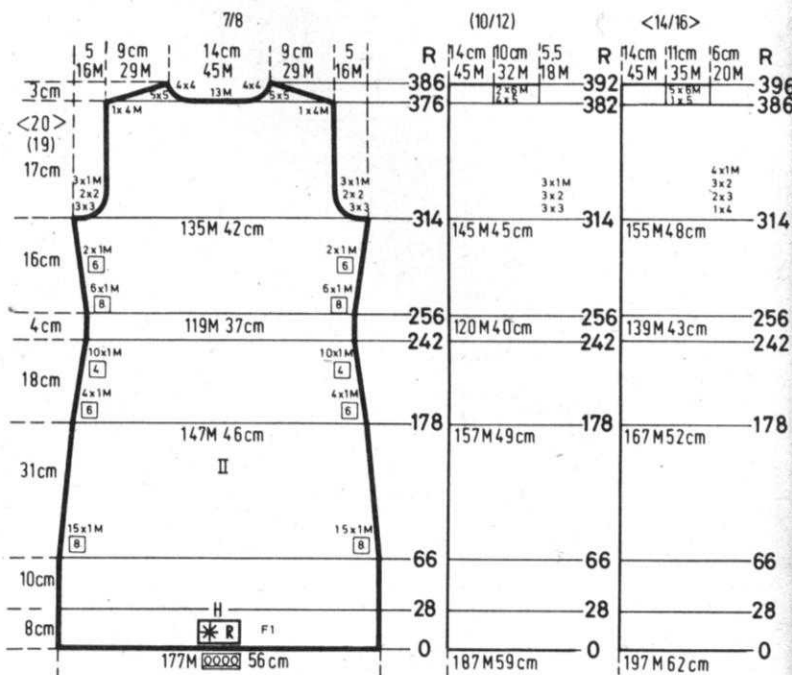
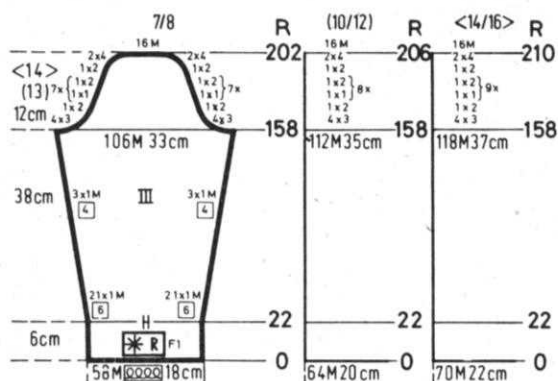

### COAT SLEEVE:

Bring 58 (64) [70] needles into working position and set up into the MOCK RIB Pattern. Cast on with color 1. Knit to Row 22 then hang the hem.  
ON EACH SIDE increase 1 st. every 6th row 21x, every 4th row 3x. Knit to Row 158.

### SHAPE CAP:

ON EACH SIDE bind off  
3 sts. 4x, 2 sts. 1x, \* 1 st. 1x, 2 sts. 1x \* and REPEAT from \* to \* 6x more,  
2 sts. 1x, 4 sts. 2x  
(3 sts. 4x, 2 sts. 1x, \* 1 st. 1x, 2 sts. 1x \* and REPEAT from \* to \* 7x more,  
2 sts. 1x, 4 sts. 2x)  
(3 sts. 4x, 2 sts. 1x, \* 1 st. 1x, 2 sts. 1x \* and REPEAT from \* to \* 8x more,  
2 sts. 1x, 4 sts. 2x]  
Bind off the remaining 16 sts.

### COAT BACK: II

Bring 177 needles into working position, then push back every 4th needle to the out of work position for the MOCK RIB. Cast on. With Color.  
Knit to Row 28, hang the hem then continue to Row 66.  
ON EACH SIDE decrease 1 st. every 8th row 15x. Knit to Row 178. On EACH SIDE decrease 1 st. every 6th row 4x, every 4th row 10x. Knit to Row 256.  
ON EACH SIDE, increase 1 st. every 8th row 6x, every 6th row 2x. Knit to Row 314.  
SHAPE ARMHOLE:  
ON EACH SIDE, bind off  
3 sts. 1x, 2 sts. 2x, 1 st. 3x  
(3 sts. 3x, 2 sts. 3x, 1 st. 3x)  
[4 sts. 1x, 3 sts. 2x, 2 sts. 3x, 1 st. 4x]  
Knit to Row 376 (382) [386]  
Bind off the center 13 sts. put the

needles on the left side into holding position and complete the right half first.  
\* SHAPE SHOULDER AND NECK AT THE SAME TIME  
Bind off

FOR SHOULDER  
4 sts. 1x, 5 sts. 5x  
(5 sts. 4x, 6 sts. 2x)  
[5 sts. 1x, 6 sts. 5x]

FOR NECK  
4 sts. 4x  
Same as above  
Same as above

Bring the needles on the left into working position, knit 1 row to the left side, turn the Row Counter back to 376 (382) [386] and complete the left half.  
Follow the instructions from \*.

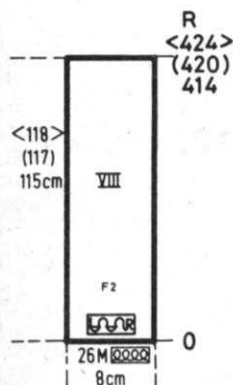

### PULLOVER BAND: VIII

Cast on 26 sts. with color 2 and work Stockinette stitch.  
Knit to Row 414 (420) [424] then bind off.

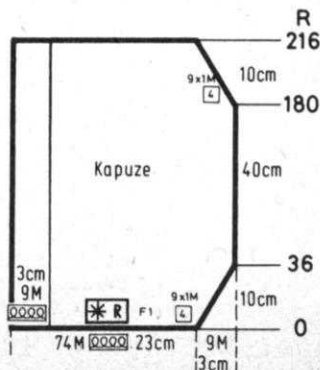

### HOOD:

Bring 74 needles into working position then set up in MOCK RIB Pattern, then add 9 needles on the left side to be kept in stockinette stitch. Cast on with color 1.  
ON CAM BOX SIDE increase 1 st. every 4th row 9x then knit even to Row 180. ON CAM BOX SIDE, decrease 1 st. every 4th row 9x. After Row 216, bind off all sts.



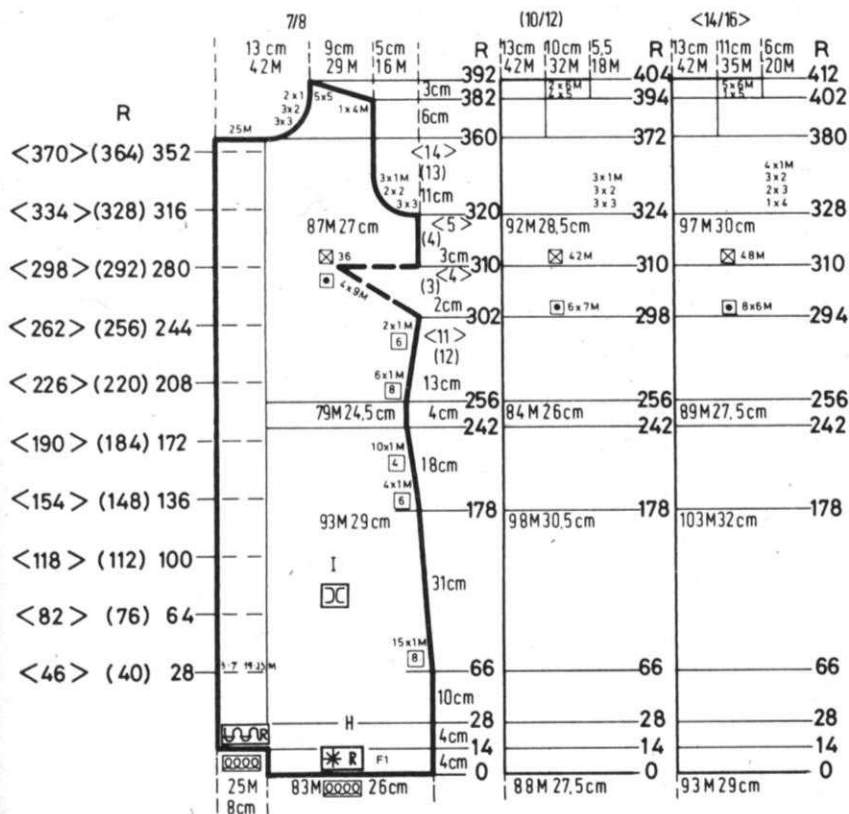

### COAT FRONT: I

Bring 83 (88) [93] needles into working position and push every 4th needle back to the out of work position for the MOCK RIB. Cast on. With Color 1. After row 14, cast on 25 sts. OPPOSITE CAM BOX (use separate yarn) for the band and continue with the band in Stockinette stitch. After Row 28, hang the original cast on stitches for the hem.

MAKE BUTTONHOLES over needles 3 to 7 and 19 to 23 counting from the left edge after Rows (for your size) shown on the Chart and at the same time SHAPE SIDE EDGE.

After Row 66, decrease 1 st. every 8th row 15x. Knit to Row 178 and decrease 1 st. every 6th row 4x, every 4th row 10x. Knit to Row 256. ON SIDE EDGE increase 1 st. every 8th row 6x, every 6th row 2x.

WORK SHORT ROWS for Bust Dart after Row 303 (299) [295] Put into holding position 9 sts. 4x (7 sts. 6x) [6 sts. 8x]. Bring all the needles back into working position before knitting the next 2 rows. Knit to Row 320 (324) [328]

SHAPE ARMHOLE: Bind off 3 sts. 3x, 2 sts. 2x, 1 st. 3x (3 sts. 3x, 2 sts. 3x, 1 st. 3x) [4 sts. 1x, 3 sts. 2x, 2 sts. 3x, 1 st. 4x]

Knit to Row 360 (372) [380] Bind off 25 sts. OPPOSITE CAM BOX for neck (use separate yarn) then on NECK SIDE bind off 3 sts. 3x, 2 sts. 3x, 1 st. 2x.

SHAPE SHOULDER after Row 382 (394) [402]

Bind off  
4 sts. 1x, 5 sts. 5x  
(5 sts. 4x, 6 sts. 2x)  
[5 sts. 1x, 6 sts. 5x]

Work the second front section with reverse shaping and omit the buttonholes.

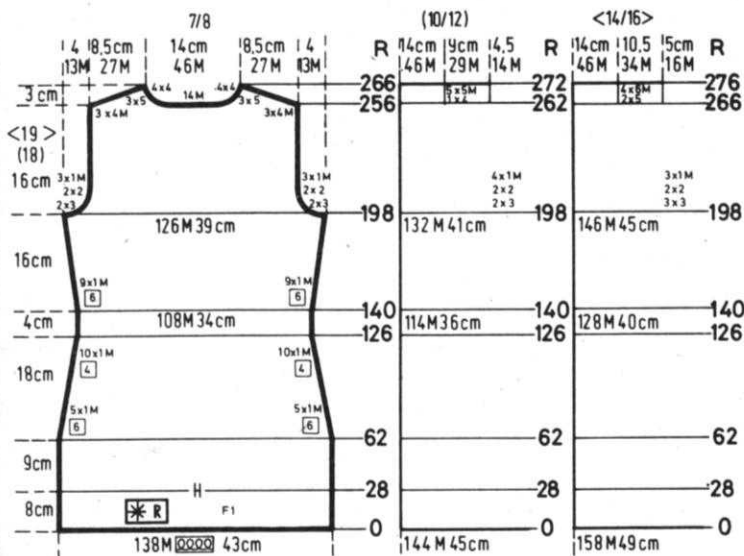

### PULLOVER BACK:

Bring 138 (144) [158] needles into working position then push back every 4th needle to the out of work position for the MOCK RIB. With color 1, cast on.

Knit to Row 28 then hang the hem and knit to Row 62.

ON EACH SIDE, decrease 1 st. every 6 row 5x, every 4th row 10x.

Knit to Row 140. ON EACH SIDE increase 1 st. every 6th row 9x.

SHAPE ARMHOLE:

ON EACH SIDE bind off

3 sts. 2x, 2 sts. 2x, 1 st. 3x (3 sts. 2x, 2 sts. 2x, 1 st. 4x) [3 sts. 3x, 2 sts. 2x, 1 st. 3x]

Knit to Row 256 (262) [266], bind off the center 14 sts. put the needles on the left into holding position and complete the right half first.

\* Bind off

FOR SHOULDER  
4 sts. 3x, 5 sts. 3x  
(4 sts. 1x, 5 sts. 5x)  
[5 sts. 2x, 6 sts. 4x]

FOR NECK  
4 sts. 4x  
(Same as above)  
[Same as above]

Bring the needles on the left into working position, knit 1 row to the left, turn the Row Counter back to 256 (262) [266] and complete the left half. Follow the instructions from \*.







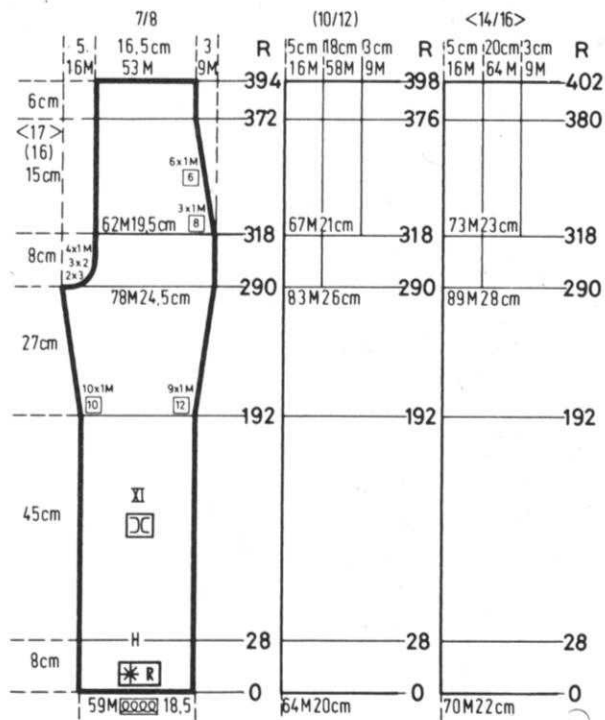

### PANTS FRONT: XI

Make 1, Reverse 1.  
Bring 59 (64) [70] needles into working position then set into MOCK RIB Pattern and cast on.  
Knit to Row 28, hang the hem then knit to Row 192.  
ON CAM BOX SIDE increase 1 st. every 12th row 9x and ON OPPOSITE SIDE OF CAM BOX increase 1 st. every 10th row 10x.  
Knit to Row 291  
Bind off for center seam 1 st. 2x, 2 sts. 3x, 1 st. 4x  
Knit to Row 318.  
ON SIDE EDGE, decrease 1 st. every 8th row 3x, every 6th row 6x  
Knit to Row 394 (398) [402]  
Bind off the remaining 53 (58) [64] sts.

# DK 33

## WOMAN'S DRESS AND SHAWL

SIZE: 8/10 (12/14) [16/18]

YARN: Amore - color 1  
Melodie - color 2

50 gr. balls: C1 12 (13) [14]  
C2 7 (8) [9]

**E** TENSION: 7 to 9

**P** GAUGE:

Stock:  
15 sts. 23 rows = 5 cm (2")

Pattern:  
13 sts. 18 rows = 5 cm (2")

Bodice, sleeves, neckband and Shawl are Stockinette stitch worn on the Knit side.  
Skirt section, Holding Position Design with out of work needles that ARE COUNTED in the stitch gauge and instructions.  
Follow the Line Drawing and use the Adjustable Needle Selector. The knit side of Pattern is the right side.

FINISHING: See General Instructions.  
Crochet around neckline and sleeve edges as follows: With color 2, work 1 row single crochet then 1 row Picot as follows:  
\* ch 3, slip stitch into first stitch; 1 sc into next 3 sts. and REPEAT from \* around.  
Sew on 5 buttons (see picture).

SHAWL: With color 2, work 1 row single crochet around edges. Make fringe using color 2 on the 2 long edges, wrapping the yarn around a 14" cardboard and cut 1 edge only. Use 4 to 6 strands of yarn for making the fringe. See General Instructions this issue.

### SHAWL

Cast on 3 sts. with color 1 and work Stockinette stitch.  
ON CAM BOX SIDE, increase 1 st. every 2nd row 102x, every 3rd row 92x. Knit to Row 496.  
ON CAM BOX SIDE, decrease 1 st. every 3rd row 92x, every 2nd row 102x. After Row 976, bind off 3 sts.

### NECKBAND: VIII

Cast on 164 sts. with color 1 and work 18 rows Stockinette stitch then bind off.

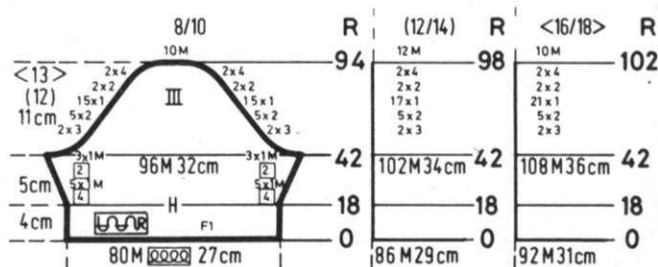
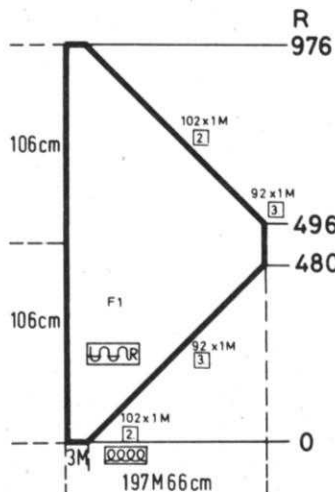

### SLEEVE: III

Cast on 80 (86) [92] sts. with color 1 and work Stockinette stitch. Knit to Row 18 then hang the hem.  
ON EACH SIDE increase 1 st. every 4th row 5x, every 2nd row 3x, knit to Row 42.  
SHAPE CAP:  
ON EACH SIDE bind off  
3 sts. 2x, 2 sts. 5x, 1 st. 15x, 2 sts. 2x, 4 sts. 2x  
(3 sts. 2x, 2 sts. 5x, 1 st. 17x, 2 sts. 2x, 4 sts. 2x)  
[3 sts. 2x, 2 sts. 5x, 1 st. 21x, 2 sts. 2x, 4 sts. 2x]  
After Row 94 (98) [102] bind off the remaining 10 (12) [10] sts.



# DK 33

## BACK: II

Bring 156 (168) [184] needles into working position then set into Pattern as on the Line Drawing. Cast on with Color 1.  
Knit in Pattern.

With Tension 10, knit to Row 72

Change to Tension 9

ON EACH SIDE decrease 1 st. every 28th row 10x CHANGING THE TENSIONS as shown on the Chart.

After Row 360, remove the work from the machine onto contrast waste yarn then replace the sts. onto the machine decreasing to 102 (112) [124] sts. Continue in Stockinette with color 2.

ON EACH SIDE, increase 1 st. every 8th row 9x

Knit to Row 460

SHAPE ARMHOLE:

ON EACH SIDE bind off

2 sts. 3x, 1 st. 6x

(3 sts. 1x, 2 sts. 3x, 1 st. 5x)

[3 sts. 2x, 2 sts. 2x, 1 st. 5x]

Knit to Row 534 (542) [562]

Bind off the center 22 sts. put the needles on the left into holding position and complete the right half first.

\* SHAPE NECK AND SHOULDER

AT THE SAME TIME

Bind off

FOR SHOULDER

3 sts. 3x, 4 sts. 3x

(4 sts. 6x)

[4 sts. 1x, 5 sts. 5x]

FOR NECK

4 sts. 4x

Same as above

Same as above

Move the Cam Box to the left side, turn the Row Counter back to 534 (542) [562] and complete the left half.

Follow the instructions from \*.

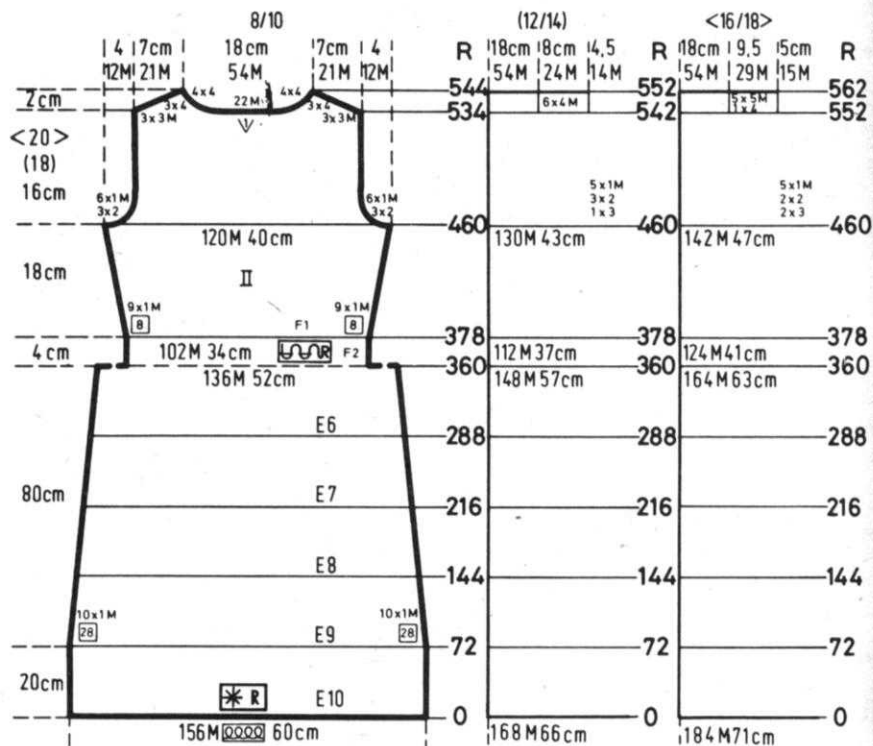

## FRONT: I

Work the front the same as the back to Row 446 (442) [438] then work Short Rows for the Bust Darts.

ON OPPOSITE SIDE OF CAM BOX, put into holding position

6 sts. 5x ON EACH SIDE

(5 sts. 7x ON EACH SIDE)

[4 sts. 9x ON EACH SIDE]

Knit to Row 470 (474) [478]

SHAPE ARMHOLE:

ON EACH SIDE bind off

2 sts. 3x, 1 st. 6x

(3 sts. 1x, 2 sts. 3x, 1 st. 5x)

[3 sts. 2x, 2 sts. 2x, 1 st. 5x]

Knit to Row 480 (492) [506]

Bind off the center 14 sts. Put the needles on the left into holding position and complete the right half first.

\* ON NECK SIDE, bind off

3 sts. 2x, 2 sts. 4x, 1 st. 6x

SHAPE SHOULDER after Row 544

(556) [570]

Bind off

3 sts. 3x, 4 sts. 3x

(4 sts. 6x)

[4 sts. 1x, 5 sts. 5x]

Move the Cam Box to the left side, turn the Row Counter back to 544 (556) [570] and complete the left half.

Follow the instructions from \*.

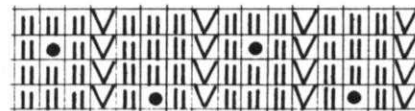
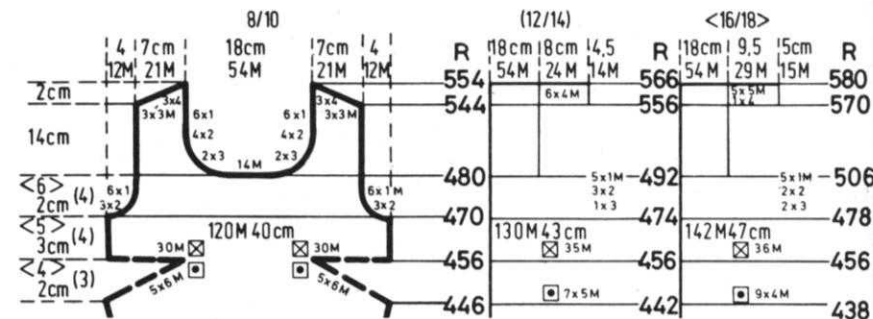

15-16 F 2

9-14 F 1

7- 8 F 2

1- 6 F 1



# DK 34

## WOMAN'S DRESS AND SHAWL

SIZE: 12/14 (16/18) [20/22]

YARN: Amore - color 1  
Melodie - color 2

50 gr. balls: C1 12 (13) [14]  
C2 7 (8) [9]

**E** TENSION: 7 to 9

**P** GAUGE:

Stock:  
15 sts. 23 rows = 5 cm (2") 

Pattern:  
13 sts. 18 rows = 5 cm (2") 

Bodice of Dress, sleeves, neckband and Shawl are Stockinette stitch. Skirt section: Holding Position Design with needles out of work that ARE COUNTED in the stitch gauge and instructions. Follow the Line Drawing and use the Adjustable Needle Selector. The Knit side is the right side.

FINISHING: Same as DK 33.

### BACK: II

Bring 172 (188) [195] needles into working position, set into Pattern as on the Line Drawing then cast on. Knit in Pattern.

With Tension 10, knit to Row 68.

Change to Tension 9 and ON EACH SIDE decrease 1 st. every 20 rows 10x and change Tensions as shown on the Chart.

Knit to Row 342.

Remove the sts. onto a stitch holder and hang them back onto the machine decreasing to 114 (126) [144] sts.

Continue in Stockinette stitch with color 1 ON EACH SIDE increase 1 st. every 8th row 9x

Knit to Row 442

#### SHAPE ARMHOLE:

ON EACH SIDE bind off

3 sts. 2x, 2 sts. 2x, 1 st. 3x

(4 sts. 2x, 2 sts. 3x, 1 st. 4x)

[4 sts. 2x, 3 sts. 2x, 2 sts. 2x, 1 st. 5x]

Knit to Row 526 (534) [540]

Bind off the center 18 sts. put the needles on the left side into holding position and complete the right half first.

\* Bind off

#### FOR SHOULDER

3 sts. 8x

(3 sts. 5x, 4 sts. 3x)

[3 sts. 1x, 4 sts. 7x]

#### FOR NECK

3 sts. 6x

Same as above

Same as above

Move the Cam Box to the left side, turn the Row Counter back to 526 (534) [540] and complete the left half.

Follow the instructions from \*.

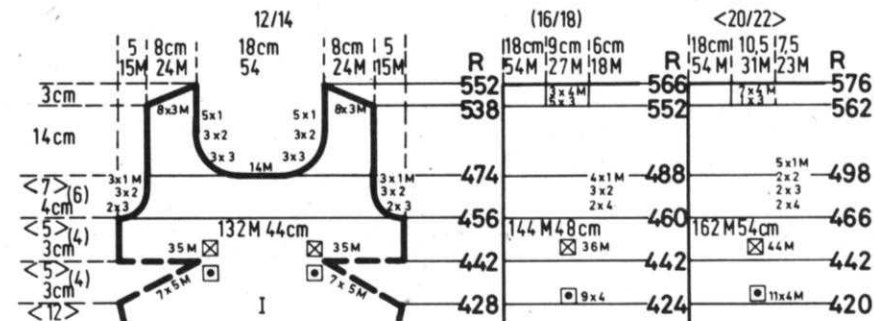
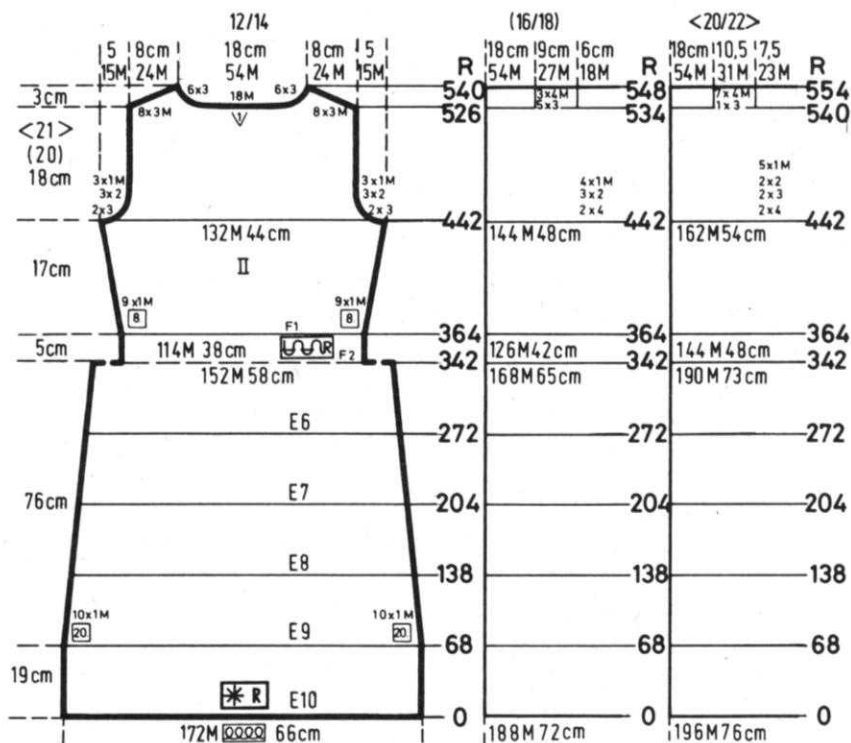

### FRONT: I

Work the front the same as the back to Row 428 (424) [420] then work Short Rows for the Bust Darts.

ON OPPOSITE SIDE OF CAM BOX, put into holding position 5 sts. 7x ON EACH SIDE (4 sts. 9x ON EACH SIDE) [4 sts. 11x ON EACH SIDE]

Bring all the needles back into working position before knitting the next 2 rows.

Knit to Row 456 (460) [466]

#### SHAPE ARMHOLE:

ON EACH SIDE bind off

3 sts. 2x, 2 sts. 3x, 1 st. 3x

(4 sts. 2x, 2 sts. 3x, 1 st. 4x)

[4 sts. 2x, 3 sts. 2x, 2 sts. 2x, 1 st. 5x]

Knit to Row 474 (488) [498]

Bind off the center 14 sts., put the needles on the left side into holding position and complete the right half first.

\* ON NECK SIDE, bind off

3 sts. 3x, 2 sts. 3x, 1 st. 5x

SHAPE SHOULDER after Row 538

(552) [562]

Bind off

3 sts. 8x

(3 sts. 5x, 4 sts. 3x)

[3 sts. 1x, 4 sts. 7x]

Move the Cam Box to the left side, turn the Row Counter back to 474 (488) [498]

and complete the left half.

Follow the instructions from \*.

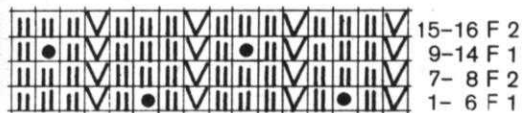



# DK 34

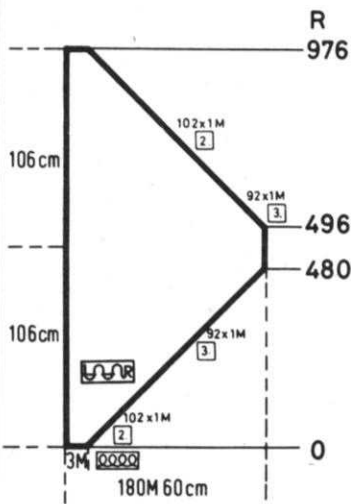

## SHAWL:

Cast on 3 sts. Work Stockinette stitch  
**ON CAM BOX SIDE** increase 1 st.  
 every 2nd row 102x, every 3rd row 92x  
 Knit to Row 496  
**ON CAM BOX SIDE** decrease 1 st.  
 every 3rd row 92x, every 2nd row 102x  
 Bind off the remaining 3 sts.

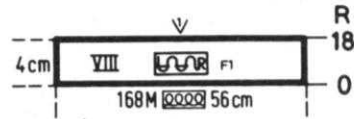

## NECKBAND: VIII

Cast on 168 sts. with color 1 and  
 work 18 rows stockinette stitch then  
 bind off.

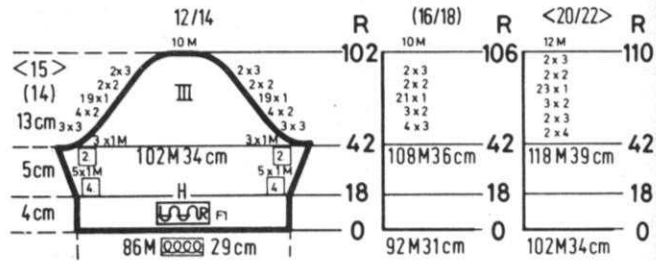

## SLEEVE: III

Cast on 86 (92) [102] sts. with color 1 and  
 work Stockinette stitch. Knit to Row 18  
 then hang the hem.

**ON EACH SIDE** increase 1 st. every 4th  
 row 5x, every 2nd row 3x.

SHAPE CAP after Row 42

**ON EACH SIDE** bind off

3 sts. 3x, 2 sts. 4x, 1 st. 19x, 2 sts. 2x,

3 sts. 2x

(3 sts. 4x, 2 sts. 3x, 1 st. 21x, 2 sts. 2x,

3 sts. 2x)

[4 sts. 2x, 3 sts. 2x, 2 sts. 3x, 1 st. 21x,

2 sts. 2x, 3 sts. 2x]

Bind off the remaining 10 (10) [12] sts.

# DK 35

## WOMAN'S COAT AND DRESS

SIZE: 12/14 (16/18) [20/22]

YARN: Beatrice

50 gr. balls: 24 (25) [26]

**E** TENSION: 6 to 8

**P** GAUGE:

Stock: 15 sts. 23 rows = 5 cm (2'')

Pattern: 15 sts. 21 rows = 5 cm (2'')

DRESS: Side panels and back of dress and  
 bands are Stockinette stitch. Coat and  
 front panel of dress are a Holding Position  
 Design with out of work needles that ARE  
 COUNTED in the Stitch gauge and  
 instructions. Follow the Line Drawing and  
 use the Adjustable Needle Selector.  
 The Knit side is the right side.

FINISHING: See General Instructions.  
 DRESS: Sew front panel to side panels  
 then sew side seams and shoulder seams.  
 Work 1 row single crochet around back  
 neck opening; sew in a zipper.

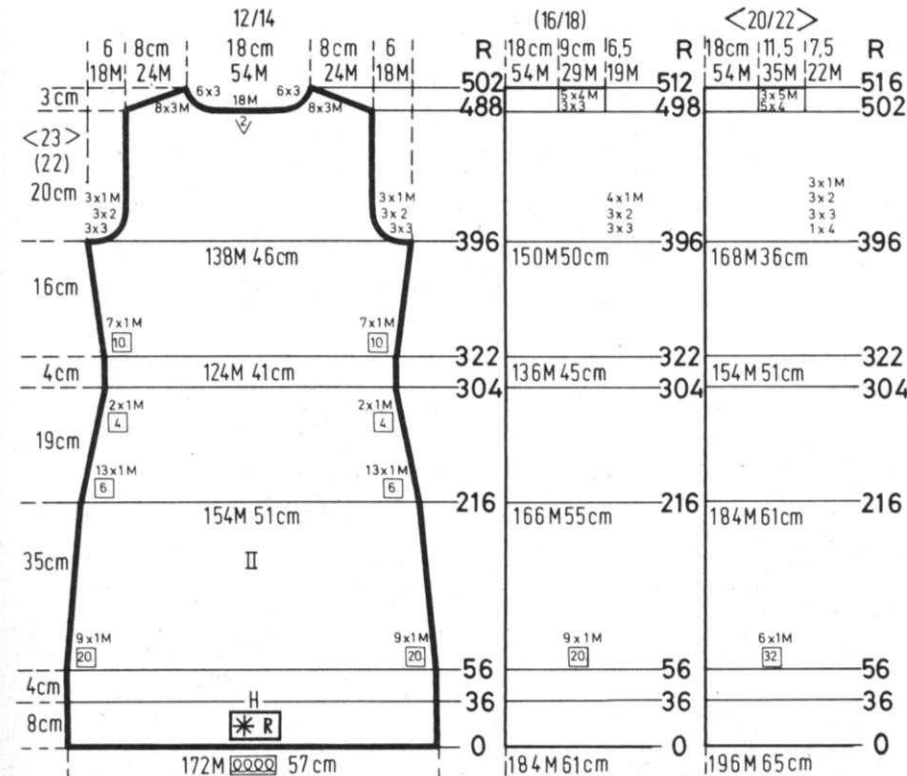

## COAT BACK: II

Bring 172 (184) [196] needles into working  
 position then set into Pattern as in the  
 Line Drawing and cast on. Knit in Pattern.  
 Knit to Row 36, hang the hem and knit  
 to Row 56.

**ON EACH SIDE** decrease 1 st. every  
 20 rows 9x. Knit to Row 216.

**ON EACH SIDE**, decrease 1 st. every 6th

row 13x, every 4th row 2x Knit to Row 322

**ON EACH SIDE**, increase 1 st. every 10th

row 7x. Knit to Row 396.

SHAPE ARMHOLE:

**ON EACH SIDE** bind off

3 sts. 3x, 2 sts. 3x, 1 st. 3x

(3 sts. 3x, 2 sts. 3x, 1 st. 4x)

[4 sts. 1x, 3 sts. 3x, 2 sts. 3x, 1 st. 3x]

Knit to Row 488 (498) [502]

Bind off the center 18 sts. put the

needles on the left into holding position

and complete the right half first.

\* Bind off

FOR SHOULDER

3 sts. 8x

(3 sts. 3x, 4 sts. 5x)

[4 sts. 5x, 5 sts. 3x]

FOR NECK

3 sts. 6x

Same as above

Same as above

Bring the needles on the left side into  
 working position, knit 1 row in pattern to  
 left, turn the Row Counter back to 488  
 (498) [502] and complete the left half.  
 Follow the instructions from \*.



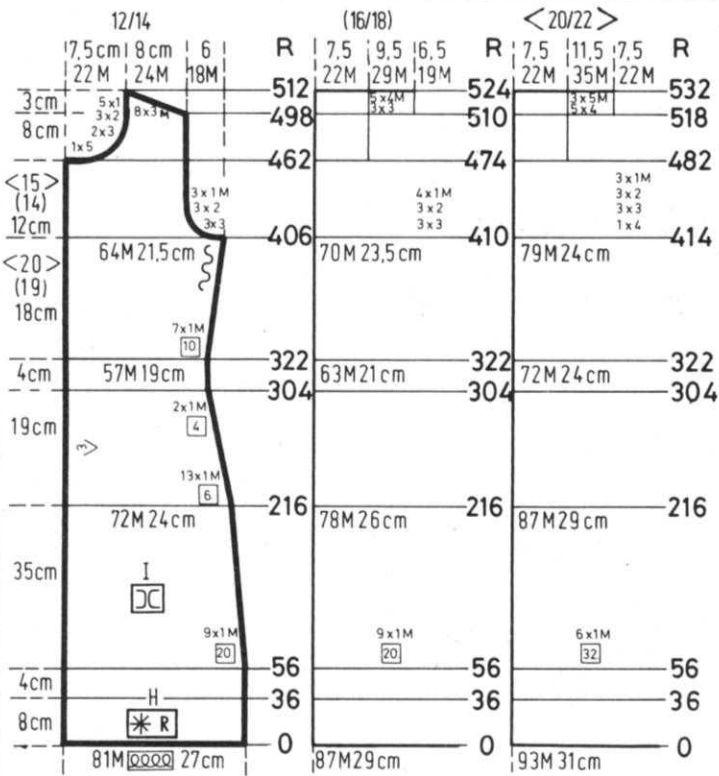

### COAT FRONT: I

Make 1 and Reverse 1  
 Bring 81 (87) [93] needles into working position and set into Pattern as on the Line Drawing. Cast on and knit in Pattern.  
 Knit to Row 36, hang the hem then knit to Row 56.  
 ON SIDE EDGE, decrease 1 st. every 20 rows 9x. Knit to Row 216 ON SIDE EDGE, decrease 1 st. every 6th row 13x, every 4th row 2x Knit to Row 322.  
 ON SIDE EDGE, increase 1 st. every 10th row 7x  
 Knit to Row 406 (410) [414]  
 SHAPE ARMHOLE: Bind off  
 3 sts. 3x, 2 sts. 3x, 1 st. 3x  
 (3 sts. 3x, 2 sts. 3x, 1 st. 4x)  
 [4 sts. 1x, 3 sts. 3x, 2 sts. 3x, 1 st. 3x]  
 Knit to Row 463 (475) [483]  
 ON NECK SIDE bind off  
 5 sts. 1x, 3 sts. 2x, 2 sts. 1x, 1 st. 5x  
 SHAPE SHOULDER after Row 498 (510) [518]  
 Bind off  
 3 sts. 8x  
 (3 sts. 3x, 4 sts. 5x)  
 [4 sts. 5x, 5 sts. 3x]

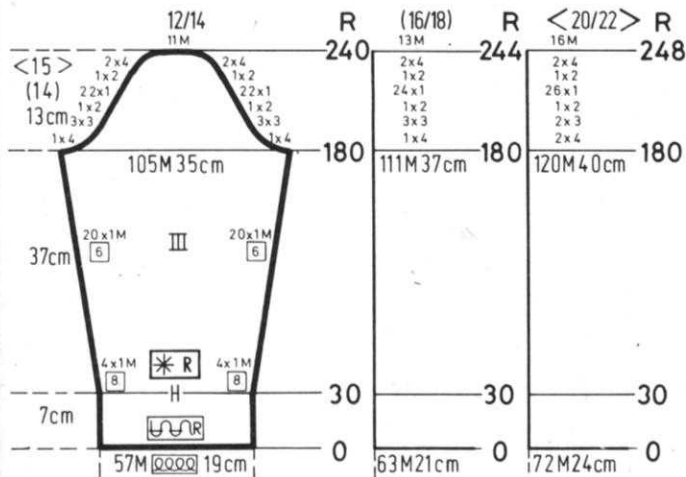

### COAT SLEEVE: III

Cast on 57 (63) [72] sts. and knit in Stockinette stitch to Row 30, hang the hem then set the needles into Pattern as in the Line Drawing and continue in Pattern.  
 ON EACH SIDE, increase 1 st. every 8th row 4x, every 6th row 20x  
 Knit to Row 180  
 SHAPE CAP:  
 ON EACH SIDE bind off  
 4 sts. 1x, 3 sts. 3x, 2 sts. 1x, 1 st. 22x,  
 2 sts. 1x, 4 sts. 2x  
 (4 sts. 1x, 3 sts. 3x, 2 sts. 1x, 1 st. 24x,  
 2 sts. 1x, 4 sts. 2x)  
 [4 sts. 2x, 3 sts. 2x, 2 sts. 1x, 1 st. 26x,  
 2 sts. 1x, 4 sts. 2x]  
 After Row 240 (244) [248] bind off the remaining 11 (13) [16] sts.

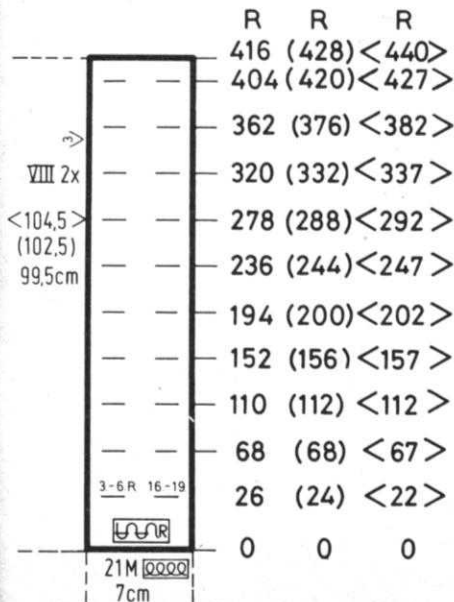

### BUTTONHOLE BAND: VIII

Cast on 21 sts. and work Stockinette stitch. Make Buttonholes over needles 3 to 6 and 16 to 19 counting from the left edge after Rows given for your size as shown on the Chart. After Row 416 (428) [440] bind off all sts.  
 Make a second band but OMIT the BUTTONHOLES.

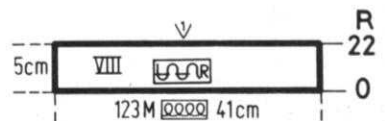

### DRESS NECKBAND: VIII

Cast on 123 sts. and knit 22 rows Stockinette stitch then bind off.

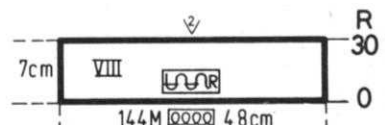

### COAT NECKBAND: VIII

Cast on 144 sts. and knit 30 rows Stockinette stitch then bind off.



# DK 35

## DRESS BACK: II

Cast on 165 (177) [189] sts. and work Stockinette stitch. Knit to Row 34 then hang the hem. Knit to Row 50 ON EACH SIDE decrease 1 st. every 18 rows 9x. Knit to Row 194. ON EACH SIDE decrease 1 st. every 6th row 8x, every 7th row 4x. Knit to Row 286. ON EACH SIDE increase 1 st. every 10th row 7x. Knit to Row 354.

### SHAPE ARMHOLE:

ON EACH SIDE bind off 3 sts. 3x, 2 sts. 2x, 1 st. 4x (3 sts. 3x, 2 sts. 3x, 1 st. 3x) [4 sts. 2x, 3 sts. 2x, 2 sts. 2x, 1 st. 3x]

Knit to Row 396 (404) [408]

Divide in center and put the needles on the left into holding position and complete the right half first.

\*. Knit to Row 434 (442) [446]

Bind off

### FOR SHOULDER

3 sts. 3x, 4 sts. 4x

(4 sts. 5x, 5 sts. 2x)

[5 sts. 6x, 6 sts. 1x]

### FOR NECK

8 sts. 1x, 3 sts. 5x

Same as above

Same as above

Move the Cam Box to the left side, turn the Row Counter back to 396 (404) [408] and complete the left half.

Follow the instructions from \*.

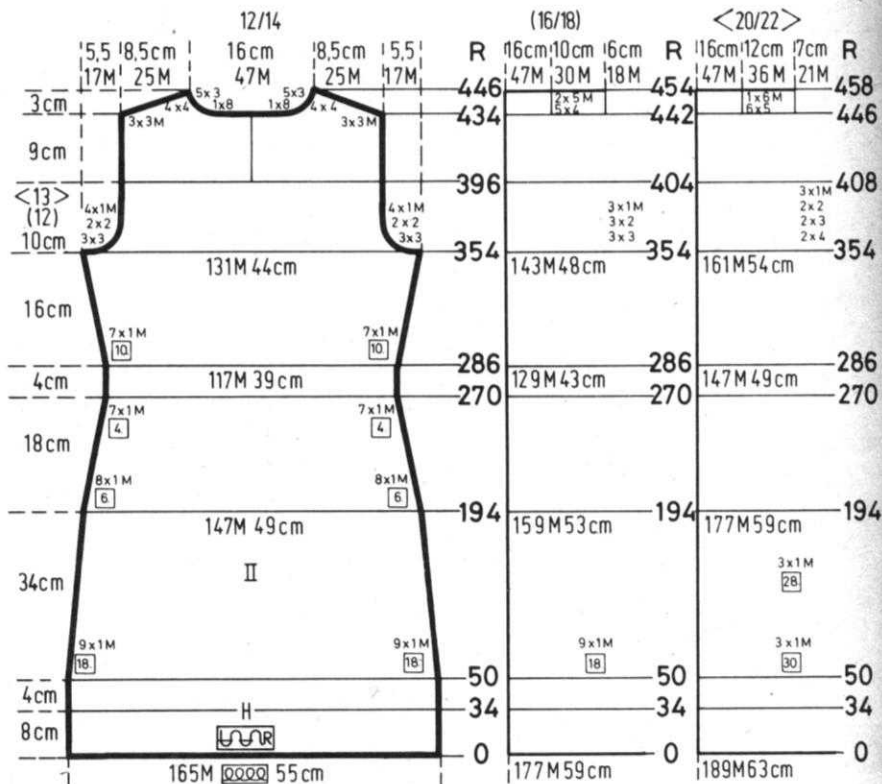

## DRESS CENTER FRONT: I

Bring 80 (90) [102] needles into working position then set into Pattern as in the Line Drawing. Cast on and knit in Pattern. Knit to Row 36 then hang the hem. Knit to Row 454 (466) [476]. Bind off the center 14 sts., put the needles on the left into holding position and complete the right half first.

\* ON NECK SIDE bind off

3 sts. 2x, 2 sts. 3x, 1 st. 5x

### SHAPE SHOULDER after Row

486 (498) [508]

Bind off

2 sts. 2x, 3 sts. 4x

(3 sts. 3x, 4 sts. 3x)

[4 sts. 3x, 5 sts. 3x]

Bring the needles on the left side into working position and knit 1 row in Pattern to the left, turn the Row Counter back to 454 (466) [476] and complete the left half.

Follow the instructions from \*.

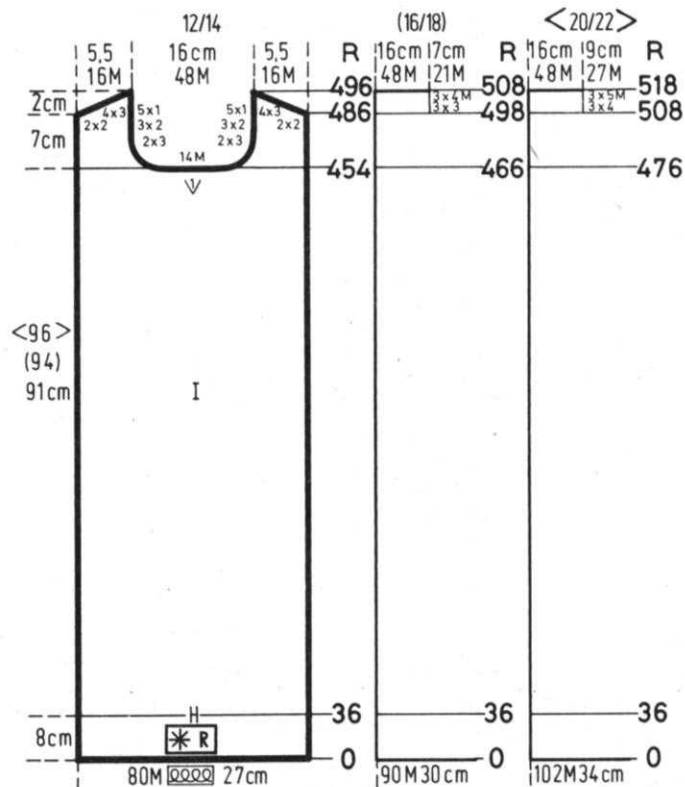



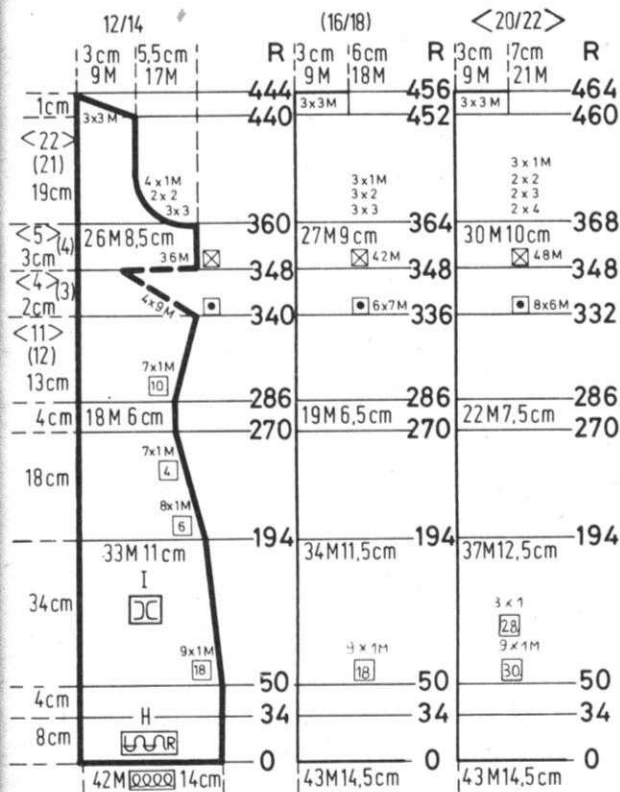

### DRESS SIDE FRONT: I

Make 1, reverse 1  
 Cast on 42 (43) [43] sts. and work Stockinette stitch.  
 Knit to Row 34, hang the hem and continue to Row 50  
 ON SIDE EDGE decrease 1 st. Every 18th row 9x, every 6th row 8x, every 4th row 7x (Every 18th row 9x, every 6th row 8x, every 4th row 7x) [Every 30th row 9x, every 28th row 3x]  
 Knit to Row 286  
 ON SIDE EDGE increase 1 st. every 10th row 7x. After Row 341 (337) [333] SHAPE BUST DART ON OPPOSITE SIDE OF CAM BOX put into holding position 9 sts. 4x (7 sts. 6x) [6 sts. 8x]  
 Bring all the needles back into working position before knitting the next row.  
 Knit to Row 360 (364) [368]  
 SHAPE ARMHOLE: Bind off 3 sts. 3x, 2 sts. 2x, 1 st. 4x (3 sts. 3x, 2 sts. 3x, 1 st. 3x) [4 sts. 2x, 3 sts. 2x, 2 sts. 2x, 1 st. 3x]  
 Knit to Row 440 (452) [460]  
 SHAPE SHOULDER:  
 Bind off 3 sts. 3x

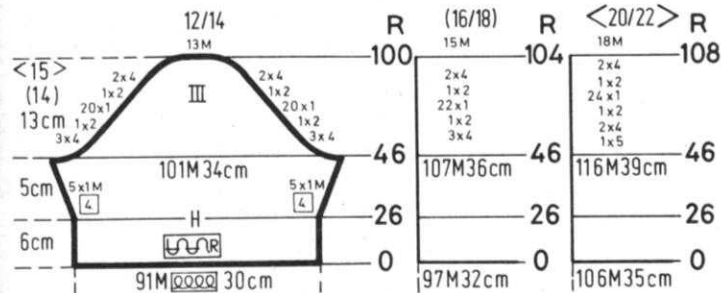
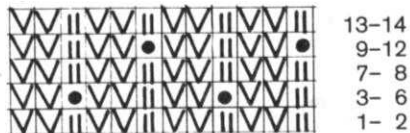

### DRESS SLEEVE:

Cast on 91 (97) [106] sts. and work Stockinette stitch.  
 Knit to Row 26, then hang the hem.  
 ON EACH SIDE, increase 1 st. every 4th row 5x.  
 After Row 46 SHAPE CAP.  
 ON EACH SIDE, bind off 4 sts. 3x, 2 sts. 1x, 1 st. 20x, 2 sts. 1x, 4 sts. 2x (4 sts. 3x, 2 sts. 1x, 1 st. 22x, 2 sts. 1x, 4 sts. 2x)  
 [5 sts. 1x, 4 sts. 2x, 2 sts. 1x, 1 st. 24x, 2 sts. 1x, 4 sts. 2x]  
 After Row 100 (104) [108], bind off the remaining 13 (15) [18] sts.



# DK 36

## WOMAN'S PANTS, JACKET, PULLOVER AND HAT

SIZE: 7/8 (10/12) [14/16]

YARN: Pants and Jacket: Beatrice  
Pullover and Hat: Mohana

50 gr. balls:  
Beatrice 30 (31) [32]  
Mohana 5 (6) [7]

**E** TENSION:  
Beatrice 6 to 8; Mohana 9 to 10  
**P** GAUGE:  
Beatrice: Stockinette stitch:  
16 sts. 22 rows = 5 cm (2")

### JACKET BACK: II





Make 1, reverse 1  
Cast on 98 (102) [108] sts.  
Knit Stockinette stitch to Row 26, hang the hem then set up the needles for Pattern I and continue in Pattern.  
Knit to Row 54  
ON SIDE EDGE decrease 1 st. every 6th row 35x, every 4th row 4x  
Knit to Row 278  
SHAPE ARMHOLE: Bind off  
3 sts. 2x, 2 sts. 2x, 1 st. 4x  
(3 sts. 2x, 2 sts. 3x, 1 st. 3x)  
[4 sts. 1x, 3 sts. 2x, 2 sts. 2x, 1 st. 4x]  
Knit to Row 350  
SHAPE SHOULDER AND NECK AT THE SAME TIME  
Bind off

FOR SHOULDER  
3 sts. 8x  
(3 sts. 5x, 4 sts. 3x)  
[3 sts. 2x, 4 sts. 6x]

FOR NECK  
9 sts. 1x, 2 sts. 6x  
Same as above  
Same as above

### JACKET FRONT: I

Make 1, reverse 1  
Cast on 94 (98) [104] sts.  
Knit Stockinette stitch to Row 26, hang the hem then set up the needles for Pattern I and continue in Pattern.  
Knit to Row 54  
ON SIDE EDGE decrease 1 st. every 6th row 35x, every 4th row 4x  
Knit to Row 278  
SHAPE ARMHOLE: Bind off  
3 sts. 2x, 2 sts. 2x, 1 st. 4x  
(3 sts. 2x, 2 sts. 3x, 1 st. 3x)  
[4 sts. 1x, 3 sts. 2x, 2 sts. 2x, 1 st. 4x]  
Knit to Row 321 (329) [337]  
ON NECK SIDE bind off  
3 sts. 2x, 2 sts. 4x, 1 st. 3x  
SHAPE SHOULDER after Row 350 (360) [370]  
Bind off  
3 sts. 8x  
(3 sts. 5x, 4 sts. 3x)  
[3 sts. 2x, 4 sts. 6x]

Pattern:  
14 sts. 23 rows = 5 cm (2")  I  
Mohana: Stockinette stitch:  
14 sts. 24 rows = 5 cm (2")  II  
Pattern I:  
14 sts. 20 rows = 5 cm (2")  I Pu. & H.  
Pattern II:  
11 sts. 12 rows = 5 cm (2")  II

COAT: Holding position Design with out of work needles that ARE COUNTED in the Stitch Gauge and instructions. Bands and Collar stockinette stitch. PULLOVER: Mock Rib with out of work needles that ARE COUNTED in the Stitch gauge and

instructions. HAT: Holding Position Design same as the Coat. Follow the Line Drawings. The Purl side of Pattern I is the right side, the knit side of Pattern II and Stockinette stitch is the right side. Use the Adjustable Needle Selector for Pattern I.

FINISHING: See General Instructions.  
CAP: Sew seam in cap then gather top, pull up and tie securely.

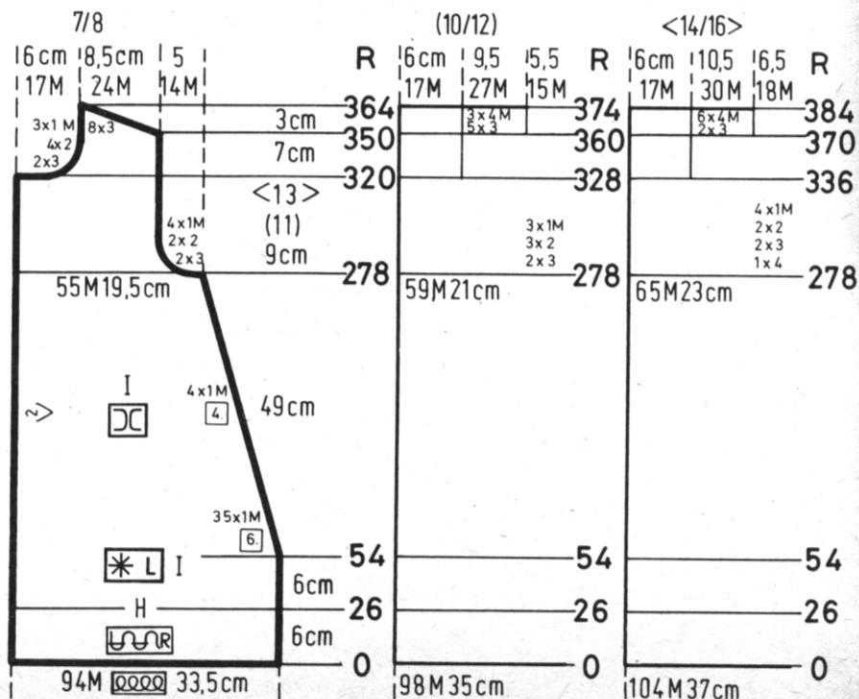
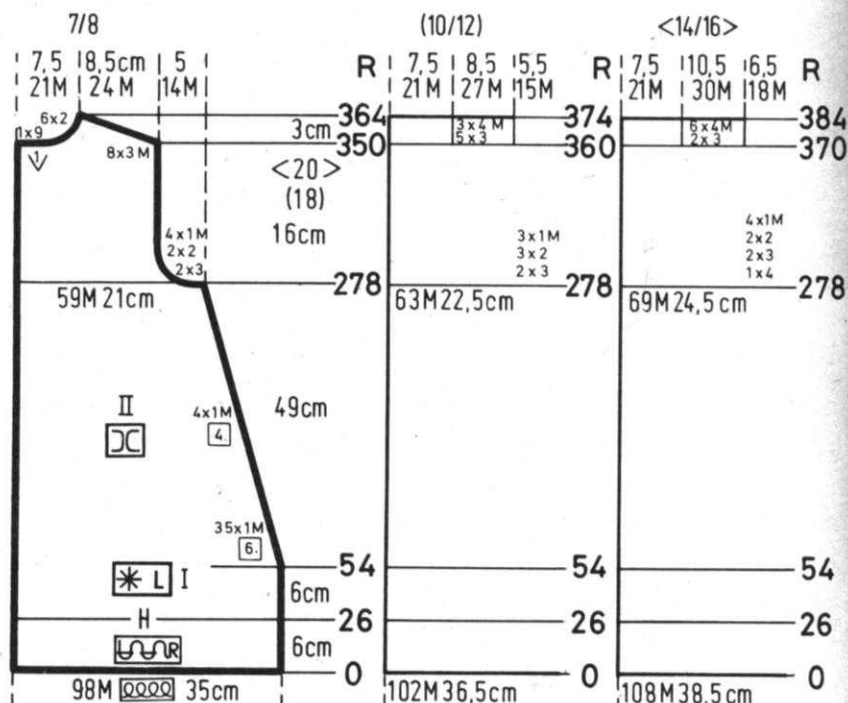



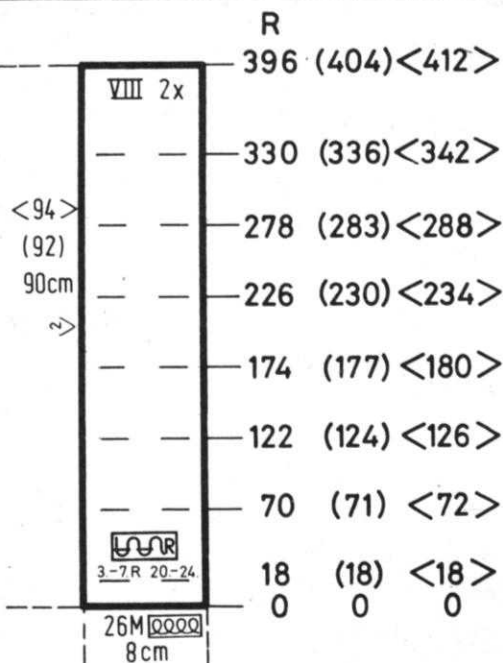

**BUTTONHOLE BAND: VIII**

Cast on 26 sts. and work Stockinette stitch. Make Buttonholes overs needles 3 to 7 and 20 to 24 counting from the left side after Rows given on Chart for your size. After Row 396 (404) [412] bind off. Make the Buttonband the same but OMIT the Buttonholes.

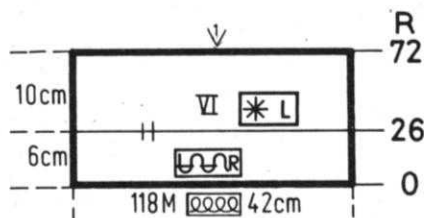

**COAT COLLAR: VI**

Cast on 118 sts. Knit 26 rows Stockinette stitch then change to Pattern I and knit to Row 72. Bind off

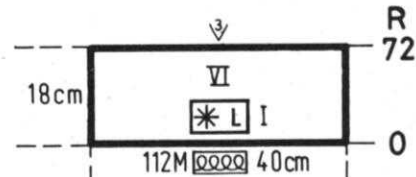

**PULLOVER COLLAR: VI**

Bring 112 needles into working position then set into Pattern as in Line Drawing for Pattern I. Knit to Row 72. Bind off

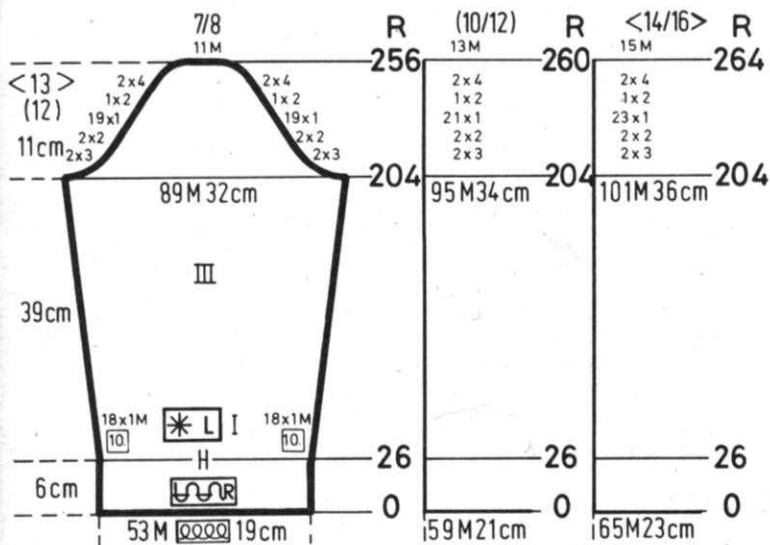

**JACKET SLEEVE: III**

Cast on 53 (59) [65] sts. and knit 26 rows Stockinette stitch. Hang the hem then set the needles for Pattern I. ON EACH SIDE increase 1 st. every 10th row 18x. Knit to Row 204. SHAPE CAP: ON EACH SIDE bind off 3 sts. 2x, 2 sts. 2x, 1 st. 19x, 2 sts. 1x, 4 sts. 2x (3 sts. 2x, 2 sts. 2x, 1 st. 21x, 2 sts. 1x, 4 sts. 2x) [3 sts. 2x, 2 sts. 2x, 1 st. 23x, 2 sts. 1x, 4 sts. 2x] After Row 256 (260) [264] bind off the remaining 11 (13) [15] sts.

**PULLOVER BACK: II**

Cast on 82 (88) [98] sts. and knit 52 rows K1, P1 Ribbing Change to Pattern II. ON EACH SIDE increase 1 st. every 14th row 3x Knit to Row 96 SHAPE ARMHOLE: ON EACH SIDE bind off 3 sts. 1x, 2 sts. 2x, 1 st. 3x (3 sts. 1x, 2 sts. 2x, 1 st. 4x) [3 sts. 2x, 2 sts. 2x, 1 st. 3x] After Row 120 (124) [130] divide in the center and put the needles on the left side into holding position and complete the right half first. \* Knit to Row 134 (138) [144] SHAPE SHOULDER AND NECK AT THE SAME TIME Bind off

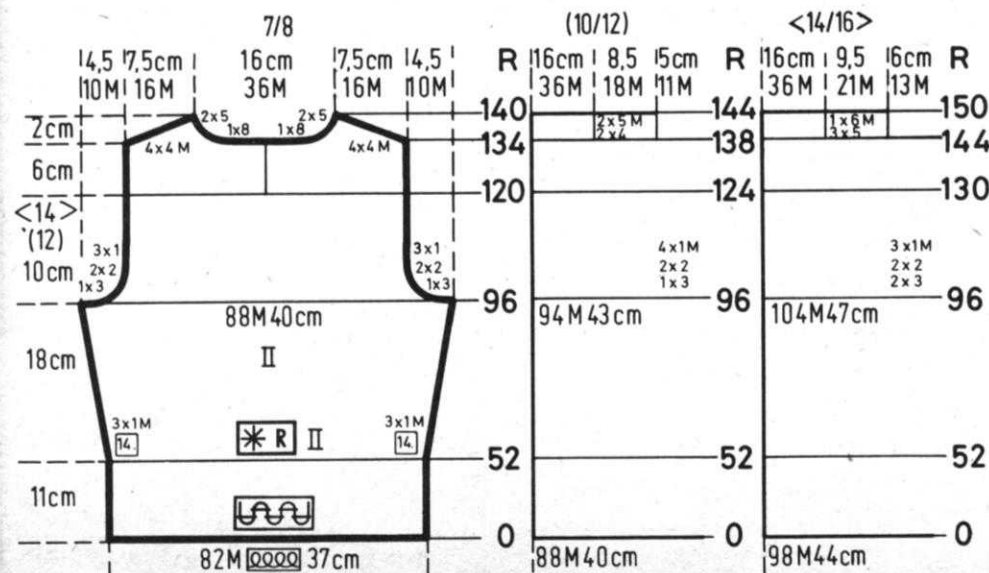

**FOR SHOULDER**

4 sts. 4x  
(4 sts. 2x, 5 sts. 2x)  
[5 sts. 3x, 6 sts. 1x]

**FOR NECK**

8 sts. 1x, 5 sts. 2x  
Same as above  
Same as above

Bring the needles on the left into working position, knit 1 row in pattern to the left side, turn the Row Counter back to 120 (124) [130] and complete the left half. Follow the instructions from \*.



# DK 36

## PULLOVER FRONT: I

Work the front the same as the back to

Row 118 (122) [128]

Bind off the center 12 sts. put the needles on the left side into holding position and complete the right half first.

\* ON NECK SIDE bind off

3 sts. 2x, 2 sts. 2x, 1 st. 2x

SHAPE SHOULDER after Row 134

(138) [144]

Bind off

4 sts. 4x

(4 sts. 2x, 5 sts. 2x)

[5 sts. 3x, 6 sts. 1x]

Bring the needles on the left into working position, knit 1 row in Pattern to the left side, turn the Row Counter back to 118 (122) [128] and complete the left half.

Follow the instructions from \*.

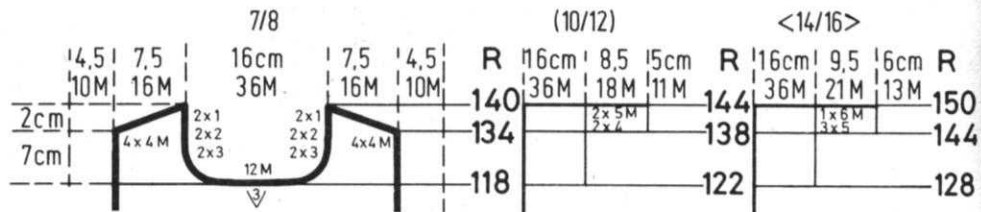

## PULLOVER SLEEVE: III

Bring 40 (44) [48] needles into working position then set up as for Pattern I.

Knit to Row 40

Change to Pattern II.

ON EAC SIDE increase 1 st. every 8th row 3x, every 6th row 11x.

Knit to Row 128

SHAPE CAP:

ON EACH SIDE bind off

4 sts. 2x, 2 sts. 1x, \* 2 sts. 1x, 1 st. 1x and REPEAT from \* 3x more, 2 sts. 1x, 4 sts. 1x.

(4 sts. 2x, 2 sts. 1x, \* 2 sts. 1x, 1 st. 1x and REPEAT from \* 4x more, 2 sts. 1x, 3 sts. 2x).

[5 sts. 1x, 4 sts. 1x, 2 sts. 1x, \* 2 sts. 1x, 1 st. 1x and REPEAT from \* 4x more, 2 sts. 1x, 4 sts. 1x].

After Row 154 (156) [158] bind off the remaining 12 sts.

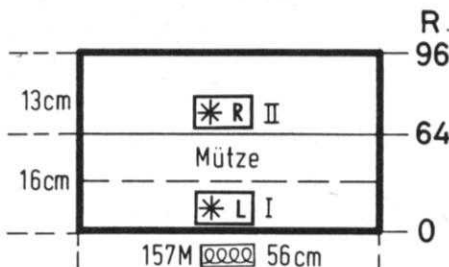
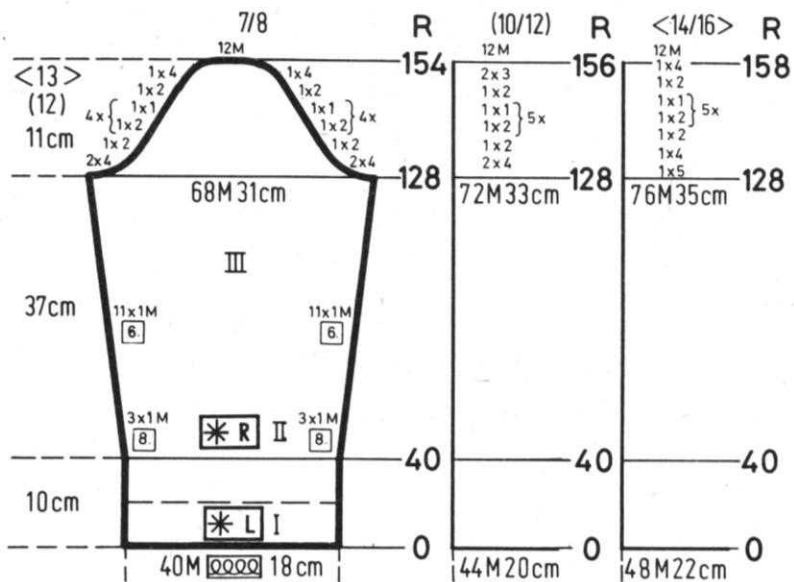

## HAT:

Bring 157 needles into working position

then set up for Pattern I.

Knit to Row 64 then change to Pattern II

and knit to Row 96. Bind off.



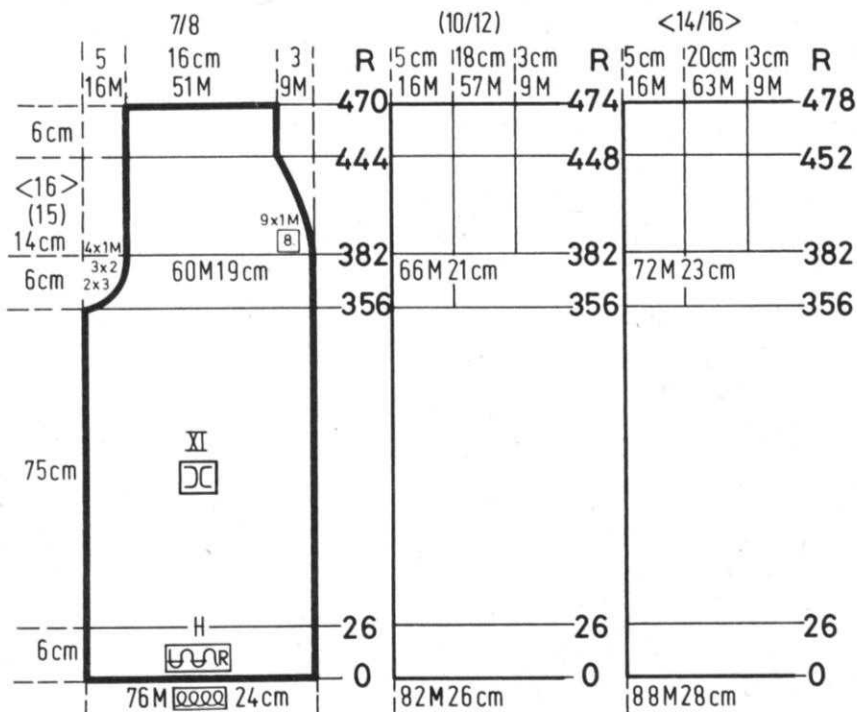

### PANTS FRONT: XI

Make 1, reverse 1  
 Cast on 76 (82) [88] sts. and work Stockinette stitch. Knit to Row 26 then hang the hem  
 Knit to Row 357  
 FOR CENTER FRONT bind off 3 sts. 2x, 2 sts. 3x, 1 st. 4x  
 Knit to Row 382  
 ON SIDE EDGE decrease 1 st. every 8th row 9x.  
 Knit to Row 470 (474) [478]  
 Bind off

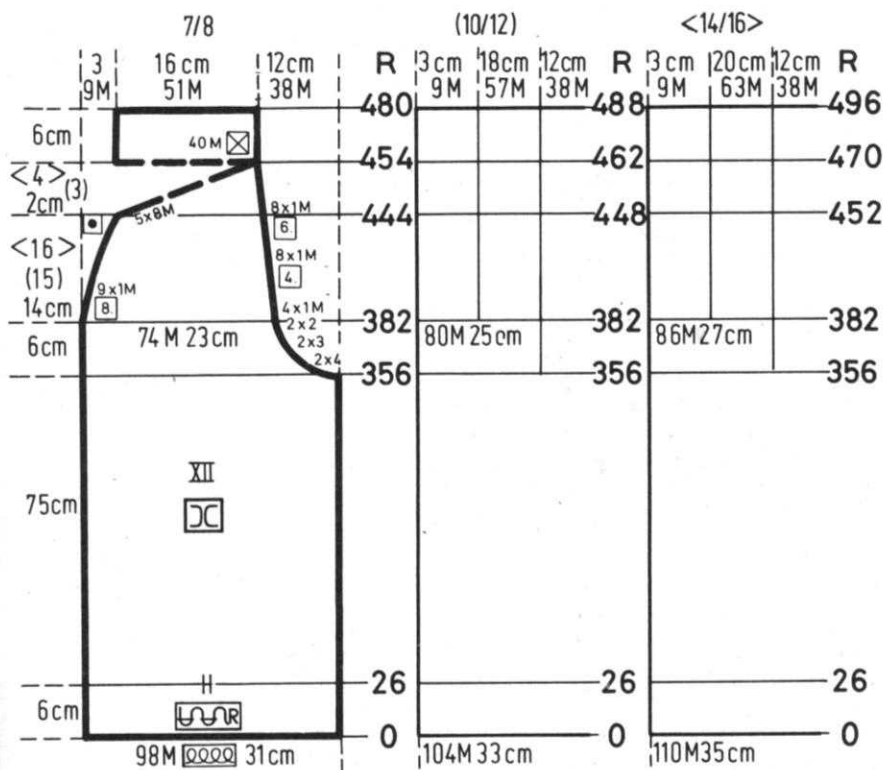

### PANTS BACK: XII

Make 1, reverse 1  
 Cast on 98 (104) [110] sts. and work Stockinette stitch. Knit to Row 26 then hang the hem.  
 Knit to Row 356  
 FOR CENTER FRONT bind off 4 sts. 2x, 3 sts. 2x, 2 sts. 2x, 1 st. 4x, then decrease 1 st. every 4th row 8x, every

6th row 8x AND AT THE SAME TIME AFTER ROW 382 ON SIDE EDGE decrease 1 st. every 8th row 9x.  
 After Row 444 (448) [452] Work Short Rows ON OPPOSITE SIDE OF CAM BOX put into holding position 8 sts. 5x then bring all the needles back into working position before knitting the next row.  
 Knit to Row 480 (488) [496] then bind off.

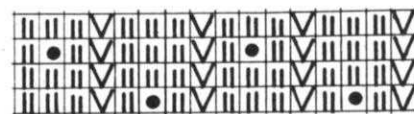

II





# DK 37

## WOMAN'S DRESS AND JACKET

SIZE: 10/12 (14/16) [18/20]

YARN: Color 1 Alanda Tweed  
Color 2 Beatrice  
Color 3 Beatrice

50 gr. balls: C1 19 (20) [21]  
C2 7 (7) [7]  
C3 1 (1) [1]

**E** TENSION: 7 to 9

**P** GAUGE:

Stock:

16 sts. 24 rows = 5 cm (2") 

Pattern:

16 sts. 19 rows = 5 cm (2") 

Dress and Jacket: Mock Rib with out of work needles that ARE COUNTED in the Stitch Gauge and instructions. Bands Stockinette stitch. The Knit side is the right side. Collar and Cuffs: See General Instructions this issue for Loop Stitch. No Instructions for Hat are given but if you want to crochet one (and are clever enough to make up your own directions) you will need 2 extra balls of color 2.

FINISHING: See General Instructions. Sew Cuffs and Collar to Jacket.

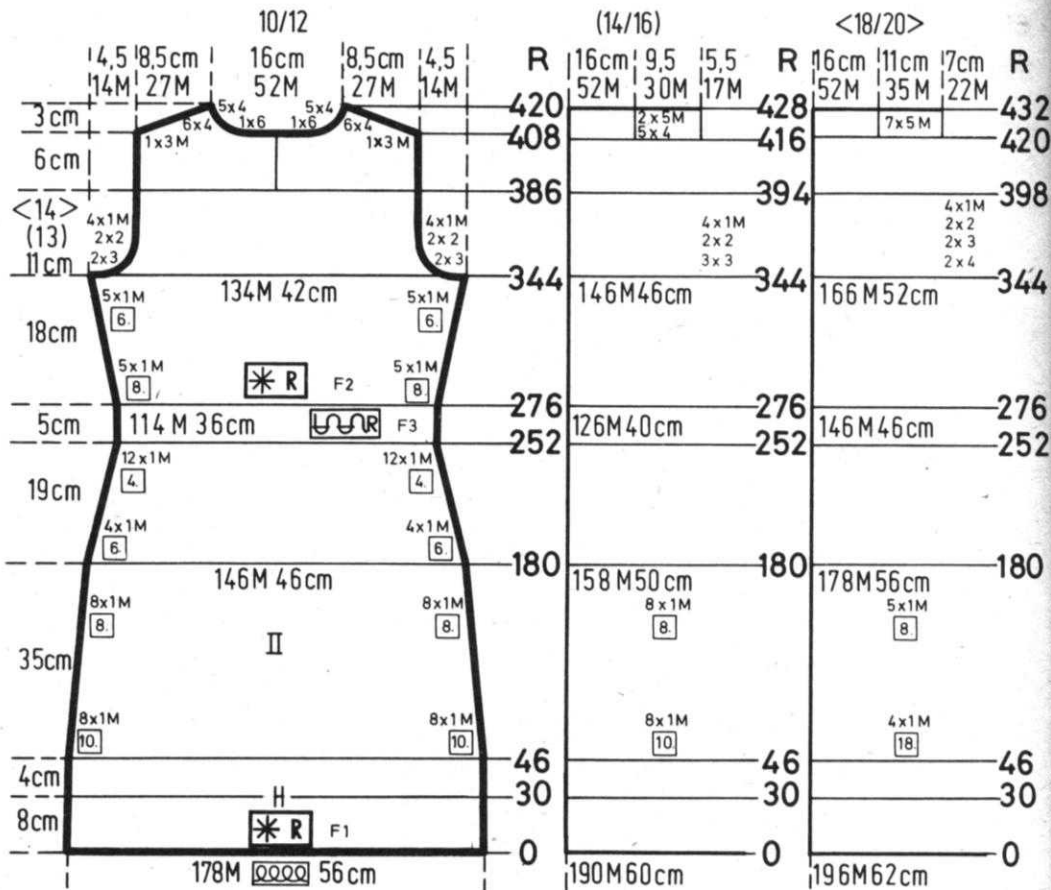

### DRESS BACK: II

Bring 178 (190) [196] needles into working position, set into Mock Rib Pattern as shown on Line Drawing. With color 1. Cast on and knit in Pattern. Knit to Row 30, hang the hem and knit to Row 46.

ON EACH SIDE decrease 1 st.

Every 10th row 8x, every 8th row 8x (Every 10th row 8x, every 8th row 8x) [Every 18th row 4x, every 8th row 5x]

ON EACH SIDE, decrease 1 st.

Every 6th row 4x, every 4th row 12x

After Row 252, change to Color 3 and knit in Stockinette stitch to Row 276.

Change back to Pattern and color 2.

ON EACH SIDE increase 1 st. every 8th row 5x, every 6th row 5x.

After Row 344, SHAPE ARMHOLE:

ON EACH SIDE bind off

3 sts. 2x, 2 sts. 2x, 1 st. 4x

(3 sts. 3x, 2 sts. 2x, 1 st. 4x)

[4 sts. 2x, 3 sts. 2x, 2 sts. 2x, 1 st. 4x]  
After Row 386 (394) [398] divid in the center and put the needles on the left side into holding position and complete the right half first.

\* Knit to Row 408 (416) [420]

Bind off

FOR SHOULDER

3 sts. 1x, 4 sts. 6x

(4 sts. 4x, 5 sts. 2x)

[5 sts. 7x]

FOR NECK

6 sts. 1x, 4 sts. 5x

Same as above

Same as above

Bring the needles on the left into working position, knit 1 row in Pattern to the left side, turn the Row Counter back to 386 (394) [398] and complete the left half. Follow the instructions from \*.



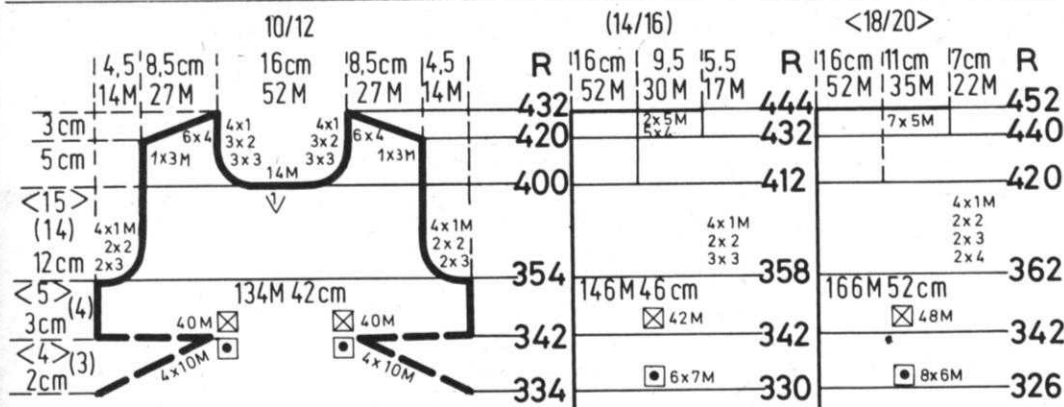

**DRESS FRONT: I**

Work the front the same as the back to Row 334 (330) [326] then work Short Rows for the Bust Darts.

ON OPPOSITE SIDE OF CAM BOX put into holding position

10 sts. 4x ON EACH SIDE

(7 sts. 6x ON EACH SIDE)

[6 sts. 8x ON EACH SIDE]

Bring all the needles back into working position before knitting the next 2 rows.

Knit to Row 354 (358) [362]

SHAPE ARMHOLE:

ON EACH SIDE Bind off

3 sts. 2x, 2 sts. 2x, 1 st. 4x

(3 sts. 3x, 2 sts. 2x, 1 st. 4x)

[4 sts. 2x, 3 sts. 2x, 2 sts. 2x, 1 st. 4x]

Knit to Row 400 (412) [420]

Bind off the center 14 sts, put the needles on the left side into holding position and complete the right half first.

\* Bind off

FOR SHOULDER

3 sts. 1x, 4 sts. 6x

(4 sts. 5x, 5 sts. 2x)

[5 sts. 7x]

FOR NECK

3 sts. 3x, 2 sts. 3x, 1 st. 4x

Same as above

Same as above

Bring the needles on the left into working position, turn the Row Counter back to 400 (412) [420] and complete the left half.

Follow the instructions from \*.

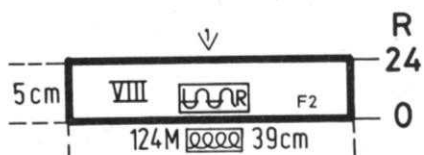
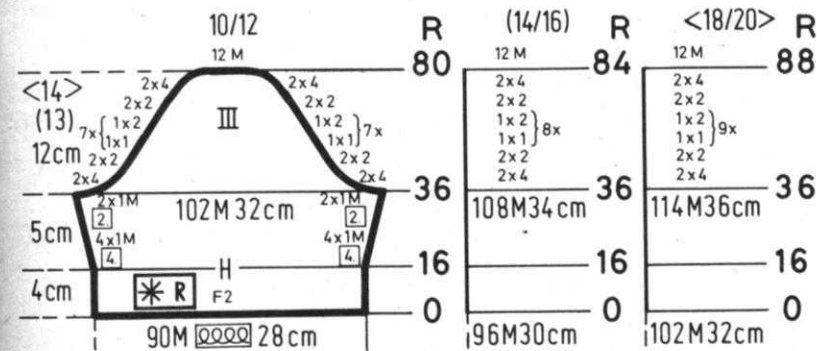

**DRESS NECKBAND: VIII**

Cast on 124 sts. with color 2 and work 24 rows stockinette stitch then bind off.

**DRESS SLEEVE: III**

Bring 90 (96) [102] needles into working position then set into Pattern and cast on with color 2. Knit in Pattern.

Knit to Row 16 then hang the hem.

ON EACH SIDE, increase 1 st. every 4th row 4x, every 2nd row 2x.

AFTER ROW 36, SHAPE ARMHOLE:

ON EACH SIDE bind off

4 sts. 2x, 2 sts. 2x, \* 1 st. 1x, 2 sts. 1x

and REPEAT from \* 6x more,

2 sts. 2x, 4 sts. 2x

(4 sts. 2x, 2 sts. 2x, \* 1 st. 1x, 2 sts. 1x

and REPEAT from \* 7x more,

2 sts. 2x, 4 sts. 2x

[4 sts. 2x, 2 sts. 2x, \* 1 st. 1x, 2 sts. 1x

and REPEAT from \* 8x more,

2 sts. 2x, 4 sts. 2x]

After Row 80 (84) [88] bind off the

remaining 12 sts.

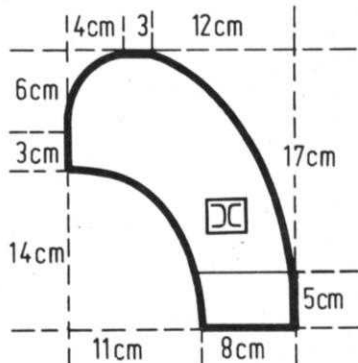

COLLAR - Crochet Loop Stitch. See General Instructions this issue.

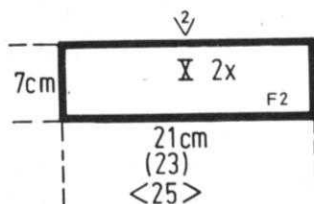

CUFFS - Crochet Loop Stitch. See General Instructions this issue.



# DK 37

## JACKET BACK: II

Cast on 132 (144) [165] sts. with color 1 and knit in Stockinette stitch to Row 60, hang the hem. Change to Pattern.

ON EACH SIDE, increase 1 st. every 16th row 5x. Knit to Row 140.

### SHAPE ARMHOLE:

ON EACH SIDE bind off

3 sts. 3x, 2 sts. 2x, 1 st. 3x

(3 sts. 3x, 2 sts. 3x, 1 st. 4x)

[4 sts. 2x, 3 sts. 2x, 2 sts. 3x, 1 st. 4x]

Knit to Row 208 (216) [220]

Bind off the center 12 sts., put the needles on the left side into holding position and complete the right half first.

\* Bind off

### FOR SHOULDER

4 sts. 6x, 5 sts. 1x

(4 sts. 3x, 5 sts. 4x)

[5 sts. 5x, 6 sts. 2x]

### FOR NECK

4 sts. 5x

Same as above

Same as above

Bring the needles on the left into working position, knit 1 row in Pattern to the left side, turn the Row Counter back to 208 (216) [220] and complete the left half. Follow the instructions from \*.

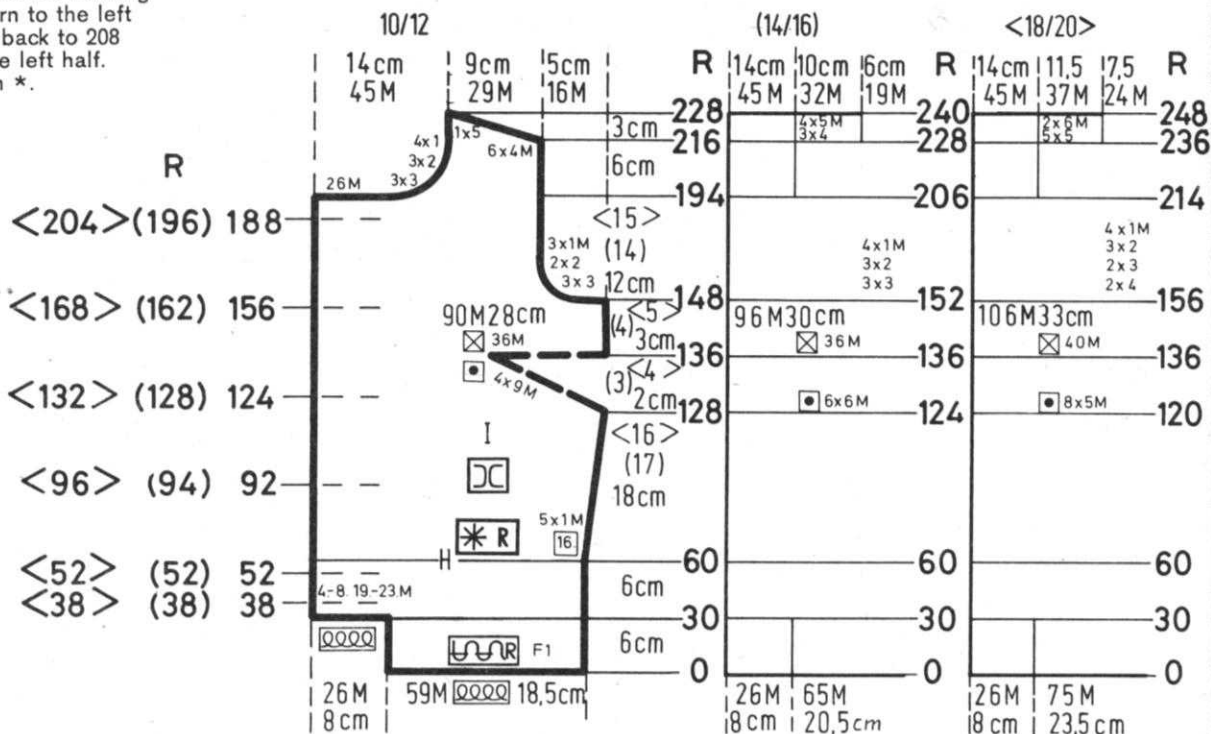
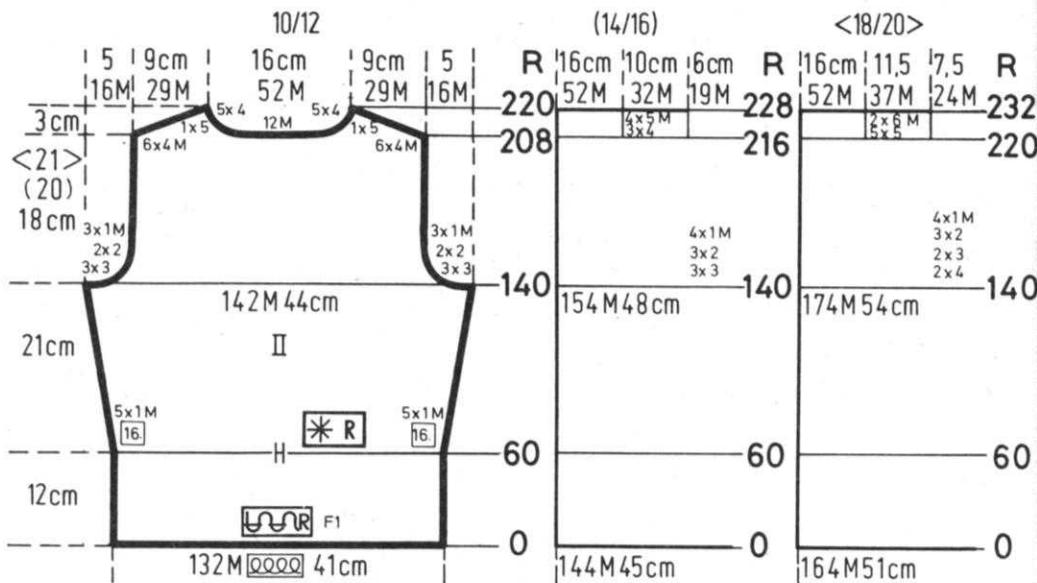

## JACKET FRONT: I

Cast on 59 (65) [75] sts. with color 1.

Knit in Stockinette stitch to Row 30.

With a Separate yarn, cast on 26 sts. on the left (right for second section)

Continue in Stockinette stitch BUT AT THE SAME TIME MAKE BUTTONHOLES over needles 4 to 8 and 19 to 23 counting from the left after Rows 38 and 52.

Knit to Row 60 then hang the hem.

Change to Pattern. Make BUTTONHOLES over same needles as before after Rows shown on Chart for your size and ON SIDE EDGE increase 1 st. every 16th row 5x.

Work BUST DART after Row 129 (125) [121]

ON OPPOSITE SIDE OF CAM BOX put into holding position

9 sts. 4x

(6 sts. 6x)

[5 sts. 8x]

Bring all the needles back into working position before knitting the next row.

Knit to Row 148 (152) [156]

SHAPE ARMHOLE: Bind off

3 sts. 3x, 2 sts. 2x, 1 st. 3x

(3 sts. 3x, 2 sts. 3x, 1 st. 4x)

[4 sts. 2x, 3 sts. 2x, 2 sts. 3x, 1 st. 4x]

Knit to Row 195 (207) [215]

SHAPE NECK: Bind off 26 sts., then bind off 3 sts. 3x, 2 sts. 3x, 1 st. 4x.

SHAPE SHOULDER after Row 216

(228) [236]

Bind off

4 sts. 6x, 5 sts. 1x

(4 sts. 3x, 5 sts. 4x)

[4 sts. 2x, 3 sts. 2x, 2 sts. 3x, 1 st. 4x]

Make second section with reverse shaping but OMIT the BUTTONHOLES.



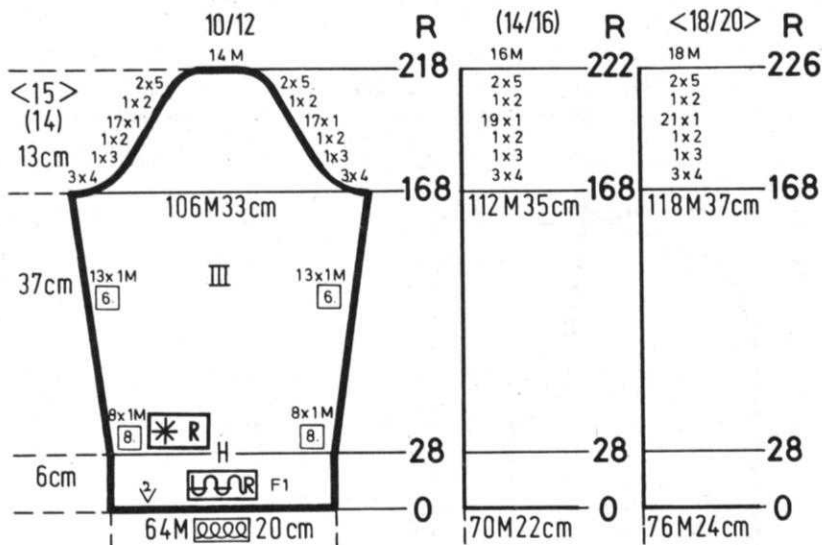

### JACKET SLEEVE: III

Cast on 64 (70) [76] sts. with color 1. Knit in Stockinette stitch to Row 28, hang the hem. Change to Pattern and continue. ON EACH SIDE increase 1 st. every 8th row 8x, every 6th row 13x. Knit to Row 168.

#### SHAPE CAP:

ON EACH SIDE bind off  
4 sts. 3x, 3 sts. 1x, 2 sts. 1x, 1 st. 17x,  
2 sts. 1x, 5 sts. 2x  
(4 sts. 3x, 3 sts. 1x, 2 sts. 1x, 1 st. 19x,  
2 sts. 1x, 5 sts. 2x)  
[4 sts. 3x, 3 sts. 1x, 2 sts. 1x, 1 st. 21x,  
2 sts. 1x, 5 sts. 2x]  
After Row 218 (222) [226] bind off the remaining 14 (16) [18] sts.

# DK 38

## WOMAN'S PANTS, JACKET AND PULLOVER

SIZE: 8/10 (12/14) [16/18]

YARN: Amoretta

50 gr. balls: 20 (21) [22]

**E** TENSION: 8 to 10

**P** GAUGE:

Pattern:

15 sts. 18 rows = 5 cm (2")

15 sts. 26 rows = 5 cm (2")

Mock Rib with needles out of work that ARE COUNTED in the Stitch Gauge and instructions. Follow the Line Drawing. COLLAR: Loop Stitch Crochet (see General Instructions).

FINISHING: See General Instructions. Work 1 row single crochet around back neck opening of Pullover then sew on Hooks and Eyes.

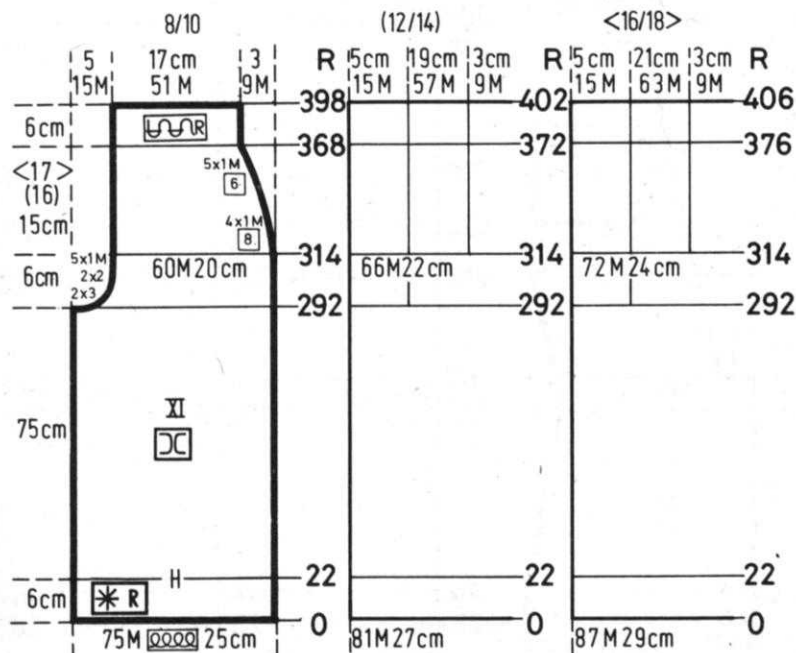

### PANTS FRONT: XI

Make 1, reverse 1  
Bring 75 (81) [87] needles into working position, set into Mock Rib Pattern. Cast on and knit in Pattern. Knit to Row 22, hang the hem. Knit to Row 293  
FRONT SHAPING ROW 293  
Bind off  
3 sts. 2x, 2 sts. 2x, 1 st. 5x  
SIDE SHAPING ROW 314  
Decrease  
1 st. every 8th row 4x, every 6th row 5x  
Knit to Row 368 (372) [376]  
Change to Stockinette stitch and knit to Row 398 (402) [406]. Bind off.



# DK 38

## PANTS BACK: XII

Make 1, reverse 1  
 Bring 96 (102) [108] needles into working position, set into Mock Rib Pattern.  
 Cast on and knit in Pattern.  
 Knit to Row 292  
**CENTER BACK SHAPING ROW 292**  
 Bind off  
 4 sts. 2x, 3 sts. 2x, 2 sts. 2x,  
 1 st. 6x, 1 st. every 4th row 6x,  
 1 st. every 6th row 6x  
**SIDE EDGE SHAPING ROW 314**  
 Decrease  
 1 st. every 8th row 4x, every 6th row 5x  
 After Row 368 (372) [376] Work Short Rows: ON OPPOSITE SIDE OF CAM BOX put into holding position 15 sts. 3x.  
 Bring all the needles back into working position before knitting the next row.  
 After Row 374 (382) [390] change to Stockinette stitch and knit to Row 404 (412) [420] then bind off.

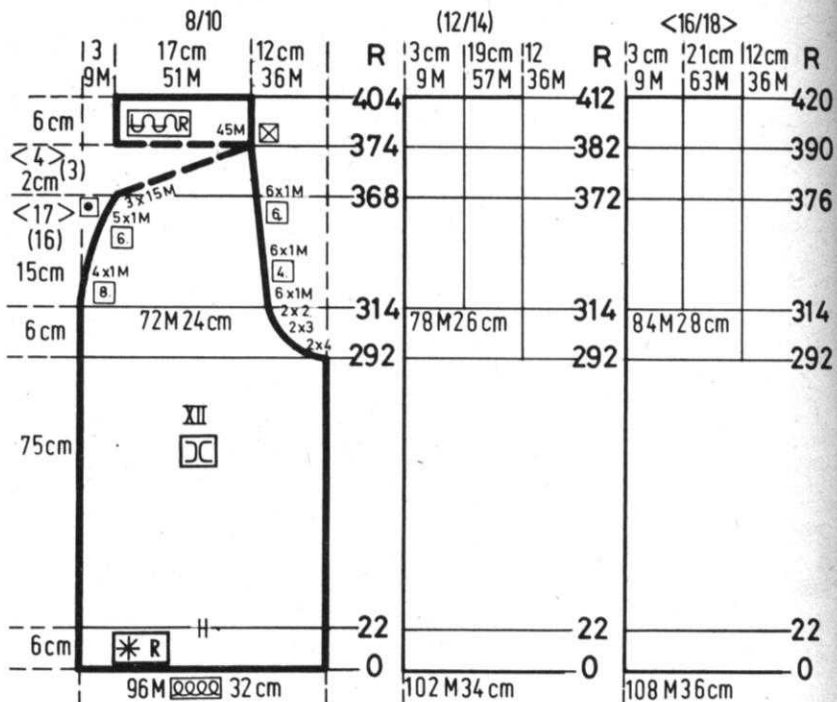

## JACKET FRONT: I

Make 1, reverse 1  
 Bring 93 (99) [107] needles into working position, set into Mock Rib Pattern. Cast on and knit in Pattern.  
 Knit to Row 28 then with a separate yarn cast on 12 sts. on the left (right for second section) side.  
 Knit to Row 44, hang the hem.  
**ON SIDE EDGE decrease 1 st. every 10th row 3x, every 8th row 11x. Knit to Row 166. Take the 12 sts. on the left off onto a stitch holder (right for second section).**  
**ON SIDE EDGE, increase 1 st. every 16th row 4x AND AT THE SAME TIME ON NECK SIDE decrease 1 st. every 2nd row 20x, every 4th row 24x AND AT THE SAME TIME work Short Rows for the Bust Dart, after Row 217 (212) [208]**  
**ON OPPOSITE SIDE OF CAM BOX Put into holding position.**  
 12 sts. 3x  
 (8 sts. 5x)  
 [6 sts. 7x]  
 Bring all the needles back into working position before knitting the next Row.  
**AFTER ROW 232 (236) [240] SHAPE ARMHOLE: Bind off.**  
 3 sts. 2x, 2 sts. 2x, 1 st. 3x  
 (3 sts. 3x, 2 sts. 2x, 1 st. 3x)  
 [4 sts. 2x, 3 sts. 2x, 2 sts. 2x, 1 st. 3x]  
**SHAPE SHOULDER after Row 296 (304) [312]**  
 Bind off  
 4 sts. 4x, 5 sts. 2x  
 (4 sts. 1x, 5 sts. 5x)  
 [5 sts. 4x, 6 sts. 2x]

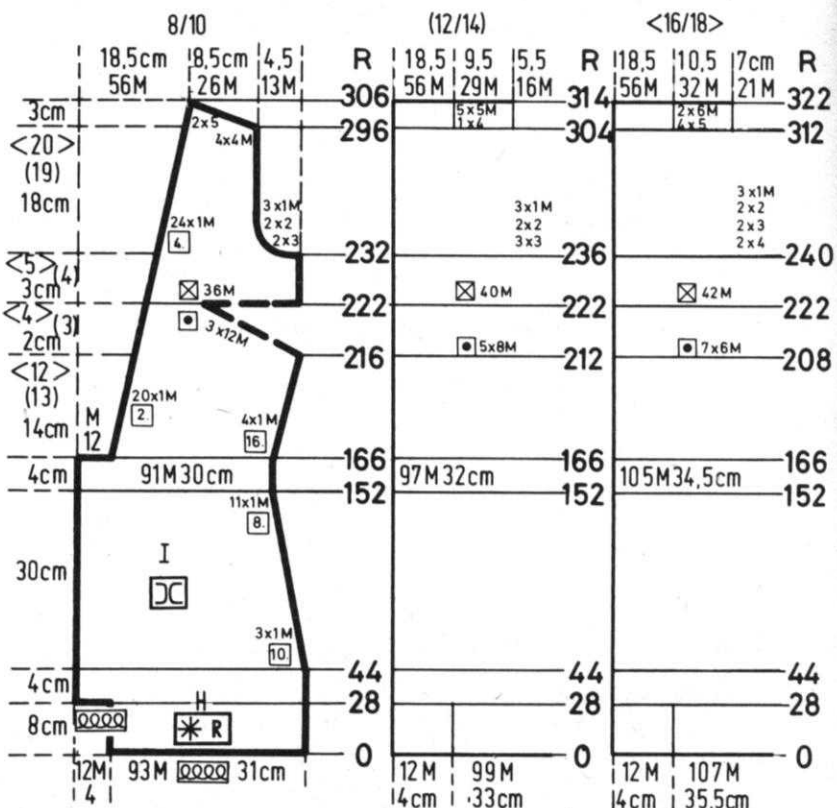





# DK 38

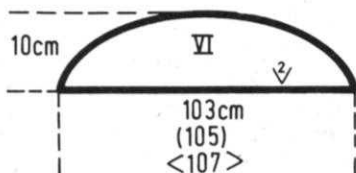

**COLLAR:**  
Crochet Loop Stitch; see  
General Instructions.

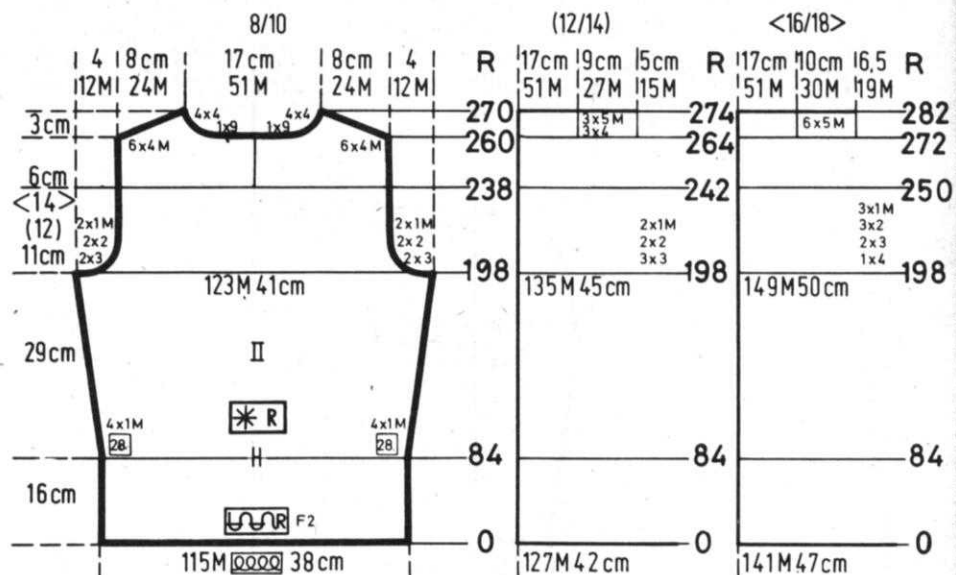

## PULLOVER FRONT:

Work the front section the same as the back section to Row 178, then work Short Rows for the BUST DARTS.

ON OPPOSITE SIDE OF CAM BOX, put into holding position

12 sts. 3x ON EACH SIDE

(8 sts. 5x ON EACH SIDE)

[6 sts. 7x ON EACH SIDE]

Bring all the needles back into working position before knitting the next 2 rows.

Knit to Row 194 (198) [202]

SHAPE ARMHOLE: Bind off

3 sts. 2x, 2 sts. 2x, 1 st. 2x

(3 sts. 3x, 2 sts. 3x, 1 st. 2x)

[4 sts. 1x, 3 sts. 2x, 2 sts. 3x, 1 st. 3x]

Knit to Row 234 (242) [250]

Bind off the center 11 sts. put the needles on the left side into holding position and complete the right half first.

\* Bind off

FOR NECK:

4 sts. 2x, 3 sts. 2x, 2 sts. 2x, 1 st. 2x

SHAPE SHOULDER after Row 256

(264) [272]

Bind off

4 sts. 6x

(4 sts. 3x, 5 sts. 3x)

[5 sts. 6x]

Bring the needles on the left into working position, knit 1 row in Pattern to the left side, turn the Row Counter back to 234 (242) [250] and complete the left half.

Follow the instructions from \*.

## PULLOVER BACK:

Cast on 115 (127) [141] sts. with color 2. Knit in Stockinette stitch to Row 84, hang the hem then CHANGE to MOCK RIB Pattern.

ON EACH SIDE increase 1 st. every 28th row 4x. Knit to Row 198.

SHAPE ARMHOLE:

ON EACH SIDE bind off

3 sts. 2x, 2 sts. 2x, 1 st. 2x

(3 sts. 3x, 2 sts. 2x, 1 st. 2x)

[4 sts. 1x, 3 sts. 2x, 2 sts. 3x, 1 st. 3x]

Knit to Row 238 (242) [250] Divide in center and put the needles on the left side into holding position and complete the right half first.

\* Knit to Row 260 (264) [272]

Bind off

FOR SHOULDER  
4 sts. 5x  
(4 sts. 3x, 5 sts. 3x)  
[5 sts. 6x]

FOR NECK  
9 sts. 1x, 4 sts. 4x  
(Same as above)  
[Same as above]

Bring the needles on the left into working position, knit 1 row in Pattern to the left side, turn the Row Counter back to 238 (242) [250] and complete the left half.

Follow the instructions from \*.

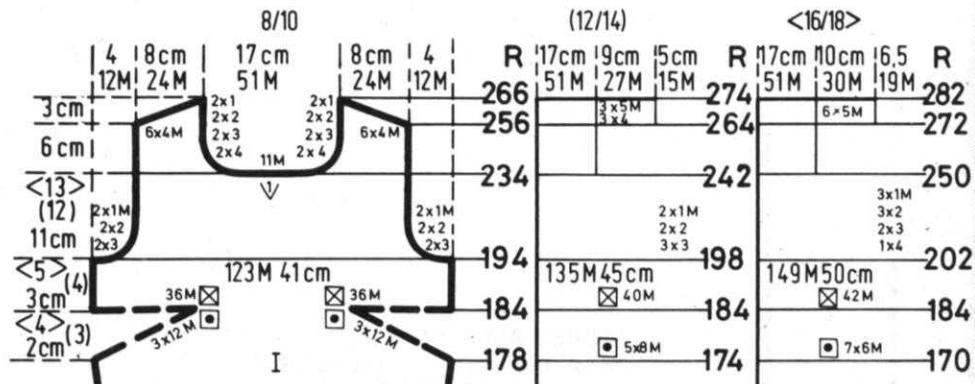



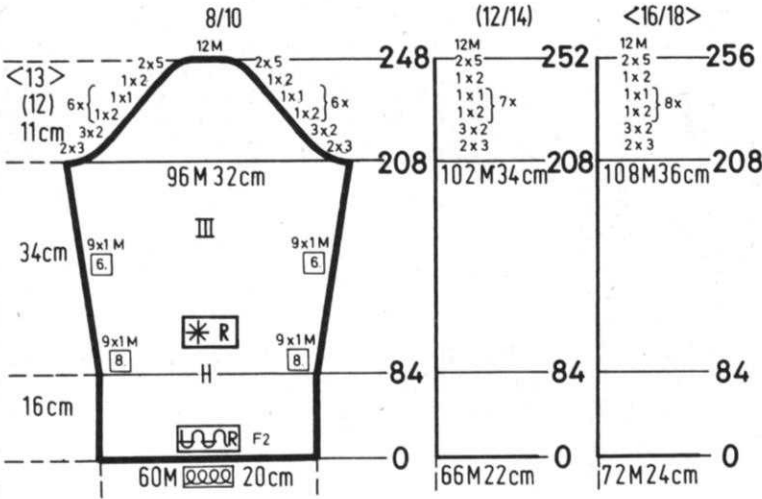

**PULLOVER SLEEVE: III**

Cast on 60 (66) [72] sts. with color 2 and knit Stockinette stitch to Row 84. Hang the hem then change to **MOCK RIB** Pattern.

ON EACH SIDE, increase 1 st. every 8th row 9x, every 6th row 9x. Knit to Row 208.

**SHAPE CAP:**

ON EACH SIDE bind off  
 3 sts. 2x, 2 sts. 3x, \* 2 sts. 1x, 1 st. 1x and REPEAT from \* 5x more,  
 2 sts. 1x, 5 sts. 2x  
 (3 sts. 2x, 2 sts. 3x, \* 2 sts. 1x, 1 st. 1x and REPEAT from \* 6x more,  
 2 sts. 1x, 5 sts. 2x)  
 [3 sts. 2x, 2 sts. 3x, \* 2 sts. 1x, 1 st. 1x and REPEAT from \* 7x more,  
 2 sts. 1x, 5 sts. 2x]  
 After Row 248 (252) [256] bind off the remaining 12 sts.

**DK 39**

**WOMAN'S DRESS AND JACKET**

SIZE: 7/8 (10/12) [14/16]  
 YARN: Crocus  
 50 gr. balls: 25 (26) [27]

**E** TENSION: 7 to 9

**P** GAUGE:  
 Stock:  
 16 sts. 22 rows = 5 cm (2'')   
 Pattern:  
 16 sts. 28 rows = 5 cm (2'')

Stockinette stitch and a Holding Position Design with needles out of work that ARE COUNTED in the stitch gauge and Instructions. The Purl side of Pattern is the right side, the knit side for Stockinette stitch. Use the Adjustable Needle Selector for Pattern.

**FINISHING:** See General Instructions. Sew Hood to Jacket (see picture).

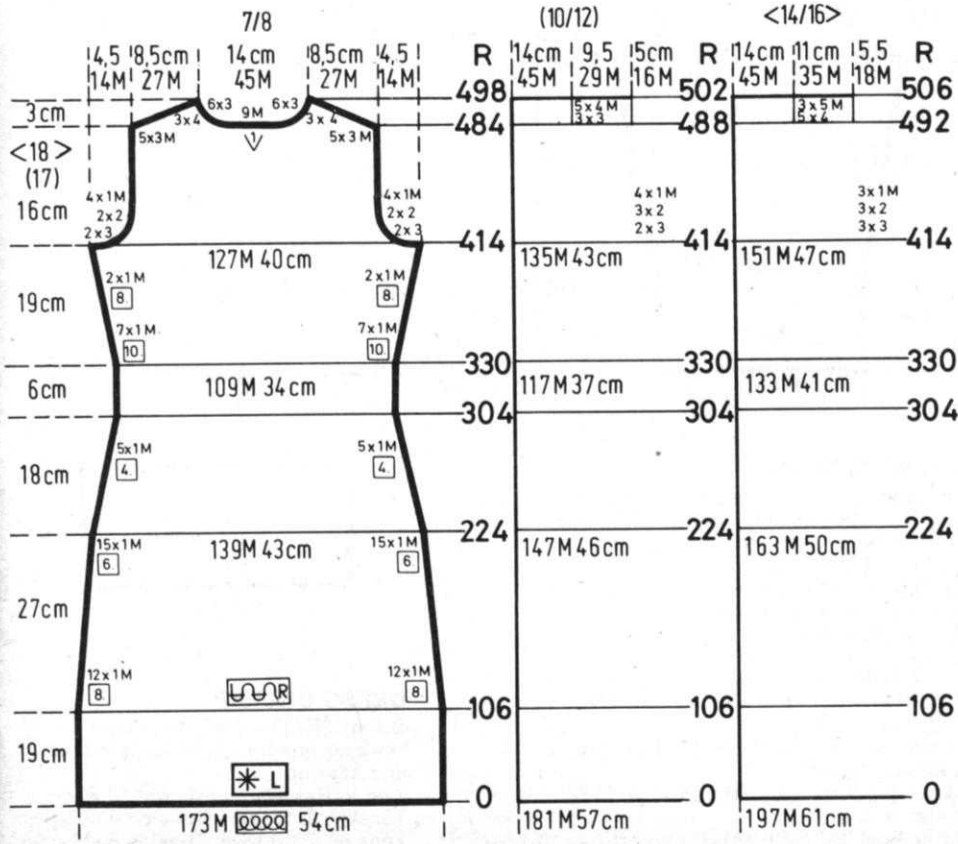

**DRESS BACK:**

Bring 173 (181) [197] needles into working position then set into Pattern as shown on the Line Drawing. Cast on. Knit in Pattern to Row 106 then continue in Stockinette stitch.

ON EACH SIDE, decrease 1 st. every 8th row 12x, every 6th row 15x, every 5th row 5x. Knit to Row 330.

ON EACH SIDE increase 1 st. every 10th row 7x, every 8th row 2x. Knit to Row 414.

**SHAPE ARMHOLE:**

ON EACH SIDE bind off  
 3 sts. 2x, 2 sts. 2x, 1 st. 4x  
 (3 sts. 2x, 2 sts. 3x, 1 st. 4x)  
 [3 sts. 3x, 2 sts. 3x, 1 st. 3x]  
 Knit to Row 484 (488) [492] Bind off the center 9 sts. put the needles on the left into holding position and complete the right half first.  
 \* Bind off

**FOR SHOULDER**

3 sts. 5x, 4 sts. 3x  
 (3 sts. 3x, 4 sts. 5t)  
 [4 sts. 5x, 5 sts. 3x]

**FOR NECK**

3 sts. 6x  
 (Same as above)  
 [Same as above]

Move the Cam Box to the left side, turn the Row Counter back to 484 (488) [492] and complete the left half. Follow the instructions from \*.

# DK 39

## DRESS FRONT: I

Bring 80 (84) [92] needles into working position then set into Pattern and cast on. Knit in Pattern to Row 22 then cast on 26 on the left side (right for second section). Knit in Pattern to Row 106 then change to Stockinette stitch.

ON FRONT EDGE, make **BUTTONHOLES** over needles 3 to 7 and 20 to 24 counting from the left edge after Row shown on the Chart and **AT THE SAME TIME** begin the side shaping after Row 106.

Decrease 1 st at side edge every 8th row 12x, every 6th row 15x, every 4th row 6x.

Knit to Row 330

ON SIDE EDGE, increase 1 st. every 10th row 7x, every 8th row 2x.

Knit to Row 414

**SHAPE ARMHOLE:** Bind off

3 sts. 2x, 2 sts. 2x, 1 st. 4x

(3 sts. 2x, 2 sts. 3x, 1 st. 4x)

[3 sts. 3x, 2 sts. 3x, 1 st. 3x]

Knit to Row 467. **SHAPE NECK:** Bind off 26 sts. 1x, 3 sts. 2x, 2 sts. 3x, 1 st. 4x.

**SHAPE SHOULDER** after Row 484

(488) [492]. Bind off

4 sts. 3x, 3 sts. 5x

(3 sts. 3x, 4 sts. 5x)

[4 sts. 5x, 5 sts. 3x]

Knit the second section with reverse shaping but **OMIT** the **BUTTONHOLES**.

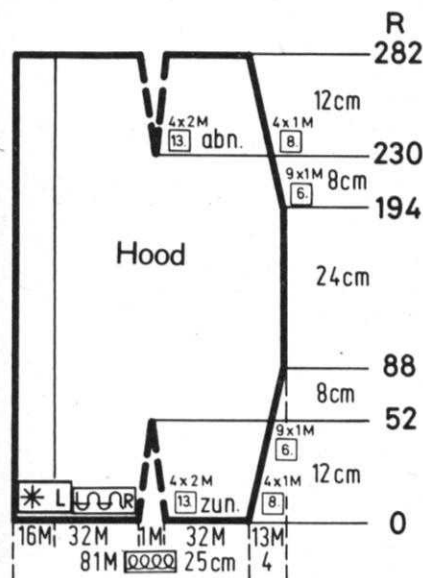

## HOOD:

Cast on 81 sts. Set 16 sts. on the **LEFT SIDE** into Pattern and **KEEP THEM IN PATTERN** with the rest of the sts. in Stockinette stitch.

Make **DART** increases and **SIDE** increases **AT THE SAME TIME**.

Increase 2 sts. for **DART** every 13th row 4x and **ON SIDE EDGE** increase 1 st. every 8th row 4x, every 6th row 9x. Knit to Row 194.

**AT SIDE EDGE** decrease 1 st. every 6th row 9x, every 8th row 4x **AND AT THE SAME TIME** after Row 230, decrease 2 sts. for **DART** every 13th row 4x. After Row 282, bind off all sts.

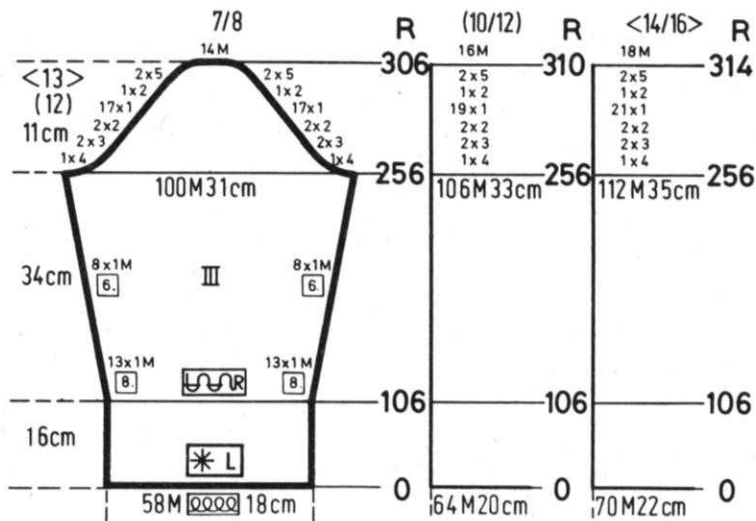
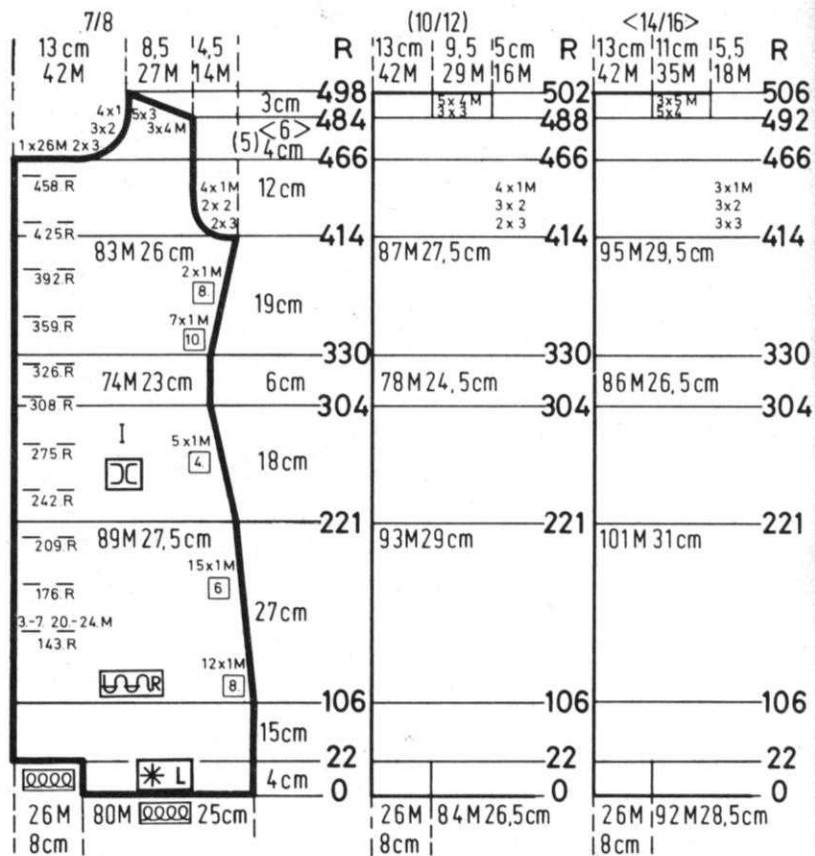

## DRESS SLEEVE:

Bring 58 (64) [70] needles into working position, then set into Pattern. Cast on. Knit in Pattern to Row 106 then change to Stockinette stitch.

On **EACH SIDE** increase 1 st. every 8th row 13x, every 6th row 8x.

Knit to Row 256

**SHAPE CAP:**

**ON EACH SIDE** bind off

4 sts. 1x, 3 sts. 2x, 2 sts. 2x, 1 st. 17x,

2 sts. 1x, 5 sts. 2x

(4 sts. 1x, 3 sts. 2x, 2 sts. 2x, 1 st. 19x,

2 sts. 1x, 5 sts. 2x)

[4 sts. 1x, 3 sts. 2x, 2 sts. 2x, 1 st. 21x,

2 sts. 1x, 5 sts. 2x]

After Row 306 (210) [314] bind off the remaining 14 (16) [18] sts.

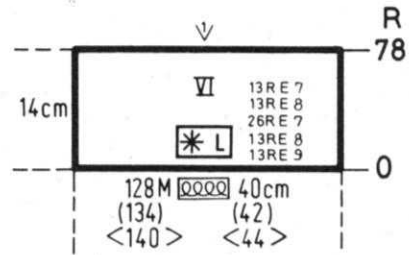

## DRESS COLLAR:

Bring 128 (134) [140] needles into working position then set into Pattern and cast on.

Knit in Pattern as follows: 13 Rows Tension 9, 13 rows Tension 8, 26 rows Tension 7, 13 rows Tension 8, 13 rows Tension 7. After Row 78, bind off.



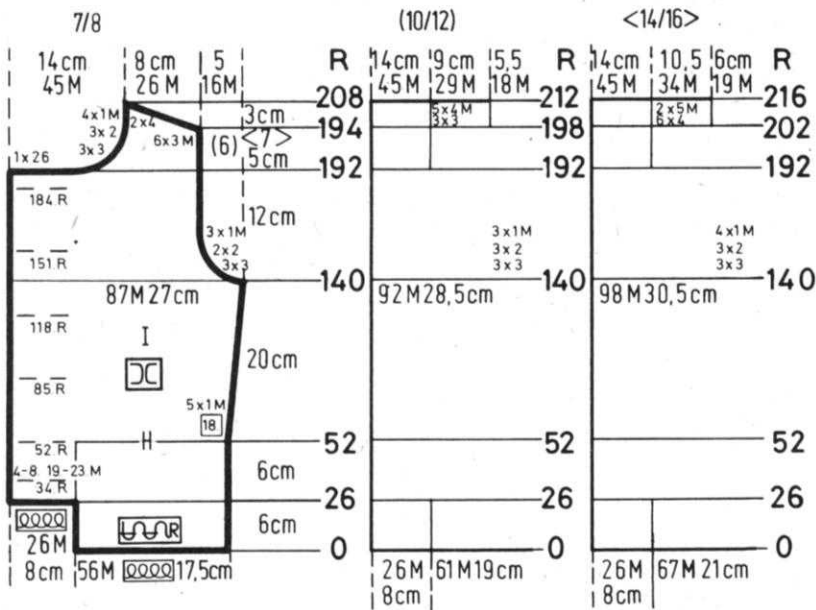

**JACKET FRONT: I**

Cast on 56 (61) [67] sts. Work Stockinette stitch. Knit to Row 26 then cast on 26 sts. on the left side (right for second section) Make **BUTTONHOLES** over needles 4 to 8 and 19 to 23 counting from the left edge after Row 34 and all the following rows marked on the Chart. After Row 52, hang the original cast on sts. back onto the machine and place the sts. behind the latches (hem). **ON SIDE EDGE** increase 1 st. every 18th row 5x. Knit to Row 140 **SHAPE ARMHOLE:** Bind off 3 sts. 3x, 2 sts. 2x, 1 st. 3x (3 sts. 3x, 2 sts. 3x, 1 st. 3x) [3 sts. 3x, 2 sts. 3x, 1 st. 4x] Knit to Row 191 **SHAPE NECK** Row 191 (ALL SIZES) Bind off 26 sts. 1x, 3 sts. 3x, 2 sts. 3x, 1 st. 4x. **SHAPE SHOULDER** Row 198 (198) [202] 3 sts. 6x, 4 sts. 2x (3 sts. 3x, 4 sts. 5x) [4 sts. 6x, 5 sts. 2x] Make the second section with reverse shaping but **OMIT** the **BUTTONHOLES**.

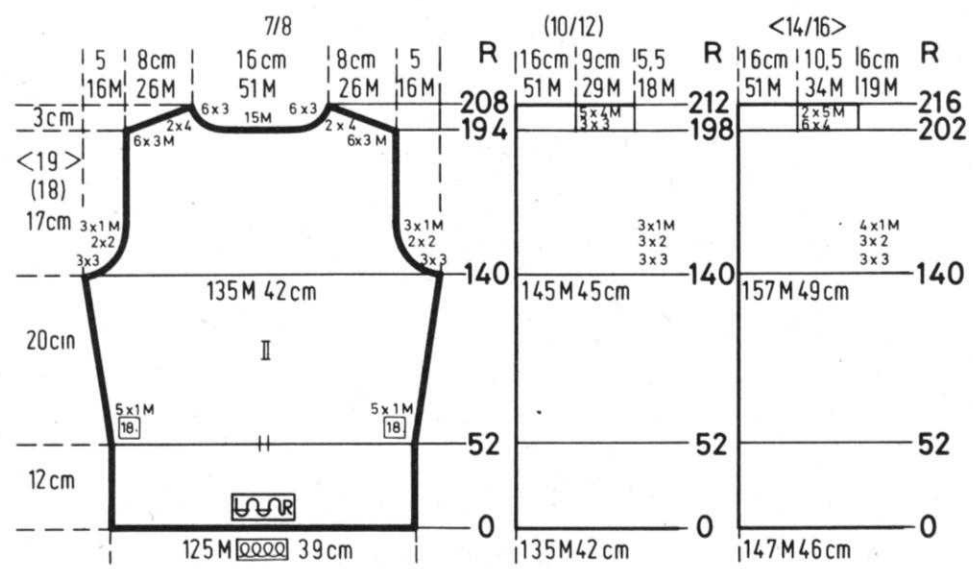

**JACKET BACK: II**

Cast on 125 (135) [147] sts. and work Stockinette stitch. Knit to Row 52, then hang the hem. **ON EACH SIDE**, increase 1 st. every 18th row 5x. Knit to Row 140. **SHAPE ARMHOLE:** **ON EACH SIDE** bind off 3 sts. 2x, 2 sts. 2x, 1 st. 3x (3 sts. 3x, 2 sts. 3x, 1 st. 3x) [3 sts. 3x, 2 sts. 3x, 1 st. 4x] Knit to Row 194 (198) [202] Bind off the center 15 sts. put the needles on the left into holding position and complete the right half first. \* Bind off **FOR SHOULDER** 3 sts. 6x, 4 sts. 2x (3 sts. 3x, 4 sts. 5x) [4 sts. 6x, 5 sts. 2x] **FOR NECK** 3 sts. 6x (Same as above) [Same as above]

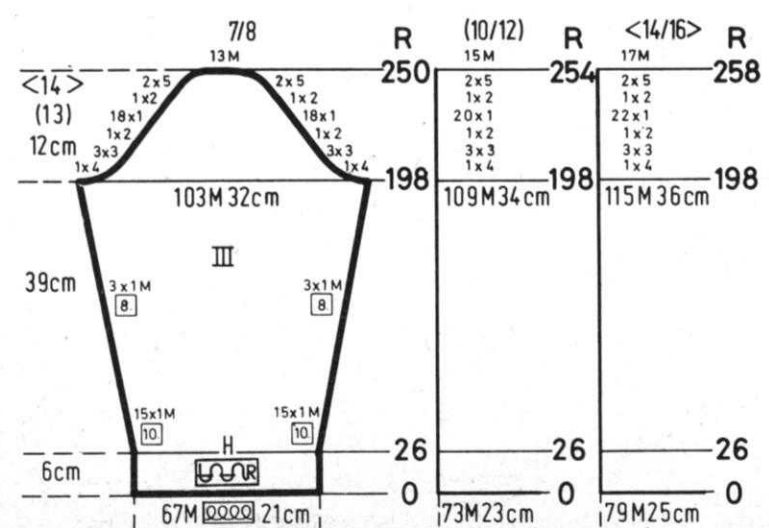

Bring the Cam Box to the left side, turn the Row Counter back to 194 (198) [202] and complete the left half. Follow the instructions from \*.

**JACKET SLEEVE: III**

Cast on 67 (73) [79] sts. and work Stockinette stitch. Knit to Row 26 then hang the hem. **ON EACH SIDE** increase 1 st. every 10th row 15x, every 8th row 3x. **SHAPE CAP** after Row 198 Bind off 4 sts. 1x, 3 sts. 3x, 2 sts. 1x, 1 st. 18x, 2 sts. 1x, 5 sts. 2x (4 sts. 1x, 3 sts. 3x, 2 sts. 1x, 1 st. 20x, 2 sts. 1x, 5 sts. 2x) [4 sts. 1x, 3 sts. 3x, 2 sts. 1x, 1 st. 22x, 2 sts. 1x, 5 sts. 2x] After Row 250 (254) [258] bind off the remaining 13 (15) [17] sts.

# DK 40

## WOMAN'S COAT AND DRESS

SIZE: 10/12 (14/16) [18/20]

YARN: Beatrice

50 gr. balls: 23 (24) [25]

**E** TENSION: 6 to 8

**P** GAUGE: 16 sts. 20 rows = 5 cm (2")

Stockinette stitch with an Eyelet Border Design over which you will work an embroidery Catch Stitch using a double strand of yarn. Worn on the Knit side.

FINISHING: See General Instructions. The Catch Stitch is worked as follows: Using a double strand of yarn, thread a tapestry needle and work from LEFT TO RIGHT. Keep the yarn down below the

needle at all times. Begin on the left but go through two holes from right to left on the lower edge, then from right to left through two holes on the top, through the next two holes on the bottom, through the next 2 holes on the top etc.

### COAT BACK: II

Bring 178 (190) [196] needles into working position, set into Pattern I. Cast on and knit in Pattern.

Knit to Row 32, hang the hem. Knit to Row 60.

ON EACH SIDE, decrease 1 st.

Every 12th row 14x, every 10th row 4x (Every 12th row 14x, every 10th row 4x) [Every 20th row 4x, every 18th row 7x]

Knit to Row 320

ON EACH SIDE decrease 1 st.

EVERY ROW 21x, every 2nd row 21x (EVERY ROW 25x, every 2nd row 23x) [EVERY ROW 37x, every 2nd row 21x]

After Row 384 (392) [400] bind off all sts.

### COAT FRONT: I

Bring 83 (89) [99] needles into working position, set into Pattern I and cast on. Knit in Pattern.

After Row 16, cast on 25 sts. ON THE LEFT (right for second section) SIDE (use a separate yarn to cast on). Leave these cast on sts. in stockinette stitch for the Front band. Knit to Row 32, then hang the original cast on sts. back onto the machine and place them behind the latches (hem).

Make BUTTONHOLES over needles 3 to 7 and 19 to 23 counting from the left edge after Rows on Chart for your size.

After Row 60, decrease 1 st. at side edge every 12th row 14x, every 10th row 4x.

Knit to Row 311 (307) [303] then work Short Rows for the Bust Dart.

ON OPPOSITE SIDE OF CAM BOX put into holding position

10 sts. 4x

(8 sts. 6x)

[6 sts. 8x]

Knit to Row 328 (332) [336]

SHAPE RAGLAN:

Decrease 1 st. EVERY ROW

21x (25x) [37x] then decrease 1 st. every

2nd row 15x (17x) [15x] AND THE SAME

TIME SHAPE NECK after Row 363 (375)

[387] Bind off 30 sts. 1x, 4 sts. 2x, 3 sts. 3x, 2 sts. 2x.

Make the second Front section with reverse shaping but OMIT the BUTTONHOLES.

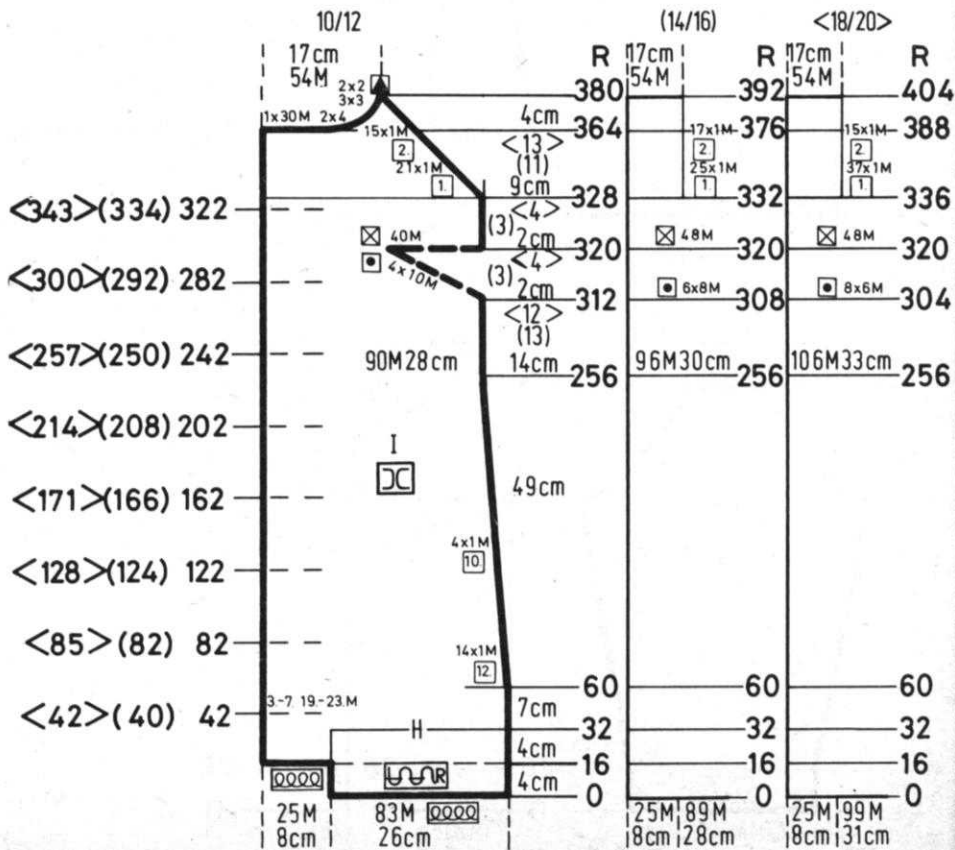
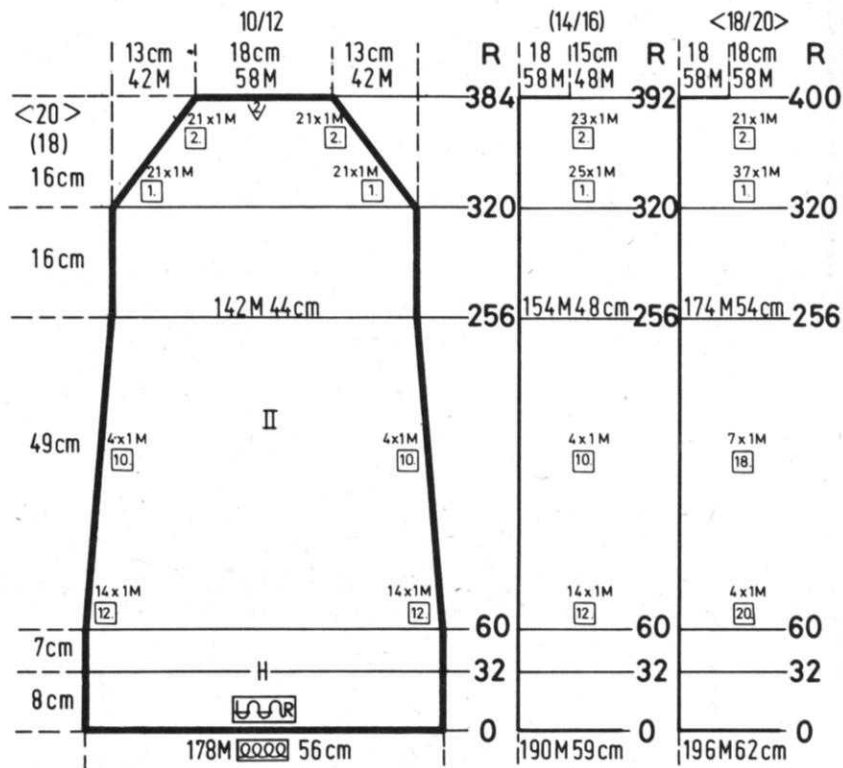



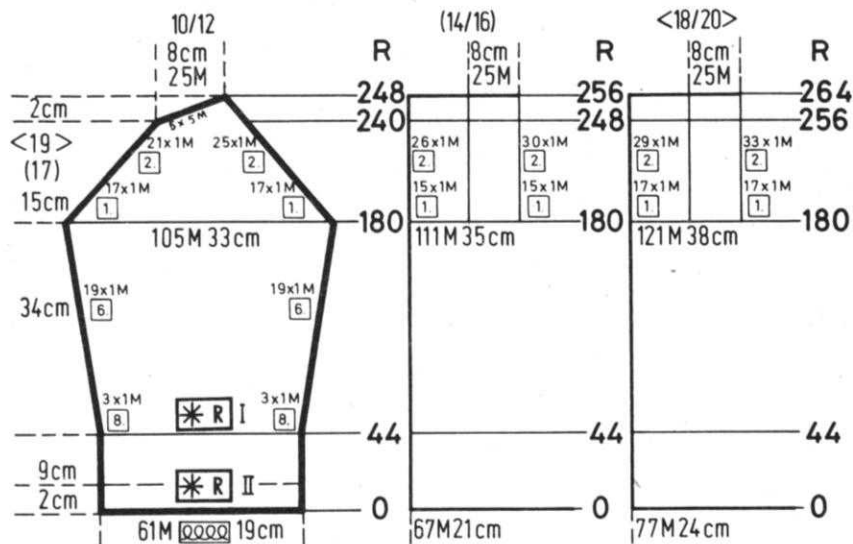

### COAT SLEEVE: III

Cast on 61 (67) [77] sts. and knit in Pattern II to Row 44.  
Change to Pattern I.  
ON EACH SIDE increase 1 st. every 8th row 3x, every 6th row 19x.  
Knit to Row 180.

ON EACH SIDE decrease 1 st. EVERY ROW 17x (15x) [17x] then decrease 1 st. every 2nd row ON LEFT (right for 2nd sleeve) 21x (26x) [29x]  
ON RIGHT (left for second sleeve) 25x (30x) [33x]  
After Row 240 (248) [256] Work Short Rows.

Put into holding position 5 sts. 5x then bring the needles into working position and bind off.

Make second Sleeve with reverse shaping, casting on from RIGHT to LEFT. Cam Box will be on the LEFT SIDE at Row 0.

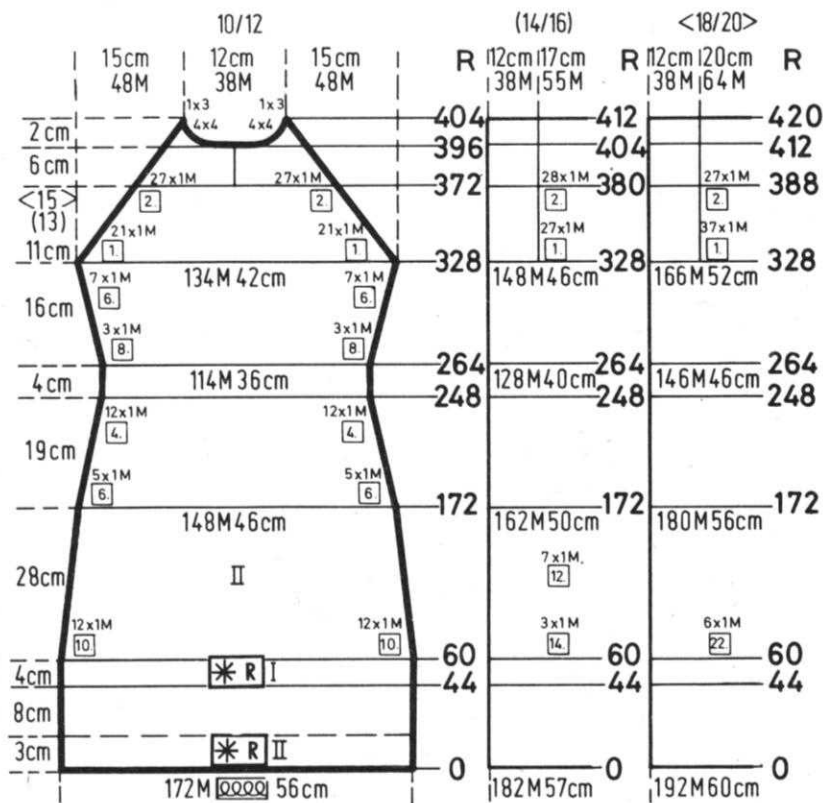

### DRESS BACK: II

Cast on 172 (182) [192] sts. and knit the 44 rows of PATTERN II. Change to PATTERN I and continue to Row 60.

ON EACH SIDE, decrease 1 st. Every 10th row 12x (Every 14th row 3x, every 12th row 7x) [Every 22nd row 6x]  
Knit to Row 172. ON EACH SIDE decrease 1 st. Every 6th row 5x, every 4th row 12x.

Knit to Row 264. ON EACH SIDE increase 1 st. Every 8th row 3x, every 6th row 7x. Knit to Row 328. ON EACH SIDE decrease 1 st. EVERY ROW 21x (27x) [37x] then decrease 1 st. every 2nd row 27x (28x) [27x] AND AT THE SAME TIME Divide in Center after Row 372 (380) [388] Put the needles on the left into holding position and complete the right half first.

\* Knit to Row 396 (404) [412]  
FOR NECK bind off 4 sts. 4x, 3 sts. 3x. Move the Cam Box to the left side, turn the Row Counter back to 372 (380) [388] and complete the left half.  
Follow the instructions from \*.

### DRESS FRONT: I

Work the front section the same as the back section to Row 320 (316) [312] then knit Short Rows for the Bust Darts. ON OPPOSITE SIDE OF CAM BOX, put into holding position 10 sts. 4x ON EACH SIDE (8 sts. 6x ON EACH SIDE) [6 sts. 8x ON EACH SIDE]  
Bring all the needles back into working position before knitting the next 2 rows. Knit to Row 336 (340) [344]  
ON EACH SIDE, decrease 1 st. EVERY ROW

21x (27x) [37x] and every 2nd row 19x (20x) [19x] AND AT THE SAME TIME after Row 380 (392) [404]. Bind off the center 12 sts., put the needles on the left into holding position and complete the right half first.

\* ON NECK SIDE bind off 4 sts. 2x, 3 sts. 2x, 2 sts. 1x, 1 st. 2x  
Move the Cam Box to the left side, turn the Row Counter back to 380 (392) [404] and complete the left half.  
Follow the instructions from \*.

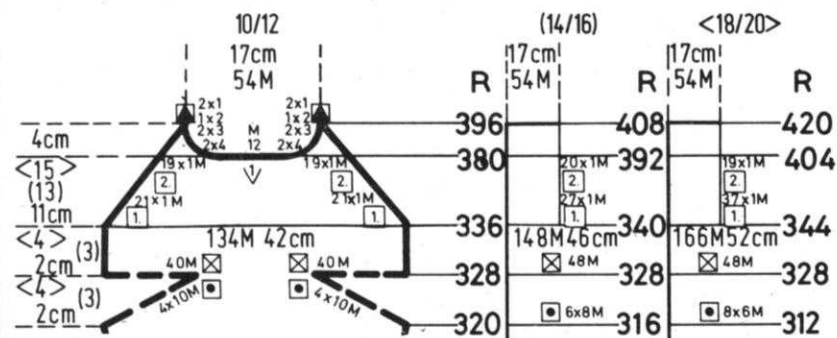

# DK 40

## DRESS SLEEVE: III

Cast on 89 (95) [105] sts. and knit the 44 rows of PATTERN II AND AT THE SAME TIME after Row 16, decrease 1 st. ON EACH SIDE every 8th row 6x. Change to PATTERN I and continue.

Knit to Row 64.  
ON EACH SIDE decrease 1 st. EVERY ROW 19x (17x) [19x] then EVERY 2nd Row ON THE LEFT SIDE (right for second section)

1 st. 20x  
(1 st. 25x)  
[1 st. 28x]

ON THE RIGHT SIDE (left for second section)

1 st. 24x  
(1 st. 29x)  
[1 st. 32x]

AFTER ROW 124 (132) [140] Work Short Rows: Put into holding position 3 sts. 1x, 4 sts. 3x. After Row 132 (140) [148] bring all the needles into working position and bind off.

Make the second sleeve with reverse shaping, casting on from Right to Left. Cam Box will be on the LEFT SIDE at Row 0.

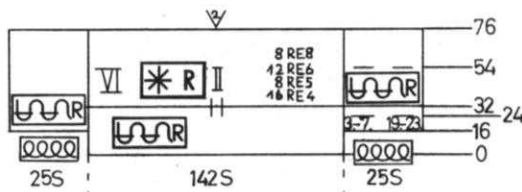
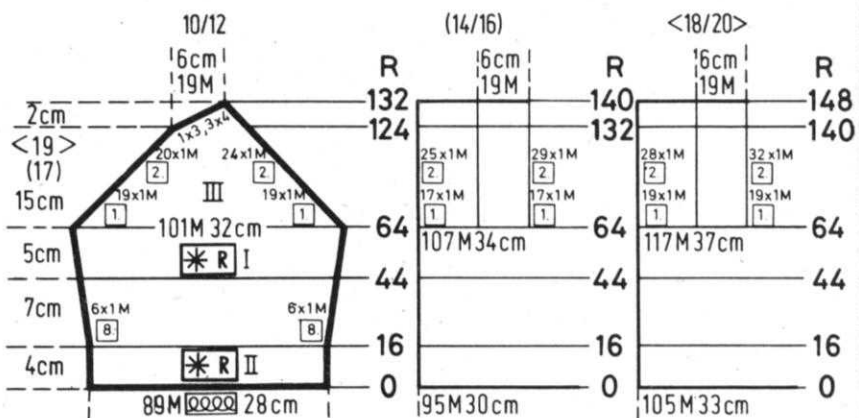

## YOKE AND NECKBAND: VI

Cast on 142 sts. Work Stockinette stitch. With TENSION 3 knit to Row 16.

ON EACH SIDE, cast on 25 sts. (use separate yarn for the left side).

CHANGE TO TENSION 4 and knit to Row 24.

MAKE BUTTONHOLES over needles 3 to 7 and 19 to 23 on the RIGHT SIDE. Knit to Row 32 then hang the original 142 cast on sts. onto the machine and place the sts. behind the latches.

Knit to Row 48. CHANGE TO TENSION 5 and knit to Row 56.

Make EYELETS across the center 142 sts. as shown for PATTERN II, then CHANGE TO TENSION 6 and knit to Row 54.

MAKE BUTTONHOLES as you did before. Knit to Row 68.

Make EYELETS across as you did before then CHANGE TO TENSION 8 and knit to Row 76. Bind off LOOSELY.

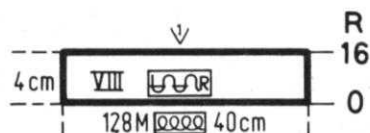

## DRESS NECKBAND: VIII

Cast on 128 sts. Knit 16 rows Stockinette stitch then bind off.

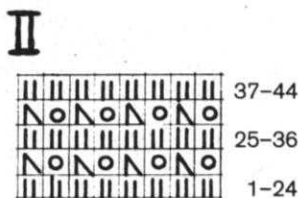



Another first from Knitking!!!

## THE ~~WHIZ KING~~ PATTERN READER with complete Charting Service

- With WHIZ KING you know exactly what to do without reference to written instructions.
- With WHIZ KING you no longer have to count rows ... Your Pattern Chart turns automatically as you knit.
- With WHIZ KING you can knit even the most intricate patterns easily and speedily.
- With a WHIZ KING Pattern Reader, even the complete newcomer to machine knitting can immediately knit garments.
- With WHIZ KING, Charts are available from KNITKING MAGAZINE Patterns in the size of your choice.

**PRICE: 59.50** Complete with instructions, practice Charts and illustrations of 50 complete Patterns for the entire family. (California residents add Sales Tax)  
Shipping costs \$2.50.

ORDER DIRECT FROM KNITKING 1128 CRENSHAW BLVD. • LOS ANGELES, CALIFORNIA 90019

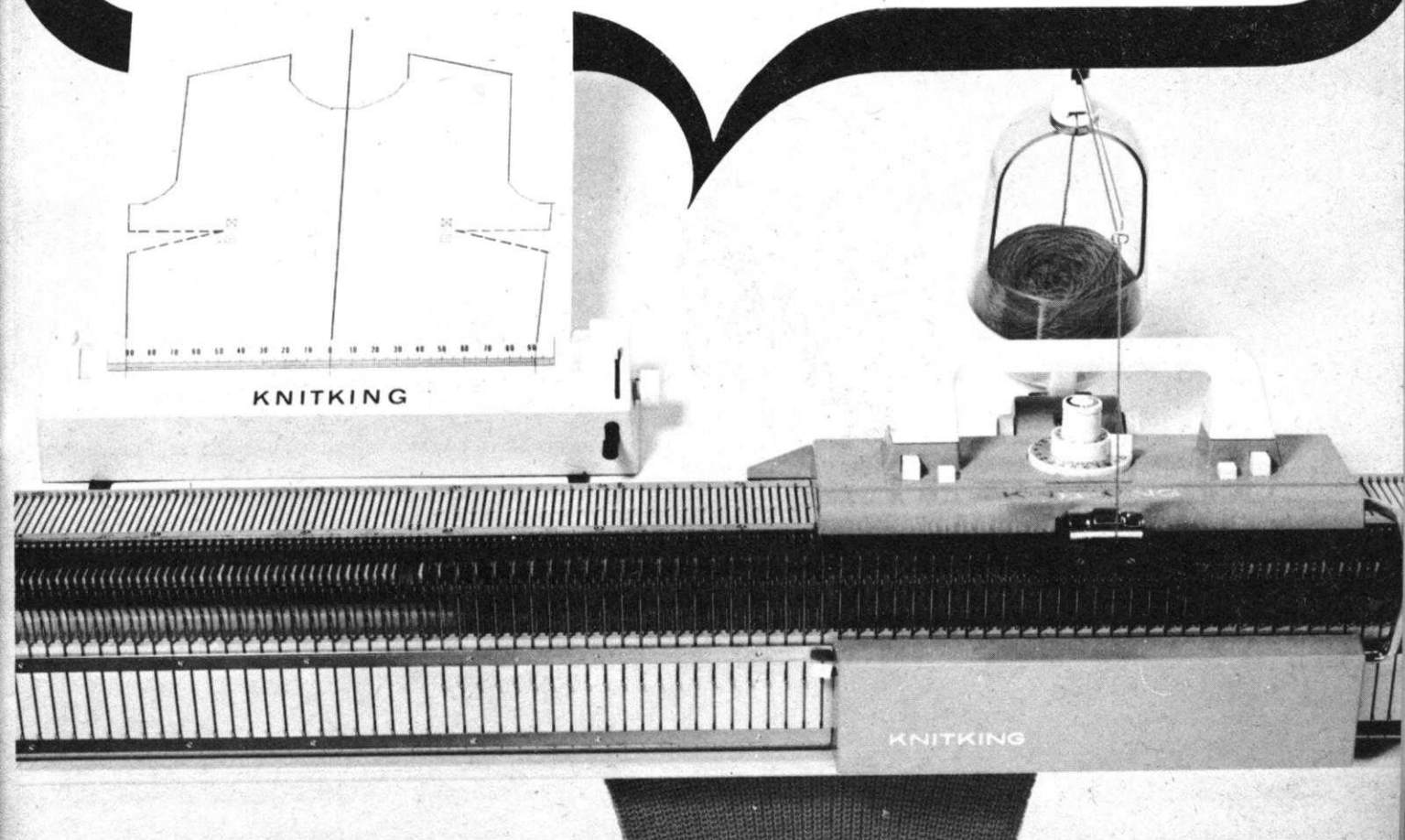
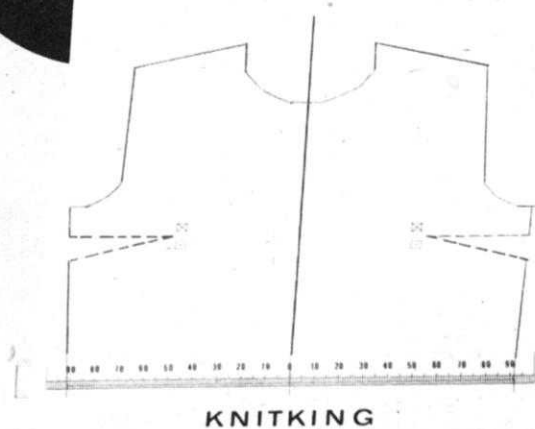

**new**  
our Pattern Reader  
makes knitting  
easier than sewing

**KN**  
brings  
kni

It is her  
easy



**Knitting**  
**AM 3**  
with one-button  
super automatic



# KNITTING

## Knitting up to date.

At last - the Pattern Reader that makes knitting easier than sewing.

Change the yarn!  
Insert the pattern as you would a sheet in a typewriter!  
No other adjustments to make!  
No figures to read!

The KNITKING Pattern Reader directs your every move. You will produce knitting without errors because the KNITKING Pattern Reader "thinks" for you. Knitting could not be easier. Patterns in the latest styles and the size of your choice are available regularly from your KNITKING fashion department.

**There is only one  
knitting machine with  
one-button super automatic cam control:**



KNITKING is it—! You do not need punch cards or key boards. Pattern knitting has never been this easy. With one-button control, pattern stitch selection is unlimited.

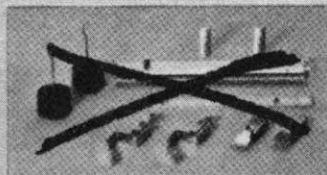

No weights.

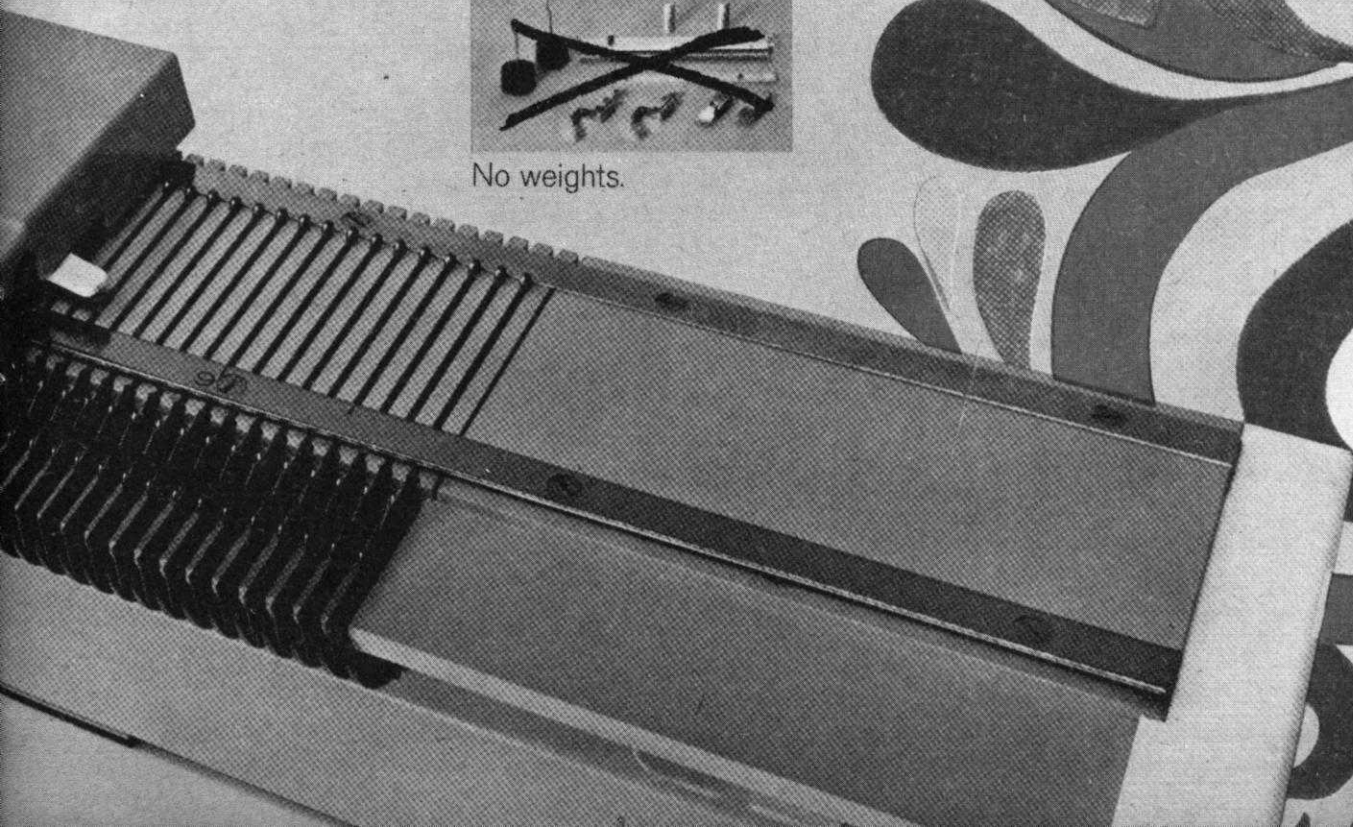

**KNITKING  
for love  
of  
doing  
it yourself**



# knitking

## ACCESSORY PRICE LIST

	PRICE	SHIPPING		PRICE	SHIPPING
WHIZ KING PATTERN READER	\$59.50	\$ 2.50	Reversing Bar (197 Needle KNIT-		
Increase-Decrease Compensator ..	27.50	2.00	KING Machine only .....	\$ 27.50	\$ 1.75
3-Color Yarn Feeder .....	22.50	1.50	Converta Tape (for Charting Pat-		
Pattern Stitch Cards for AM 3			terns to size) .....	9.50	.60
KNITKING Machine only -			Fluorescent Magnifying Lamp with		
#17 to #48 .....	9.50	1.25	5 inch lens and adjustable 45		
Weaving Accessory for AM 3			inch extension arm.(specify		
KNITKING only .....	8.95	.80	table clamp or wall Fitting), ...	57.95	3.00
Adjustable Needle Selector			JAC 40 (KNITKING Machine only)	29.50	1.50
(33 Needle) .....	4.25	.60	JAC 40 Punch Cards, Please give		
Cam Wheels for AM 3 KNITKING			alternate numbers ... Each	.95	.15
Machine only .....	1.00	.10	Strap for JAC 40 .....	2.00	.30
Knitting Table (suitable for all			KNITKING Instruction Book		
machines .....	44.95	F.O.B.	(specify machine) .....	4.00	.50
KNITKING Metal Table .....	39.50	F.O.B.	1 Year Subscription to KNITKING		
Treble Transfer Tool (pair) ....	2.00	.50	MAGAZINE (6 issues) .....	10.00 (no tax)	
Multiple Transfer Tool (33 needle)	3.95	.60	Canada	12.00	
Double Transfer Tool (pair) ....	1.80	.50	Back Issues of KNITKING MAGAZINE		
Transfer Tools (1 each - 4 needle			SINGLE COPY (thru Vol. 10)Ea.	1.50	Postpaid
and 6 needle) .....	2.95	.50	After Vol. 11 No. 1 ... Each	3.00	Postpaid
Combined Latch Needle & Transfer			Complete 6th or 7th or 8th or 9th		
Tool .....	1.50	.25	or 10th Bound Volume of		
Combined Work Hook & Transfer			KNITKING MAGAZINE (6		
Tool .....	1.50	.25	issues bound in Plastic Cover)Ea.	7.95	1.15
Knitting Machine Needles for			KNITKING Yarn Catalogue ....	1.00	Postpaid
KNITKING Machines only ..	.35	.10	KNITKING Carrying Bags (2-piece)		
Ribbing Attachment Needles for			AM 3 and Cam Box .....	29.50	1.75
KNITKING Ribbers only ....	.45	.10	KNITKING Carrying Bag (for		
Ribber Transfer Needles .....	.35	.10	Ribber only) .....	15.50	1.00
Strippers for KNITKING Ribber(pr)	.95	.25			
KNITKING Sinker & Spring (specify					
Machine No.) .....	.20	.15			
Shipping for 20 .....		.35			
Yarn Winder with 'Waxamajig' and					
Skein Holder .....	23.95	1.75			
Wax Spools, .....	.30	.20			
OR 4 for .....	1.00	.40			

Sorry, No C.O.D.'s or Billings, Please send money with your order. California Residents please add Sales Tax.

Price Lists prior to this date are obsolete.

KNITKING, INC.

1128 Crenshaw Blvd., Los Angeles, California 90019





# DK 41

## WOMAN'S COAT

SIZE: 10/12 (14/16) [18/20]

YARN: Beatrice

50 gr. baals: 18 (19) [20]

**E** TENSION: 6 to 8

**P** GAUGE: 15 sts. 20 rows = 5 cm (2")

Mock Rib with needles out of work that ARE COUNTED in the Stitch Gauge and instructions. COLLAR: Crochet Loop Stitch (See General Instructions this issue). The knit side is the right side.

FINISHING: See General Instructions. Attach long knotted fringe to belt ends.

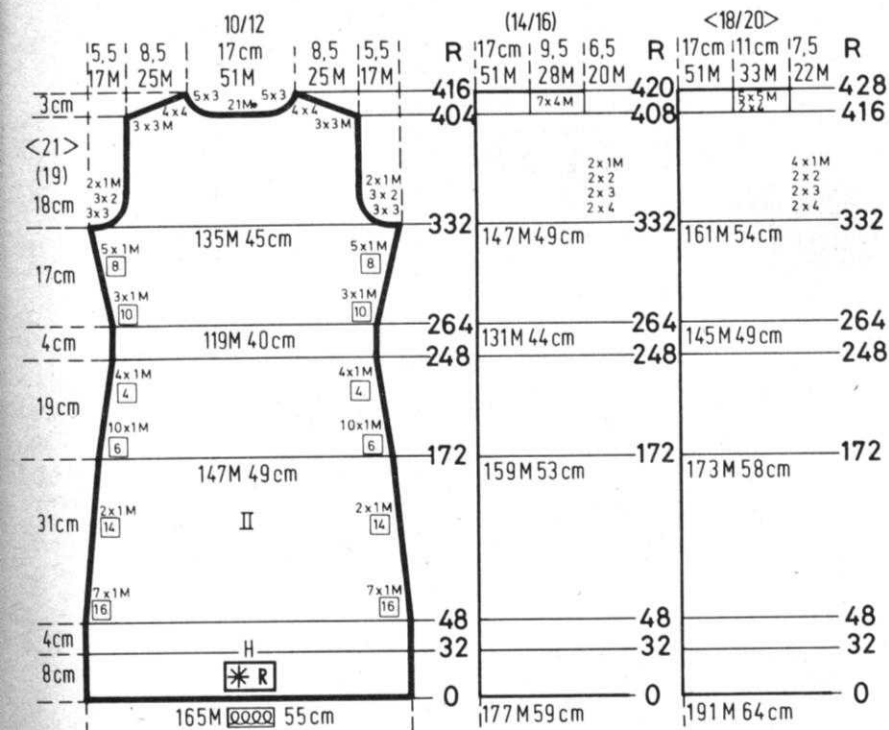
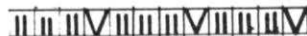

### BACK: II

Bring 165 (177) [191] needles into working position, set into MOCK RIB Pattern as on the Line Drawing, cast on and knit to Row 32. Hang the hem then knit to Row 48. ON EACH SIDE, decrease 1 st. every 16th row 7x, every 14th row 2x. ON EACH SIDE, after Row 172, decrease 1 st. every 6th row 10x, every 4th row 4x. Knit to Row 264. ON EACH SIDE, increase 1 st. every 10th row 3x, every 8th row 5x. Knit to Row 332.

#### SHAPE ARMHOLES:

ON EACH SIDE bind off 3 sts. 3x, 2 sts. 3x, 1 st. 2x (4 sts. 2x, 3 sts. 2x, 2 sts. 2x, 1 st. 2x) [4 sts. 2x, 3 sts. 2x, 2 sts. 2x, 1 st. 4x] Knit to Row 404 (408) [416]. Bind off the center 21 sts. put the needles on the left side into holding position and complete the right side first.

\* Bind off

#### FOR SHOULDER

3 sts. 3x, 4 sts. 4x (4 sts. 7x) [4 sts. 2x, 5 sts. 5x]

#### FOR NECK

3 sts. 5x (Same as above) [Same as above]

Bring the needles on the left side into working position, knit 1 row in Pattern to the left, turn the Row Counter back to 404 (408) [416] and complete the left half. Follow the instructions from \*.

### SLEEVE: III

Bring 64 (70) [78] needles into working position, set into MOCK RIB Pattern, cast on and knit to Row 24. Hang the hem. ON EACH SIDE, increase 1 st. every 8th row 11x, every 6th row 11x. Knit to Row 176.

#### SHAPE ARMHOLE:

ON EACH SIDE, bind off 5 sts. 1x, 4 sts. 2x, 3 sts. 1x, 2 sts. 1x, 1 st. 16x, 2 sts. 1x, 5 sts. 2x (5 sts. 1x, 4 sts. 2x, 3 sts. 1x, 2 sts. 1x, 1 st. 18x, 2 sts. 1x, 5 sts. 2x) [5 sts. 1x, 4 sts. 2x, 3 sts. 1x, 2 sts. 1x, 1 st. 20x, 2 sts. 1x, 5 sts. 2x] After Row 224, (228) [232] bind off the remaining 16 (18) [20] sts.

### BELT: IX

Cast on 29 sts. Work 600 Rows Stockinette st. then bind off.

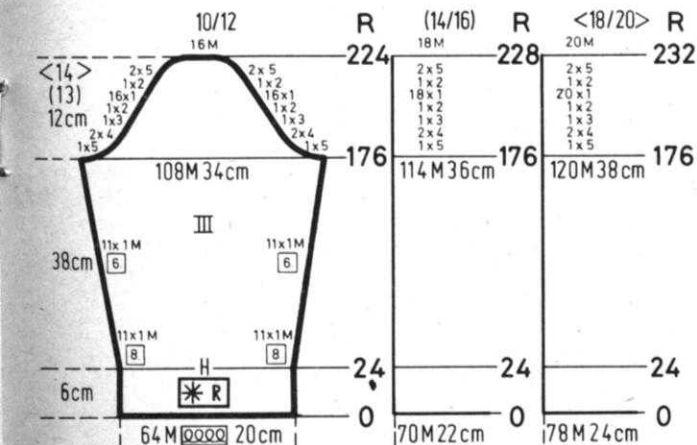

# DK 41

## COAT FRONT: I

Bring 75 (81) [88] needles into working position, set into MOCK RIB Pattern, cast on. Knit to Row 16, then bring 30 needles into working position on the LEFT side (right for second section), set into Pattern and cast on over these needles with a separate yarn. Knit to Row 32, hang the hem and knit to Row 36. Make BUTTONHOLES over needles 3 to 8 and 23 to 28 counting from the left edge. Continue to make BUTTONHOLES after Rows shown on Chart over the same needles as before. ON SIDE EDGE after Row 48, decrease 1 st. every 16th row 7x, every 14th row 2x. After Row 172, ON SIDE EDGE, decrease 1 st. every 16th row 10x, every 4th row 4x. Knit to Row 264, then take 15 sts. of the front band off onto a stitch holder (remember empty needles DO COUNT).

### SHAPE FRONT AND SIDE EDGE AT THE SAME TIME.

ON FRONT EDGE, decrease 1 st. every 4th row 22x, every 6th row 11x. ON SIDE EDGE, increase 1 st. every 10th row 3x, every 8th row 5x.

AFTER ROW 319 (315) [311] work Short Rows for the BUST DART.

ON OPPOSITE SIDE OF CAM BOX, put into holding position

10 needles 4x  
(8 needles 6x)  
[6 needles 8x]

Bring all the needles back into working position before knitting the next row.

Knit to Row 340 (344) [348]

SHAPE ARMHOLE: Bind off

3 sts. 3x, 2 sts. 3x, 1 st. 2x  
(4 sts. 2x, 3 sts. 2x, 2 sts. 2x, 1 st. 2x)  
[4 sts. 2x, 3 sts. 2x, 2 sts. 2x, 1 st. 4x]

Knit to Row 412 (420) [432]

SHAPE SHOULDER: Bind off

3 sts. 3x, 4 sts. 4x  
(4 sts. 7x)  
[4 sts. 2x, 5 sts. 5x]

Make the second front section with reverse shaping but OMIT the BUTTONHOLES.

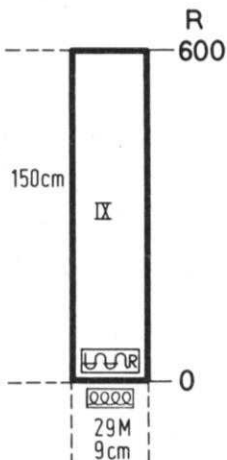

## BELT: IX

Cast on 29 sts. Work 600 Rows Stockinette st. then bind off.

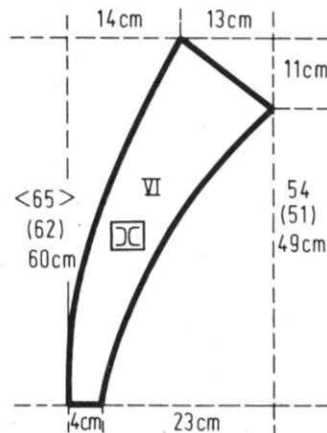
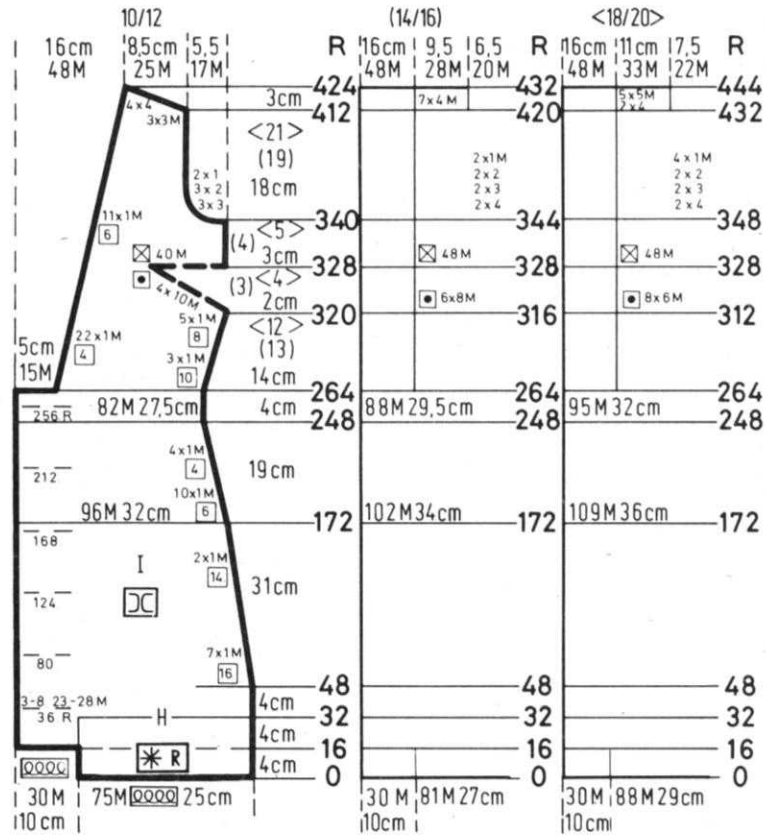

COLLAR: Crochet Loop Stitch.  
See General Instructions this issue.



# DK 42

## WOMAN'S DRESS

SIZE: 14/16 (18/20) [22/24]

YARN: Allegro - 4 colors

50 gr. balls:	C1	8	(9)	[10]
	C2	2	(2)	[2]
	C3	2	(2)	[2]
	C4	2	(2)	[2]

**E** TENSION: Stock: 7 to 9 

Pattern: 10 

**P** GAUGE: Stock: 

15 sts. 20 rows = 5 cm (2")

Pattern: 

10 sts. 17 rows = 5 cm (2")

Bodice and sleeves of dress are Stockinette stitch, skirt a Holding position Design with out of work needles that ARE COUNTED in the Stitch Gauge and Instructions. Follow the Line Drawing and use the Adjustable Needle Selector. Worn on the Knit side.

**FINISHING:** See General Instructions. Gather skirt then sew to bodice. Work 1 row Picot around Sleeve and neck edges. Attach Fringe to lower edge of dress. Sew on 5 buttons (see picture).

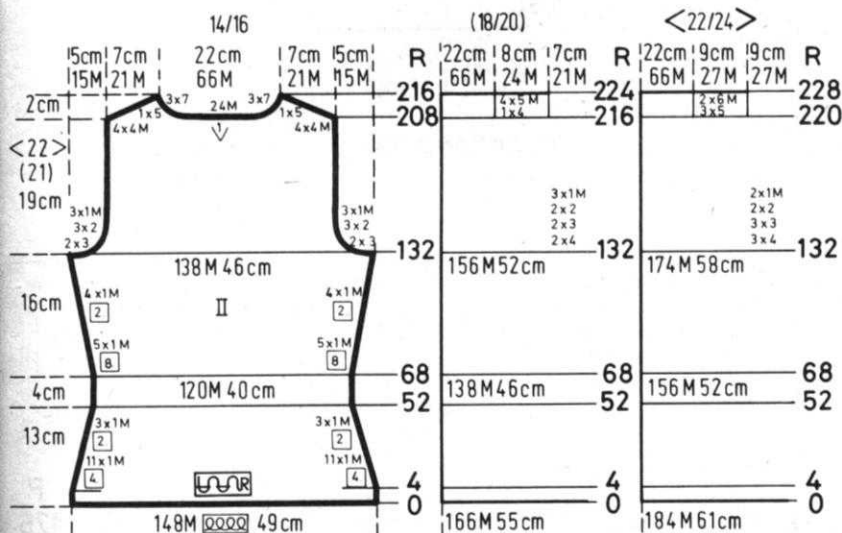

### BODICE BACK: II

Cast on 148 (166) [184] sts. and work Stockinette stitch. OE EACH SIDE, decrease 1 st. every 4th row 11x, every 2nd row 3x. Knit to Row 68. ON EACH SIDE, increase 1 st. every 8th row 5x, every 2nd row 4x. Knit to Row 132. SHAPE ARMHOLE: OE EACH SIDE bind off 3 sts. 2x, 2 sts. 3x, 1 st. 3x (4 sts. 2x, 3 sts. 2x, 2 sts. 2x, 1 st. 3x) [4 sts. 3x, 3 sts. 3x, 2 sts. 2x, 1 st. 2x] Knit to Row 208 (216) [220]. Bind off the center 24 sts., put the needles on the left side into holding position and complete the right half first.

\* bind off  
FOR SHOULDER  
4 sts. 4x, 5 sts. 1x  
(4 sts. 1x, 5 sts. 4x)  
[5 sts. 3x, 6 sts. 2x]

FOR NECK  
7 sts. 3x  
(Same as above)  
[Same as above]

Bring the Cam Box to the left side, turn the Row Counter back to 208 (216) [220] and complete the left half. Follow the instructions from \*.

### BODICE FRONT:

Work the front the same as the back to Row 124 (120) [116] then work Short Rows for the Bust Dart. ON OPPOSITE SIDE OF CAM BOX, put into holding position 6 sts. 6x (5 sts. 8x) [4 sts. 10x] Bring all the needles back into working position before knitting the next 2 rows. Knit to Row 144 (148) [152]. SHAPE ARMHOLE: ON EACH SIDE, bind off 3 sts. 2x, 2 sts. 3x, 1 st. 3x (4 sts. 2x, 3 sts. 2x, 2 sts. 2x, 1 st. 3x) [4 sts. 3x, 3 sts. 3x, 2 sts. 2x, 1 st. 2x] AT THE SAME TIME after Row 156 (160) [164] bind off the center 20 sts. put the needles on the left into holding position and complete the right half first.

\* ON NECK SIDE, bind off  
4 sts. 2x, 3 sts. 2x, 2 sts. 3x, 1 st. 3x and SHAPE SHOULDER after Row 220 (232) [240]  
Bind off

4 sts. 4x, 5 sts. 1x  
(4 sts. 1x, 5 sts. 4x)  
[5 sts. 3x, 6 sts. 2x]  
Bring the Cam Box to the left side, turn the Row Counter back to 156 (160) [164] and complete the left half. Follow the instructions from \*.

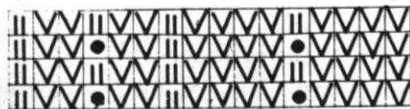
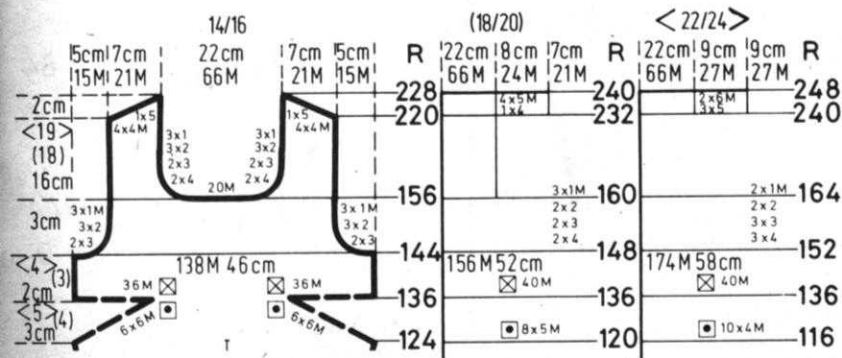

11-12  
7-10  
5-6  
1-4

# DK 42

## SLEEVE: III

Cast on 60 (66) [76] sts. and work Stockinette stitch.  
 Knit to Row 24, hang the hem.  
**ON EACH SIDE**, increase 1 st. every 8th row 8x, every 6th row 5x. Knit to Row 176.  
**SHAPE CAP: ON EACH SIDE**, bind off 4 sts. 2x, 3 sts. 2x, 2 sts. 1x, 1 st. 18x, 2 sts. 1x, 5 sts. 2x (5 sts. 1x, 4 sts. 1x, 3 sts. 2x, 2 sts. 1x, 1 st. 20x, 2 sts. 1x, 5 sts. 2x) [6 sts. 1x, 4 sts. 2x, 3 sts. 1x, 2 sts. 1x, 1 st. 22x, 2 sts. 1x, 5 sts. 2x]  
 After Row 228 (232) [236] bind off the remaining 14 (14) [16] sts.

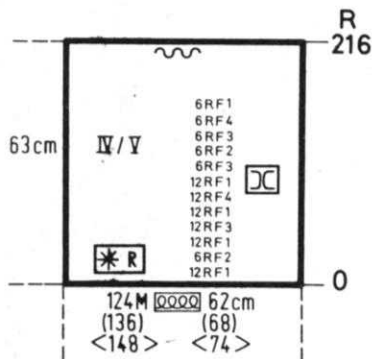
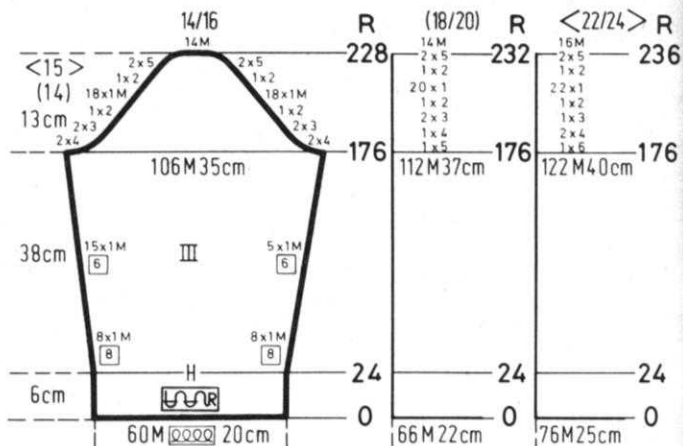

## SKIRT: IV/V

Make 2 pieces  
 Bring 124 (136) [148] needles into working position, set into Pattern. Cast on and knit in Pattern, changing the colors as shown on the Chart.  
 Knit to Row 216, then bind off.

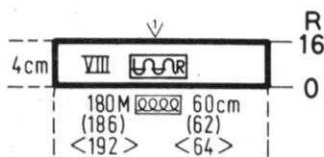

## NECKBAND: VIII

Cast on 180 (186) [192] sts. and work 16 rows Stockinette stitch then bind off.

# DK 43

## WOMAN'S DRESS

SIZE: 12/14 (16/18) [20/22]

YARN: Allegro - 4 colors

50 gr. balls: C1	7	(8)	[9]
C2	1	(1)	[1]
C3	1	(1)	[1]
C4	2	(2)	[2]

**P** TENSION: Stock: 7 to 9

Pattern: 10

**E** GAUGE:

Stock:  
 15 sts. 20 rows = 5 cm (2")  
 Pattern:  
 10 sts. 18 rows = 5 cm (2")

**FINISHING:** See General Instructions. Gather Skirt and sew to bodice. Attach fringe to lower edge and Sleeve edge. Work 1 row single crochet then 1 row Picot around neckline.

Stockinette stitch and a Holding Position with out of work needles that ARE COUNTED in the Stitch Gauge and the Instructions. Follow the Line Drawing. The knit side is the right side. Use the Adjustable Needle Selector for Pattern.

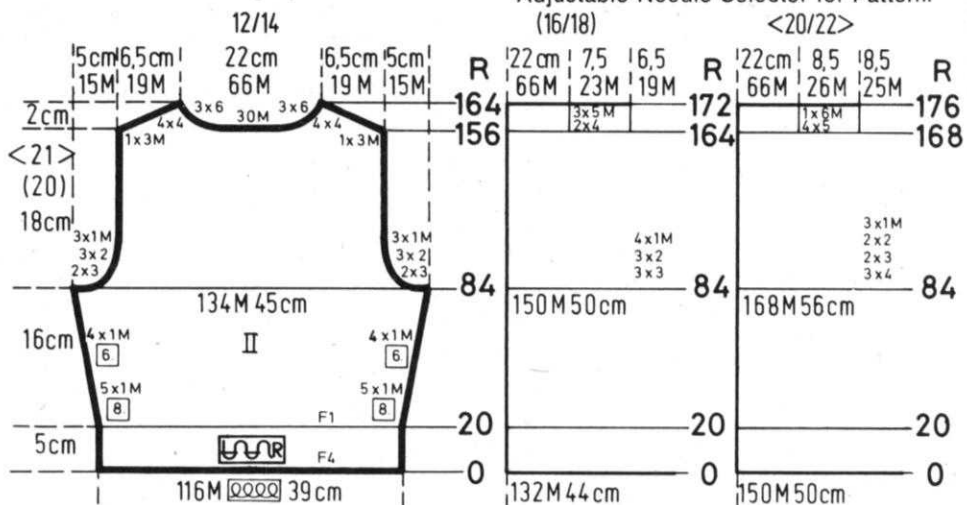

## BODICE BACK: II

Cast on 116 (132) [150] sts. with color 4 and work Stockinette stitch. Knit to Row 20 then change to color 1  
**ON EACH SIDE** increase 1 st. every 8th row 5x, every 6th row 4x. Knit to Row 84  
**SHAPE ARMHOLE: ON EACH SIDE** bind off 3 sts. 2x, 2 sts. 3x, 1 st. 3x (3 sts. 3x, 2 sts. 3x, 1 st. 4x) [4 sts. 3x, 2 sts. 2x, 2 sts. 2x, 1 st. 3x]  
 Knit to Row 156 (164) [168] Bind off the center 30 sts., put the needles on the left side into holding position and complete the right half first.

\* Bind off  
**FOR SHOULDER**  
 3 sts. 1x, 4 sts. 4x  
 (4 sts. 2x, 5 sts. 3x)  
 [5 sts. 4x, 6 sts. 1x]

**FOR NECK**  
 6 sts. 3x  
 (Same as above)  
 [Same as above]

Bring the Cam Box to the left side, turn the Row Counter back to 156 (164) [168] and complete the left half. Follow the instructions from \*.



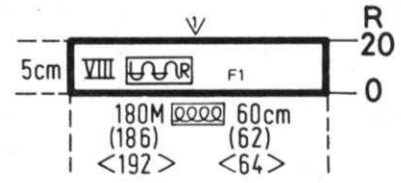
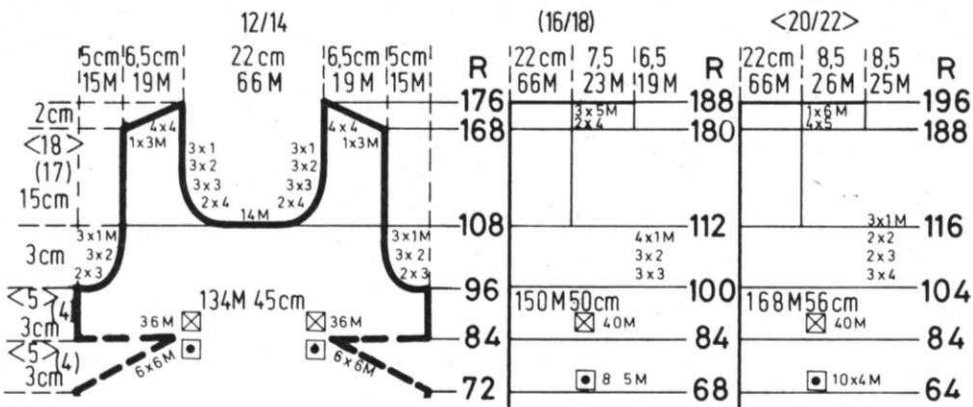

**NECKBAND: VIII**  
Cast on 180 (186) [192] sts. with color 1 and work 20 rows Stockinette stitch then bind off.

**BODICE FRONT: I**

Work the front section the same as the back to Row 72 (68) [64] then work Short Rows for the Bust Darts.  
ON OPPOSITE SIDE OF CAM BOX, put into holding position 6 sts. 6x ON EACH SIDE (5 sts. 8x ON EACH SIDE) [4 sts. 10x ON EACH SIDE]  
Bring all the needles back into working position before knitting the next 2 rows.  
Knit to Row 96 (100) [104]  
SHAPE ARMHOLE: Bind off 3 sts. 2x, 2 sts. 3x, 1 st. 3x (3 sts. 3x, 2 sts. 3x, 1 st. 4x) [4 sts. 3x, 3 sts. 2x, 2 sts. 2x, 1 st. 3x]

AT THE SAME TIME after Row 108 (112) [116] bind off the center 14 sts., put the needles on the left side into holding position and complete the right half first.

\* ON NECK SIDE, bind off 4 sts. 2x, 3 sts. 3x, 2 sts. 3x, 1 st. 3x  
SHAPE SHOULDER after Row 168 (180) [188]  
Bind off  
3 sts. 1x, 4 sts. 4x (4 sts. 2x, 5 sts. 3x) [5 sts. 4x, 6 sts. 1x]  
Bring the Cam Box to the left side, turn the Row Counter back to 108 (112) [116] and complete the left half.  
Follow the instructions from \*.

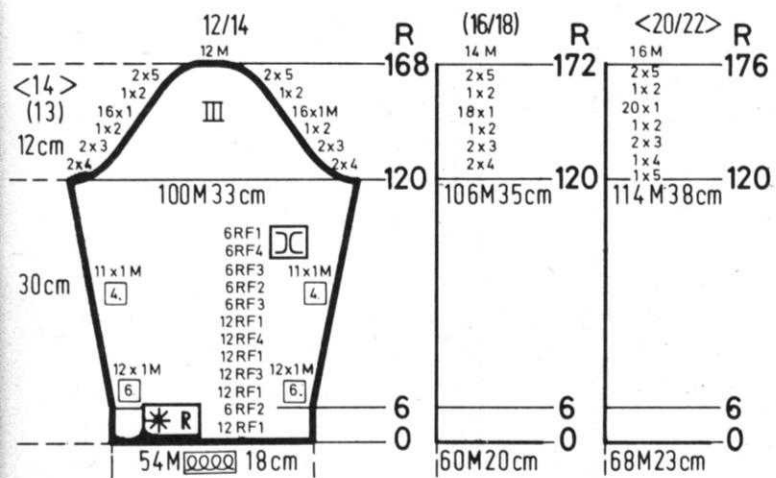

**SLEEVE: III**

Bring 54 (60) [68] needles into working position, set into Pattern. Cast on with color 1 and knit in Pattern with color changes as shown on the Chart. After Row 6, ON EACH SIDE, increase 1 st. every 6th row 12x, every 4th row 11x. Knit to Row 120.  
SHAPE CAP: ON EACH SIDE, bind off 4 sts. 2x, 3 sts. 2x, 2 sts. 1x, 1 st. 16x, 2 sts. 1x, 9 sts. 2x (4 sts. 2x, 3 sts. 2x, 2 sts. 1x, 1 st. 18x, 2 sts. 1x, 5 sts. 2x) [5 sts. 1x, 4 sts. 1x, 3 sts. 2x, 2 sts. 1x, 1 st. 20x, 2 sts. 1x, 5 sts. 2x]  
After Row 168 (172) [176], bind off the remaining 12 (14) [16] sts.

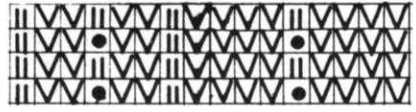

11-12  
7-10  
5-6  
1-4

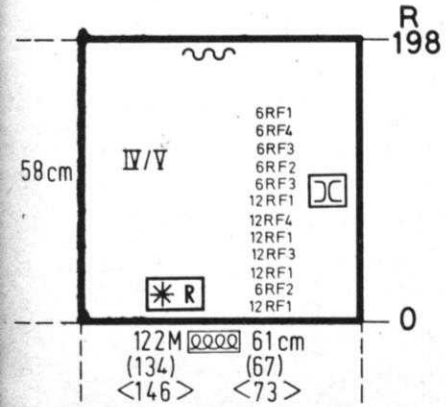

**SKIRT: IV/V**

Make 2 sections  
Bring 122 (134) [146] needles into working position, set into Pattern and cast on with color 1.  
Knit in Pattern with color changes as shown on the Chart to Row 198 then bind off.

# DK 44

## WOMAN'S DRESS

SIZE: 10/12 (14/16) [18/20]

YARN: Allegro - 4 colors

50 gr. balls:	C1	7	(8)	[9]
	C2	3	(3)	[3]
	C3	1	(1)	[1]
	C4	1	(1)	[1]

**E** TENSION:  
Stock: 7 to 9



Pattern: 10



**P** GAUGE:

Stock:  
15 sts. 20 rows = 5 cm (2")  
Pattern:  
10 sts. 17 rows = 5 cm (2")



Stockinette stitch and a Holding Position Design with out of work needles that ARE COUNTED in the stitch Gauge and Instructions. Follow the Line Drawing. The knit side is the right side. Use the Adjustable Needle Selector for Pattern.

FINISHING: See General Instructions. Gather Skirt and sew to bodice. Attach fringe to lower edge of dress. Work 1 row double crochet around neck and sleeves then make a cord over 3 needles using Tension 1 or 2 and pull cord through the double crochet (see picture) and tie in a bow at neckline.

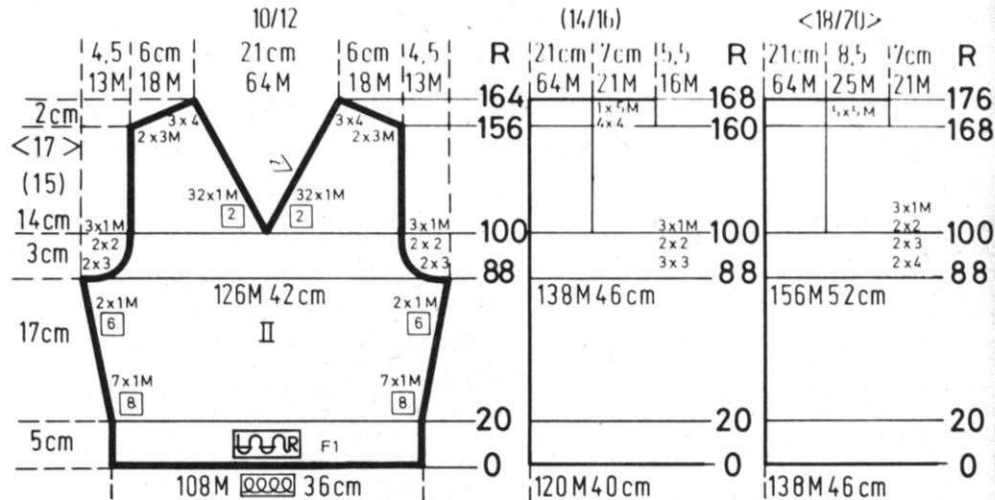

### BODICE BACK: II

Cast on 108 (120) [138] sts. with color 1 and work Stockinette stitch. After Row 20, ON EACH SIDE increase 1 st. every 8th row 7x, every 6th row 2x. Knit to Row 88. SHAPE ARMHOLE: Bind off 3 sts. 2x, 2 sts. 2x, 1 st. 3x (3 sts. 3x, 2 sts. 2x, 1 st. 3x) [4 sts. 2x, 3 sts. 2x, 2 sts. 2x, 1 st. 3x] AND AT THE SAME TIME SHAPE NECK after Row 100 Hang the 2 center sts. 1 to the right and 1 to the left adjacent needle. Put the

needles on the left into holding position and complete the right half first. \* ON NECK SIDE, decrease 1 st. every 2nd row 32x and SHAPE SHOULDER after Row 156 (160) [168] Bind off 3 sts. 2x, 4 sts. 3x (4 sts. 4x, 5 sts. 1x) [5 sts. 5x] Bring the Cam Box to the left side, turn the Row Counter back to 100 and complete the left half. Follow the instructions from \*.

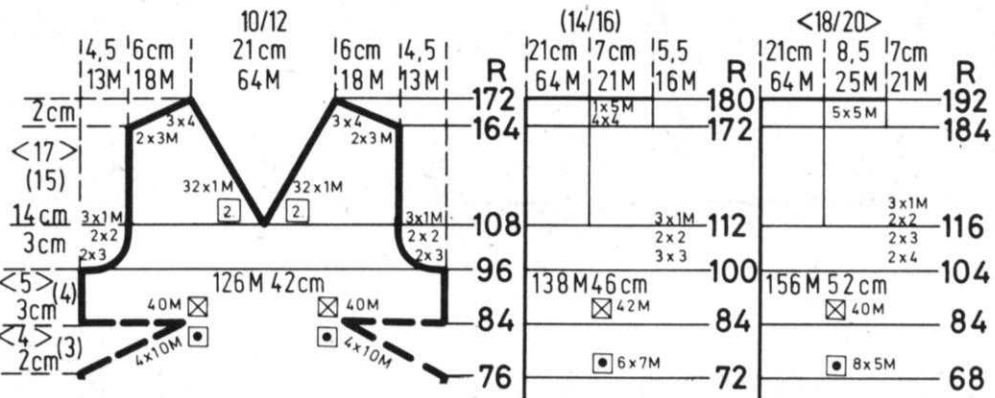

### BODICE FRONT: I

Work the front section the same as the back to Row 76 (72) [68] then work Short Rows for the Bust Dart. ON OPPOSITE SIDE OF CAM BOX, put into holding position 10 sts. 4x ON EACH SIDE (7 sts. 6x ON EACH SIDE) [5 sts. 8x ON EACH SIDE] Bring all the needles back into working position before knitting the next 2 rows. Knit to Row 96 (100) [104] SHAPE ARMHOLE: ON EACH SIDE, bind off 3 sts. 2x, 2 sts. 2x, 1 st. 3x (3 sts. 3x, 2 sts. 2x, 1 st. 3x) [4 sts. 2x, 3 sts. 2x, 2 sts. 2x, 1 st. 3x]

AND AT THE SAME TIME SHAPE NECK after Row 108 (112) [116] Hang the 2 center sts. 1 to the right and 1 to the left adjacent needle put the needles on the left into holding position and complete the right half first. \* ON NECK SIDE, decrease 1 st. every 2nd row 32x and SHAPE SHOULDER after Row 164 (172) [184] Bind off 3 sts. 2x, 4 sts. 3x (4 sts. 4x, 5 sts. 1x) [5 sts. 5x] Bring the Cam Box to the left side, turn the Row Counter back to 108 (112) [116] and complete the left half. Follow the instructions from \*.

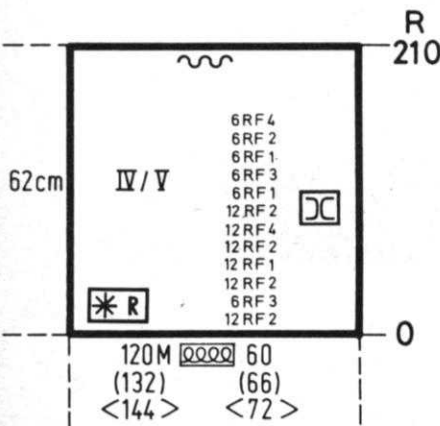

### SKIRT: IV/V

Make 2 sections Bring 120 (132) [144] needles into working position, set into Pattern then cast on with color 2 and knit in Pattern with Color changes as shown on the Chart to Row 210. Bind off.





11-12  
7-10  
5-6  
1-4

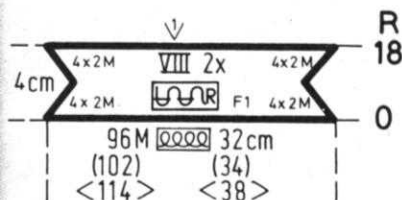

R 18  
0

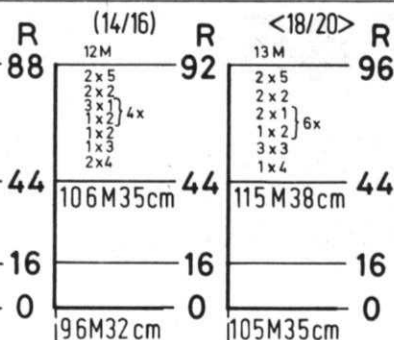
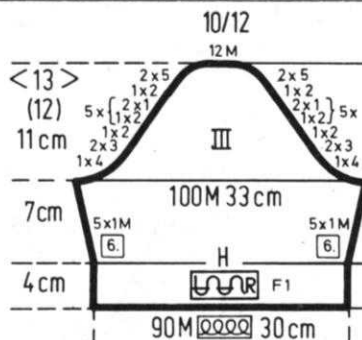

### SLEEVE: III

Cast on 90 (96) [105] sts. with color 1 and work Stockinette stitch. After Row 16, hang the hem and ON EACH SIDE increase 1 st. every 6th row 5x. Knit to Row 44  
SHAPE CAP: ON EACH SIDE, bind off  
4 sts. 1x, 3 sts. 2x, 2 sts. 1x, \*2 sts. 1x, 1 st. 2x, and REPEAT from \*

4x more. 2 sts. 1x, 5 sts. 2x (4 sts. 2x, 3 sts. 1x, 2 sts. 1x, \*2 sts. 1x, 1 st. 3x and REPEAT from \* 3x more, 2 sts. 2x, 5 sts. 2x) [4 sts. 1x, 3 sts. 3x, \*2 sts. 1x, 1 st. 2x, and REPEAT from \* 5x more, 2 sts. 2x, 5 sts. 2x]  
After Row 88 (92) [96] bind off the remaining 12 (12) [13] sts.

### NECKBAND: VIII

Make 2  
Cast on 96 (102) [114] sts. with color 1 and work Stockinette stitch. ON EACH SIDE, decrease 1 st. every 2nd row 4x then ON EACH Side, increase 1 st. every 2nd row 4x. After Row 18, bind off all sts.

# DK 45

## WOMAN'S DRESS

SIZE: 8/10 (12/14) [16/18]

YARN: Beatrice - 4 colors

50 gr. balls: C1 10 (11) [12]  
C2 1 (1) [1]  
C3 1 (1) [1]  
C4 1 (1) [1]

**E** TENSION:  
Stock: 6 to 8  
Pattern: 9



**P** GAUGE:  
Stock:  
16 sts. 22 rows = 5 cm (2")  
Pattern:  
11 sts. 18 rows = 5 cm (2")



Stockinette stitch and a Holding Position Design with needles out of work that ARE COUNTED in the Stitch Gauge and Instructions. Follow the Line Drawing and use the Adjustable Needle Selector.

**FINISHING:** See General Instructions. Gather skirt and sew to bodice. Attach fringe to lower edge of dress. Work 1 row double crochet around neckline and sleeve edges then make cord over 3 needles using Tension 1 or 2 and pull through the double crochet. Sew on 5 buttons, (see picture).

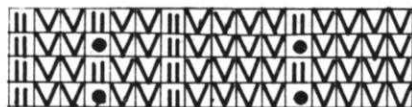

11-12  
7-10  
5-6  
1-4

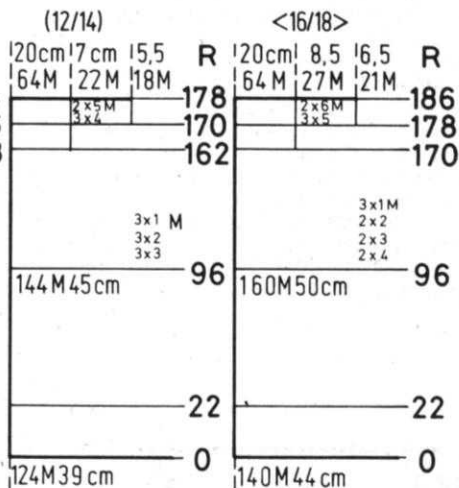
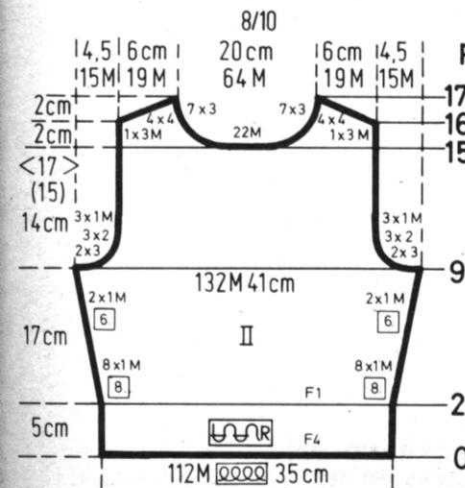

### BODICE BACK: II

Cast on 112 (124) [140] sts. with color 4 and work Stockinette stitch. Knit to Row 22 and change to color 1.  
ON EACH SIDE increase 1 st. every 8th row 8x, every 6th row 2x. Knit to Row 96.  
SHAPE ARMHOLE:  
ON EACH SIDE, bind off  
3 sts. 2x, 2 sts. 3x, 1 st. 3x (3 sts. 3x, 2 sts. 3x, 1 st. 3x) [4 sts. 2x, 3 sts. 2x, 2 sts. 2x, 1 st. 3x]  
Knit to Row 158 (162) [170] bind off the center 22 sts., put the needles on the left side into holding position and complete the right half first.  
\* Bind off  
ON NECK SIDE  
3 sts. 7x (Same as above)  
[Same as above]  
SHAPE SHOULDER AFTER ROW 166 (170) [178]  
3 sts. 1x, 4 sts. 4x (4 sts. 3x, 5 sts. 2x) [5 sts. 3x, 6 sts. 2x]  
Bring the Cam Box to the left side, turn the Row Counter back to 158 (162) [170] and complete the left half.  
Follow the instructions from \*.

# DK 45

## BODICE FRONT: I

Work the front section the same as the back to Row 84 (80) [76] then work Short Rows for the Bust Darts.

ON OPPOSITE SIDE OF CAM BOX put into holding position

8 sts. 5x  
(6 sts. 7x)  
[5 sts. 9x]

ON OPPOSITE SIDE OF CAM BOX, bring all the needles back into working position before knitting the next 2 rows.

Knit to Row 108 (112) [116]

SHAPE ARMHOLE:

ON EACH SIDE bind off

3 sts. 2x, 2 sts. 3x, 1 st. 3x

(3 sts. 3x, 2 sts. 3x, 1 st. 3x)

[4 sts. 2x, 3 sts. 2x, 2 sts. 2x, 1 st. 3x]

AND SHAPE NECK AFTER Row 116

(120) [124]. Hang the 2 center sts. 1 to the right and to the left adjacent needle, put the needles on the left side into holding position and complete the right half first.

\* ON NECK SIDE, decrease 1 st. every 2nd row 29x, every 4th row 3x AND AT THE SAME TIME, SHAPE SHOULDER after Row 178 (186) [198]

Bind off

3 sts. 1x, 4 sts. 4x

(4 sts. 3x, 5 sts. 2x)

[5 sts. 3x, 6 sts. 2x]

Move the Cam Box to the left side, turn the Row Counter back to 116 (120) [124] and complete the left half.

Follow the instructions from \*.

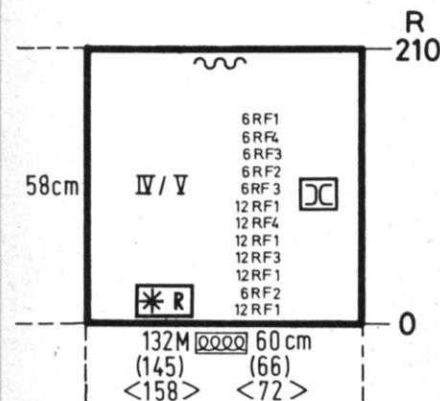
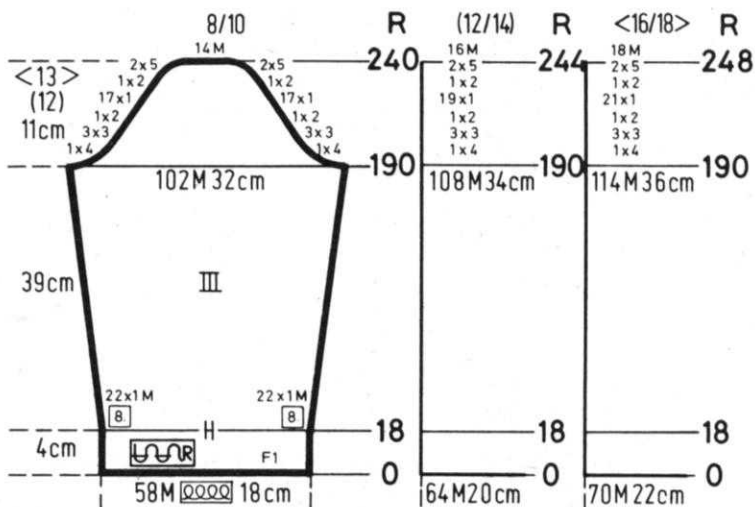
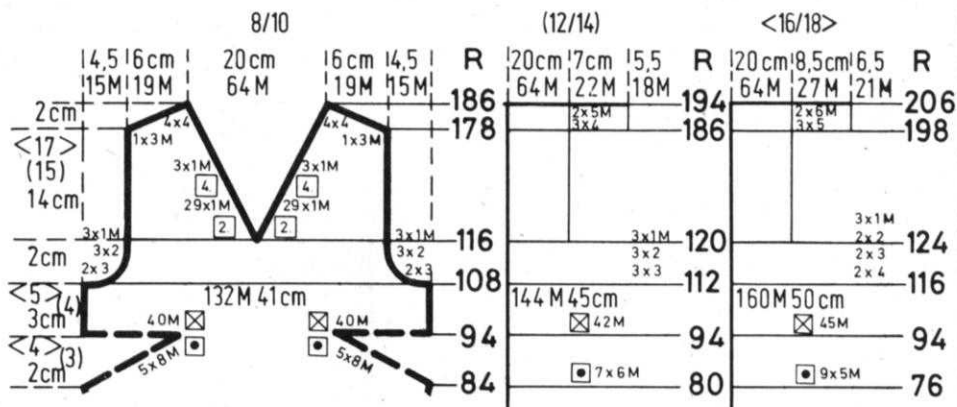

## SKIRT:

Make 2 sections

Bring 132 (145) [158] needles into working position, then set in Pattern. Cast on with Color 1 and Knit in Pattern with color changes as shown on the Chart to Row 210. Bind off

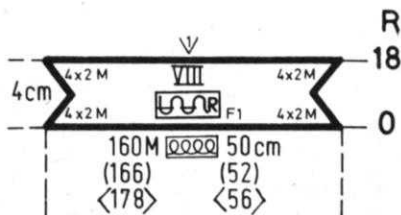

## NECKBAND: VIII

Cast on 160 (166) [178] sts. with color 1 and work Stockinette stitch.

ON EACH SIDE, decrease 1 st. every 2nd row 4x, then ON EACH SIDE increase 1 st. every 2nd row 4x.

After Row 18, bind off.

## SLEEVE: III

Cast on 58 (64) [70] sts. with color 1 and work Stockinette stitch.

Knit to Row 18 then hang the hem.

ON EACH SIDE, increase 1 st. every 8th row 22x.

Knit to Row 190.

SHAPE CAP:

ON EACH SIDE, bind off

4 sts. 1x, 3 sts. 3x, 2 sts. 1x, 1 st. 17x,

2 sts. 1x, 5 sts. 2x

(4 sts. 1x, 3 sts. 3x, 2 sts. 1x, 1 st. 19x,

2 sts. 1x, 5 sts. 2x)

[4 sts. 1x, 3 sts. 3x, 2 sts. 1x, 1 st. 21x,

2 sts. 1x, 5 sts. 2x]

After Row 240 (244) [248], bind off the remaining 14 (16) [18] sts.



# DK 46



## WOMAN'S DRESS

SIZE: 7/8 (10/12) [14/16]

YARN: Beatrice - 4 colors

50 gr. balls: C1 9 (10) [11]  
 C2 1 (1) [1]  
 C3 1 (1) [1]  
 C4 3 (3) [3]

**E** TENSION:  
 Stock: 6 to 8   
 Pattern: 9 

**P** GAUGE:  
 Stock:   
 16 sts. 22 rows = 5 cm (2)  
 Pattern:   
 16 sts. 18 rows = 5 cm (2")

Stockinette stitch and a Holding Position Design with out of work needles that ARE COUNTED in the stitch gauge and instructions. Follow the Line Drawing. Worn on the knit side. Use the Adjustable Needle Selector for Pattern.

FINISHING: See General Instructions. Same as DK 45 (see picture).

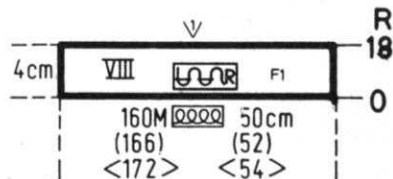
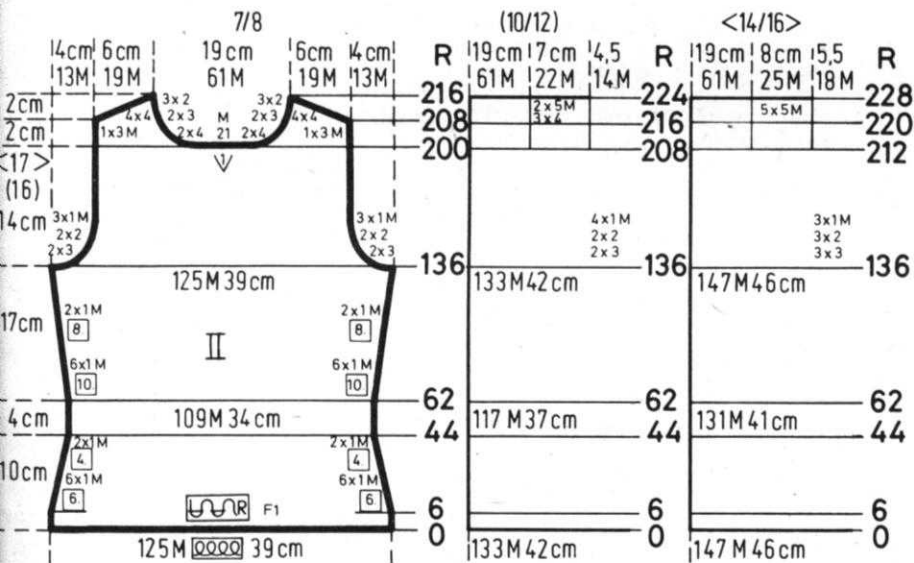

### NECKBAND: VIII

Cast on 160 (166) [172] sts. with color 1 and work 18 rows Stockinette stitch then bind off.

### BODICE BACK: II

Cast on 125 (133) [147] sts. with color 1 and work Stockinette stitch.  
 ON EACH SIDE, decrease 1 st. every 4th row 6x, every 4th row 2x.  
 Knit to Row 62.  
 ON EACH SIDE, increase 1 st. every 4th row 6x, every 8th row 2x.  
 Knit to Row 136.  
 SHAPE ARMHOLE:  
 ON EACH SIDE, bind off 3 sts. 2x, 2 sts. 2x, 1 st. 3x  
 3 sts. 2x, 2 sts. 2x, 1 st. 4x  
 3 sts. 3x, 2 sts. 3x, 1 st. 3x  
 Knit to Row 200 (208) [212]. Bind off the center 21 sts. put the needles on the left

side into holding position and complete the right half first.

\* Bind off

FOR NECK

4 sts. 2x, 3 sts. 2x, 2 sts. 3x

(Same as above)

[Same as above]

FOR SHOULDER after Row 208 (216) [220]

3 sts. 1x, 4 sts. 4x

(4 sts. 3x, 5 sts. 2x)

[5 sts. 5x]

Bring the Com Box to the left side, turn the Row Counter back to 200 (208) [212] and complete the left half.

Follow the instructions from \*.

### BODICE FRONT: I

Work the front the same as the back to Row 172. Bind off the center 15 sts., put the needles on the left side into holding position and complete the right half first.  
 \* ON NECK SIDE, bind off 3 sts. 4x, 2 sts. 4x, 1 st. 3x

SHAPE SHOULDER after Row 208

(216) [220]. Bind off

3 sts. 1x, 4 sts. 4x

(4 sts. 3x, 5 sts. 2x)

[5 sts. 5x]

Bring the Cam Box to the left side, turn the Row Counter back to 172 and complete the left half.

Follow the instructions from \*.

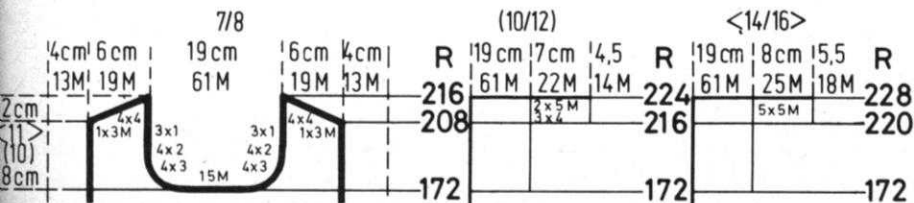

# DK 46

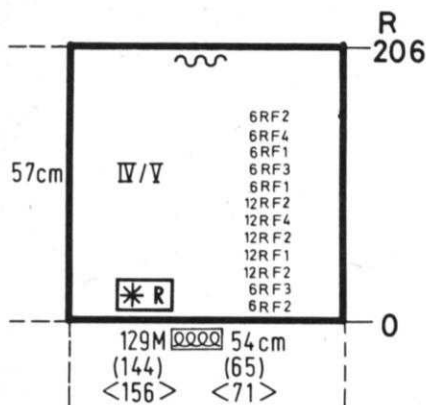

## SKIRT: IV/V

Make 2 sections  
Bring 129 (144) [156] needles into working position, set into Pattern. Cast on with color 2 and knit in Pattern with color changes as marked on the Chart to Row 206. Bind off.

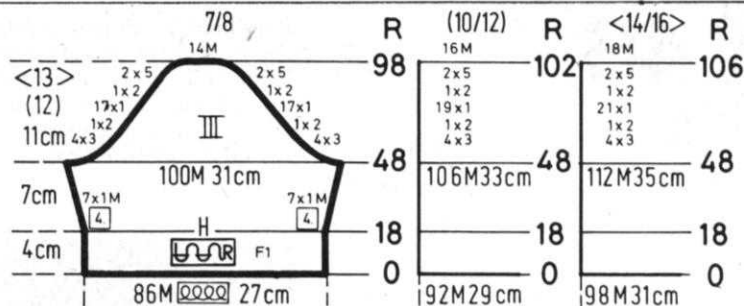

## SLEEVE: III

Cast on 86 (92) [98] sts. with color 1 and work Stockinette stitch. Knit to Row 18 then hang the hem. ON EACH SIDE increase 1 st. every 4th row 7x. Knit to Row 48  
SHAPE CAP:  
ON EACH SIDE, bind off  
3 sts. 4x, 2 sts. 1x, 1 st. 17x, 2 sts. 1x, 5 sts. 2x  
(3 sts. 4x, 2 sts. 1x, 1 st. 19x, 2 sts. 1x, 5 sts. 2x)  
(3 sts. 4x, 2 sts. 1x, 1 st. 21x, 2 sts. 1x, 5 sts. 2x)  
After Row 98 (102) [106], bind off the remaining 14 (16) [18] sts.

# DK 47

## WOMAN'S DRESS

SIZE: 8/10 (12/14) [16/18]

YARN: Beatrice - 4 colors

50 gr. balls: C1 8 (9) [10]  
C2 3 (3) [3]  
C3 1 (1) [1]  
C4 1 (1) [1]

**E** TENSION:  
Stock: 6 to 8  
Pattern: 9

**P** GAUGE:  
Stock:  
16 sts. 22 rows = 5 cm (2")  
Pattern:  
11 sts. 18 rows = 5 cm (2")

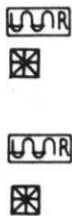

Stockinette stitch and a Holding Position Design with out of work needles that ARE COUNTED in the Stitch gauge and instructions. Follow the Line Drawing. Use the Adjustable Needle Selector. Worn on the knit side.

FINISHING: See General Instructions. Gather Skirt and sew to bodice. Attach fringe to lower edge of dress. Work 1 row of single crochet and picots around neckline and sleeve edges.

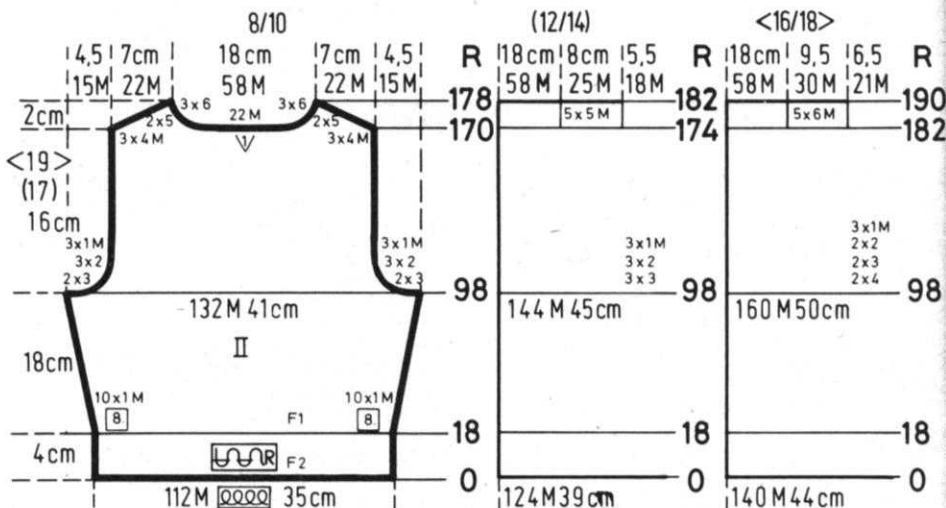

## BODICE BACK:

Cast on 112 (124) [140] sts. with color 2 and work Stockinette stitch. Knit to Row 18, then change to color 2. ON EACH SIDE, increase 1 st. every 8th row 10x. Knit to Row 98.  
SHAPE ARMHOLE:  
ON EACH SIDE bind off  
3 sts. 2x, 2 sts. 3x, 1 st. 3x  
(3 sts. 3x, 2 sts. 3x, 1 st. 3x)  
[4 sts. 2x, 3 sts. 2x, 2 sts. 2x, 1 st. 3x]  
Knit to Row 170 (174) [182]. Bind off the center 22 sts. put the needles on the left side into holding position and complete the right half first.  
\* Bind off

ON SHOULDER SIDE  
4 sts. 3x, 5 sts. 2x  
(5 sts. 5x)  
[6 sts. 5x]

ON NECK SIDE  
6 sts. 3x  
(Same as above)  
[Same as above]

Bring the Cam Box to the left side, turn the Row Counter back to 170 (174) [182] and complete the left half. Follow the instructions from \*.



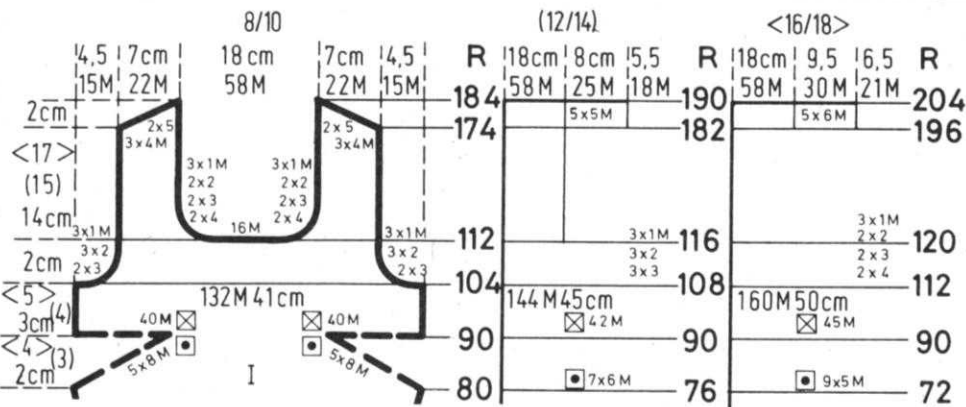

**BODICE FRONT:**

Work the front section the same as the back to Row 80 (76) [72] then work Short Rows for the Bust Darts.  
 ON OPPOSITE SIDE OF CAM BOX, put into holding position  
 8 sts. 5x ON EACH SIDE  
 (6 st. 7x ON EACH SIDE)  
 [5 sts. 9x ON EACH SIDE]  
 ON OPPOSITE SIDE OF CAM BOX, bring all the needles back into working position before knitting the next 2 rows  
 Knit to Row 104 (108) [112]  
 SHAPE ARMHOLE:  
 ON EACH SIDE, bind off  
 3 st. 2x, 2 sts. 3x, 1 st. 3x  
 (3 sts. 3x, 2 sts. 3x, 1 st. 3x)  
 [4 sts. 2x, 3 sts. 2x, 2 sts. 2x, 1 st. 3x]

AND AT THE SAME TIME after Row 112 (116) [120] bind off the center 16 sts., put the needles on the left side into holding position and complete the right half first.  
 \* ON NECK SIDE, bind off  
 4 sts. 2x, 3 sts. 2x, 2 sts. 2x, 1 st. 3x  
 SHAPE SHOULDER after Row 174 (182) [196]. Bind off  
 4 sts. 3x, 5 sts. 2x  
 (5 sts. 5x)  
 [6 sts. 5x]  
 Bring the Cam Box to the left side, turn the Row Counter back to 112 (116) [120] and complete the left half.  
 Follow the instructions from \*.

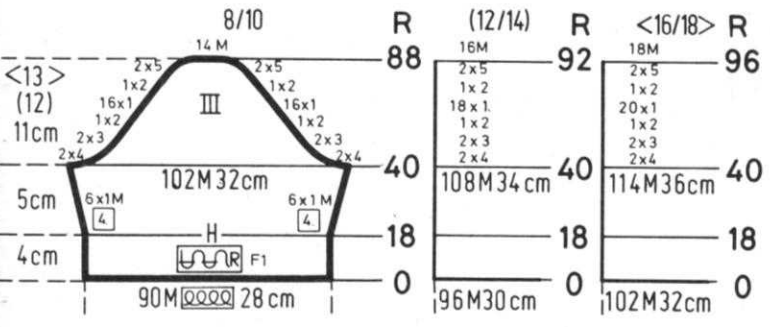

**SLEEVE: III**

Cast on 90 (96) [102] sts. with color 1 and work Stockinette stitch.  
 Knit to Row 18 then hang the hem.  
 ON EACH SIDE, increase 1 st. every 4th row 6x  
 After Row 40 SHAPE ARMHOLE:  
 ON EACH SIDE bind off  
 4 st. 2x, 3 sts. 2x, 2 sts. 1x, 1 st. 16x,  
 2 sts. 1x, 5 sts. 2x  
 (4 sts. 2x, 3 sts. 2x, 2 sts. 1x, 1 st. 18x,  
 2 sts. 1x, 5 sts. 2x)  
 [4 sts. 2x, 3 sts. 2x, 2 sts. 1x, 1 st. 20x,  
 2 sts. 1x, 5 sts. 2x]  
 After Row 88 (92) [96], bind off the remaining 14 (16) [18] sts.

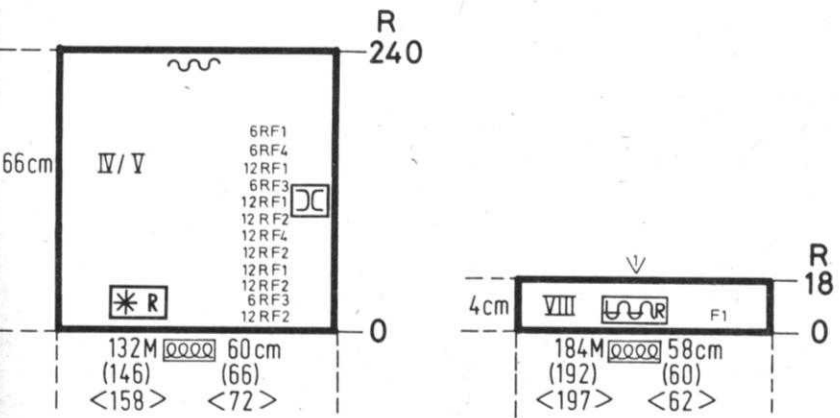

**SKIRT: IV/V**

Make 2 sections  
 Bring 132 (146) [158] needles into working position, set Pattern. Cast on with color 2 and knit in Pattern with color changes as shown on the Chart. Knit to Row 240. Bind off.

**NECKBAND: VIII**

Cast on 184 (192) [197] sts. with color 1 and work 18 rows Stockinette stitch then bind off.

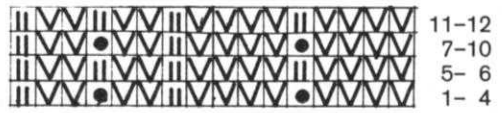

# DK 48

## WOMAN'S DRESS

SIZE: 10/12 (14/16) [18/20]

YARN: Beatrice - 4 colors

50 gr. balls: C1 7 (8) [9]  
 C2 3 (3) [3]  
 C3 1 (1) [1]  
 C4 1 (1) [1]

**E** TENSION:  
 Stock: 6 to 8  
 Pattern: 9



**P** GAUGE:  
 Stock:  
 16 sts. 22 rows = 5 cm (2")  
 Pattern:  
 11 sts. 18 rows = 5 cm (2")



Stockinette stitch and a Holding Position Design with needles out of work that ARE COUNTED in the stitch gauge and instructions. Follow the Line Drawing and use the Adjustable Needle Selector. The knit side is the right side.

FINISHING: See General Instructions. Gather skirt and sew to bodice. Work 1 row double crochet around neckline and sleeves. Make cord over 3 needles using Tension 1 or 2 then pull through the double crochet. See picture. Attach fringe to lower edge of dress.

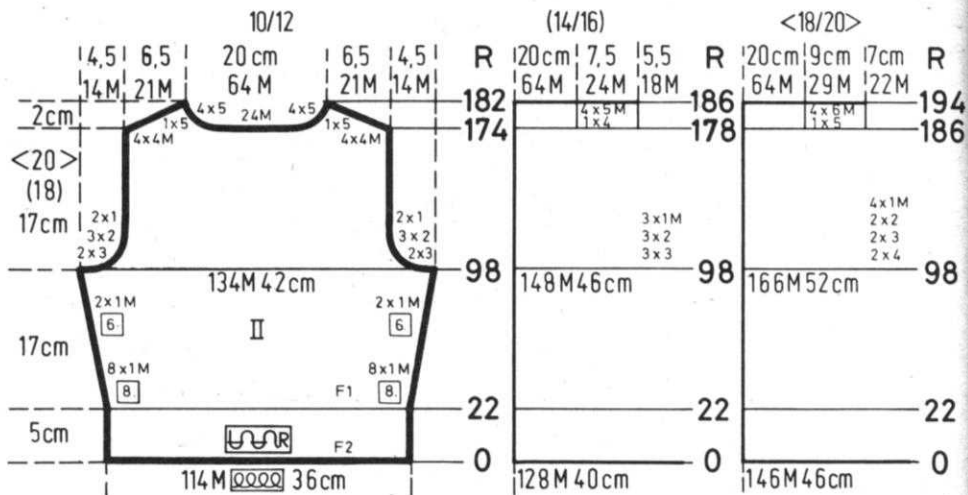

### BODICE BACK: II

Cast on 114 (128) [146] sts. with color 2 and work Stockinette stitch. Knit to Row 22 then change to color 1.  
 ON EACH SIDE increase 1 st. every 8th row 8x, every 6th row 2x.  
 SHAPE ARMHOLE after Row 98. Bind off 3 sts. 2x, 2 sts. 3x, 1 st. 2x (3 sts. 3x, 2 sts. 3x, 1 st. 3x) [4 sts. 2x, 3 sts. 2x, 2 sts. 2x, 1 st. 4x]  
 Knit to Row 174 (178) [186], bind off the center 24 sts., put the needles on the left side into holding position and complete the right half first  
 \* Bind off

FOR SHOULDER  
 4 sts. 4x, 5 sts. 1x  
 (4 sts. 1x, 5 sts. 4x)  
 [5 sts. 1x, 6 sts. 4x]

FOR NECK  
 5 sts. 4x  
 (Same as above)  
 [Same as above]

Move the Cam Box to the left side, turn the Row Counter back to 174 (178) [186] and complete the left half.  
 Follow the instructions from \*.

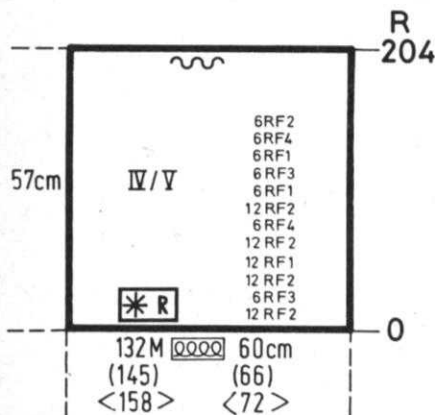

### SKIRT: IV/V

Make 2 sections  
 Bring 132 (145) [158] needles into working position, set in Pattern.  
 Cast on with color 2 and work in Pattern with color changes as shown on the Chart to Row 204. Bind off.

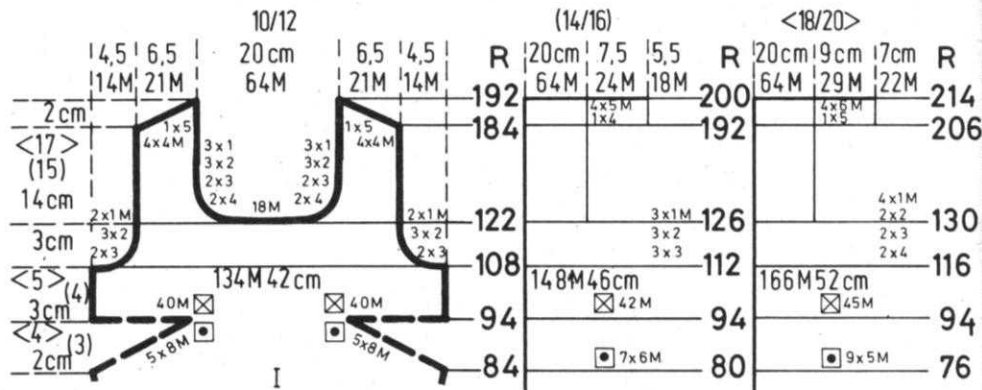

### BODICE FRONT: I

Work the front section the same as the back to Row 84 (80) [76] then work Short Rows for the Bust Darts.  
 ON OPPOSITE SIDE OF CAM BOX, put into holding position  
 8 sts. 5x  
 (6 sts. 7x)  
 [5 sts. 9x]  
 ON OPPOSITE SIDE OF CAM BOX, bring all the needles back into working position before knitting the next 2 rows.  
 SHAPE ARMHOLE after Row 108 (112) [116]. Bind off  
 3 sts. 2x, 2 sts. 3x, 1 st. 2x  
 (3 sts. 3x, 2 sts. 3x, 1 st. 3x)  
 [4 sts. 2x, 3 sts. 2x, 2 sts. 2x, 1 st. 4x]

AT THE SAME TIME after Row 122 (126) [130] bind off the center 18 sts., put the needles on the left side into holding position and complete the right half first  
 \* ON NECK SIDE bind off  
 4 sts. 2x, 3 sts. 2x, 2 sts. 3x, 1 st. 3x  
 SHAPE SHOULDER after Row 184 (192) [206]. Bind off  
 4 sts. 4x, 5 sts. 1x  
 (4 sts. 1x, 5 sts. 4x)  
 [5 sts. 1x, 6 sts. 4x]  
 Move the Cam Box to the left side, turn the Row Counter back to 122 (126) [130] and complete the left half.  
 Follow the instructions from \*.



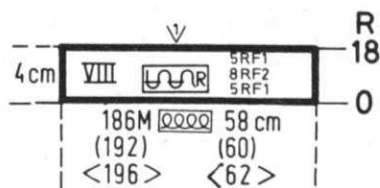
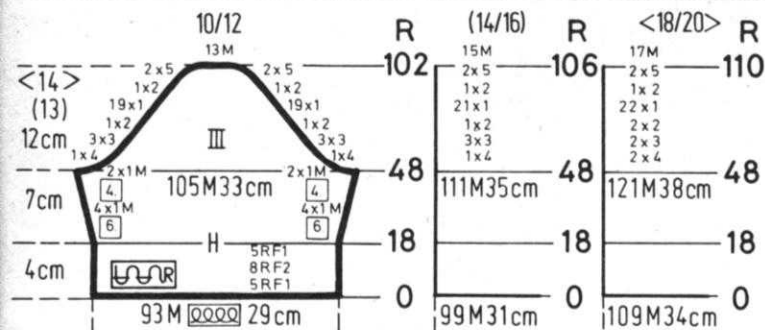

**NECKBAND: VIII**

Cast on 186 (192) [196] sts. with color 1 and work 18 rows Stockinette stitch with color changes as shown on the Chart. Bind off.

**SLEEVE: III**

Cast on 93 (99) [109] sts. with color 1 and work Stockinette stitch. Follow the Chart for the color changes to Row 18 then hang the hem and continue with color 1.  
ON EACH SIDE, increase 1 st. every 6th row 4x, every 4th row 2x.  
SHAPE CAP after Row 48.  
ON EACH SIDE bind off

4 sts. 1x, 3 sts. 3x, 2 sts. 1x, 1 st. 19x,  
2 sts. 1x, 5 sts. 2x  
(4 sts. 1x, 3 sts. 2x, 2 sts. 2x, 1 st. 22x,  
2 sts. 1x, 5 sts. 2x)  
[4 sts. 2x, 3 sts. 2x, 2 sts. 2x, 1 st. 22x,  
2 sts. 1x, 5 sts. 2x]  
After Row 102 (106) [110], bind off the remaining 13 (15) [17] sts.



**DK 49**

**WOMAN'S DRESS**

SIZE: 7/8 (10/12) [14/16]

YARN: Beatrice - 4 colors

50 gr. balls:	C1	8	(9)	[10]
	C2	3	(3)	[3]
	C3	1	(1)	[1]
	C4	1	(1)	[1]

**TENSION:**  
Stock: 6 to 8  
Pattern: 9

**GAUGE:**  
Stock:  
16 sts. 22 rows = 5 cm (2")  
Pattern:  
11 sts. 18 rows = 5 cm (2")

Stockinette stitch and a Holding Position Design with out of work needles that ARE COUNTED in the Stitch Gauge and Instructions. Follow the Line Drawing and use the Adjustable Needle Selector. Worn on the knit side.

**FINISHING:** See General Instructions. Gather skirt and sew to bodice. Attach fringe to lower edge of dress. Work 1 row single crochet around neck opening then set in zipper. Work 1 row Double crochet around neck and sleeves then make cord over 3 needles using Tension 1 or 2 and pull through double crochet. See picture.

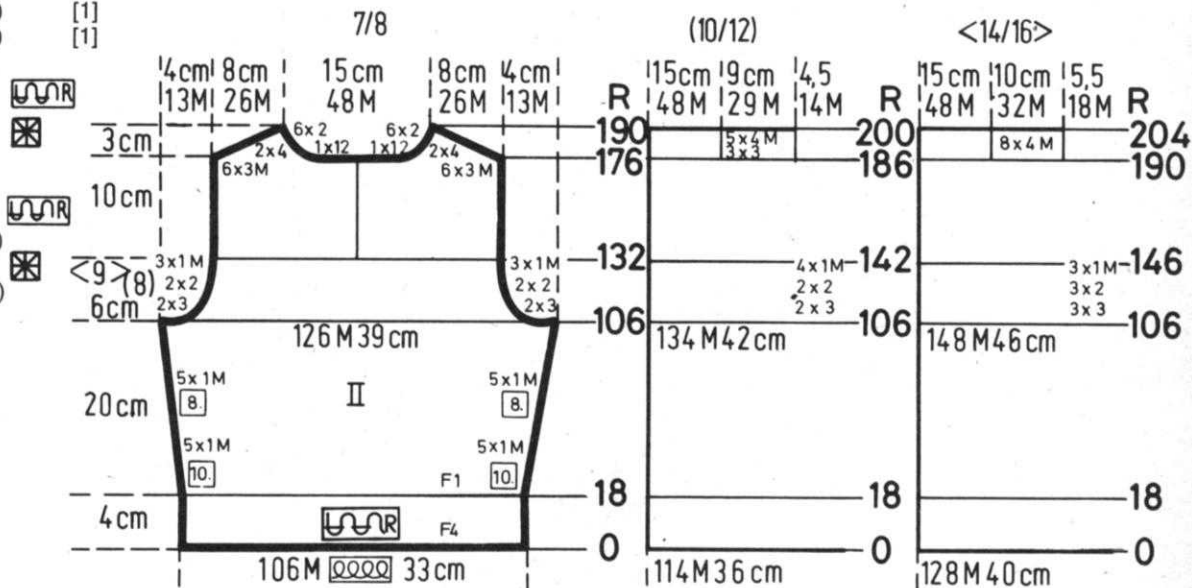

**BODICE BACK: II**

Cast on 106 (114) [128] sts. with color 4 and work Stockinette stitch. Knit to Row 18 the change to color 1.  
ON EACH SIDE increase 1 st. every 10th row 5x, every 8th row 5x. Knit to Row 106.  
SHAPE ARMHOLE:  
ON EACH SIDE, bind off  
3 sts. 2x, 2 sts. 2x, 1 st. 3x  
(3 sts. 2x, 2 sts. 2x, 1 st. 4x)  
[3 sts. 3x, 2 sts. 3x, 1 st. 3x]  
Knit to Row 132 (142) [146] Divide in the center and put the needles on the left side into holding position and complete the right half first.  
\* Knit to Row 176 (186) [190]

Bind off  
**FOR SHOULDER**  
3 sts. 6x, 4 sts. 2x  
(3 sts. 3x, 4 sts. 5x)  
[4 sts. 8x]

**FOR NECK**  
12 sts. 1x, 2 sts. 6x  
(Same as above)  
[Same as above]

Move the Cam Box to the left side, turn the Row Counter back to 132 (142) [146] and complete the left half.  
Follow the instructions from \*.

# DK 49

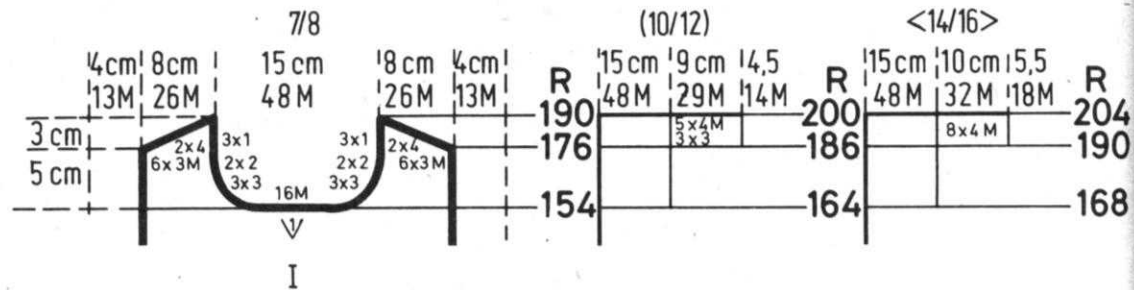

## BODICE FRONT:

Work the front section the same as the back to Row 154 (164) [168] BUT DO NOT DIVIDE IN CENTER.

Bind off the center 16 sts., put the needles on the left side into holding position and complete the right half first.

\* ON NECK SIDE, bind off

3 sts. 3x, 2 sts. 2x, 1 st. 3x

SHAPE SHOULDER after Row 176 (186)

[190]. Bind off

3 sts. 6x, 4 sts. 2x

(3 sts. 3x, 4 sts. 5x)

[4 sts. 8x]

Move the Cam Box to the left side, turn the Row Counter back to 154 (164) [168] and complete the left half.

Follow the instructions from \*.

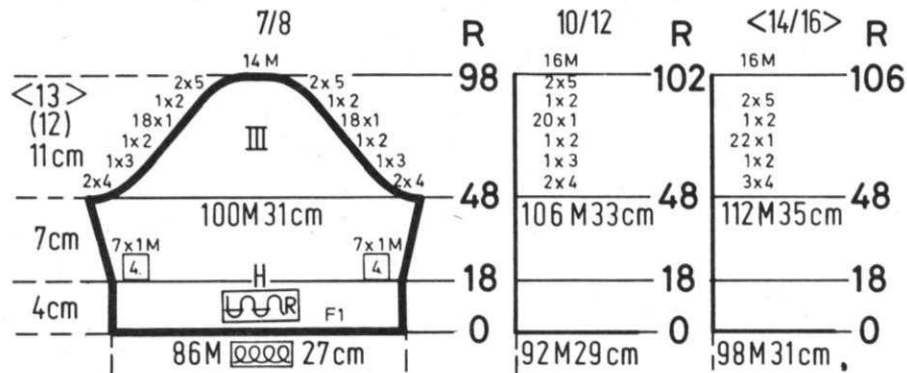

## SLEEVE: III

Cast on 86 (92) [98] sts. with color 1 and work Stockinette stitch. Knit to Row 18, then hang the hem.

ON EACH SIDE increase 1 st. every 4th row 7x.

Knit to Row 48.

SHAPE CAP:

ON EACH SIDE bind off

4 sts. 2x, 3 sts. 1x, 2 sts. 1x, 1 sts. 18x,

2 sts. 1x, 5 sts. 2x

(4 sts. 2x, 3 sts. 1x, 2 sts. 1x, 1 st. 20x,

2 sts. 1x, 5 sts. 2x)

[4 sts. 3x, 2 sts. 1x, 1 st. 22x,

2 sts. 1x, 5 sts. 2x]

After Row 98 (102) [106] bind off the remaining 14 (16) [16] sts.

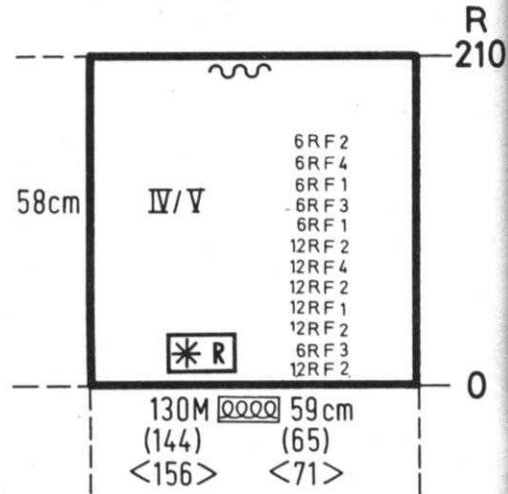

## SKIRT: IV/V

Make 2 sections

Bring 130 (144) [156] needles into working position, set into Pattern. Cast on with color 2 and work in Pattern with color changes as shown on the Chart to Row 210. Bind off.

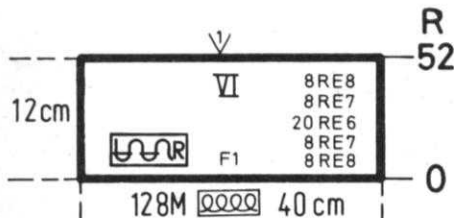

## COLLAR: VI

Cast on 128 sts. with color 1 and work 52 rows Stockinette stitch with Tension changes as shown on the Chart. Bind off.





# DK 50

## WOMAN'S DRESS

SIZE: 10/12 (14/16) [18/20]

YARN: Beatrice - 4 colors

50 gr. balls: C1 8 (9) [10]  
 C2 3 (3) [3]  
 C3 1 (1) [1]  
 C4 1 (1) [1]

**E** TENSION:  
 Stock: 6 to 8  
 Pattern: 9



**P** GAUGE:  
 Stock:  
 16 sts. 22 rows = 5 cm (2")  
 Pattern:  
 11 sts. 18 rows = 5 cm (2")



Stockinette stitch and a Holding Position Design with out of work needles that ARE COUNTED in the Stitch Gauge and Instructions. Follow the Line Drawing and use the Adjustable Needle Selector. Worn on the knit side.

FINISHING: See General Instructions. Gather skirt and sew to bodice. Attach fringe to lower edge of dress. Single crochet around back neck opening then set in zipper. Work 1 row Picots around neck and sleeves.

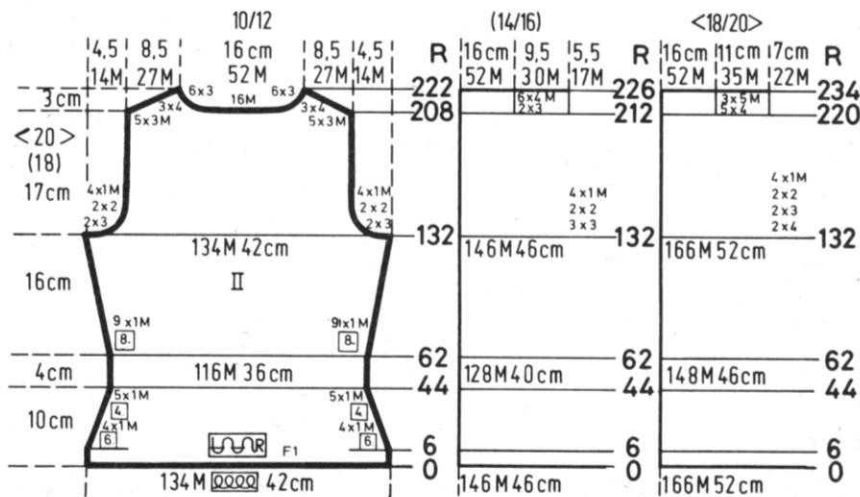

### BODICE BACK: II

Cast on 134 (146) [166] sts. with color 1 and work Stockinette stitch. After Row 6 ON EACH SIDE, decrease 1 st. every 6th row 4x, every 4th row 5x. Knit to Row 62.  
 ON EACH SIDE, increase 1 st. every 8th row 9x. Knit to Row 132.  
 SHAPE ARMHOLE:  
 ON EACH SIDE, bind off 3 sts. 2x, 2 sts. 2x, 1 st. 4x (3 sts. 3x, 2 sts. 2x, 1 st. 4x) [4 sts. 2x, 3 sts. 2x, 2 sts. 2x, 1 st. 4x] Knit to Row 208 (212) [220] bind off the center 16 sts., put the needles on the left side into holding position and

complete the right half first.

\* Bind off  
 FOR SHOULDER  
 3 sts. 5x, 4 sts. 3x  
 (3 sts. 2x, 4 sts. 6x)  
 [4 sts. 5x, 5 sts. 3x]

FOR NECK  
 3 sts. 6x  
 (Same as above)  
 [Same as above]

Move the Cam Box to the left side, turn the Row Counter back to 208 (212) [220] and complete the left half. Follow the instructions from \*.

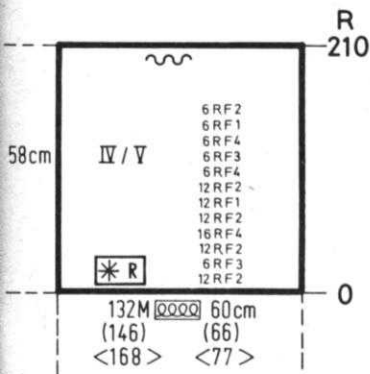

### SKIRT: IV/V

Make 2 sections  
 Bring 132 (146) [168] needles into working position, set in Pattern. Cast on with color 2 and knit in Pattern with color changes as shown on the Chart to Row 210. Bind off.

### BODICE FRONT: I

Work the front section the same as the back to Row 118 (114) [110] then work Short Rows for the Bust Darts.  
 ON OPPOSITE SIDE OF CAM BOX put into holding position  
 8 sts. 5x  
 (6 sts. 7x)  
 [5 sts. 9x]  
 ON OPPOSITE SIDE OF CAM BOX, bring all the needles back into working position before knitting the next 2 rows. Knit to Row 142 (146) [150]  
 SHAPE ARMHOLE:  
 ON EACH SIDE bind off 3 sts. 2x, 2 sts. 2x, 1 st. 4x (3 sts. 3x, 2 sts. 2x, 1 st. 4x) [4 sts. 2x, 3 sts. 2x, 2 sts. 2x, 1 st. 4x]

Knit to Row 192 (200) [208] bind off the center 14 sts., put the needles on the left side into holding position and complete the right half first.

\* Bind off  
 FOR NECK  
 3 sts. 3x, 2 sts. 3x, 1 st. 4x  
 (Same as above)  
 [Same as above]  
 SHAPE SHOULDER AFTER ROW 218 (226) [234]  
 3 sts. 5x, 4 sts. 3x  
 (3 sts. 2x, 4 sts. 6x)  
 [4 sts. 5x, 5 sts. 3x]  
 Move the Cam Box to the left side, turn the Row Counter back to 192 (200) [208] and complete the left half. Follow the instructions from \*.





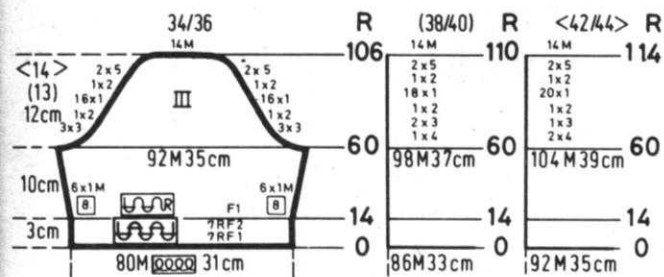

### PULLOVER SLEEVE: III

Cast on 80 (86) [92] sts. with color 1 and work K1, P1 Ribbing with color changes as shown on the Chart to Row 14. Change to color 1 and Stockinette stitch. ON EACH SIDE increase 1 st. every 8th row 6x.

AFTER ROW 60 SHAPE CAP:

ON EACH SIDE, bind off  
 3 sts. 3x, 2 sts. 1x, 1 st. 16x, 2 sts. 1x, 5 sts. 2x  
 (4 sts. 1x, 3 sts. 2x, 2 sts. 1x, 1 st. 18x, 2 sts. 1x, 5 sts. 2x)  
 [4 sts. 2x, 3 sts. 1x, 2 sts. 1x, 1 st. 20x, 2 sts. 1x, 5 sts. 2x]  
 After Row 106 (110) [114] bind off the remaining 14 sts.

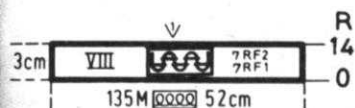

### PULLOVER NECKBAND: VIII

Cast on 135 sts. with color 1 and work 14 rows K1, P1 Ribbing with color change as shown on the Chart. Bind off.

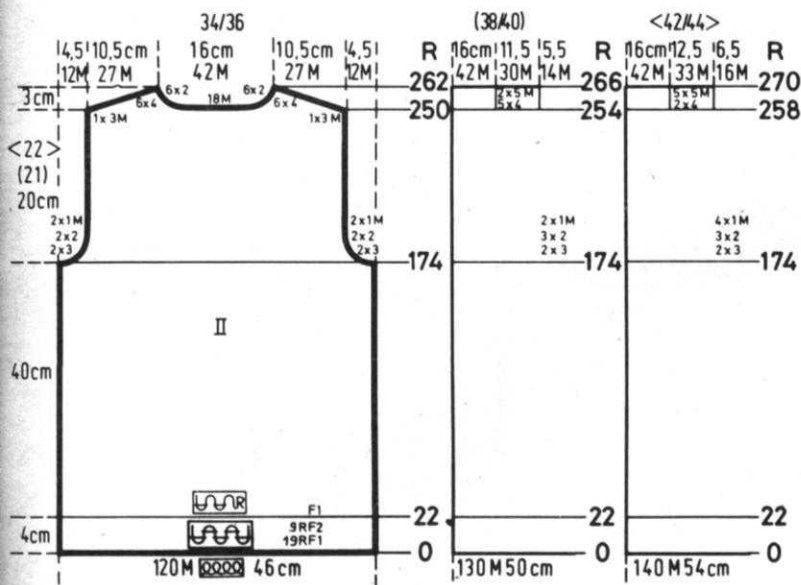

### JACKET BACK: II

Cast on 120 (130) [140] sts. with color 1 and work K1, P1 Ribbing with color change as shown on the Chart to Row 22. Change to color 1 and Stockinette stitch. Knit to Row 174.

SHAPE ARMHOLE:

ON EACH SIDE bind off  
 3 sts. 2x, 2 sts. 2x, 1 st. 2x  
 (3 sts. 2x, 2 sts. 3x, 1 st. 2x)  
 [3 sts. 2x, 2 sts. 3x, 1 st. 4x]  
 Knit to Row 250 (254) [258]. Bind off the center 18 sts., put the needles on the left side into holding position and complete the right half first.

\* Bind off

FOR SHOULDER

3 sts. 1x, 4 sts. 6x  
 (4 sts. 5x, 5 sts. 2x)  
 [4 sts. 2x, 5 sts. 5x]

FOR NECK

2 sts. 6x  
 (Same as above)  
 [Same as above]

Move the Cam Box to the left side, turn the Row Counter back to 250 (254) [258] and complete the left half. Follow the instructions from \*.

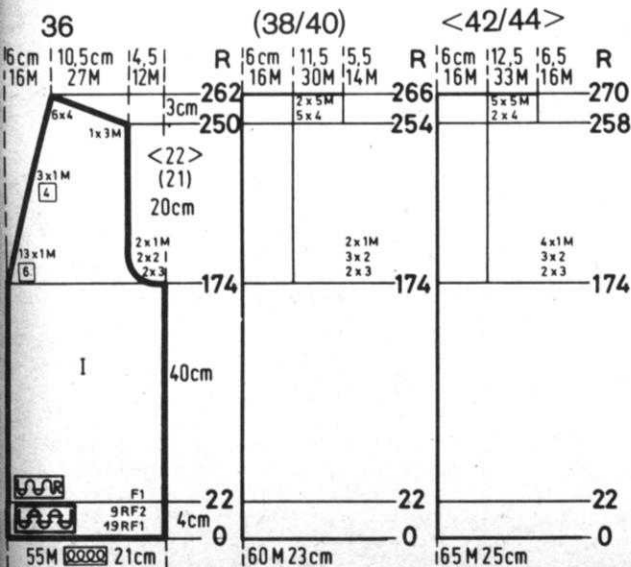

### JACKET FRONT: I

Cast on 55 (60) [65] sts. with color 1 and work K1, P1 Ribbing with color change as shown on the Chart to Row 22. Change to Stockinette stitch and color 1. Knit to Row 174.

SHAPE ARMHOLE AND NECK

AT THE SAME TIME  
 ON NECK SIDE decrease 1 st. every 6th row 13x, every 4th row 3x.  
 Bind off for ARMHOLE  
 3 sts. 2x, 2 sts. 2x, 1 st. 2x  
 (3 sts. 2x, 2 sts. 3x, 1 st. 2x)  
 [3 sts. 2x, 2 sts. 3x, 1 st. 4x]

SHAPE SHOULDER after Row 250 (254) [258]  
 Bind off  
 3 sts. 1x, 4 sts. 6x  
 (4 sts. 5x, 5 sts. 2x)  
 [4 sts. 2x, 5 sts. 5x]

Make the second front section with reverse shaping.





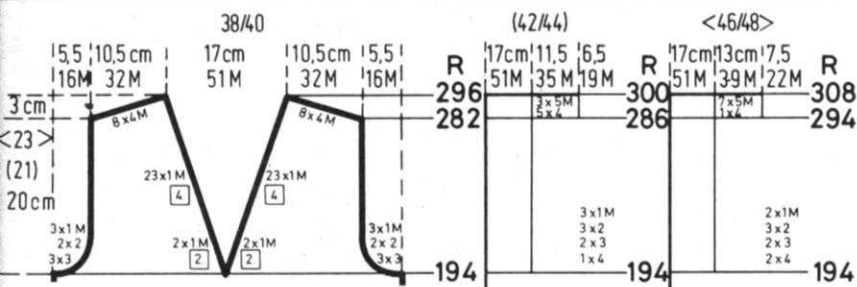

**PULLOVER FRONT:**

Work the front section the same as the back to Row 194. Hang the center st. onto the adjacent needle to the left.

\* SHAPE NECK and ARMHOLE at the same time.

ON NECK SIDE decrease 1 st. every 2nd row 2x, every 4th row 23x.

ON ARMHOLE SIDE, bind off

3 sts. 3x, 2 sts. 2x, 1 st. 3x

(4 sts. 1x, 3 sts. 2x, 2 sts. 3x, 1 st. 3x)

[4 sts. 2x, 3 sts. 2x, 2 sts. 3x, 1 st. 2x]

SHAPE SHOULDER after Row 282

(286) [294]

Bind off

4 sts. 8x

(4 sts. 5x, 5 sts. 3x)

[4 sts. 1x, 5 sts. 7x]

Bring the needles on the left into working position, knit 1 row to the left side, turn the Row Counter back to 194 and complete the left half.

Follow the instructions from \*.

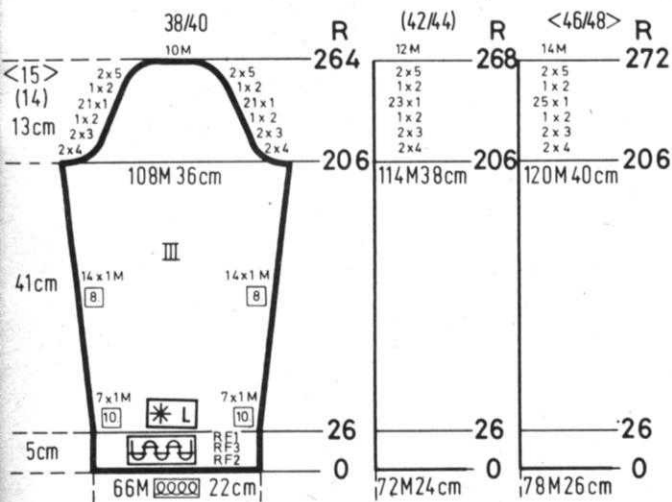

**SLEEVE: III**

Cast on 66 (72) [78] sts. with color 2 and work K1, P1 Ribbing with color changes as marked on the Chart to Row 26.

Change to Pattern as marked on the Line Drawing and continue with color 1.

ON EACH SIDE, increase 1 st. every 10th row 7x, every 8th row 14x.

After Row 206, SHAPE CAP:

ON EACH SIDE, bind off

4 sts. 2x, 3 sts. 2x, 2 sts. 1x, 1 st. 21x,

2 sts. 1x, 5 sts. 2x

(4 sts. 2x, 3 sts. 2x, sts. 1x, 1 st. 23x,

2 sts. 1x, 5 sts. 2x)

[4 sts. 2x, 3 sts. 2x, 2 sts. 1x, 1 st. 25x,

2 sts. 1x, 5 sts. 2x]

After Row 264 (268) [272] bind off the remaining 10 (12) [14] sts.

**HP 53**

**MAN'S JACKET**

SIZE: 36/38 (40/42) [44/46]

YARN: Sport Prima

50 gr. balls: 15 (16) [17]

**E** TENSION: 7 to 9

**P** GAUGE:

Stockinette stitch:  
15 sts. 20 rows = 5 cm (2")



15 sts. 24 rows = 5 cm (2")



Stockinette stitch with FISHERMAN'S RIB for bands, pockets, top of sleeves and shoulders. When working Fisherman's Rib, put the Gate Cam Release Lever of the KNITTER to the needle heels. Worn on the knit side.

FINISHING: See General Instructions.

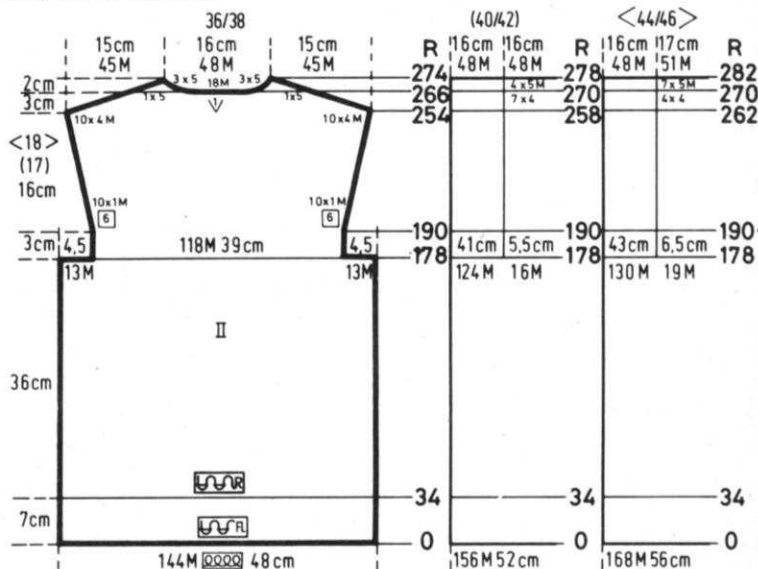

**BACK: II**

Cast on 144 (156) [168] sts. and work Fisherman's Rib to Row 34. Change to Stockinette stitch and knit to Row 178.

SHAPE ARMHOLE:

ON EACH SIDE bind off

13 (16) [19] sts. then ON EACH SIDE, increase 1 st. every 6th row 10x.

Knit to Row 254 (258) [262]

BEGIN THE SHOULDER SHAPING ON EACH SIDE, and after ROW 266 (270) [270].

**SHAPE NECK:**

Bind off the center 18 sts. put the needles on the left into holding position and complete the right half first.

BIND OFF

FOR SHOULDER

4 sts. 10x, 5 sts. 1x

(4 sts. 7x, 5 sts. 4x)

[4 sts. 4x, 5 sts. 7x]

**FOR NECK**

5 sts. 3x

(Same as above)

[Same as above]

Move the Cam Box to the left side, turn the Row Counter back to 266 (270) [270] and complete the shoulder and neck shaping.

# HP 53

## FRONT: I

Do NOT make Buttonholes in this section. Cast on 90 (96) [102] sts. Work in Fisherman's Rib with 24 sts. on the left side (right for second section) in Stockinette stitch. Knit to Row 34, then change to Stockinette stitch. Knit to Row 178.

### SHAPE ARMHOLE:

Bind off 13 (16) [19] sts. then ON ARM SIDE, increase 1 st. every 6th row 10x and AFTER ROW 233 bind off 24 sts. for neck then on NECK SIDE bind off 3 sts.

3x, 2 sts. 3x, 1 st. 3x and SHAPE SHOULDER after Row 254. Bind off

4 sts. 10x, 5 sts. 1x

(4 sts. 7x, 5 sts. 4x)

[4 sts. 4x, 5 sts. 7x]

Work the LEFT FRONT SECTION with reverse shaping and work the first BUTTONHOLE after Row 14 over needles 3 to 7 and 18 to 22 counting from the RIGHT EDGE. Make the following Buttonholes over the same needles after Rows as shown on the Chart.

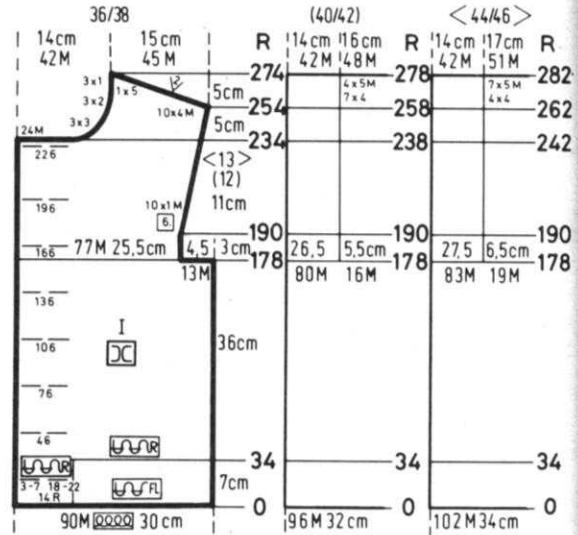

## SLEEVE: III

Cast on 66 (72) [78] sts. and work 34 rows Fisherman's Rib. Change to Stockinette stitch and ON EACH SIDE, increase 1 st. every 8th row 3x, every 6th row 21x.

After Row 182, work Short Rows ON OPPOSITE SIDE OF CAM BOX, put into holding position 4 sts. 6x, 3 sts. 6x ON EACH SIDE. ON OPPOSITE SIDE OF CAM BOX, bring all the needles back into working position before knitting the next 2 rows.

Change to FISHERMAN'S RIB and knit to Row 234, then bind off.

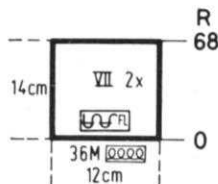
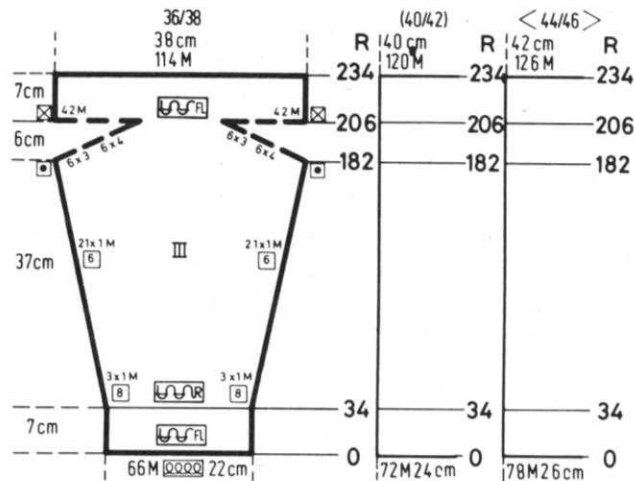

## POCKET: VII

Make 2  
Cast on 36 sts. and work 68 Rows FISHERMAN'S RIB, then bind off.

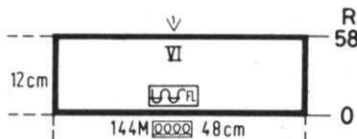

## COLLAR: VI

Cast on 144 sts. and work 58 Rows FISHERMAN'S RIB, then bind off.

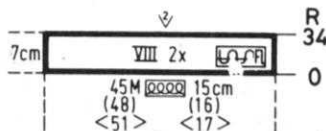

## SHOULDER BAND: VIII

Make 2  
Cast on 45 (48) [51] sts. and work 34 rows FISHERMAN'S RIB, then bind off.



# KK 54

## CHILD'S PULLOVER

SIZE: 6 (8) [10]

CARN: Color 1 – Alanda Tweed  
Color 2 – Alanda

0 gr. balls: C1 4 (5) [6]  
C2 1 (1) [1]

TENSION: 8 to 10

GAUGE:

Ribbing Pattern:

15 sts. 22 rows = 5 cm (2") 

15 sts. 26 rows = 5 cm (2") 

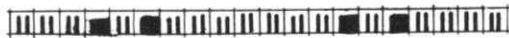
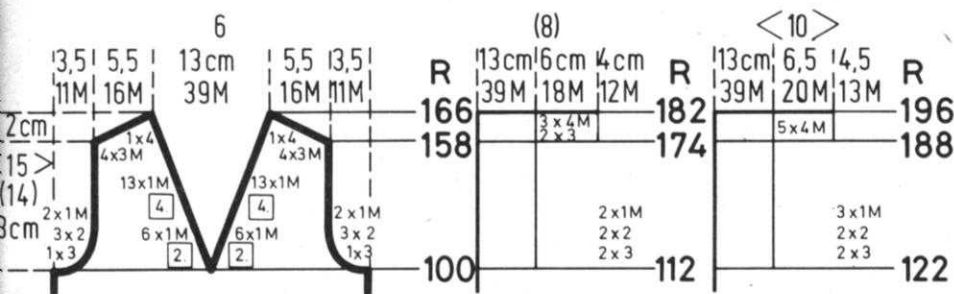
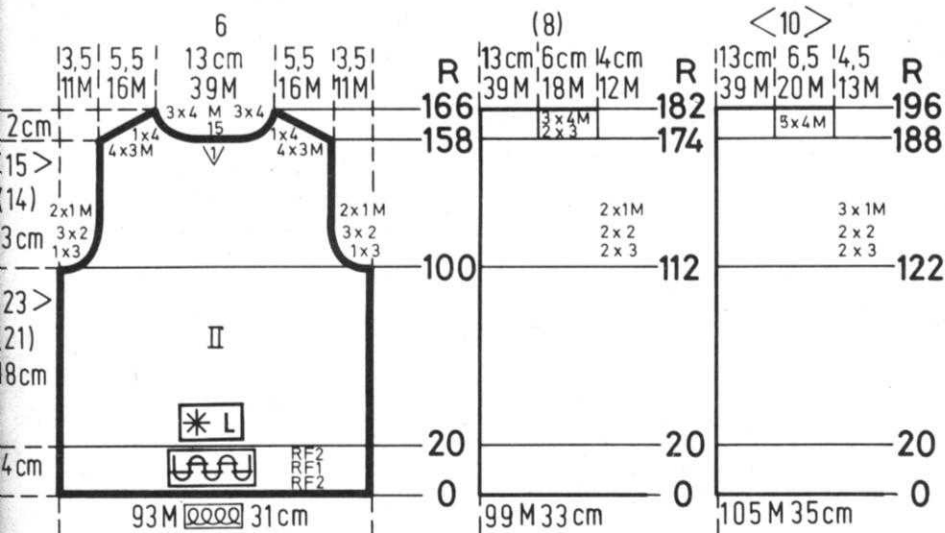

Ribbing Pattern according to the Line Drawing. The Purl side of knitting is the right side. Bands are 1 x 1 Rib with stripes of color as shown on the Chart.

FINISHING: See General Instructions.

### BACK: II

Cast on 93 (99) [105] st. with color 2 and work K1, P1 Ribbing with color stripes as shown on the Chart.

After Row 20, change to Pattern and knit to Row 100 (112) [122].

#### SHAPE ARMHOLE:

ON EACH SIDE, bind off

3 sts. 1x, 2 sts. 3x, 1 st. 2x

(3 sts. 2x, 2 sts. 2x, 1 st. 2x)

[3 sts. 2x, 2 sts. 2x, 1 st. 3x]

Knit to Row 158 (174) [188] bind off the

left side into holding position and complete the right half first.

\* SHAPE SHOULDER and NECK at the SAME TIME

Bind off

#### FOR SHOULDER

3 sts. 4x, 4 sts. 1x

(3 sts. 2x, 4 sts. 3x)

[4 sts. 5x]

#### FOR NECK

4 sts. 3x

(Same as above)

[Same as above]

Bring the needles on the left into working position, knit 1 row in Pattern to the left side, turn the Row Counter back to 158 (174) [188] and complete the right half. Follow the instructions from \*.

### FRONT: I

Work the front the same as the back to Row 100 (112) [122]. Hang the center st. onto the adjacent needle then put the needles on the left side into holding position and complete the right half first.

\* SHAPE ARMHOLE AND NECK AT THE SAME TIME

Bind off

#### FOR ARMHOLE

3 sts. 1x, 2 sts. 3x, 1 st. 2x

(3 sts. 2x, 2 sts. 2x, 1 st. 2x)

[3 sts. 2x, 2 sts. 2x, 1 st. 3x]

Decrease

#### FOR NECK

1 st. every 2nd row 6x, every 4th row 13x

(Same as above)

[Same as above]

#### SHAPE SHOULDER after Row 158

(172) [188]. Bind off

3 sts. 4x, 4 sts. 1x

(3 sts. 2x, 4 sts. 3x)

[4 sts. 5x]

Bring the needles on the left into working position, knit 1 row in Pattern to the left side, turn the Row Counter back to 100 (112) [122] and complete the left half. Follow the instructions from \*.

# KK 54

## SLEEVE: III

Cast on 51 (54) [57] sts. with color 2 and work K1, P1 Ribbing with color stripes as shown on the Chart to Row 20.

Change to Pattern and ON EACH SIDE increase 1 st. Every 12th row 4x, every 10th row 6x. Knit to Row 126 (140) [154].

### SHAPE CAP:

ON EACH SIDE bind off

3 sts. 3x, 2 sts. 1x, 1 st. 11x, 2 sts. 1x, 3 sts. 2x

(3 sts. 3x, 2 sts. 1x, 1 st. 13x, 2 sts. 1x, 3 sts. 2x)

[3 sts. 2x, 2 sts. 2x, 1 st. 15x, 2 sts. 1x, 3 sts. 2x]

After Row 162 (180) [198], bind off the remaining 11 (10) [11] sts.

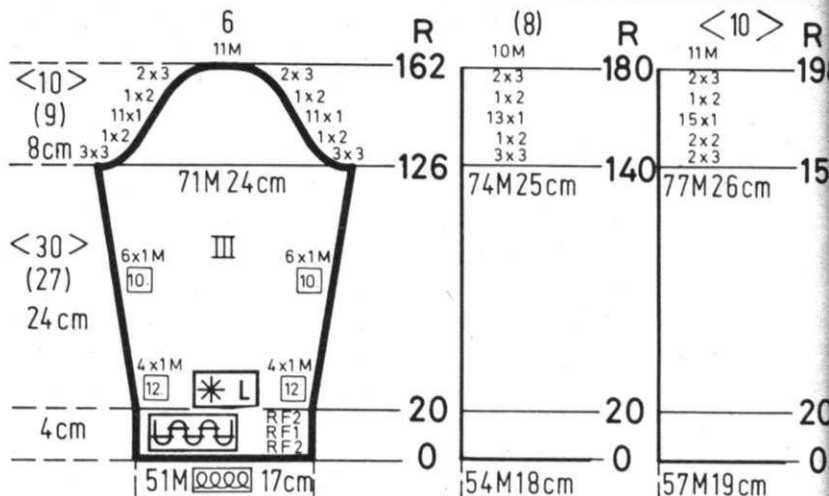

## NECKBAND: VIII

Make 1, reverse 1

Cast on 66 (69) [72] sts. and work K1, P1 Ribbing.

ON EVERY 2nd row ON THE LEFT EDGE (RIGHT FOR SECOND section) decrease 2 sts. 6x. After Row 14, bind off.

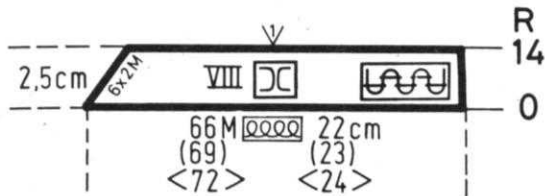

# KK 55

## CHILD'S VEST AND PANTS

SIZE: 6 (8) [10]

YARN: Subita Crepe - 4 colors

50 gr. balls: C1 7 (8) [9]  
C2 1 (1) [1]  
C3 1 (1) [1]  
C4 1 (1) [1]

**E** TENSION: 8 to 10

**P** GAUGE:

Pattern:

14 sts. 30 rows = 5 cm (2")

14 sts. 24 rows = 5 cm (2")

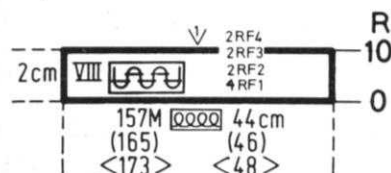
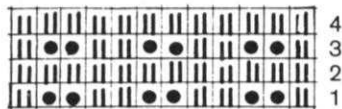

## ARMBANDS: VIII

Make 2

Cast on 122 (130) [138] sts. with color 1 and work 10 Rows K1, P1 Ribbing with color stripes as shown on the Chart. Bind off.

Holding Position Design using Wheel No. 3. K1, P1 Ribbing for bands. Follow the Line Drawing and the Chart for color changes. The Purl side is the right side.

FINISHING: See General Instructions

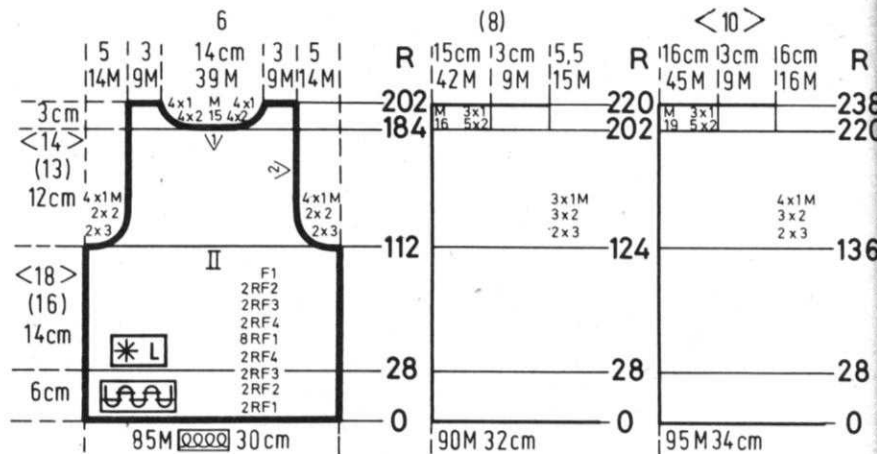

## VEST BACK: II

Cast on 85 (90) [95] sts. with color 1 and work K1, P1 Ribbing with color stripes as marked on the Chart.

After Row 28, change to Pattern and knit to Row 112 (124) [136].

### SHAPE ARMHOLE:

ON EACH SIDE, bind off

3 sts. 2x, 2 sts. 2x, 1 st. 4x

(3 sts. 2x, 2 sts. 3x, 1 st. 3x)

[3 sts. 2x, 2 sts. 3x, 1 st. 4x]

Knit to Row 184 (202) [220], bind off the

center 15 sts., put the needles on the left side into holding position and complete the right half first.

\* ON NECK SIDE, bind off 2 sts. 4x, 1 st. 4x.

After Row 202 (220) [238], bind off the remaining 9 sts.

Bring the needles on the left side into working position, knit 1 row in Pattern to the left, turn the Row Counter back to 184 (202) [220] and complete the left half. Follow the instructions from \*.

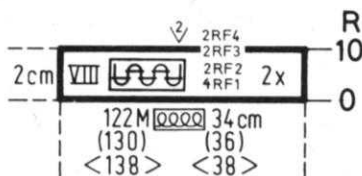

## NECKBAND: VIII

Cast on 157 (165) [173] st, with color 1 and work 10 Rows K1, P1 Ribbing with color stripes as shown on the Chart. Bind off.



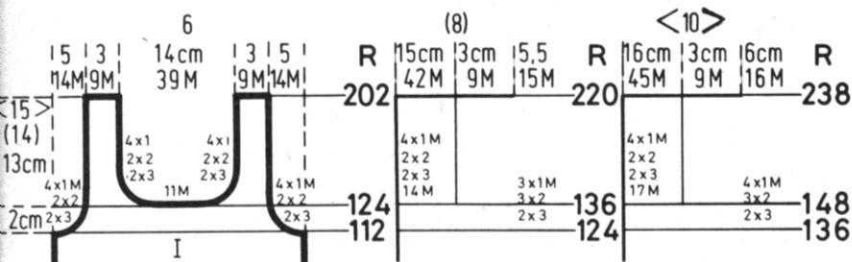

### VEST FRONT: II

Work the front the same as the back to Row 112 (124) [136]

#### SHAPE ARMHOLE:

ON EACH SIDE, bind off  
3 sts. 2x, 2 sts. 2x, 1 st. 4x  
(3 sts. 2x, 2 sts. 3x, 1 st. 3x)  
[3 sts. 2x, 2 sts. 3x, 1 st. 4x]

#### SHAPE NECK AFTER ROW 124 (136)

[148]. Bind off the center 11 (14) [17] sts.  
put the needles on the left side into  
holding position and complete the right  
half first.

\* ON NECK SIDE bind off

3 sts. 2x, 2 sts. 2x, 1 st. 4x

Knit to Row 202 (220) [238] then bind off  
the remaining 9 sts.

Bring the needles on the left into working  
position, knit 1 row in Pattern to the left  
side, turn the Row Counter back to 124  
(136) [148] and complete the right half.  
Follow the instructions from \*.

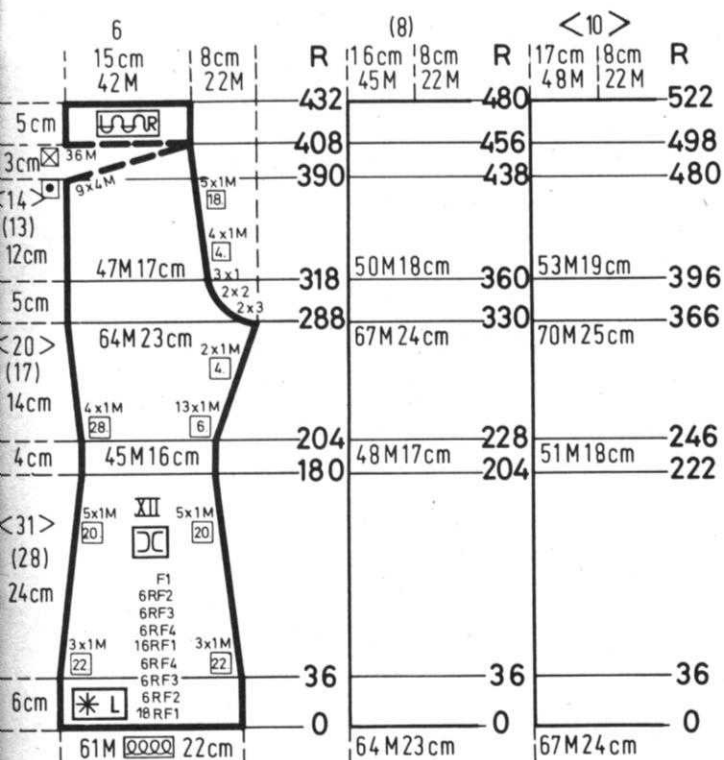

### PANTS BACK: XII

Make 1, reverse 1

Cast on 61 (64) [67] sts. with color 1 and  
work in Pattern with color stripes as  
marked on the Chart.

After Row 36, ON EACH SIDE, decrease  
1 st. every 22nd row 3x, every 20th row 5x.  
After Row 180 (204) [222] SHAPE SIDE  
EDGE AND CENTER BACK INCREASE  
1 st. on

#### SIDE EDGE

every 28th row 4x

After Row 288 (330) [366] SHAPE CROTCH  
CENTER BACK

Every 6th row 13x, every 4th row 2x

Bind off 3 sts. 2x, 2 st. 2x, 1 st. 3x then  
every 4th row 1 st. 4x, every 18th row  
1 st. 5x.

AFTER Row 390 (438) [480] Change to  
Stockinette stitch and work Short Rows.  
ON OPPOSITE SIDE OF CAM BOX put  
into holding position 4 st. 9x.

Bring all the needles back into working  
position before knitting the next row.

Knit to Row 432 (480) [522] then bind off.

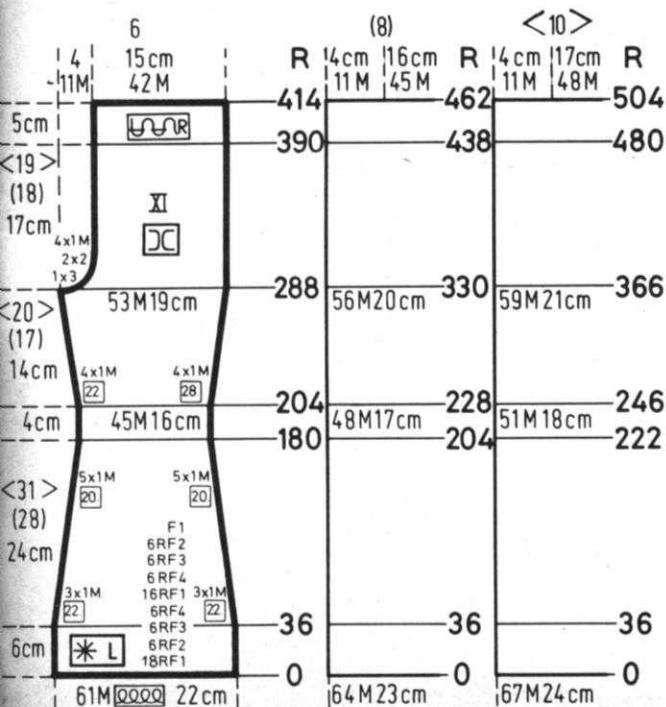

### PANTS FRONT: XI

Make 1, reverse 1

Work the front the same as the back to  
Row 204 (228) [246]

#### SHAPE CENTER FRONT AND SIDE EDGE:

Increase 1 st. on

CENTER FRONT

every 22nd row 4x

SIDE EDGE

every 28th row 4x

After Row 288 (330) [366]. Bind off for  
Crotch

3 sts. 1x, 2 sts. 2x, 1 st. 4x

Knit to Row 390 (438) [480] then change to  
Stockinette stitch and knit to Row 414  
(462) [504]. Bind off.

# KK 56

## CHILD'S PULLOVER

SIZE: 10 (12) [14]

YARN: Subita Crepe - 2 colors

50 gr. balls: C1 2 (3) [4]  
C2 1 (2) [3]

**E** TENSION: 8 to 10

**P** GAUGE:

Pattern:  
13 sts. 28 rows = 5 cm (2")

13 sts. 24 rows = 5 cm (2")

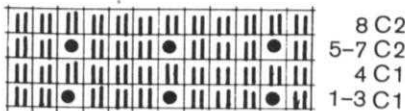

Holding Position Design using Wheel No. 3 with color stripes as shown on the chart. Follow the Line Drawing. Bands are a 1 x 1 Rib. Worn on the knit side.

FINISHING: See General Instructions

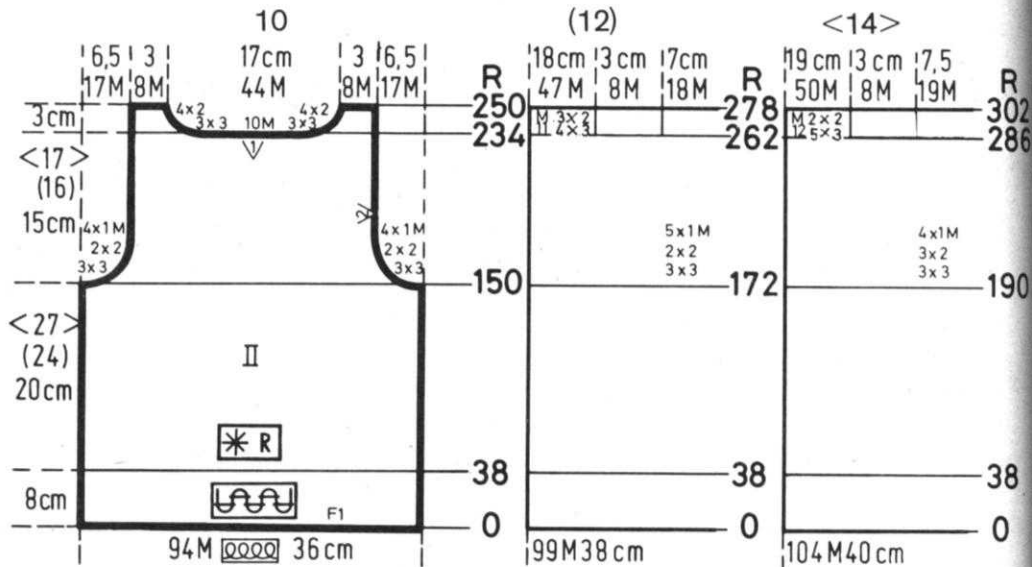

### BACK: II

Cast on 94 (99) [104] sts. with color 1 and work 38 rows K1, P1 Ribbing. Change to Pattern and knit to Row 150 (172) [190].  
SHAPE ARMHOLE:  
ON EACH SIDE, bind off  
3 sts. 3x, 2 sts. 2x, 1 st. 4x  
(3 sts. 3x, 2 sts. 2x, 1 st. 5x)  
(3 sts. 3x, 2 sts. 3x, 1 st. 4x)  
Knit to Row 234 (262) [286]. Bind off the center 10 sts., put the needles on the left side into holding position and complete

the right half first.  
\* ON NECK SIDE, bind off  
3 sts. 3x, 2 sts. 4x  
(3 sts. 4x, 2 sts. 3x)  
(3 sts. 5x, 2 sts. 2x)  
Bind off the remain 8 sts.  
Bring the needles on the left into working position, knit 1 row in Pattern to the left side, turn the Row Counter back to 234 (262) [286] and complete the left half. Follow the instructions from \*.

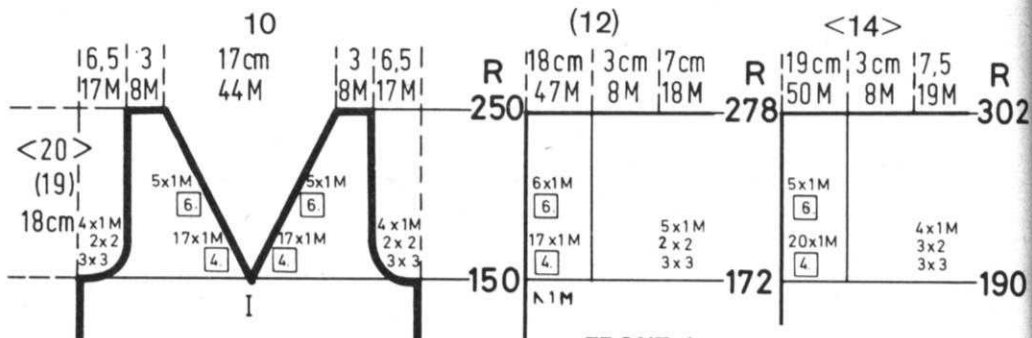

### FRONT: I

Work the front the same as the back to Row 150 (172) [190], then divide in the center and put the needles on the left into holding position and complete the right half first.

\* Bind off  
FOR ARMHOLE  
3 sts. 3x, 2 sts. 2x, 1 st. 4x  
(3 sts. 3x, 2 sts. 2x, 1 st. 5x)  
(3 sts. 3x, 2 sts. 3x, 1 st. 4x)  
Decrease 1 st.

FOR NECK  
every 4th row 17x, every 6th row 5x  
(every 4th row 17x, every 6th row 6x)  
(every 4th row 20x, every 6th row 5x)  
After Row 250 (278) [302], bind off the remaining 8 sts.  
Bring the needles on the left into working position, knit 1 row in Pattern to the left side, turn the Row Counter back to 150 (172) [190] and complete the left half. Follow the instructions from \*.

### NECKBAND: VII

Cast on 160 (166) [172] sts. with color 1 and work 12 rows K1, P1 Ribbing then bind off.

### ARMHOLE BANDS: VIII

Make 2  
Cast on 134 (140) [146] sts. with color 1 and work 12 rows K1, P1 Ribbing then bind off.

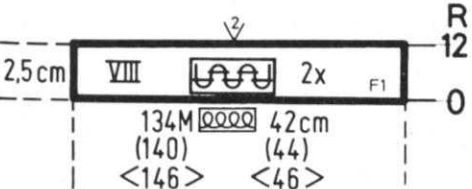
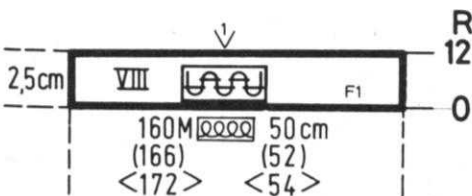



# KK 57

## GIRL'S SKIRT AND PULLOVER

SIZE: 8 (10) [12]

YARN: Subita Crepe - 3 colors

50 gr. balls: C1 6 (7) [8]  
 C2 1 (1) [1]  
 C3 1 (1) [1]

**E** TENSION: 8 to 10

**P** GAUGE:

Stock:  
 15 sts. 20 rows = 5 cm (2")

Pattern:  
 13 sts. 26 rows = 5 cm (2")

15 sts. 24 rows = 5 cm (2")

24 C2
21-23 C2
20 C3
17-19 C3
16 C1
13-15 C1
12 C2
9-11 C2
8 C3
5-7 C3
4 C1
1-3 C1

### PULLOVER FRONT: I

Work the front the same as the back to Row 92 (100) [116].

SHAPE RAGLAN:

ON EACH SIDE, decrease 1 st.

every 2nd row 24x, every 4th row 3x

(every 2nd row 28x, every 4th row 2x)

[every 2nd row 32x, every 4th row 1x]

After Row 132 (144) [164], bind off the

center 12 sts., put the needles on the left into holding position and complete the right half first.

\* ON NECK SIDE, bind off

2 sts. 3x, 1 st. 6x

Move the Cam Box to the left side, turn the Row Counter back to 132 (144) [164] and complete the left half.

Follow the instructions from \*.

### SLEEVE: III

Make 1, reverse 1

Cast on 51 (53) [57] sts. with color 1 and work 24 rows K1, P1 Ribbing. Change to Stockinette stitch. ON EACH SIDE

increase 1 st. every 10th Row 11x. Knit to Row 132 (148) [164].

SHAPE RAGLAN:

Decrease 1 st.

ON FRONT SIDE

every 2nd row 26x, every 4th row 2x

(every 2nd row 26x, every 4th row 3x)

[every 2nd row 29x, every 4th row 2x]

ON BACK SIDE

every 2nd row 26x, every 4th row 4x

(every 2nd row 26x, every 4th row 5x)

[every 2nd row 29x, every 4th row 4x]

After Row 192 (212) [232] Work

Short Rows.

ON OPPOSITE SIDE OF CAM BOX, put into holding position 3 sts. 5x. Bring all the needles back into working position then bind off.

Stockinette stitch with Ribbed bands for the Pullover. The Skirt is a Holding Position Design using Wheel No. 3. Follow the Line Drawing. Worn on the knit side.

FINISHING: See General Instructions. Work 2 rows single crochet around lower edge of Skirt then turn to the wrong side and hem.

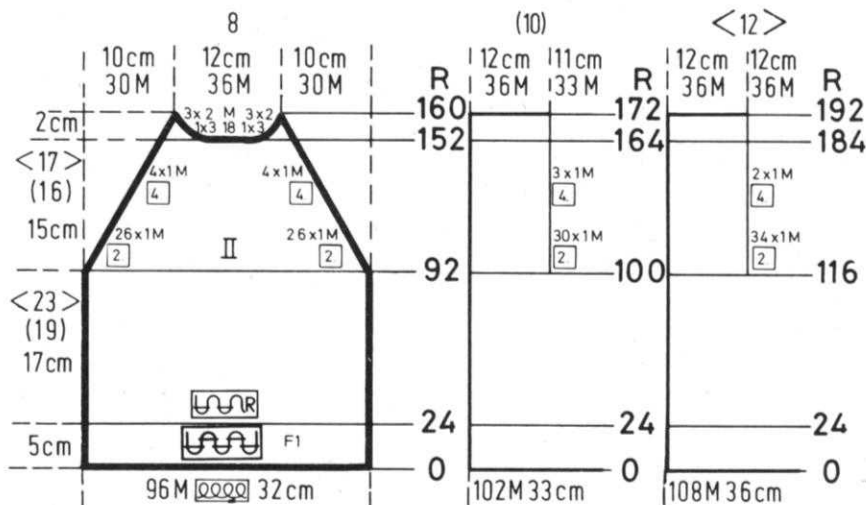

### PULLOVER BACK: II

Cast on 96 (102) [108] sts. with color 1 and work 24 rows K1, P1 Ribbing then change to Stockinette stitch and knit to Row 92 (100) [116].

#### SHAPE RAGLAN:

ON EACH SIDE, decrease 1 st. every 2nd row 26x, every 4th row 4x (every 2nd row 30x, every 4th row 3x) [every 2nd row 34x, every 4th row 2x] After Row 152 (164) [184] bind off the

center 18 sts., put the needles on the left into holding position and complete the right half first.  
 \* ON NECK SIDE, bind off 3 sts. 1x, 2 sts. 3x  
 Move the Cam Box to the left side, turn Row Counter back to 152 (164) [184] and complete the left half.  
 Follow the instructions from \*.

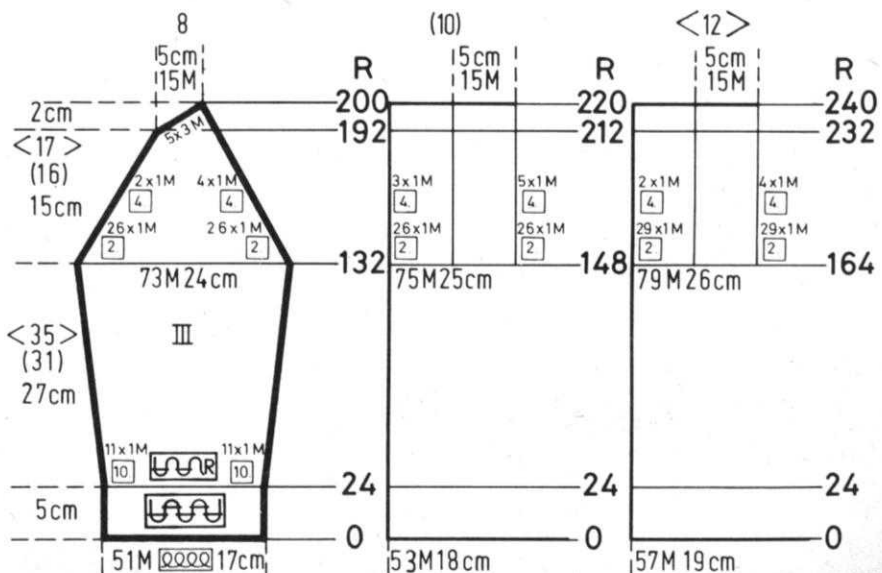
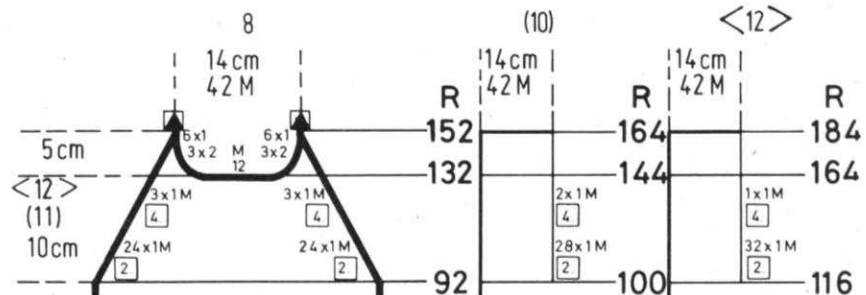

# KK 57

## SKIRT: IV/V

Make 2 sections

Cast on 63 (67) [73] sts. and work in Pattern.

ON EACH SIDE increase 8 sts. every 2nd row 4x ON EACH SIDE.

Knit to Row 52.

ON EACH SIDE decrease 1 st.

every 8th row 6x, every 6th row 7x

(every 10th row 4x, every 8th row 9x)

[every 11th row 2x, every 10th row 11x]

Knit to Row 136 (156) [176] then remove

the stitches onto a stitch holder and

hang them back onto the machine

decreasing to 79 (83) [89] sts.

Change to Stockinette stitch and knit

to Row 156 (176) [196]. Bind off.

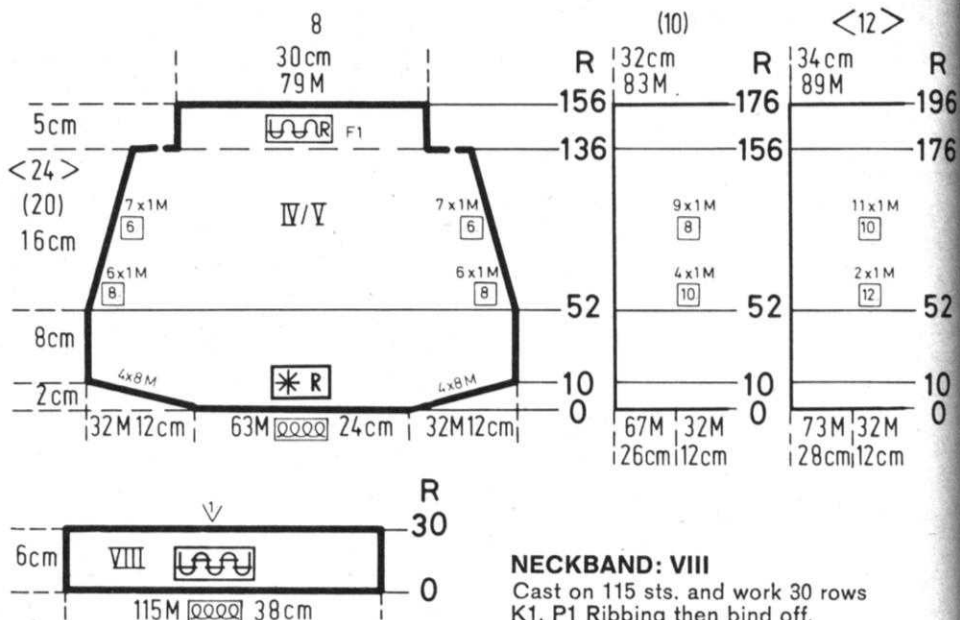

# KK 58

## CHILD'S PULLOVER

SIZE: 8 (10) [12]

YARN: Amore

50 gr. balls: 5 (6) [7]

**E** TENSION: 7 to 9

**P** GAUGE:

15 sts. 20 rows = 5 cm (2")

15 sts. 24 rows = 5 cm (2")

Stockinette stitch with a Cable Design down the front section. The bands are ribbed. Follow the Line Drawing for the Cable Design. Worn on the knit side.

FINISHING: See General Instructions.

## BACK: II

Cast on 95 (101) [107] sts. and work

34 rows KI, PI Ribbing. Change to

Stockinette stitch and knit to Row

94 (102) [114]

SHAPE RAGLAN: ON EACH SIDE

decrease 1 st.

every 2nd row 23, every 4th row 4x

(every 2nd row 27x, every 4th row 3x)

[every 2nd row 31x, every 4th row 2x]

After Row 150 (162) [178] bind off the

center 17 sts. put the needles on the

left into holding position and complete

the right half first.

\* ON NECK SIDE, bind off 3 sts. 4x.

Move the Cam Box to the left side,

turn the Rock Counter back to 150

(162) [178] and complete the left half.

Follow the instructions from \*.

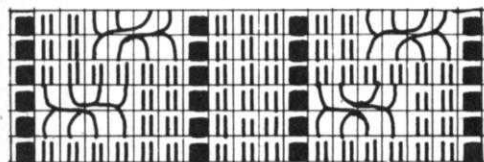
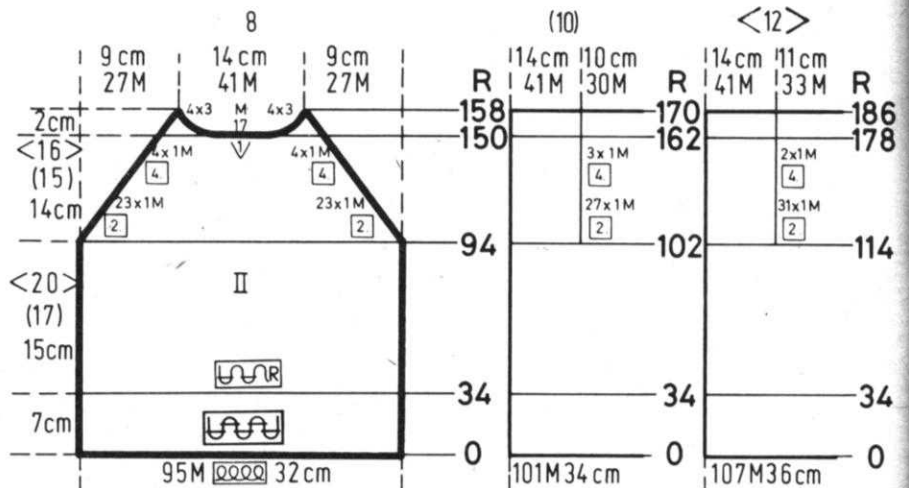

1-2  
5-6  
3-4  
1-2  
3-4  
1-2



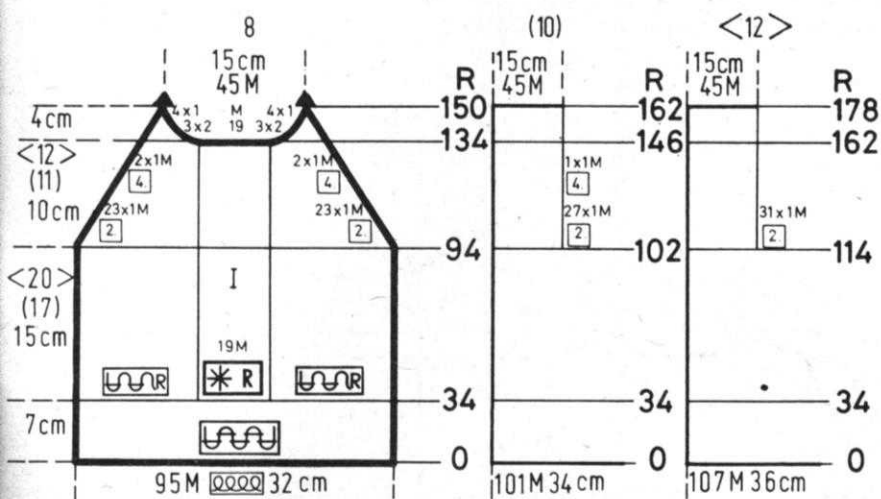

**FRONT: I**

Cast on 95 (101) [107] sts. and work 34 Rows KI, PI Ribbing. Change to Stockinette stitch with Cable Design as shown on the Chart over the center 19 sts.  
 Knit to Row 94 (102) [114]  
 SHAPE RAGLAN: ON EACH SIDE decrease 1 st. every 2nd row 23x, every 4th row 2x (every 2nd row 27x, every 4th row 1x) [every 2nd row 31x]  
 After Row 134 (146) [162] bind off the center 19 sts., put the needles on the left side into holding position and complete the right half first.  
 \* ON NECK SIDE bind off 2 sts. 3x, 1 st. 4x.  
 Move the Cam Box to the left side, turn the Row Counter back to 134 (146) [162] and complete the left half. Follow the instructions from \*.

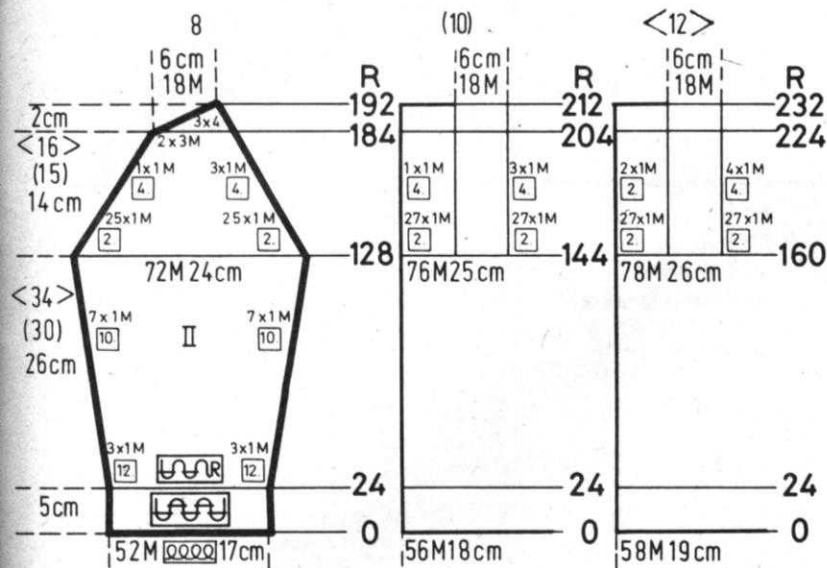

**SLEEVE: II**

Make 1, reverse 1  
 Cast on 52 (56) [58] sts. and work 24 rows KI, PI Ribbing. Change to Stockinette stitch and ON EACH SIDE increase 1 st. every 12th row 3x, every 10th row 7x  
 Knit to Row 128 (144) [160]  
 SHAPE RAGLAN: Decrease 1 st. ON FRONT SIDE:  
 every 2nd row 25x, every 4th row 1x (every 2nd row 27x, every 4th row 3x) [every 2nd row 27x, every 2nd row 2x]  
 After Row 184 (204) [224] work short Rows.  
 ON BACK SIDE  
 every 2nd row 25x, every 4th row 3x (every 2nd row 27x, every 4th row 3x) [every 2nd row 27x, every 4th row 4x]  
 ON OPPOSITE SIDE OF CAM BOX, put into holding position 3 sts. 2x, 4 sts. 3x  
 Bring all the needles back into working position and bind off.

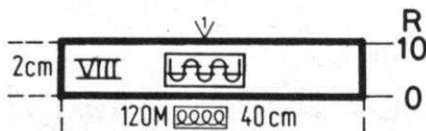

**NECKBAND: VIII**

Cast on 120 sts. and work 10 rows KI, PI Ribbing then bind off.

# KK 59

## GIRL'S CARDIGAN

SIZE: 12 (14) [16]

YARN: Amore

50 gr. balls: 7 (8) [9]

**E** TENSION: 7 to 9

**P** GAUGE:

15 sts. 20 rows = 5 cm (2") 

15 sts. 24 rows = 5 cm (2") 

Stockinette and a Rib stitch with a Cable Design down the front sections. Follow the Line Drawing. The bands are a 1 x 1 rib.

FINISHING: See General Instructions.

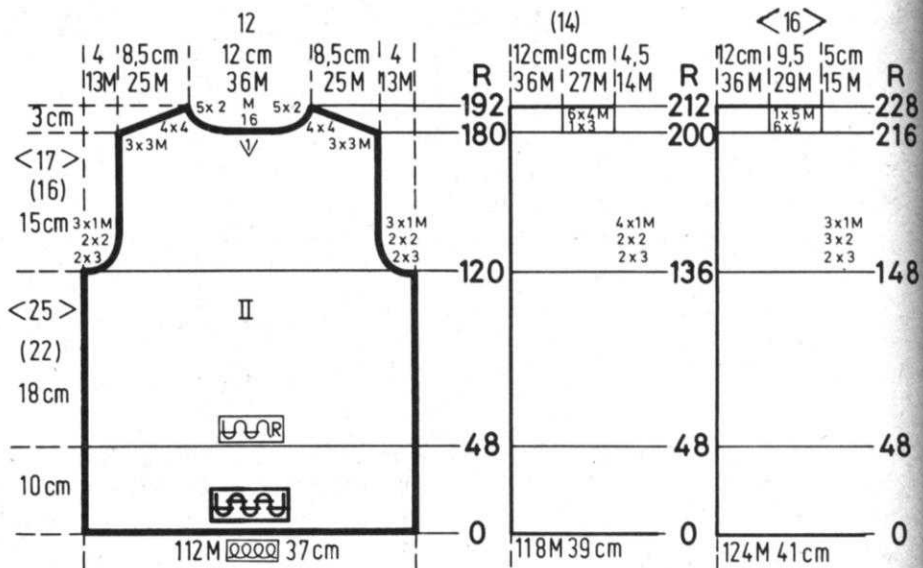

### BACK: II

Cast on 112 (118) [124] sts. and work 48 rows K1, P1 Ribbing. Change to Stockinette stitch and knit to Row 120 (136) [148]

SHAPE ARMHOLE: ON EACH SIDE bind off 3 sts. 2x, 2 sts. 2x, 1 st. 3x

(3 sts. 2x, 2 sts. 2x, 1 st. 4x)

[3 sts. 2x, 2 sts. 3x, 1 st. 3x]

Knit to Row 180 (200) [216], bind off the center 16 sts., put the needles on the left side into holding position and complete the right half first.

\* SHAPE NECK AND SHOULDER

AT THE SAME TIME

Bind off

### FOR SHOULDER

3 sts. 3x, 4 sts. 4x  
(3 sts. 1x, 4 sts. 6x)  
[4 sts. 6x, 5 sts. 1x]

### FOR NECK

2 sts. 5x  
(Same as above)  
[Same as above]

Move the Cam Box to the left side, turn the Row Counter back to 180 (200) [216] and complete the left half. Follow the instructions from \*.

### FRONT: I

Make 1, reverse 1

Cast on 52 (55) [58] sts. and work 48 rows K1, P1 Ribbing. Change to Stockinette stitch with Cable Design as shown on the Chart.

Knit to Row 120 (136) [148]

SHAPE ARMHOLE: Bind off

3 sts. 2x, 2 sts. 2x, 1 st. 3x

(3 sts. 2x, 2 sts. 2x, 1 st. 4x)

[3 sts. 2x, 2 sts. 3x, 1 st. 3x]

Knit to Row 159 (179) [195]

ON NECK SIDE, bind off

3 sts. 2x, 2 sts. 2x, 1 st. 4x AND SHAPE

SHOULDER after Row 180 (200) [216]

bind off 3 sts. 3x, 4 sts. 4x

(3 sts. 1x, 4 sts. 6x)

[4 sts. 6x, 5 sts. 1x]

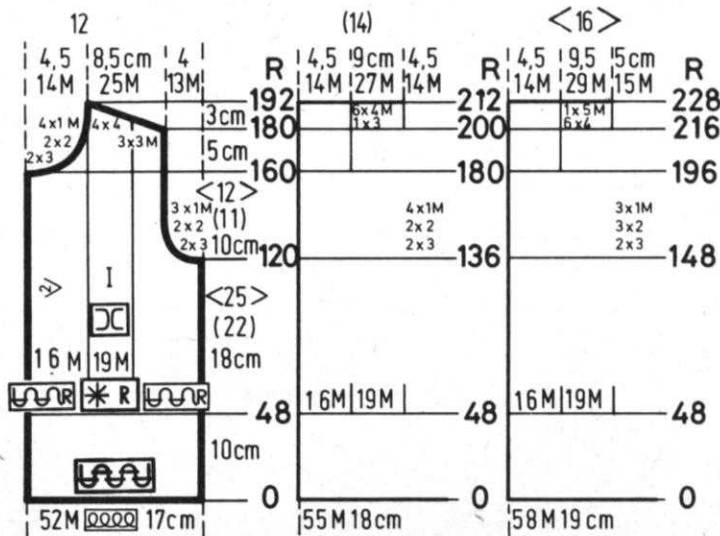



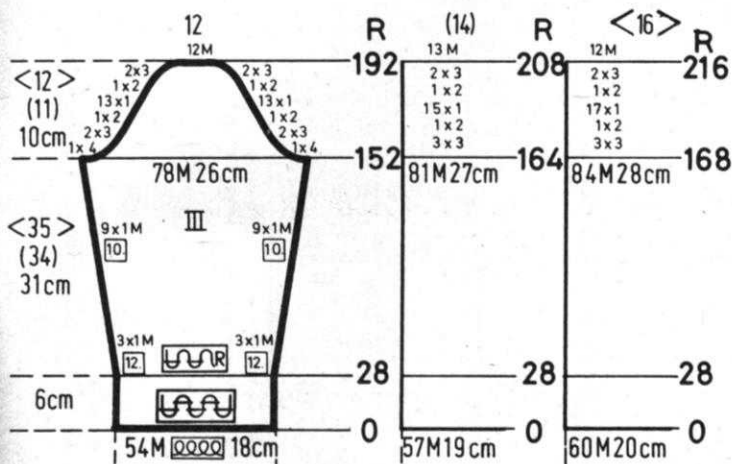

### SLEEVE: III

Cast on 54 (57) [60] sts. and work 28 rows KI, PI Ribbing. Change to Stockinette stitch and ON EACH SIDE increase 1 st. every 12th row 3x, every 10th row 9x. Knit to Row 152 (164) [168] SHAPE CAP: ON EACH SIDE bind off 4 sts. 2x, 3 sts. 2x, 2 sts. 1x, 1 st. 13x, 2 sts. 1x, 3 sts. 2x (3 sts. 3x, 2 sts. 1x, 1 st. 15x, 2 sts. 1x, 3 sts. 2x) [3 sts. 3x, 2 sts. 1x, 1 st. 17x, 2 sts. 1x, 3 sts. 2x] After Row 192 (208) [216], bind off the remaining 12 (13) [12] sts.

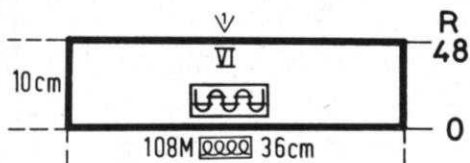

### COLLAR: VI

Cast on 108 sts. and work 48 rows KI, PI Ribbing then bind off.

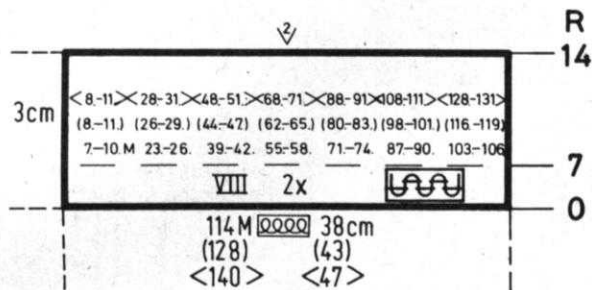

### BUTTONHOLE BAND:

Cast on 114 (128) [140] sts. and work KI, PI Ribbing. After Row 7, make Buttonholes over the needles as specified on CHART for your size. Knit to Row 14 and bind off. Make another band for the Buttons but OMIT THE BUTTONHOLES.

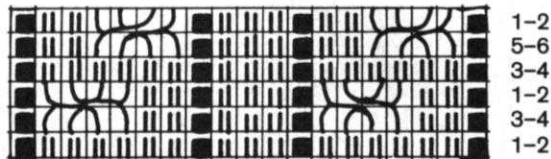

# KK 60

## GIRL'S CARDIGAN

SIZE: 10 (12) [14]

YARN: Beatrice

50 gr. balls: 7 (8) [9]

**E** TENSION: 7 to 9

**P** GAUGE:

Stock:  
16 sts. 22 rows = 5 cm (2")

Pattern:  
17 sts. 27 rows = 5 cm (2")

16 sts. 26 rows = 5 cm (2")

The Ribber is used as well as a Holding Position Design on the main Machine.  
Follow the Line Drawing and use Wheel No. 2. SLEEVES: Stockinette. Bands are Ribbed. The Knit side is the right side.

FINISHING: See General Instructions.

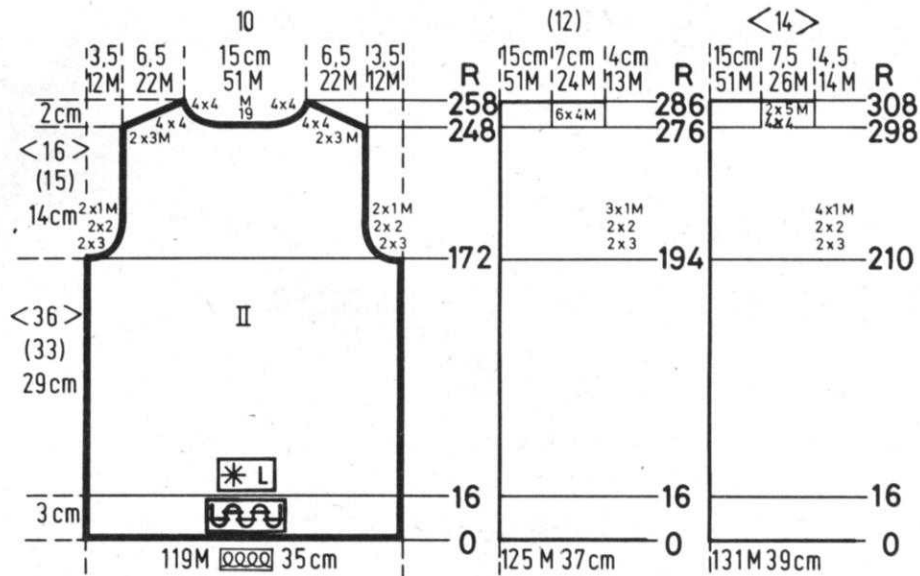

### BACK: II

Cast on 119 (125) [131] sts. and work 16 rows KI, PI Ribbing. Change to Pattern and knit to Row 172 (194) [210].  
SHAPE ARMHOLE: ON EACH SIDE,

bind off  
3 sts. 2x, 2 sts. 2x, 1 st. 2x  
(3 sts. 2x, 2 sts. 2x, 1 st. 3x)  
[3 sts. 2x, 2 sts. 2x, 1 st. 4x]

Knit to Row 248 (276) [298]. Bind off the center 19 sts., put the needles on the left side into holding position and complete the right half first.

\* SHAPE SHOULDER AND NECK AT THE SAME TIME  
Bind off

FOR SHOULDER  
3 sts. 2x, 4 sts. 4x  
(4 sts. 6x)  
[4 sts. 4x, 5 sts. 2x]

FOR NECK  
4 sts. 4x  
(Same as above)  
[Same as above]

Bring the needles on the left into working position, knit 1 row in Pattern to the left side, turn the Row Counter back to 248 (276) [298] and complete the left half. Follow the instructions from \*.

### FRONT: I

Make 1, reverse 1  
Cast on 54 (57) [60] sts. and work 16 rows KI, PI Ribbing. Change to Pattern and knit to Row 172 (194) [210].  
SHAPE ARMHOLE AND NECK AT THE SAME TIME  
ON NECK SIDE decrease 1 st. every 4th row 18x, every 6th row 2x AND AT THE SAME TIME bind off for ARMHOLE

3 sts. 2x, 2 sts. 2x, 1 st. 2x  
(3 sts. 2x, 2 sts. 2x, 1 st. 3x)  
[3 sts. 2x, 2 sts. 2x, 1 st. 4x]  
SHAPE SHOULDER after Row 248 (276)

[298] Bind off  
3 sts. 2x, 4 sts. 4x  
(4 sts. 6x)  
[4 sts. 4x, 5 sts. 2x]

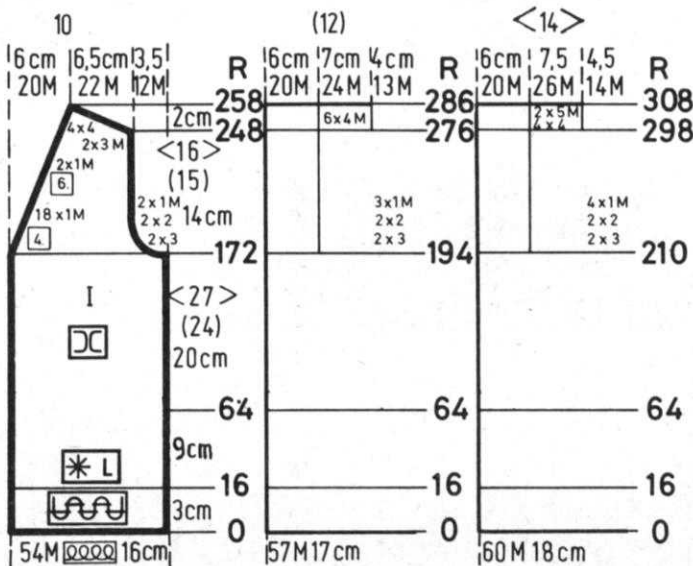



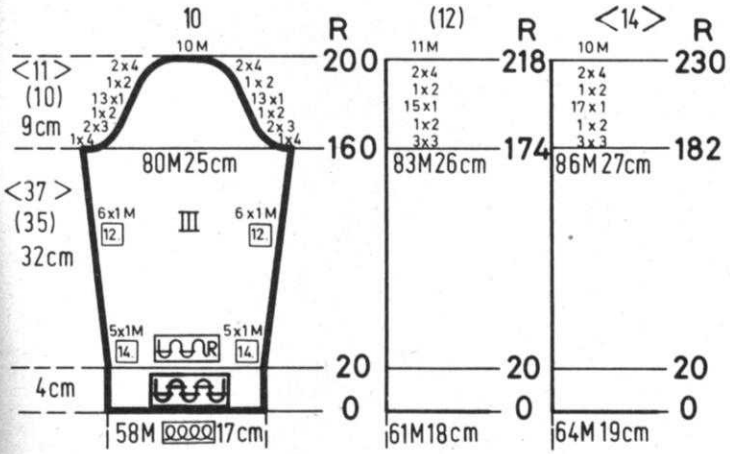

**SLEEVE: III**

Cast on 58 (61) [64] sts. and work 20 rows KI, PI Ribbing. Change to Stockinette stitch and ON EACH SIDE increase 1 st. every 14th row 5x, every 12th row 6x. After Row 160 (174) [182] SHAPE ARMHOLE, bind off 4 sts. 1x, 3 sts. 2x, 1 st. 15x, 2 sts. 1x, 4 sts. 2x (3 sts. 3x, 2 sts. 1x, 1 st. 15x, 2 sts. 1x, 4 sts. 2x) [3 sts. 3x, 2 sts. 1x, 1 st. 17x, 2 sts. 1x, 4 sts. 2x] After Row 200 (218) [230] bind off the remaining 10 (11) [10] sts.

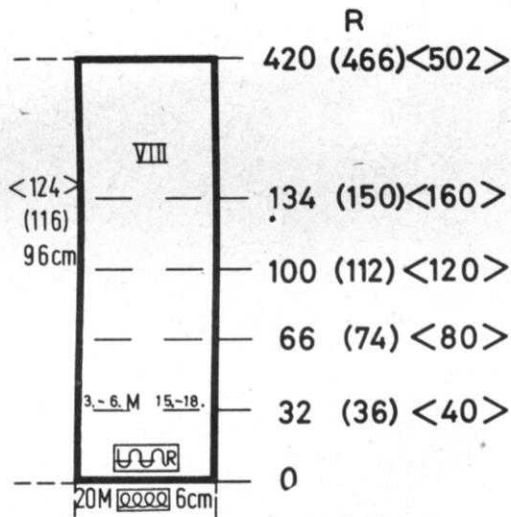
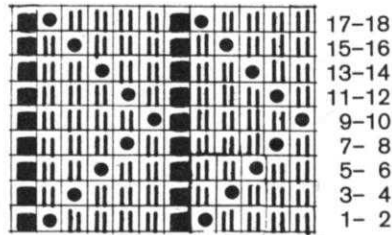

**FRONT AND NECKBAND: VIII**

Cast on 20 sts. and work Stockinette stitch. MAKE BUTTONHOLES over needles 3 to 6 and 15 to 18 (counting from the left edge) after Rows SHOWN ON THE CHART FOR YOUR SIZE. Knit to Row 420 (466) [502] then bind off.

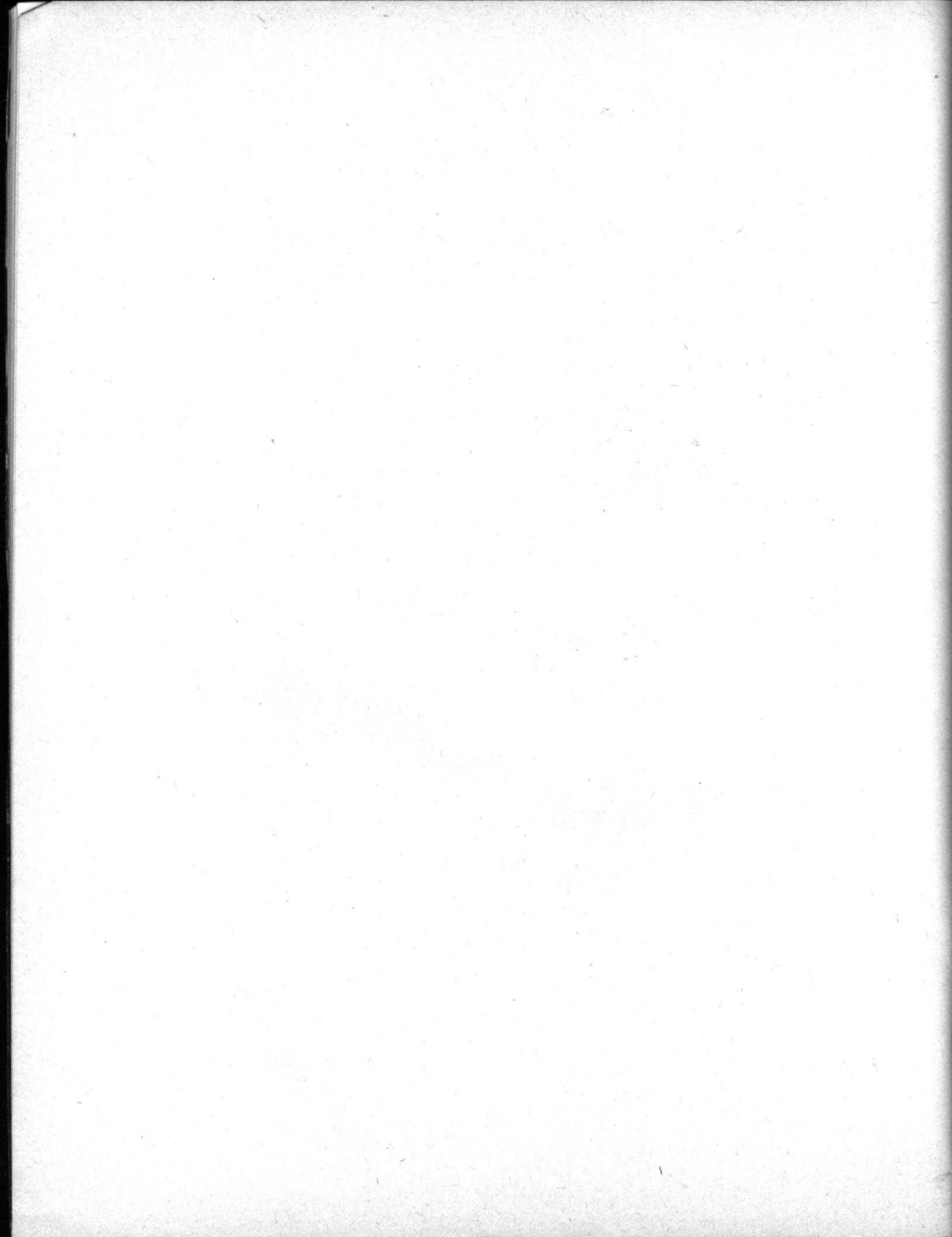





  
DK 31





DK32

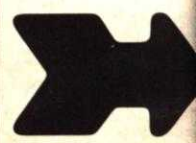

DK38











HP53

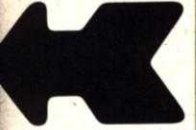

KK56









**KK 60**  
**KK 55**



KK57

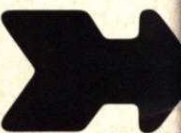

KK58







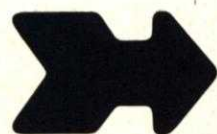
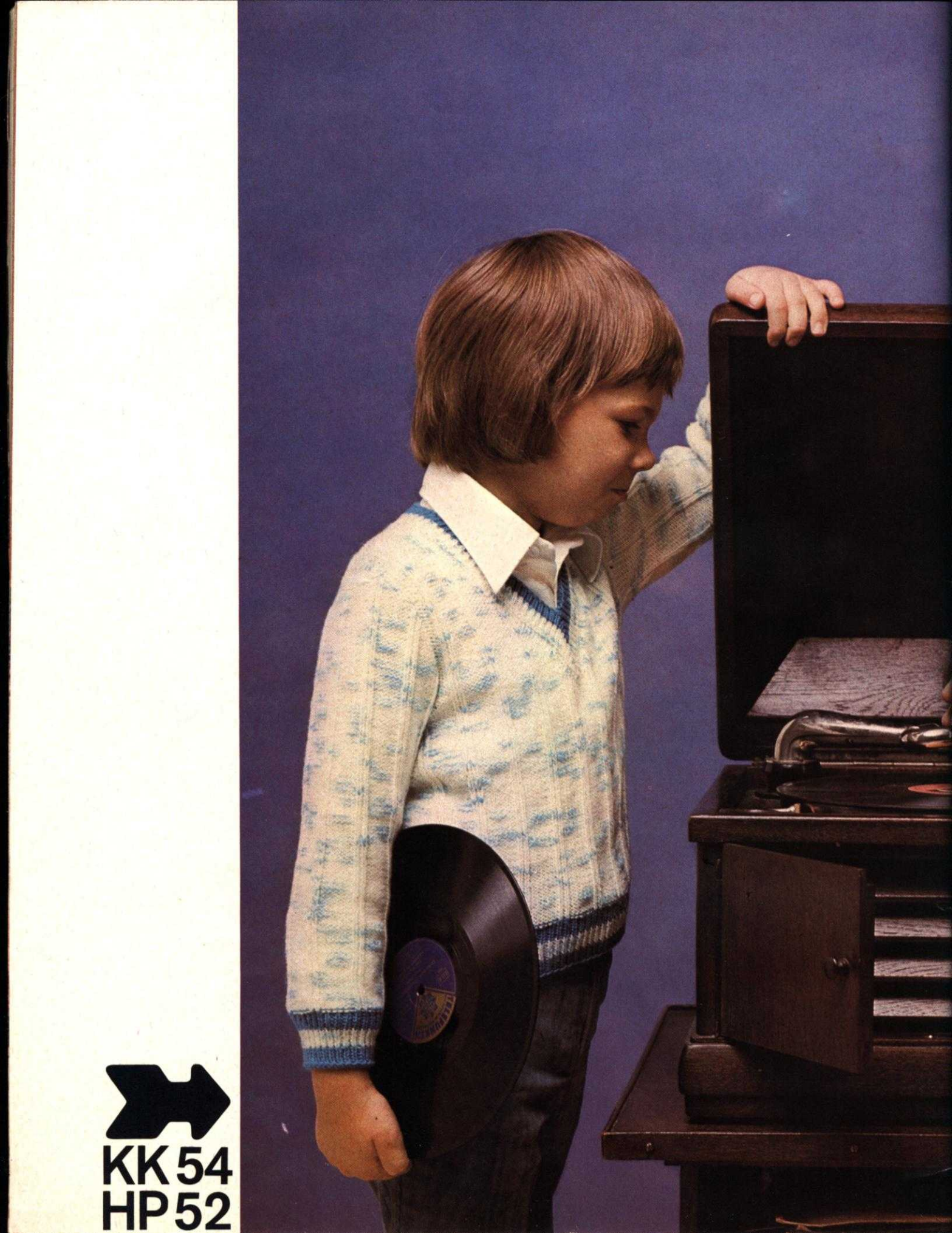

**KK 54**  
**HP 52**







KK59



DK39



HP51







