

11-4
knitking

magazine

may/june '75





DK 64

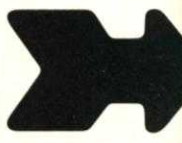

DK 66

Titel

DK 67





DK63



DK70





DK68



DK61





HP76



HP78

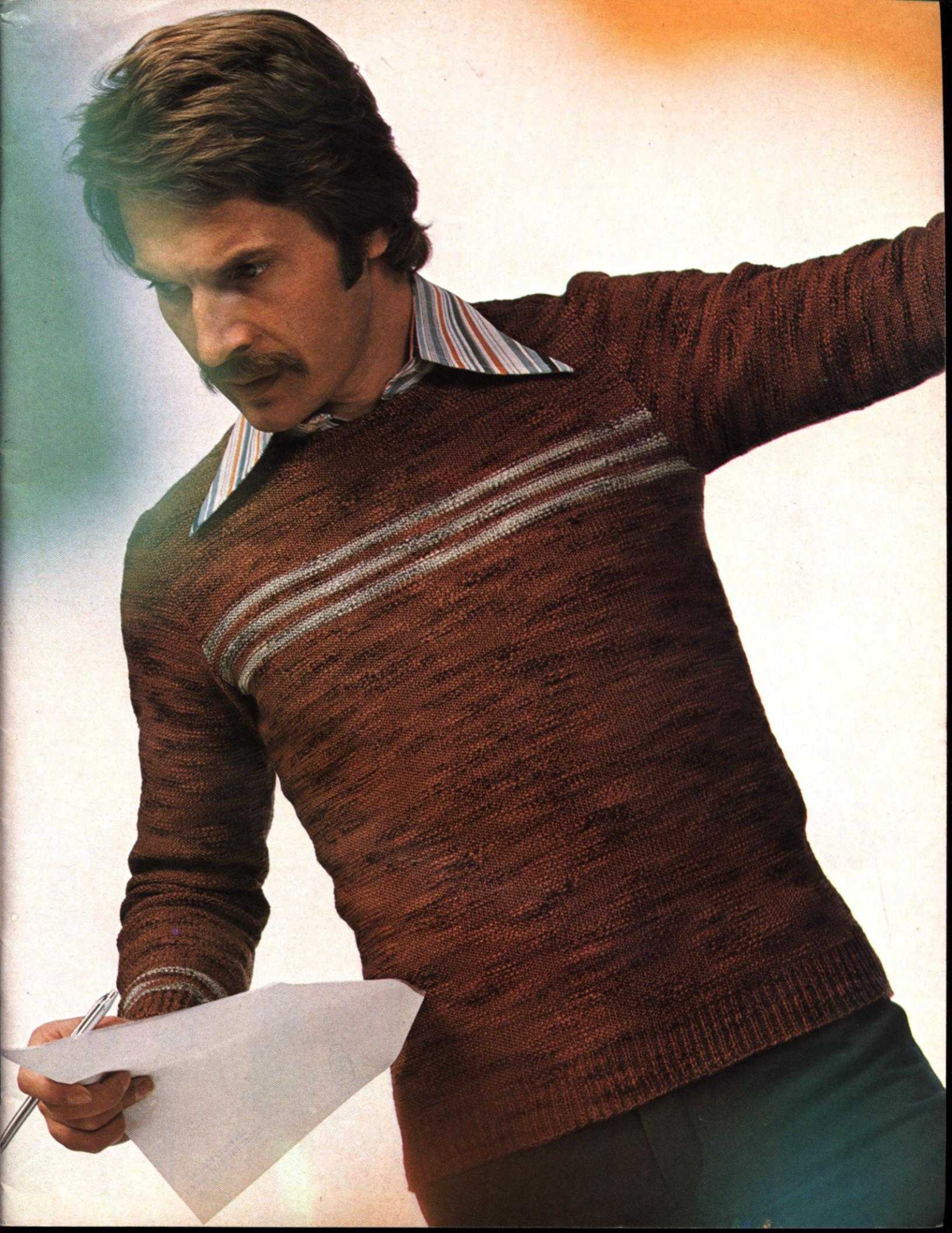





DK73



DK72







DK65



DK74



DK62

knitking

magazine

INDEX		PAGE NO.
DK 61	Woman's Coat and Pants	18
DK 62	Woman's Dress	20
DK 63	Woman's Skirt and Pullover	22
DK 64	Woman's Coat	23
DK 65	Woman's Dress	24
DK 66	Woman's Pullover and Pants	26
DK 67	Woman's Dress and Coat	28
DK 68	Woman's Dress	30
DK 69	Woman's Jacket	31
DK 70	Woman's Pantsuit	32
DK 71	Woman's Pantsuit	34
DK 72	Woman's Pants and Vest	36
DK 73	Woman's Long Vest	38
DK 74	Woman's Dress	40
HP 75	Man's Pullover and Jacket	41
HP 76	Man's Jacket	45
HP 77	Man's Pullover	47
HP 78	Man's Pullover	48
HP 79	Man's Jacket	49
HP 80	Man's Jacket	50
KK 81	Girl's Skirt and Sleeveless Pullover	52
KK 82	Girl's Skirt and Pullover	53
KK 83	Girl's Jacket and Pullover	54
KK 84	Boy's Pantsuit	56
KK 85	Child's Pullover	58
KK 86	Boy's Pantsuit	60
KK 87	Child's Pullover and Cap	62
KK 88	Child's Jacket and Pullover	63
KK 89	Child's Pullover	66
KK 90	Child's Pullover	68

Publisher: KNITKING CORPORATION, 1128 Crenshaw Blvd., Los Angeles, Calif. 90019. Telephone: (213) 938-2079. Published bi-monthly. Subscriptions: USA — \$10.00 annually, single copies \$3.00; Canada — \$12.00; other parts of the world — \$15.00. The entire contents of KNITKING MAGAZINE are copyright and must not be reproduced in any shape or form without the express permission, in writing of the publisher. © COPYRIGHT 1975 by KNITKING CORPORATION.

Printed in West Germany.

editorial

We are confident that before reading this Editorial, you have already spun the pages and examined the garments . . . and we believe that you like what you see . . . This issue has a really nice selection of garments for everybody in the family and in a range of sizes sufficient to make a majority of readers happy.

The first two issues of KNITKING MAGAZINE in the new format resulted in by far the largest number of comments ever received at KNITKING, and we are grateful for these comments . . . They tell us exactly what the majority of readers want . . . We are planning future issues accordingly.

Regular readers would also notice a complete revision of pattern symbols (they are illustrated on the other side of this page) and the elimination of several sets of figures on pattern charts . . . We will, in the next few issues, adjust instructions and symbols so that they become even easier to understand . . . You will also notice the introduction of a new symbol (a large "B" within a square) at the start of some patterns. These are Beginners Patterns specially designed for newcomers to machine knitting.

Because of insurmountable problems and lengthy delays caused through type setting and laying out the magazine in Germany, we are, starting with this issue, doing the work in the U.S.A. once again . . . We apologize for the delays in getting the first two issues in the format to you, but the problems were unforeseeable and the frustration unbelievable . . . so, we have withdrawn from our agreement to typeset, etc., in Germany . . . It costs much more to do the work in the U.S., but we are not accustomed to subscriber complaints and our reputation for consistently good service was suffering . . . We are getting back on the tracks now, so stay with us . . .

Pattern Symbols

Knitting — Chart Symbols

- () Size Symbols (2nd Size)
 < > 3rd Size
- B** Beginners Pattern
T Tension
G Gauge
① Color Number
- Cast on
 Stitch
R Row
H Hem
 Bind off
- Stockinette stitch — worn on the Knit side.
 Stockinette stitch — worn on the Purl side.
 Knit 1, Purl 1 Ribbing
 Ribbing Pattern — worn on the Knit side.
 Ribbing Pattern — worn on the Purl side.
- Closed Dart
 Open Dart
 Put on a stitch holder
 Reverse 1 section
 On every other needle
 Number of Rows between Shapings. Make increase (or decrease) FIRST, then knit 4 rows. For example: 3 x 1 means decrease (or increase) 1 st., knit 4 rows; decrease 1 st., knit 4 rows; decrease 1 st., knit 4 rows; decrease 1 st., knit 4 rows. All decreasing (or increasing) without row numbers as shown must be shaped on every 2nd row.

Increase

- Increase 2 sts. With a transfer tool, move the sts. over the left (or right) leaving 2 empty needles at the point of increase. At the increase point, move 1 st. to the left, (or right) so that there is an empty needles on each side of a stitch. On each side of the center stitch, pick up a stitch from the row below and hang it onto the empty needle.

- 3 stitches on 1 needle. The 1st and 3rd stitch in a group of 3 has been hung on the 2nd or center needle.

- Short Row increase or decrease; for instance on a flared skirt knitted sideways.

- Pattern Stitch

- Pattern Stitch — worn on the Knit side.

- Pattern Stitch — worn on the Purl side.

- Norwegian Design using the Pattern Reader. Only 1 row must be registered on the Pattern Reader, so when knitting two or more colors in 1 row, knit the first color with the LEVER of Pattern Reader UP (working), then push the LEVER DOWN (non-working) for the additional colors.

REPEAT the above for each complete row.

- Repeat

- I = Front
 II = Back
 III = Sleeve
 IV = Skirt Front
 V = Skirt Back
 VI = Collar
 VII = Pocket
 VIII = Band
 IX = Belt
 X = Cuff
 XI = Pants Front
 XII = Pants Back

Finishing — Chart Symbols

- Match numbers on section for assembling.
 Ease
 Fold Line
 Turn to the wrong side and hem.

Stitch Symbols

- Knit Stitch
 Purl Stitch
 Needles in holding position
 Needles back into working position.
 Empty needle (leave in working position)
 Needle not used (in the out of work position).
 Two stitches on 1 needle, either transferred from the right side or the left side, then put into holding position.
 Needle holding 2 stitches. Stitch has been transferred from the RIGHT.
 Needle holding 2 stitches. Stitch has been transferred from the LEFT.
 Center of garment section
 Pattern Reader
 JAC 40
 Adjustable Needle Selector
 Pattern Wheel
 Weaver
 Needle Shifter



General Instructions

GENERAL INSTRUCTIONS FOR THIS ISSUE

FULL FASHION DECREASING AND INCREASING

For Stockinette stitch, always use the Full Fashion method for decreasing or increasing.

TO DECREASE: Hang the 3rd stitch onto the 2nd stitch, then move the stitches in to fill the empty needle.

TO INCREASE: Move the 2 end stitches 1 needle outward, then pick up the 3rd stitch from the row below and hang it onto the empty needle.

NORWEGIAN DESIGNS

In the instructions, each row of the Norwegian Design is counted as 1 row but several movements of the Cam Box are needed to complete 1 row.

NORWEGIAN DESIGN WHEN USING THE PATTERN READER

When you use the Pattern Reader and knit a Norwegian Design using several colors, it is necessary to move the trip control lever so that only 1 row registers.

TO MAKE FRINGE

Cut yarn **DOUBLE** the length of fringe desired (wind around a cardboard or book). Using 2 or more strands of yarn (depending on weight of yarn) fold in half and with a crochet hook, draw folded loop through knitting from the wrong side. Pull strands through loop and tighten.

To make an additional row of knots on fringe, take half the strands from 1 group and half from the next group, then knot together approximately 1" to 2" below and continue across.

FINISHING: Block all sections. For **PULLOVERS, JACKETS and DRESSES:** Join front to back at sides and shoulders. Sew sleeves together and set in. Hem lower edge and sleeve edges if needed. For a double neckband or armhole band, sew 1 edge to the inside and 1 to the outside of neck or armhole. For a single ribbed band, sew 1 edge to the outside of neck or armhole edge. For a Cardigan or Jacket with buttonholes, finish buttonholes and sew on buttons.

PANTS: Join front to back at sides. Sew inside leg seams, then join center front and back. Make hem at waistline and insert elastic. Hem lower edge of pants legs.

THE SAMPLE SWATCH

Before you begin to knit any garment, you will need to knit a sample piece using the yarn you have chosen for your garment, so that you can check the stitch and row gauge which must measure the correct number of stitches and rows in 5 cm (2 inches).

For each Pattern in **KNITTING MAGAZINE**, we give you 3 Tension Numbers to work from and if you use the specified yarn for the garment, you should be able to get the correct stitch and row gauge using one of these numbers. Here is a very easy way to make your sample swatch and count the stitches and rows **WITHOUT** actually counting, by using our **KNITTING CONVERTA TAPE**.

Supposing the Tension Numbers for the Stitch and Row Gauge are given as 5 to 7. Set the Tension Dial to the first number which is 5. With contrast waste yarn, and using the quick cast-on method, cast on 60 stitches and knit 10 rows. Change to garment yarn and turn the Row Counter to 0. Knit 30 rows. Counting from each end, knit the 10th stitch on each side by hand with a small piece of contrast yarn. Leave the needles in working position and knit 30 rows (Row 60), then knit 4 rows with contrast waste yarn. Turn the Row Counter to 0 and the Tension Dial to 6 and with garment yarn, knit 30 rows. Mark the 10th stitch on each side as you did before, knit 30 rows, then 4 rows with contrast waste yarn. Turn the Row Counter to 0 and with Tension 7, repeat the above once more ending with 10 rows of contrast waste yarn, then remove the work from the machine by passing the Slide across the needles without yarn (sometimes called 'dropping').

Pull and stretch the sample piece both lengthwise and diagonally from corner to corner, then lengthwise again. Do not count the stitches and rows immediately, but allow the sample to rest for several hours or even over night. This will allow the stitches and rows to return to their basic form.

When your sample has rested and you are ready to count the stitches and rows, the **KNITTING CONVERTA TAPE** will do the figuring for you without any counting on your part. Use the Tape as follows:

To measure the stitches, pull out the Tape to measure **BETWEEN** the 40 stitches in the center that you marked by hand knitting with contrast waste yarn. Push the red marker on the Tape so that it points to 40 stitches on the Tape. Your stitch gauge to 5 cm (2 inches) will show in the red window on the tape. To find the number of rows in 5 cm (2 inches), place the tape to measure over 60 rows, push the red marker to 60 on the tape and your row gauge for 5 cm (2 inches) will show in the red window... Easy...? If you do not get the correct stitch and row gauge in the first part of your sample, then try the other two.

If you do not own a **KNITTING CONVERTA TAPE**, you must mark a 5 cm (2 inch) square in the center of the knitting, then count the number of stitches and rows within the square.



DK 61

WOMAN'S COAT AND PANTS

SIZE: 8/10 (12/14) [16/18]

YARN: Beatrice

grams 900 950 1000

TENSION: 5 to 7

GAUGE:

Stock: 16 sts. 22 rows = 5 cm

Pattern: 13 sts. 20 rows = 5 cm



COAT: Holding Position Design according to Line Drawing with needles out of work that ARE counted in the stitch gauge and instructions. The purl side of Pattern stitch is the right side. Border and Bands are in Stockinette stitch. PANTS: Stockinette stitch.

FINISHING: See General Instructions. Ease the extra rows at the bustline of front section of Coat.

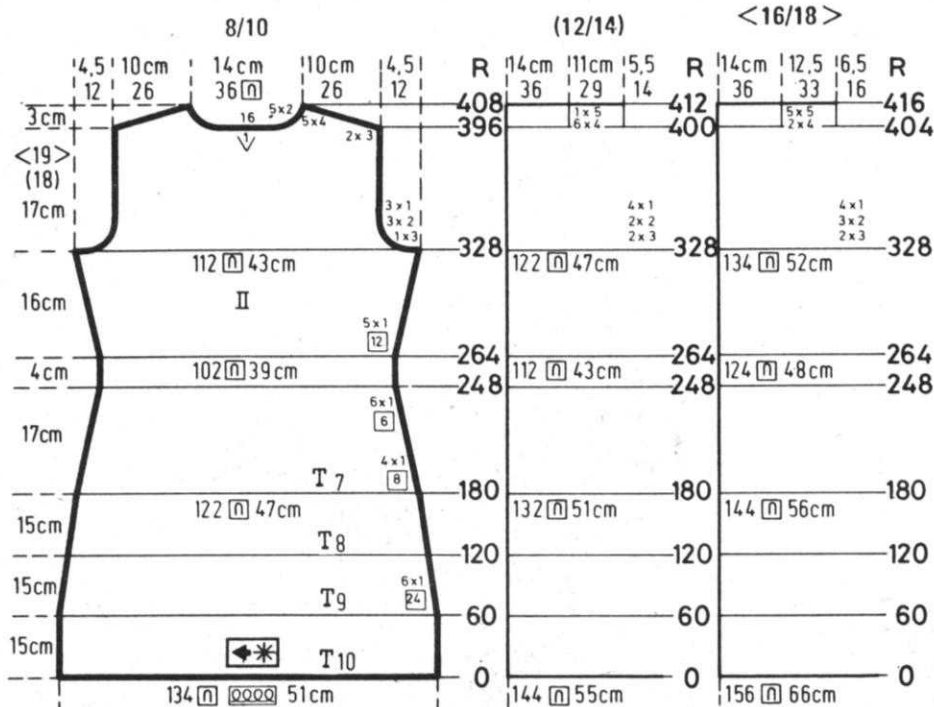
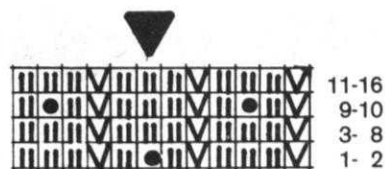

COAT BACK: II

Bring 134 (144) [156] needles into working position, set into Pattern then cast on over the remaining needles. Work in Holding Position Design with Tension 10 to Row 60. Change to Tension 9 and ON EACH SIDE decrease 1 st. every 24th row 6x, changing to Tension 8 after Row 120. After Row 180, change to Tension 7 and ON EACH SIDE, decrease 1 st. every 8th row 4x, every 6th row 6x. Knit to Row 264. ON EACH SIDE, increase 1 st. every 12th row 5x. Knit to Row 328.

SHAPE ARMHOLE: ON EACH SIDE, bind off 3 sts. 1x, 2 sts. 3x, 1 st. 3x. (3 sts. 2x, 2 sts. 2x, 1 st. 4x). [3 sts. 2x, 2 sts. 3x, 1 st. 4x]. Knit to Row 396 (400) [404]. Bind off the center 16 sts. put the needles on the left side into holding position and complete the right half first.

*SHAPE SHOULDER AND NECK AT THE SAME TIME. Bind off FOR SHOULDER: 3 sts. 2x, 4 sts. 5x (4 sts. 6x, 5 sts. 1x) [4 sts. 2x, 5 sts. 5x]. FOR NECK: All Sizes 2 sts. 5x.

Bring the needles on the left into working position, knit 1 row in Pattern to the left side, turn the Row Counter back to 396 (400) [404] and complete the left half. Follow the instructions from *.

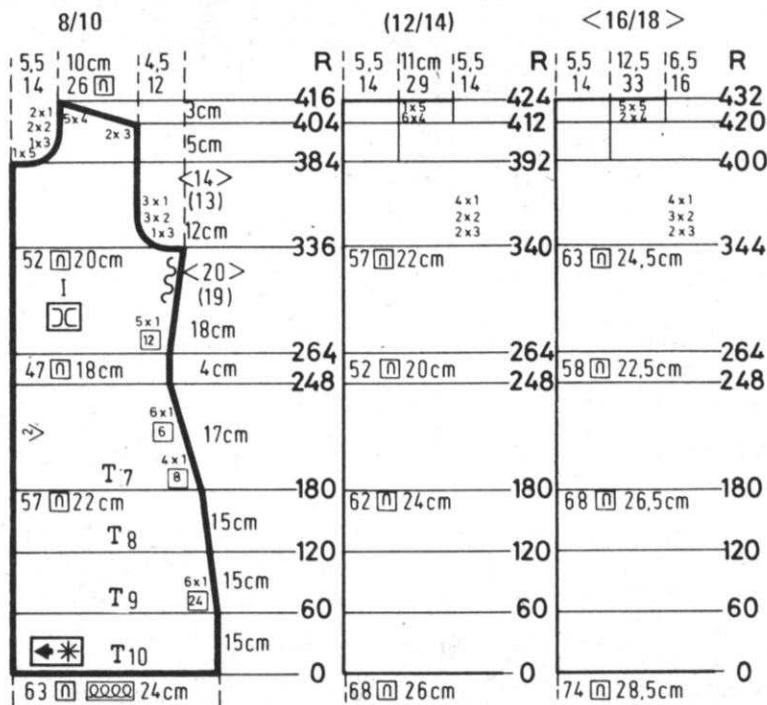

COAT FRONT: I - Make 1, reverse 1.

Bring 63 (68) [74] needles into working position, set into Pattern then cast on over the remaining needles. Work in Holding Position Design with Tension 10 to Row 60. Change to Tension 9 and ON CAM BOX SIDE decrease 1 st. every 24th row 6x. After Row 180, decrease 1 st. ON CAM BOX SIDE every 8th row 4x, every 6th row 1x. Knit to Row 264. ON SIDE EDGE, increase 1 st. every 12th row 6x. Knit to Row 336 (340) [344].

SHAPE ARMHOLE: Bind off 3 sts. 1x, 2 sts. 3x, 1 st. 3x. (3 sts. 2x, 2 sts. 2x, 1 st. 4x) [3 sts. 2x, 2 sts. 3x, 1 st. 4x]. Knit to Row 385 (393) [401].

Bind off for NECK - All Sizes: 5 sts. 1x, 3 sts. 1x, 2 sts. 2x, 1 st. 2x. SHAPE SHOULDER after Row 396 (400) [404]. Bind off 3 sts. 2x, 4 sts. 5x. (4 sts. 6x, 5 sts. 1x). [4 sts. 2x, 5 sts. 5x].

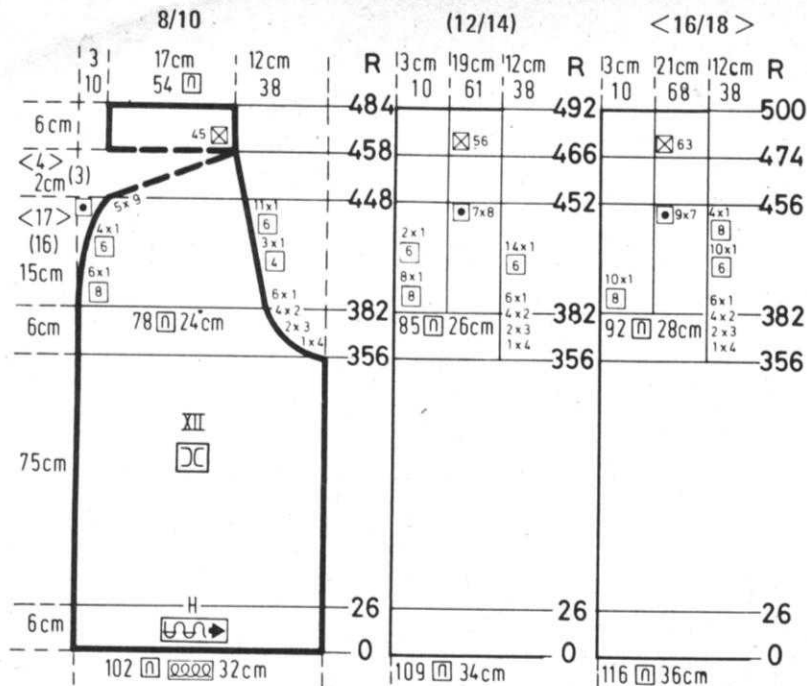

PANTS BACK: XII Make 1, reverse 1.

Cast on 102 (109) [116] sts. and work Stockinette stitch. Knit even to Row 356. Begin Shaping center back and after Row 382, SHAPE SIDE EDGE. Bind off CENTER BACK - Row 356, 4 sts. 1x, 3 sts. 2x, 2 sts. 4x, 1 st. 6x, 1 st. every 4th row 3x, 1 st. every 6th row 11x. (4 sts. 1x, 3 sts. 2x, 2 sts. 4x, 1 st. 6x, 1 st. every 6th row 14x). [4 sts. 1x, 3 sts. 2x, 2 sts. 4x, 1 st. 6x, 1 st. every 6th row 10x, 1 st. every 8th row 4x]. SIDE EDGE - Row 382, 1 st. every 8th row 6x, 1 st. every 6th row 4x. (1 st. every 8th row 8x, 1 st. every 6th row 2x). [1 st. every 8th row 10x].

After Row 448 (452) [456], work Short Rows. ON OPPOSITE SIDE OF CAM BOX, put into holding position 9 sts. 5x (8 sts. 7x). [7 sts. 9x]. Bring all the needles back into working position before knitting the next row, then knit to Row 484 (492) [500] and bind off.

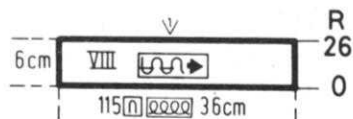
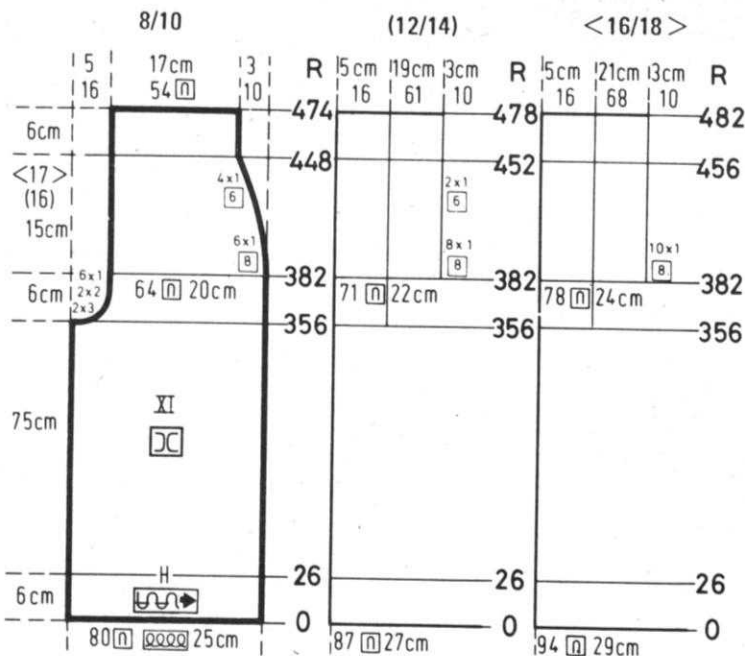

COAT NECKBAND: VIII

Cast on 115 sts. and work 26 rows Stockinette stitch then bind off.

PANTS FRONT: XI Make 1, reverse 1.

Cast on 80 (87) [94] sts and work Stockinette stitch. Knit even to Row 357. Begin SHAPING CENTER FRONT and after Row 382, SHAPE SIDE EDGE. Bind off CENTER FRONT - Row 357. ALL SIZES: 3 sts. 2x, 2 sts. 2x. 1 st. 6x. SIDE EDGE - Row 382, 1 st. every 8th row 6x, 1 st. every 6th row 4x. (1st. every 8th row 8x, 1 st. every 6th row 2x). [1 st. every 8th row 10x]. Knit to Row 474 (478) [482] then bind off.

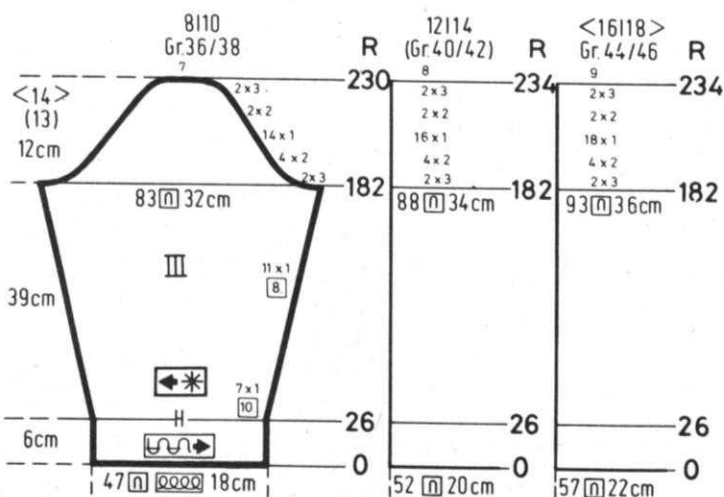

SLEEVE: III

Cast on 47 (52) [57] sts. and work Stockinette stitch to Row 26 then hang the hem. Set the needles into Pattern and continue with Holding Position Design.

ON EACH SIDE increase 1 st. every 10th row 7x, every 8th row 11x. Knit to Row 182. SHAPE CAP: ON EACH SIDE bind off 3 sts. 2x, 2 sts. 4x, 1 st. 16x, 2 sts. 2x, 3 sts. 2x. (3 sts. 2x, 2 sts. 4x, 1 st. 16x, 2 sts. 2x, 3 sts. 2x). [3 sts. 2x, 2 sts. 4x, 1 st. 18x, 2 sts. 2x, 3 sts. 2x]. After Row 230 (234) [234] bind off the remaining 7 (8) [9] sts.

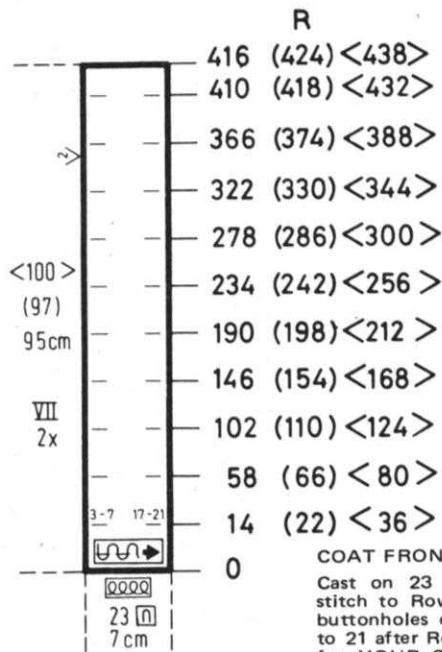

BE SURE TO NOTIFY US IMMEDIATELY OF ANY CHANGE OF ADDRESS. THE POST OFFICE WILL NOT FORWARD YOUR MAGAZINE TO YOU.

COAT FRONT BAND:

Cast on 23 sts. and work Stockinette stitch to Row 416 (424) [438] making buttonholes over needles 3 to 7 and 17 to 21 after Rows as marked on the Chart for YOUR SIZE, then bind off. Make another band, omitting the buttonholes.

DK 62

WOMAN'S DRESS



SIZE: 12/14 (16/18) [20/22]
YARN: Crocus Crepe
 grams C1 450 500 550
 grams C2 100 100 100
 grams C3 100 100 100
 grams C4 100 100 100
TENSION:
 Stock: 7 to 9
 Pattern: 10
GAUGE:
 Stock: 15 sts. 20 rows = 5 cm
 Pattern: 10 sts. 17 rows = 5 cm

Skirt and Sleeves are a Holding Position Design with needles out of work according to the Line Drawing. The out of work needles ARE counted in the stitch gauge and instructions. Bodice and Neckband are Stockinette stitch. The knit side is the right side.

FINISHING: See General Instructions. Gather Skirt and sew to bodice. Attach fringe to lower edge of dress and sleeves. Sew neckband to neckline then work 1 row single crochet around neck and 1 row Picot as follows: *chain 3, slip stitch into first of chain 3, single crochet into next 3 sts. REPEAT FROM *.

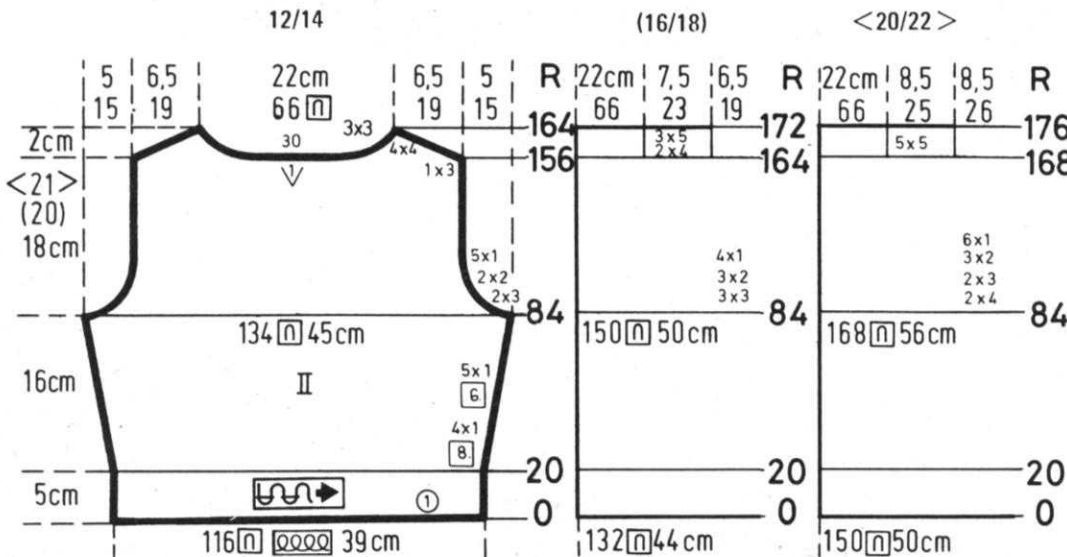
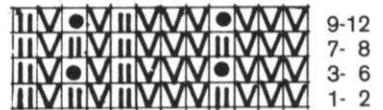

BODICE BACK: II
 Cast on 116 (132) [150] sts. with color 1 and work Stockinette stitch. Knit even to Row 20. ON EACH SIDE, increase 1 st. every 8th row 4x, every 6th row 5x. Knit to Row 84.

SHAPE ARMHOLE: On each side bind off 3 sts. 2x, 2 sts. 2x, 1 st. 5x. (3 sts. 3x, 2 sts. 3x, 1 st. 4x). [4 sts. 2x, 3 sts. 2x, 2 sts. 3x, 1 st. 6x]. Knit to Row 156 (164) [168]. Bind off the center 30 sts., put the needles on the left side into holding position and complete the right half first.

***SHAPE SHOULDER AND NECK AT THE SAME TIME.** Bind off FOR SHOULDER: 3 sts. 1x, 4 sts. 4x. (4 sts. 2x, 5 sts. 3x). [5 sts. 5x]. FOR NECK: ALL SIZES: 3 sts. 3x.

Bring the Cam Box to the left side, turn the Row Counter back to 156 (164) [168] and complete the left half. Follow the instructions from *.

DK 63

WOMAN'S SKIRT AND PULLOVER

SIZE: 7/8 (10/12) [14/16]

YARN: Amore

grams C1 450 500 550
grams C2 300 350 400

TENSION: 6 to 8

GAUGE: 16 sts. 26 rows = 5 cm

Skirt: Stockinette stitch. Pullover: Norwegian Design that follows the Line Drawing or use JAC 40 and Pattern No. 570. Bands: K1, P1 Ribbing. The knit side is the right side.

FINISHING: See General Instructions.



570

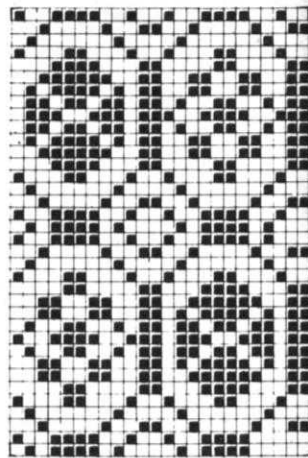

□ - COLOR 1 ■ - COLOR 2

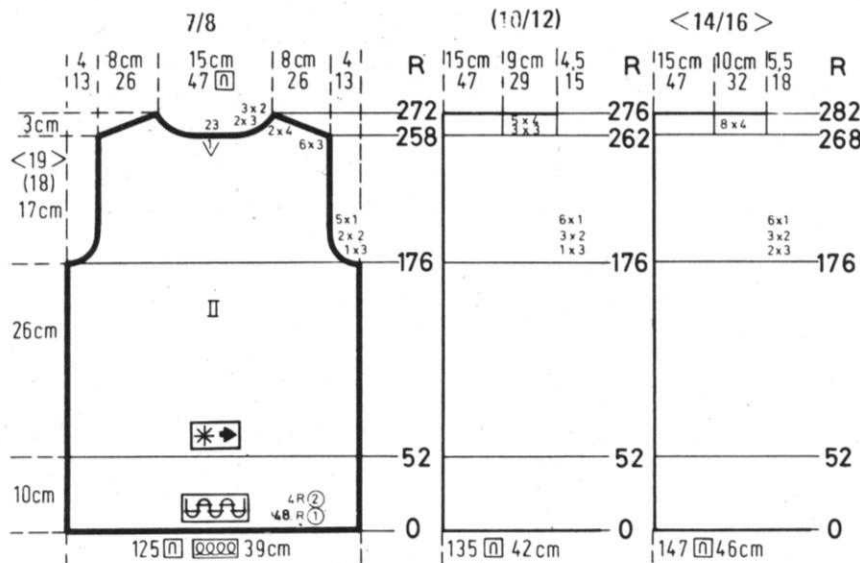

PULLOVER BACK: II

Cast on 125 (135) [147] sts. with color 1 and work K1, P1 Ribbing to Row 48, change to color 2 and rib 4 more rows, then transfer the ribber sts. to main machine and continue in Norwegian Design. Knit to Row 176.

SHAPE ARMHOLE: ON EACH SIDE, bind off 3 sts. 1x, 2 sts. 2x, 1 st. 5x. (3 sts. 1x, 2 sts. 3x, 1 st. 6x). [3 sts. 2x, 2 sts. 3x, 1 st. 6x]. Knit to Row 258 (262) [268]. Bind off the center 23 sts. put the needles on the left side into holding position and complete the right half first.

SHAPE NECK AND SHOULDER AT THE SAME TIME. *Bind off FOR SHOULDER: 3 st. 6x, 4 sts. 2x. (3 sts. 3x, 4 sts. 5x). [4 sts. 8x]. FOR NECK: ALL SIZES, 3 sts. 2x, 2 sts. 3x.

Bring the needles on the left into working position, knit 1 row in Pattern to the left side, turn the Row Counter back to 258 (262) [268] and complete the left half. Follow the instructions from *.

PULLOVER FRONT: I

Work the front section the same as the back to Row 176. SHAPE ARMHOLE: ON EACH SIDE, bind off 3 sts. 1x, 2 sts. 2x, 1 st. 5x. (3 sts. 1x, 2 sts. 3x, 1 st. 6x). [3 sts. 2x, 2 sts. 3x, 1 st. 6x]. AT THE SAME TIME, after Row 190, hang the center st. onto the neighboring needle, put the needles on the left side into holding position and complete the right half first.

*ON NECK SIDE, decrease 1 st. every 2nd row 5x, every 4th row 18x and SHAPE SHOULDER after Row 258. (every 2nd row 5x, every 4th row 18x and SHAPE SHOULDER after Row 262). [every 2nd row 11x, every 4th row 22x and SHAPE SHOULDER after Row 266]. FOR SHOULDER, bind off 3 sts. 6x, 4 sts. 2x. (3 sts. 3x, 4 sts. 5x). [4 sts. 8x].

Bring the needles on the left into working position, knit 1 row in Pattern to the left side, turn the Row Counter back to 190 and complete the left half. Follow the instructions from *.

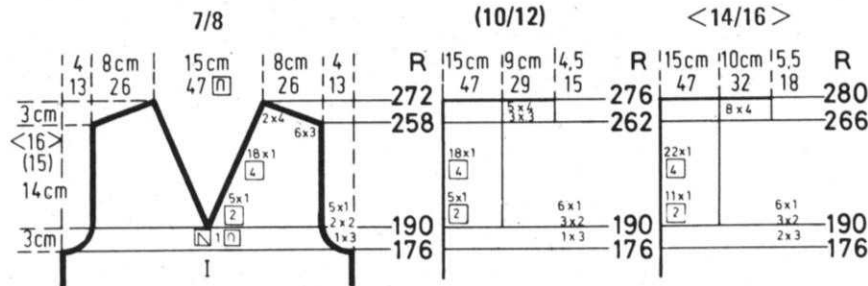

SLEEVE: III

Cast on 87 (93) [99] sts. with color 1 and work K1, P1 Ribbing. Knit 28 rows then change to color 2 and knit to Row 32. Change to Stockinette stitch. ON EACH SIDE, increase 1 st. every 4th row 6x.

After Row 60, SHAPE CAP: ON EACH SIDE bind off 3 sts. 1x, 2 sts. 4x, *1 st. 2x, 2 sts. 1x and REPEAT from * 5x more, 3 sts. 3x. (3 sts. 1x, 2 sts. 3x, *1 st. 2x, 2 sts. 1x and REPEAT from * 6 x more, 2 sts. 3x, 3 sts. 2x). After Row 112 (118) [122] bind off the remaining 11 (13) [13] sts.

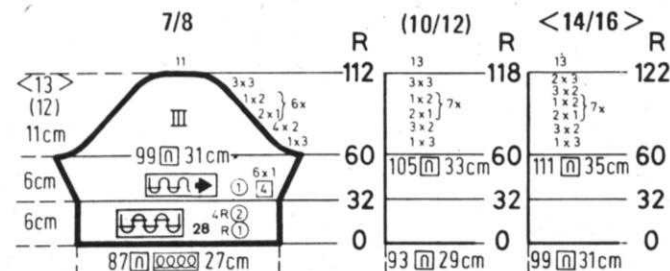

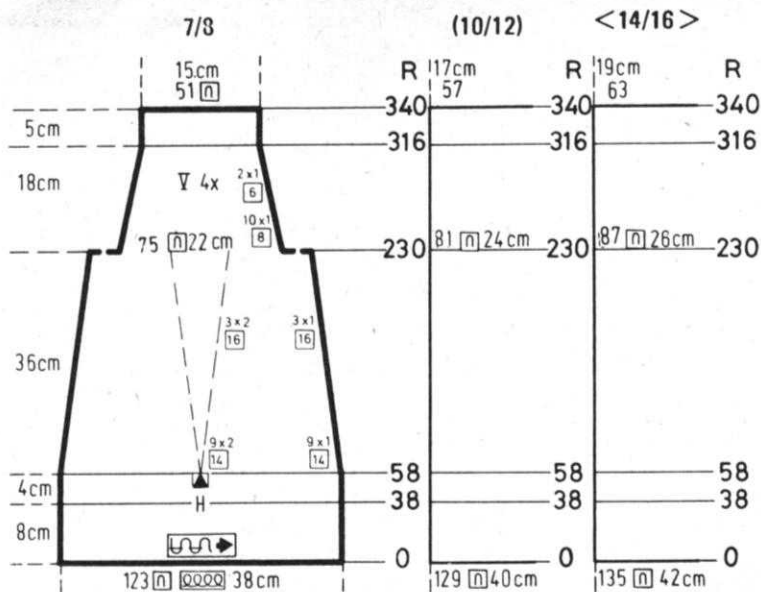

SKIRT: V: Make 4 sections.

Cast on 123 (129) [135] sts. and work Stockinette stitch. Knit to Row 38, hang the hem then knit to Row 58. Decrease 2 sts. for DART and 1 st. ON EACH SIDE at the same time, every 14th row 9x, every 16th row 3x. FOR THE DART decreases, the first time hang the 60th (63rd) [66th] st. ON EACH SIDE onto the 61st (64th) [67th] needles and move the sts. in to fill the empty needles. The following DART decreases lie directly above. After Row 230, ON EACH SIDE, decrease 1 st. every 8th row 10x, every 6th row 2x. After Row 340, bind off the remaining 51 (57) [63] sts.

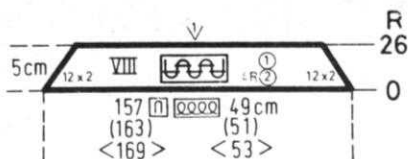

NECKBAND: VIII

Cast on 157 (163) [169] sts. with color 2 and work K1, P1 Ribbing. Change to color 1 after Row 4 and ON EVERY OTHER ROW ON EACH SIDE, decrease 1 st. 12x. After Row 26, bind off the crochet method for Ribbing.

DK 64

WOMAN'S COAT

SIZE: 8/10 (12/14) [16/18]

YARN: Flamingo

grams 650 700 750

TENSION: 6 to 8

GAUGE: 15 sts. 18 rows = 5 cm

Coat is a Mock Rib with every 4th needle out of work (and counted in the stitch gauge and instructions). COLLAR: Loop Crochet. See FINISHING instructions below. The knit side of Rib is the right side.

FINISHING: See General Instructions. LOOP CROCHET COLLAR: Use Yarn doubled. Make a chain 108 cm (112 cm) [116 cm] long. Work 1 row single crochet into each stitch, turn. ROW 1: LOOP ROW: Single crochet into first stitch. *Put hook into next stitch and place your middle finger OVER the yarn in BACK, yarn over hook and pull through (slip stitch). Chain 1, REPEAT from * to end, chain 1 turn. ROW 2: Hold loop down with your left thumb and single crochet into stitch BETWEEN each group of loops, chain 1, turn. REPEAT ROWS 1 and 2 for Pattern and at the same time, decrease ON EACH SIDE as shown on the Chart. If you prefer longer loops, place 2 fingers over yarn in back instead of 1 finger.

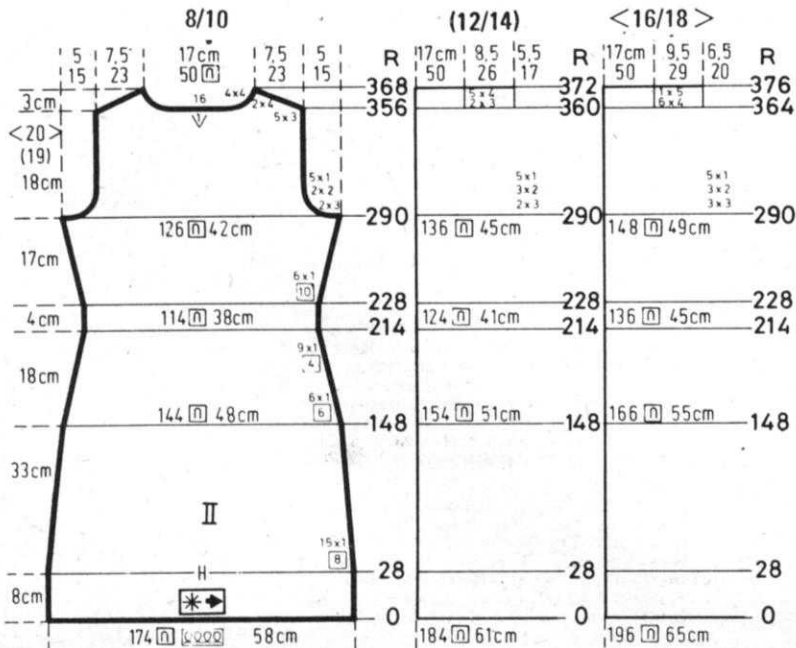

BACK: II

Bring 174 (184) [196] needles into working position, then set into MOCK RIB PATTERN and cast on over the remaining needles in work. Knit to Row 28 and hang the hem.

ON EACH SIDE, decrease 1 st. every 8th row 15x. After Row 148, ON EACH SIDE, decrease 1 st. every 6th row 6x, every 4th row 9x. Knit even to Row 228. ON EACH SIDE, increase 1 st. every 10th row 6x. Knit to Row 290.

SHAPE ARMHOLE: ON EACH SIDE bind off 3 sts. 2x, 2 sts. 2x, 1 st. 5x. (3 sts. 2x, 2 sts. 3x, 1 st. 5x). [3 sts. 3x, 2 sts. 3x, 1 st. 5x]. Knit to Row 356 (360) [364], bind off the center 16 sts., put the needles on the left side into holding position and complete the right half first.

SHAPE SHOULDER AND NECK AT THE SAME TIME. *Bind off FOR SHOULDER: 3 sts. 5x, 4 sts. 2x. (3 sts. 2x, 4 sts. 5x). [4 sts. 6x, 5 sts. 1x]. FOR NECK: ALL SIZES, 4 sts. 4x.

Bring the needles on the left into working position, knit 1 row to the left side, turn the Row Counter back to 356 (360) [364] and complete the left half. Follow the instructions from *.

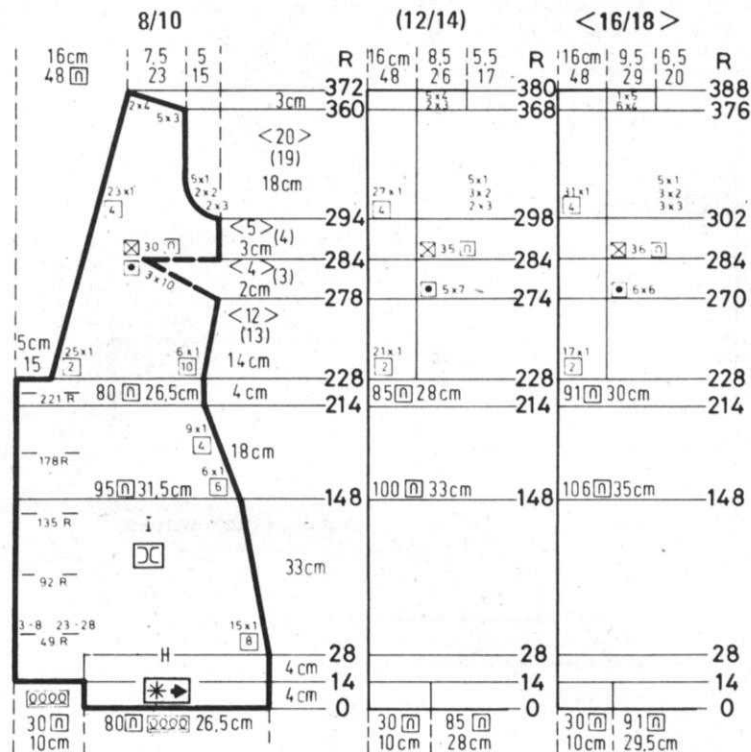

FRONT: I

Bring 80 (85) [91] needles into working position, set into MOCK RIB PATTERN, then cast on over the remaining needles in work. Knit to Row 14, then cast on 30 sts. on the LEFT (right for second section) side. (use a separate yarn to cast on.) Knit to Row 28, then hang the original cast on sts. back onto the machine to form the hem.

ON SIDE EDGE, decrease 1 st. every 8th row 15x AND AT THE SAME TIME, make BUTTONHOLES over needles 3 to 8 and 23 to 28 counting from the left edge, after rows as SHOWN ON THE CHART. After Row 148, ON SIDE EDGE, decrease 1 st. every 6th row 6x, every 4th row 9x. Knit to Row 228.

ON SIDE EDGE, increase 1 st. every 10th row 6 x AND AT THE SAME TIME AT FRONT EDGE, bind off 15 sts. then every 2nd row at front edge, decrease 1 st. 25x (21x) [17x], every 4th row 23x (27x) [31x] and ON SIDE EDGE after Row 277 (273) [283] work Short Rows for the Bust Darts.

ON OPPOSITE SIDE OF CAM BOX, put into holding position 10 needles 3x (7 needles 5x) [6 needles 6x]. Bring all the needles back into working position before knitting the next row. Knit to Row 294 (298) [302].

SHAPE ARMHOLE: Bind off 3 sts. 2x, 2 sts. 2x, 1 st. 5x. (3 sts. 2x, 2 sts. 3x, 1 st. 5x). [3 sts. 3x, 2 sts. 2x, 1 st. 5x]. Knit to Row 360 (368) [376].

SHAPE SHOULDER: Bind off 3 sts. 5x, 4 sts. 2x. (3 sts. 2x, 4 sts. 5x). [4 sts. 6x, 5 sts. 1x]. Make the second section with reverse shaping, but OMIT the Buttonholes.

DK 65

WOMAN'S DRESS

SIZE: 10/12 (14/16) [18/20]
 YARN: Flamingo
 grams C1 400 450 500
 grams C2 100 100 100
 grams C3 100 100 100
 TENSION: 7 to 9
 GAUGE: 14 sts. 19 rows = 5 cm

Stockinette stitch with color stripes as marked on the Chart. Collar and Cuffs, K1, P1 Ribbing. The knit side is the right side.
 FINISHING: See General Instructions.

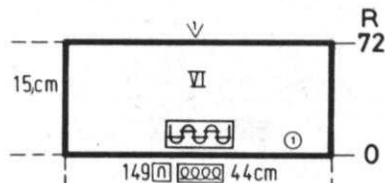
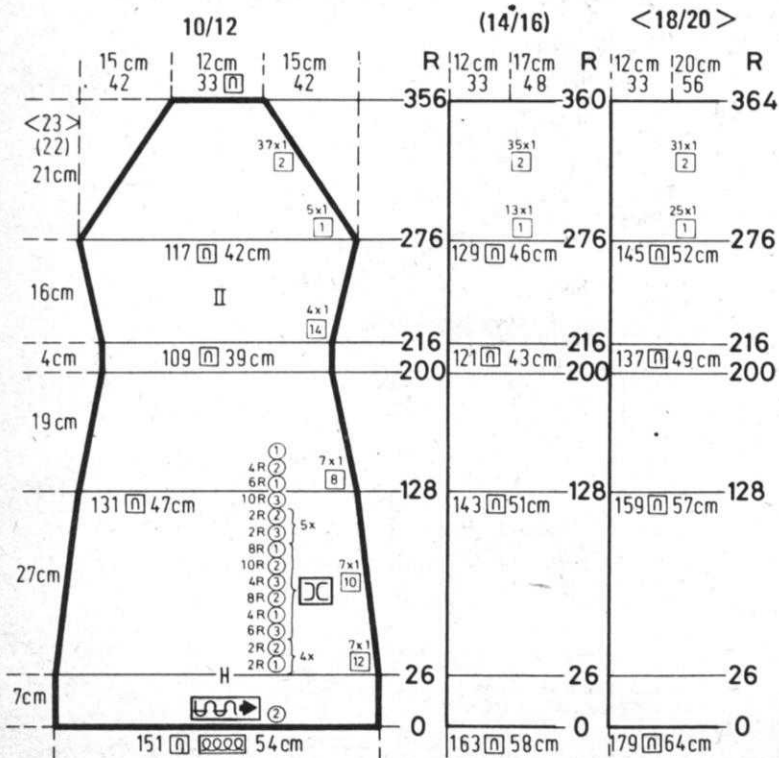

COLLAR: VI
 Cast on 149 sts. and work 72 rows K1, P1 Ribbing, then bind off.

BACK: II

Cast on 151 (163) [179] sts. with color 2 and work Stockinette stitch. Knit to Row 26, then hang the hem. Work the COLOR STRIPES as shown on the CHART and ON EACH SIDE, decrease 1 st. every 12th row 7x, every 10th row 7x. After Row 128, ON EACH SIDE, decrease 1 st. every 8th row 7x. Knit to Row 216.

ON EACH SIDE, increase 1 st. every 14th row 4x. After Row 276, SHAPE RAGLAN: ON EACH SIDE ON EVERY ROW decrease 1 st. 5x (13x) [25x], then on EVERY OTHER ROW, decrease 1 st. 37x (35x) [31x]. After Row 356 (360) [364], bind off the remaining 33 (48) [56] sts.

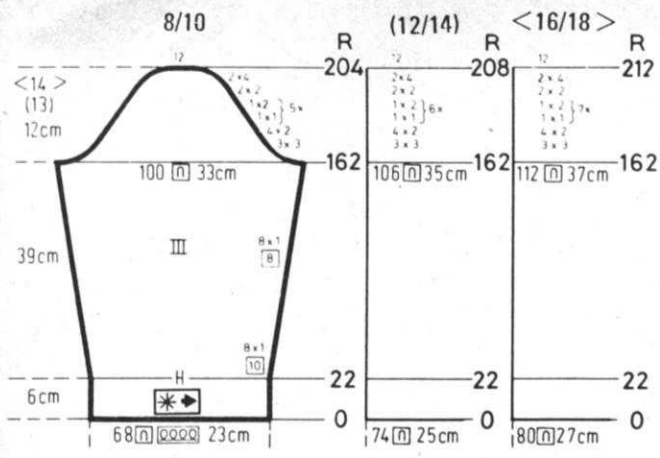

DK 64
SLEEVE: III

Bring 68 (74) [80] needles into working position, then set into **MOCK RIB PATTERN** and cast on over the remaining needles in work. Knit to Row 22. **ON EACH SIDE**, increase 1 st. every 10th row 8x, every 8th row 8x. Knit to Row 162.

SHAPE CAP: ON EACH SIDE, bind off 3 sts. 3x, 2 sts. 4x, *1 st. 1x, 2 sts. 1x and **REPEAT** from * 4x more, 2 sts. 2x, 4 sts. 2x. (3 sts. 3x, 2 sts. 4x, *1 st. 1x, 2 sts. 1x and **REPEAT** from * 5x more, 2 sts. 2x, 4 sts. 2x). [3 sts. 3x, 2 sts. 4x, *1 st. 1x, 2 sts. 1x and **REPEAT** from * 6x more, 2 sts. 2x, 4 sts. 2x]. After Row 204 (208) [212], bind off the remaining 12 sts.

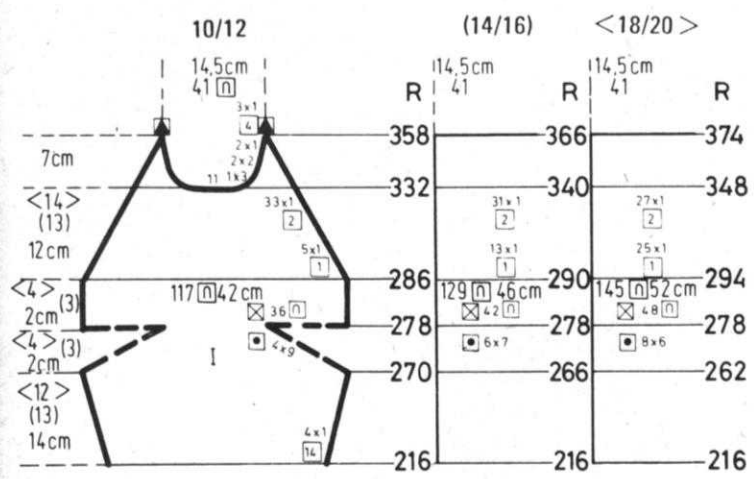
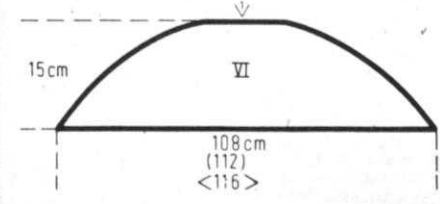

FRONT: I

Work the front section the same as the back to Row 270 (266) [262], then work Short Rows for the Bust Darts.

ON OPPOSITE SIDE OF CAM BOX, put into holding positions 9 sts. 4x **ON EACH SIDE**. (7 sts. 6x **ON EACH SIDE**). [6 sts. 8x **ON EACH SIDE**]. Bring all the needles **OPPOSITE CAM BOX** back into working position before knitting the next 2 rows then knit to Row 286 (290) [294].

ON EACH SIDE, decrease 1 st. **EVERY ROW** 5x (13x) [25x] then on **EVERY OTHER ROW ON EACH SIDE**, decrease 1 st. 33x (31x) [27x] and **AT THE SAME TIME SHAPE NECK** after Row 332 (340) [348]. Bind off the center 11 sts., put the needles on the left side into holding position and complete the right half first.

***ON NECK SIDE**, bind off 3 sts. 1x, 2 sts. 2x, 1 st. 2x, then on every 4th row 1 st. 3x. Bring the Cam Box to the left side, turn the Row Counter back to 332 (340) [348] and complete the left half. Follow the instructions from *.

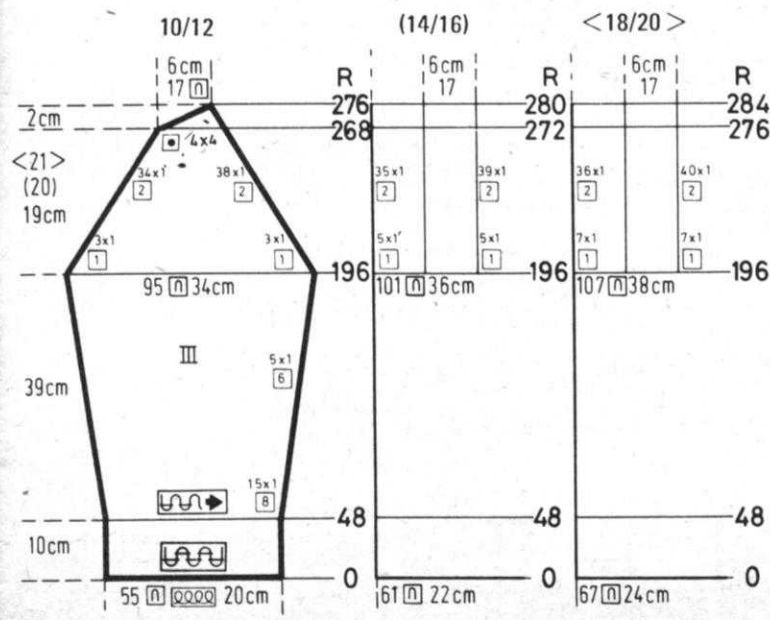

SLEEVE: III

Cast on 55 (61) [67] sts. and work K1, P1 Ribbing to Row 48. Change to Stockinette stitch. **ON EACH SIDE**, increase 1 st. every 8th row 15x, every 6th row 6x.

SHAPE RAGLAN after Row 196. **ON EACH SIDE**, decrease 1 st. **EVERY ROW** 3x (5x) [7x], then **ON EVERY OTHER ROW**, on **OPPOSITE SIDE OF CAM BOX**, decrease 1 st. 34x (35x) [39x] and **ON CAM BOX SIDE**, decrease 1 st. **EVERY OTHER ROW** 38x (39x) [40x].

After Row 268 (272) [276], work Short Rows. **ON OPPOSITE SIDE OF CAM BOX**, put into holding position, 4 needles 4x. After Row 276 (280) [284], bring all the needles into working position and bind off.

DK 66

WOMAN'S PULLOVER AND PANTS

SIZE: 8/10 (12/14) [16/18]
 YARN: Beatrice
 Pullover grams 400 450 500
 Pants grams 450 500 550
 TENSION: 6 to 8
 GAUGE: 16 sts. 20 rows = 5 cm

Mock Rib Pattern as shown in Line Drawing, with every 4th needle out of work. The empty needles DO count in the stitch gauge and instructions. The knit side is the right side.

FINISHING: See General Instructions. Work 1 row single crochet around back neck opening then set in a zipper.

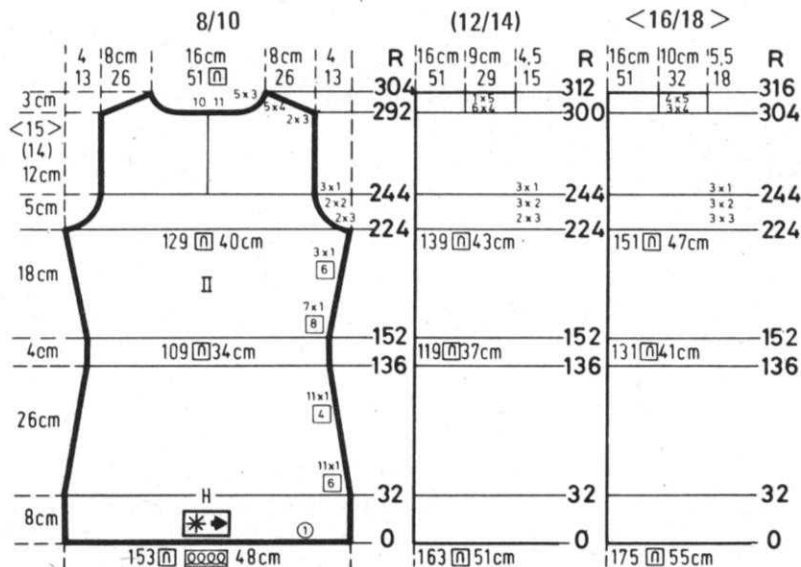

PULLOVER BACK: II

Bring 153 (163) [175] needles into working position, set up into MOCK RIB Pattern, then cast on with color 1 over the remaining needles in work. Knit to Row 32. ON EACH SIDE decrease 1 st. every 6th row 11x, every 4th row 11x. Knit even to Row 152. ON EACH SIDE, increase 1 st. every 8th row 7x, every 6th row 3x.

After Row 224, SHAPE ARMHOLE. ON EACH SIDE, bind off 3 sts. 2x, 2 sts. 2x, 1 st. 3x. (3 sts. 2x, 2 sts. 3x, 1 st. 3x). [3 sts. 3x, 2 sts. 3x, 1 st. 3x]. Knit to Row 224, then divide in the center and put the needles on the left side into holding position and complete the right half first. * Knit to Row 292 (300) [304].

SHAPE NECK AND SHOULDER AT THE SAME TIME. Bind off FOR SHOULDER: 3 sts. 2x, 4 sts. 5x. (4 sts. 6x, 5 sts. 1x). [4 sts. 3x, 5 sts. 4x]. FOR NECK: ALL SIZES THE SAME, 11 sts. (10 sts. for left half) 3 sts. 5x. Bring the needles on the left into working position, knit 1 row to the left side, turn the Row Counter, back to 224 and complete the left half. Follow the instructions from *.

PULLOVER FRONT: I

Work the front section the same as the back section to Row 212 (208) [204], then work Short Rows for the Bust Darts. ON OPPOSITE SIDE OF CAM BOX, put into holding position 9 sts. 4x ON EACH SIDE. (7 sts. 6x ON EACH SIDE). [6 sts. 8x ON EACH SIDE]. ON OPPOSITE SIDE OF CAM BOX, bring all the needles back into working position before knitting the next 2 rows. Knit to Row 232 (236) [240].

SHAPE ARMHOLE: ON EACH SIDE, bind off 3 sts. 2x, 2 sts. 2x, 1 st. 3x. (3 sts. 2x, 2 sts. 3x, 1 st. 3x). [3 sts. 3x, 2 sts. 3x, 1 st. 3x]. Knit to Row 280 (292) [300], bind off the center 13 sts., put the needles on the left side into holding position and complete the right half first.

* ON NECK SIDE, bind off 3 sts. 3x, 2 sts. 3x, 1 st. 4x and SHAPE SHOULDER after Row 300 (312) [320]. Bind off 3 sts. 2x, 4 sts. 5x. (4 sts. 6x, 5 sts. 1x). [4 sts. 3x, 5 sts. 4x].

Bring the needles on the left side into working position, knit 1 row to the left, turn the Row Counter back to 280 (292) [300] and complete the left half. Follow the instructions from *.

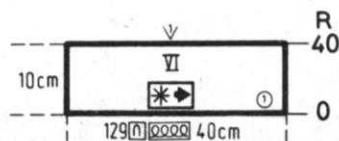
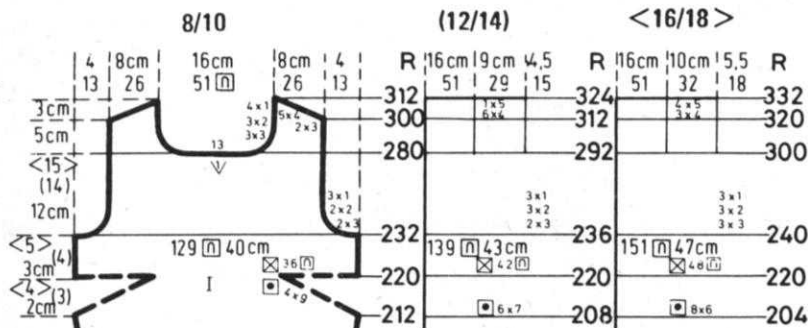

PULLOVER COLLAR: VI

Bring 129 needles into working position, set into MOCK RIB pattern, then cast on over the remaining needles in work. Knit to Row 40, then bind off.

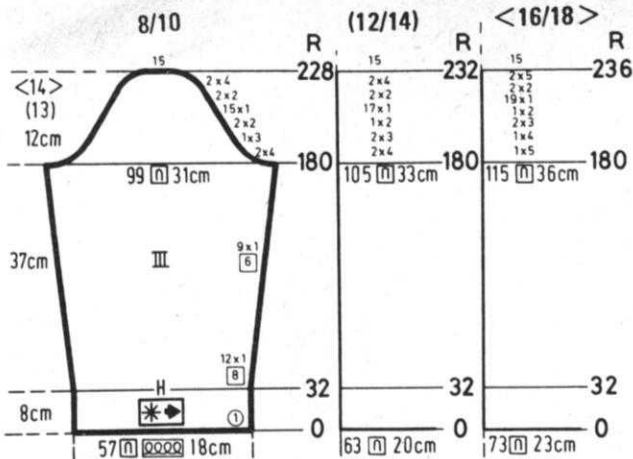

PULLOVER SLEEVE: III

Bring 57 (63) [73] needles into working position, set into **MOCK RIB PATTERN**, then cast on with color 1 over the remaining needles in work. Knit to Row 32.

ON EACH SIDE, increase 1 st. every 8th row 12x, every 6th row 9x. Knit to Row 180. **SHAPE CAP: ON EACH SIDE**, bind off 4 sts. 2x, 3 sts. 1x, 2 sts. 2x, 1 st. 15x, 2 sts. 2x, 4 sts. 2x. (4 sts. 2x, 3 sts. 2x, 2 sts. 1x, 1 st. 17x, 2 sts. 2x, 4 sts. 2x). [5 sts. 1x, 4 sts. 1x, 3 sts. 2x, 2 sts. 1x, 1 st. 19x, 2 sts. 2x, 5 sts. 2x]. After Row 228 (232) [236], bind off the remaining 15 sts.

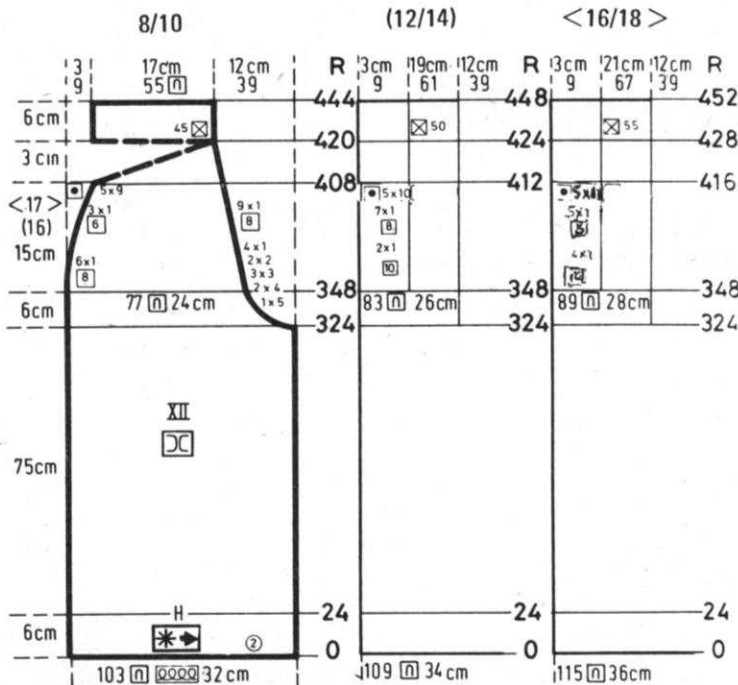

PANTS BACK: XII. Make 1, reverse 1.

Bring 103 (109) [115] needles into working position, set into **MOCK RIB PATTERN**, then cast on with color 2 over the remaining needles in work. Knit to Row 24, hang the hem and knit to Row 324. Begin the bind-offs (which are the same for all sizes) for the center back after Row 324 and begin the decreases for side edge after Row 348.

Bind off for the **CENTER BACK** 5 sts. 1x, 4 sts. 2x, 3 sts. 3x, 2 sts. 2x, 1 st. 4x, 1 st. every 8th row 9x. Decrease 1 st. **AT SIDE EDGE** every 8th row 6x, every 6th row 3x. (every 10th row 2x, every 8th row 7x). [every 10th row 4x, every 8th row 5x].

After Row 408 (412) [416], work **Short Rows**. **ON OPPOSITE SIDE OF CAM BOX**, put into holding position 9 (10) [11] sts. 5x. **ON OPPOSITE SIDE OF CAM BOX**, bring all the needles back into working position before knitting the next row. Knit to Row 444 (448) [452], then bind off all sts.

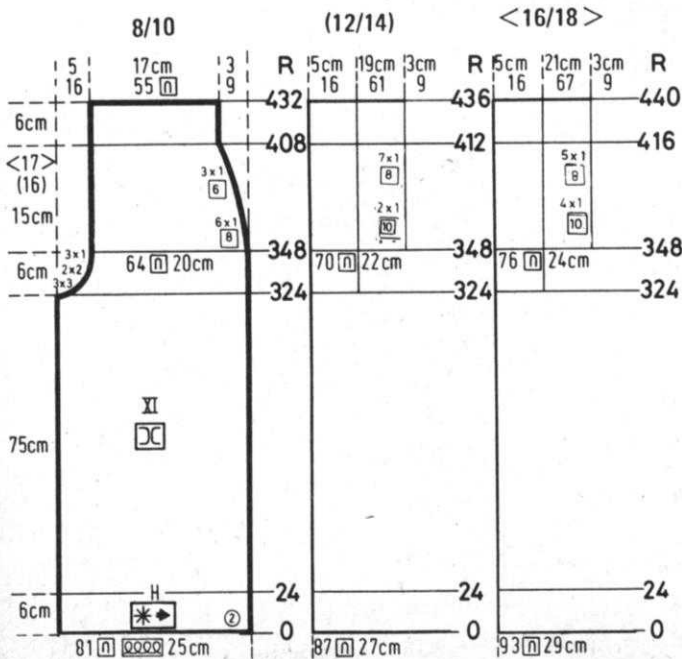

PANTS FRONT: XI Make 1, reverse 1.

Bring 81 (87) [93] needles into working position, set into **MOCK RIB PATTERN** then cast on with color 2 over the remaining needles in work. Knit to Row 24, hang the hem then knit to Row 324. Begin the bind-offs for the center front (which are the same for all sizes) and begin the decreases for side edge after Row 348.

Bind off the **CENTER FRONT**: 3 sts. 3x, 2 sts. 2x, 1 st. 3x. Decrease 1 st. at **SIDE EDGE**: every 8th row 6x, every 6th row 3x. (every 10th row 2x, every 8th row 7x). [every 10th row 4x, every 8th row 5x]. Knit to Row 432 (436) [440], then bind off.

DK 67

WOMAN'S DRESS AND COAT

SIZE: 10/12 (14/16) [18/20]
YARN: Sport Prima
 grams C1 950 1000 1050
 grams C2 350 350 350
 grams C3 150 150 150
TENSION: 7 to 9
GAUGE: 14 sts. 19 rows = 5 cm

Mock Rib Pattern as shown on Line Drawing with every 4th needle out of work. The empty needles DO count in the stitch gauge and instructions. The knit side is the right side.

FINISHING: See General Instructions. Single crochet around back neck opening of dress, then make a loop for one side and sew button to other side of opening. For the Loop Trim down front of Coat, around Hood and for the Cuffs, make a chain 4 cm long then work the Loop Crochet alternating the 3 colors (see front cover picture) and follow the Loop Crochet instructions same as DK 64 this issue. Follow the correct centimeter length for your size as shown on the Chart.

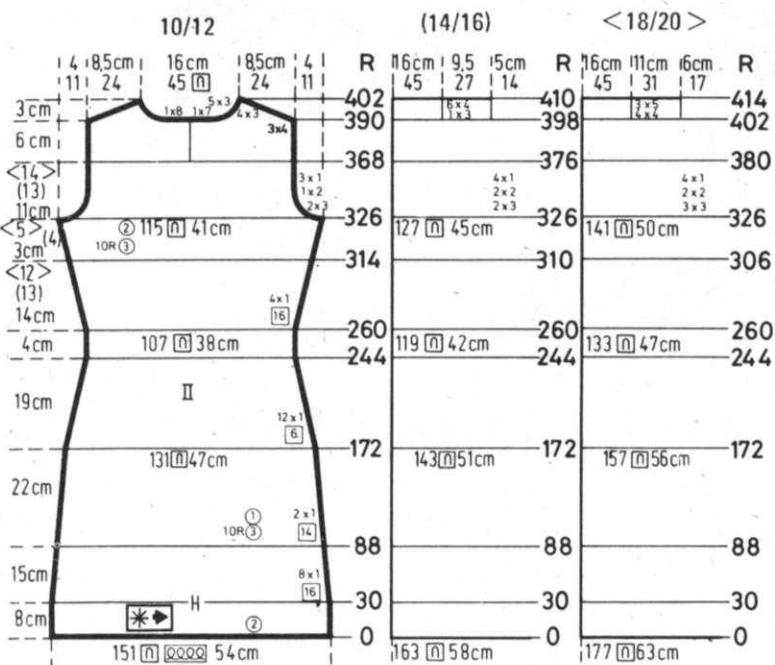

DRESS BACK: II

Bring 151 (163) [177] needles into working position, set into **MOCK RIB PATTERN** then cast on with color 2 over the remaining needles in work. Knit to Row 30, hang the hem and **ON EACH SIDE**, decrease 1 st. every 16th row 8x.

After Row 88, knit 10 rows with color 3, then continue with color 1 and **AT THE SAME TIME**, on each side, decrease 1 st. every 14th row 2x. After Row 172, **ON EACH SIDE**, decrease 1 st. every 6th row 12x. Knit to Row 260.

ON EACH SIDE, increase 1 st. every 16th row 4x, and after Row 314 (310) [306], knit 10 rows with color 3, then continue with row 2. After Row 326, **SHAPE ARMHOLE: ON EACH SIDE**, bind off 3 sts. 2x, 2 sts. 1x, 1 st. 3x. (3 sts. 2x, 2 sts. 2x, 1 st. 4x). [3 sts. 3x, 2 sts. 2x, 1 st. 4x].

After Row 368 (376) [380], divide in the center and put the needles on the left side into holding position and complete the right half first. *Knit to Row 390 (398) [402], divide in the center and put the needles on the left side into holding position and complete the right half first. *Knit to Row 390 (398) [402]. **SHAPE SHOULDER AND NECK AT THE SAME TIME.** Bind off **FOR SHOULDER:** 4 sts. 3x, 3 sts. 4x. (3 sts. 1x, 4 sts. 6x). [4 sts. 4x, 5 sts. 3x]. **FOR NECK: ALL SIZES:** 7 sts. 1x (8 for left side) 3 sts. 5x.

Bring the needles on the left into working position, knit 1 row to the left side, turn the Row Counter back to 390 (398) [402] and complete the left half. Follow the instructions from *.

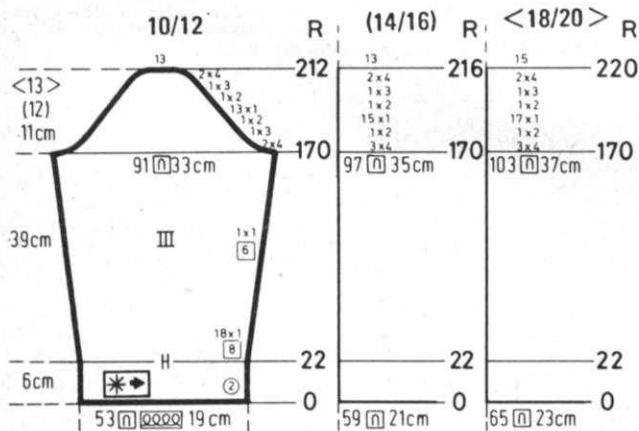

DRESS NECKBAND: VIII

Bring 103 needles into working position, then set into **MOCK RIB PATTERN**, cast on with color 2 over the remaining needles in work. Knit to Row 30, then bind off.

DRESS SLEEVE: III

Bring 53 (59) [65] needles into working position, set into **MOCK RIB PATTERN**, then cast on with color 2 over the remaining needles in work. Knit to Row 22, hang the hem. **ON EACH SIDE**, increase 1 st. every 8th row 18x, every 6th row 1x. Knit to Row 170.

SHAPE CAP: ON EACH SIDE, bind off 4 sts. 2x, 3 sts. 1x, 2 sts. 1x, 1 st. 13x, 2 sts. 1x, 3 sts. 1x, 4 sts. 2x. (4 sts. 3x, 2 sts. 1x, 1 st. 15x, 2 sts. 1x, 3 sts. 1x, 4 sts. 2x). [4 sts. 3x, 2 sts. 1x, 1 st. 17x, 2 sts. 1x, 3 sts. 1x, 4 sts. 2x]. After Row 212 (216) [220], bind off the remaining 13 (13) [15] sts.

DRESS FRONT: I

Work the front section the same as the back to Row 314 (310) [306], then work Short Rows for the Bust Darts. **ON OPPOSITE SIDE OF CAM BOX**, put into holding position 5 sts. 6x **ON EACH SIDE**. (4 sts. 8x **ON EACH SIDE**). [4 sts. 10x **ON EACH SIDE**]. Bring all the needles back into working position before knitting the next 2 rows and knit 10 rows with Color 3, then continue with color 2.

After Row 338 (342) [346], **SHAPE ARMHOLE: ON EACH SIDE**, bind off 3 sts. 2x, 2 sts. 1x, 1 st. 3x. (3 sts. 2x, 2 sts. 2x, 1 st. 4x). [3 sts. 3x, 2 sts. 2x, 1 st. 4x]. Knit to Row 384 (396) [404]. Bind off the center 13 sts., put the needles on the left side into holding position and complete the right half first.

***ON NECK SIDE**, bind off 3 sts. 2x, 2 sts. 3x, 1 st. 4x. **SHAPE SHOULDER** after Row 404 (416) [424]. Bind off 4 sts. 3x, 3 sts. 4x. (3 sts. 1x, 4 sts. 6x). [4 sts. 4x, 5 sts. 3x]. Bring the needles on the left into working position, knit 1 row to the left side, turn the Row Counter back to 384 (396) [404] and complete the left half. Follow the instructions from *.

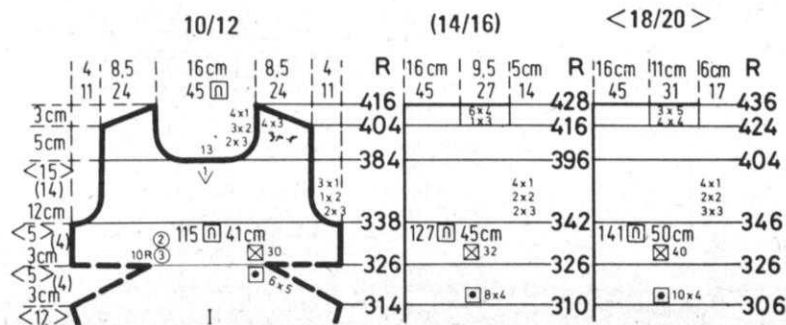

10/12

(14/16)

<18/20>

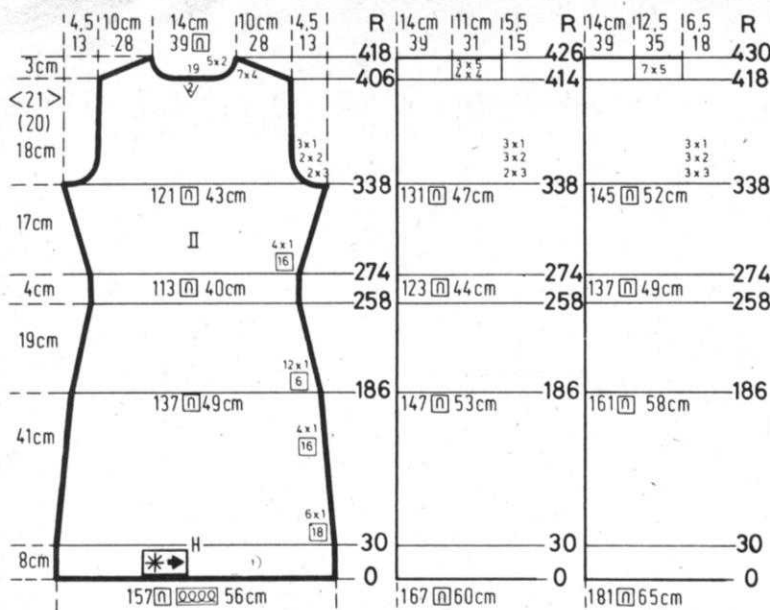

COAT BACK: II

Bring 157 (167) [181] needles into working position, set into MOCK RIB PATTERN, then cast on with color 1 over the remaining needles in work. Knit to Row 30, hang the hem.

ON EACH SIDE, decrease 1 st. every 18th row 6x, every 16th row 4x. After Row 186, decrease 1 st. every 6th row 12x. Knit to Row 274. ON EACH SIDE, increase 1 st. every 16th row 4x. Knit to Row 338.

SHAPE ARMHOLE: ON EACH SIDE, bind off 3 sts. 2x, 2 sts. 2x, 1 st. 3x. (3 sts. 2x, 2 sts. 3x, 1 st. 3x). [3 sts. 3x, 2 sts. 3x, 1 st. 3x]. Knit to Row 406 (414) [418]. Bind off the center 19 sts., put the needles on the left side into holding position and complete the right half first.

SHAPE SHOULDER AND NECK AT THE SAME TIME. *Bind off FOR SHOULDER: 4 sts. 7x. (4 sts. 4x, 5 sts. 2x). [5 sts. 7x]. FOR NECK: ALL SIZES, 2 sts. 5x. Bring the needles on the left into working position, knit 1 row, turn the Row Counter back to 406 (414) [418] and complete the left half. Follow the instructions from *.

10/12

(14/16)

<18/20>

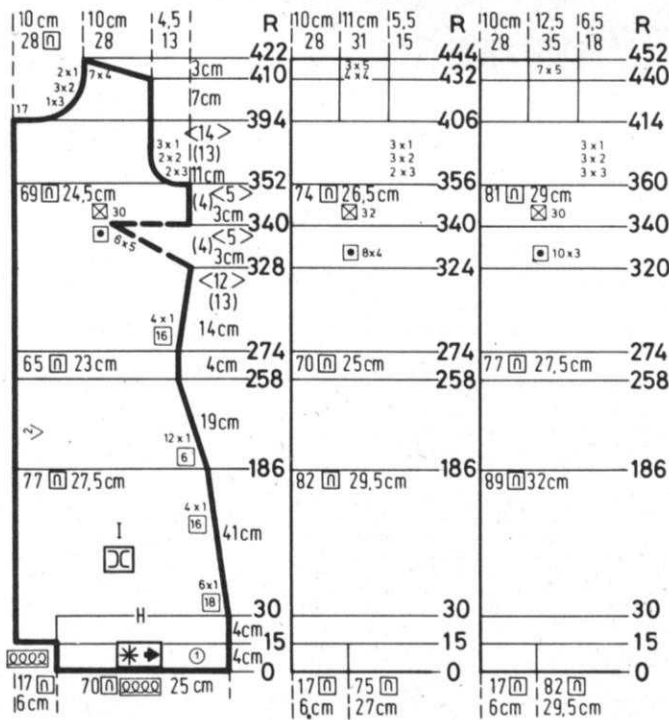

COAT FRONT: I Make 1, reverse 1.

Bring 70 (75) [82] needles into working position, set into MOCK RIB PATTERN, then cast on with color 1 over the remaining needles in work. Knit to Row 15, then cast on 17 sts. and knit to Row 30. Hang the original cast on sts. back onto the machine to form the hem.

ON SIDE EDGE, decrease 1 st. every 18th row 6x, every 16th row 4x. After Row 186, decrease 1 st. every 6th row 12x. Knit to Row 274. ON SIDE EDGE, increase 1 st. every 16th row 4x. Knit to Row 329 (325) [321], then work Short Rows for the Bust Dart. ON OPPOSITE SIDE OF CAM BOX, put into holding position 5 sts. 6x. (4 sts. 8x). [3 sts. 10x]. Bring all the needles back into working position before knitting the next row. Knit to Row 352 (356) [360].

SHAPE ARMHOLE: Bind off 3 sts. 2x, 2 sts. 2x, 1 st. 3x. (3 sts. 2x, 2 sts. 3x, 1 st. 3x). [3 sts. 3x, 2 sts. 3x, 1 st. 3x]. The Neck Bind-offs are the same for all sizes. After Row 395 (407) [415], ON NECK SIDE, bind off 17 sts., then bind off 3 sts. 1x, 2 sts. 3x, 1 st. 2x. AFTER Row 410 (432) [440], SHAPE SHOULDER. Bind off 4 sts. 7x. (4 sts. 4x, 5 sts. 3x). [5 sts. 7x].

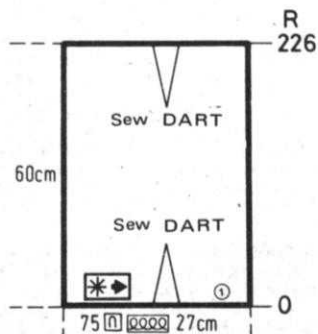
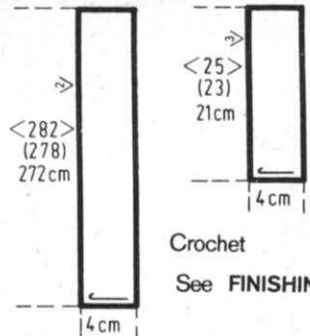

HOOD:

Bring 75 needles into working position, set into Pattern, then cast on with color 1 and knit to Row 226. Bind off.

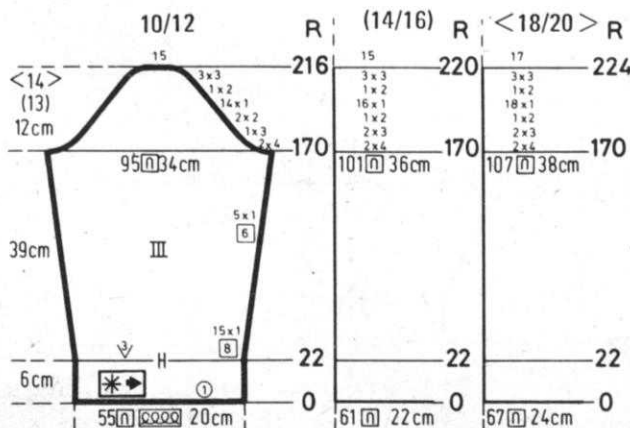

COAT SLEEVE: III

Bring 55 (61) [67] needles into working position, set into MOCK RIB PATTERN, then cast on with color 1 over the remaining needles in work. Knit to Row 22, hang the hem. ON EACH SIDE, increase 1 st. every 8th row 15x, every 6th row 5x.

After Row 170, SHAPE CAP: ON EACH SIDE, bind off 4 sts. 2x, 3 sts. 1x, 2 sts. 2x, 1 st. 14x, 2 sts. 1x, 3 sts. 3x. (4 sts. 2x, 3 sts. 2x, 2 sts. 1x, 1 st. 16x, 2 sts. 1x, 3 sts. 3x). [4 sts. 2x, 3 sts. 2x, 2 sts. 1x, 1 st. 18x, 2 sts. 1x, 3 sts. 3x]. After Row 216 (220) [224], bind off the remaining 15 (15) [17] sts.

DK 68

WOMAN'S DRESS

SIZE: 8/10 (12/14) [16/18]
 YARN: Allegro
 grams 450 500 550
 TENSION: 6 to 8
 GAUGE: 15 sts. 18 rows - 5 cm

The Dress is a Mock Rib with every 4th needle out of work. The empty needles ARE counted in the stitch gauge and the instructions. Stockinette stitch is used for the neck and sleeve bands. The knit side is the right side.

FINISHING: See General Instructions. For the Catch Stitch embroidery down the front of the dress, use 4 strands of yarn. Leave 9 ribs in the center, then over the next 13 sts. ON EACH SIDE work the Catch Stitch (see picture).

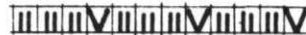
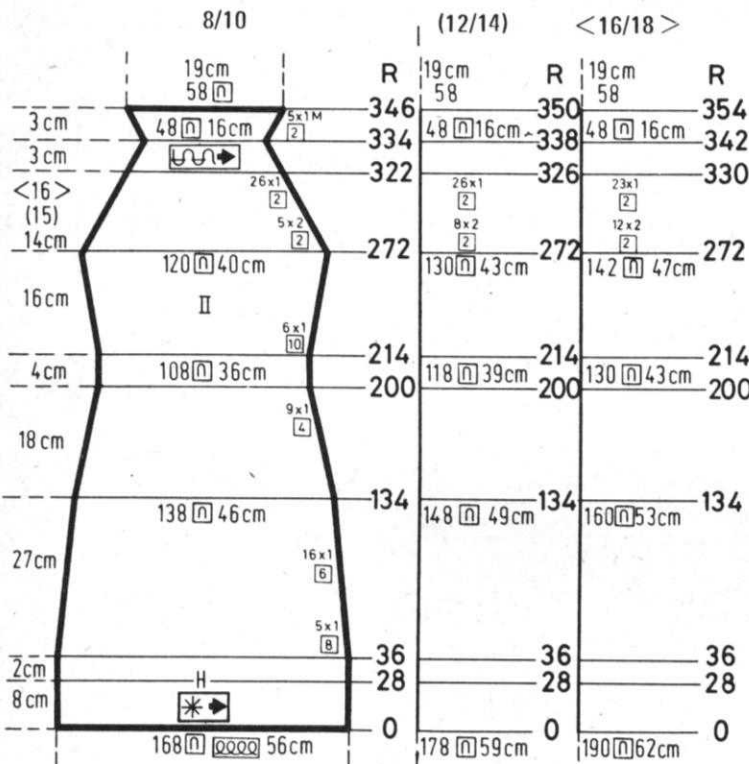
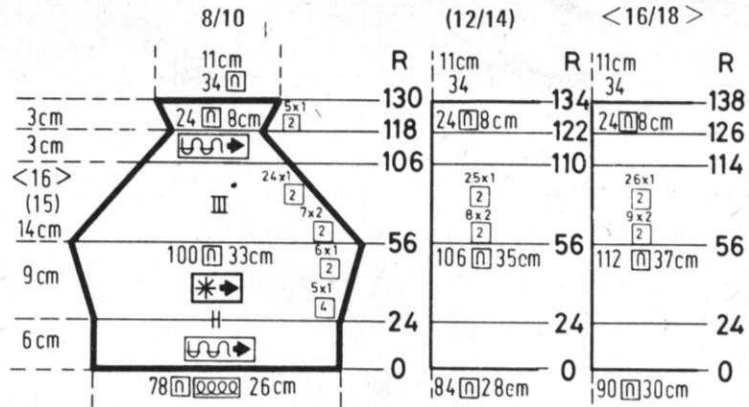

DRESS BACK: II

Bring 168 (178) [190] needles into working position, set into MOCK RIB PATTERN, then cast on over the remaining needles in work. Knit to Row 28, hang the hem. Knit to Row 36.

ON EACH SIDE, decrease 1 st. every 8th row 5x, every 6th row 16x, every 4th row 9x. Knit to Row 214. ON EACH SIDE, increase 1 st. every 10th row 6x.

After Row 272, SHAPE RAGLAN: ON EACH SIDE, decrease 2 sts. 5x, 1 st. 26x, change to Stockinette stitch after Row 322. (2 sts. 8x, 1 st. 26x, change to Stockinette stitch after Row 326). [2 sts. 12x, 1 st. 23x, change to Stockinette stitch after Row 330]. After Row 334 (338) [342], ON EACH SIDE, increase 1 st. every 2nd row 5x. After Row 346 (350) [364], bind off all sts.

FRONT: I

Work the front section the same as the back section to Row 262 (258) [254], then work Short Rows for the Bust Darts. ON OPPOSITE SIDE OF CAM BOX, put into holding position 10 sts. 3x ON EACH SIDE. (7 sts. 5x ON EACH SIDE). [6 sts. 6x ON EACH SIDE]. Bring all the needles back into working position before knitting the next 2 rows. Knit to Row 280 (282) [286].

SHAPE RAGLAN: ON EACH SIDE, decrease 2 sts. 5x, 1 st. 26x, change to Stockinette stitch after Row 330. (2 sts. 8x, 1 st. 25x, change to Stockinette stitch after Row 336). [2 sts. 12x, 1 st. 23x, change to Stockinette stitch after Row 344]. After Row 342 (348) [356], ON EACH SIDE, increase 1 st. every 2nd row 5x. After Row 354 (360) [368], bind off all sts.

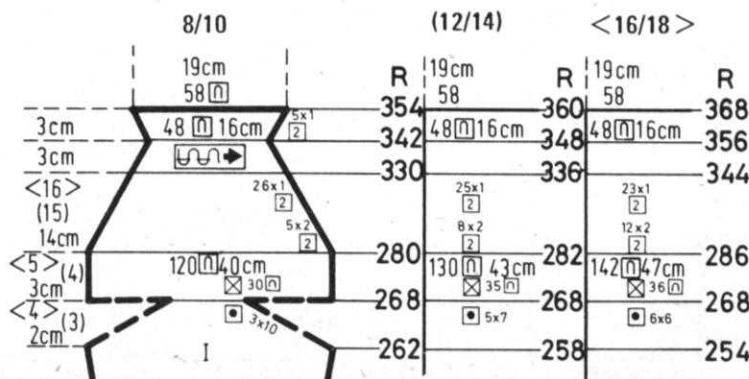

SLEEVE: III

Cast on 78 (84) [90] sts. and work Stockinette stitch to Row 24. Hang the hem, then change to the **MOCK RIB PATTERN**. ON EACH SIDE, increase 1 st. every 4th row 5x, every other row 6x.

After Row 56, **SHAPE RAGLAN**: ON EVERY OTHER ROW, ON EACH SIDE, decrease 2 sts. 7x, 1 st. 24x, change to Stockinette stitch after Row 106. (2 sts. 8x, 1 st. 25x, change to Stockinette stitch after Row 110). [2 sts. 9x, 1 st. 26x, change to Stockinette stitch after Row 114]. After Row 118 (122) [126], ON EACH SIDE, increase 1 st. every 2nd row 5x. After Row 130 (134) [138], bind off.

DK 69



WOMAN'S JACKET

SIZE: 8/10 (12/14) [16/18]
YARN: Crocus
 grams 600 650 700
TENSION: 6 to 8
GAUGE: 16 sts. 20 rows = 5 cm

Mock Rib with every 4th needle out of work. The empty needles ARE counted in the stitch gauge and the instructions. Bands are in Stockinette stitch. The knit side is the right side.

FINISHING: See General Instructions. Work 1 row single crochet down the front fold and around the edge of Collar.

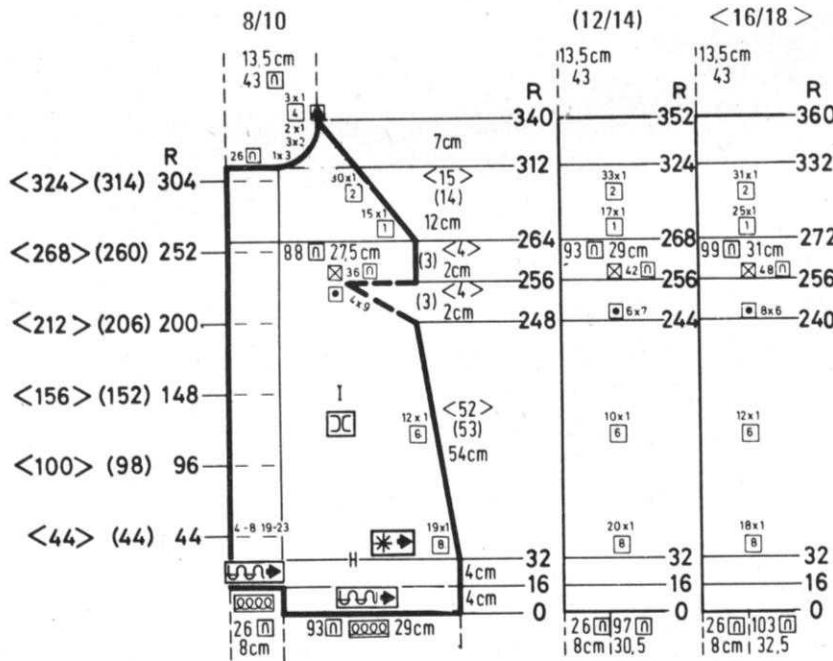
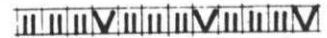

FRONT: I Make 1, reverse 1 and omit the buttonholes.

Cast on 93 (97) [103] sts. and work Stockinette stitch to Row 16, then cast on 26 sts. on the LEFT (right for second section) side and knit to Row 32. Hang the original cast on sts. back onto the machine to form the hem, then set into **MOCK RIB PATTERN**.

ON FRONT EDGE, make **BUTTON-HOLES** over needles 4 to 8 and 19 to 23 counting from the left, after ROWS GIVEN FOR YOUR SIZE, AND AT THE SAME TIME, ON SIDE EDGE, decrease 1 st. every 8th row 19x, every 6th row 12x. (every 8th row 20x, every 6th row 10x). [every 8th row 18x, every 6th row 12x]. Knit to Row 249 (245) [241], then work Short Rows.

ON OPPOSITE SIDE OF CAM BOX, put into holding position, 9 sts. 4x. (7 sts. 6x). [6 sts. 8x]. Bring all the needles back into working position before knitting the next row, then knit to Row 264 (268) [272].

SHAPE RAGLAN: ON ARM SIDE, decrease 1 st. EVERY ROW 15x, every 2nd row 30x. **SHAPE NECK AFTER Row 312.** (EVERY ROW 17x, every 2nd row 33x. **SHAPE NECK AFTER Row 324.** [EVERY ROW 25x, every 2nd row 31x. **SHAPE NECK AFTER Row 332.** ON NECK SIDE, bind off 26 sts., then bind off 3 sts. 1x, 2 sts. 3x, 1 st. 2x, and every 4th row, 1 st. 3x.

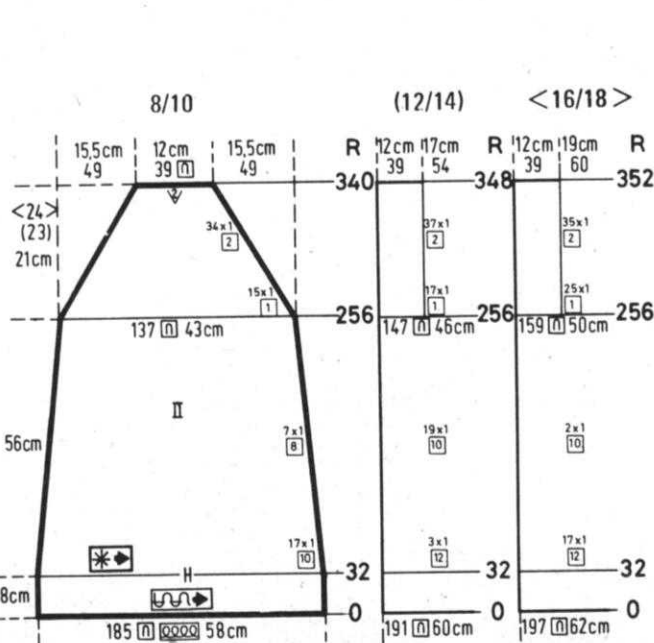

BACK: II

Cast on 185 (191) [197] sts. and work Stockinette stitch to Row 32. Hang the hem, then change to **MOCK RIB PATTERN**. ON EACH SIDE, decrease 1 st. every 10th row, 17x, every 8th row 7x. (every 12th row 3x, every 10th row 19x). [every 12th row 17x, every 10th row 2x].

After Row 256, **SHAPE RAGLAN:** ON EACH SIDE, decrease 1 st. EVERY ROW 15x, every 2nd row 34x. (EVERY ROW 17x, every 2nd row 37x). [EVERY ROW 25x, every 2nd row 35x]. After Row 340 (348) [352], bind off the remaining 39 sts.

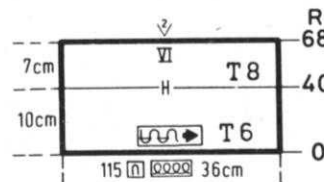

COLLAR: VI

Cast on 115 sts. and work Stockinette stitch. With Tension 8, knit to Row 40. With Tension 6, knit to Row 68, then bind off all sts.

Continued

DK 70

WOMAN'S PANTSUIT

SIZE: 10/12 (14/16) [18/20]
 YARN: Beatrice
 grams 1200 1250 1300
 TENSION:
 Stock.: 6 to 8
 Pattern: 8 to 10
 GAUGE:
 Stock.: 16 sts. 22 rows = 5 cm
 Pattern: 13 sts. 34 rows = 5 cm

PANTS: Stockinette stitch. TOP: Holding Position Design according to the Line Drawing. KNITTING machine owners use Wheel No. 3. Bands: Stockinette stitch. The purl side of pattern is the right side.

FINISHING: See General Instructions. Ease the extra rows marked with Contrast yarn at Bustline of front section.

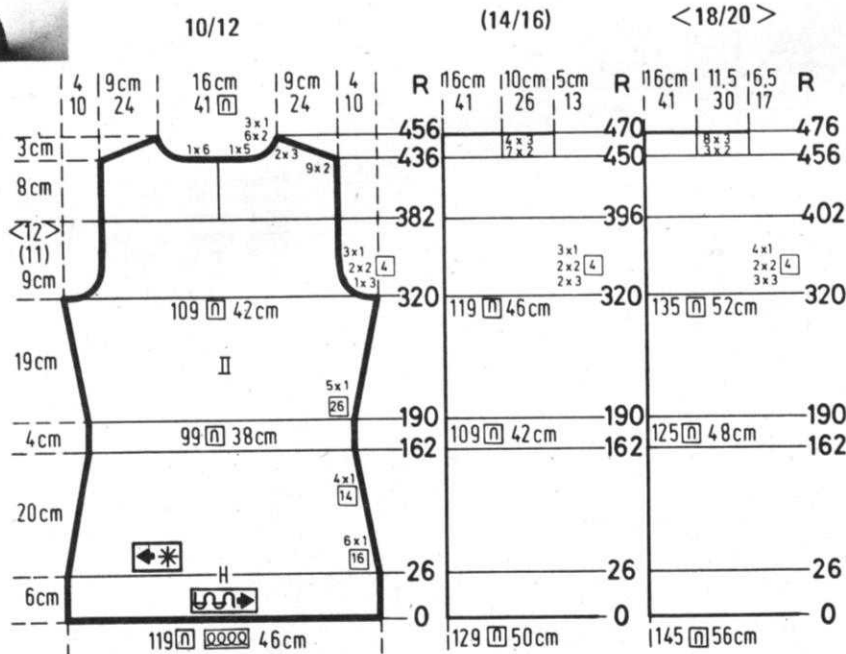
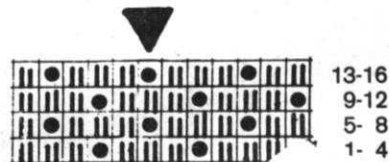

BACK: II

Cast on 119 [129] [145] sts. and work Stockinette stitch to Row 26. Hang the hem, then change to the Holding Position Design. ON EACH SIDE, decrease 1 st. every 16th row 6x, every 14th row 4x. Knit to Row 190. ON EACH SIDE, increase 1 st. every 26th row 5x.

After Row 320, SHAPE ARMHOLE: ON EACH SIDE ON EVERY 4th ROW bind off 3 sts. 1x, 2 sts. 2x, 1 st. 3x. (3 sts. 2x, 2 sts. 2x, 1 st. 3x). [3 sts. 3x, 2 sts. 2x, 1 st. 4x]. After Row 382 (396) [402], divide in the center and put the needles on the left side into holding position and complete the right half first.

*Knit to Row 436 (450) [456]. SHAPE SHOULDER AND NECK AT THE SAME TIME. Bind off FOR SHOULDER: 2 sts. 9x, 3 sts. 2x. (2 sts. 7x, 3 sts. 4x). [2 sts. 3x, 3 sts. 8x]. FOR NECK: SAME FOR ALL SIZES: 5 sts. 1x (6 for left half). 2 sts. 6x, 1 st. 3x. Bring the needles on the left into working position, knit 1 row in Pattern to the left side, turn the Row Counter back to 382 (396) [402] and complete the left half. Follow the instructions from *.

FRONT: I

Work the front section the same as the back section to Row 298 (292) [286]. Mark the end needle on each side, by tying a small piece of contrast yarn on the end needles. Knit to Row 312 and mark the end needle on each side again. Knit even to Row 334 (340) [346].

SHAPE ARMHOLE: ON EACH SIDE, ON EVERY 4th ROW, bind off 3 sts. 1x, 2 sts. 2x, 1 st. 3x. (3 sts. 2x, 2 sts. 2x, 1 st. 3x). [3 sts. 3x, 2 sts. 2x, 1 st. 4x]. Knit to Row 416 (428) [440]. Bind off the center 11 sts., put the needles on the left side into holding position and complete the right half first.

*ON NECK SIDE, ON EVERY 4th row, bind off 3 sts. 2x, 2 sts. 3x, 1 st. 3x, and AT THE SAME TIME, after Row 450 (462) [474], SHAPE SHOULDER by binding off 2 sts. 9x, 3 sts. 2x. (2 sts. 7x, 3 sts. 4x). [2 sts. 3x, 3 sts. 8x]. Bring the needles on the left into working position, knit 1 row in Pattern to the left side, turn the Row Counter back to 416 (428) [440] and complete the left half. Follow the instructions from *.

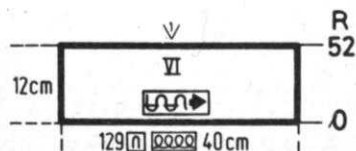
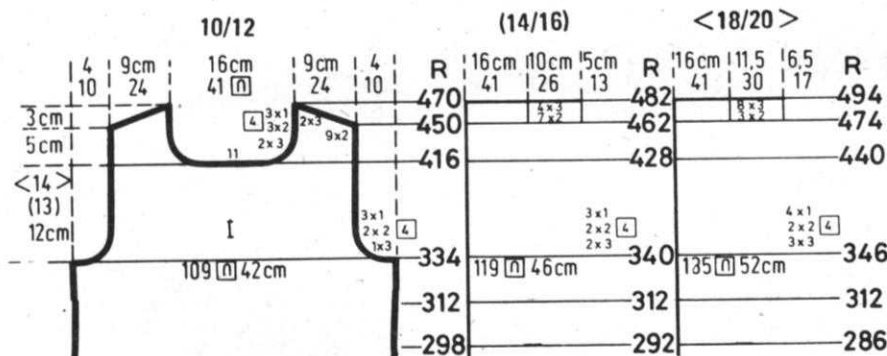

COLLAR: VI

Cast on 129 sts. and work 52 rows Stockinette stitch, then bind off.

Continued

BE SURE TO NOTIFY US IMMEDIATELY OF ANY CHANGE OF ADDRESS. THE POST OFFICE WILL NOT FORWARD YOUR MAGAZINE TO YOU.

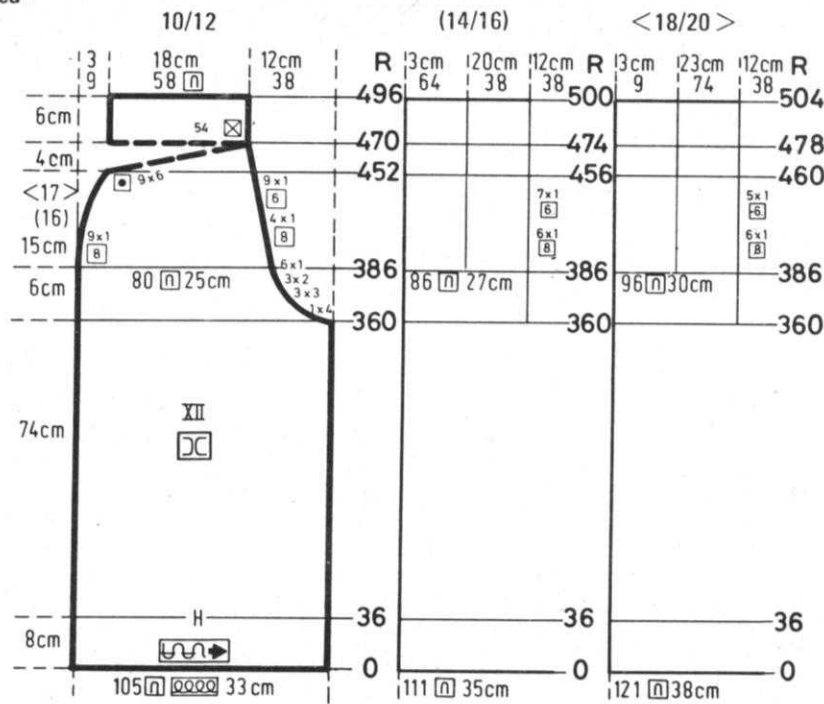

PANTS BACK: XII Make 1, reverse 1. Cast on 105 (111) [121] sts. and work Stockinette stitch. Knit to Row 36, hang the hem and knit to Row 360.

FOR CENTER BACK, bind off 4 sts. 1x, 3 sts. 3x, 2 sts. 3x, 1 st. 6x. After Row 386, at side edge, decrease 1 st. every 8th row 9x and **AT THE SAME TIME,** at **CENTER BACK,** decrease 1 st. every 8th row 4x (6x) [6x], every 6th row 9x (7x) [5x].

After Row 452 (456) [460], work Short Rows. **ON OPPOSITE SIDE OF CAM BOX,** put into holding position 6 sts. 9x, then bring all the needles back into working position before knitting the next row. Knit to Row 496 (500) [504], then bind off 58 (64) [74] sts.

DK 71

WOMAN'S PANTSUIT

SIZE: 12/14 (16/18) [20/22]

YARN: Beatrice

grams 900 950 1000

TENSION: 6 to 8

GAUGE: St

Stock: 15 sts. 22 rows = 5 cm

Pattern: 15 sts. 20 rows = 5 cm

A Holding Position Design with needles out of work according to the Line Drawing. The empty needles ARE counted in

the stitch gauge and instructions. The purl side is the right side of Pattern. **KNITTING** machine owners use the Adjustable Needle Selector. Bands: Stockinette stitch on the knit side.

FINISHING: See General Instructions. Ease the extra rows marked with Contrast yarn at Bustline of front section. Single crochet around back neck opening, then sew in a zipper or you can use a button on one side and loop on the other side.

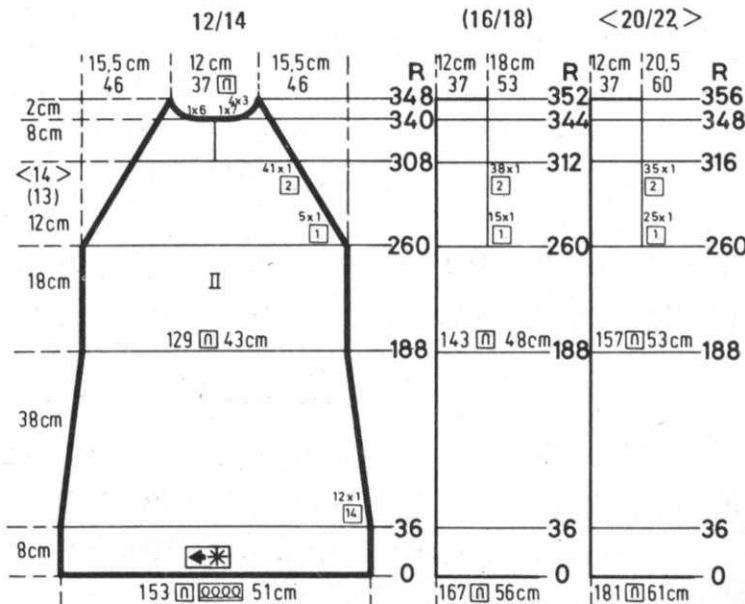

PULLOVER BACK: II

Bring 153 (167) [181] needles into working position, set into Pattern, then cast on over the remaining needles in work. Continue in Holding Position Design. After Row 36, **ON EACH SIDE,** decrease 1 st. every 14th row 12x. Knit to Row 260.

SHAPE RAGLAN: ON EACH SIDE, decrease 1 st. **EVERY ROW** 5x (15x) [25x], then **EVERY 2nd Row** 41x (38x) [35x] **AND AFTER ROW 308** (312) [316], divide in the center and put the needles on the left side into holding position and complete the right half first.

*Knit to Row 341 (345) [349], continuing the raglan shaping. **SHAPE NECK:** Bind off 7 sts. 1x (6 for left half), 3 sts. 4x. Bring the needles on the left into working position, knit 1 row in Pattern to the left side, turn the Row Counter back to 308 (312) [316] and complete the left half. Follow the instruction from *.

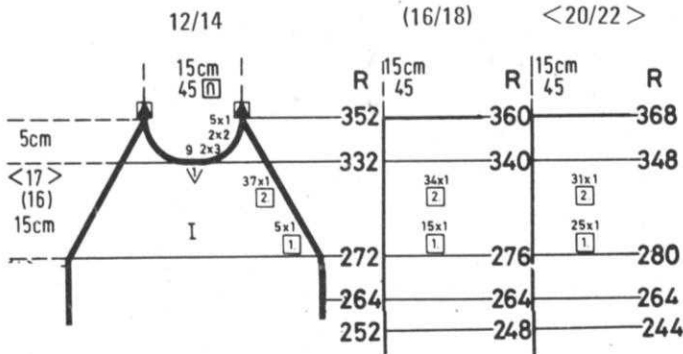

PULLOVER FRONT: I

Knit the FRONT section the same as the back to Row 252 (248) [244]. Mark the end needle ON EACH SIDE, by tying a piece of contract yarn to the end st. Knit to Row 264 and mark each end st. as you did before. Knit to Row 272 (276) [280].

SHAPE RAGLAN: ON EACH SIDE, decrease 1 st. EVERY ROW 5x (15x) [25x], then ON EVERY 2nd ROW 1 st. 37x (34x) [31x] AND AT THE SAME TIME after Row 332 (340) [348], bind off the center 9 sts., put the needles on the left side into holding position and complete the right half first.

*ON NECK SIDE, bind off 3 sts. 2x, 2 sts. 2x, 1 st. 5x. Bring the needles on the left into working position, knit 1 row in Pattern to the left side, turn the Row Counter back to 332 (340) [348] and complete the left half. Follow the instructions from *, continuing the Raglan decreases.

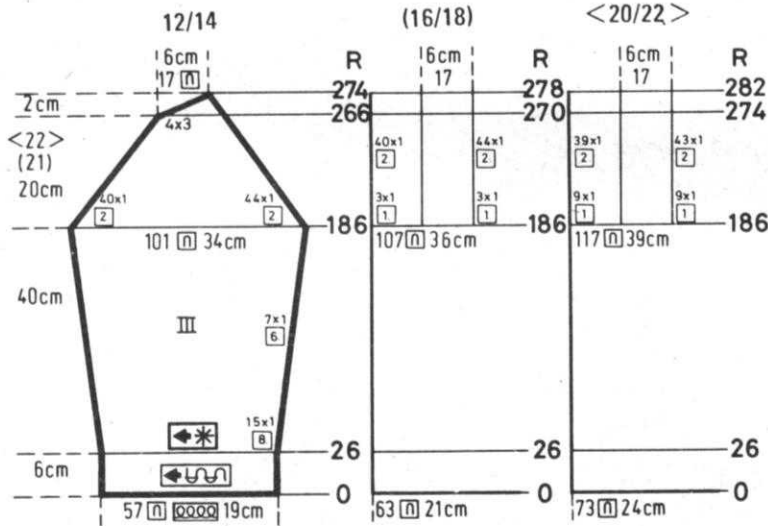

SLEEVE: III

Cast on 57 (63) [73] sts. and work Stockinette stitch to Row 26. Change to Pattern. ON EACH SIDE, increase 1 st. every 8th row 15x, every 6th row 7x. Knit to Row 186.

SHAPE RAGLAN: ON EVERY 2nd row, ON CAM BOX SIDE, decrease 1 st. 44x and ON OPPOSITE SIDE OF CAM BOX, ON EVERY 2nd Row, decrease 1 st. 40x. (ON EACH SIDE ON EVERY ROW, decrease 1 st. 3x, then ON CAM BOX SIDE, decrease 1 st. every 2nd row 44x and ON OPPOSITE SIDE OF CAM BOX, decrease 1 st. every 2nd row 40x). [ON EACH SIDE ON EVERY ROW, decrease 1 st. 9x, then ON CAM BOX SIDE, decrease 1 st. every 2nd row 43x and ON OPPOSITE SIDE OF CAM BOX, on every 2nd row, decrease 1 st. 39x].

After Row 266 (270) [274], work Short Rows. ON OPPOSITE SIDE OF CAM BOX, put into holding position 3 sts. 4x. After Row 274 (278) [282], bring all the needles back into working position and bind off. Work the second sleeve with reverse shaping.

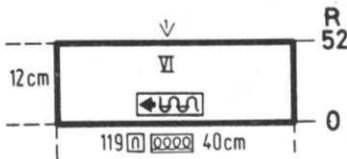

COLLAR: VI

Cast on 119 sts. and work 52 rows Stockinette stitch, then bind off.

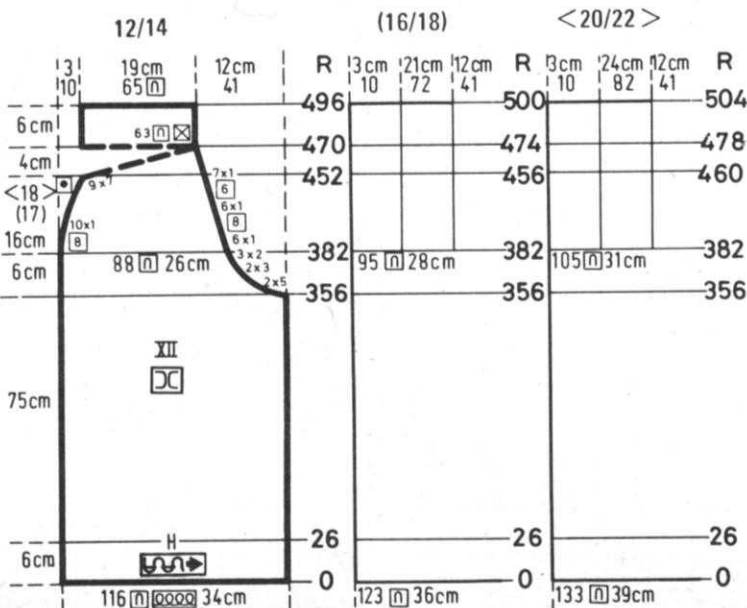

PANTS BACK: XII Make 1, reverse 1.

Cast on 116 (123) [133] sts. and work Stockinette stitch. Knit to Row 26, hang the hem, then knit to Row 356. FOR CENTER BACK, bind off 5 sts. 2x, 3 sts. 2x, 2 sts. 1x, 2 st. 6x, 1 st. every 8th row 6x, every 6th row 7x, AND AT THE SAME TIME, after Row 382, decrease 1 st. ON SIDE EDGE every 8th row 10x. After Row 452 (456) [460], work Short Rows.

ON OPPOSITE SIDE OF CAM BOX, put into holding position 7 sts. 9x. Bring all the needles back into working position before knitting the next row, then knit to Row 496 (500) [504] and bind off the remaining 65 (72) [82] sts.

Continued

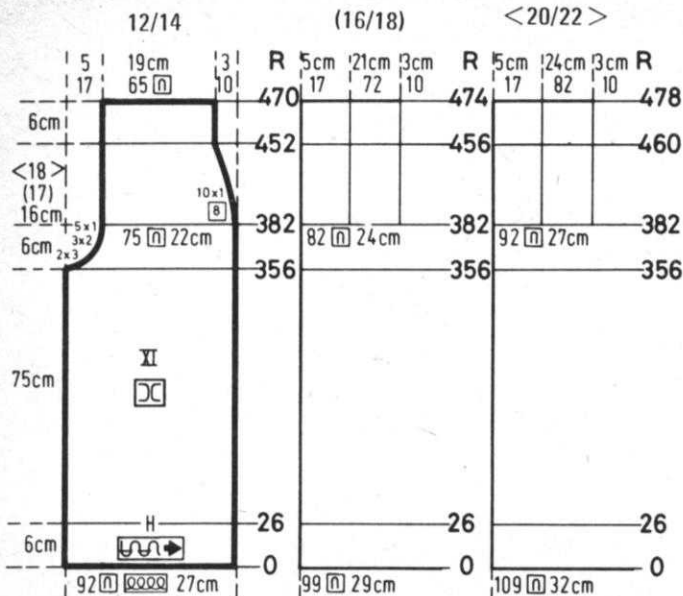

PANTS FRONT: XI Make 1, reverse 1.
 Cast on 92 (99) [109] sts. and work Stockinette stitch. Knit to Row 26, then hang the hem and knit to Row 357. FOR CENTER FRONT, bind off 3 sts. 2x, 2 sts. 3x, 1 st. 5x AND AT THE SAME TIME, after Row 382, decrease 1 st. ON SIDE EDGE every 8th row 10x. Knit to Row 470 (474) [478], then bind off 65 (72) [82] sts.

DK 72

WOMAN'S PANTS AND VEST

SIZE: 7/8 (10/12) [14/16]
 YARN: Crocus
 grams 950 1000 1050
 TENSION: 7 to 9
 GAUGE: 16 sts. 21 rows = 5 cm

Pants: Stockinette stitch. Vest: Holding Position Design with out of work needles that ARE counted in the stitch gauge and instructions. Follow the Line Drawing. KNITTING machine owners, use the Adjustable Needle Selector. The knit side is the right side. Bands are Stockinette stitch.

FINISHING: See General Instructions. Sew on Pockets (see Picture).

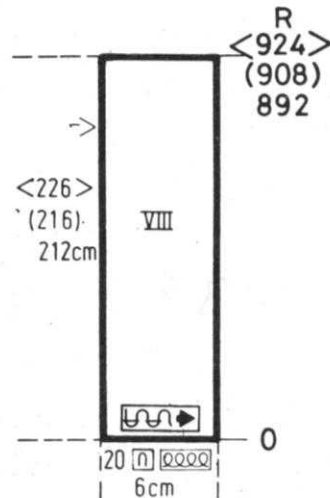

FRONT AND NECK BAND: VIII
 Cast on 20 sts. and work 892 (908) [924] rows Stockinette stitch, then bind off.

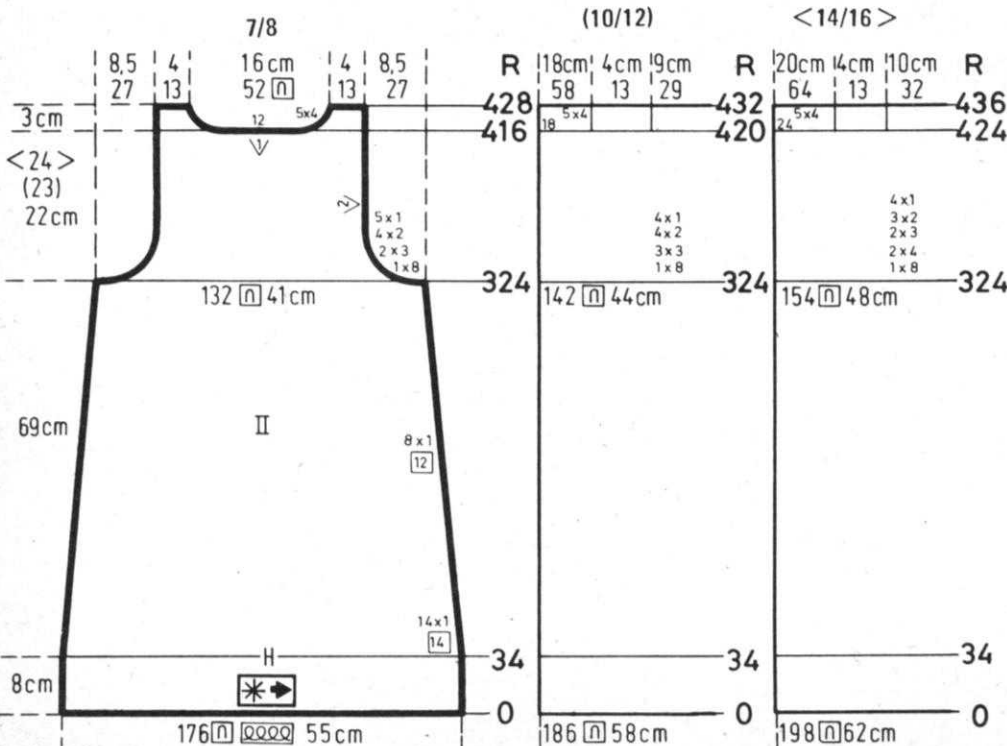

VEST BACK: II
 Bring 176 (186) [198] needles into working position, set into Pattern, then cast on over the remaining needles in work. Knit in Pattern. After Row 34, hang the hem. ON EACH SIDE, decrease 1 st. every 14th row 14x, every 12th row 8x.

After Row 324, SHAPE ARMHOLE: ON EACH SIDE, bind off 8 sts. 1x, 3 sts. 2x, 2 sts. 4x, 1 st. 5x. [8 sts. 1x, 3 sts. 3x, 2 sts. 4x, 1 st. 4x]. [8 sts. 1x, 4 sts. 2x, 3 sts. 2x, 2 sts. 3x, 1 st. 4x]. Knit to Row 416 (420) [424]. Bind off the center 12 (18) [24] sts., put the needles on the left side into holding position and complete the right half first.

*ON NECK SIDE, bind off 4 sts. 5x. After Row 428 (432) [436], bind off the remaining 13 sts. Bring the needles on the left into working position, knit 1 row in Pattern to the left side, turn the Row Counter back to 416 (420) [424] and complete the right half. Follow the instructions from *.

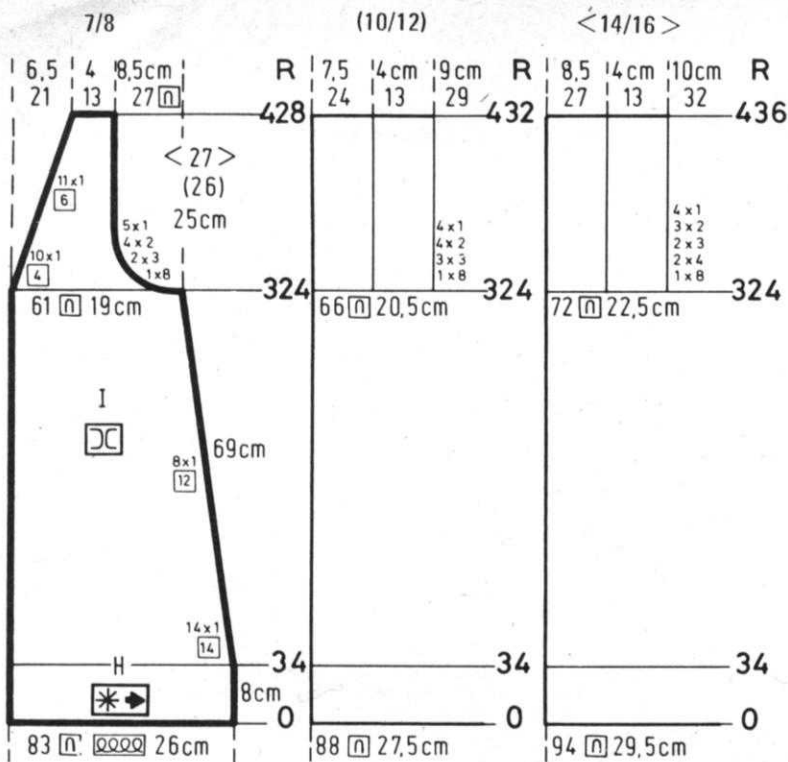

VEST FRONT: I Make 1, reverse 1.

Bring 83 (88) [94] needles into working position, set into Pattern, then cast on over the remaining needles in work. Knit in Pattern. After Row 34, hang the hem. ON SIDE EDGE, decrease 1 st. every 14th row 14x, every 12th row 8x. Knit to Row 324.

SHAPE ARMHOLE AND NECK AT THE SAME TIME: ON NECK SIDE for all sizes, decrease 1 st. every 4th row 10x, every 6th row 11x. FOR ARMHOLE, bind off 8 sts. 1x, 3 sts. 2x, 2 sts. 4x, 1 st. 5x. (8 sts. 1x, 3 sts. 3x, 2 sts. 4x, 1 st. 4x). [8 sts. 1x, 4 sts. 2x, 3 sts. 2x, 2 sts. 3x, 1 st. 4x]. After Row 428 (432) [436], bind off the remaining 13 sts.

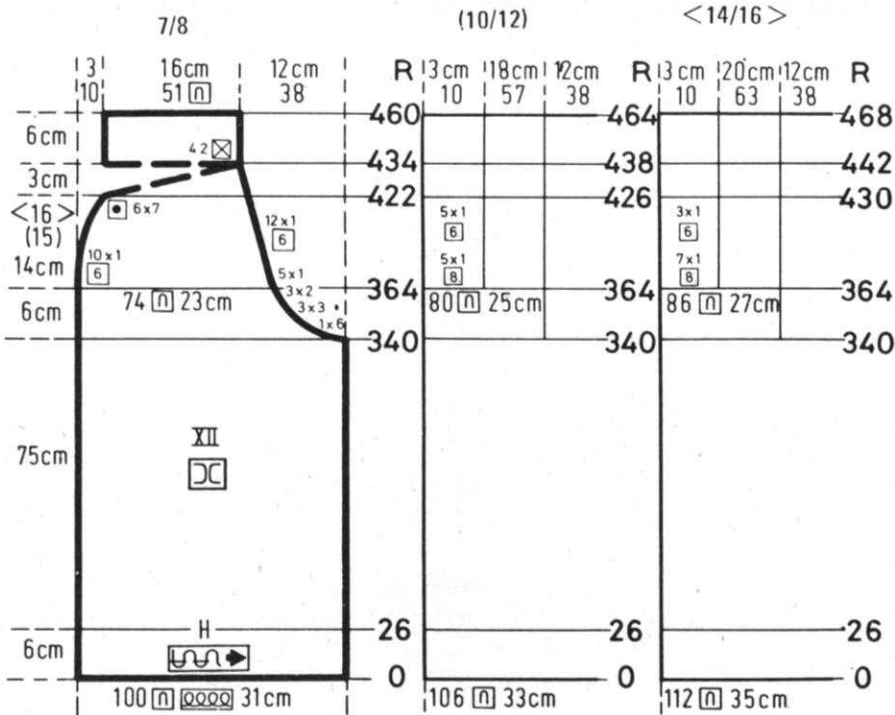

PANTS BACK: XII Make 1, reverse 1.

Cast on 100 (106) [112] sts. and work Stockinette stitch. After Row 26, hang the hem and knit even to Row 340.

FOR CENTER BACK, bind off 6 sts. 1x, 3 sts. 3x, 2 sts. 3x, 1 st. 5x, then every 6th row 1 st. 12x AND AT THE SAME TIME after Row 364, ON SIDE EDGE, decrease 1 st. every 6th row 10x. (every 8th row 5x, every 6th row 5x). [every 8th row 7x, every 6th row 3x]. After Row 422 (426) [430], work Short Rows.

ON OPPOSITE SIDE OF CAM BOX, put into holding position 7 sts. 6x. Bring all the needles back into working position before knitting the next row. After Row 460 (464) [468], bind off the remaining 51 (57) [63] sts.

R ARMBANDS: VIII

Cast on 167 (173) [179] sts. and work Stockinette stitch. ON EACH SIDE, on every 2nd row, decrease 2 sts. 6x, then increase 2 sts. 6x. After Row 26, bind off all sts.

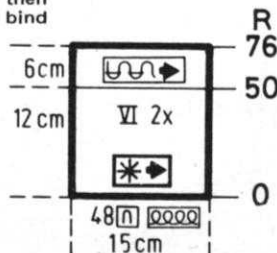
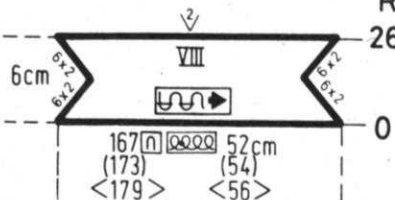

R 76

50 POCKETS: VI Make 2.

Bring 48 needles into working position, set into Pattern, then cast on over the remaining needles in work. Knit in Pattern to Row 50, then change to Stockinette stitch and knit to Row 76. Bind off.

Continued

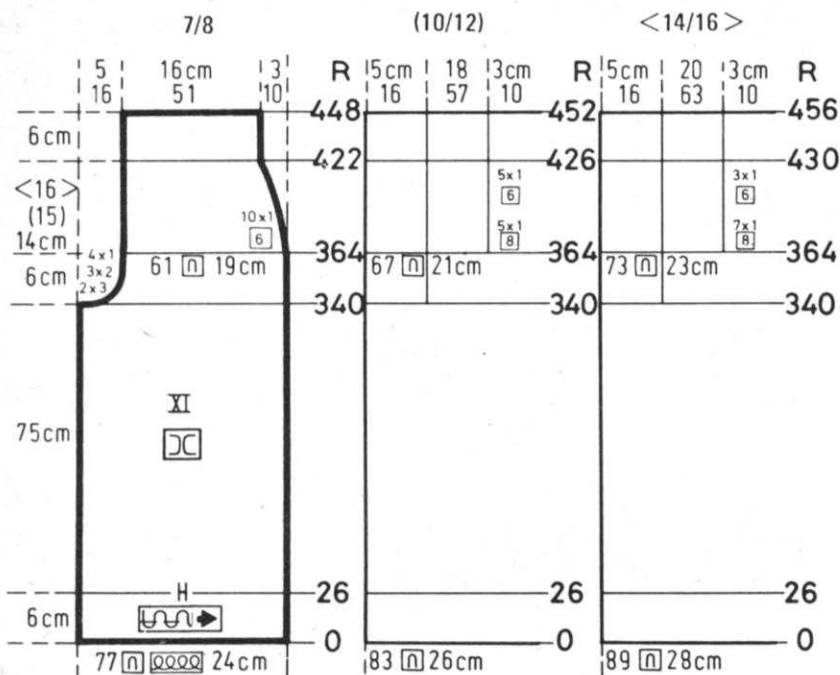

PANTS FRONT: XI Make 1, reverse 1.
Cast on 77 (83) [89] sts. and work Stockinette stitch. After Row 26, hang the hem. Knit to Row 341.

FOR CENTER FRONT, bind off 3 sts. 2x, 2 sts. 3x, 1 st. 4x. After Row 364, **ON SIDE EDGE,** decrease 1 st. every 6th row 10x. (every 8th row 5x, every 6th row 5x). [every 8th row 7x, every 6th row 3x]. Knit to Row 448 (452) [456], then bind off the remaining 51 (57) [63] sts.

DK 73

WOMAN'S LONG VEST

SIZE: 7/8 (10/12) [14/16]
YARN: Amore
grams 600 650 700
TENSION: 7 to 9
GAUGE:
Stock: 15 sts. 21 rows = 5 cm
Pattern: 15 sts. 26 rows = 5 cm

Holding Position Design with needles out of work according to the Line Drawing. The empty needles ARE counted in the stitch gauge and instructions. The Purl side of Pattern is the right side. **KNIT-KING** machine owners, use the Adjustable Needle Selector. Bands: Stockinette stitch on the Knit side.

FINISHING: See General Instructions. Attach Fringe to lower edge of Vest. See General Instructions.

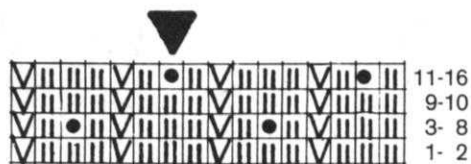
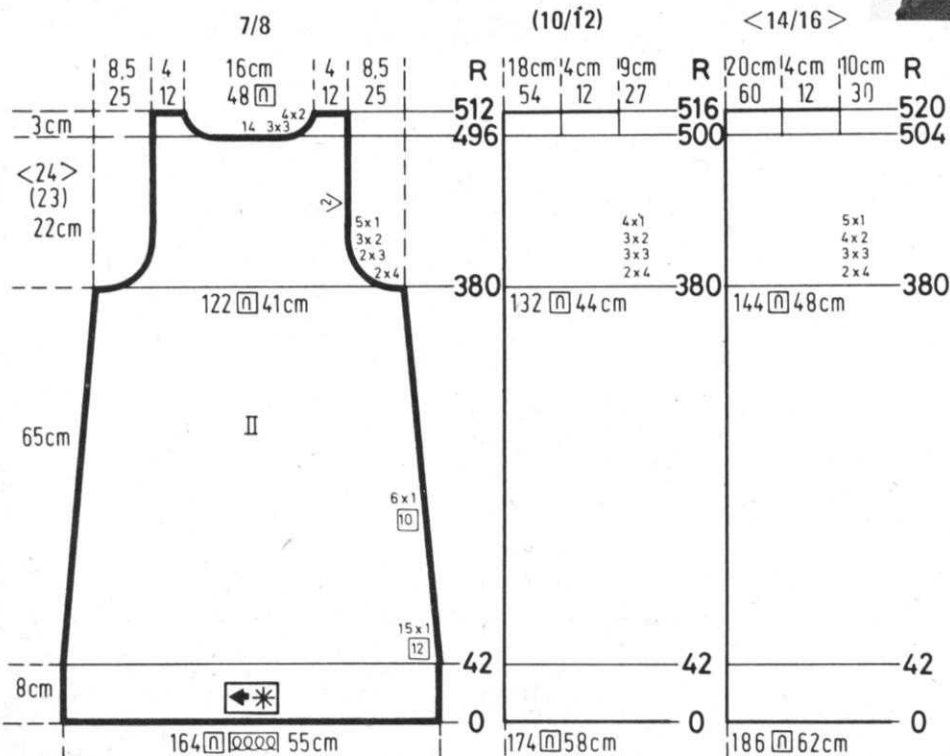

VEST BACK: II

Bring 164 (174) [186] needles into working position, set into pattern, then cast on over the remaining needles in work. Knit in Pattern. After Row 42, hang the hem. **ON EACH SIDE,** decrease 1 st. every 12th row 15x, every 10th row 6x. Knit to Row 380.

SHAPE ARMHOLE: ON EACH SIDE, bind off 4 sts. 2x, 3 sts. 2x, 2 sts. 3x, 1 st. 5x. (4 sts. 2x, 3 sts. 3x, 2 sts. 3x, 1 st. 4x). [4 sts. 2x, 3 sts. 3x, 2 sts. 4x, 1 st. 5x]. Knit to Row 496 (500) [504], bind off the center 14 sts., put the needles on the left side into holding position and complete the right half first.

***ON NECK SIDE,** bind off 3 sts. 3x, 2 sts. 4x. After Row 512 (516) [520], bind off the remaining 12 sts. Bring the needles on the left into working position, knit 1 row in Pattern to the left side, turn the Row Counter back to 496 (500) [504] and complete the left half. Follow the instructions from *.

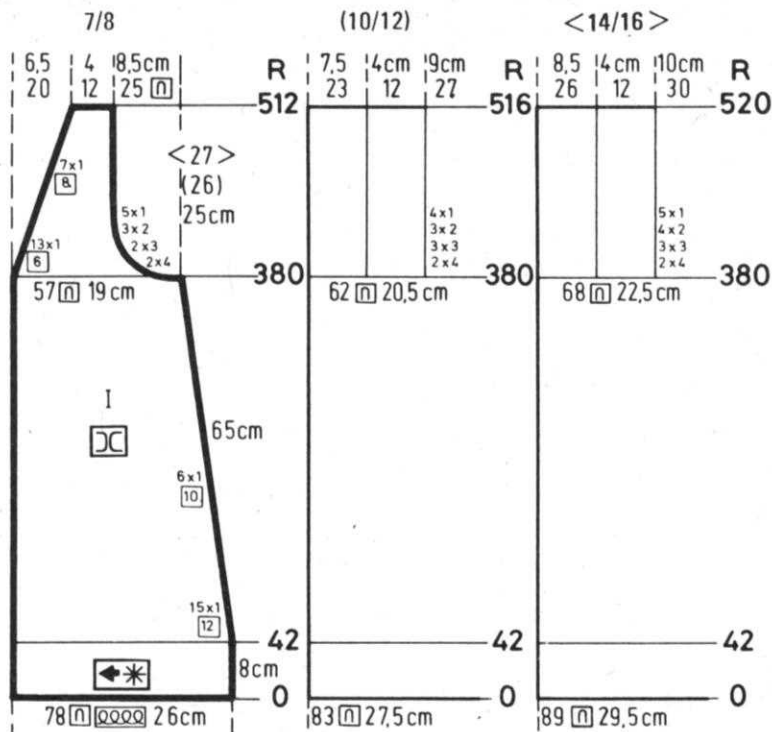

VEST FRONT: I Make 1, reverse 1.

Bring 78 (83) [89] needles into working position, set into Pattern, then cast on over the remaining needles in work. Knit in Pattern. After Row 42, hang the hem. ON SIDE EDGE, decrease 1 st. every 12th row 15x, every 10th row 6x. Knit to Row 380.

SHAPE ARMHOLE AND NECK AT THE SAME TIME. ON NECK SIDE, decrease 1 st. every 6th row 13x, every 8th row 7x. FOR ARMHOLE: bind off 4 sts. 2x, 3 sts. 2x, 2 sts. 3x, 1 st. 5x. (4 sts. 2x, 3 sts. 3x, 2 sts. 3x, 1 st. 4x). [4 sts. 2x, 3 sts. 3x, 2 sts. 4x, 1 st. 5x]. After Row 512 (516) [520], bind off the remaining 12 sts.

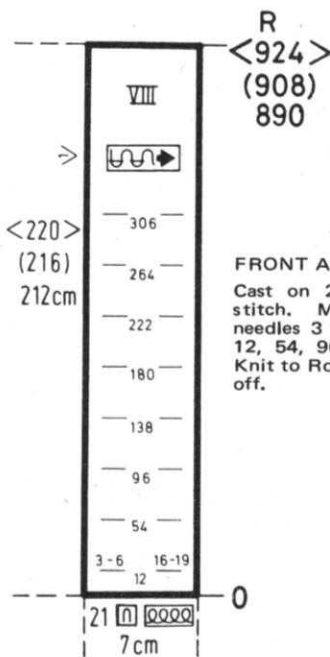

FRONT AND NECK BAND: VIII

Cast on 21 sts. and work Stockinette stitch. Make **BUTTONHOLES** over needles 3 to 6 and 16 to 19 after Rows 12, 54, 96, 138, 180, 222, 264, 306. Knit to Row 890 (908) [924], then bind off.

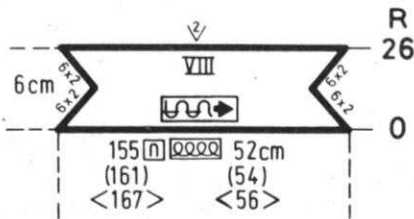

ARMHOLE BANDS: VIII

Cast on 155 (161) [167] sts. and work Stockinette stitch. ON EACH SIDE, decrease 2 sts. every 2nd row 6x, then increase 2 sts. every 2nd row 6x. After Row 26, bind off all sts.

baby lock

MODEL NO. 605. Fabulous Cut,
Sew and Overlock machine.
Perfect for the entire Family.
List Price **\$349.00**

MODEL NO. 405.
New Style Cut and
Overlock Machine.
Specially for knit materials.
List Price: **\$329.00**
(California residents add Sales Tax)

Shipping charges: F.O.B. Los Angeles

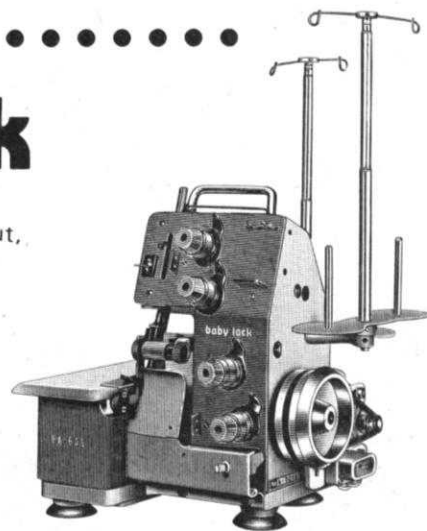

BE SURE TO NOTIFY US IMMEDIATELY OF ANY CHANGE OF ADDRESS. THE POST OFFICE WILL NOT FORWARD YOUR MAGAZINE TO YOU.

DK 74

WOMAN'S DRESS

SIZE: 7/8 (10/12) [14/16]

YARN: Sport Prima

grams C1 500 550 600
grams C2 150 200 250

TENSION: 9 to 10

GAUGE:

Pattern: 14 sts. 26 rows = 5 cm

Holding Position Design according to the Line Drawing. KNITTING machine owners use Wheel No. 3. The knit side is the right side. Bands: Stockinette stitch on the knit side is the right side. Bands: Stockinette stitch on the knit side.

FINISHING: See General Instructions.

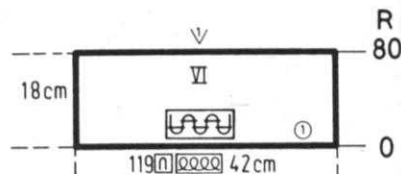

COLLAR: VI

Cast on 119 sts. with color 1 and work 80 rows K1, P1 Ribbing, then bind off.

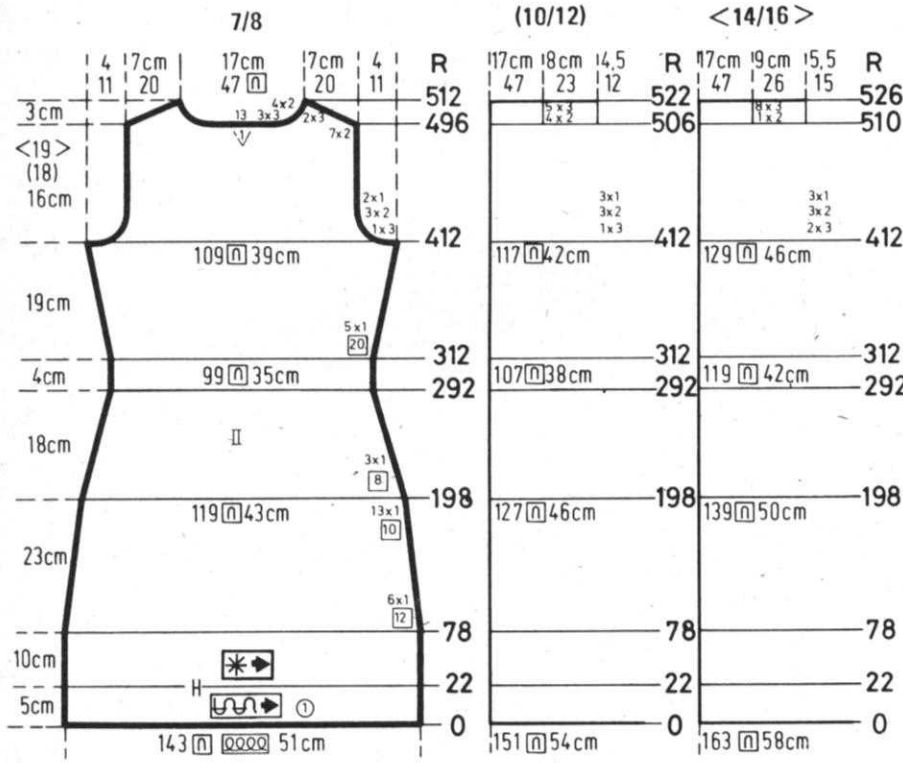

DRESS BACK:

Cast on 143 (151) [163] sts. with color 1. Knit in Stockinette stitch to Row 22, hang the hem, then begin the Holding Position Design. Knit to Row 78. ON EACH SIDE, decrease 1 st. every 12th row 6x, every 10th row 13x. After Row 198, ON EACH SIDE, decrease 1 st. every 8th row 3x. Knit to Row 312. ON EACH SIDE, increase 1 st. every 20th row 5x. Knit to Row 412.

SHAPE ARMHOLE: ON EACH SIDE, bind off 3 sts. 1x, 2 sts. 3x, 1 st. 2x. (3 sts. 1x, 2 sts. 3x, 1 st. 3x). [3 sts. 2x, 2 sts. 3x, 1 st. 3x]. Knit to Row 496 (506) [510]. Bind off the center 13 sts., put the needles on the left side into holding position and complete the right half first.

*SHAPE SHOULDER AND NECK AT THE SAME TIME. Bind off FOR SHOULDER: 2 sts. 7x, 3 sts. 2x. (2 sts. 4x, 3 sts. 5x). [2 sts. 1x, 3 sts. 8x]. FOR NECK - ALL SIZES: 3 sts. 3x, 2 sts. 4x. Bring the needles on the left into working position, knit 1 row in Pattern to the left side, turn the Row Counter back to 496 (506) [510] and complete the left half. Follow the instructions from *.

DRESS FRONT: I

Work the Front section the same as the Back to Row 470 (480) [484]. Bind off the center 11 sts., put the needles on the left side into holding position and complete the right half first.

*ON NECK SIDE, bind off 3 sts. 3x, 2 sts. 3x, 1 st. 3x. After Row 496 (506) [510], SHAPE SHOULDER: bind off 2 sts. 7x, 3 sts. 2x. (2 sts. 4x, 3 sts. 5x). [2 sts. 1x, 3 sts. 8x]. Bring the needles on the left into working position, knit 1 row in Pattern to the left side, turn the Row Counter back to 470 (480) [484] and complete the left half. Follow the instructions from *.

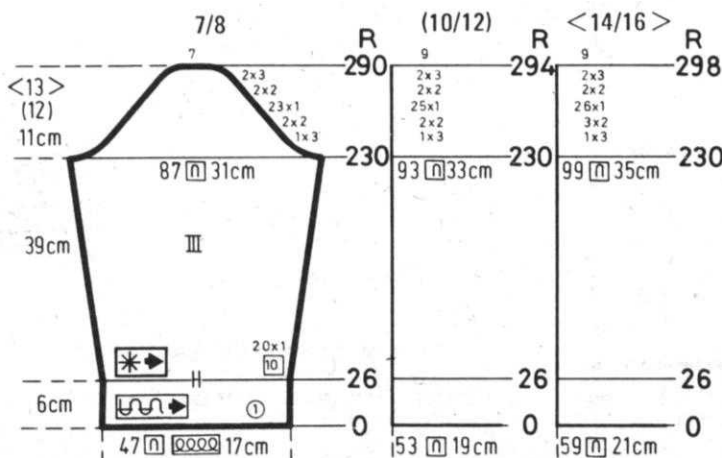
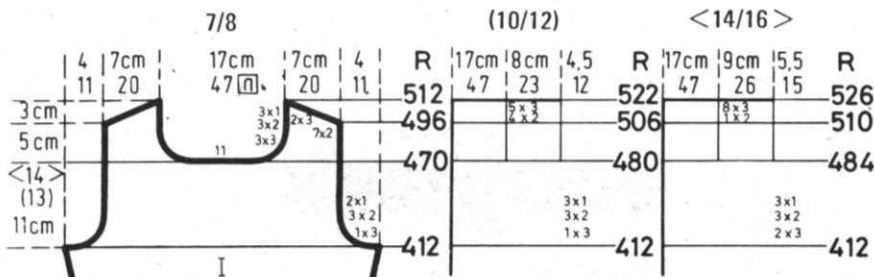

SLEEVE: III

Cast on 47 (53) [59] sts. with color 1 and work Stockinette stitch to Row 26. Hang the hem, then continue with Holding Position Design. ON EACH SIDE, increase 1 st. every 10th row 20x. Knit to Row 230.

SHAPE CAP: ON EACH SIDE, bind off 3 sts. 1x, 2 sts. 2x, 1 st. 23x 2 sts. 2x, 3 sts. 2x. (3 sts. 1x, 2 sts. 2x, 1 st. 25x, 2 sts. 2x, 3 sts. 2x). [3 sts. 1x, 2 sts. 3x, 1 st. 26x, 2 sts. 2x, 3 sts. 2x]. After Row 290 (294) [298], bind off the remaining 7 (9) [9] sts.



HP 75 B

MAN'S PULLOVER AND JACKET

SIZE: 32/34 (36/38) [40/42]

YARN: Beatrice

grams C1	450	500	550
grams C2	300	350	400
grams C3	50	50	50

TENSION: 5 to 7

GAUGE: 17 sts. 24 rows = 5 cm

Stockinette stitch with K1, P1 Ribbing for the bands. Worn on the knit side.

FINISHING: See General Instructions. Work 2 rows single crochet around armholes of Pullover.

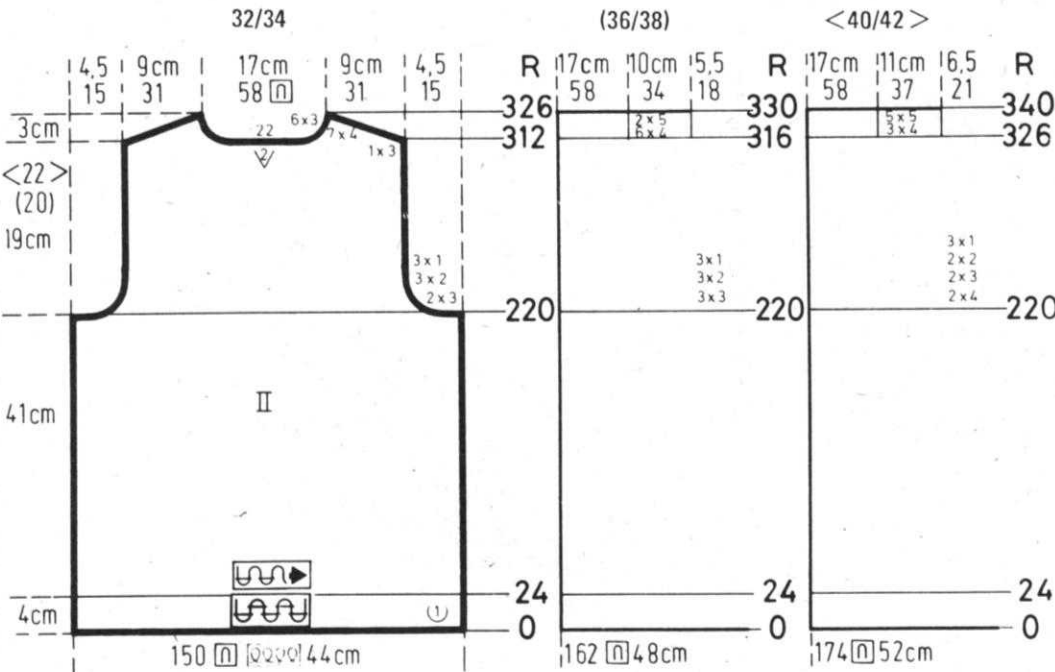

JACKET BACK: II

Cast on 150 (162) [174] sts. with color 1 and work K1, P1 Ribbing to Row 24, then change to Stockinette stitch. Knit even to Row 220.

SHAPE ARMHOLE: ON EACH SIDE, bind off 3 sts. 2x, 2 sts. 3x, 1 st. 3x. (3 sts. 3x, 2 sts. 3x, 1 st. 3x). [4 sts. 2x, 3 sts. 2x, 2 sts. 2x, 1 st. 3x]. Knit to Row 312 (316) [326]. Bind off the center 22 sts., put the needles on the left into holding position and complete the right half first.

*SHAPE NECK AND SHOULDER AT THE SAME TIME. Bind off FOR SHOULDER: 3 sts. 1x, 4 sts. 7x. (4 sts. 6x, 5 sts. 2x). [4 sts. 3x, 5 sts. 5x]. FOR NECK: ALL SIZES, 3 sts. 6x. Move the Cam Box to the left side, turn the Row Counter back to 312 (316) [326] and complete the left half. Follow the instructions from *.

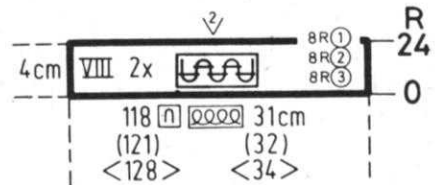

JACKET NECKBAND: VIII Make 2.

Cast on 118 (121) [128] sts. with color 3 and work K1, P1 Ribbing with color stripes as shown on the Chart to Row 24, then bind off the crochet method for ribbing.

JACKET FRONT: I

Cast on 70 (76) [82] sts. with color 1 and work K1, P1 Ribbing to Row 24, then change to Stockinette stitch. Knit to Row 220.

SHAPE NECK AND ARMHOLE AT THE SAME TIME. Bind off FOR ARMHOLE: 3 sts. 2x, 2 sts. 3x, 1 st. 3x. (3 sts. 3x, 2 sts. 3x, 1 st. 3x). [4 sts. 2x, 3 sts. 2x, 2 sts. 2x, 1 st. 3x]. Decrease 1 st. NECK EDGE every 4th row 20x, every 6th row 4x. (every 4th row 18x, every 6th row 6x). [every 4th row 13x, every 6th row 11x].

After Row 312 (316) [326], SHAPE SHOULDER: Bind off 3 sts. 1x, 4 sts. 7x. (4 sts. 6x, 5 sts. 2x). [4 sts. 3x, 5 sts. 5x].

Continued



Knitking News

PRACTICAL KNITTING HINTS FOLLOWING PRINTED INSTRUCTIONS

If you are following the printed instructions in KNITKING MAGAZINE, remember that the instructions are given for 3 sizes. Where shapings are the same for all sizes, you will of course follow them, but where shapings for 3 sizes follow one another, use a red pencil and circle the instructions for the size you are knitting. If at another time you wish to knit a different size, you can use another color pencil to circle that size.

REVERSE SHAPINGS FOR RAGLAN SLEEVES

The Raglan Sleeves for DK 65, DK 71, KK 83 and KK 84 in this issue, are reversed for the second sleeve. An easy way to knit this type of sleeve is to follow the instructions as given for the first sleeve then, for the second sleeve follow the instructions up to the beginning of the Raglan shaping, make your first decrease ON EACH SIDE, then turn the Row Counter to the next higher number. Now the even numbers will be on the left side and the odd numbers will be on the right side and you can follow the instructions as written for the raglan and short row shapings. The only thing you need to remember is that should you be knitting a Pattern stitch on the KNITKING machine, the Pattern stitch is always worked from right to left.

INCREASING, DECREASING, BINDING OFF, WHEN THERE ARE NEEDLES OUT OF WORK

In this issue of KNITKING MAGAZINE, there are a number of Patterns with needles in the out of work position and we remind you that the empty needles ARE COUNTED in the stitch gauge and the instructions. A MOCK RIB Pattern usually has every 4th needle out of work. When increasing or decreasing a Pattern with out of work needles, make the increases and decreases at the edge of your knitting.

Supposing you already have 3 needles in work at the edge of the knitting and you need to increase 1 stitch. The next increase would be an out of work needle and you cannot cast on over a needle that would be out of work. The way to make this increase is: bring a new needle into working position and cast on. Now you have 4 end needles in work. Continue with your knitting until the next increase, then with a transfer tool, pick up the end stitch and move it over to the next outside empty needle and leave it in work. Put the emptied needle into the out of work position. This will make your second increase and the first increase is now the empty needle.

If you are increasing more than 1 stitch, bring the number of needles into working position FIRST, then set the needles into Pattern. For instance, if you are increasing 3 sts. (and you already have 3 end needles in work), bring 3 new needles into working position, then put the 3rd needle (counting from the end) back into the out of work position and cast on over the 2 new needles only.

When binding off a number of stitches, you MUST make a bind off stitch over the empty needles. There are two ways you can do this. If you use

the crochet method for binding off, bring all the empty needles into working position before knitting your bind off row with a larger tension. As you crochet the stitches off, make a chain at every former empty needle space. This will prevent a too tight bind off edge.

The second way is to make the bind offs as shown in your Instruction Manual and be sure to bring the empty needles into working position so that you can make a bind off (counting it of course) over every empty needle.

If a Pattern Stitch has two or three empty needles, the increasing, decreasing and bind offs are made in the same way as above and you count each empty needle as one stitch.

TO INCREASE OR DECREASE 2 STITCHES AT THE EDGE OF YOUR KNITTING

Occasionally you will find instructions telling you to increase or decrease 2 stitches at the edge of your knitting. Usually, if there is more than a 1 stitch increase or decrease, it is called casting on - or binding off.... but if we say to increase or decrease 2 sts., this is the way it is done.

1. To decrease: With a double Transfer Tool, remove the 2 end sts., then hang the sts. onto the next 2 working needles (2 stitches on each needle).
2. To increase: Move the end stitch out to the next empty needle, leave it in working position then pick up the 2nd stitch from the row below and hang it onto the empty needle. Bring an empty needle at the edge of your knitting into working position and continue knitting.

KNITTING WITH AMORE

AMORE is one of our loveliest yarns. It is a hard twist synthetic (100% Orlon) that goes into your washer and dryer and comes out soft and looking like new every time. It is a very hard wearing yarn because of its special twist. It makes up into beautiful garments... dresses, pantsuits, coats, sweaters - just about anything you want and it is perfect for children's garments because of its easy care. Some of our customers say it twists and knots when they are knitting with it... so here are some hints that absolutely will prevent this and we guarantee you too will love AMORE.

We hope you KNOW that you must ALWAYS rewind yarn when you receive it before you knit with it. Even if a ball of yarn is wound so that you can pull it from the center, you MUST rewind it yourself because it has been packaged for some time and the fibers will stick together and produce uneven knitting.. Cone yarn is the only yarn that does not need to be wound into center pull balls... you can knit it right from the cone.

AMORE should be waxed... either at the time you are winding it into a pull ball, or while you are knitting with it. To wax it as you make the pull ball, use the KNITKING Waxamajig Yarn Winder. If you do not have the Waxamajig Yarn Winder, you

can use another winder and hold a piece of paraffin wax in your left hand and allow the yarn to run over the wax as you wind with your right hand. Do not hold the yarn too tight - you do not want a tight ball. If it does not pull easily from the center, you will have to rewind it without the wax.

Another way is to wax the yarn as you knit with it. Wind your center pull ball first. Some Japanese machines (Brother for instance) come equipped with a wax disc. Follow the instructions given for attaching the wax disc to your machine and the yarn will automatically be waxed as you knit. KNITKING machine owners should place the ball of yarn on the floor in back of the machine, then feed it through a hole in the back of the Yarn Container, then through the Tension Disc, the Antenna and down to the feed finger. If you do not have a hole in your Yarn Container, make one with a 1/4" drill and about half way up on the back of the Container. Now you can tape a piece of Paraffin wax with a hole in the center, right over the hole in the Yarn Container then feed the yarn through the holes in wax and container. When you knit with AMORE in this way, the yarn feeds smoothly without twisting or knotting and the knitting is beautifully even... try it!! This method of waxing yarn as you knit can be used with any yarns but is especially great with any synthetics and nub yarns that might not have as much elasticity as the pure wools.

NEW CONE YARNS BY KNITKING

While we are talking about quality yarns, we would like to emphasize the excellent quality and low prices of our new Cone Yarns and to tell you that we are adding more cone yarns to the celebrated range of KNITKING Yarns... You will be informed about them as they become available for sale... Meanwhile you can substitute our cone yarns Heavenly or Venetia for some of the yarns called for in this issue... The coning of yarns is less expensive than winding it into 1 ounce or 50 gram balls, so if you can substitute cone yarns for balled yarns, your production costs per garment will be much less. Heavenly is our most popular yarn at this time... It is a lovely boucle especially popular in the knitting of dresses and pantsuits but equally suitable for cardigans and sweaters for all members of the

NEW SAFE STEAM IRON

We have discovered a new design Steam Iron called STEAMSTRESS and found it to be ideal for pressing and blocking knits, both woolen and synthetics.... It is guaranteed not to scorch any kind of fabric, you need no pressing cloth or sleeve board... The STEAMSTRESS has a non-metal base, it can be used horizontally or vertically... and the price is right... We recommend it to all subscribers... \$12.95 plus \$1.00 Shipping.

family... Heavenly is an elegant easy care yarn, tops in quality and low in price.

Venetia cone yarn is a luscious 70% pure wool, 30% rayon yarn of incomparable quality... Venetia has a lustrous appearance in keeping with modern style garments and it is suitable for all types of clothing.

Heavenly has a stitch gauge from 14 to 16 stitches and 22 to 24 rows to 2" (or 5 centimeters) and Venetia 16 to 18 stitches and 23 to 31 rows. Try them both... you will like them.

BROTHER SEWING MACHINES

It seems that whenever we introduce a product not directly connected with knitting and knitting machines, we get customer resistance from some of our readers... we even get letters telling us to stick to our knitting... Our first love is of course knitting but we do have a large number of loyal customers who know that we strive to give them a good deal in everything we offer... and we know that just about every household in the U.S.A. owns at least one sewing machine.

The market for sewing machines has been gaining steadily over the past few years and there has been substantial improvement in the design and function of leading brand machines during that period... which means that large numbers of old style machines are being traded... We aim to be a part of the sewing boom and we ask that whenever you are in the market for a top quality sewing machine, you give us the opportunity to quote... We are working directly with Brother International and because of volume buying we can offer our readers machines at big, big savings.

We did not choose Brother sewing machines lightly. We shopped very carefully and tested many brands before deciding on Brother... A recent survey and report showed that Brother rated in the top three machines (along with Bernina and Elna) so we suggest that when you are ready you compare our prices... We are selling the top five machines in a range of 14 made by Brother for home use - including the new highly rated Shangri-La portable and the Deluxe free arm Model XL-703 zig zag with built in Cams for 25 different designs. It has blind stitch, self stop bobbin winder, push button reverse, twin needle sewing and golden needles... A marvelous sewing machine.. and the low price will surprise you.

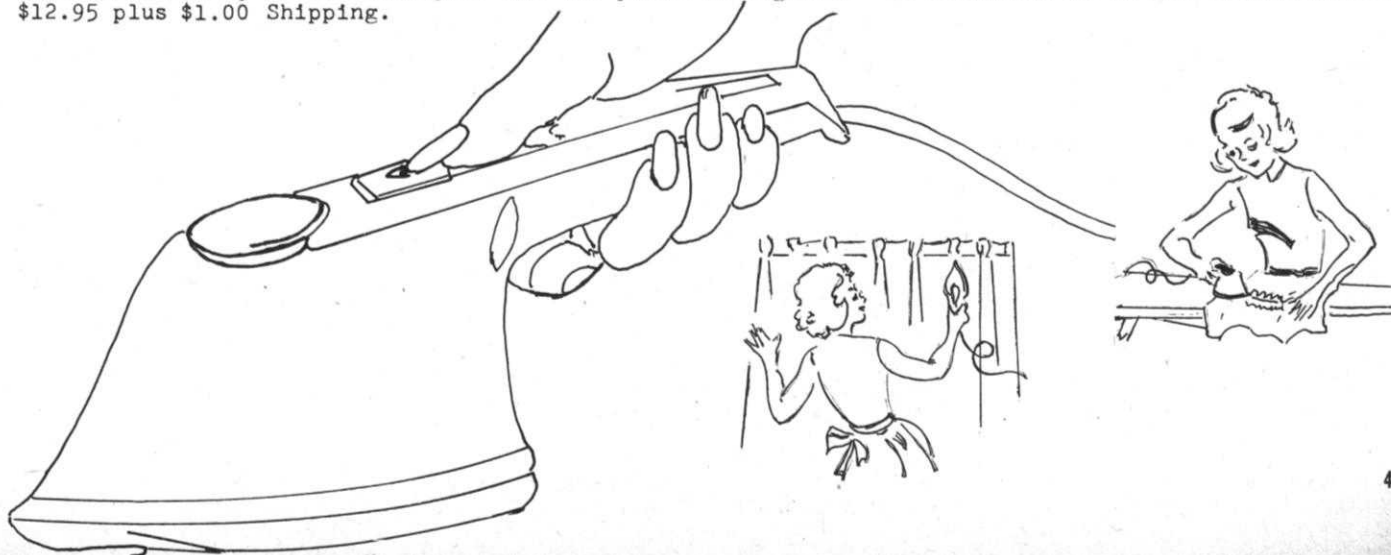

JACKET FRONT BAND: VIII

Cast on 170 sts. with color 3 and work K1, P1 Ribbing with color stripes as marked on the chart. Work Buttonholes after Row 12 over needles 6 to 11, 44 to 49, 82 to 87, 120 to 125, 158 to 163 counting from the left. After Row 24, bind off the crochet method for Ribbing. Make a second Band the same but omit the buttonholes.

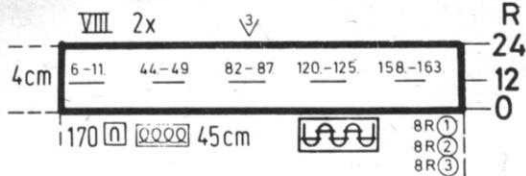

HP 76

MAN'S JACKET

SIZE: 34/36 (38/40) [42/44]
YARN: Crocus
 grams 550 600 650
TENSION: 6 to 8
GAUGE:
 Stock: 15 sts. 22 rows = 5 cm
 Pattern: 15 sts. 26 rows = 5 cm

Holding Position Design according to the Line Drawing. KNITTING machine owners use Wheel No. 6. Bands: Stockinette stitch. The purl side of Pattern is the right side, the knit side of Stockinette stitch.

FINISHING: See General Instructions. Make hem on Pocket, then sew onto Jacket (see picture).

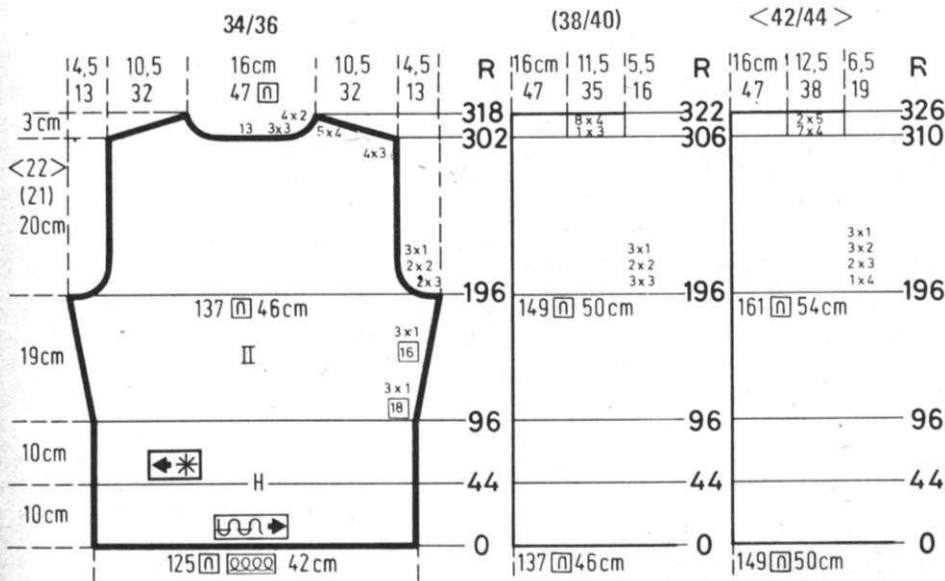
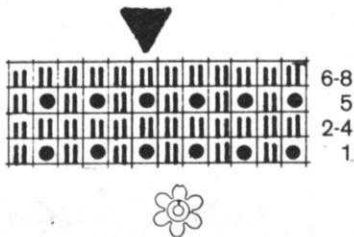

JACKET BACK: II

Cast on 125 (137) [149] sts. and work Stockinette stitch to Row 44. Hang the hem, then change to the Holding Position Design. Knit to Row 96. ON EACH SIDE, increase 1 st. every 18th row 3x. every 16th row 3x. After Row 196, SHAPE ARMHOLE: ON EACH SIDE, bind off 3 sts. 2x, 2 sts. 2x, 1 st. 3x. (3 sts. 3x, 2 sts. 2x, 1 st. 3x). [4 sts. 1x, 3 sts. 2x, 2 sts. 3x, 1 st. 3x]. Knit to Row 302 (306) [310], bind off the center 13 sts., put the needles on the left side into holding position and complete the right half first.

*SHAPE NECK AND SHOULDER AT THE SAME TIME: Bind off FOR SHOULDER: 3 sts. 4x, 4 sts. 5x. (3 sts. 1x, 4 sts. 8x). [4 sts. 7x, 5 sts. 2x]. FOR NECK: SAME FOR ALL SIZES: 3 sts. 3x, 2 sts. 4x. Bring the needles on the left into working position, knit 1 row in Pattern to the left side, turn the Row Counter back to 302 (306) [310] and complete the left half. Follow the instructions from *.

FRONT BAND: VIII

Cast on 156 sts. and work Stockinette stitch. After Rows 9 and 17, make BUT-TONHOLES over needles 6 to 11, 26 to 31, 46 to 51, 66 to 71, 86 to 91, 106 to 111, 126 to 131, 146 to 151 counting from the left edge. Knit to Row 26, then bind off. Make another band the same but omit the buttonholes.

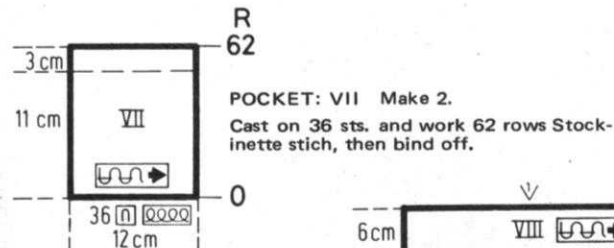
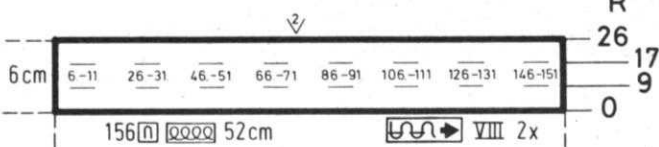

POCKET: VII Make 2.
 Cast on 36 sts. and work 62 rows Stockinette stitch, then bind off.

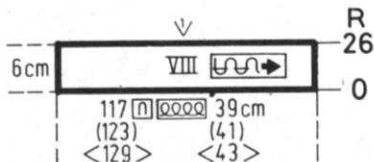

NECKBAND: VIII
 Cast on 117 (123) [129] sts. and work 26 rows Stockinette stitch, then bind off.

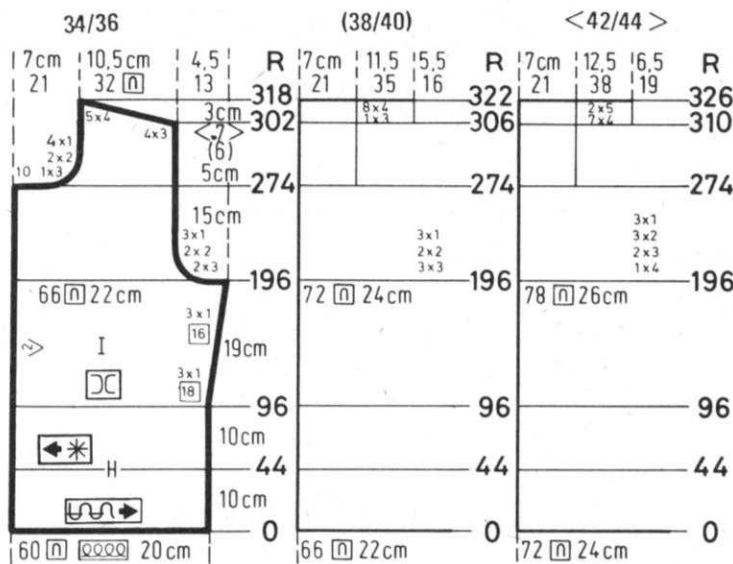

JACKET FRONT: I Make 1, reverse 1.
Cast on 60 (66) [72] sts. and work 14 rows Stockinette stitch. Hang the hem, then change to the Holding Position Design. Knit to Row 96. **ON SIDE EDGE**, increase 1 st. every 18th row 3x, every 16th row 3x. Knit to Row 196.

SHAPE ARMHOLE: Bind off 3 sts. 2x, 2 sts. 2x, 1 st. 3x. (3 sts. 3x, 2 sts. 2x, 1 st. 3x). [4 sts. 1x, 3 sts. 2x, 2 sts. 3x, 1 st. 3x]. Knit to Row 275. **SHAPE NECK:** Bind off 10 sts. 1x, 3 sts. 1x, 2 sts. 2x, 1 st. 4x.

SHAPE SHOULDER after Row 302 (306) [310]. Bind off 3 sts. 4x, 4 sts. 5x. (3 sts. 1x, 4 sts. 8x). [4 sts. 7x, 5 sts. 2x].

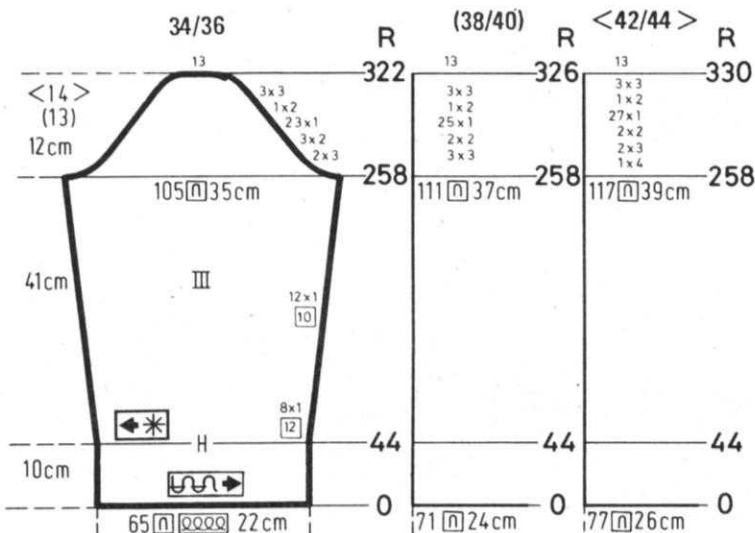

SLEEVE: III

Cast on 65 (71) [77] sts. and work 44 rows Stockinette stitch. Hang the hem, then change to the Holding Position Design. **ON EACH SIDE**, increase 1 st. every 12th row 8x, every 10th row 12x. Knit to Row 258.

SHAPE CAP: **ON EACH SIDE**, bind off 3 sts. 2x, 2 sts. 3x, 1 st. 23x, 2 sts. 1x, 3 sts. 3x. (3 sts. 3x, 2 sts. 2x, 1 st. 25x, 2 sts. 1x, 3 sts. 3x). [4 sts. 1x, 3 sts. 2x, 2 sts. 2x, 1 st. 27x, 2 sts. 1x, 3 sts. 3x]. After Row 322 (326) [330], bind off the remaining 13 sts.

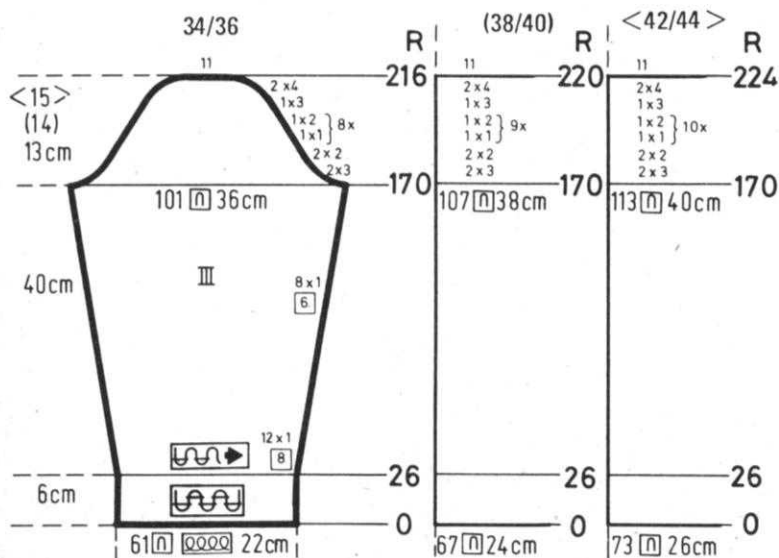

HP 77

SLEEVE: III

Cast on 61 (67) [73] sts and work 26 rows K1, P1 Ribbing. Change to Stockinette stitch. **ON EACH SIDE**, increase 1 st. every 8th row 12x, every 6th row 8x. Knit to Row 170.

SHAPE CAP: **ON EACH SIDE**, bind off 3 sts. 2x, 2 sts. 2x, *1 st. 1x, 2 sts. 1x and REPEAT FROM * 7x more, 3 sts. 1x, 4 sts. 2x. (3 sts. 2x, 2 sts. 2x, *1 st. 1x, 2 sts. 1x and REPEAT FROM * 8x more, 3 sts. 1x, 4 sts. 2x). [3 sts. 2x, 2 sts. 2x, *1 st. 1x, 2 sts. 1x and REPEAT FROM * 9x more, 3 sts. 1x, 4 sts. 2x]. After Row 216 (220) [224], bind off the remaining 11 sts.

HP 77

MAN'S PULLOVER

SIZE: 34/36 (38/40) [42/44]

YARN: Allegro
grams 450 500 550

TENSION: 8 to 10

GAUGE: 14 sts. 18 rows = 5 cm

Stockinette stitch with a Cable Design down the front section according to the Line Drawing. The bands are Ribbed. The knit side is the right side.

FINISHING: See General Instructions.

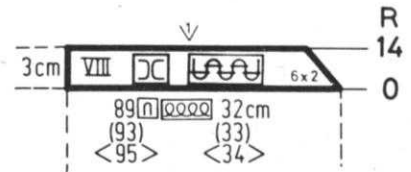

NECKBAND: VIII Make 1, reverse 1.

Cast on 89 (93) [95] sts. and work K1, P1 Ribbing. ON THE RIGHT SIDE (left for the second section), decrease 2 sts. every 2nd row 6x. After Row 14, bind off the crochet method for ribbing.

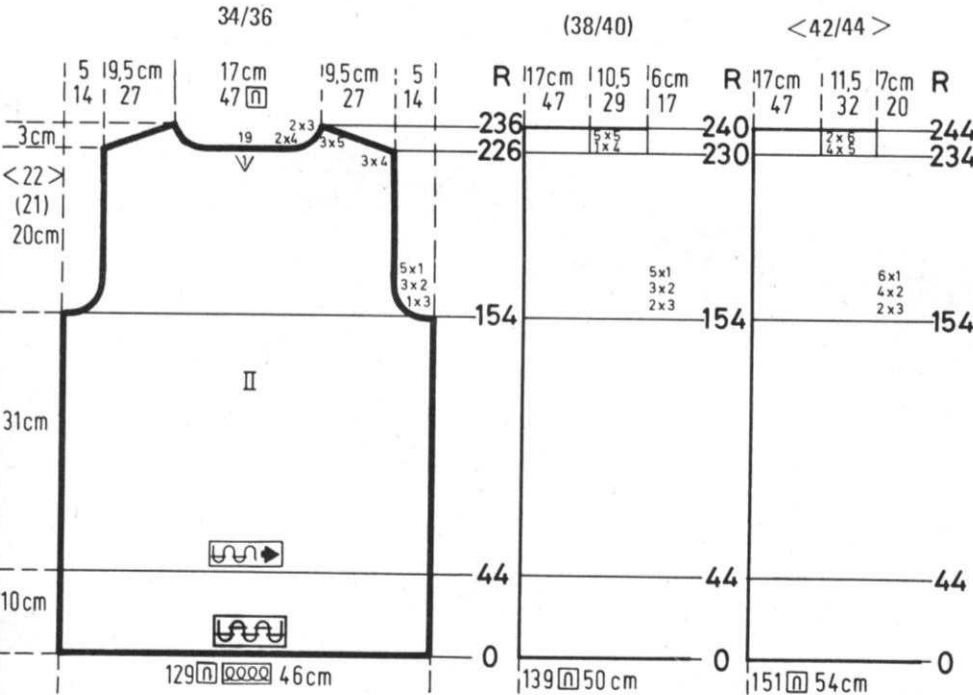

PULLOVER BACK: II

Cast on 129 (139) [151] sts. and work 44 rows K1, P1 Ribbing. Change to Stockinette stitch and knit to Row 154. SHAPE ARMHOLE: ON EACH SIDE, bind off 3 sts. 1x, 2 sts. 3x, 1 st. 5x. (3 sts. 2x, 2 sts. 3x, 1 st. 5x). [3 sts. 2x, 2 sts. 4x, 1 st. 6x]. Knit to Row 226 (230) [234]. Bind off the center 19 sts., put the needles on the left side into holding position and complete the right half first.

*SHAPE NECK AND SHOULDER AT THE SAME TIME: Bind off FOR SHOULDER: 4 sts. 3x, 5 sts. 3x. (4 sts. 1x, 5 sts. 5x). [5 sts. 4x, 6 sts. 2x]. FOR NECK: SAME FOR ALL SIZES: 4 sts. 2x, 3 sts. 2x. Move the Cam Box to the left side, turn the Row Counter back to 226 (230) [234] and complete the left half. Follow the instructions from *.

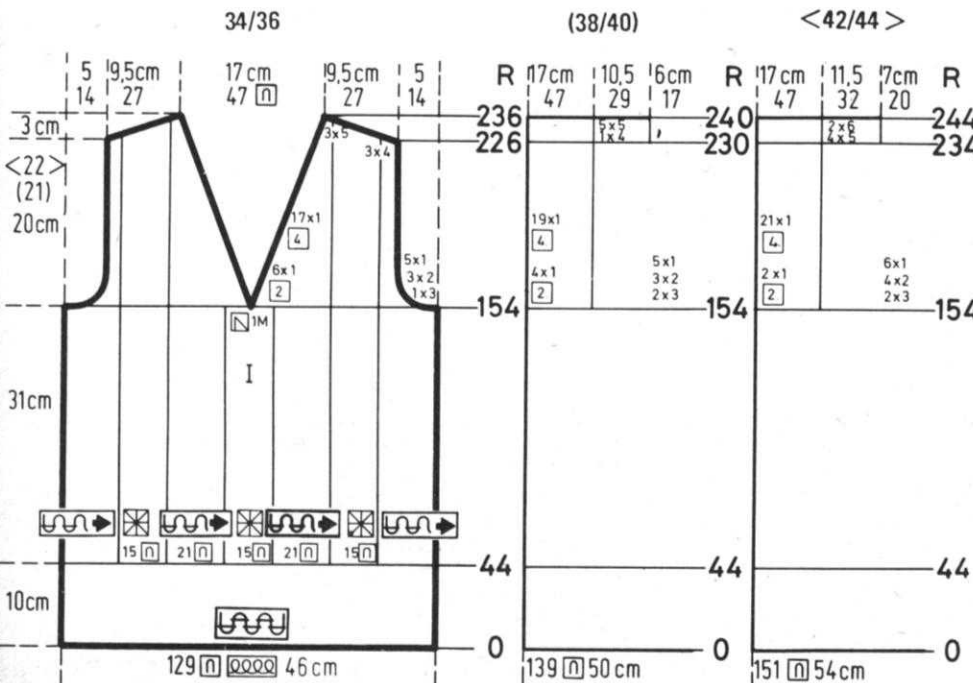

PULLOVER FRONT: I

Cast on 129 (139) [151] sts. and work 44 rows K1, P1 Ribbing. Change to Stockinette stitch and work Cable Design as on the Line Drawing, over the needles marked on the Chart. Knit to Row 154. Divide in the center and put the needles on the left side into holding position and complete the right half first.

*SHAPE ARMHOLE AND NECK AT THE SAME TIME: Bind off FOR ARMHOLE: 3 sts. 1x, 2 sts. 3x, 1 st. 5x. (3 sts. 2x, 2 sts. 3x, 1 st. 5x). [3 sts. 2x, 2 sts. 4x, 1 st. 6x]. FOR NECK: decrease 1 st. every 2nd row 6x, every 4th row 17x. (every 2nd row 7x, every 4th row 19x). [every 2nd row 2x, every 4th row 21x].

SHAPE SHOULDER after Row 226 (230) [234]. Bind off 4 sts. 3x, 5 sts. 3x. (4 sts. 1x, 5 sts. 5x). [5 sts. 4x, 6 sts. 2x]. Bring the needles on the left into working position, knit 1 row in Pattern to the left side, turn the Row Counter back to 154 and complete the left half. Follow the instructions from *.

HP 78 B

MAN'S PULLOVER

SIZE: 34/36 (38/40) [42/44]

YARN: Amoretta
grams C1 350 400 450
grams C2 50 50 50

TENSION: 8 to 10

GAUGE: 15 sts. 25 rows = 5 cm

Stockinette stitch with color stripes as shown on the Charts. The purl side is the right side. Bands: K1, P1 Ribbing.

FINISHING: See General Instructions.

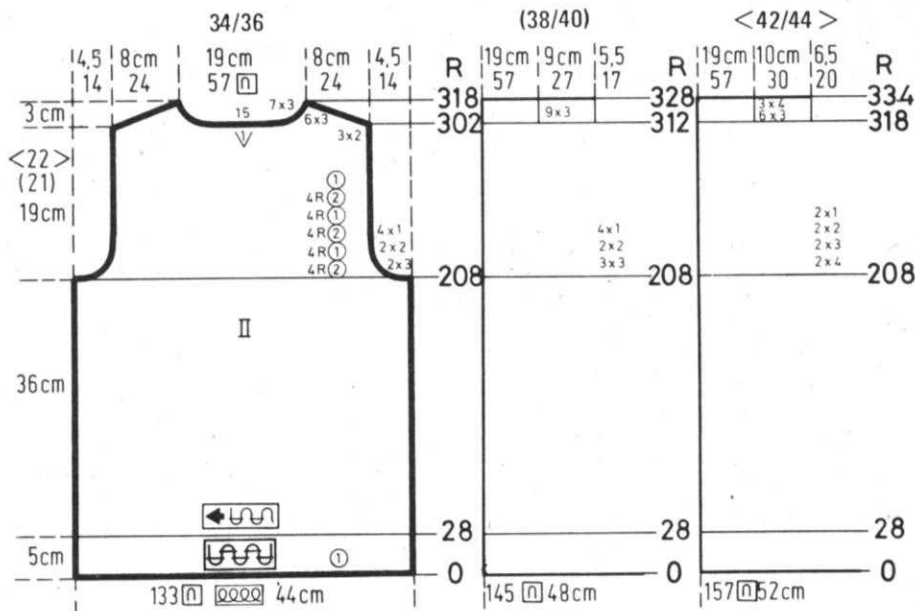

PULLOVER BACK: II

Cast on 133 (145) [157] sts. with color 1 and work 28 rows K1, P1 Ribbing. Change to Stockinette stitch and knit to Row 208.

SHAPE ARMHOLE and work the color stripes as marked on the Chart. ON EACH SIDE, bind off 3 sts. 2x, 2 sts. 2x, 1 st. 4x. (3 sts. 3x, 2 sts. 2x, 1 st. 4x). [4 sts. 2x, 3 sts. 2x, 2 sts. 2x, 1 st. 2x]. Knit to Row 302 (312) [318]. Bind off the center 15 sts., put the needles on the left side into holding position and complete the right half first.

*Bind off FOR SHOULDER: 2 sts. 3x, 3 sts. 6x. (3 sts. 9x). [3 sts. 6x, 4 sts. 3x]. FOR NECK: ALL SIZES THE SAME: 3 sts. 7x. Bring the needles on the left into working position, knit 1 row to the left side, turn the Row Counter back to 302 (312) [318] and complete the left half. Follow the instructions from *.

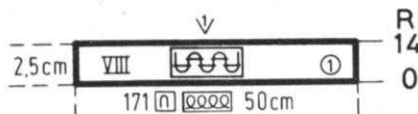

NECKBAND: VIII

Cast on 171 sts. with color 1 and work 14 rows K1, P1 Ribbing, then bind off the crochet method for ribbing.

PULLOVER FRONT: I

Knit the Front section the same as the back to Row 248. Bind off the center 13 sts., put the needles on the left side into holding position and complete the right half first.

*ON NECK SIDE, bind off 3 sts. 2x, 2 sts. 3x, 1 st. 5x, 1 st. every 4th row 5x AND AT THE SAME TIME after Row 302 (312) [318], SHAPE SHOULDER: Bind off 2 sts. 3x, 3 sts. 6x. (3 sts. 9x). [3 sts. 6x, 4 sts. 3x]. Bring the needles on the left into working position, knit 1 row to the left side, turn the Row Counter back to 248 and complete the left half. Follow the instructions from *.

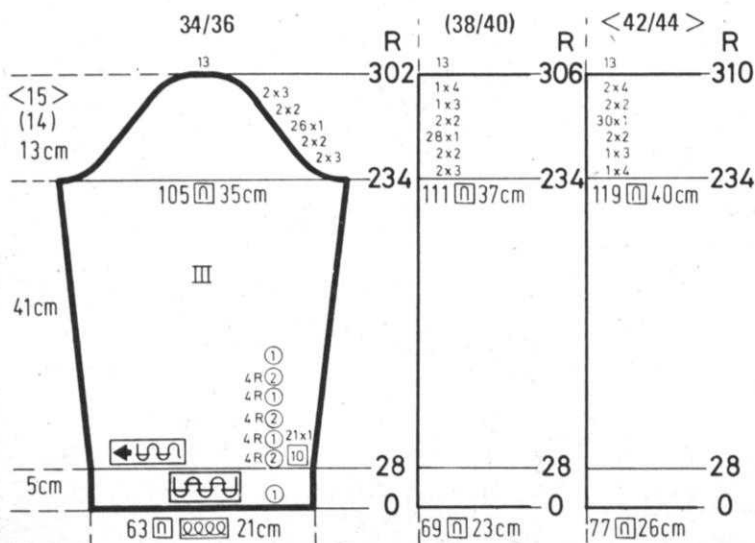
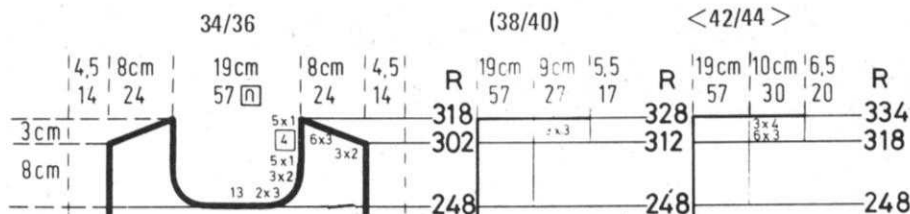

SLEEVE: III

Cast on 63 (69) [77] sts. with color 1 and work 28 rows K1, P1 Ribbing. Change to Stockinette stitch and work the color stripes as marked on the Chart. ON EACH SIDE, increase 1 st. every 10th row 21x. Knit to Row 234.

SHAPE CAP: ON EACH SIDE, bind off 3 sts. 2x, 2 sts. 2x, 1 st. 26x, 2 sts. 2x, 3 sts. 2x. (3 sts. 2x, 2 sts. 2x, 1 st. 28x, 2 sts. 2x, 3 sts. 1x, 4 sts. 1x). [4 sts. 1x, 3 sts. 1x, 2 sts. 2x, 1 st. 30x, 2 sts. 2x, 4 sts. 2x]. After Row 302 (306) [310], bind off the remaining 13 sts.

HP 79

MAN'S JACKET

SIZE: 36/38 (40/42) [44/46]

YARN: Beatrice
grams 700 750 800

TENSION: 7 to 9

GAUGE: 17 sts. 21 rows = 5 cm

Ribbing Pattern according to Line Drawing, worn on the purl side. Bands are K1, P1 Ribbing.

FINISHING: See General Instructions. Sew the pocket lining in place.

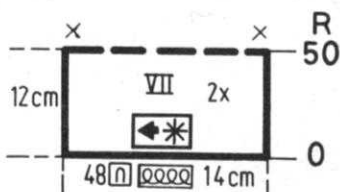

POCKET LINING: VII Make 2.

Cast on 48 sts. and work in Rib Pattern to Row 50, then remove the sts. onto contrast waste yarn.

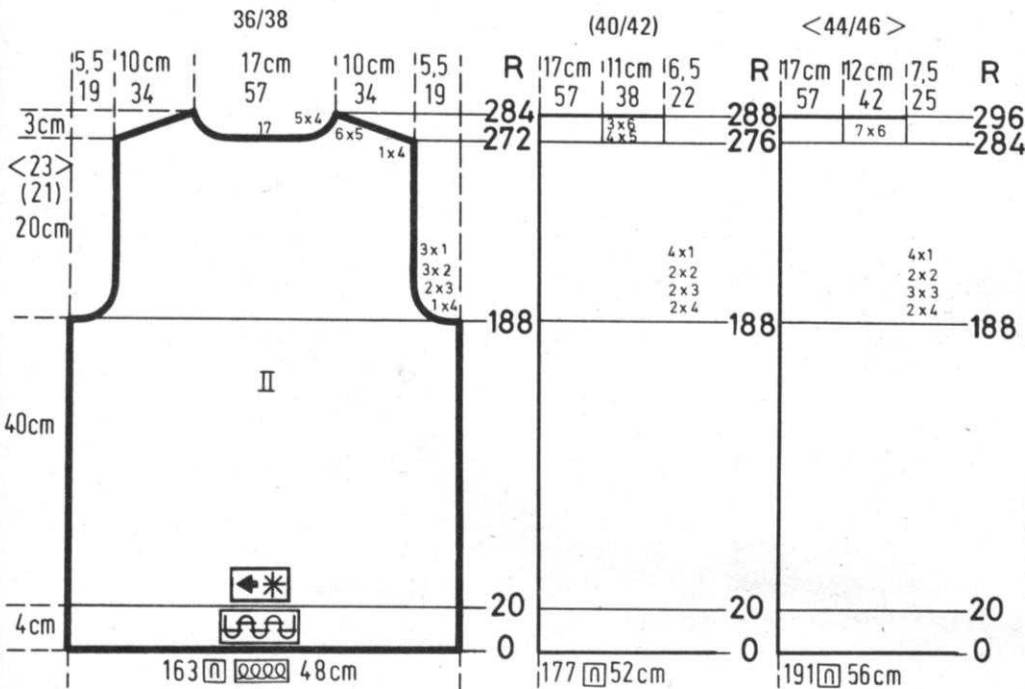

JACKET BACK:

Cast on 163 (177) [191] sts. and work 20 rows K1, P1 Ribbing. Change to Ribbing Pattern and knit to Row 188. SHAPE ARMHOLE: ON EACH SIDE, bind-off 4 sts. 1x, 3 sts. 2x, 2 sts. 3x, 1 st. 3x. (4 sts. 2x, 3 sts. 2x, 2 sts. 2x, 1 st. 4x). [4 sts. 2x, 3 sts. 3x, 2 sts. 2x, 1 st. 4x]. Bind off the center 17 sts., put the needles on the left into holding position and complete the right half first.

*SHAPE SHOULDER AND NECK AT THE SAME TIME: Bind off FOR SHOULDER: 4 sts. 1x, 5 sts. 6x. (5 sts. 4x, 6 sts. 3x). [6 sts. 7x]. FOR NECK: SAME FOR ALL SIZES: 4 sts. 5x. Bring the needles on the left into working position, knit 1 row in rib pattern to the left, turn the Row Counter back to 272 (276) [284] and complete the left half. Follow the instructions from *.

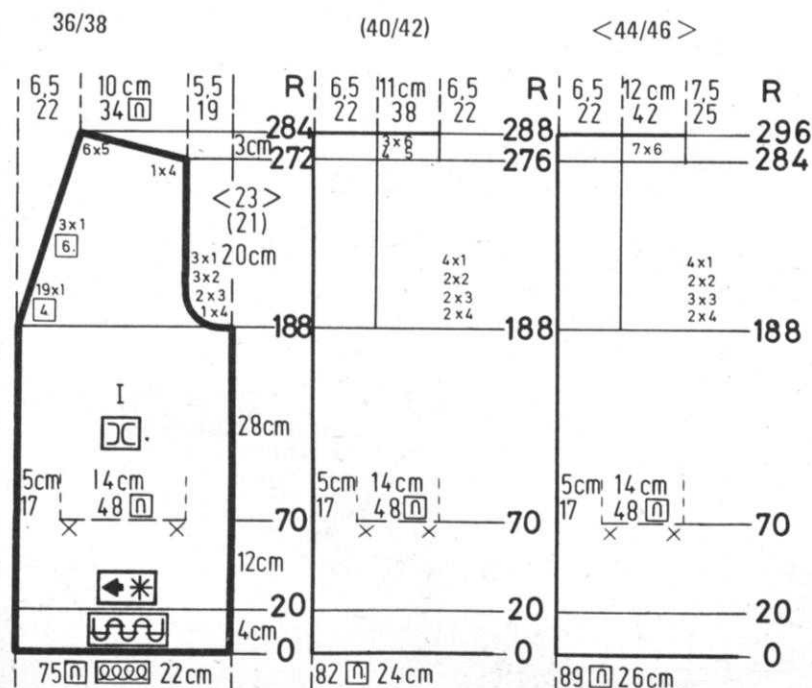

JACKET FRONT: Make 1, reverse 1.

BE SURE TO MAKE THE POCKET LININGS FIRST. Cast on 75 (82) [89] sts. and work 20 rows K1, P1 Ribbing, then change to Rib Pattern. Knit to Row 70.

ON THE LEFT SIDE (right for second section), put 17 needles into holding position. Knit 1 row. ON THE RIGHT SIDE (left for second section), put 10 needles into holding position. Knit 1 row. Over the remaining 48 needles in work, knit 12 rows K1, P1 Ribbing, then bind off these stitches.

With Purl side facing you, hang the pocket lining stitches onto the empty needles, then remove the waste yarn. Set all the needles into Rib Pattern. Turn the Row Counter back to 70 and knit to Row 188.

SHAPE ARMHOLE AND NECK AT THE SAME TIME. ON NECK SIDE, decrease 1 st. every 4th row 19x, every 6th row 3x. FOR ARMHOLE: Bind off 4 sts. 1x, 3 sts. 2x, 2 sts. 3x, 1 st. 3x. (4 sts. 2x, 3 sts. 2x, 2 sts. 2x, 1 st. 4x). [4 sts. 2x, 3 sts. 3x, 2 sts. 2x, 1 st. 4x]. SHAPE SHOULDER after Row 272 (276) [284]. Bind off 4 sts. 1x, 5 sts. 6x. (5 sts. 4x, 6 sts. 3x). [6 sts. 7x].

Continued

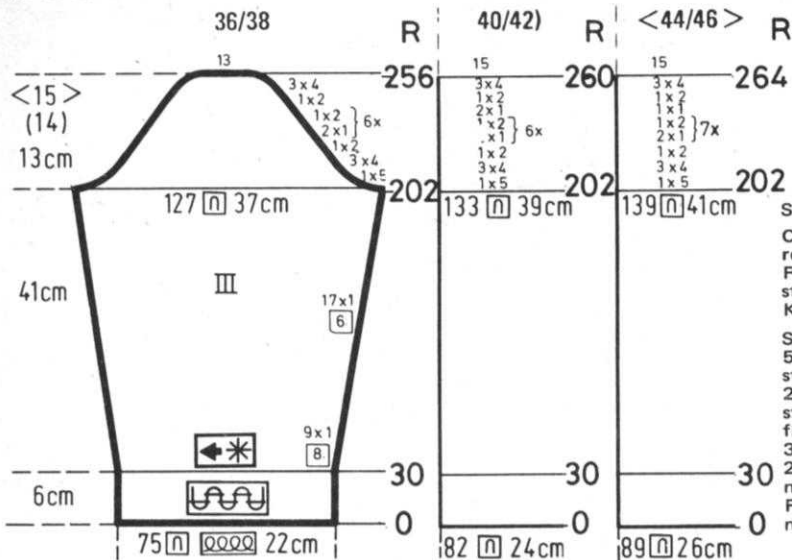

SLEEVE: III

Cast on 75 (82) [89] sts. and work 30 rows K1, P1 Ribbing, then change to the Rib Pattern. ON EACH SIDE, increase 1 st. every 8th row 9x, every 6th row 17x. Knit to Row 202.

SHAPE CAP: ON EACH SIDE, bind off 5 sts. 1x, 4 sts. 3x, 2 sts. 1x, *1 st. 2x, 2 sts. 1x, and REPEAT FROM * 5x more, 2 sts. 1x, 4 sts. 3x. (5 sts. 1x, 4 sts. 3x, 2 sts. 1x, *1 st. 2x, 2 sts. 1x, and REPEAT from * 5x more, 1 st. 2x, 2 sts. 1x, 4 sts. 3x). [5 sts. 1x, 4 sts. 3x, 2 sts. 1x, *1 st. 2x, 2 sts. 1x, and REPEAT from * 6x more, 1 st. 1x, 2 sts. 1x, 4 sts. 3x]. After Row 256 (260) [264], bind off the remaining 13 (15) [15] sts.

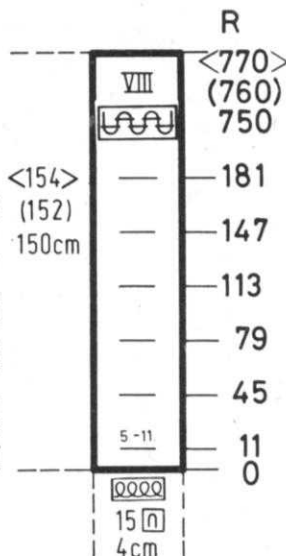

FRONT AND NECKBAND: VIII

Cast on 15 sts. and work K1, P1 Ribbing. Make **BUTTONHOLES** over needles 5 to 11 after Rows as shown on the Chart. After Row 750 (760) [770], bind off.

HP 80

MAN'S JACKET

SIZE: 34/36 (38/40 [42/44])

YARN: Allegro

grams C1 500 550 600
grams C2 350 400 450

Jacket Zipper

TENSION: 8 to 10

GAUGE:

Stock: 14 sts. 20 rows = 5 cm

Pattern: 14 sts. 38 rows = 5 cm

FINISHING: See General Instructions. Fold up the lower band and sew the ends together. Make a 7 cm hem on top of pocket, then turn over 5 cm to the right side and sew in place. Sew pockets in place, (see picture). Finish buttonholes on tabs and sew on buttons. Work 1 row single crochet down front edges, then sew in zipper.



Holding Position Design according to Line Drawing. **KNITTING** machine owners use Adjustable Needle Selector to set up Pattern, then use the Needle Shifter. The Knit side is the right side of Pattern. Bands are Stockinette stitch.

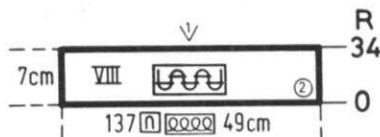

NECKBAND: VIII

Cast on 137 sts. with color 2 and work 34 rows K1, P1 Ribbing, then bind off.

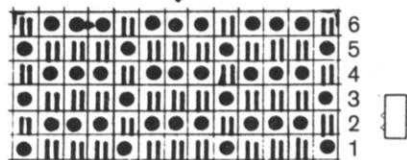

JACKET BACK: II

Cast on 133 (143) [153] sts. with color 2 and knit 50 rows Stockinette stitch. Change to color 1 and the Holding Position Design. Knit to Row 332.

SHAPE ARMHOLE: ON EACH SIDE, on EVERY 4th ROW, bind off 3 sts. 2x, 2 sts. 2x, 1 st. 4x. (3 sts. 2x, 2 sts. 3x, 1 st. 2x). [4 sts. 1x, 3 sts. 2x, 2 sts. 3x, 1 st. 4x]. Knit to Row 484 (498) [506]. Bind off the center 13 sts., put the needles on the left side into holding position and complete the right half first.

***SHAPE SHOULDER AND NECK AT THE SAME TIME: Bind off FOR SHOULDER: 2 sts. 6x, 3 sts. 6x. (2 sts. 4x, 3 sts. 8x). [2 sts. 2x, 3 sts. 10x]. FOR NECK: ALL SIZES THE SAME: 2 sts. 6x, 1 st. 4x. Bring the needles on the left into working position, knit 1 row in Pattern to the left side, turn the Row Counter back to 484 (498) [506] and complete the left half. Follow the instructions from *.**

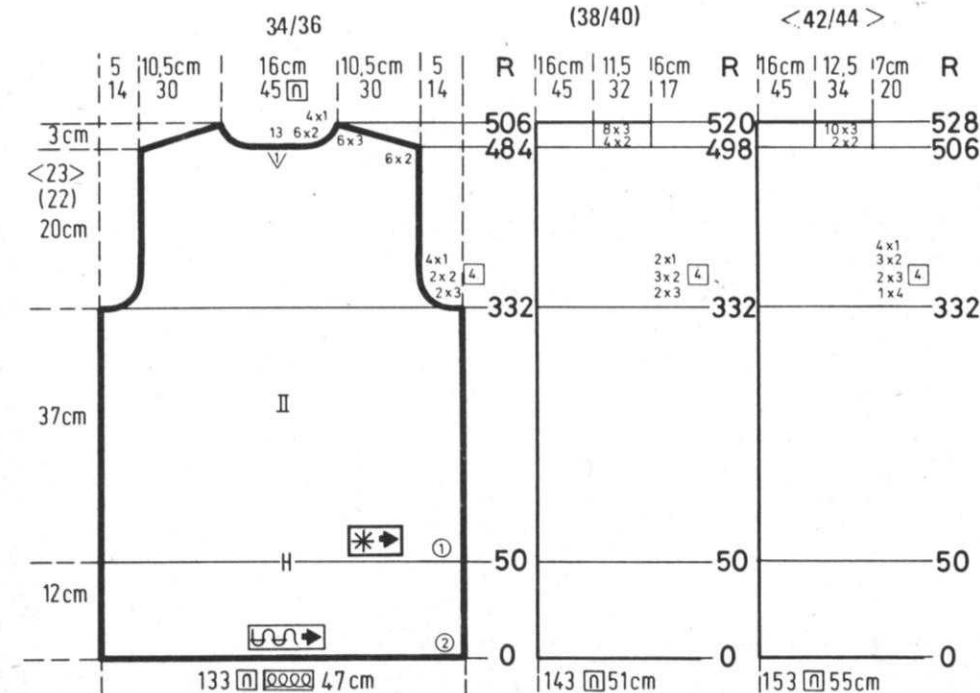

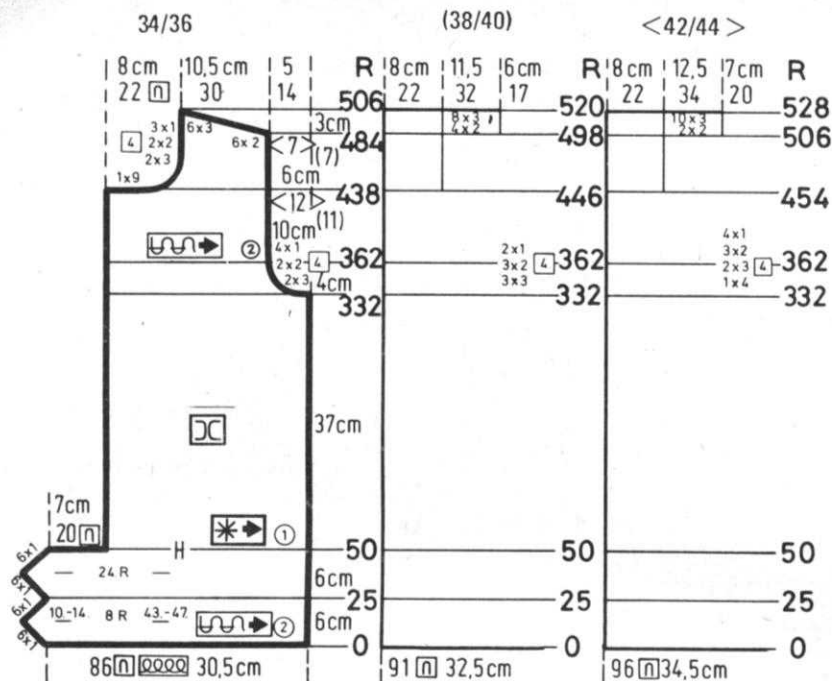

RIGHT FRONT: I

DO NOT MAKE BUTTONHOLES ON THIS SECTION. Cast on 86 (91) [96] sts. with color 2 and work Stockinette stitch. ON THE LEFT SIDE (right for second section) ON EVERY OTHER ROW, increase 1 st. 6x, decrease 1 st. 6x, increase 1 st. 6x, decrease 1 st. 6x. After Row 50, bind off 20 sts. on the left side (right for second section) and hang 66 cast on sts. on the RIGHT (left for second section) back onto the machine to form the hem. CHANGE to color 1 and continue in the Holding Position Design. Knit to Row 332.

SHAPE ARMHOLE: ON EVERY 4th ROW, bind off 3 sts. 2x, 2 sts. 2x, 1 st. 4x. (3 sts. 3x, 2 sts. 3x, 1 st. 2x). [4 sts. 1x, 3 sts. 2x, 2 sts. 3x, 1 st. 4x]. After Row 362, change to color 2 and continue in Stockinette stitch. After Row 439 (447) [455], SHAPE NECK: Bind off 9 sts., then on EVERY 4th ROW, bind off 3 sts. 2x, 2 sts. 2x, 1 st. 3x.

SHAPE SHOULDER after Row 484 (498) [506]: Bind off 2 sts. 6x, 3 sts. 6x. (2 sts. 4x, 3 sts. 8x). [2 sts. 2x, 3 sts. 10x]. Work the LEFT FRONT with reverse shaping, making BUTTONHOLES over needles 10 to 14 and 43 to 47 counting from the RIGHT EDGE after Rows 8 and 24.

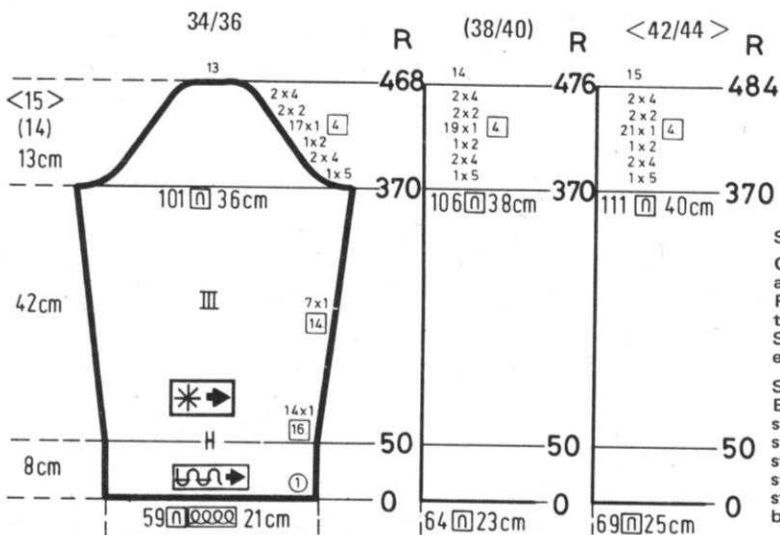

SLEEVE: III

Cast on 59 (64) [69] sts. with color 1 and work Stockinette stitch. Knit to Row 50, then hang the hem. Continue in the Holding Position Design. ON EACH SIDE, increase 1 st. every 16th row 14x, every 14th row 7x. Knit to Row 370.

SHAPE CAP: ON EACH SIDE, ON EVERY 4th ROW, bind off 5 sts. 1x, 4 sts. 2x, 2 sts. 1x, 1 st. 17x, 2 sts. 2x, 4 sts. 2x. (5 sts. 1x, 4 sts. 2x, 2 sts. 1x, 1 st. 19x, 2 sts. 2x, 4 sts. 2x). [5 sts. 1x, 4 sts. 2x, 2 sts. 1x, 1 st. 21x, 2 sts. 2x, 4 sts. 2x]. After Row 468 (476) [484], bind off the remaining 13 (14) [15] sts.

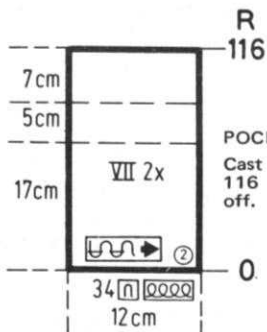

POCKET: VII Make 2.

Cast on 34 sts. with color 2 and work 116 rows Stockinette stitch, then bind off.

knit carrying bags

Completely new design in heavy duty canvas with waterproof interior. For AM 3 Knitter and Yarn Container.

List Price: \$29.50

For Ribber only: \$17.50

(California residents add Sales Tax)

Shipping Costs: \$1.75 and \$1.00

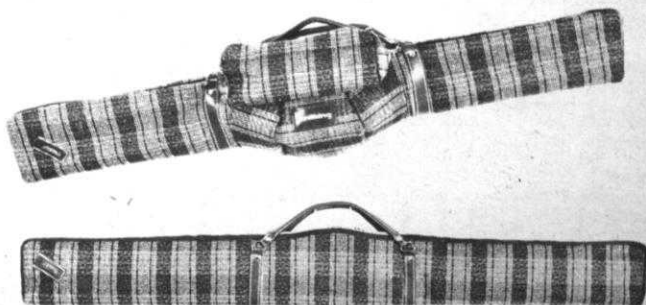

KK 81

GIRL'S SKIRT AND SLEEVELESS PULLOVER

SIZE: 8/9 (10/11) [12/13]

YARN: Allegro

grams C1 250 300 350

grams C2 50 50 50

grams C3 50 50 50

TENSION: 7 to 9

GAUGE: 15 sts. 23 rows = 5 cm

Stockinette stitch with 1 x 1 Ribbing for the Bands. The knit side is the right side.

FINISHING: See General Instructions.

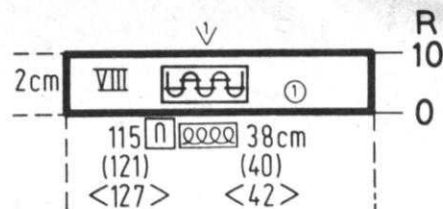

NECKBAND: VIII

Cast on 115 (121) [127] sts. with color 1 and work 10 rows K1, P1 Ribbing, then bind off the crochet method for Ribbing.

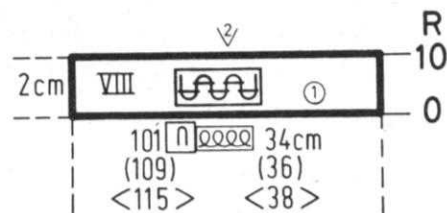

ARMHOLE BANDS: VIII Make 2.

Cast on 101 (109) [115] sts. with color 1 and work 10 rows K1, P1 Ribbing, then bind off the crochet method for Ribbing.

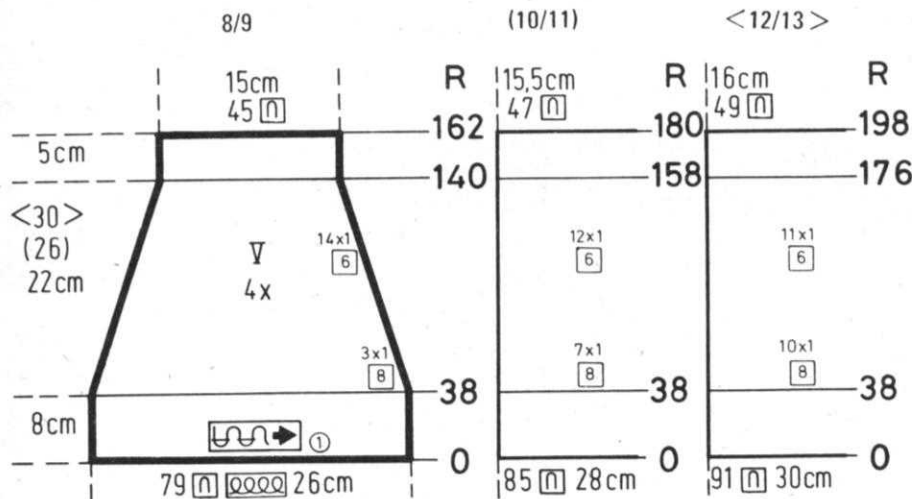

SKIRT: V Make 4 sections.

Cast on 79 (85) [91] sts. with color 1 and work Stockinette stitch. Knit to Row 38. ON EACH SIDE, decrease 1 st. every 8th row 3x (7x) [10x], every 6th row 14x (12x) [11x]. Knit to Row 162 (180) [198], then bind off the remaining 45 (47) [49] sts.

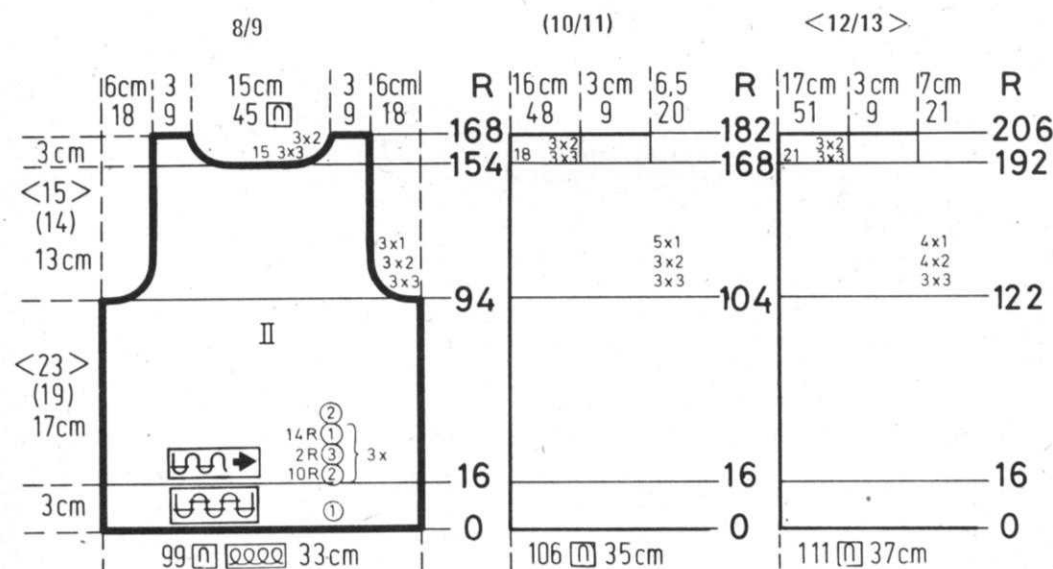

PULLOVER BACK: II

Cast on 99 (106) [111] sts. with color 1 and work 16 rows K1, P1 Ribbing. Change to Stockinette stitch and work the color stripes as shown on the Chart. Knit to Row 94 (104) [122].

SHAPE ARMHOLE: ON EACH SIDE, bind off 3 sts. 3x, 2 sts. 3x, 1 st. 3x. (3 sts. 3x, 2 sts. 3x, 1 st. 5x). [3 sts. 3x, 2 sts. 4x, 1 st. 4x]. Knit to Row 154 (168) [192]. Bind off the center 15 (18) [21] sts., put the needles on the left into holding position and complete the right half first.

*ON NECK SIDE, for ALL SIZES, bind off 3 sts. 3x, 2 sts. 3x. After Row 168 (182) [206], bind off the remaining 9 sts. Move the Cam Box to the left side, turn the Row Counter back to 154 (168) [192] and complete the left half. Follow the instructions from *.

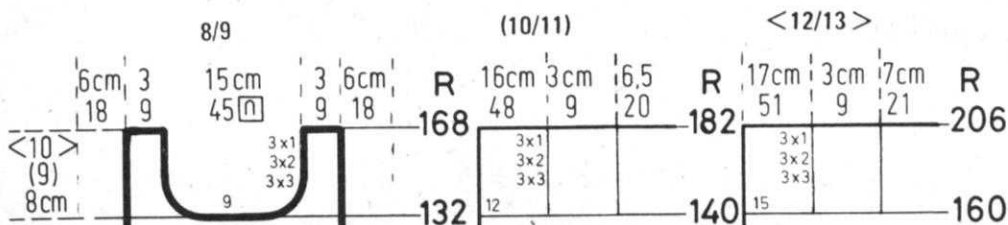

PULLOVER FRONT: I

Work the front section the same as the back to Row 132 (140) [160]. Bind off the center 9 (12) [15] sts., put the needles on the left into holding position and complete the right half first.

*ON NECK SIDE, FOR ALL SIZES, bind off 3 sts. 3x, 2 sts. 3x, 1 st. 3x. After Row 168 (182) [206], bind off the remaining 9 sts. Move the Cam Box to the left side, turn the Row Counter back to 132 (140) [160] and complete the left half. Follow the instructions from *.

KK 82

GIRL'S SKIRT AND PULLOVER

SIZE: 5/6 (7/8) [9/10]
YARN: Flamingo
 grams C1 200 200 250
 grams C2 50 50 50
 grams C3 50 50 50
TENSION: 7 to 9
GAUGE: 15 sts. 20 rows = 5 cm

The Skirt is in Stockinette stitch knitted sideways on the machine using Short Rows. The Pullover is Stockinette stitch with repeated color stripes as shown on the Chart. All Bands are K1, P1 Ribbing. The knit side is the right side.

FINISHING: See General Instructions. Weave the open sts. of the skirt together, then remove the waste yarn. Make hem on lower edge and at waistline, then insert elastic at waist.

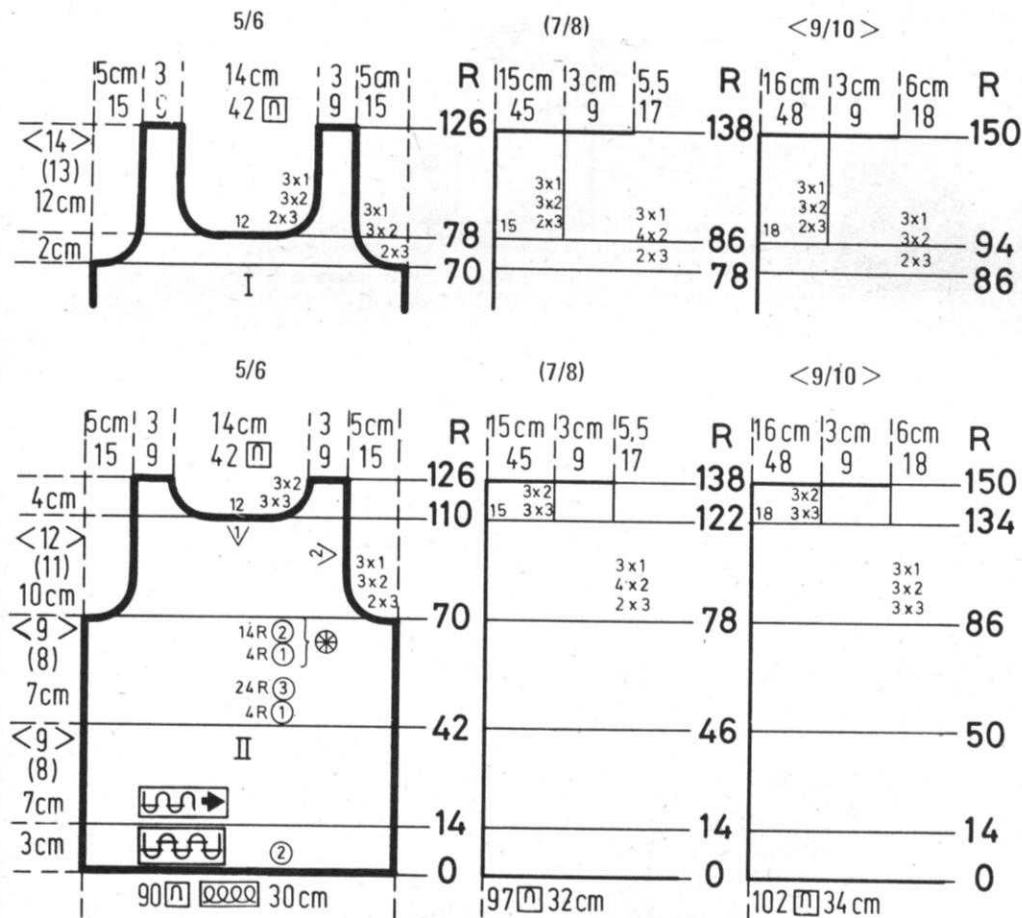

PULLOVER FRONT: I

Work the front section the same as the back to Row 78 (86) [94]. Bind off the center 12 (15) [18] sts., put the needles on the left into holding position and complete the right half first.

*Continue the armhole shaping and the color stripes same as the back and on **NECK SIDE**, for all sizes, bind off 3 sts. 2x, 2 sts. 3x, 1 st. 3x. After Row 126 (138) [150], bind off the remaining 9 sts. Bring the needles on the left into working position, knit 1 row to the left side, turn the Row Counter back to 78 (86) [94] and complete the left half. Follow the instructions from *.

PULLOVER BACK: II

Cast on 90 (97) [102] sts. with color 2 and work 14 rows K1, P1 Ribbing. Change to Stockinette stitch and knit to Row 42 (46) [50], then begin the color stripes as marked on the Chart.

After Row 70 (78) [86], **SHAPE ARMHOLE: ON EACH SIDE**, bind off 3 sts. 2x, 2 sts. 3x, 1 st. 3x. (3 sts. 2x, 2 sts. 4x, 1 st. 3x). [3 sts. 3x, 2 sts. 3x, 1 st. 3x]. Knit to Row 110 (122) [134]. Bind off the center 12 (15) [18] sts., put the needles on the left into holding position and complete the right half first.

***ON NECK SIDE, FOR ALL SIZES**, bind off 3 sts. 3x, 2 sts. 3x. After Row 126 (138) [150], bind off the remaining 9 sts. Bring the needles on the left into working position, knit 1 row to the left side, turn the Row Counter back to 110 (122) [134] and complete the left half. Follow the instructions from *.

SKIRT: V

With contrast waste yarn, cast on 84 (96) [108] sts. Knit 8 to 10 rows ending with Cam Box on the right side. Change to garment yarn - color 1 and turn the Row Counter to 0.

*Knit 8 rows, then work Short Rows. **ON OPPOSITE SIDE OF CAM BOX**, put into holding position 63 (71) [79] needles, knit 2 rows. **ON OPPOSITE SIDE OF CAM BOX**, bring back into working position 6 (7) [8] needles 8x. **ON OPPOSITE SIDE OF CAM BOX**, put into holding position 6 (7) [8] needles 8x. **ON OPPOSITE SIDE OF CAM BOX**, bring all the needles into working position and knit to Row 50.

REPEAT FROM * 14x (15x) [16x] more. Knit 8 to 10 rows using contrast waste yarn, then remove the work from the machine by passing the Cam Box across without yarn.

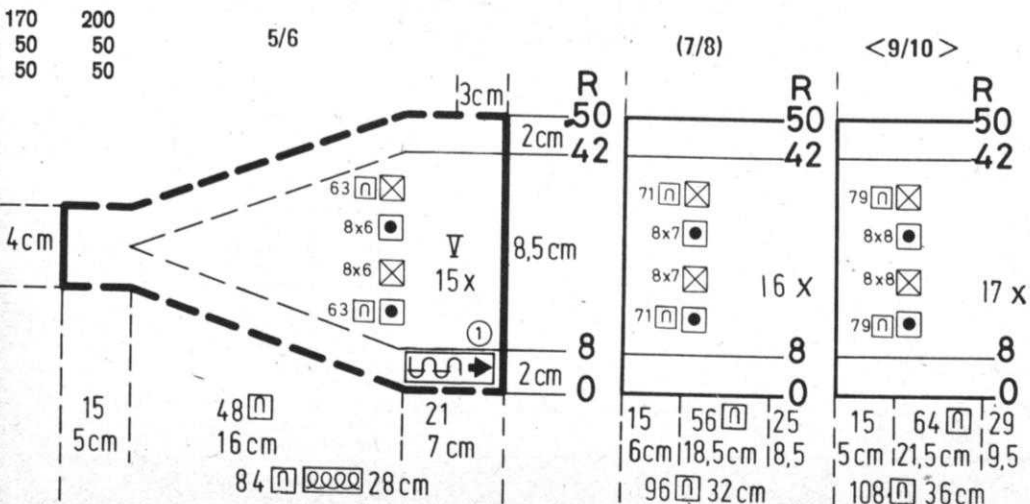

Continued

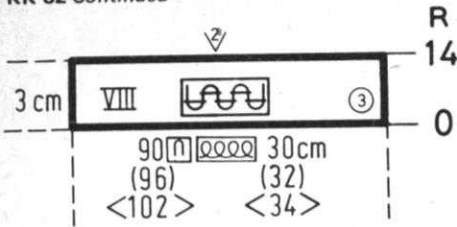

ARMHOLE BAND: VIII
Cast on 90 (96) [102] sts. with color 3 and work 14 rows K1, P1 Ribbing, then bind off the crochet method for Ribbing.

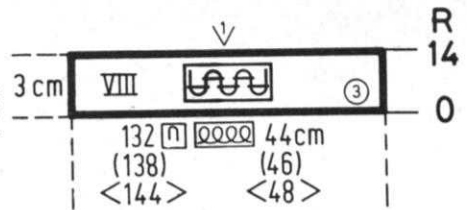

NECKBAND: VIII
Cast on 132 (138) [144] sts. with color 3 and work 14 rows K1, P1 Ribbing, then bind off the crochet method for Ribbing.

KK 83

GIRL'S JACKET, SKIRT AND PULLOVER

SIZE: 11/12 (13/14) [15/16]
YARN: Allegro
grams C1 600 650 700
grams C2 100 100 100
TENSION: 5 to 7
GAUGE: 15 sts. 23 rows = 5 cm

Stockinette stitch with color stripes as shown on the Charts. The knit side is the right side. Sleeve and Neckbands, K1, P1 Ribbing.

FINISHING: See General Instructions.

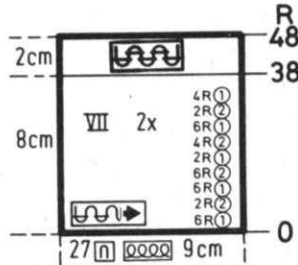

JACKET POCKET: VII Make 2.
Cast on 27 sts. with color 1 and work Stockinette stitch and color stripes as shown on the Chart. After Row 38, change to K1, P1 Ribbing and knit to Row 48, then bind off the crochet method for ribbing.

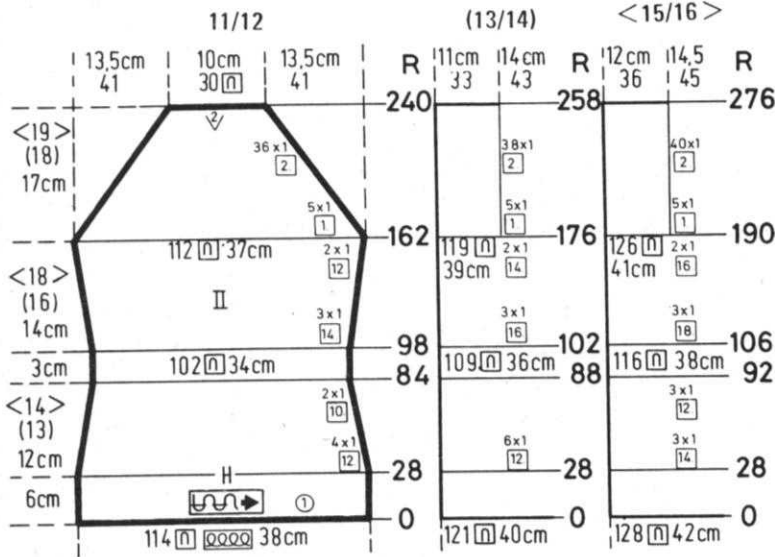

JACKET BACK: II

Cast on 114 (121) [128] sts. with color 1 and work Stockinette stitch. Knit to Row 28, hang the hem. **ON EACH SIDE**, decrease 1 st. every 12th row 4x, every 10th row 2x. (every 12th row 6x). [every 14th row 3x, every 12th row 3x]. Knit to Row 98 (102) [106]. **ON EACH SIDE**, increase 1 st. every 14th row 3x, every 12th row 2x. (every 16th row 3x, every 14th row 2x). [every 18th row 3x, every 16th row 2x].

After Row 162 (176) [190], **SHAPE RAGLAN: ON EACH SIDE**, decrease 1 st. EVERY ROW 5x, every 2nd row 36x. (EVERY ROW 5x, every 2nd row 38x). [EVERY ROW 5x, every 2nd row 40x]. After Row 240 (258) [276], bind off the remaining 30 (33) [36] sts.

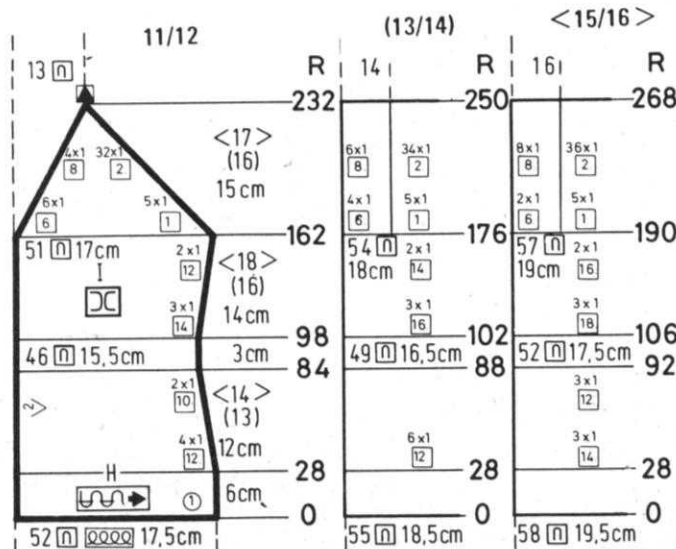

JACKET FRONT: I Make 1, reverse 1.

Cast on 52 (55) [58] sts. with color 1 and work Stockinette stitch. Knit to Row 28, hang the hem. **ON SIDE EDGE**, decrease 1 st. every 12th row 4x, every 10th row 2x. (every 12th row 6x). [every 14th row 3x, every 12th row 3x]. Knit to Row 98 (102) [106]. **ON SIDE EDGE**, increase 1 st. every 14th row 3x, every 12th row 2x. (every 16th row 3x, every 14th row 2x). [every 18th row 3x, every 16th row 2x].

After Row 162 (176) [190], **SHAPE ARMHOLE AND NECK AT THE SAME TIME. FOR ARMHOLE**, decrease 1 st. EVERY ROW 5x, every 2nd row 32x. (EVERY ROW 5x, every 2nd row 34x). [EVERY ROW 5x, every 2nd row 36x]. **FOR NECK**, decrease 1 st. every 6th row 6x, every 8th row 4x. (every 6th row 4x, every 8th row 6x). [every 6th row 2x, every 8th row 8x].

11/12

(13/14)

<15/16>

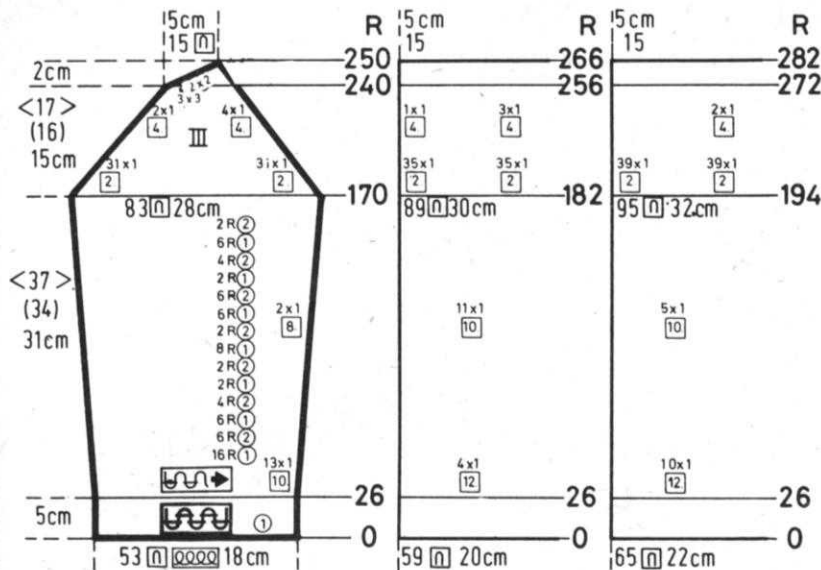

JACKET SLEEVE: III Make 1, reverse 1.

Cast on 53 (59) [65] sts. with color 1 and work 26 rows K1, P1 Ribbing. Change to Stockinette stitch and color stripes as marked on the Chart. ON EACH SIDE, increase 1 st. every 10th row 13x, every 8th row 2x. (every 12th row 4x, every 10th row 11x). [every 12th row 10x, every 10th row 5x].

After Row 170 (182) [194], SHAPE RAGLAN. ON EACH SIDE, decrease 1 st. every 2nd row 31x (35x) [39x]. ON EVERY 4th row, decrease 1 st. ON BACK SIDE OF SLEEVE 4x (3x) [2x]. ON FRONT SIDE OF SLEEVE 2x (1x). After Row 240 (256) [272], work Short Rows.

ON OPPOSITE SIDE OF CAM BOX, put into holding position, 3 sts. 3x, 2 sts. 2x. After Row 250 (266) [282], bring all the needles back into working position and bind off.

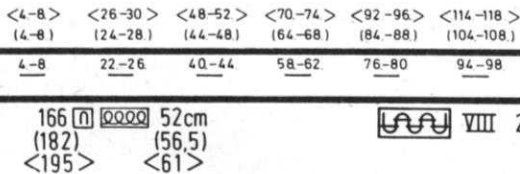

BUTTONHOLE BAND: VIII

Cast on 166 (182) [195] sts. with color 1 and work K1, P1 Ribbing. After Row 8, make BUTTONHOLES over the specified needles marked on the Chart for YOUR SIZE. After Row 16, bind off the crochet method for Ribbing. Make a BUTTON BAND the same but omit the buttonholes.

11/12

(13/14)

<15/16>

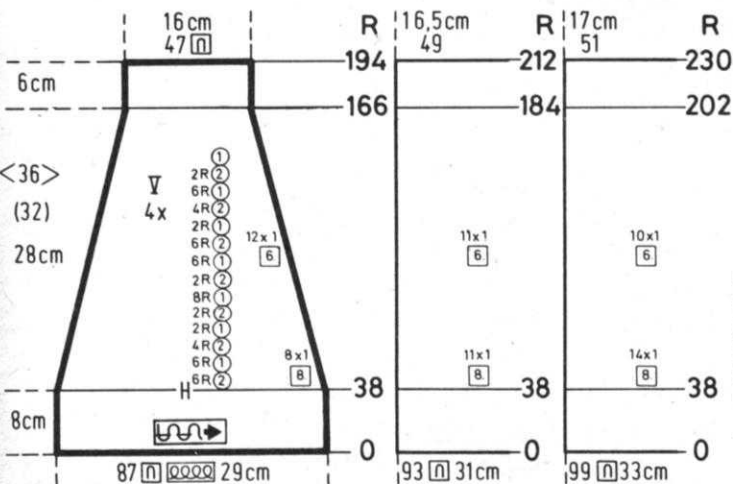

SKIRT: V Make 4 sections.

Cast on 87 (93) [99] sts. with color 1 and work Stockinette stitch. After Row 38, hang the hem, then begin the color stripes as shown on the Chart. ON EACH SIDE, decrease 1 st. every 8th row 8x (11x) [14x], every 6th row 12x (11x) [10x]. Knit to Row 194 (212) [230], then bind off the remaining 47 (49) [51] sts.

PULLOVER NECKBAND: VIII

Cast on 116 (122) [128] sts. with color 1 and work 10 rows K1, P1 Ribbing, then bind off the crochet method for Ribbing.

11/12

(13/14)

<15/16>

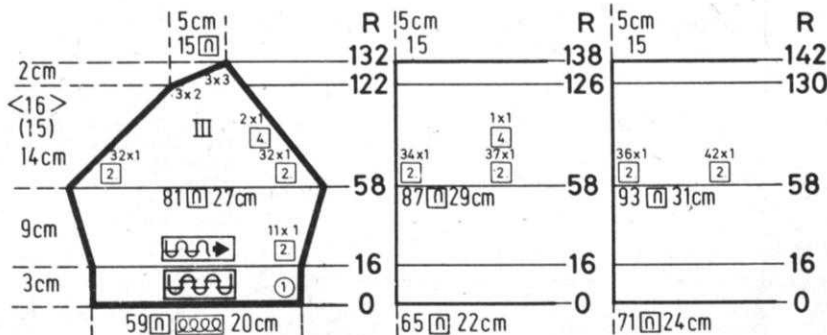

PULLOVER SLEEVE: III Make 1, reverse 1.

Cast on 59 (65) [71] sts. with color 1 and work 16 rows K1, P1 Ribbing, then change to Stockinette stitch. ON EACH SIDE, increase 1 st. every 2nd row 11x. After Row 58, SHAPE RAGLAN: Decrease 1 st. ON BACK SIDE OF SLEEVE: every 2nd row 32x (37x) [42x], every 4th row 2x (1x). ON FRONT SIDE OF SLEEVE: every 2nd row 32x (34x) [36x]. After Row 122 (126) [130], work Short Rows.

ON OPPOSITE SIDE OF CAM BOX, put into holding position, 2 sts. 3x, 3 sts. 3x. After Row 132 (138) [142], bring all the needles into working position and bind off.

Continued

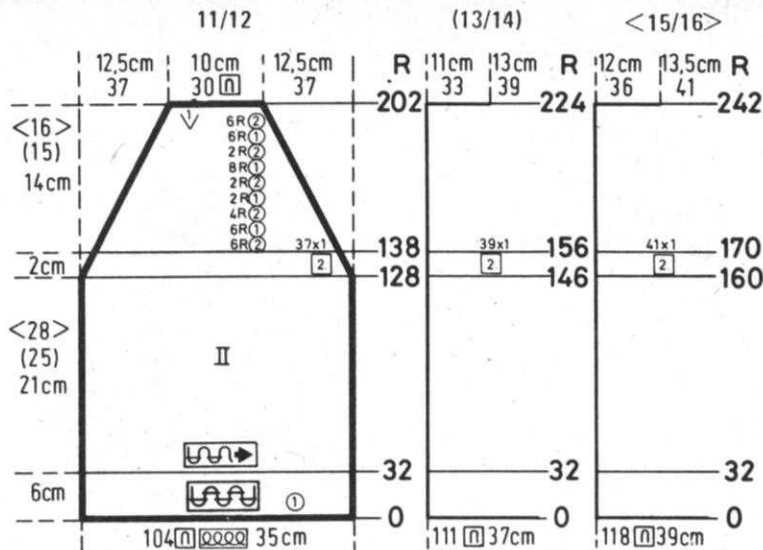

PULLOVER BACK: II
 Cast on 104 (111) [118] sts. with color 1 and work 32 rows K1, P1 Ribbing to Row 32. Change to Stockinette stitch and knit even to Row 128 (146) [160]. SHAPE RAGLAN and work color stripes as shown on the Chart. ON EACH SIDE, decrease 1 st. every 2nd row 37x (39x) [41x]. After Row 202 (224) [242], bind off the remaining 30 (33) [36] sts.

KK 84



BOY'S PANTSUIT

SIZE: 4/5 (6/7) [8/9]
YARN: Allegro
 grams C1 450 500 550
 grams C2 100 100 100
Jacket type: Zipper.
TENSION: 5 to 7
GAUGE: 15 sts. 23 rows = 5 cm

Stockinette stitch with changing colors as shown on the Charts. Bands: K1, P1 Ribbing. The knit side is the right side.
FINISHING: See General Instructions. With color 2, single crochet down front of Jacket, then sew in zipper. Sew pocket flaps in place (see picture).

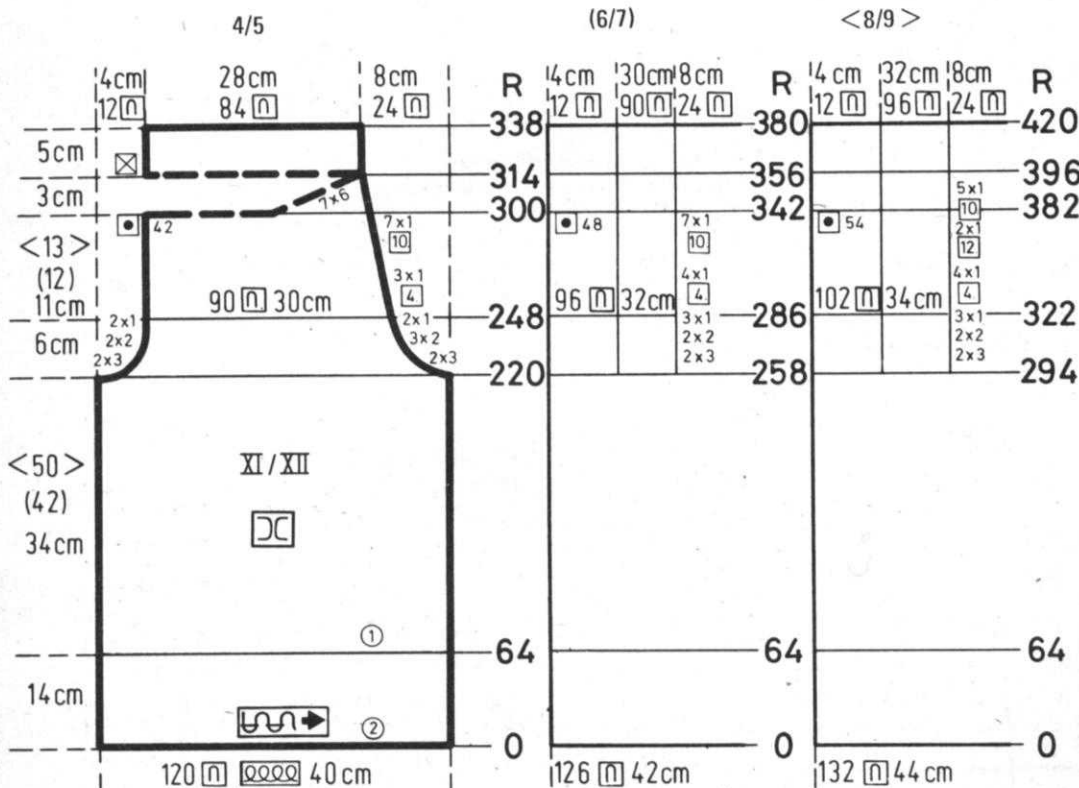

PANTS: XI/XII Make 1, reverse 1.
 Cast on 120 (126) [132] sts. with color 2 and work Stockinette stitch. Knit to Row 64, then change to color 1. Knit to Row 220 (258) [294]. SHAPE CROTCH: Bind off FOR CENTER BACK: 3 sts. 2x, 2 sts. 3x, 1 st. 2x, then every 4th row 1 st. 3x, every 10th row 1 st. 7x. (3 sts. 2x, 2 sts. 2x, 1 st. 3x, then every 4th row 1 st. 4x, every 10th row 1 st. 7x). [3 sts. 2x, 2 sts. 2x, 1 st. 3x, then every 4th row 1 st. 4x, every 12th row 1 st. 2x, every 10th row 1 st. 5x]. FOR CENTER FRONT: ALL SIZES THE SAME: 3 sts. 2x, 2 sts. 2x, 1 st. 2x. After Row 300 (342) [382], work Short Rows.
 ON OPPOSITE SIDE OF CAM BOX, put into holding position 42 (48) [54] needles 1x, 6 needles 7x. Bring all the needles back into working position before knitting the next row, then knit to Row 338 (380) [420] and bind off the remaining 84 (90) [96] sts.

PULLOVER FRONT: I

Work the front the same as the back to Row 170 (192) [210]. Bind off the center 10 sts., put the needles on the left into holding position and complete the right half first.

*Continue the Raglan shaping as you did on the back with color stripes and ON NECK SIDE, bind off 2 sts. 3x, 1 st. 3x, then every 4th row 1 st. 2x. Bring the needles on the left into working position, knit 1 row to the left side, turn the Row Counter back to 170 (192) [210] and complete the left half. Follow the instructions from *.

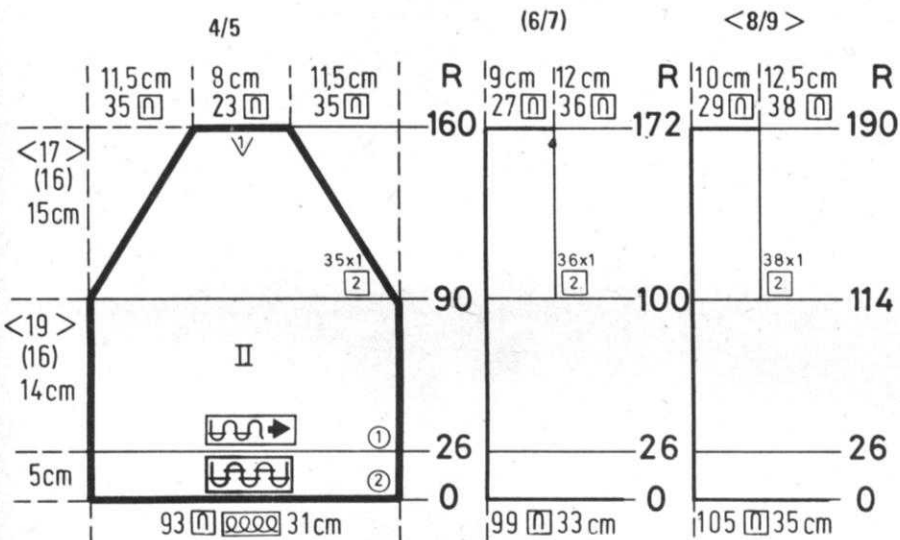
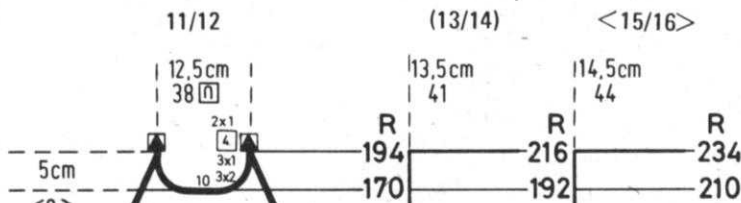

JACKET BACK: II

Cast on 93 (99) [105] sts. with color 2 and work 26 rows K1, P1 Ribbing. Change to Stockinette stitch and color 1. Knit to Row 90 (100) [114].

SHAPE RAGLAN: ON EACH SIDE, decrease 1 st. every 2nd row 35x (36x) [38x]. After Row 160 (172) [190], bind off the remaining 23 (27) [29] sts.

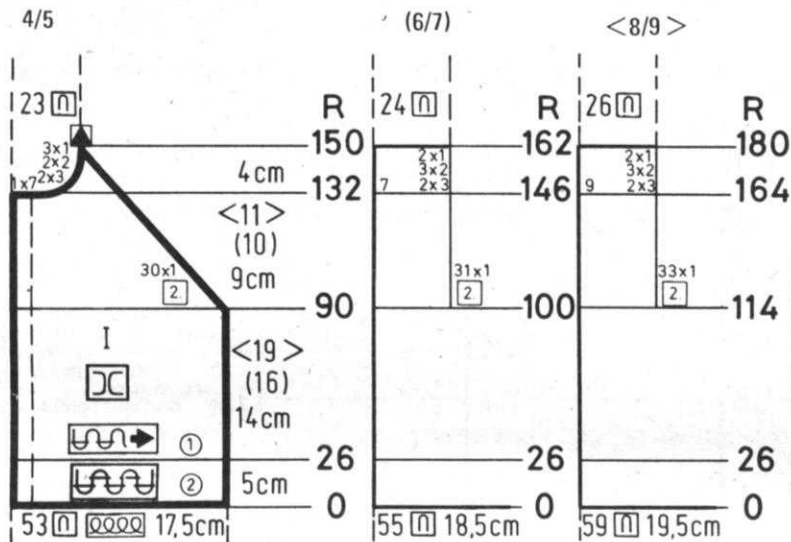

JACKET FRONT: I Make 1, reverse 1.

Cast on 53 (55) [59] sts. with color 2 and work 26 rows K1, P1 Ribbing. Change to Stockinette stitch and color 1. Knit to Row 90 (100) [114].

SHAPE RAGLAN: Decrease 1 st. every 2nd row 30x (31x) [33x] AND AT THE SAME TIME after Row 133 (147) [165], bind off 7 (7) [9] sts. for neck, then ON NECK SIDE, bind off 3 sts. 2x, 2 sts. 2x, 1 st. 3x. (3 sts. 2x, 2 sts. 3x, 1 st. 2x). [3 sts. 2x, 2 sts. 3x, 1 st. 2x].

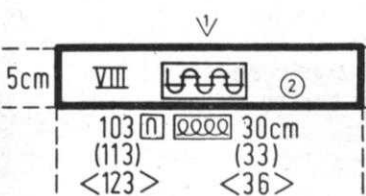

JACKET NECKBAND: VIII

Cast on 103 (113) [123] sts. with color 2 and work 26 rows K1, P1 Ribbing, then bind off the crochet method for Ribbing.

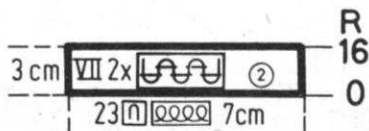

FLAP: VIII

Cast on 23 sts. with color 2 and work 16 rows K1, P1 Ribbing, then bind off the crochet method for Ribbing.

Continued

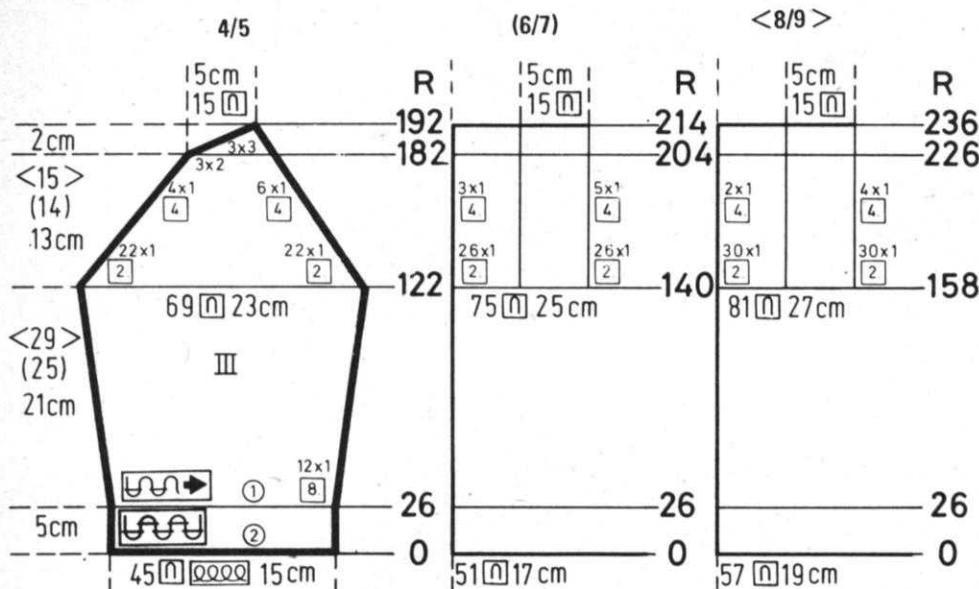

JACKET SLEEVE: III Make 1, reverse 1.

Cast on 45 (51) [57] sts. with color 2 and work 26 rows K1, P1 Ribbing. Change to Stockinette stitch and color 1. ON EACH SIDE, increase 1 st. every 8th row 12x. Knit to Row 122 (140) [158].

SHAPE RAGLAN: ON EACH SIDE, decrease 1 st. every 2nd row 22x (26x) [30x], then decrease 1 st. every 4th row ON BACK SIDE OF SLEEVE: 6x (5x) [4x]. ON FRONT SIDE OF SLEEVE: 4x (3x) [2x]. After Row 182 (204) [226], work Short Rows.

ON OPPOSITE SIDE OF CAM BOX, put into holding position, 2 sts. 3x, 3 sts. 3x. After Row 192 (214) [236], bring all the needles into working position and bind off.

KK 85 B

CHILD'S PULLOVER

SIZE: 11/12 (13/14) [15/16]

YARN: Flamingo

grams C1 250 300 350
grams C2 50 50 50
grams C3 50 50 50

TENSION: 7 to 9

GAUGE: 14 sts. 19 rows = 5 cm

Stockinette stitch with color stripes as shown on the Charts. The purl side is the right side. Bands: K1, P1 Ribbing.

FINISHING: See General Instructions.

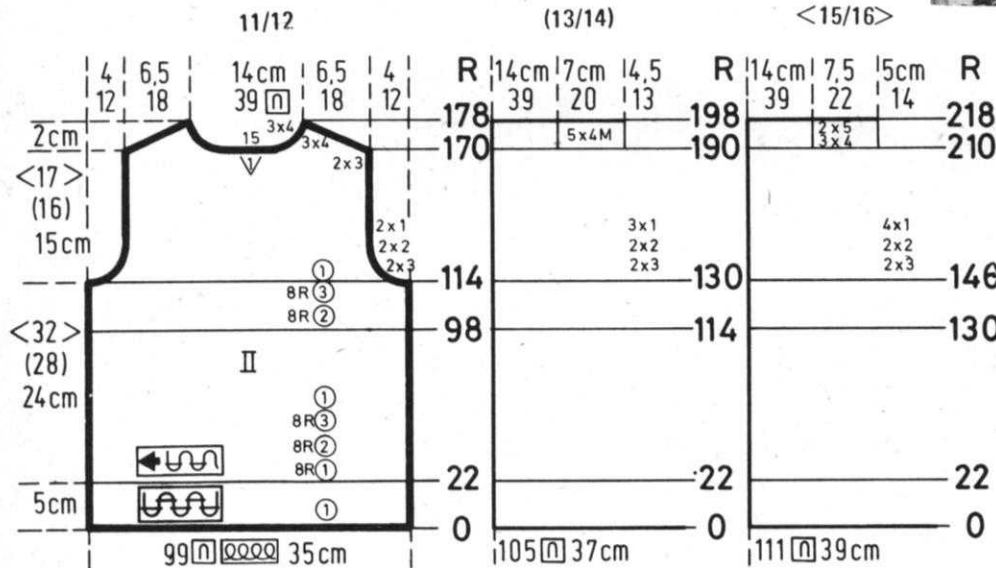

PULLOVER BACK: II

Cast on 99 (105) [111] sts. with color 1 and work 22 rows K1, P1 Ribbing. Change to Stockinette stitch with color stripes as marked on the Chart. Knit to Row 98 (114) [130] and work the color stripes to Row 114 (130) [146]. Continue with color 1.

SHAPE ARMHOLE: ON EACH SIDE, bind off 3 sts. 2x. 2 sts. 2x. 1 st. 2x. (3 sts. 2x, 2 sts. 2x, 1 st. 3x). [3 sts. 2x, 2 sts. 2x, 1 st. 4x]. Knit to Row 170 (190) [210]. Bind off the center 15 sts., put the needles on the left into holding position and complete the right half first.

*SHAPE NECK AND SHOULDER AT THE SAME TIME: Bind off FOR SHOULDER: 3 sts. 2x, 4 sts. 3x. (4 sts. 5x) [4 sts. 3x, 5 sts. 2x]. FOR NECK: ALL SIZES THE SAME: 4 sts. 3x. Move the Cam Box to the left side, turn the Row Counter back to 170 (190) [210] and complete the left half. Follow the instructions from *.

PULLOVER FRONT: I

Work the front section the same as the back to Row 150 (170) [190], bind off the center 13 sts., put the needles on the left into holding position and complete the right half first.

*ON NECK SIDE, bind off 3 sts. 2x, 2 sts. 2x, 1 st. 3x. SHAPE SHOULDER after Row 170 (190) [210]. Bind off 3 sts. 2x, 4 sts. 3x. (4 sts. 5x). [4 sts. 3x, 5 sts. 2x]. Bring the Cam Box to the left side, turn the Row Counter back to 150 (170) [190] and complete the left half. Follow the instructions from *.

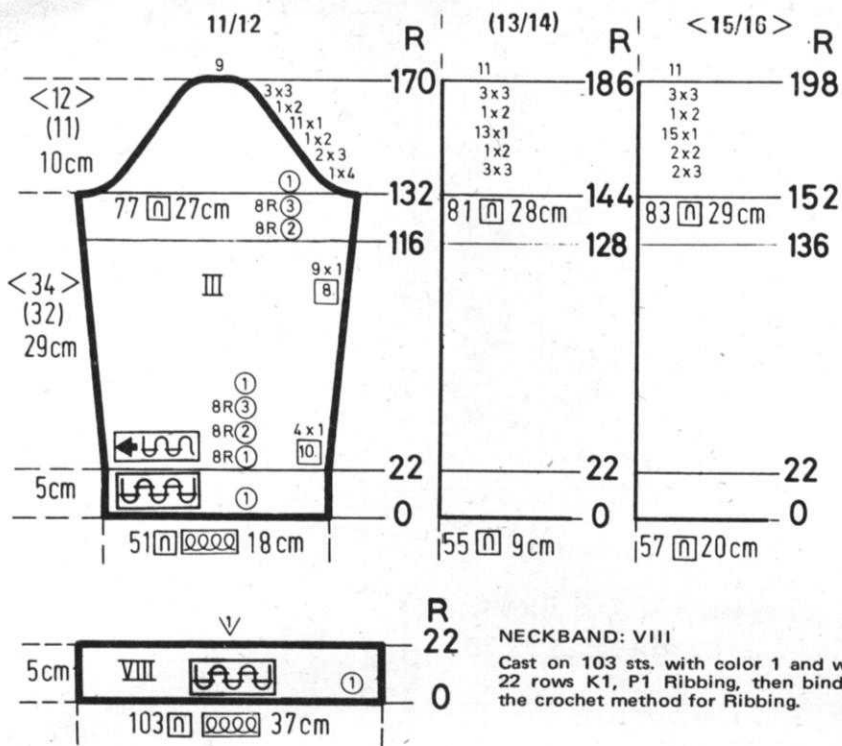

PULLOVER SLEEVE: III

Cast on 51 (55) [57] sts. with color 1 and work 22 rows K1, P1 Ribbing. Change to Stockinette stitch and color stripes as shown on the Chart. ON EACH SIDE, increase 1 st. every 10th row 4x, every 8th row 9x. After Row 116 (128) [136], work the color stripes as shown on the Chart to Row 132 (144) [152], then continue with color 1.

SHAPE CAP: ON EACH SIDE, bind off 4 sts. 1x, 3 sts. 2x, 2 sts. 1x, 1 st. 11x, 2 sts. 1x, 3 sts. 3x. (3 sts. 3x, 2 sts. 1x, 1 st. 13x, 2 sts. 1x, 3 sts. 3x). [3 sts. 2x, 2 sts. 2x, 1 st. 15x, 2 sts. 1x, 3 sts. 3x]. After Row 170 (186) [198], bind off the remaining 9 (11) [11] sts.

are you unhappy with your present knitting machine?

- DOES IT REFUSE TO KNIT FANCY DRESS YARNS?
- DOES IT JAM UP WHEN YOU TRY TO KNIT LOOPED MOHAIR OR THICK AND THIN YARNS?
- DOES IT DROP STITCHES ALL OVER THE PLACE?
- ARE YOU CONTINUALLY HAVING TROUBLE WITH AWKWARD, CUMBERSOME WEIGHTS?
- ARE YOU UNABLE TO MAKE A LARGE GARMENT WITH BULKY YARNS?
- DO YOU HAVE TO SELECT PATTERN STITCHES MANUALLY?
- DO YOU HAVE TO LATCH YOUR RIBBING BY HAND?
- IF YOU ARE HAVING ANY OF THESE PROBLEMS YOU SHOULD TRADE UP TO A NEW FANTASTIC PUSH BUTTON KNITTING WITH COORDINATED RIBBER AND ENJOY KNITTING WITH THE WORLDS FINEST, MOST VERSATILE AND MOST AUTOMATIC KNITTER.

Send for your color brochure to: KNITKING - 1128 Crenshaw Blvd., Los Angeles, California 90019

KK 86

BOY'S PANTSUIT

SIZE: 3/4 (5/6) [7/8]

YARN: Amore

grams C1 400 450 500

grams C2 100 100 100

TENSION: 6 to 8

GAUGE:

Stock: 15 sts. 22 rows = 5 cm

Pattern: 15 sts. 18 rows = 5 cm

Pants: Stockinette stitch. Pullover: Norwegian Design according to the Line Drawing or use JAC 40 and Pattern No. 561. The knit side is the right side. Bands of Pullover are 1 x 1 Rib.

FINISHING: See General Instructions.

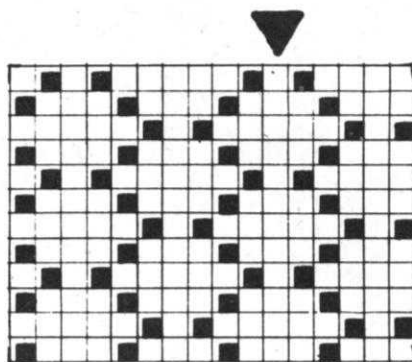

■ color 2 □ color 1



561

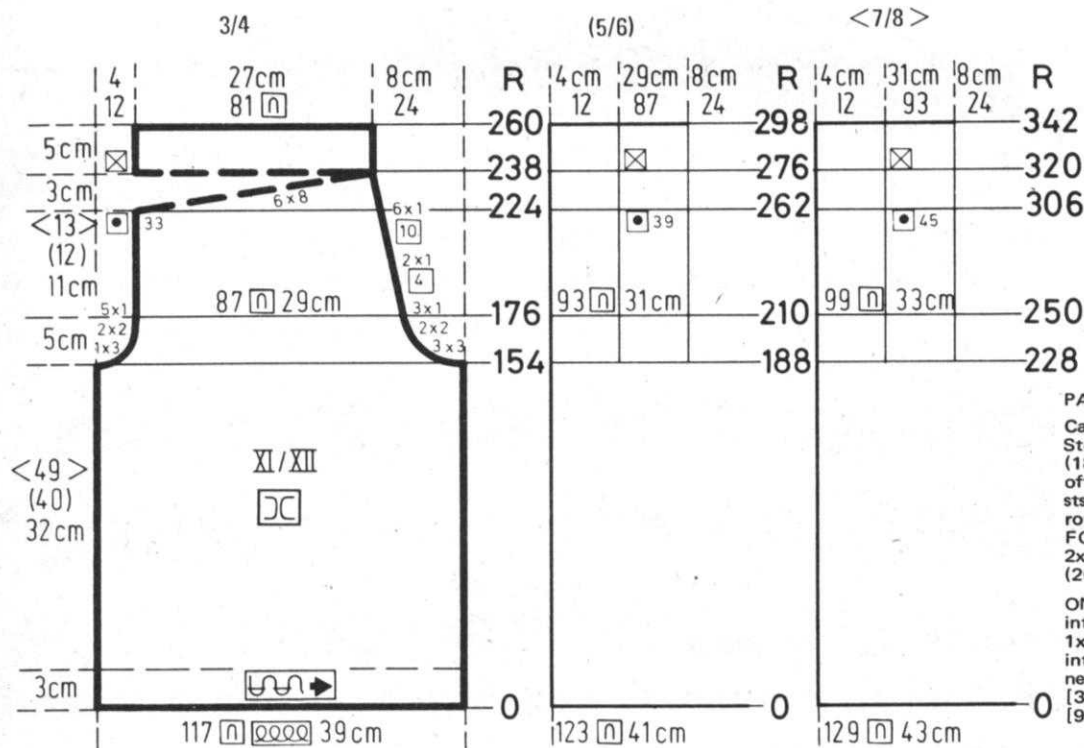

PANTS: XI/XII Make 1, reverse 1.

Cast on 117 (123) [129] sts. and work Stockinette stitch. Knit to Row 154 (188) [228]. SHAPE CROTCH: Bind off for all sizes FOR CENTER BACK: 3 sts. 3x, 2 sts. 2x, 1 st. 3x, then every 4th row 1 st. 2x, every 10th row 1 st. 6x. FOR CENTER FRONT: 3 sts. 1x, 2 sts. 2x, 1 st. 5x. AND AFTER ROW 224 (262) [306], work Short Rows.

ON OPPOSITE SIDE OF CAM BOX, put into holding position 33 (39) [45] sts. 1x, 8 sts. 6x. Bring all the needles back into working position before knitting the next row and knit to Row 260 (298) [342]. Bind off the remaining 81 (87) [93] sts.

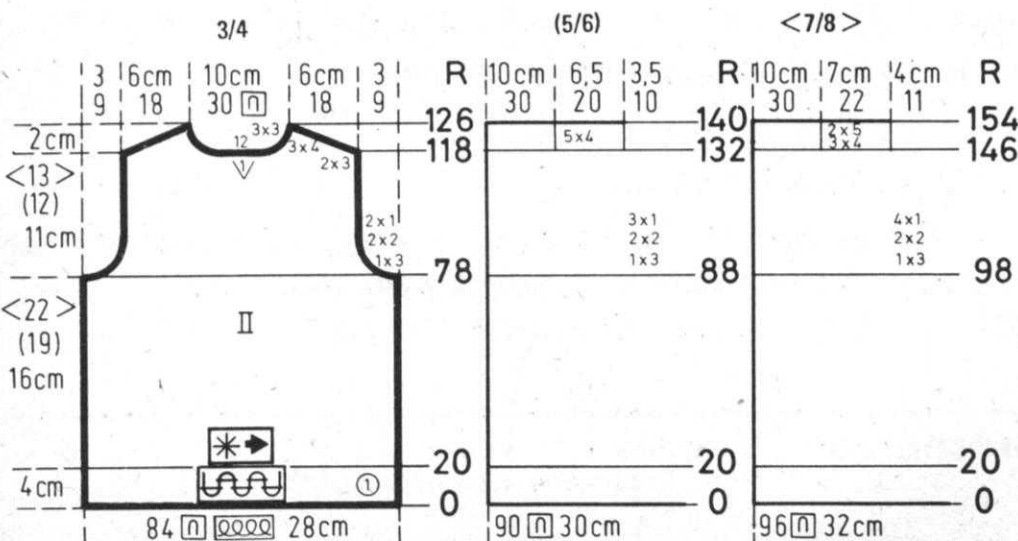

PULLOVER BACK: II

Cast on 84 (90) [96] sts. with color 1 and work 20 rows K1, P1 Ribbing. Change to the Norwegian Design. Knit to Row 78 (88) [98].

SHAPE ARMHOLE: ON EACH SIDE, bind off 3 sts. 1x, 2 sts. 2x, 1 st. 2x. (3 sts. 1x, 2 sts. 2x, 1 st. 3x). [3 sts. 1x, 2 sts. 2x, 1 st. 4x]. Knit to Row 118 (132) [146]. Bind off the center 12 sts., put the needles on the left into holding position and complete the right half first.

*SHAPE NECK AND SHOULDER AT THE SAME TIME: Bind off FOR SHOULDER: 3 sts. 2x, 4 sts. 3x. (4 sts. 5x). [4 sts. 3x, 5 sts. 2x]. FOR NECK: ALL SIZES THE SAME: 3 sts. 3x. Bring the needles on the left into working position, knit 1 row in Pattern to the left side, turn the Row Counter back to 118 (132) [146] and complete the left half. Follow the instructions from *.

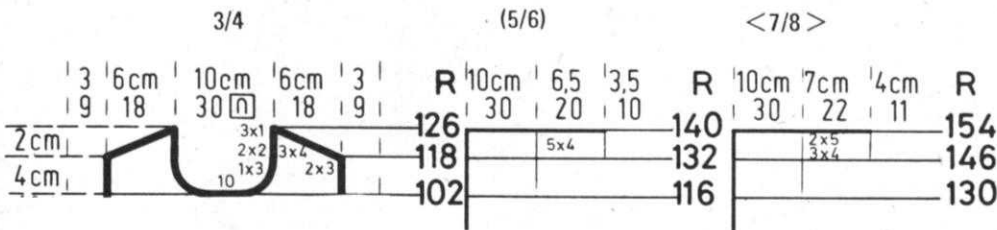

PULLOVER FRONT: I

Work the front the same as the back to Row 102 (116) [130]. Bind off the center 10 sts., put the needles on the left into holding position and complete the right half first.

*ON NECK SIDE, bind off 3 sts. 1x, 2 sts. 2x, 1 st. 3x. **SHAPE SHOULDER** after Row 118 (132) [146]. Bind off 3 sts. 2x, 4 sts. 3x. (4 sts. 5x). [4 sts. 3x, 5 sts. 2x]. Bring the needles on the left into working position, knit 1 row in Pattern to the left side, turn the Row Counter back to 102 (116) [130] and complete the left half. Follow the instructions from *.

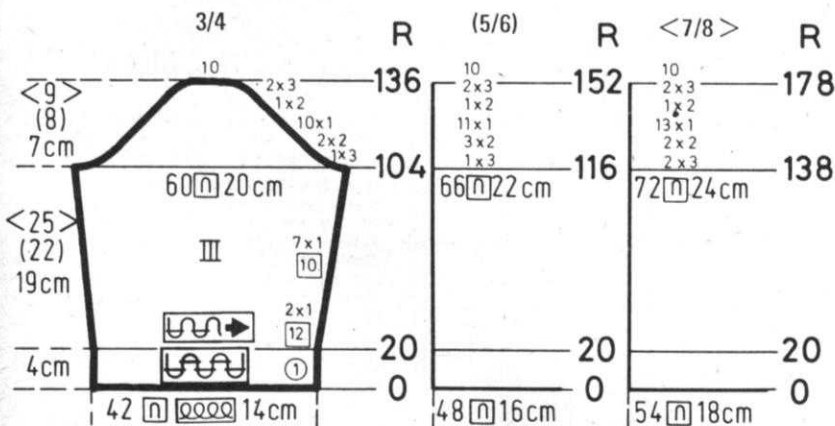

SLEEVE: III

Cast on 42 (48) [54] sts. with color 1 and work 20 rows K1, P1 Ribbing. Change to Stockinette stitch. **ON EACH SIDE**, increase 1 st. every 12th row 2x, every 10th row 7x. Knit to Row 104 (116) [138].

SHAPE CAP: ON EACH SIDE, bind off 3 sts. 1x, 2 sts. 2x, 1 st. 10x, 2 sts. 1x, 3 sts. 2x. (3 sts. 1x, 2 sts. 3x, 1 st. 11x, 2 sts. 1x, 3 sts. 2x). [3 sts. 2x, 2 sts. 2x, 1 st. 13x, 2 sts. 1x, 3 sts. 2x]. After Row 136 (152) [178], bind off the remaining 10 sts.

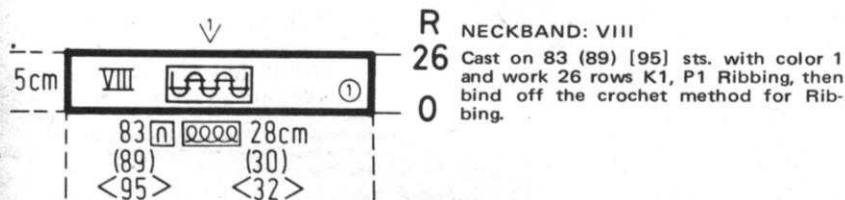

Cast on 83 (89) [95] sts. with color 1 and work 26 rows K1, P1 Ribbing, then bind off the crochet method for Ribbing.

knitking magnifier lamp

A perfect gift item for any knitter. It has a large (5") magnifying lens and a cool fluorescent tube light. It stays in any position and is wonderful for general illumination for you to work under when joining seams, etc. Color: light grey.

List Price: \$69.50

(California residents add Sales Tax)

Shipping Costs: \$3.00

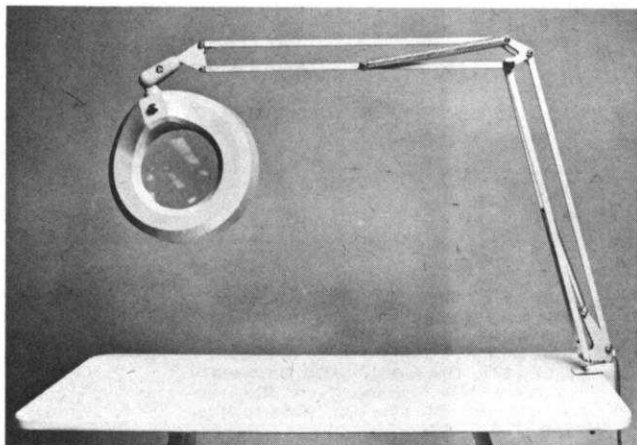

Order direct from KNITKING - 1128 Crenshaw Blvd., Los Angeles, California 90019

KK 87

CHILD'S PULLOVER AND CAP

SIZE: 5/6 (7/8) [9/10]

YARN: Allegro

grams C1	300	350	400
C2	50	50	50
C3	50	50	50

Neck type Zipper.

TENSION:

Stock: 9 to 10

Pattern 1: 6 to 8

Pattern 2: 5 to 7

GAUGE:

Stock: 14 sts. 23 rows = 5 cm

Pattern 1 13 sts. 40 rows = 5 cm

Pattern 2 14 sts. 30 rows = 5 cm

Stockinette stitch with a Holding Position Design and Weaving Pattern. Follow Line Drawings I and II. KNITTING machine owners, use Automatic Wheel W3 for Patterns I and II. The purl side of Patterns are the right side.

FINISHING: See General Instructions. Sew front neckbands to front opening, then sew in zipper. HAT: Sew back seams, then work 2 rows single crochet around neck edge and sew on loop and button.

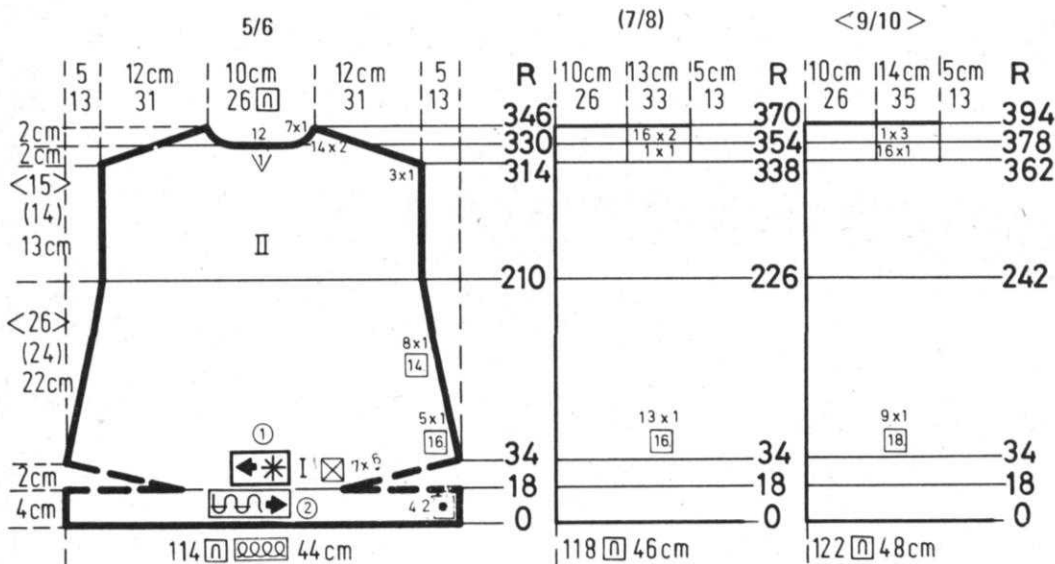

PULLOVER BACK: II

Cast on 114 (118) [122] sts. with color 2 and work Stockinette stitch to row 18. Change to color 1 and the Holding Position Design - Pattern I. Work Short Rows. ON OPPOSITE SIDE OF CAM BOX, put into holding position 42 needles before knitting the next 2 rows. ON OPPOSITE SIDE OF CAM BOX, bring back into working position 6 needles 7x ON EACH SIDE.

ON EACH SIDE, decrease 1 st. every 16th row 5x, every 14th row 8x. (every 16th row 13x). [every 18th row 9x]. Knit to Row 314 (338) [362].

SHAPE SHOULDER: Bind off 1 st. 3x, 2 sts. 14x. (1 st. 1x, 2 sts. 16x). [1 st. 16x, 3 sts. 1x]. AND AT THE SAME TIME, SHAPE NECK after Row 330 (354) [378]. Bind off the center 12 sts., put the needles on the left into holding position and complete the right half first. *ON NECK SIDE, bind off 1 st. 7x.

Bring the needles on the left into working position, knit 1 row in Pattern to the left side, turn the Row Counter back to 330 (354) [378] and complete the left half. Follow the instructions from * and be sure to complete the shoulder shaping at the same time.

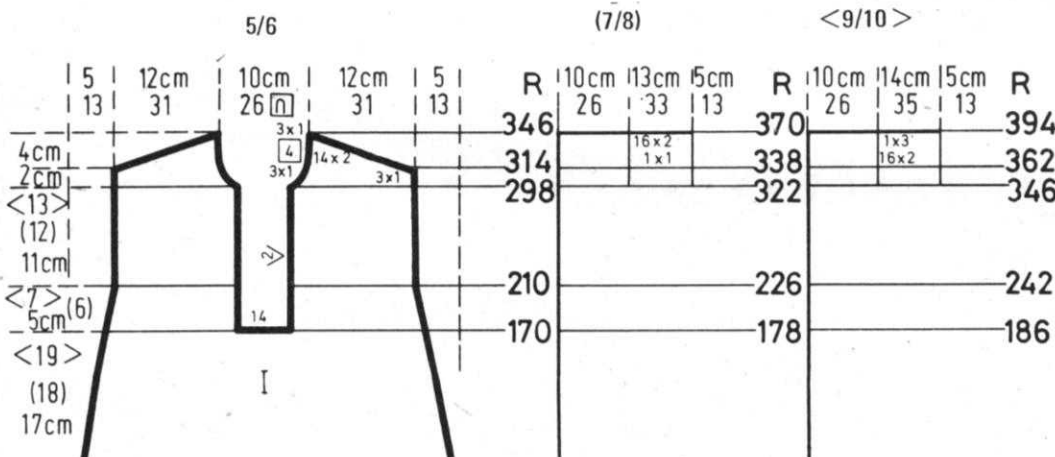

PULLOVER FRONT: I

Work the front section the same as the back to Row 170 (178) [186], bind off the center 14 sts., put the needles on the left into holding position and complete the right half first.

*Continue the decreases on the side edge as on the back section, then knit even to Row 298. ON NECK SIDE, decrease 1 st. 3x, then every 4th row, decrease 1 st. 3x and AT THE SAME TIME SHAPE SHOULDER after Row 314 (338) [362] by binding off 1 st. 3x, 2 sts. 14x. (1 st. 1x, 2 sts. 16x). [2 sts. 16x, 3 sts. 1x].

Bring the needles on the left into working position, knit 1 row in Pattern to the left side, turn the Row Counter back to 170 (178) [186] and complete the left half. Follow the instructions from *.

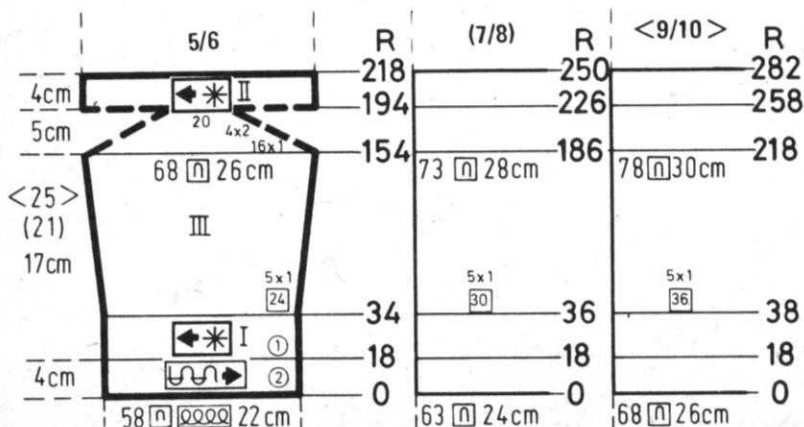

SLEEVE: III

Cast on 58 (63) [68] sts. with color 2 and work Stockinette stitch to Row 18. Change to color 1 and the Holding Position Design - Pattern I. After Row 34 (36) [38], ON EACH SIDE, increase 1 st. every 24th row 5x. (every 30th row 5x). [every 36th row 5x]. Knit to Row 154 (186) [218].

Work Short Rows. ON OPPOSITE SIDE OF CAM BOX, put into holding position 1 st. 16x ON EACH SIDE, then 2 sts. 4x ON EACH SIDE. After Row 194 (226) [258], bring all the needles back into working position and work the WEAVING PATTERN II to Row 218 (250) [282], then bind off.

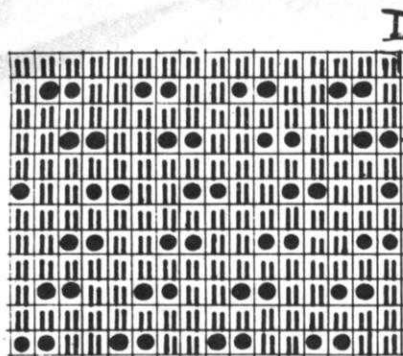

24
21-23
20
17-19
16
13-15
12
9-11
8
5-7
4
1-3

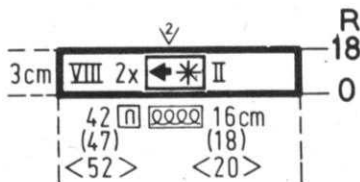

FRONT BAND: VIII Make 2.
Cast on 42 (47) [52] sts. with color 2 and work the Weaving Pattern II to Row 18, then bind off all sts.

KK 88

CHILD'S JACKET AND PULLOVER

SIZE: 10/11 (12/13) [14/15]
YARN: Amore
grams C1 250 300 350
grams C2 100 100 100
grams C3 50 50 50
TENSION: 6 to 8.
GAUGE: 16 sts. 23 rows = 5 cm

Stockinette stitch with repeated color stripes as shown on the Charts. Bands: K1, P1 Ribbing or you can use a Mock Rib if you do not own a ribber. The knit side is the right side.

FINISHING: See General Instructions. Work 1 row single crochet around back neck opening of Pullover, then make a loop for one side and sew button to other side at neck edge.

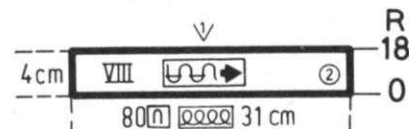
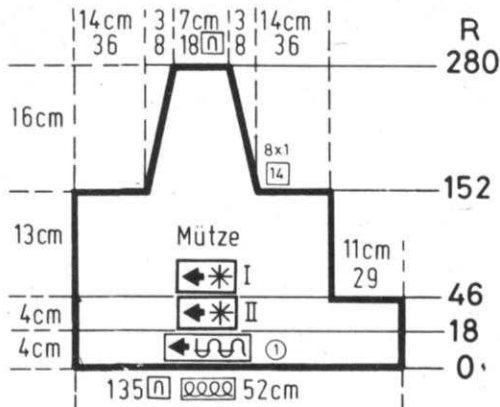
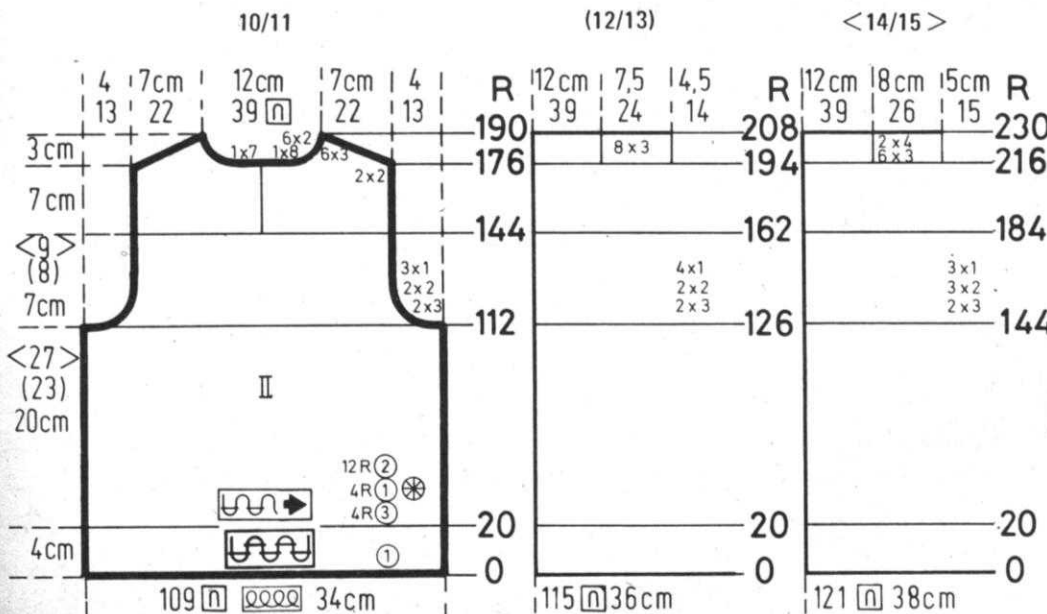

NECKBAND: VIII
Cast on 80 sts. with color 2 and work 18 rows Stockinette stitch, then bind off.

HAT:

Cast on 135 sts. with color 1 and work 18 rows Stockinette stitch. Change to the Weaving Pattern II and knit to Row 46. Change to the Holding Position Design - Pattern I and ON THE RIGHT SIDE, bind off 29 sts. Knit to Row 152. ON EACH SIDE, bind off 36 sts. (use a separate yarn for the left side), then ON EACH SIDE, decrease 1 st. every 14th row 8x. After Row 280, bind off the remaining 18 sts.

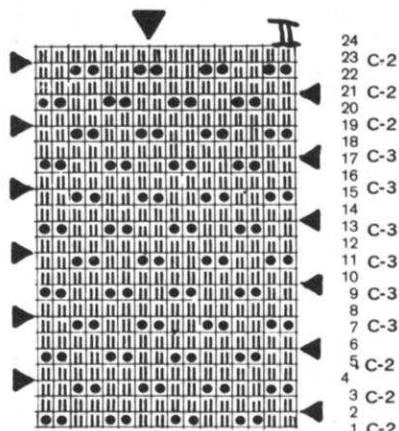

PULLOVER BACK: II

Cast on 109 (115) [121] sts. with color 1 and work 20 rows K1, P1 Ribbing. Change to Stockinette stitch with REPEATED color stripes as marked on the Chart. Knit to Row 112 (126) [144].

SHAPE ARMHOLE: ON EACH SIDE, bind off 3 sts. 2x, 2 sts. 2x, 1 st. 3x. (3 sts. 2x, 2 sts. 2x, 1 st. 4x). [3 sts. 2x, 2 sts. 3x, 1 st. 3x]. After Row 144 (162) [184], divide in the center and put the needles on the left side into holding position and complete the right half first. *Knit to Row 176 (194) [216].

SHAPE SHOULDER AND NECK AT THE SAME TIME: Bind off FOR SHOULDER: 2 sts. 2x, 3 sts. 6x. (3 sts. 8x). [3 sts. 6x, 4 sts. 2x]. FOR NECK: ALL SIZES THE SAME: 8 sts. (7 for left side) 1x, 2 sts. 6x. Bring all the needles on the left into working position, knit 1 row in Pattern to the left side, turn the Row Counter back to 144 (162) [184] and complete the left half. Follow the instructions from *.

Continued

10/11

(12/13)

<14/15>

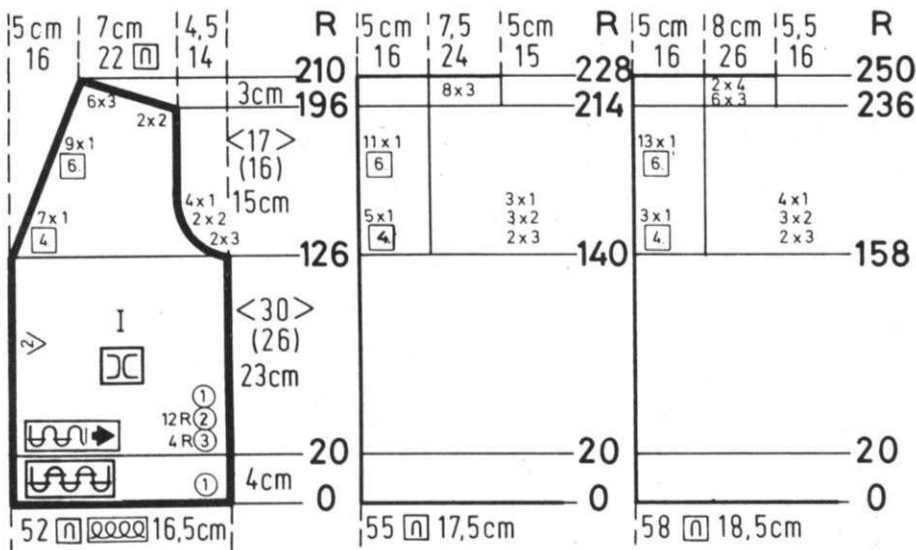
**KK 88**

JACKET FRONT: I Make 1, reverse 1.

Cast on 52 (55) [58] sts. with color 1 and work 20 rows K1, P1 Ribbing. Change to Stockinette stitch with color stripes as marked on the Chart. Knit to Row 126 (140) [158].

SHAPE ARMHOLE AND NECK AT THE SAME TIME: Bind off FOR ARMHOLE: 3 sts. 2x, 2 sts. 2x, 1 st. 4x. (3 sts. 2x, 2 sts. 3x, 1 st. 3x). [3 sts. 2x, 2 sts. 3x, 1 st. 4x]. Decrease 1 st. for NECK every 4th row 7x, every 6th row 9x. (every 4th row 5x, every 6th row 11x). [every 4th row 3x, every 6th row 13x]. AND SHAPE SHOULDER AFTER ROW 196 (214) [236], bind off 2 sts. 2x, 3 sts. 6x. (3 sts. 8x). [3 sts. 6x, 4 sts. 2x].

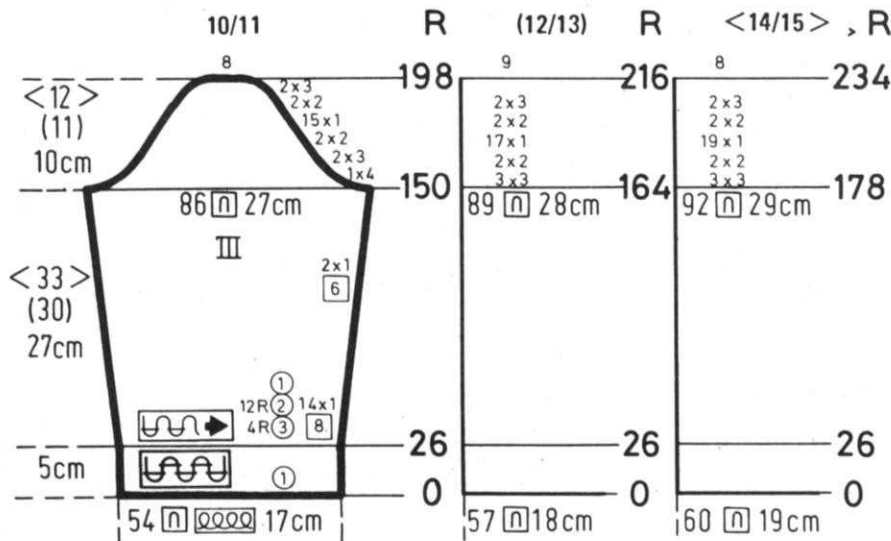
**JACKET SLEEVE: III**

Cast on 54 (57) [60] sts. with color 1 and work 26 rows K1, P1 Ribbing. Change to Stockinette stitch with color stripes as marked on the Chart. ON EACH SIDE, increase 1 st. every 8th row 14x, every 6th row 2x. Knit to Row 150 (164) [178].

SHAPE CAP: ON EACH SIDE, bind off 4 sts. 1x, 3 sts. 2x, 2 sts. 2x, 1 st. 15x, 2 sts. 2x, 3 sts. 2x. (3 sts. 3x, 2 sts. 2x, 1 st. 17x, 2 sts. 2x, 3 sts. 2x). [3 sts. 3x, 2 sts. 2x, 1 st. 19x, 2 sts. 2x, 3 sts. 2x]. After Row 198 (216) [234], bind off the remaining 8 (9) [8] sts.

<6-10> (6-10) <38-42> (35-39) <70-74> (64-68) <102-106> (93-97)

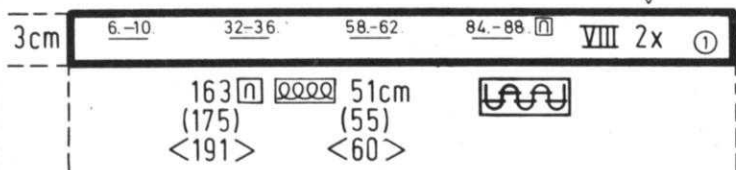
**BUTTONHOLE AND NECKBAND: VIII**

Cast on 163 (175) [191] sts. with color 1 and work K1, P1 Ribbing. After Row 8, make BUTTONHOLES over needles as marked on the Chart FOR YOUR SIZE. After Row 16, bind off the crochet method for ribbing. Make a second band the same but omit the Buttonholes.

BE SURE TO NOTIFY US IMMEDIATELY OF ANY CHANGE OF ADDRESS. THE POST OFFICE WILL NOT FORWARD YOUR MAGAZINE TO YOU.

KK 89

CHILD'S PULLOVER

SIZE: 9/10 (11/12) [13/14]

YARN: Amore

grams C1 150 200 250

grams C2 50 50 50

Neck type Zipper

TENSION: 6 to 8

GAUGE: 17 sts. 22 rows = 5cm
for Rib Pattern.

Ribbing Pattern according to Line Drawing with color stripes as shown on the Charts. Worn on the purl side. Bands are K1, P1 Ribbing.

FINISHING: See General Instructions. Single crochet around back neck opening, then sew in zipper.

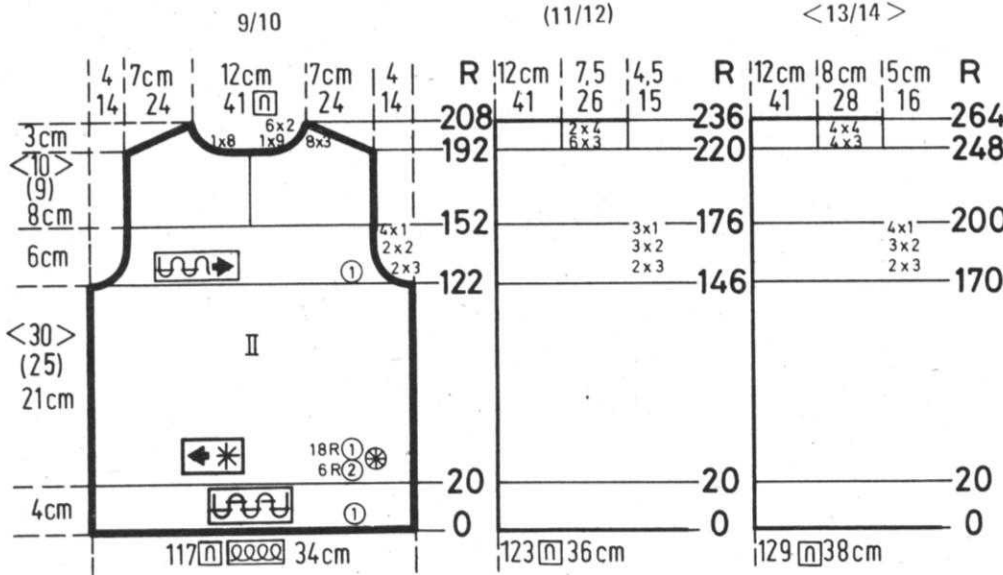

PULLOVER BACK: II

Cast on 117 (123) [129] sts. with color 1 and work 20 rows K1, P1 Ribbing. Change to Ribbing Pattern with REPEATED COLOR STRIPES as marked on the Chart. Knit to Row 122 (146) [170]. Change to color 1 and Stockinette stitch.

SHAPE ARMHOLE: ON EACH SIDE, bind off 3 sts. 2x, 2 sts. 2x, 1 st. 4x. (3 sts. 2x, 2 sts. 3x, 1 st. 3x). [3 sts. 2x, 2 sts. 3x, 1 st. 4x]. After Row 152 (176) [200], divide in the center, put the needles on the left into holding position and complete the right half first.

*Knit to Row 192 (220) [248]. SHAPE NECK AND SHOULDER AT THE SAME TIME: Bind off FOR SHOULDER: 3 sts. 8x. (3 sts. 6x, 4 sts. 2x). [3 sts. 4x, 4 sts. 4x]. FOR NECK: ALL SIZES THE SAME: 9 sts. (8 for left half) 1x, 2 sts. 6x. Bring the Cam Box to the left side, turn the Row Counter back to 152 (176) [200] and complete the left half. Follow the instructions from *.



PULLOVER FRONT: I

Work the front section the same as the back to Row 172 (200) [228], bind off the center 11 sts., put the needles on the left into holding position and complete the right half first.

*ON NECK SIDE, bind off 3 sts. 2x, 2 sts. 3x, 1 st. 3x. SHAPE SHOULDER after Row 192 (220) [246]. Bind off 3 sts. 8x (3 sts. 6x, 4 sts. 2x). [3 sts. 4x, 4 sts. 4x]. Bring the Cam Box to the left side, turn the Row Counter back to 172 (200) [228] and complete the left half. Follow the instructions from *.

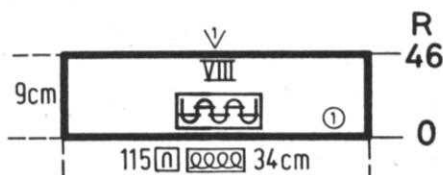
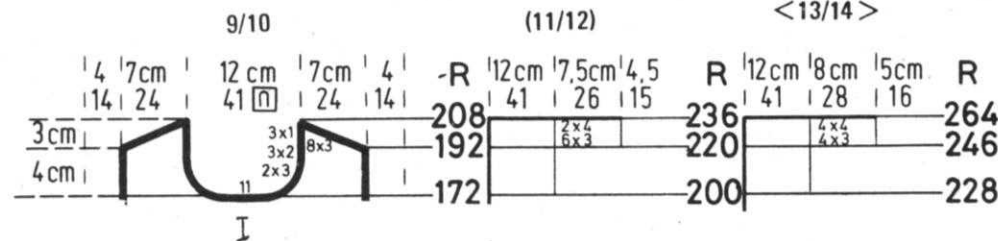

COLLAR: VIII

Cast on 115 sts. with color 1 and work 46 rows K1, P1 Ribbing, then bind off the crochet method for Ribbing.

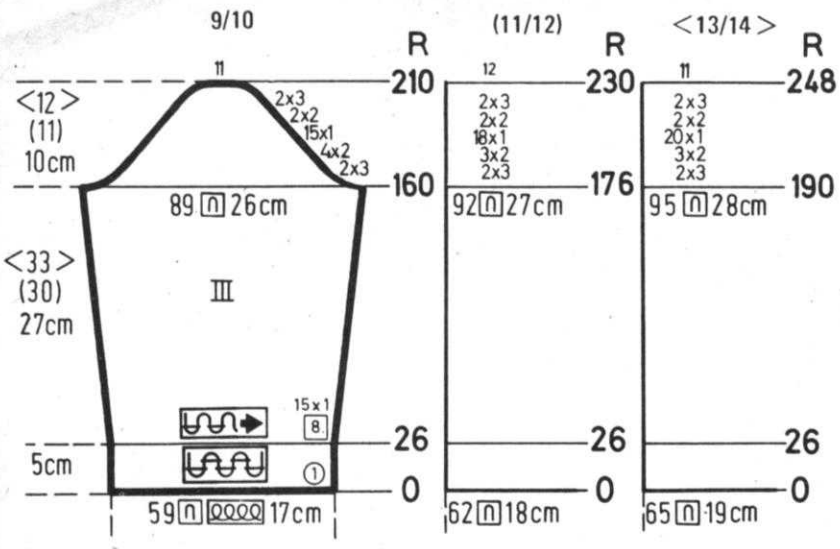

SLEEVE: III
 Cast on 59 (62) [65] sts. with color 1 and work 26 rows K1, P1 Ribbing. Change to Stockinette stitch. ON EACH SIDE, increase 1 st. every 8th row 15x. Knit to Row 160 (176) [190].

SHAPE CAP: ON EACH SIDE, bind off 3 sts. 2x, 2 sts. 4x, 1 st. 15x, 2 sts. 2x, 3 sts. 2x. (3 sts. 2x, 2 sts. 3x, 1 st. 18x, 2 sts. 2x, 3 sts. 2x). [3 sts. 2x, 2 sts. 3x, 1 st. 20x, 2 sts. 2x, 3 sts. 2x]. After Row 210 (230) [248], bind off the remaining 11 (12) [11] sts.

converta tape

For simple and speedy charting of custom knits.
 List Price \$9.50

(California residents add Sales Tax)
 Shipping charges: F.O.B. Los Angeles

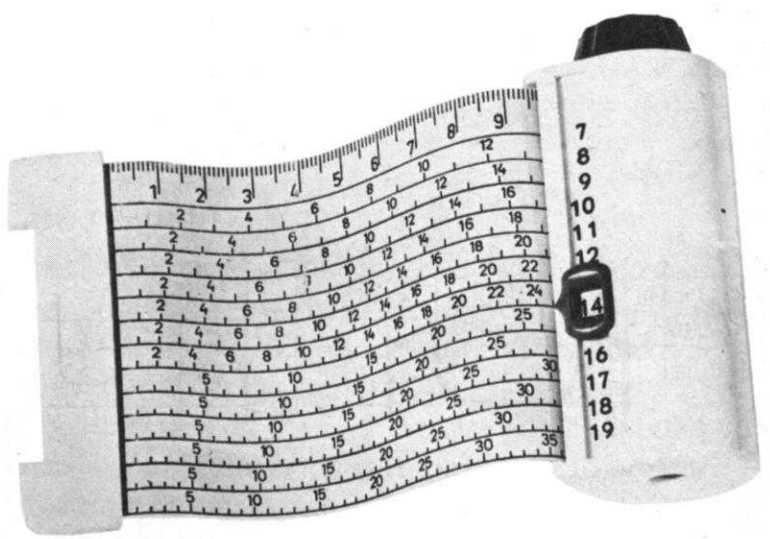

Order direct from KNITKING — 1128 Crenshaw Blvd., Los Angeles, California 90019

KK 90

CHILD'S PULLOVER

SIZE: 8/9 10/11 [12/13]

YARN: Alanda

grams C1 150 200 250
grams C2 50 50 50

TENSION: 8 to 10

GAUGE: 13 sts. 20 rows = 5 cm

Stockinette stitch with REPEATED color stripes as shown on the Charts. Bands are K1, P1 Ribbing. The knit side is the right side.

FINISHING: See General Instructions. Sew the pocket onto right sleeve (see picture).

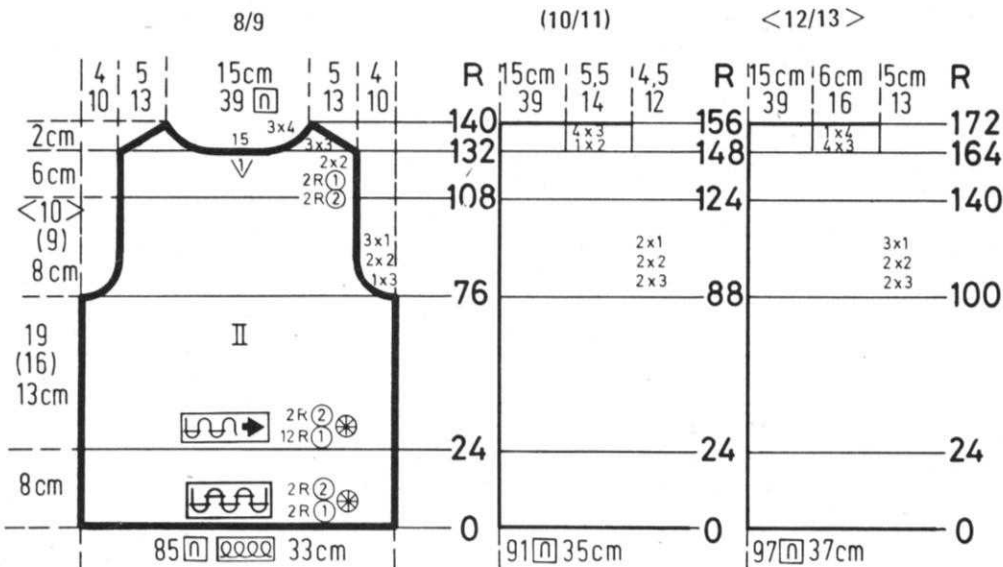

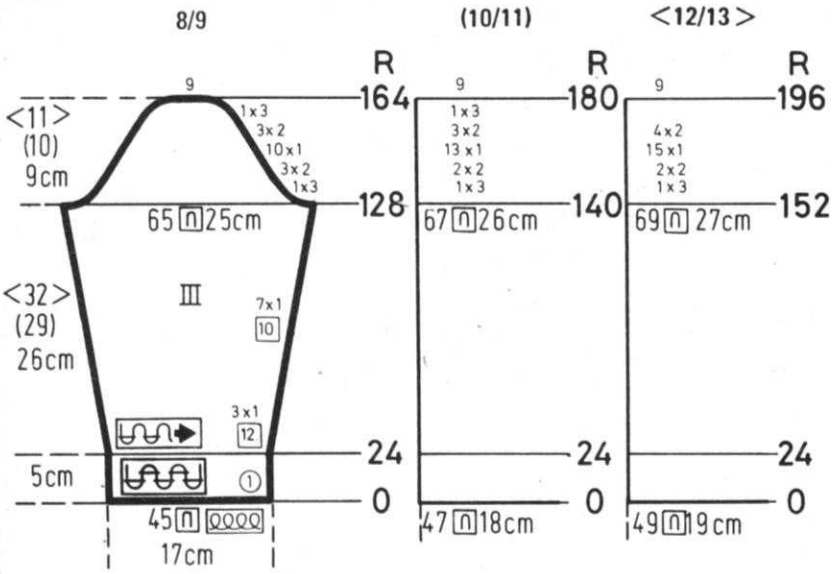

SLEEVE: III
 Cast on 45 (47) [49] sts. with color 1 and work 24 rows K1, P1 Ribbing. Change to Stockinette stitch. ON EACH SIDE, increase 1 st. every 12th row 3x, every 10th row 7x. Knit to Row 128 (140) [152].

SHAPE CAP: ON EACH SIDE, bind off 3 sts. 1x, 2 sts. 3x, 1 st. 10x, 2 sts. 3x, 3 sts. 1x. (3 sts. 1x, 2 sts. 2x, 1 st. 13x, 2 sts. 3x, 3 sts. 1x). [3 sts. 1x, 2 sts. 2x, 1 st. 15x, 2 sts. 4x]. After Row 164 (180) [196], bind off the remaining 9 sts.

knitking table

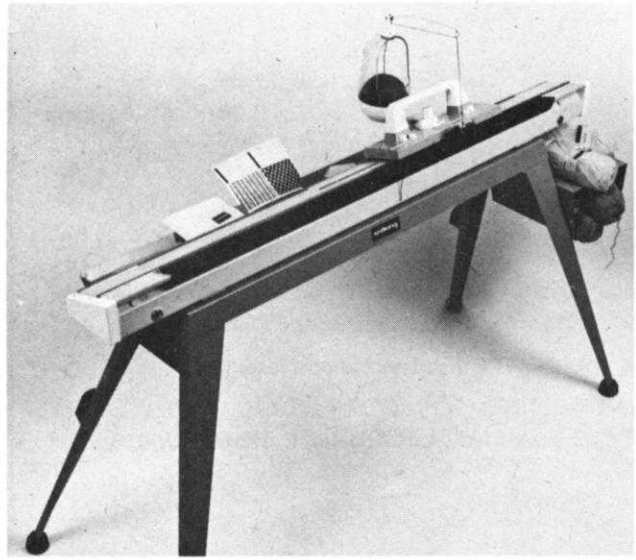

Special Designed Table for KNITKING machines only. Sturdy All Steel construction with Tray in the rear for Tools, Books, etc., and Slots for inserting Pattern Cards. Storage box for yarns . . . Special spot welded brackets on the back legs for storing Ribbing Attachment . . . Heavy duty Rubber Feet to prevent Table from moving around.

List Price: **\$39.50**

(California residents add Sales Tax)

Shipping — F.O.B. Los Angeles

(Shipping weight approximately 25 pounds)

Order direct from KNITKING — 1128 Crenshaw Blvd., Los Angeles, California 90019



knitking accessory price list

	PRICE	SHIPPING		PRICE	SHIPPING
WHIZ KING PATTERN READER	\$69.50	\$ 2.50	Reversing Bar (197 Needle KNIT- KING Machine only	\$29.50	\$ 1.75
Increase-Decrease Compensator . .	29.50	2.00	Converta Tape (for Charting Pat- terns to size)	9.50	.60
3-Color Yarn Feeder	24.50	1.50	Fluorescent Magnifying Lamp with 5 inch lens and adjustable 45 inch extension arm (specify table clamp or wall Fitting)	69.50	3.00
Pattern Stitch Cards for AM 3 KNITKING Machine only - #17 to #48	10.50	1.25	JAC 40 (KNITKING Machine only)	32.50	1.50
Weaving Accessory for AM 3 KNITKING only	8.95	.80	JAC 40 Punch Cards, Please give alternate numbers . . . Each	1.25	.15
Adjustable Needle Selector (33 Needle)	4.25	.60	Strap for JAC 40	2.00	.30
Cam Wheels for AM 3 KNITKING Machine only Each	1.25	.10	KNITKING Instruction Book (specify machine)	4.00	.50
Knitting Table (suitable for all machines)	46.50	F.O.B.	1 Year Subscription to KNITKING MAGAZINE (6 issues)	10.00 (no tax)	
KNITKING Metal Table	39.50	F.O.B.	Canada	12.00	
Treble Transfer Tool (pair)	2.50	.50	Back Issues of KNITKING MAGAZINE		
Multiple Transfer Tool (33 needle)	4.25	.60	SINGLE COPY (thru Vol. 10)Ea.	1.50	Postpaid
Double Transfer Tool (pair)	2.00	.50	After Vol. 11 No. 1 . . . Each	3.00	Postpaid
Transfer Tools (1 each - 4 needle and 6 needle)	3.25	.50	Complete 6th or 7th or 8th or 9th or 10th Bound Volume of KNITKING MAGAZINE (6 issues bound in Plastic Cover)Ea.	7.95	1.15
Combined Latch Needle & Transfer Tool	1.50	.25	KNITKING Yarn Catalogue	1.00	Postpaid
Combined Work Hook & Transfer Tool	1.50	.25	KNITKING Carrying Bags (2-piece) AM 3 and Cam Box	29.50	1.75
Knitting Machine Needles for KNITKING Machines only39	.10	KNITKING Carrying Bag (for Ribber only)	17.50	1.00
Ribbing Attachment Needles for KNITKING Ribbers only49	.10			
Ribber Transfer Needles35	.10			
Strippers for KNITKING Ribber(pr) KNITKING Sinker & Spring (specify Machine No.)95	.25			
Shipping for 2020	.15			
Yarn Winder with 'Waxamajig' and Skein Holder	27.50	1.75			
Wax Spools Each	.30	.20			
OR 4 for	1.00	.40			

Sorry, No C.O.D's or Billings, Please send money with your order. California Residents please add Sales Tax.

Price Lists prior to this date are obsolete.

KNITKING, INC.

1128 Crenshaw Blvd., Los Angeles, California 90019



HP79





HP77

DK71







HP75

HP80







KK88
A + B



KK83





KK81

KK89







KK90



KK85





KK 87

KK 86



KK 82

KK 84
Rückseite
DK 69

