

# knitking

*magazine*

nov/dec '71







## NEW VOLUME AVAILABLE NOW

A complete seventh volume of **KNITKING MAGAZINES** with a flexible, transparent plastic cover and specially bound so that it will stay open at any page, is available at the special price of \$6.95 (plus 95 cents mailing costs).

If purchased separately the magazines would cost a total of \$9.00.

The volume contains over 120 fully illustrated complete stylish patterns for all members of the family together with many valuable, practical knitting hints.

There is a very limited number of these volumes available and it will undoubtedly become a collectors item.

If you already have the entire set it will almost certainly be well thumbed and marked. Why not purchase a perfect mint condition volume for your bookshelf and ready reference at any time.

Place your order today and avoid disappointment. Send it to **KNITKING MAGAZINE**, 1128 Crenshaw Boulevard, Los Angeles, California 90019.

I enclose \$7.90

Please RUSH my bound Seventh Volume of **KNITKING MAGAZINE** to me at:

Name \_\_\_\_\_

Address \_\_\_\_\_

City \_\_\_\_\_ State \_\_\_\_\_ Zip \_\_\_\_\_

## BOOKS by KNITKING

### KNITKING CHILDREN'S BOOK

The Big, beautiful book of children's patterns. Over 50 complete and lovely patterns for infants and children to teenage. Buntings, Blankets and Baby outfits, cute Dresses, Leotites, Skirts, Suits, Pull-overs, Cardigans, Stockings, Trousers, etc. . . The only Children's Book for the machine knitter published in the U.S.A. It sells for **\$2.95**

40 cents mailing  
Calif. residents add 5% Sales Tax



### PRACTICAL KNITTING HINTS

We call this book the **TEXT BOOK** for machine knitters because it answers the many questions that occur in machine knitting, from preparing to knit, taking measurements, shaping, making button-holes, special effects, bindings, bands and edges, etc., through finishing and blocking. It sells for **\$2.95**

40 cents mailing  
Calif. residents add 5% Sales Tax

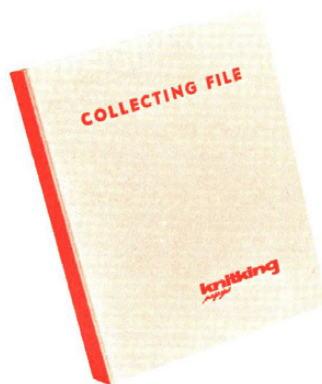

### COLLECTING FILE

Keep your valuable **KNITKING MAGAZINES** in mint condition in a Collecting File. Each file holds twelve issues.

**\$2.95**

75 cents mailing  
Calif. residents add 5% Sales Tax



# knitking

*magazine*

We thought we had problems because of the West Coast dock strike that started on July 1st and continues at the time of writing despite the invoking of the Taft-Hartley Law...but strike problems are minor compared with those created by President Nixon through his August 15th speech to the Nation.

It had been obvious for quite some time that drastic action was necessary to stop the inflationary spiral of the U.S. economy and to somehow balance exports with ever increasing imports... We are all aware of the great infiltration of imported automobiles, and the very substantial share they claim of the American purchasers money... we also know about the growing numbers of motorcycles... radios... television sets... sewing machines and numerous other hard goods that compete with domestic products...but imported knitting machines have no counterpart in American industry...there are no home knitting machines made here, consequently, imported knitting machines are not competing with any comparable American product and should not, in our opinion, be affected by the 10% import surtax.. We provide a service to U.S. consumers that cannot be obtained from any U.S. source, so why should we have to increase the price to the consumer by an import surtax...? We are approaching government authorities with an appeal to exempt knitting machines and accessories from any surtax and we urge other importers of knitting machines to do similarly...

That's not all our consumer will be in for in the way of increases... The re-evaluation of currency will increase the actual prices from manufacturers to us and when the dock strike is eventually settled, there will undoubtedly be an increase in freight rates... Our yarns, of course, are competitive with domestic products so a price increase is inevitable on all new stocks as they are brought in, but we will keep all prices as low as possible... Most of the quality yarns sold by our competition are imported, so you can reckon that there will be a general increase in yarn prices irrespective of brand names.

Now...to more pleasant things... How do you like the magnificent Afghan on the Cover of this issue? Its display at the recent Los Angeles County Fair created more interest and enthusiasm than any other item, and we had some beauties... So many people want to make it, we decided to give all our readers an opportunity to see how gorgeous it looks in color... What a handsome (and inexpensive, either as an Afghan or Bedsread) Christmas gift it will make for your best friends...!

The entire next issue promises to be outstanding with a lovely four piece Blazer and Skirt Suit on the Front Cover...an exciting Robin Hood outfit with Hot pants, Leotites, Pullover and stunning Jacket on the Back Cover... a Classic Suit with an interesting Popcorn Pattern Stitch... and for Teen-age Girls or small Women, a simple to make long sleeve Dress plus a dressier Empire style short sleeved Dress... a small Boys (2 to 3 years) Pants and Pullover outfit and some warm Sweaters with Matching Hats for Boys and Girls... For the Men, something new... Knitted Pants and a matching long sleeved Turtle Neck Sweater plus a second Sweater with a heavy masculine V-neckline...



LETTER  
from the  
PUBLISHER



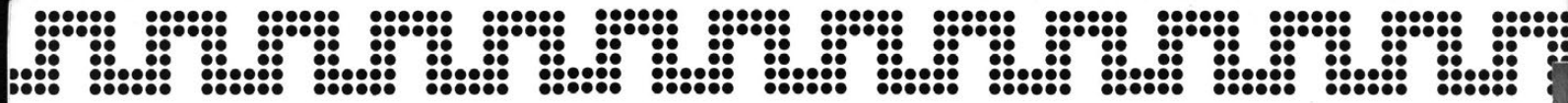

■■ DK 7976  
 ■■ Party Elegance . . . Be ready for any festive occasion  
 ■■ and knit this perfectly shaped and perfectly beautiful  
 ■■ long dress. Follow the Line Drawing for the Eyelet  
 ■■ Design. Knit Size 8 and 12 with KNITKING Subita  
 ■■ Crepe with Lurex (it sparkles), Size 14 with Amore.  
 ■■ See page 13

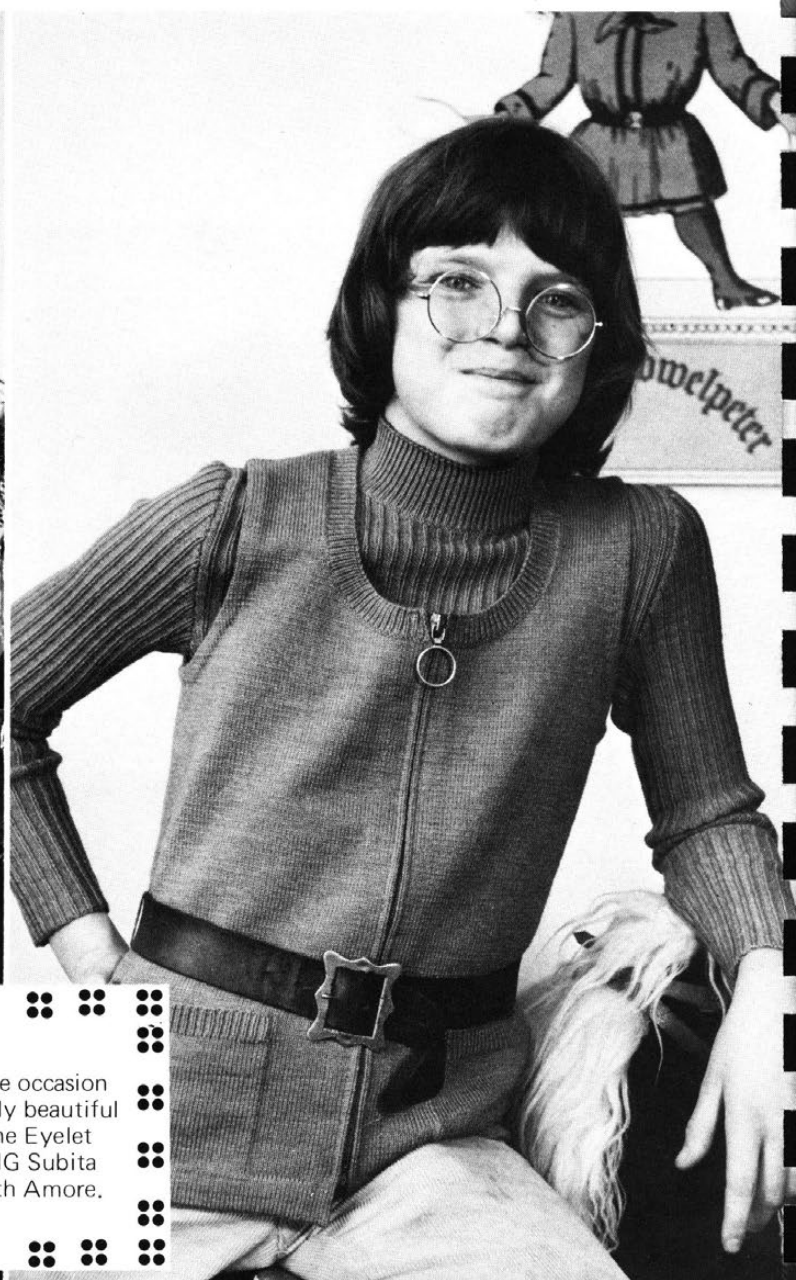

■■ KK 5315  
 ■■ The boys are hep to the fashion trends of the day and  
 ■■ the call for skinny ribbed Pullovers and Vests is loud  
 ■■ and clear. The Vest is knitted in Stockinette Stitch  
 ■■ with Ribbed neckline and top of pockets. The Pull-  
 ■■ over is a 1 x 3 Rib. Both are knitted with KNITKING  
 ■■ Subita Crepe 2 x 3, Size 12. See page 20

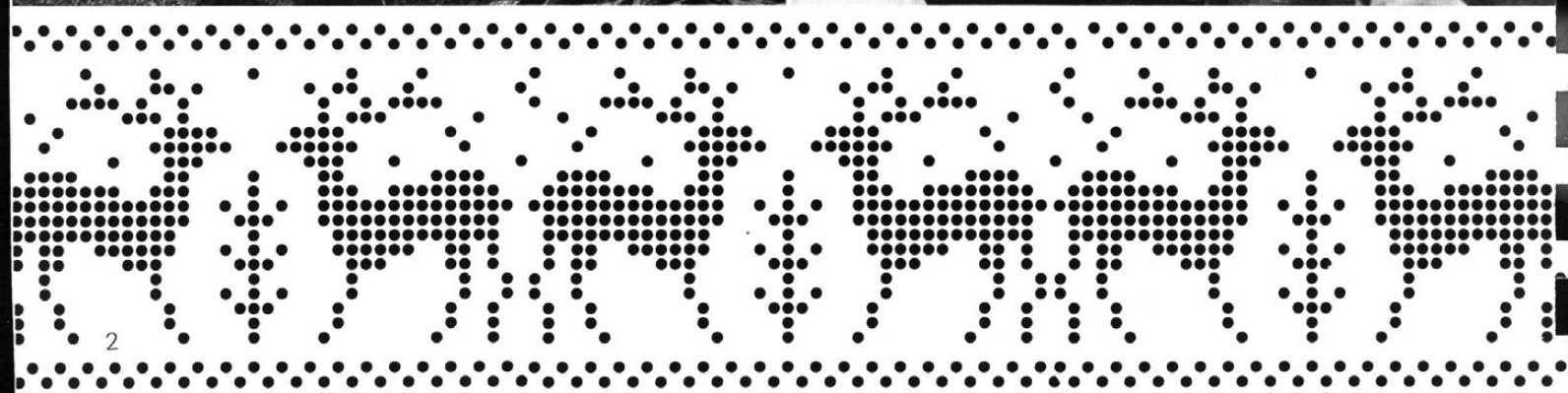





DK 7955

We're mad for plaid . . . and you must knit this plaid Mini Vest that barely touches the waistline with its matching Midi Skirt that buttons down the front. A JAC 40 Design, Pattern No. 442, or you may follow the Line Drawing. 3 sizes are given . . . for Size 10, use KNITKING Subita Crepe 2 x 4; Size 12, Crocus Crepe; Size 14, Sonika Dralon. See page 16

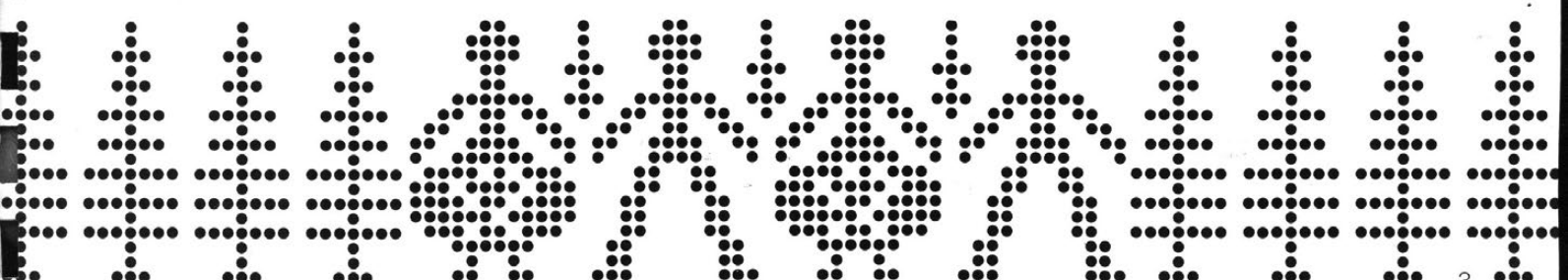



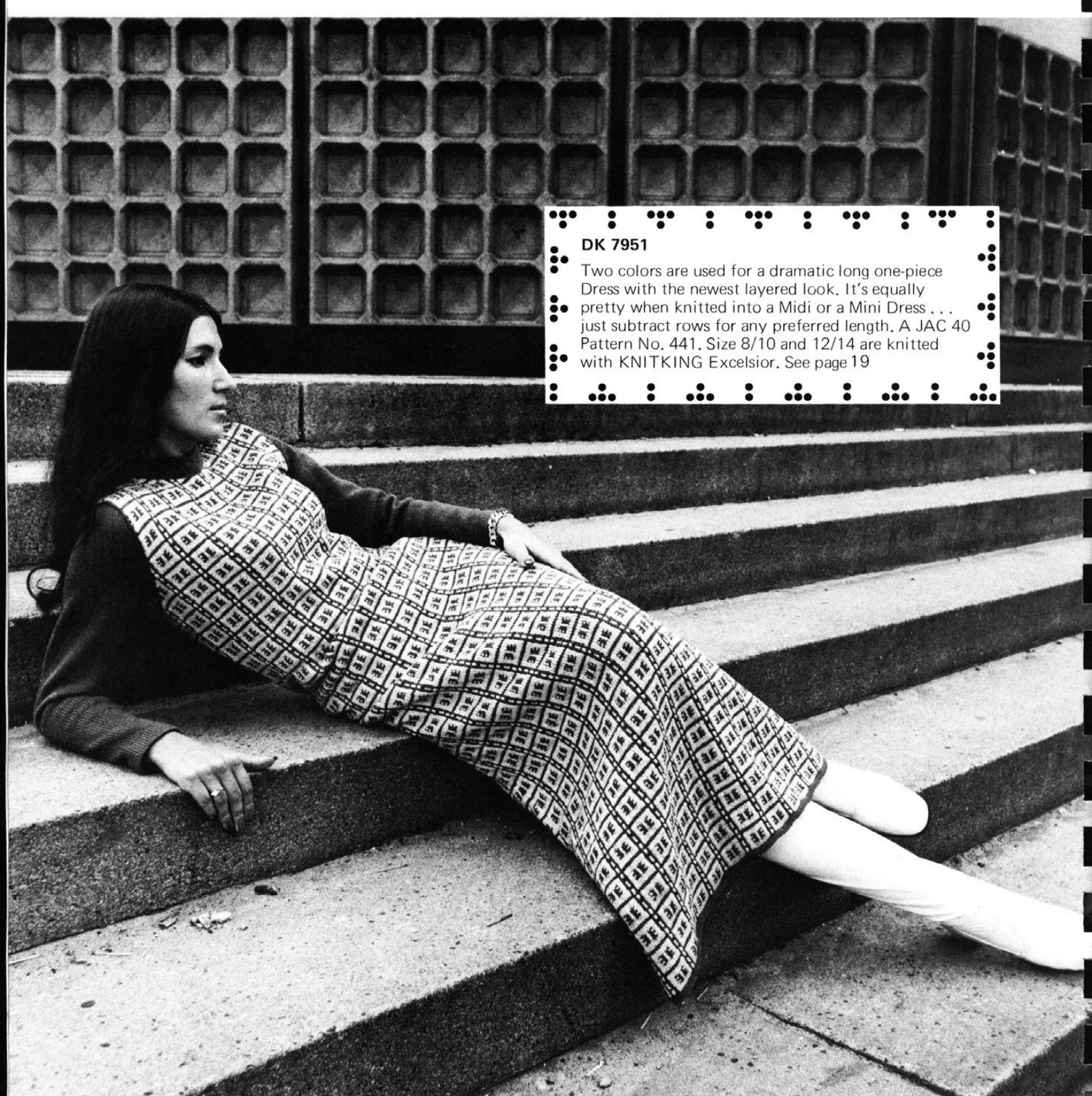
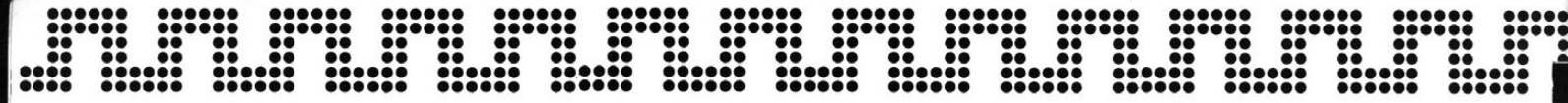

**DK 7951**

Two colors are used for a dramatic long one-piece Dress with the newest layered look. It's equally pretty when knitted into a Midi or a Mini Dress . . . just subtract rows for any preferred length. A JAC 40 Pattern No. 441. Size 8/10 and 12/14 are knitted with KNITKING Excelsior. See page 19

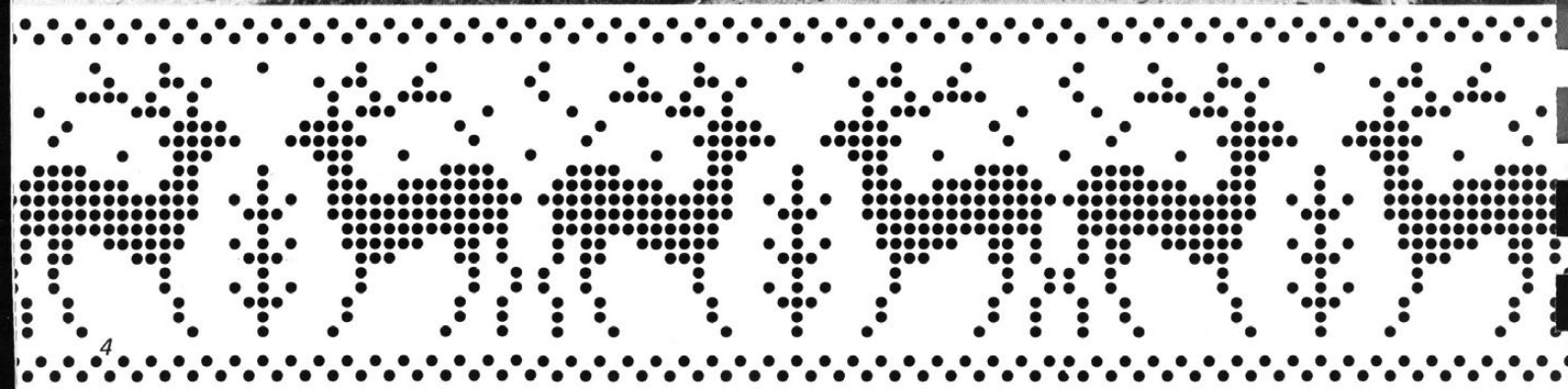



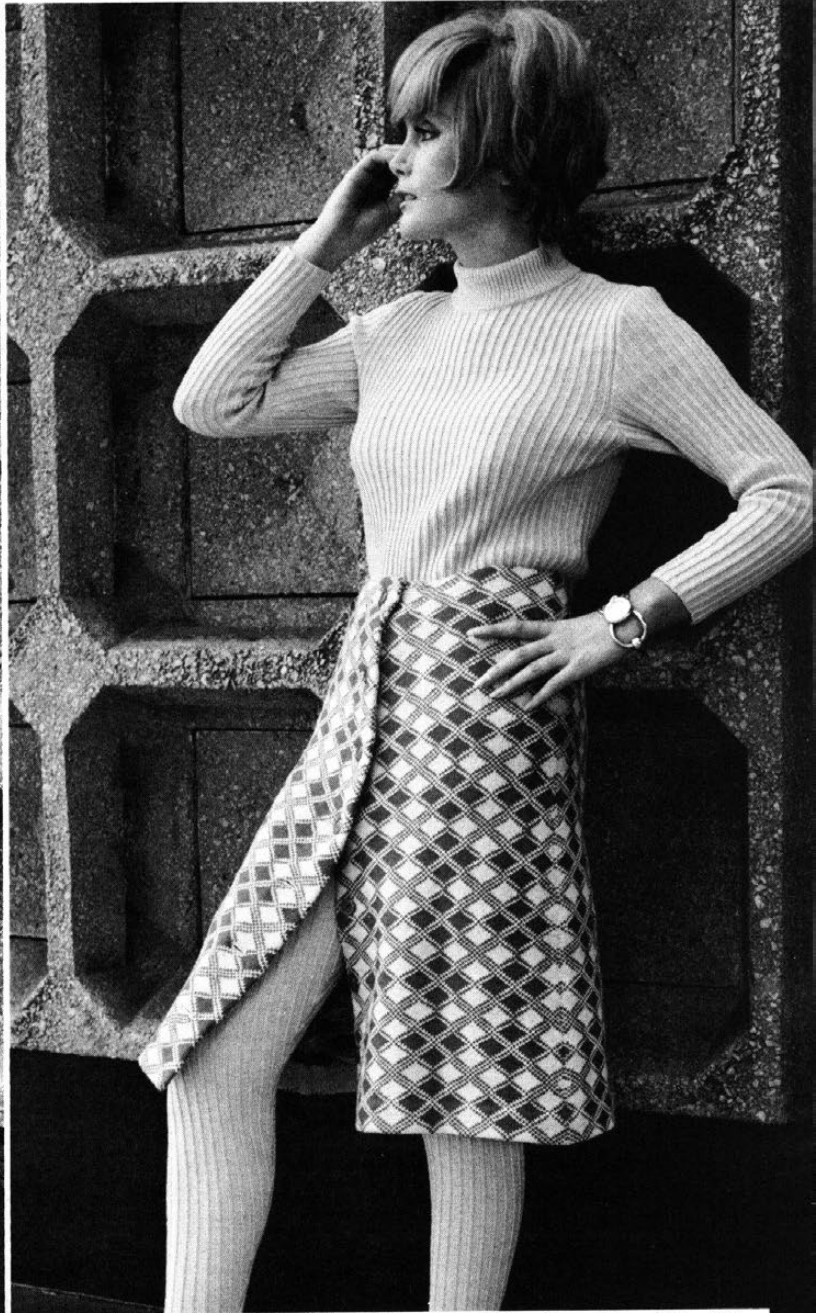

**DK 7954**

Call it what you will . . . a long Vest . . . or a sleeveless Coat. It is knitted in an easy Holding Position Design. Wear it over the pants knitted in Stockinette Stitch. The skinny Rib Pullover DP 7956 shown opposite, completes a 3-piece outfit. Size 12 is knitted with KNITKING Subita Crepe 2 x 4; Size 14, Crocus Crepe; Size 16, Lovely. See page 18

**DP 7956**

Team up a skinny Rib Pullover with matching Leotites and wear them with your plaid Skirt and Vest . . . For Size 10 use KNITKING Subita Crepe 2 x 4; Size 12, Crocus Crepe; Size 14, Sonika Dralon. See page 17







•• •• •• •• •• •• •• •• •• •• ••

•• **HP 3640**

•• The layered look is in for Men too. A Norwegian border Design is knitted across the chest and sleeves of a Pullover. Reverse the colors for the design on the zippered Vest. Follow the Line Drawing or use JAC 40 and Pattern No. 439. Size 36 is knitted with KNITKING Subita Dralon 3-ply; Size 38, Subita Crepe 2 x 4; Size 40, Sonika Dralon. See page 22

•• •• •• •• •• •• •• •• •• •• ••

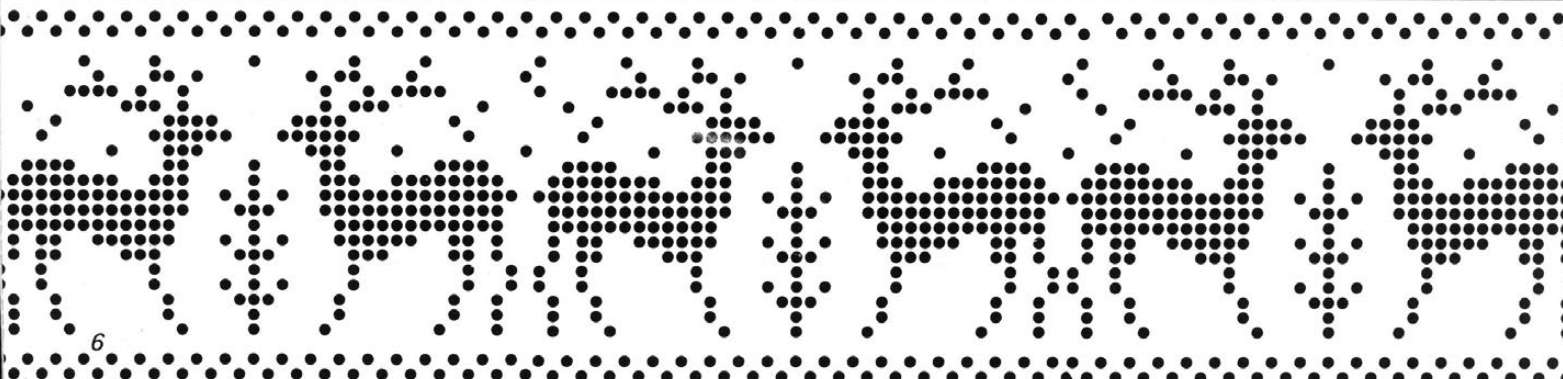





**HP 3642**

Satisfy his longing for a good looking warm Pullover. This one is handsome and bright as well as warm. The Norwegian Design is JAC 40 Pattern No. 381, or you may follow the Line Drawing. The Collar and Bands are ribbed. Size 38 is knitted with KNITKING Crocus Crepe; Size 40, Subita Crepe 2 x 4; Size 42, Lovely. See page 23

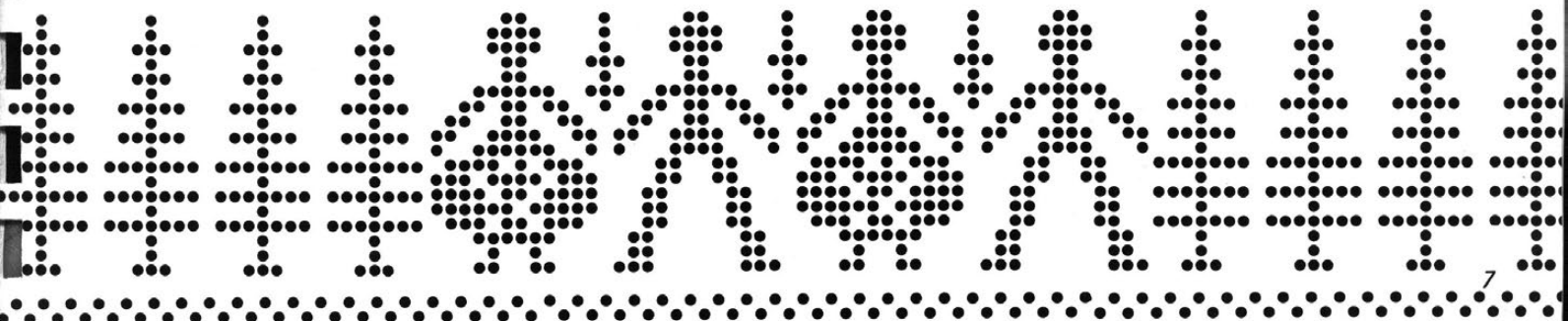



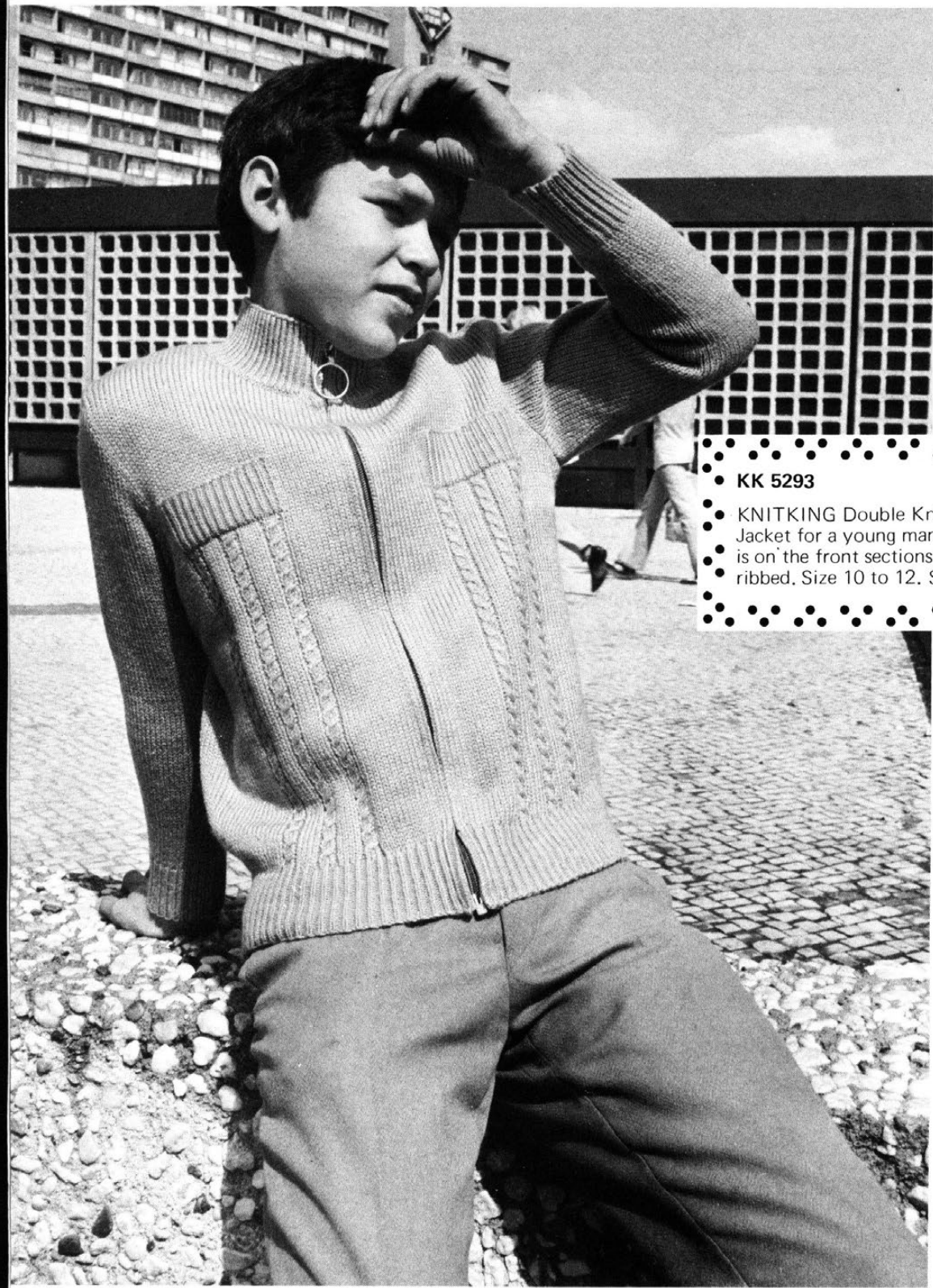

• **KK 5293**  
• **KNITKING** Double Knitting makes a warm zippered Jacket for a young man. An easy to knit Cable Design is on the front sections. The Collar and Bands are ribbed. Size 10 to 12. See page 24

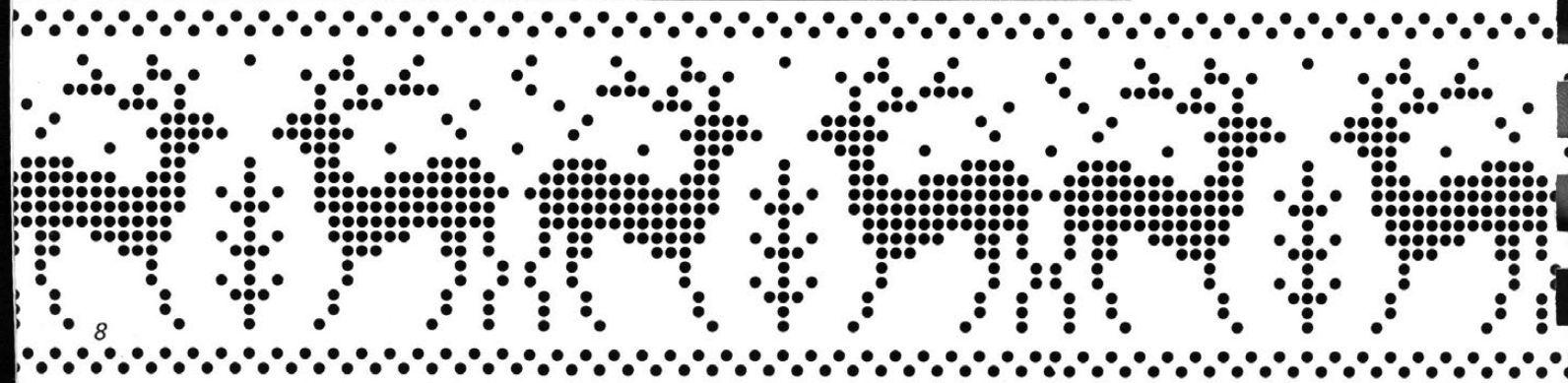



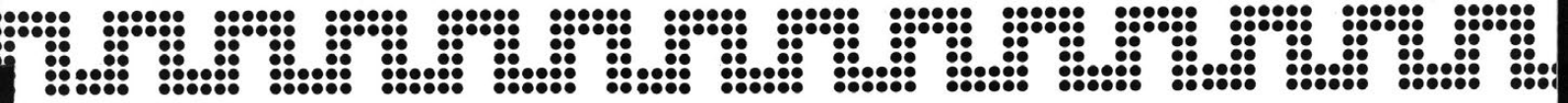

**MK 5292**

Zingy stripes make a big hit with the younger generation. The bodice of the one-piece Dress and the Leotites are striped in two colors. Rib the Collar and Bands. Very easy to knit in Stockinette Stitch using KNITKING Amore. Size 8 to 10. See page 26

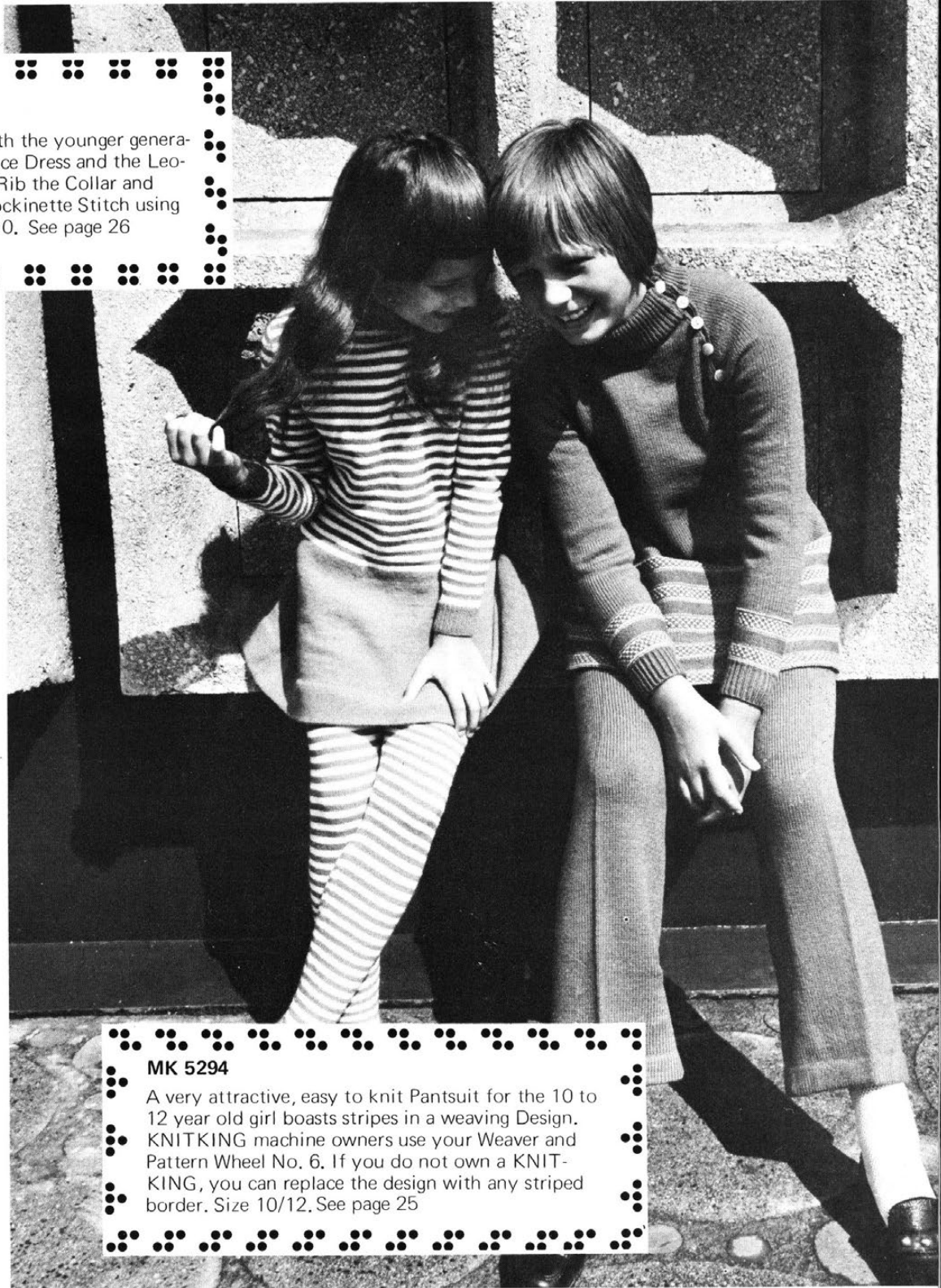

**MK 5294**

A very attractive, easy to knit Pantsuit for the 10 to 12 year old girl boasts stripes in a weaving Design. KNITKING machine owners use your Weaver and Pattern Wheel No. 6. If you do not own a KNITKING, you can replace the design with any striped border. Size 10/12. See page 25

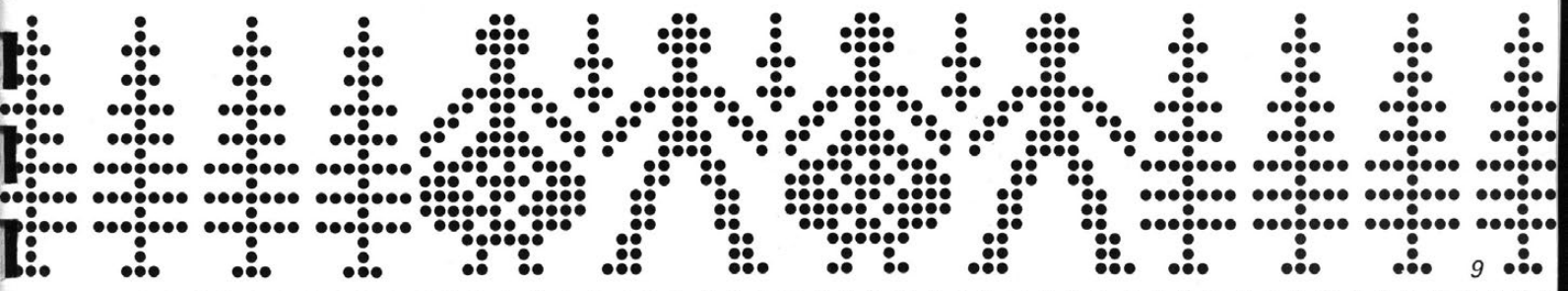



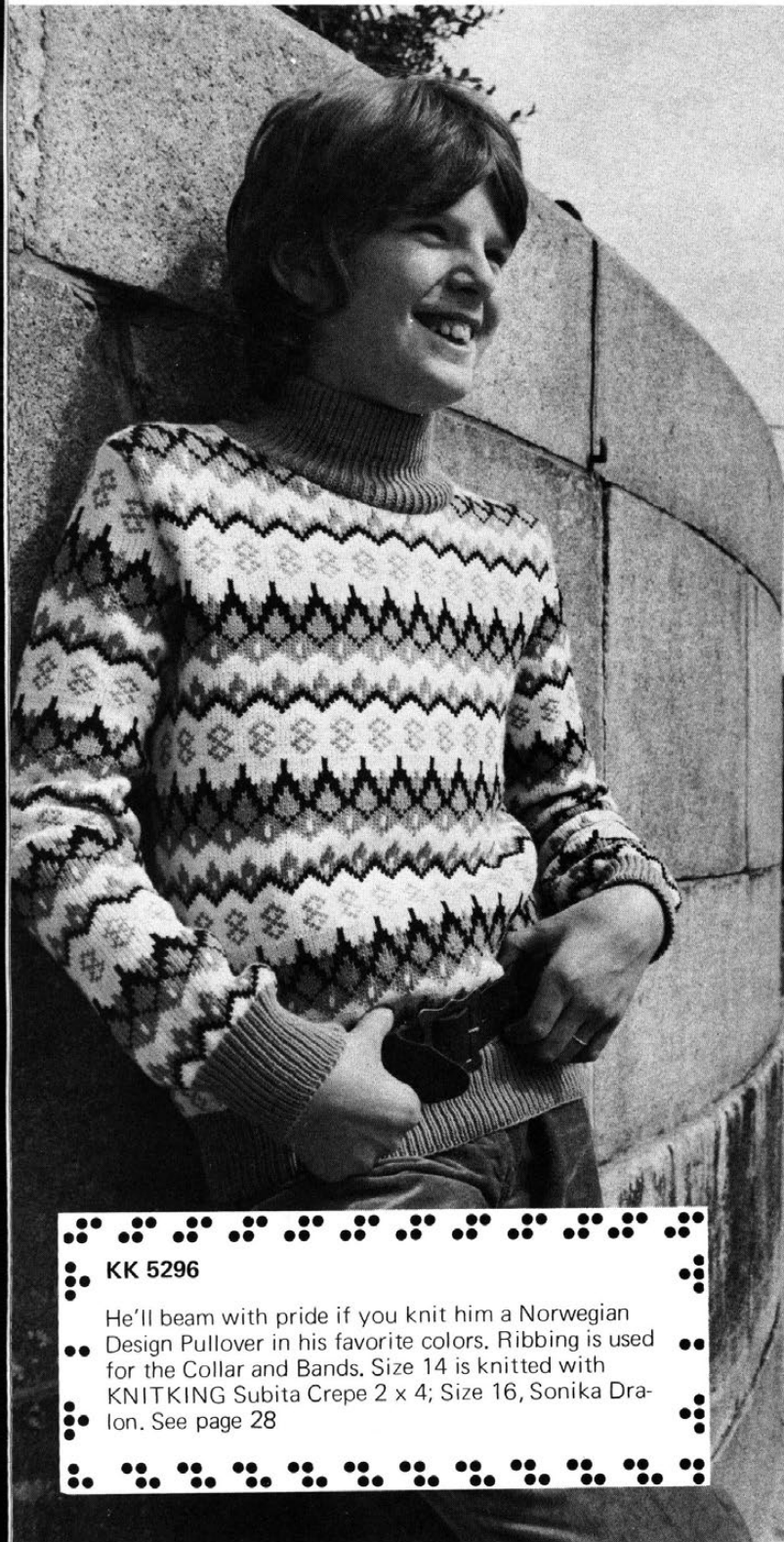

**KK 5296**

He'll beam with pride if you knit him a Norwegian Design Pullover in his favorite colors. Ribbing is used for the Collar and Bands. Size 14 is knitted with KNITKING Subita Crepe 2 x 4; Size 16, Sonika Dragon. See page 28



**MK 5320**

A warm and pretty outfit for a small girl is given in two sizes. The Jumper is knitted in Stockinette Stitch with snaps sewn under the double row of buttons (no buttonholes). The Turtle necked Pullover is an easy Holding Position Design in two colors. Bands and Collar are ribbed. Size 8 and Size 10, both sizes knitted with KNITKING Amore. See page 28

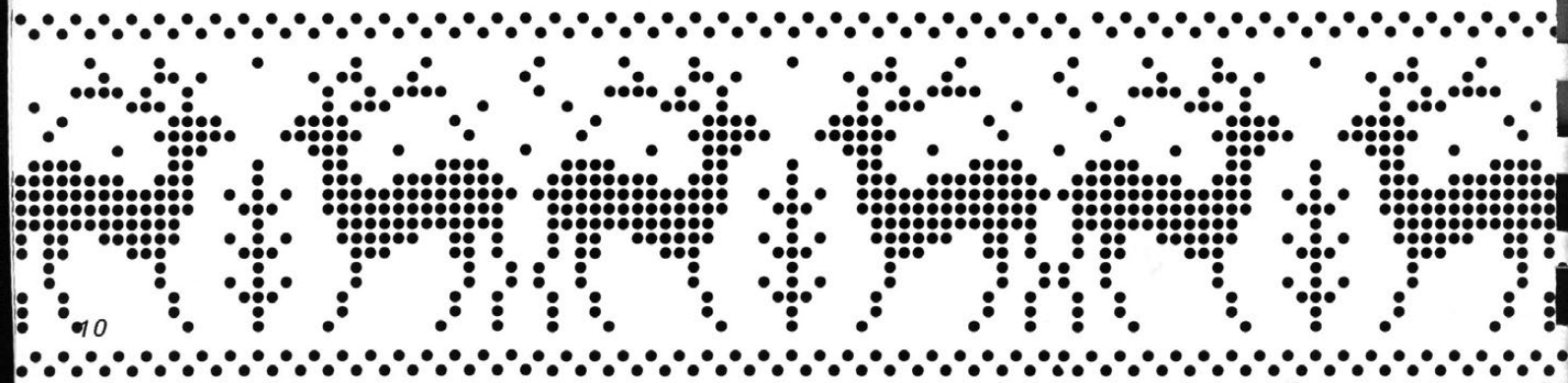



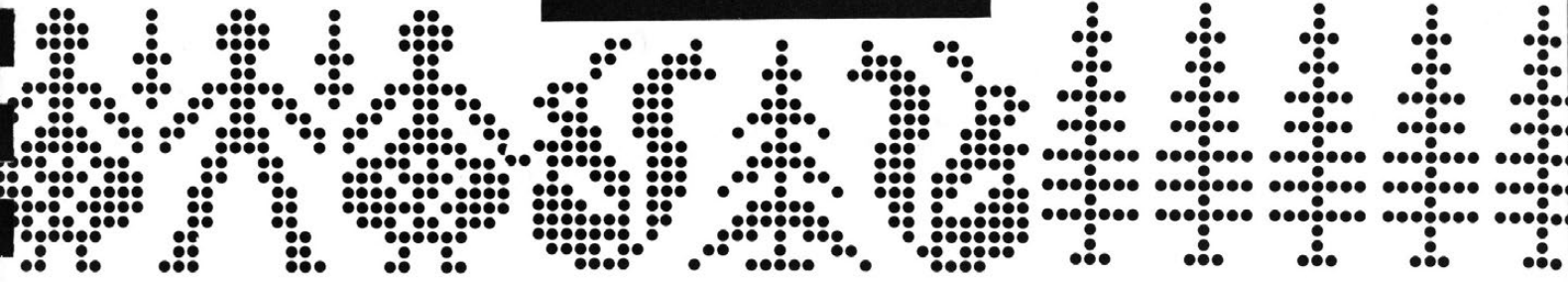
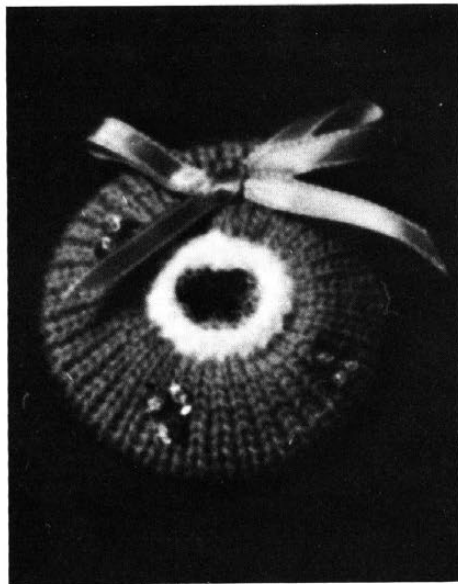
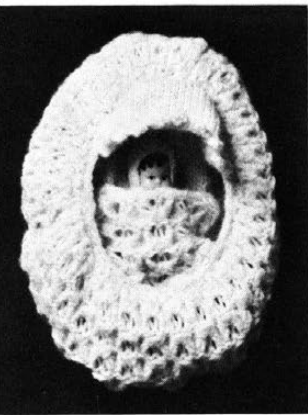
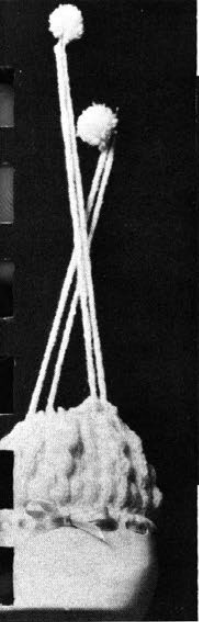

**KG 1929**  
 Watch a small girl squeal with delight when she opens and folds back the top of the pretty drawstring Purse to find it turns into a Bassinette with baby doll inside. Use KNITKING Sonika Dralon 3-ply. See page 31

**KG 1930**  
 A large Tote Bag is knitted in two colors using KNITKING Double Knitting. It's fun to make and is a wonderful Gift for anyone. The Reindeer Design is made with JAC 40 and Pattern No. 319. See page 32

**KG 1931**



Knit a Christmas Wreath Lapel Pin to wear during the Holiday Season . . . only minutes to make . . . so tuck one in with a special Christmas Greeting to far-away friends. KNITKING Subita Crepe 2 x 3. See page 32



**KG 1932**  
 Cozy Footee's for Children, Women and Men are quickly knitted and completed for that extra gift you'll surely need. Knit them with KNITKING Subita Dralon 3-ply. See page 31

**KG 1933**  
 Designed for the Golfer who insists on protecting his valuable Golf Clubs . . . He'll make good use of these numbered Golf Mitts and appreciate them for years to come. Knit them with KNITKING Double Knitting. See page 32

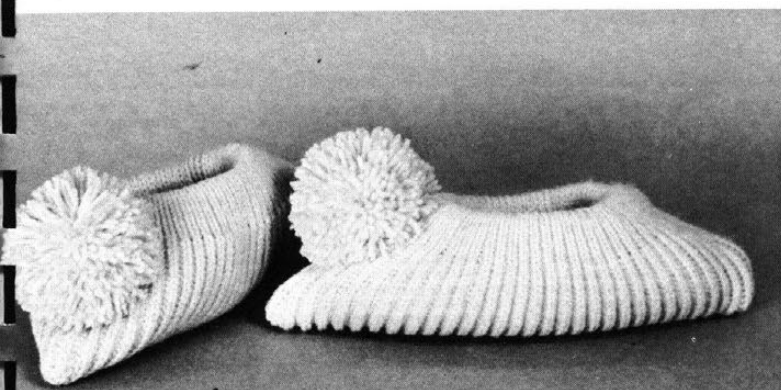
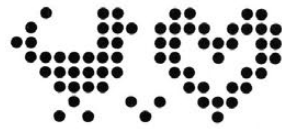





**MK 5310**  
She'll sing happily and look adorable dressed in her new party Dress. The Skirt and Sleeve sections are knitted in Stockinette Stitch with the Yoke, Pockets and Cuffs in an easy Holding Position Design. KNIT-KING Subita Crepe 2 x 3 for size 3 to 4 or you may use Amore. See page 30

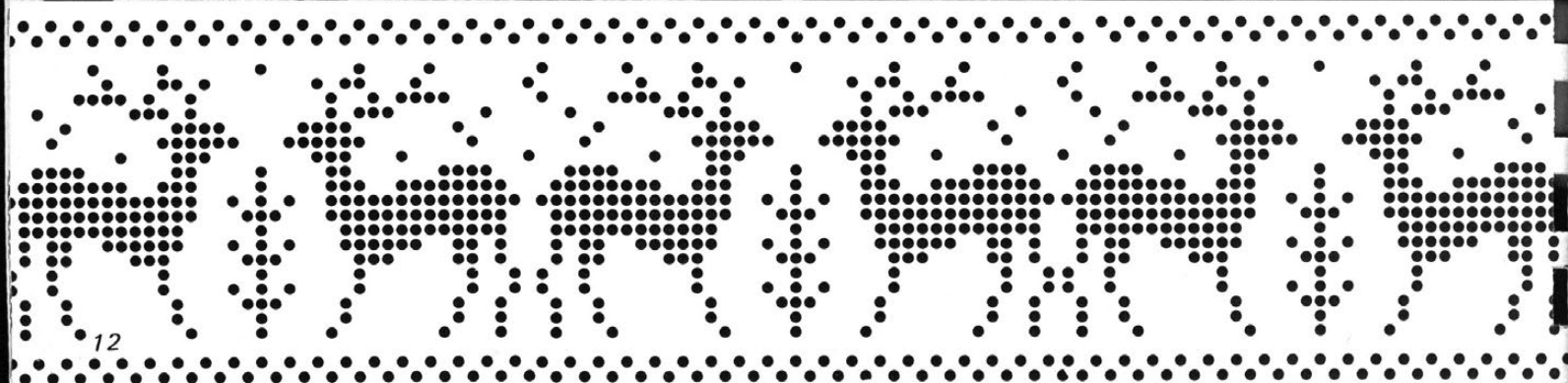



# DK 7976

SIZE 8 (Bust 31 1/2"), SIZE 12 (Bust 34"), SIZE 14 (Bust 36").  
**SIZE 8:** MATERIAL: 15-50gr. balls KNITTING Subita Crepe with Lurex and a 21" zipper, TENSION: 4 to 6. GAUGE: 17 sts, 2", 25 rows 2".  
**SIZE 12:** MATERIAL: 15-50gr. balls KNITTING Subita Crepe with Lurex and a 22" zipper, TENSION: 5 to 7. GAUGE: 16 sts, 2", 23 rows 2".  
**SIZE 14:** MATERIAL: 19-50gr. balls KNITTING Amore and a 22" zipper, TENSION: 7 to 9. GAUGE: 15 sts, 2", 23 rows 2".  
**ALL SIZES:** Taffeta to line the skirt. The instructions are the same for all sizes. **PATTERN:** Stockinette Stitch and Eyelet Design. Stripes according to Line Drawing. **DECREASES:** After rows indicated, hang the 3rd st. on each side onto the 2nd st., then move the end sts. inward to fill the empty needle. **INCREASES:** After rows indicated, move the 2 end sts. on the appropriate sides 1 needle outward, then place the 3rd st. from the row below onto the empty needle. Finished length: **SIZE 8:** 48"; **SIZE 12 and 14:** 52".

**FINISHING:** Weave the skirt sections together, 1 st. in from each edge, leaving the center back seam open about 6". Join front and back sections of bodice at sides and shoulders. Turn under 4 sts. around armhole edges and hem to wrong side. Sew 1 edge of neckband to inside and 1 edge to outside of neckline. Join bodice to skirt, easing in the fullness of bodice. Work 1 row of slip st. crocheted around back opening, then sew in the zipper. Turn under 40 rows on lower edge and hem to wrong side. Line the skirt with taffeta. Sew belt to belt backing. Sew buckle to belt.

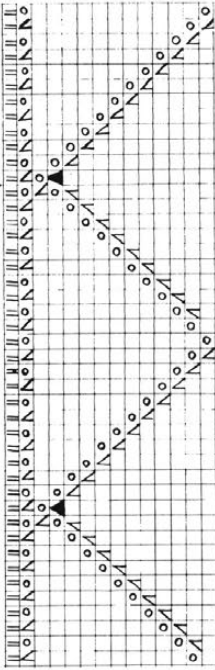

Work the second back section with reverse shapings, casting on from right to left. (Cam Box will be on the LEFT side at Row 0).

**ON CAM BOX SIDE**, bind off 4 sts. after Row 170 (EVEN ROWS = SHOULDERS SHAPING); 8 sts. after Row 171 (ODD ROW = NECK SHAPING); 4 sts. after Rows 172, 173, 174, 175, 176; 2 sts. after Row 177; 4 sts. after Row 178; 2 sts. after Row 179; 4 sts. after Row 180; 2 sts. after Row 181; 4 sts. after Row 182; 2 sts. after Row 183; 5 sts. after Row 184.

**ON CAM BOX SIDE**, bind off 4 sts. after Row 96; 3 sts. after Row 98; 2 sts. after Rows 100, 102, 104; 1 st. after Rows 106, 108, 110, then knit to Row 170.

**ON CAM BOX SIDE**, increase 1 st. after Rows 18, 30, 42, 54, 66, 78, then knit to Row 96.

**ROWS 0 to 18:** Knit even, then begin the Eyelet Design.

Cast on 67 sts. and work stockinette st.

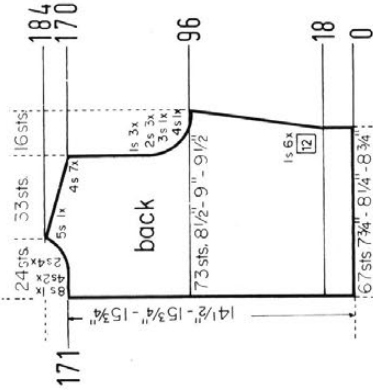

Cast on 18 sts., work stockinette st. and knit to Row 392, then work Short Rows. **ON OPPOSITE SIDE** of CAM BOX put into holding position 2 needles after Rows 392, 394, 396, 398, 400, 402, 404, 406. After Row 408 bring all needles back into working position, then bind off all 18 sts.

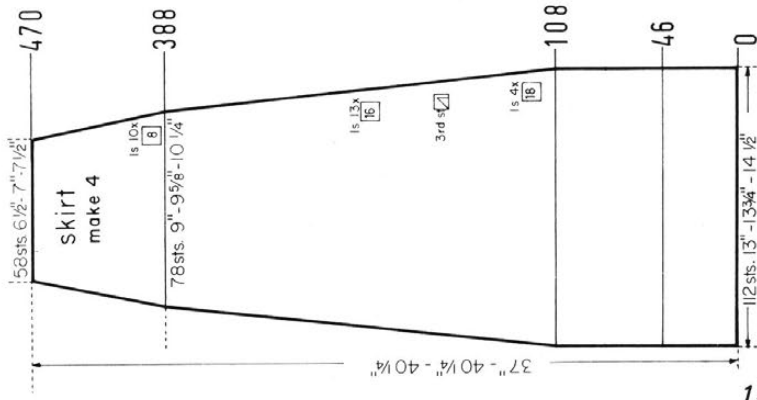
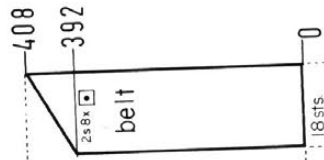

Work 3 more sections the same.

**ON EACH SIDE** decrease 1 st. after Rows 108, 126, 144, 162, 180, 196, 212, 228, 244, 260, 276, 292, 308, 324, 340, 356, 372, 388, 396, 404, 412, 420, 428, 436, 444, 452, 460, then knit to Row 470 and bind off the remaining 58 sts.

**ROWS 47 to 108:** Knit even.

**ROWS 0 to 46:** Knit even, then begin the Eyelet Design.

Cast on 112 sts. and work stockinette st.



Cast on 105 sts. and work 32 rows stockinette st., then bind off all sts.

Move the Cam Box to the left side, turn the Row Counter back to 162 and complete the left half. Follow the instructions from\*.

\***ON CAM BOX SIDE**, bind off 3 sts. after Rows 163, 165; 2 sts. after Rows 167, 169, 171, 173; 1 st. after Rows 175, 177, 179, 181. For SHOULDERS bind off 4 sts. after Rows 184, 186, 188, 190, 192, 194, 196; 5 sts. after Row 198.

**ON CAM BOX SIDE**, bind off 4 sts. after Rows 110, 111; 3 sts. after Rows 112, 113; 2 sts. after Rows 114, 115, 116, 117, 118, 119; 1 st. after Rows 120, 121, 122, 123, 124, 125, then knit to Row 162, bind off the center 12 sts., put the needles on the left side into holding position and complete the right half first.

**ON EACH SIDE** increase 1 st. after Rows 18, 30, 42, 54, 66, then knit to Row 74 and work Short Rows for the Bust Darts. **ON OPPOSITE SIDE** of CAM BOX put into holding position 5 needles after Rows 74, 75, 76, 77, 78, 79, 80, 81, 82, 83, 84, 85, 86, 87. **ON OPPOSITE SIDE** of CAM BOX bring all needles back into working position after Rows 88, 89. Increase 1 st. **ON EACH SIDE** after Row 92, then knit to Row 110.

**ROWS 0 to 18:** Knit even, then begin the Eyelet Design.

Cast on 134 sts. and work stockinette st.

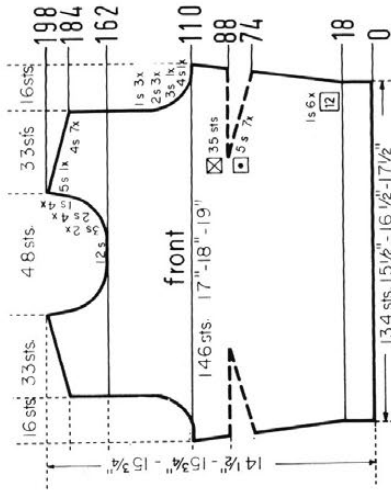



# DK 7960

SIZE 12/14 (Bust 34"-36"), SIZE 16 (Bust 38")  
 SIZE 12/14: MATERIAL: TUNIC 9-50gr. balls Color 1 and 4-50gr. balls Color 2; PANTS 10-50gr. balls Color 1 KNIITING Subita Crepe 2 x 3, TENSION: 3 to 5, GAUGE: Stockinette Stitch on Pants: 18 sts, 2", 25 rows 2"; Holding Position Design and Stockinette Stitch combined on Tunic: 17 sts, 2", 35 rows 2". SIZE 16: MATERIAL: TUNIC 10-50gr. balls Color 1 and 5-50gr. balls Color 2; PANTS 11-50gr. balls Color 1 KNIITING Subita Crepe 2 x 3, TENSION: 4 to 6, GAUGE: Stockinette Stitch on Pants: 17 sts, 2", 24 rows"; Holding Position Design and Stockinette Stitch combined on Tunic: 16 sts, 2", 33 rows 2". The instructions are the same for both sizes. PATTERN: PANTS: Stockinette Stitch; TUNIC: Holding Position Design according to Line Drawing, or use JAC 40 and Pattern No. 445. PANTS: DECREAS: After rows indicated, hang the 3rd st. on the appropriate sides onto the 2nd st. then move the end sts. inward to fill the empty needle. INCREASES: After rows indicated, move the 2

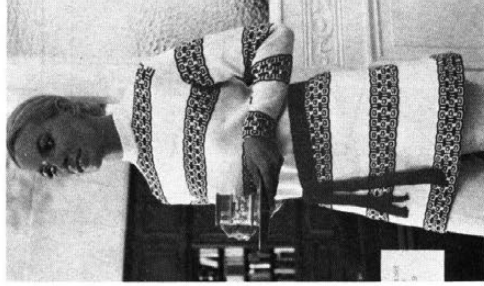

45-90 Color 1  
 45-46 Color 2  
 43-44 Color 1  
 42 Color 2  
 37-40 Color 1  
 35-38 Color 2  
 33-34 Color 1  
 31-32 Color 2  
 29-30 Color 1  
 27-28 Color 2  
 25-26 Color 1  
 23-24 Color 2  
 21-22 Color 1  
 19-20 Color 2  
 17-18 Color 1  
 15-16 Color 2  
 13-14 Color 1  
 11-12 Color 2  
 9-10 Color 1  
 7-8 Color 2  
 5-6 Color 1  
 3-4 Color 2  
 1-2 Color 1

end sts. on the appropriate sides 1 needle outward, then place the 3rd st. from the row below onto the empty needle. Begin the DARTS by hanging the sts. together as marked on the diagrams, then move the end sts. inward to fill the empty needles. The following decreases for the darts lie directly above. TUNIC: DECREAS: On each side after rows indicated, hang the 1st st. onto the 2nd st. INCREASES: On each side after rows indicated, place the end st. from the row below onto the next empty needle.

FINISHING: TUNIC: Join front and back section at sides and shoulders. Sew sleeves together and set in. Turn under 28 rows on lower edge and sleeve edges and hem to wrong side. Sew 1 edge of collar to inside and 1 edge to outside of neckline. Work 1 row of single crochet around back opening, then sew in a zipper. Knot fringe into short ends of belt. PANTS: Join sections at sides, center front and center back. Sew leg seams together. Turn under 20 rows on upper edge and leg edges and hem to wrong side. Insert an elastic band into upper hem.



Cast on 130 sts. with Color 1 and work 38 rows stockinette st., then bind off all sts.

Bring the needles on the left side into working position, knit 1 row in PATTERN to the left side, turn the Row Counter back to 510 and complete the left half. Follow the instructions from\*.

\*ON CAM BOX SIDE, bind off 3 sts. after Rows 513, 517, 521 (ODD ROWS = NECK SHAPING); 2 sts. after Rows 525, 529, 533; 1 st. after Row 537; 3 sts. after Rows 538, 540 (EVEN ROWS = SHOULDER SHAPING); 1 st. after Row 541; 3 sts. after Rows 542, 544; 1 st. after Row 545; 3 sts. after Rows 546, 548; 1 st. after Row 549; 3 sts. after Rows 550, 552; 1 st. after Row 553; 3 sts. after Rows 554, 556, 558; 4 sts. after Row 560.

Work the front section the same as the back section to ROW 510, then bind off the center 11 sts., put the needles on the left side into holding position and complete the right half first.

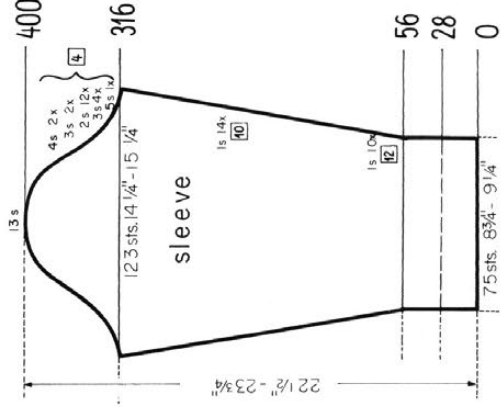
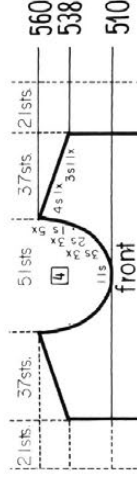

ON CAM BOX SIDE, bind off 5 sts. after Rows 316, 317; 3 sts. after Rows 320, 321, 324, 325, 328, 329, 332, 333; 2 sts. after Rows 336, 337, 340, 341, 344, 345, 348, 349, 352, 353, 356, 357, 360, 361, 364, 365, 368, 369, 372, 373, 376, 377, 380, 381; 3 sts. after Rows 384, 385, 388, 389; 4 sts. after Rows 392, 393, 396, 397; 13 sts. after Row 400.

ON EACH SIDE, increase 1 st. after Rows 56, 68, 80, 92, 104, 116, 126, 140, 152, 164, 176, 186, 196, 206, 216, 226, 236, 246, 256, 266, 276, 286, 296, 306, then knit to Row 316.

ROWS 0 to 28: Knit even, then work the Holding Position Design.  
 Cast on 75 sts. with Color 1 and work stockinette st.

Bring the needles on the left side into working position, knit 1 row in PATTERN to the left side, turn the Row Counter back to 476 and complete the left half. Follow the instructions from\*.

ON CAM BOX SIDE, bind off 3 sts. after Row 538 (EVEN ROWS = SHOULDER SHAPING); 8 sts. (9 sts. for the left half) after Row 539 (ODD ROWS = NECK SHAPING); 3 sts. after Rows 540, 541, 542, 543, 544, 545, 546; 2 sts. after Row 547; 3 sts. after Row 548; 2 sts. after Row 549; 3 sts. after Row 550; 2 sts. after Row 551; 3 sts. after Row 552; 1 st. after Row 553; 3 sts. after Row 554; 1 st. after Row 555; 3 sts. after Rows 556, 558; 4 sts. after Row 560.

\*Rows 477 to 538: Knit even.  
 ON CAM BOX SIDE, bind off 5 sts. after Rows 406, 407; 3 sts. after Rows 410, 411, 414, 415; 2 sts. after Rows 418, 419, 422, 423, 426, 427; 1 st. after Rows 430, 431, 434, 435, 438, 439, 442, 443, then knit to Row 476, put 63 needles on the left side into holding position and complete the right half first. (For the Front Section knit even to ROW 510 after completion of the Arm-hole Shaping).

ON EACH SIDE, increase 1 st. after Rows 294, 310, 326, 342, 358, 374, 390, then knit to Row 406.

ON EACH SIDE, decrease 1 st. after Rows 84, 98, 112, 126, 140, 154, 168, 182, 194, 206, 218, 230, 242, 254, 266, then knit to Row 294.  
 ROWS 29 to 84: Knit even.  
 ROWS 0 to 28: Knit even, then work the Holding Position Design.  
 Cast on 183 sts. with Color 1 and work stockinette st.

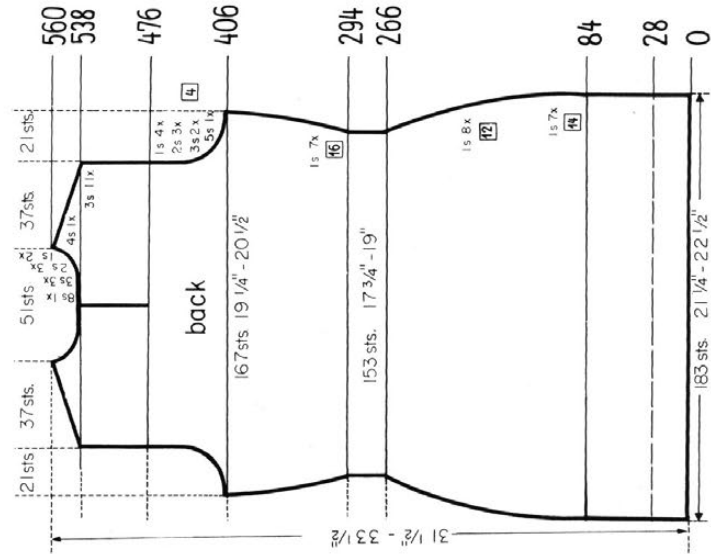



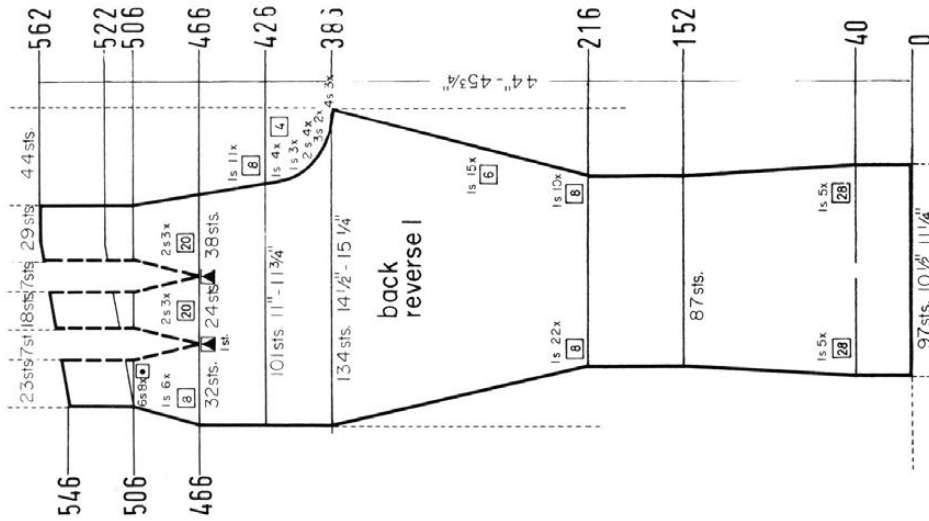

Work the second back section with reverse shapings, casting on from right to left. (Cam Box will be on the LEFT side at Row 0).

Decrease 2 sts. for EACH DART after Rows in ( ). ON EACH SIDE decrease 1 st. after Rows 466, (466), 474, 482, (486), 490, 498, 506, (506), but do not knit after last decreases. Work Short Rows. ON OPPOSITE SIDE of CAM BOX put into holding position 6 needles after Rows 506, 508, 510, 512, 514, 516, 518, 520. After Row 522 bring all needles back into working position, then knit to Row 562 and bind off the remaining 72 sts.

ON CAM BOX SIDE, bind off 4 sts. after Rows 386, 388, 390; 3 sts. after Rows 392, 394; 2 sts. after Rows 396, 398, 400, 402; 1 st. after Rows 404, 406, 408, 410, 414, 418, 422, 426, 434, 442, 450, 458, then knit to Row 466.

ON EACH SIDE, increase 1 st. after Rows 216, 224, 232, 240, 248, 256, 264, 272, 280, 288, 296 then increase 1 st. ON OPPOSITE SIDE of CAM BOX after Rows in ( ). ON CAM BOX SIDE increase 1 st. after Rows 302, (304), 308, (312), 314, 320, (326), (328), 332, (336), 338, 344, (344), 350, (352), 356, (360), 362, 368, (368), 374, (376), 380, (384), then knit to Row 386.

ON EACH SIDE, decrease 1 st. after Rows 40, 68, 96, 124, 152, then knit to Row 216.

ROWS 0 to 40: Knit even.

Cast on 97 sts. and work stockinette st.

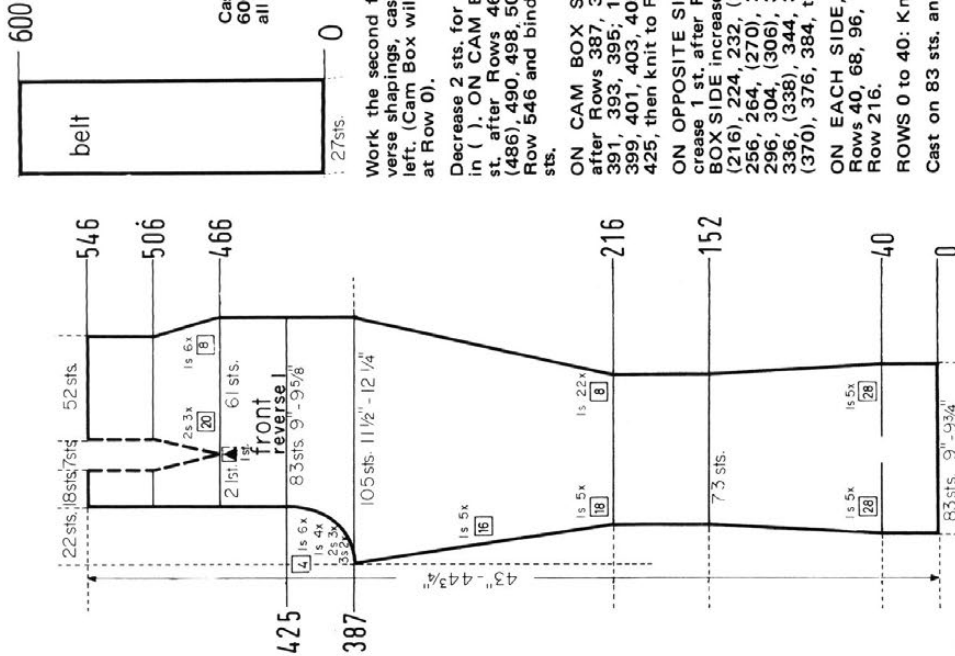

Work the second front section with reverse shapings, casting on from right to left. (Cam Box will be on the LEFT side at Row 0).

Decrease 2 sts. for the DART after Rows in ( ). ON CAM BOX SIDE decrease 1 st. after Rows 466, (466), 474, 482, (486), 490, 498, 506, (506), then knit to Row 546 and bind off the remaining 71 sts.

ON CAM BOX SIDE, bind off 3 sts. after Rows 387, 389; 2 sts. after Rows 391, 393, 395; 1 st. after Rows 397, 399, 401, 403, 405, 409, 413, 417, 421, 425, then knit to Row 466.

ON OPPOSITE SIDE of CAM BOX increase 1 st. after Rows in ( ). ON CAM BOX SIDE increase 1 st. after Rows 216, (216), 224, 232, (234), 240, 248, (252), 256, 264, (270), 272, 280, 288, (288), 296, 304, (306), 312, 320, (322), 328, 336, (338), 344, 352, (354), 360, 368, (370), 376, 384, then knit to Row 387.

ON EACH SIDE, decrease 1 st. after Rows 40, 68, 96, 124, 152, then knit to Row 216.

ROWS 0 to 40: Knit even.

Cast on 83 sts. and work stockinette st.

# A FEW LEFT ... BOUND VOLUMES 5&6

If purchased separately the magazines would cost a total of \$9.00.

The volume contains over 120 fully illustrated complete stylish patterns for all members of the family, together with many valuable, practical knitting hints.

There is a very limited number of these volumes available and it will undoubtedly become a collectors item.

If you already have the entire set it will almost certainly be well thumbed and marked. Why not purchase a perfect mint condition volume for your bookshelf and ready reference at any time.

D. G. C.

Place your order today and avoid disappointment. Send it to **KNITKING MAGAZINE, 1128 Crenshaw Boulevard, Los Angeles, California 90019.**

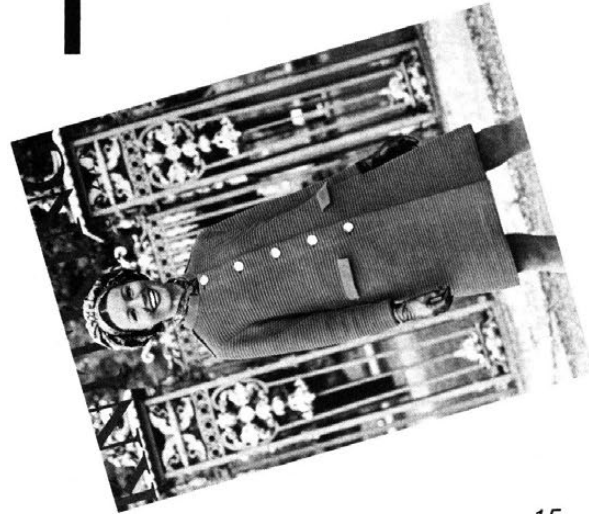

The complete fifth or sixth volume of **KNITKING MAGAZINE** with flexible, transparent plastic covers and specially bound so that they will stay open at any page, are available at the special price of \$6.95 each (plus 95 cents mailing costs).

# DK 7955

SIZE 10 (Bust 32½") SIZE 12 (Bust 34") SIZE 14 (Bust 36") SIZE 16 (Bust 38") SIZE 18 (Bust 40")  
**MATERIAL:** 7-50gr. balls Color 1 and 6-50gr. balls Color 2 **KNITTING** Subita Crepe 2 x 4, **TENSION:** 5 to 7, **GAUGE:** 16 sts, 2" 21 rows 2", **SIZE 12:** MATERIAL: 7-50gr. balls Color 1 and 6-50gr. balls Color 2 **KNITTING** Crocus Crepe, **TENSION:** 6 to 8, **GAUGE:** 15 sts, 20 rows 2", **SIZE 14:** MATERIAL: 7-50gr. balls Color 1 and 6-50gr. balls Color 2 **KNITTING** Sonika Dralon, **TENSION:** 7 to 9, **GAUGE:** 14 sts, 2" 19 rows 2". The instructions are the same for all sizes. **PATTERN:** Norwegian Design according to Line Drawing, or use JAC 40 and Pattern No. 442. In the instructions, each row in the Norwegian Design is counted as 1 row, but several movements of the Cam Box are needed to complete 1 row. **DECREASES:** After rows indicated, hang the 1st st. on each side onto the 2nd st. **INCREASES:** On the appropriate sides, after rows indicated place the end st. from the row below onto the next empty needle.

**FINISHING: SKIRT:** Sew the back sections together, then join back and front sections at sides. Turn under 16 rows on lower edge and hem to wrong side. Turn under 2½" on each front edge and hem to wrong side. Turn under a small amount on upper edge and baste in place. Sew an elastic band against the basting line. Sew hooks and eyes to overlap and underlap. Finish buttonholes, sew on buttons. **VEST:** Join back and front sections at sides and shoulders, easing in the fullness at bustline of front sections. Turn under 12 rows on lower edge and 7 sts. on front edges and hem to wrong side. Work 2 rows of single crochet around neckline and armhole edges, then turn under the crochet rows and hem to wrong side.



Work the second back section the same. **ON EACH SIDE,** decrease 1 st. after Rows 56, 70, 84, 98, 112, 126, 140, 152, 164, 176, 188, 200, 208, 216, 224, 232, 240, 248, 256, 264, 272 then knit to Row 280 and bind off the remaining 55 sts.

**ROWS 17 to 56:** Knit even.  
**ROWS 0 to 16:** Knit even, then work the Norwegian Design.  
 Cast on 97 sts. with Color 1 and work stockinette st.

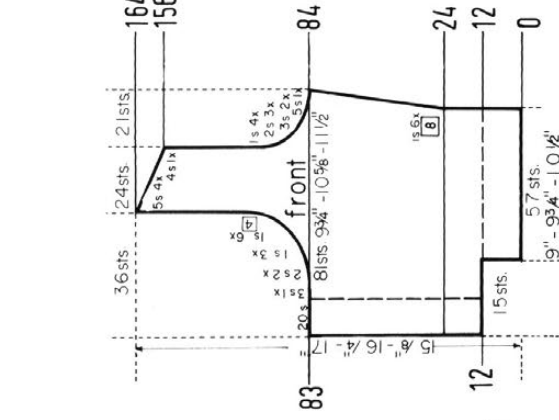
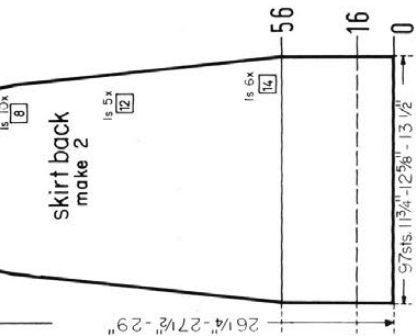
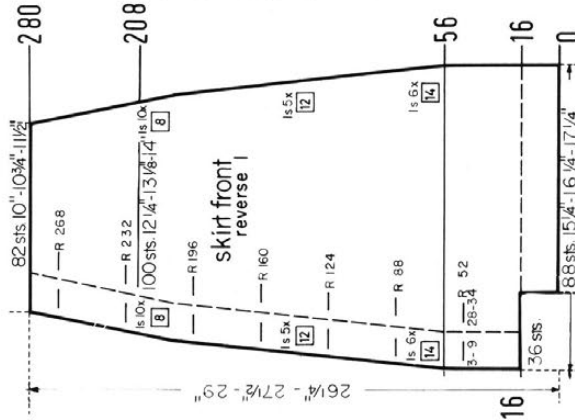
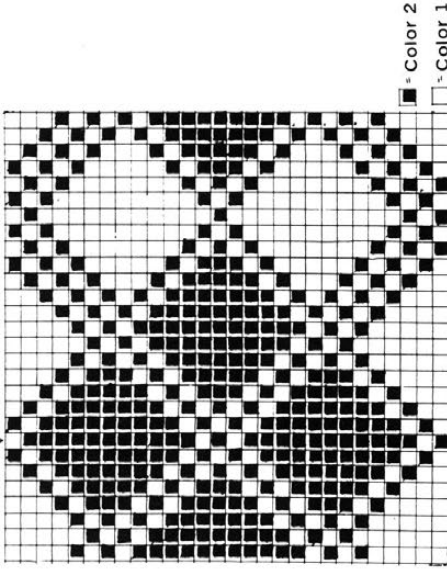

Work the second front section with reverse shaping, casting on from right to left. (Cam Box will be on the LEFT side at Row 0).

Make buttonholes over the 3rd-9th and 28th-34th sts. counting from the left side after Row 52, then again after Rows in ( ). **ON EACH SIDE,** decrease 1 st. after Rows 56, 70, 84, (88), 98, 112, (124), 126, 140, 152, (160), 164, 176, 188, (196), 200, 208, 216, 224, 232, (232), 240, 248, 256, 264, (268), 272, then knit to Row 280 and bind off the remaining 82 sts.

**ROWS 17 to 52:** Knit even.  
**ROWS 0 to 16:** Knit even, then cast on 36 sts. **ON OPPOSITE SIDE** of CAM BOX (use a separate length of yarn) and work the Norwegian Design.  
 Cast on 88 sts. with Color 1 and work stockinette st.

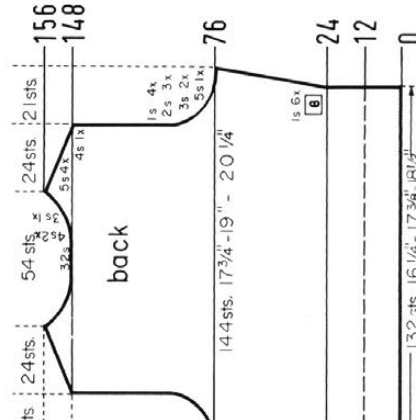

Bring the needles on the left side into working position, knit 1 row in PAT-TERN to the left side, turn the Row Counter back to 148 and complete the left half. Follow the instructions from\*.

\***ON CAM BOX SIDE,** bind off 4 sts. after Rows 148 (EVEN ROWS = SHOULDER SHAPING), 149 (ODD ROWS = NECK SHAPING); 5 sts. after Row 150; 4 sts. after Row 151; 5 sts. after Row 152; 3 sts. after Row 153; 5 sts. after Rows 154, 156.

**ON CAM BOX SIDE,** bind off 5 sts. after Rows 76, 77; 3 sts. after Rows 78, 79, 80, 81; 2 sts. after Rows 82, 83, 84, 85, 86, 87; 1 st. after Rows 88, 89, 90, 91, 92, 93, 94, 95, then knit to Row 148, bind off the center 32 sts., put the needles on the left side into holding position and complete the right half first.

**ON EACH SIDE,** increase 1 st. after Rows 24, 32, 40, 48, 56, 64, then knit to Row 76.

**ROWS 13 to 24:** Knit even.  
**ROWS 0 to 12:** Knit even, then work the Norwegian Design.  
 Cast on 132 sts. with Color 1 and work stockinette st.

Work the second front section with reverse shapings, casting on from right to left. (Cam Box will be on the LEFT side at Row 0).

**ON CAM BOX SIDE,** bind off 20 sts. after Row 83 (ODD ROWS = NECK SHAPING); 5 sts. after Row 84 (EVEN ROWS = ARMHOLE SHAPING); 3 sts. after Rows 85, 86; 2 sts. after Row 87; 3 sts. after Row 88; 2 sts. after Rows 89, 90; 1 st. after Row 91; 2 sts. after Row 92; 1 st. after Rows 95, 96, 97, 98, 100, 101, 102, 105, 109, 113, 117. Knit to Row 156 then bind off for SHOULDER 4 sts. after Row 156; 5 sts. after Rows 158, 160, 162, 164.

**ON CAM BOX SIDE** increase 1 st. after Rows 24, 32, 40, 48, 56, 64, then knit to Row 83.

**ROWS 13 to 24:** Knit even.

**ROWS 0 to 12:** Knit even, then cast on 15 sts. **ON OPPOSITE SIDE** of CAM BOX (use a separate length of yarn) and work the Norwegian Design.

Cast on 57 sts. with Color 1 and work stockinette st.



# DP 7956

SIZE 10 (Bust 32½"), SIZE 12 (Bust 34"), SIZE 14 (Bust 36"). SIZE 10: MATERIAL: Pullover 10-50gr. balls; Leotites 8-50gr. balls KNOTTING Subita Crepe 2 x 4. TENSION: 4 to 6. GAUGE: 19 sts., 24 rows 2". SIZE 12: MATERIAL: Pullover 11-50gr. balls; Leotites 9-50gr. balls KNOTTING KING Crocus Crepe. TENSION: 5 to 7. GAUGE: 18 sts., 23 rows 2". SIZE 14: MATERIAL: Pullover 10-50gr. balls; Leotites 9-50gr. balls KNOTTING Sonika Dralon. TENSION: 6 to 8. GAUGE: 17 sts., 22 rows 2". The instructions are the same for all sizes. PATTERN: Knit 1, Purl 3. Ribbing according to Line Drawing. (3 sts. on the main machine and 1 st. on the ribber) The purl side is the right side. Foot of Leotites: Stockinette Stitch worn on the knit side. To turn the knitting, transfer the ribber sts. to the main machine, then put all sts. onto a stitch holder. Turn the knitting and hang the sts. back onto the machine. INCREASES: On each side after rows indicated, place the end st. from the row below onto the next empty needle. DECREASES: On each side after rows indicated, hang the 1st st. onto the 2nd st. When putting needles into holding position, transfer the appropriate ribber sts. to the main machine.

FINISHING: PULLOVER: Join front and back section at sides and shoulders. Sew sleeves together and set in. Join short ends of collar, then sew 1 edge of collar to inside and 1 edge to outside of neckline. LEOTITES: Join sections at center back and center front. Sew leg seams together. Weave the open sts. together. Join sole and instep at sides. Sew gusset in place. Turn under 9 rows on upper edge and hem to wrong side. Insert an elastic band into hem.

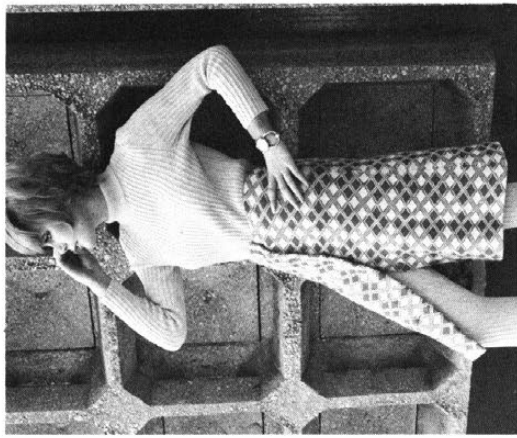

Bring the needles on the left side into working position, knit 1 row in PATTERN to the left side, turn the Row Counter back to 248 and complete the left half. Follow the instructions from\*.

\*ON CAM BOX SIDE, bind off 4 sts. after Row 249; 3 sts. after Rows 251, 253; 2 sts. after Rows 255, 257, 259; 1 st. after Rows 161, 163, 165. For SHOULDER bind off 4 sts. after Rows 272, 274, 276; 5 sts. after Rows 278, 280, 282, 284, 286.

Work the front section the same as the back section to ROW 248, then bind off the center 13 sts., put the needles on the left side into holding position and complete the right half first.

Bring the needles on the left side into working position, knit 1 row in PATTERN to the left side, turn the Row Counter back to 272 and complete the left half. Follow the instructions from\*.

\*ON CAM BOX SIDE, bind off 4 sts. after Rows 272 (EVEN ROWS = SHOULDER SHAPING), 274, 275, 276; 3 sts. after Row 277; 5 sts. after Row 278; 3 sts. after Row 279; 5 sts. after Row 280; 3 sts. after Row 281; 5 sts. after Rows 282, 284, 286.

ON CAM BOX SIDE, bind off 5 sts. after Rows 184, 185; 3 sts. after Rows 186, 187, 188, 189; 2 sts. after Rows 190, 191, 192, 193, 194, 195; 1 st. after Rows 196, 197, 198, 199, 200, 201, then knit to Row 272, bind off the center 17 sts., put the needles on the left side into holding position and complete the right half first. (For the Front Section knit to Row 248.)

ROWS 0 to 184: Knit even.

Cast on 165 sts. and work Knit 1, Purl 3, Ribbing.

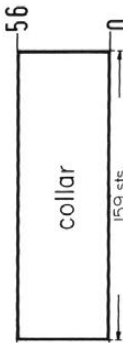
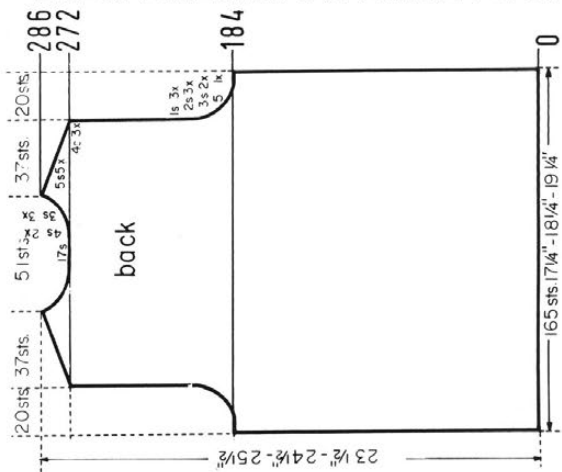
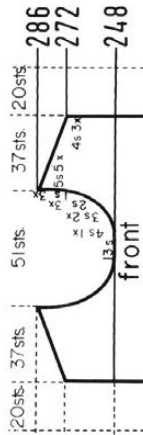

Cast on 159 sts. and work 56 rows K1, P1, Ribbing, then bind off all sts.

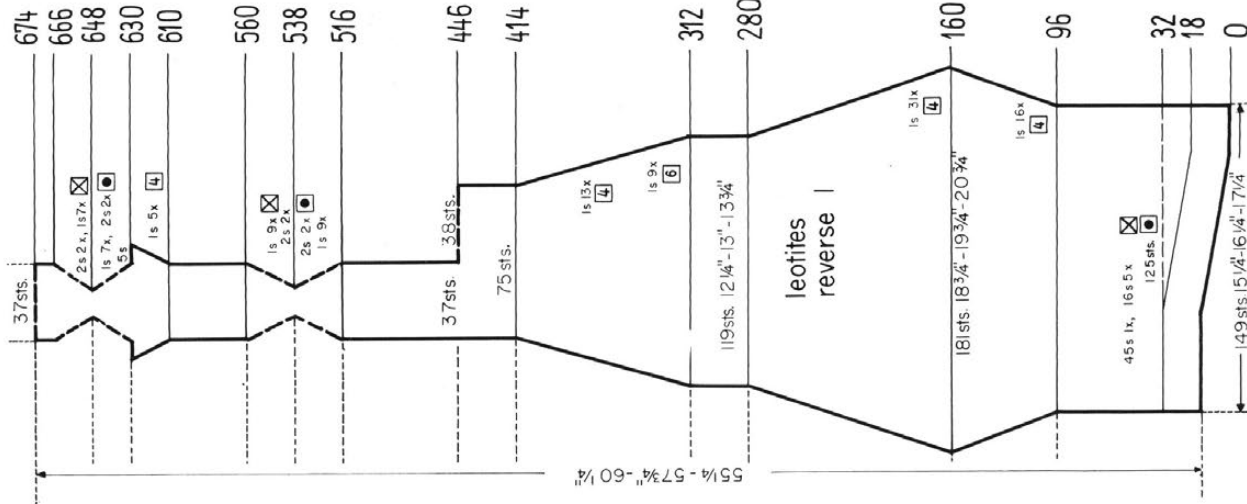

Work the second section with reverse shapings, casting on from right to left. (Cam Box will be on the LEFT side at Row 0).

ON OPPOSITE SIDE of CAM BOX put into holding position 1 needle after Rows 516, 517, 518, 519, 520, 521, 522, 523, 524, 525, 526, 527, 528, 529, 530, 531, 532, 533; 2 needles after Rows 534, 535, 536, 537, then bring back into working position 2 needles after Rows 538, 539, 540, 541; 1 needle after Rows 542, 543, 544, 545, 546, 547, 548, 549, 550, 551, 552, 553, 554, 555, 556, 557, 558, 559. Now knit to Row 610, then increase 1 st. ON EACH SIDE after Rows 610, 614, 618, 622, 626. After Row 630 bind off 5 sts. ON EACH SIDE (use a separate length of yarn for the opposite side), then work Short Rows. ON OPPOSITE SIDE of CAM BOX put into holding position 1 needle after Rows 630, 631, 632, 633, 634, 635, 636, 637, 638, 639, 640, 641, 642, 643; 2 needles after Rows 644, 645, 646, 647, then bring back into working position 2 needles after Rows 648, 649, 650, 651; 1 needle after Rows 652, 653, 654, 655, 656, 657, 658, 659, 660, 661, 662, 663, 664, 665, then knit to Row 674 and put the 37 sts. onto a stitch holder.

ON EACH SIDE, decrease 1 st. after Rows 160, 164, 168, 172, 176, 180, 184, 188, 192, 196, 200, 204, 208, 212, 216, 220, 224, 228, 232, 236, 240, 244, 248, 252, 256, 260, 264, 268, 272, 276, 280, then again after Rows 312, 318, 324, 330, 336, 342, 348, 354, 360, 366, 370, 374, 378, 382, 386, 390, 394, 398, 402, 406, 410, 414, then knit to Row 446, put 38 sts. ON CAM BOX SIDE onto a stitch holder and knit over the remaining 37 sts. to Row 516, turn the knitting and work stockinette st.

Knit even to Row 18, then work Short Rows. ON OPPOSITE SIDE of CAM BOX put into holding position 125 needles, then bring back into working position 16 needles after Rows 20, 22, 24, 26, 28; 45 needles after Row 30. Knit even over all 149 sts. to Row 96, then increase 1 st. ON EACH SIDE after Rows 96, 100, 104, 108, 112, 116, 120, 124, 128, 132, 136, 140, 144, 148, 152, 156, then knit to Row 160. Cast on 149 sts. and work Knit 1, Purl 3, Ribbing.

**SIZE 12** (Bust 34"), **SIZE 14** (Bust 36"), **SIZE 16** (Bust 38"). **SIZE 12:** MATERIAL: PANTS 10-50gr, balls; VEST 13-50gr, balls. **KNITTING** Subita Crepe 2 x 4. **TENSION:** 5 to 7 GAUGE: Stockinette Stitch 16 sts, 2" rows 2". **PATTERN** Stockinette Stitch 16 sts, 2" rows 2". **MA-** **TERRIAL:** PANTS 11-50gr, balls; VEST 15-50gr, balls. **KNITTING** Crocus Crepe. **TENSION:** 6 to 8 GAUGE: Stockinette Stitch 15 sts, 2" rows 2". **PATTERN:** Stockinette Stitch 15 sts, 2" rows 2". **MA-** **TERRIAL:** PANTS 15-50gr, balls; VEST 20-50gr, balls. **KNITTING** Lovely. **TENSION:** 8 to 10 GAUGE: Stockinette Stitch 14 sts, 2" rows 2". **PATTERN:** Stockinette Stitch 14 sts, 2" rows 2". **MA-** **TERRIAL:** PANTS 14 sts, 2" rows 2". **PATTERN:** instructions are the same for all sizes. **PANTS** Stockinette Stitch; VEST Holding Position Design according to Line Drawing, worn on the puri side. **KNITTING** AM3 use Wheel W2 and push in the right Retractor Button. **PANTS:** Decreases: After rows indicated, hang the 3rd st. on the appropriate sides onto the 2nd st, then move the end sts. inward to fill the empty needle. **Increases:** After rows indicated, move the 2 end sts. on the appropriate sides 1 needle outward, then place the 3rd st. from the row below onto the empty needle. **Begin the DARTS** by hanging the sts. together as marked on the diagrams, then move the end sts. inward to fill the empty needles. The following decreases for the DARTS lie directly above. **VEST:** Decreases: After rows indicated, hang the 1st st. on the appropriate sides onto the 2nd st. **Increases:** On the appropriate sides place the end st. from the row below onto the next empty needle.

**FINISHING: PANTS:** Join sections at sides, center front and center back. Sew leg seams together. Turn under 21 rows on leg edges and 16 rows on upper edge and hem to wrong side. Insert an elastic band into upper hem. Fold lower hems into cuffs, press and sew in place at side seams. **VEST:** Join back sections. Join back and front sections at sides and shoulders, easing in the fullness at bustline of front sections. Join facing at center back, then sew facing to neckline. Turn under about 1" at front edges and around neckline and hem to wrong side. Turn under 4 sts. around armhole edges and hem to wrong side. Turn over 13 rows on upper pocket edges and hem to right side, then sew pockets in place. Turn under 21 rows on lower edge and hem to wrong side.

Cast on 60 sts. and work 90 rows the Holding Position Design, then work stockinette st. to Row 116 and bind off all sts.

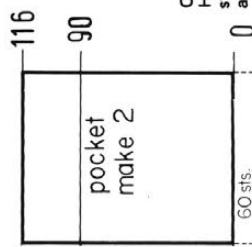

Work the second front section with reverse shapings, casting on from right to left. (Cam Box will be on the LEFT side at Row 0).

Decrease 2 sts. for the DART after Rows in ( ). ON CAM BOX SIDE, decrease 1 st. after Rows 400, (400), 408, 416, (418), 424, 432, (436), 440, then knit to Row 472 and bind off the remaining 57 sts.

Continue to increase 1 st. ON CAM BOX SIDE after Rows in ( ). ON CAM BOX SIDE bind off 3 sts. after Rows 333, 335; 2 sts. after Rows 337, 339, (340), 341; 1 st. after Rows 343, 345, 347, 349, 351, (352), 355, 359, 363, (364), then knit to Row 400.

ON OPPOSITE SIDE of CAM BOX increase 1 st. after Rows in ( ). ON CAM BOX SIDE increase 1 st. after Rows 190, (190), 200, (202), 210, (214), 220, (226), 230, (238), 240, 250, (250), 260, (262), 270, (274), 280, (286), 290, (298), 300, 310, (310), 320, (322), 330, then knit to Row 333.

ON EACH SIDE decrease 1 st. after Rows 42, 68, 94, 120, 146, then knit to Row 190.

ROWS 0 to 42: Knit even.

Cast on 69 sts. and work stockinette st.

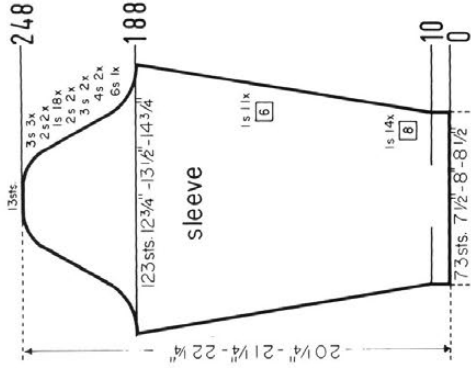
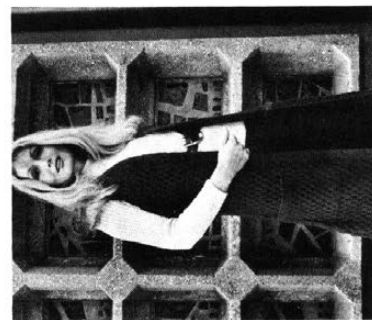
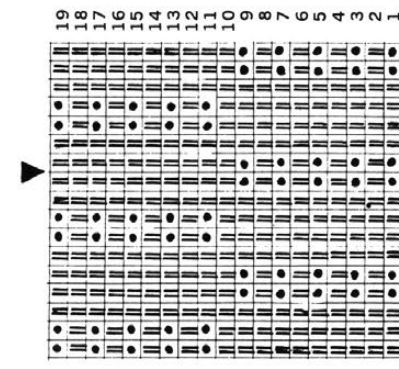
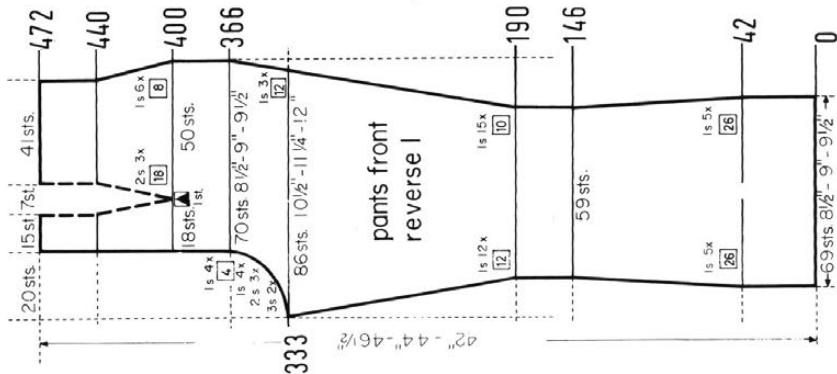

ON CAM BOX SIDE, bind off 6 sts. after Rows 188, 189; 4 sts. after Rows 190, 191, 192, 193; 3 sts. after Rows 194, 195, 196, 197; 2 sts. after Rows 198, 199, 200, 201. ON EACH SIDE, decrease 1 st. after Rows 202, 204, 206, 208, 210, 212, 214, 216, 218, 220, 222, 224, 226, 228, 230, 232, 234, 236. ON CAM BOX SIDE, bind off 2 sts. after Rows 238, 239, 240, 241; 3 sts. after Rows 242, 243, 244, 245, 246, 247; 13 sts. after Row 248.

ON EACH SIDE, increase 1 st. after Rows 10, 18, 26, 34, 42, 50, 58, 66, 74, 82, 90, 98, 106, 114, 122, 128, 134, 140, 146, 152, 158, 164, 170, 176, 182, then knit to Row 188.

ROWS 0 to 10: Knit even.

Cast on 73 sts. and work Knit 1, Purl 3, Ribbing.

Work the second back section with reverse shapings, casting on from right to left. (Cam Box will be on the LEFT side at Row 0).

Decrease 2 sts. for EACH DART after Rows in ( ). ON EACH SIDE, decrease 1 st. after Rows 400, (400), 408, 416, (418), 424, 432, (436), 440, but do not knit after last decrease. Work Short Rows. ON OPPOSITE SIDE of CAM BOX put into holding position 6 needles after Rows 440, 442, 444, 446, 448, 450. After Row 452 bring all needles back into working position, then knit to Row 484 and bind off the remaining 57 sts.

Continue to increase 1 st. ON OPPOSITE SIDE of CAM BOX after Rows in ( ). ON CAM BOX SIDE bind off 5 sts. after Row 332; 4 sts. after Rows 334, 336; 3 sts. after Rows 338, 340; (340), 2 sts. after Rows 342, 344; 1 st. after Rows 346, 348, 350, 352, (352), 356, 360, (364), 368, 376, 384, 392, then knit to Row 400.

ON OPPOSITE SIDE of CAM BOX increase 1 st. after Rows in ( ). ON CAM BOX SIDE increase 1 st. after Rows 190, (190), 196, (200), 202, 208, (210), 214, 220, (220), 226, (230), 232, 238, (240), 244, 250, (250), 256, (260), 262, 268, (270), 274, 280, (280), 286, (290), 292, 298, (300), 304, 310, (310), 316, (320), 322, 328, (330), then knit to Row 332.

ON EACH SIDE, decrease 1 st. after Rows 42, 68, 94, 120, 146, then knit to Row 190.

ROWS 0 to 42: Knit even.

Cast on 82 sts. and work stockinette st.

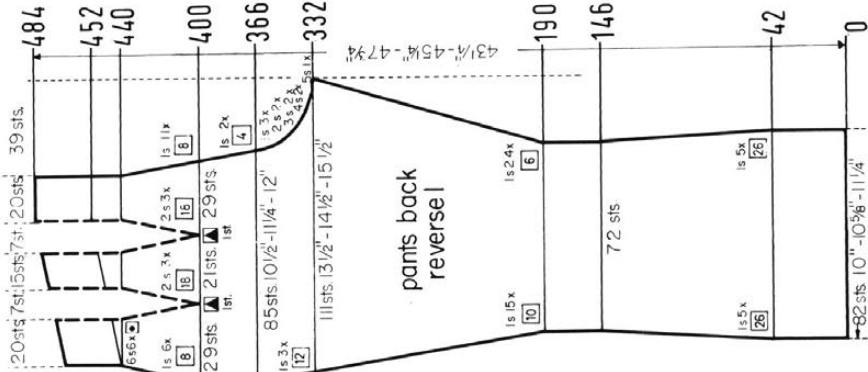



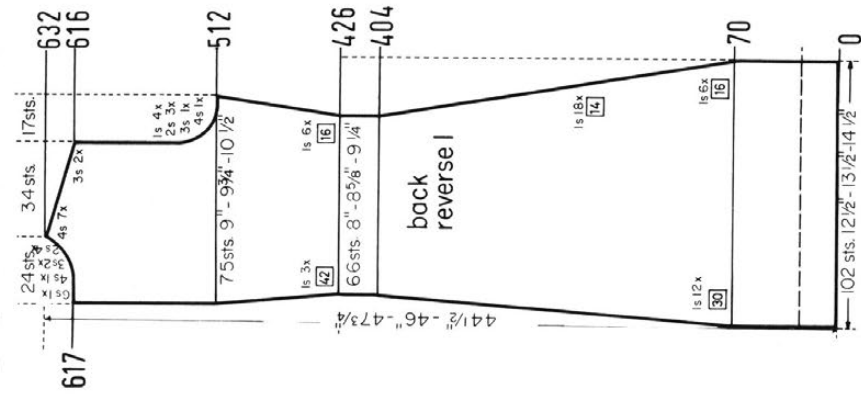

Work the second back section with reverse shapings. Cast on the usual way, then knit 1 row in PATTERN to the left side and turn the Row Counter to 0.

ON CAM BOX SIDE, bind off 3 sts. after Row 616 (EVEN ROWS = SHOULDER SHAPING); 6 sts. after Row 617 (ODD ROWS = NECK SHAPING); 3 sts. after Row 618; 4 sts. after Row 619; Row 620; 3 sts. after Row 621; 4 sts. after Row 622; 3 sts. after Row 623; 4 sts. after Row 624; 2 sts. after Row 625; 4 sts. after Row 626; 2 sts. after Row 627; 4 sts. after Row 628; 2 sts. after Row 629; 4 sts. after Row 630; 2 sts. after Row 631; 4 sts. after Row 632.

ON CAM BOX SIDE, bind off 4 sts. after Row 512; 3 sts. after Row 514; 2 sts. after Row 516, 518, 520; 1 st. after Row 522, 524, 526, 528, then knit to Row 616.

ON OPPOSITE SIDE of CAM BOX increase 1 st. after Rows in ( ). ON CAM BOX SIDE increase 1 st. after Rows 426, (426), 440, 454, 468, (468), 482, 496, (510), then knit to Row 512.

ON OPPOSITE SIDE of CAM BOX decrease 1 st. after Rows in ( ). ON CAM BOX SIDE decrease 1 st. after Rows 70, (70), 86, (100), 102, 118, (130), 134, 150 (160), 166, 180, (190), 194, 208, (220), 222, 236, 250, (250), 264, 278, (280), 292, 306, (310), 320, 334, (340), 348, 362, (370), 376, 390, (400), 404, then knit to Row 426.

ROWS 0 to 70: Knit even.

Cast on 102 sts. and work the Holding Position Design.

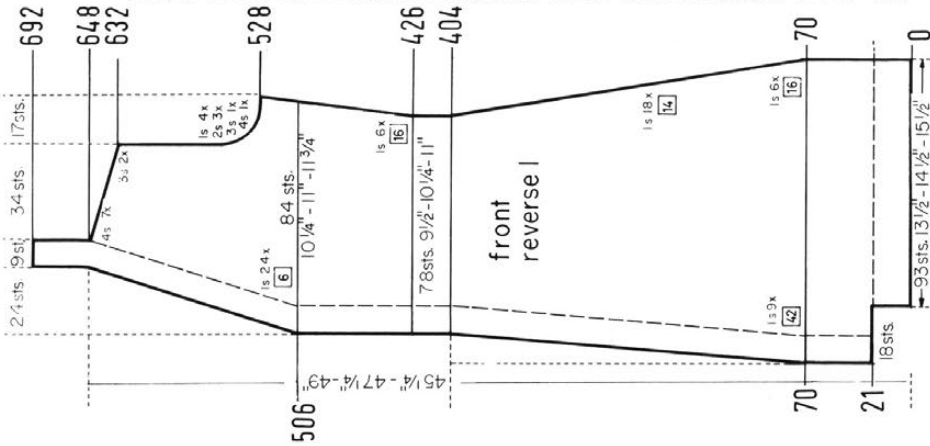

Work the second front section with reverse shapings. Cast on the usual way, then knit 1 row in PATTERN to the left side and turn the Row Counter to 0.

ON OPPOSITE SIDE of CAM BOX (NECK SIDE) decrease 1 st. after Rows 506, 512, 518, 524, then again after Rows in ( ). For Armhole bind off 4 sts. after Row 528; 3 sts. after Row 530; (530), 2 sts. after Rows 532, 534, 536; (536), 1 st. after Rows 538, 540, 542, (542), 544. The Armhole Shaping is now completed. Continue to decrease 1 st. ON NECK SIDE after Rows 548, 554, 560, 566, 572, 578, 584, 590, 596, 602, 608, 614, 620, 626, then again after Rows in ( ). For SHOULDER bind off 3 sts. after Rows 632, (632), 634; 4 sts. after Rows 636, 638, (638), 640, 642, 644, (644), 646, 648. Work over the remaining 9 sts. to Row 692, then bind off the sts.

ON CAM BOX SIDE, increase 1 st. after Rows 426, 440, 454, 468, 482, 496, then knit to Row 506.

ON OPPOSITE SIDE of CAM BOX decrease 1 st. after Rows in ( ). ON CAM BOX SIDE decrease 1 st. after Rows 70, (70), 86, 102, (112), 118, 134, 150, (154), 166, 180, 194, (196), 208, 222, 236, (238), 250, 264, 278, (280), 292, 306, 320, (322), 334, 348, 362, (364), 376, 390, 404, (406), then knit to Row 426.

ROWS 22 to 70: Knit even.

ROWS 0 to 21: Knit even, then cast on 18 sts. ON CAM BOX SIDE.

Cast on 93 sts. and work the Holding Position Design.



## DK 7951

SIZE 8/10 (Bust 31½"-32½"), SIZE 12/14 (Bust 34"-36"). SIZE 8/10: MATERIAL: 12-50gr. balls Color 1 and 10-50gr. balls Color 2 KNOTTING Excelsior. TENSION: 6 to 8. GAUGE: Stockinette Stitch 15 sts. 2", 21 rows 2"; Pattern Stitch 14 sts. 2", 31 rows 2". SIZE 12/14: MATERIAL: 14-50gr. balls Color 1 and 12-50gr. balls Color 2 KNOTTING Excelsior. TENSION: 7 to 9. GAUGE: Stockinette Stitch 14 sts. 2", 20 rows 2"; Pattern Stitch 13 sts. 2", 30 rows 2". The instructions are the same for both sizes. PATTERN: Front and back Section: Holding Position Design according to Line Drawing, or use JAC 40 and Pattern No. 441; Sleeves: Stockinette Stitch, DECREASES: On each side after Rows indicated, hang the 1st st. onto the 2nd st. INCREASES: On each side after rows indicated, place the end st. from the row below onto the next empty needle. Finished length: SIZE 8/10: 51"; SIZE 12/14: 52½".

FINISHING: Join front and back section at sides and shoulders. Sew sleeves together and set in. Turn under 13 rows on sleeve edges and hem to wrong side. Sew 1 edge of neckband to inside and 1 edge to outside of neckline. Work 1 row of single crochet around back opening. Make 4 loops on 1 side and sew 4 buttons to other side of opening. Work 2 rows of single crochet around lower edge.

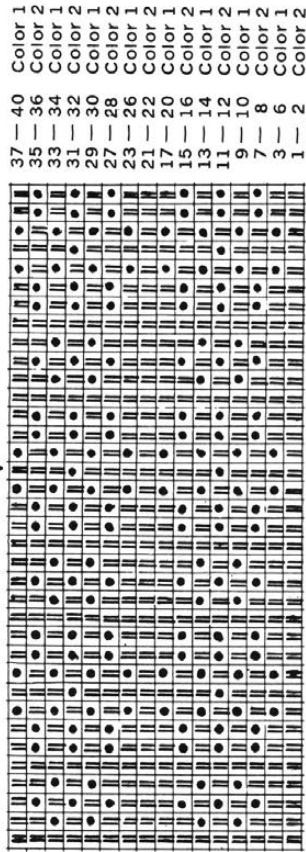

**SIZE 12** (Chest 30"-31"). **MATERIAL** 13-50gr. balls **KNITTING** Subita Crepe 2 x 3 and a 16" Jacket Type Zipper. **TENSION:** KNITTING 3 to 5. **Gauge:** Stockinette Stitch 18 sts. 2". 25 rows 2". **Pattern** Stitch 20 sts. 2". 28 rows 2". **PATTERN:** Pullover: Knit 1, Purl 3 Ribbing, (3 sts. on the main machine and 1 st. on the ribber) worn on the purl side: **COLLAR:** K1, P1, Ribbing; Vest: Stockinette Stitch; **EDGES:** K1, P1, Ribbing. **SLEEVE INCREASES:** ON EACH SIDE, after rows indicated, place the end st. from the row below onto the next empty needle. When working the Pullover Neck Shaping, transfer the appropriate ribber sts. to the main machine before putting the needles into holding position. Bind off the ribbed sections the crochet method for ribbing.

**FINISHING:** **PULLOVER:** Join front and back section at sides and shoulders. Sew sleeves together and set in. Join short ends of collar, then sew 1 edge of collar to inside and 1 edge to outside of neckline. **VEST:** Join front and back sections at sides and shoulders. Turn under 7 sts. on front edges and 4 sts. around armhole edges and hem to wrong side. Turn under 15 rows on lower edge and hem to wrong side. Join neckband sections at center back, then sew band to neckline. Sew in the zipper. Sew pockets in place.

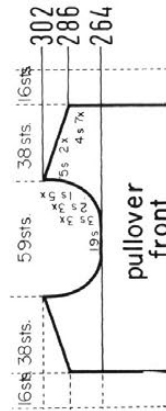
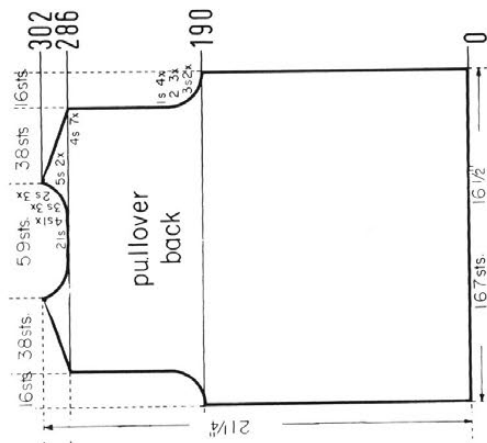

Bring the needles on the left side into working position, knit 1 row in PAT-TERN to the left side, turn the Row Counter back to 286 and complete the left half. Follow the instructions from \*.

\*ON CAM BOX SIDE, bind off 4 sts. after Rows 286 (EVEN ROWS = SHOULDER SHAPING), 287 (ODD ROWS = NECK SHAPING), 288; 3 sts. after Row 289; 4 sts. after Row 290; 3 sts. after Row 291; 4 sts. after Row 292; 3 sts. after Row 293; 4 sts. after Row 294; 2 sts. after Row 295; 4 sts. after Row 296; 2 sts. after Row 297; 4 sts. after Row 298; 2 sts. after Row 299; 5 sts. after Rows 300, 302.

ON CAM BOX SIDE, bind off 3 sts. after Rows 190, 191, 192, 193; 2 sts. after Rows 194, 195, 196, 197, 198, 199; 1 st. after Rows 200, 201, 202, 203, 204, 205, 206, 207, then knit to Row 286, bind off the center 21 sts., put the needles on the left side into holding position and complete the right half first. (For the Front Section knit to Row 264).

ROWS 0 to 190: Knit even.  
Cast on 167 sts. and work Knit 1, Purl 3, Ribbing.

Bring the needles on the left side into working position, knit 1 row in PAT-TERN to the left side, turn the Row Counter back to 264 and complete the left half. Follow the instructions from \*.

\*ON CAM BOX SIDE, bind off 3 sts. after Rows 265, 267, 269; 2 sts. after Rows 271, 273, 275; 1 st. after Rows 277, 279, 281, 283, 285. For SHOULDER bind off 4 sts. after Rows 286, 288, 290, 292, 294, 296, 298; 5 sts. after Rows 300, 302.

Work the front section the same as the back section to Row 264, then bind off the center 19 sts., put the needles on the left side into holding position and complete the right half first.

ON CAM BOX SIDE, bind off 4 sts. after Rows 190, 191, 192, 193; 3 sts. after Rows 194, 195, 196, 197; 2 sts. after Rows 198, 199, 200, 201. ON EACH SIDE, hang the 1st st. onto the 2nd st. after Rows 202, 204, 206, 208, 210, 212, 214, 216, 218, 220, 222, 224, 226, 228, 230. ON CAM BOX SIDE, bind off 2 sts. after Rows 232, 233, 234, 235; 3 sts. after Rows 236, 237; 4 sts. after Rows 238, 239; 14 sts. after Row 240.

ON EACH SIDE, increase 1 st. after Rows 26, 34, 42, 50, 58, 66, 74, 82, 90, 98, 106, 112, 118, 124, 130, 136, 142, 148, 154, 160, 166, 172, 178, 184, then knit to Row 190.

ROWS 0 to 26: Knit even.

Cast on 54 sts. with Color 2 and work stockinette st.

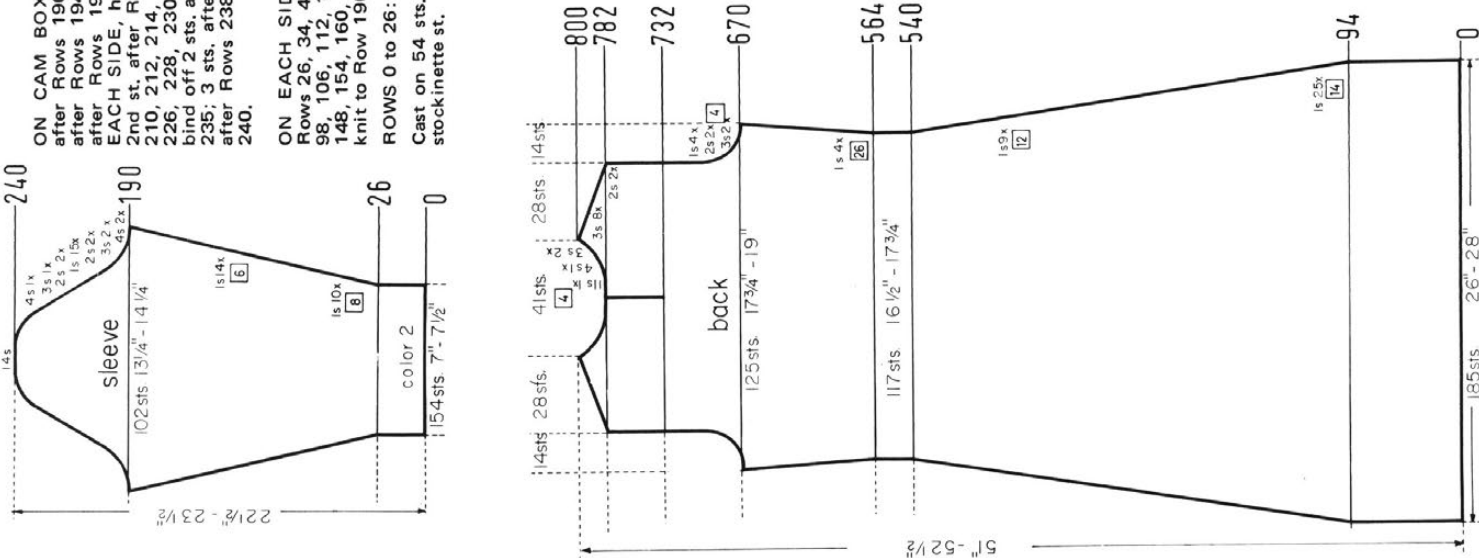

Bring the needles on the left side into working position, knit 1 row in PAT-TERN to the left side, turn the Row Counter back to 732 and complete the left half. Follow the instructions from \*.

ON CAM BOX SIDE, bind off 2 sts. after Row 782 (EVEN ROWS = SHOULDER SHAPING); 11 sts. (10 sts. for the left half) after Row 783 (ODD ROWS = NECK SHAPING); 2 sts. after Row 784; 3 sts. after Row 786; 4 sts. after Row 787; 3 sts. after Rows 788, 790, 791, 792, 794, 795, 796, 798, 800.

\*ROWS 733 to 782: Knit even.

ON CAM BOX SIDE, bind off 3 sts. after Rows 670, 671, 674, 675; 2 sts. after Rows 678, 679, 682, 683; 1 st. after Rows 686, 687, 690, 691, 694, 695, 698, 699, then knit to Row 732, put 48 needles on the left side into holding position and complete the right half first. (For the Front Section knit to Row 750 after completion of the Armhole Shaping).

ON EACH SIDE, increase 1 st. after Rows 564, 590, 616, 642, then knit to Row 670.

ON EACH SIDE, decrease 1 st. after Rows 94, 108, 122, 136, 150, 164, 178, 192, 206, 220, 234, 248, 262, 276, 290, 304, 318, 332, 346, 360, 374, 388, 402, 416, 430, 444, 456, 468, 480, 492, 504, 516, 528, 540, then knit to Row 564.

ROWS 0 to 94: Knit even.

Cast on 185 sts. with Color 2 and work the Holding Position Design.



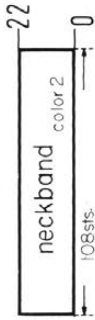

Cast on 108 sts. with Color 2 and work 22 rows stockinette st., then bind off all sts.

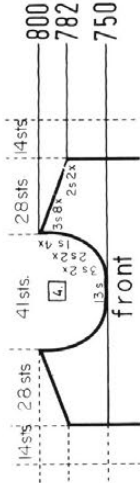

Bring the needles on the left side into working position, knit 1 row in PAT-TERN to the left side, turn the Row Counter back to 750 and complete the left half. Follow the instructions from\*.

\*ON CAM BOX SIDE, bind off 3 sts. after Rows 753, 757; 2 sts. after Rows 761, 765; 1 st. after Rows 769, 773, 777, 781. For SHOULDER bind off 2 sts. after Rows 782, 784; 3 sts. after Rows 786, 788, 790, 792, 794, 796, 798, 800.

Work the front section the same as the back section to Row 750, then bind off the center 13 sts., put the needles on the left side into holding position and complete the right half first.

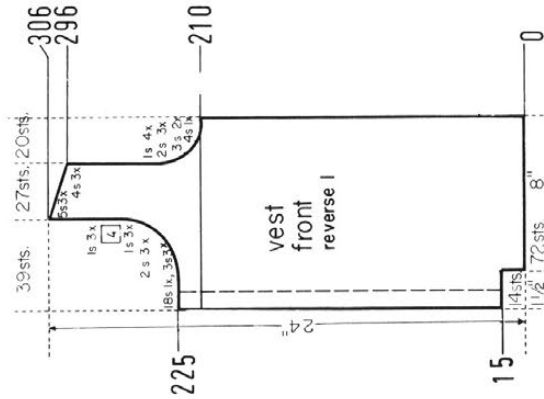

Work the second front section with reverse shapings, casting on from right to left. (Cam Box will be on the LEFT side at Row 0).

ON CAM BOX SIDE, bind off 4 sts. after Row 210 (EVEN ROWS = ARM-HOLE SHAPING); 3 sts. after Rows 212, 214; 2 sts. after Rows 216, 218, 220; 1 st. after Rows 222, 224; 18 sts. after Row 225 (ODD ROWS = NECK SHAPING); 1 st. after Row 226; 3 sts. after Row 227; 1 st. after Row 228; 3 sts. after Rows 229, 231; 2 sts. after Rows 233, 235, 237; 1 st. after Rows 239, 241, 243, 245, 249, 253 then knit to Row 296. For SHOULDER bind off 4 sts. after Rows 296, 298, 300; 5 sts. after Rows 302, 304, 306.

ROWS 16 to 210: Knit even.  
ROWS 0 to 15: Knit even, then cast on 14 sts. ON CAM BOX SIDE.  
Cast on 72 sts. and work stockinette st.

ON CAM BOX SIDE, bind off 3 sts. after Rows 224, 225, 226, 227, 228, 229; 2 sts. after Rows 230, 231, 232, 233, 234, 235, 236, 237. ON EACH SIDE hang the 1st st. onto the 2nd st. after Rows 238, 240, 242, 244, 246, 248, 250, 252, 254, 256, 258, 260, 262, 264, 266, 268, 270, 272, 274, 276, 278. ON CAM BOX SIDE, bind off 2 sts. after Rows 280, 281, 282, 283, 284, 285, 286, 287; 3 sts. after Rows 288, 289, 290, 291; 13 sts. after Row 292.

ON EACH SIDE, increase 1 st. after Rows 8, 20, 32, 44, 56, 68, 80, 92, 104, 116, 128, 140, 152, 164, 176, 188, 200, 212, then knit to Row 224.  
ROWS 0 to 8: Knit even.  
Cast on 81 sts. and work Knit 1, Purl 3, Ribbing.

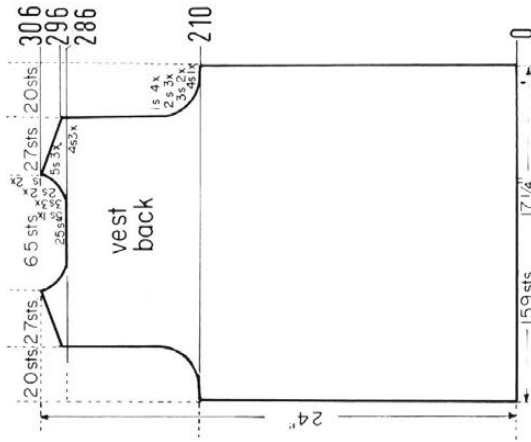

Move the Cam Box to the left side, turn the Row Counter back to 286 and complete the left half. Follow the instructions from\*.

\*ON CAM BOX SIDE, bind off 5 sts. after Row 287 (ODD ROWS = NECK SHAPING); 3 sts. after Rows 289, 291, 293; 2 sts. after Row 295; 4 sts. after Row 296 (EVEN ROWS = SHOULDER SHAPING); 2 sts. after Row 297; 4 sts. after Row 298; 1 st. after Row 299; 4 sts. after Row 300; 1 st. after Row 301; 5 sts. after Rows 302, 304, 306.

ON CAM BOX SIDE, bind off 4 sts. after Rows 210, 211; 3 sts. after Rows 212, 213, 214, 215; 2 sts. after Rows 216, 217, 218, 219, 220, 221; 1 st. after Rows 222, 223, 224, 225, 226, 227, 228, 229, then knit to Row 286, bind off the center 25 sts., put the needles on the left side into holding position and complete the right half first.  
ROWS 0 to 210: Knit even.

Cast on 159 sts. and work stockinette st.

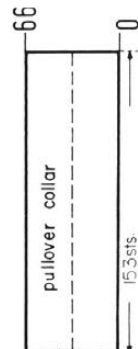
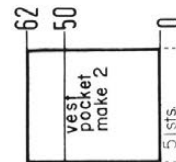
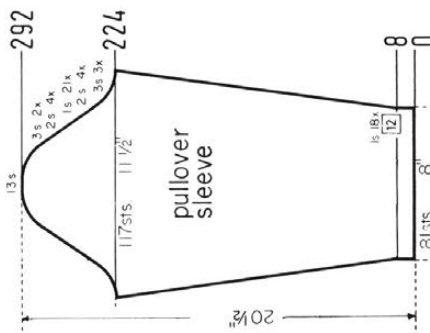

Cast on 153 sts. and work 66 rows K1, P1, Ribbing, then bind off all sts.

Cast on 115 sts. and work 12 rows K1, P1, Ribbing, then bind off all sts.

# jac40 is a must

for fast easy knitting of  
Jaquard and Ski-sweater  
designs

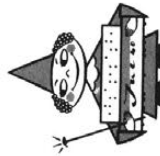
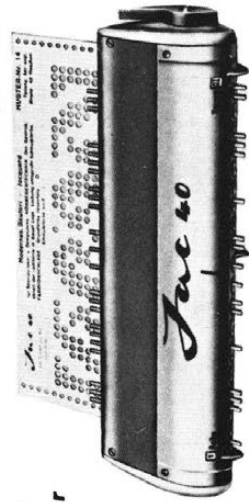

# HP 3640

**SIZE 36** (Chest 35"-36"), **SIZE 38** (Chest 37"-38"), **SIZE 40** (Chest 39"-40"). **SIZE 36:** MATERIAL: PULLOVER 7-50gr. balls Main Color and 2-50gr. balls Contrast Color; VEST 5-50gr. balls Main Color and 1-50gr. ball Contrast Color KNITTING Subita Dralon 3 ply and a 24" Jacket Type Zipper. **TENSION:** 4 to 6. **GAUGE:** 16 sts, 22 rows 2". **SIZE 38:** MATERIAL: PULLOVER 10-50gr. balls Main Color and 2-50gr. balls Contrast Color; VEST 7-50gr. balls Main Color and 1-50gr. ball Contrast Color KNITTING Subita Crepe 2 x 4 and a 25" Jacket Type Zipper. **TENSION:** 5 to 7. **GAUGE:** 15 sts, 21 rows 2". **SIZE 40:** MATERIAL: PULLOVER 9-50gr. balls Main Color and 2-50gr. balls Contrast Color; VEST 6-50gr. balls Main Color and 1-50gr. ball Contrast Color KNITTING Sonika Dralon and a 26" Jacket Type Zipper. **TENSION:** 7 to 9. **GAUGE:** 14 sts, 20 rows 2". The instructions are the same for all sizes. **PATTERN:** Stockinette Stitch and a Norwegian Design Border according to Line Drawing, or use JAC 40 and Pattern No. 439. **EDGES:** K1, P1, Ribbing. In the instructions, each row in the Norwegian Design is counted as 1 row, but several movements of the Cam Box are needed to complete 1 row. **INCREASES:** After rows indicated, move the end st. on each side 1 needle outward, then place the 2nd st. from the row below onto the empty needle.

**FINISHING:** PULLOVER: Join front and back section at sides and shoulders. Sew sleeves together and set in. Join short end of collar, then sew 1 edge of collar to inside and 1 edge to outside of neckline. VEST: Join back and front sections at sides and shoulders. Join short ends of armhole bands. Turn under 6 sts. on front edges and hem to wrong side. Sew 1 edge of armhole band to inside and 1 edge to outside of armholes. Sew neckband to neckline in the same manner. Sew in the zipper.

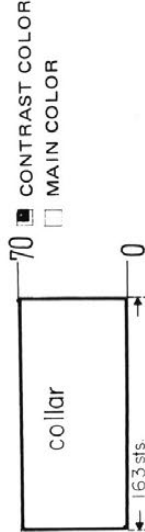
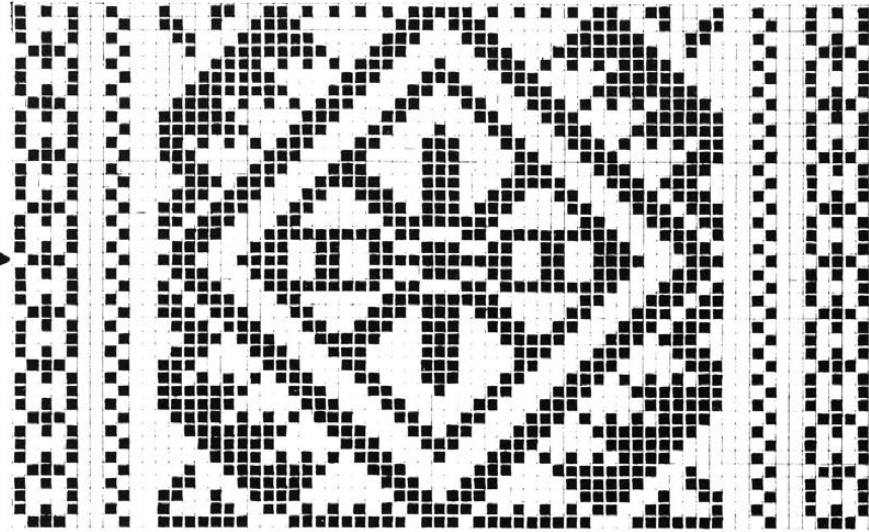
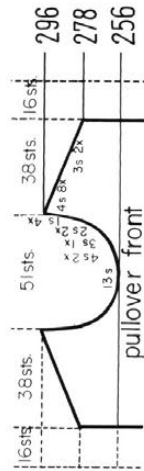

Cast on 163 sts. with main color and work 70 rows K1, P1, Ribbing, then bind off all sts.

Move the Cam Box to the left side, turn the Row Counter back to 256 and complete the left half. Follow the instructions from\*.

\*ON CAM BOX SIDE, bind off 4 sts. after Rows 257, 259; 3 sts. after Row 261; 2 sts. after Rows 263, 265; 1 st. after Rows 267, 269, 271, 273. For SHOULDER bind off 3 sts. after Rows 278, 280; 4 sts. after Rows 282, 284, 286, 288, 290, 292, 294, 296.

Work the front section the same as the back section to ROW 256, then bind off the center 13 sts., put the needles on the left side into holding position and complete the right half first.

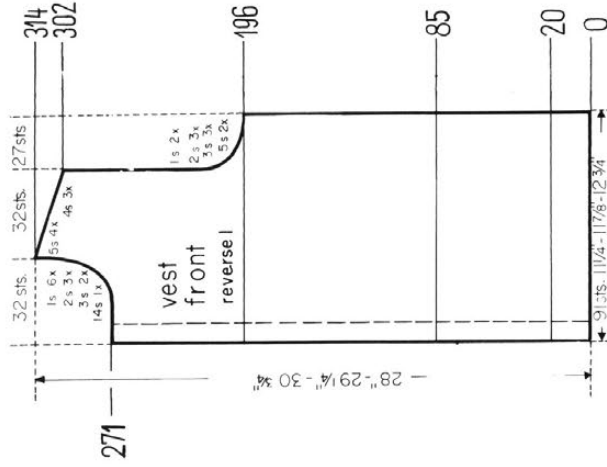

Work the second front section with reverse shapings, casting on from right to left. (Cam Box will be on the LEFT side at Row 0).

ON CAM BOX SIDE, bind off 14 sts. after Row 271; 3 sts. after Rows 273, 275; 2 sts. after Rows 277, 279, 281; 1 st. after Rows 283, 285, 287, 289, 291, 293. For SHOULDER bind off 4 sts. after Rows 302, 304, 306; 5 sts. after Rows 308, 310, 312, 314.

ON CAM BOX SIDE, bind off 5 sts. after Rows 196, 198; 3 sts. after Rows 200, 202, 204; 2 sts. after Rows 206, 208, 210; 1 st. after Rows 212, 214, then knit to Row 271.

ROWS 86 to 196: Knit even.

ROWS 21 to 85: Knit even, then continue with stockinette st.

ROWS 0 to 20: Knit even, then transfer the ribber sts. to the main machine and work the Norwegian Design.

Cast on 91 sts. with main color and work K1, P1, Ribbing.

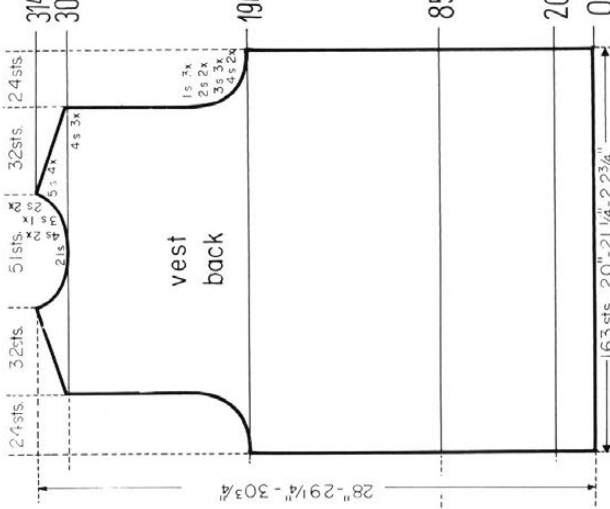

Move the Cam Box to the left side, turn the Row Counter back to 302 and complete the left half. Follow the instructions from\*.

\*ON CAM BOX SIDE, bind off 4 sts. after Rows 302 (EVEN ROWS = SHOULDER SHAPING), 303 (ODD ROWS = NECK SHAPING), 304, 305, 306; 3 sts. after Row 307; 5 sts. after Row 308; 2 sts. after Row 309; 5 sts. after Row 310; 2 sts. after Row 311; 5 sts. after Rows 312, 314.

ON CAM BOX SIDE, bind off 4 sts. after Rows 196, 197, 198, 199; 3 sts. after Rows 200, 201, 202, 203, 204, 205; 2 sts. after Rows 206, 207, 208, 209; 1 st. after Rows 210, 211, 212, 213, 214, 215, then knit to Row 302, bind off the center 21 sts., put the needles on the left side into holding position and complete the right half first.

ROWS 86 to 196: Knit even.

ROWS 21 to 85: Knit even, then continue with stockinette st.

ROWS 0 to 20: Knit even, then transfer the ribber sts. to the main machine and work the Norwegian Design.

Cast on 163 sts. with main color and work K1, P1, Ribbing.

Cast on 195 sts. with main color and work 20 rows K1, P1, Ribbing, then bind off all sts.

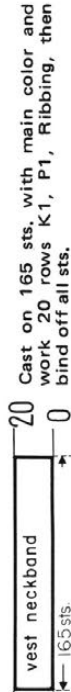

Cast on 165 sts. with main color and work 20 rows K1, P1, Ribbing, then bind off all sts.

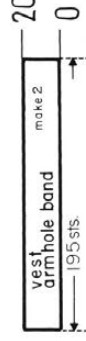

Cast on 195 sts. with main color and work 20 rows K1, P1, Ribbing, then bind off all sts.



Move the Cam Box to the left side, turn the Row Counter back to 282 and complete the left half. Follow the instructions from\*.

\*ON CAM BOX SIDE, bind off 4 sts, after Rows 282 (EVEN ROWS = SHOULDER SHAPING), 283 (ODD ROWS = NECK SHAPING), 284; 3 sts, after Row 285; 4 sts, after Row 286; 3 sts, after Row 287; 4 sts, after Row 288; 2 sts, after Row 289; 4 sts, after Row 290; 2 sts, after Row 291; 4 sts, after Row 292; 2 sts, after Row 293; 4 sts, after Row 294, 296.

ON CAM BOX SIDE, bind off 3 sts, after Rows 278, 279, 280, 281, then knit to Row 282, bind off the center 19 sts., put the needles on the left side into holding position and complete the right half first.

ON CAM BOX SIDE, bind off 3 sts, after Rows 188, 189, 190, 191; 2 sts, after Rows 192, 193, 194, 195; (CHANGE TO STOCKINETTE STITCH after Row 195) 2 sts, after Rows 196, 197; 1 st, after 198, 199, 200, 201, 202, 203, 204, 205, then knit to Row 278. (For the Front Section knit to Row 256).

ROWS 131 to 188: Knit even.

ROWS 21 to 130: Knit even, then work the Norwegian Design.

ROWS 0 to 20: Knit even, then change to stockinette st.

Cast on 159 sts, with main color and work K1, P1, Ribbing.

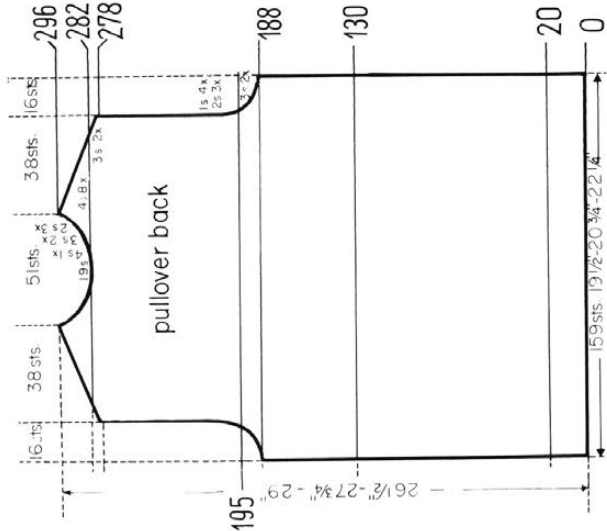

ON CAM BOX SIDE, bind off 4 sts, after Rows 206, 207; 3 sts, after Rows 208, 209, 210, 211, 212, 213; 2 sts, after Rows 214, 215, 216, 217, 218, 219; 1 st, after Rows 220, 221; 2 sts, after Rows 222, 223; 1 st, after Rows 224, 225; 2 sts, after Rows 226, 227; 1 st, after Rows 228, 229; 2 sts, after Rows 230, 231; 1 st, after Rows 232, 233; 2 sts, after Rows 234, 235; 1 st, after Rows 236, 237; 2 sts, after Rows 238, 239; 1 st, after Rows 240, 241; 2 sts, after Rows 242, 243; 1 st, after Rows 244, 245; 2 sts, after Rows 246, 247; 1 st, after Rows 248, 249; 2 sts, after Rows 250, 251; 1 st, after Rows 252, 253; 2 sts, after Rows 254, 255; 3 sts, after Rows 256, 257, 258, 259; 4 sts, after Rows 260, 261; 13 sts, after Row 262.

ON EACH SIDE, increase 1 st, after Rows 20, 28, 36, 44, 52, 60, 68, 76, 84, 92, 100, 108, 116, 124, 132. Knit to Row 140, begin the Norwegian Design and continue to increase 1 st. ON EACH SIDE after Rows 140, 146, 152, 158, 164, 170, 176, 182, 188, 194, 200. After Row 205 continue with stockinette st. and knit to Row 206.

ROWS 0 to 20: Knit even, then change to stockinette st.

Cast on 73 sts, with main color and work K1, P1, Ribbing.

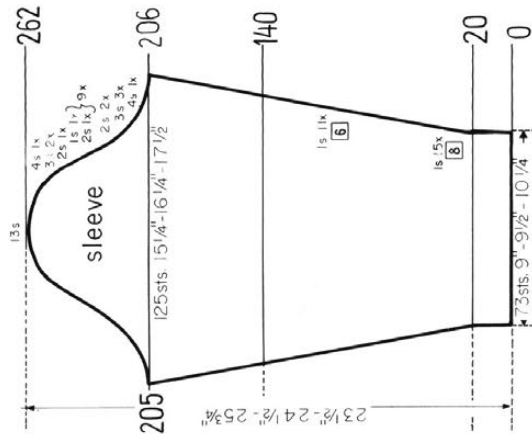

ON CAM BOX SIDE, bind off 4 sts, after Rows 206, 207; 3 sts, after Rows 208, 209, 210, 211, 212, 213; 2 sts, after Rows 214, 215, 216, 217, 218, 219; 1 st, after Rows 220, 221; 2 sts, after Rows 222, 223; 1 st, after Rows 224, 225; 2 sts, after Rows 226, 227; 1 st, after Rows 228, 229; 2 sts, after Rows 230, 231; 1 st, after Rows 232, 233; 2 sts, after Rows 234, 235; 1 st, after Rows 236, 237; 2 sts, after Rows 238, 239; 1 st, after Rows 240, 241; 2 sts, after Rows 242, 243; 1 st, after Rows 244, 245; 2 sts, after Rows 246, 247; 1 st, after Rows 248, 249; 2 sts, after Rows 250, 251; 1 st, after Rows 252, 253; 2 sts, after Rows 254, 255; 3 sts, after Rows 256, 257, 258, 259; 4 sts, after Rows 260, 261; 13 sts, after Row 262.

ON EACH SIDE, increase 1 st, after Rows 20, 28, 36, 44, 52, 60, 68, 76, 84, 92, 100, 108, 116, 124, 132. Knit to Row 140, begin the Norwegian Design and continue to increase 1 st. ON EACH SIDE after Rows 140, 146, 152, 158, 164, 170, 176, 182, 188, 194, 200. After Row 205 continue with stockinette st. and knit to Row 206.

ROWS 0 to 20: Knit even, then change to stockinette st.

Cast on 73 sts, with main color and work K1, P1, Ribbing.

# HP 3642

SIZE 38 (Chest 37"-38"), SIZE 40 (Chest 39"-40"), SIZE 42 (Chest 41"-42"). SIZE 38: MATERIAL: 8-50gr. balls Color 1 and 6-50gr. balls Color 2 KNITTING Crocus Crepe. TENSION: 5 to 7. GAUGE: 16 sts, 2", 21 rows 2". SIZE 40: MATERIAL: 8-50gr. balls Color 1 and 6-50gr. balls Color 2 KNITTING Subita Crepe 2 x 4. TENSION: 6 to 8. GAUGE: 15 sts, 2", 20 rows 2". SIZE 42: MATERIAL: 11-50gr. balls Color 1 and 9-50gr. balls Color 2 KNITTING Lovely. TENSION: 7 to 9. GAUGE: 14 sts, 2", 20 rows 2". The instructions are the same for all sizes. PATTERN: Norwegian Design according to Line Drawing, or use JAC 40 and Pattern No. 381. In the instructions, each row in the Norwegian Design is counted as 1 row, but several movements of the Cam Box are needed to complete 1 row. EDGES: K1, P1, Ribbing. INCREASES: On each side after Rows indicated, place the end st. from the row below onto the next empty needle.

FINISHING: Join front and back section at sides and shoulders. Sew sleeves together and set in. Join short ends of collar, then sew 1 edge of collar to inside and 1 edge to outside of neckline.

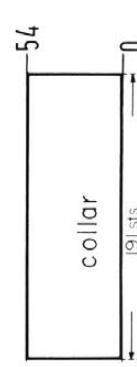

Cast on 191 sts, with Color 1 and work 54 rows K1, P1, Ribbing, then bind off all sts.

Bring the needles on the left side into working position, knit 1 row in PATTERN to the left side, turn the Row Counter back to 248 and complete the left half. Follow the instructions from\*.

\*ON CAM BOX SIDE, bind off 4 sts, after Row 249; 3 sts, after Rows 251, 253; 2 sts, after Rows 255, 257; 1 st, after Rows 259, 261, 263, 265. For SHOULDER bind off 5 sts, after Rows 266, 268, 270, 272, 274, 276; 6 sts, after Rows 278, 280.

Work the front section the same as the back section to Row 248, then bind off the center 13 sts., put the needles on the left side into holding position and complete the right half first.

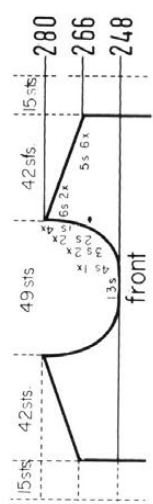

(Continued on next page)

SIZE: 10-12 (Chest 28"-30"). MATERIAL: 8-50gr. balls KNITTING Double Knitting and a 20" Jacket Type Zipper. TENSION: KNITTING 9 to 10. GAGUE: 13 sts, 2", 17 rows 2". PAT-TERN: Stockinette Stitch and a Cable Design on the front sections. EDGES: K1, P1, Ribbing. Follow the Line Drawing for the Cable Design. INCREASES: After rows indicated, move the 2 end sts. on each side 1 needle outward, then place the 3rd st. from the row below onto the empty needle. FINISHING: Join front and back sections at sides and shoulders. Sew sleeves together and set in. Turn under 5 sts. on front edges and hem to wrong side. Sew collar to neckline. Sew in the zipper. Sew pocket flaps in place (See picture).

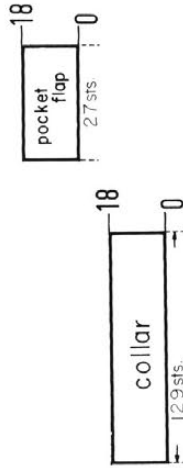
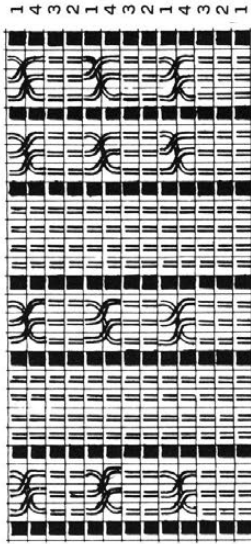
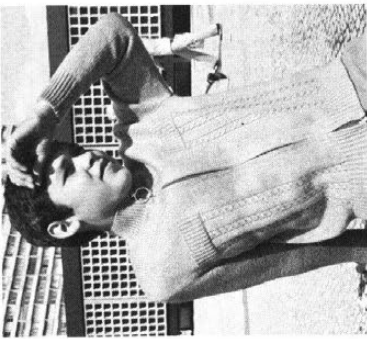

Cast on 129 sts. and work 18 rows K1, P1, Ribbing, then bind off all sts.

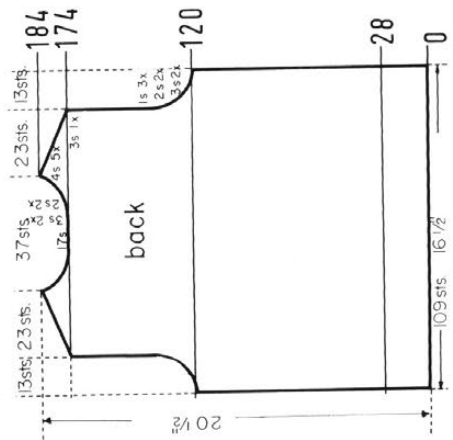

Move the Cam Box to the left side, turn the Row Counter back to 174 and complete the left half. Follow the instructions from\*.

\*ON CAM BOX SIDE, bind off 3 sts. after Row 174 (EVEN ROWS = SHOULDER SHAPING); 175 (ODD ROWS = NECK SHAPING); 4 sts. after Row 176; 3 sts. after Row 177; 4 sts. after Row 178; 2 sts. after Row 179; 4 sts. after Row 180; 2 sts. after Row 181; 4 sts. after Rows 182, 184.

ON CAM BOX SIDE, bind off 3 sts. after Rows 120, 121, 122, 123; 2 sts. after Rows 124, 125, 126, 127; 1 st. after Rows 128, 129, 130, 131, 132, 133, then knit to Row 174, bind off the center 17 sts., put the needles on the left side into holding position and complete the right half first.

ROWS 29 to 120: Knit even.

ROWS 0 to 28: Knit even, then change to stockinette st.

Cast on 109 sts. and work K1, P1, Ribbing.

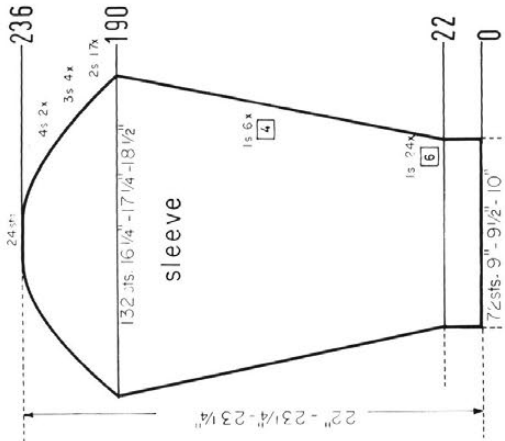

ON CAM BOX SIDE, bind off 2 sts. after Rows 190, 191, 192, 193, 194, 195, 196, 197, 198, 199, 200, 201, 202, 203, 204, 205, 206, 207, 208, 209, 210, 211, 212, 213, 214, 215, 216, 217, 218, 219, 220, 221, 222, 223; 3 sts. after Rows 224, 225, 226, 227, 228, 229, 230, 231; 4 sts. after Row 232, 233, 234, 235; 24 sts. after Row 236.

ON EACH SIDE, increase 1 st. after Rows 22, 28, 34, 40, 46, 52, 58, 64, 70, 76, 82, 88, 94, 100, 106, 112, 118, 124, 130, 136, 142, 148, 154, 160, 166, 170, 174, 178, 182, 186, then knit to Row 190.

ROWS 0 to 22: Knit even, then transfer the ribber sts. to the main machine and work the Norwegian Design.

Cast on 72 sts. with Color 1 and work K1, P1, Ribbing.

Bring the needles on the left side into working position, knit 1 row in PAT-TERN to the left side, turn the Row Counter back to 266 and complete the left half. Follow the instructions from\*.

\*ON CAM BOX SIDE, bind off 5 sts. after Row 266 (EVEN ROWS = SHOULDER SHAPING); 3 sts. after Row 267 (ODD ROWS = NECK SHAPING); 5 sts. after Row 268; 3 sts. after Row 269; 5 sts. after Row 270; 3 sts. after Row 271; 5 sts. after Row 272; 3 sts. after Row 273; 5 sts. after Row 274; 2 sts. after Row 275; 5 sts. after Row 276; 2 sts. after Row 277; 6 sts. after Rows 278, 280.

ON CAM BOX SIDE, bind off 2 sts. after Rows 170, 171, 172, 173, 174, 175, 176, 177, 178, 179, 180, 181; 1 st. after Rows 182, 183, 184, 185, 186, 187, then knit to Row 266, bind off the center 17 sts., put the needles on the left side into holding position and complete the right half first. (For the Front Section knit to Row 248).

ROWS 23 to 170: Knit even.

ROWS 0 to 22: Knit even, then transfer the ribber sts. to the main machine and work the Norwegian Design.

Cast on 163 sts. with Color 1 and work K1, P1, Ribbing.

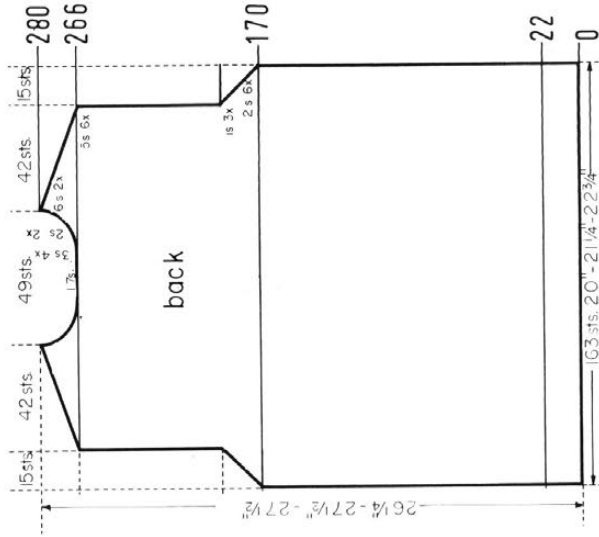



# MK 5294

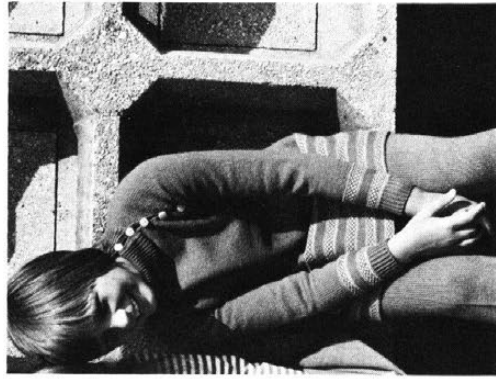

**SIZE** 10-12 (Chest 28½"-30"). **MATERIAL:** DRESS 6-50gr. balls Color 1 and 1-50gr. ball Color 2; PANTS 6-50gr. balls KNITTING Amore, TEN-  
**SION: KNITTING** 7 to 9. **GAUGE:** Stockinette  
Stitch 14 sts. 2", 21 rows 2". **PATTERN:** Pants, upper portion  
2", 25 rows 2". **FINISHING:** Dress, upper portion  
of the Dress and Sleeves; Stockinette Stitch, worn  
on the knit side; lower portion of the Dress and  
Sleeves; Weaving Design according to Line Draw-  
ing. The Purl side is the right side. **KNITTING**  
AM3 use the Weaving Attachment and Wheel 6.  
Collar and Sleeve Edges: K1, P1, Ribbing. After  
the Weaving Design is completed, the knitting has  
to be turned. Knit several rows with contrast waste  
yarn, then remove the knitting from the machine,  
turn over and hang the garment sts. back onto the  
machine. Remove the contrast waste yarn and turn  
the Row Counter back. **DECREASES:** After rows  
indicated, hang the 3rd st. on the appropriate sides  
onto the 2nd st., then move the end sts. inward to  
fill the empty needle. **INCREASES:** After rows in-  
dicated, move the 2 end sts. on the appropriate  
sides 1 needle outward, then place the 3rd st. from  
the row below onto the empty needle.

**FINISHING:** DRESS: Join front and back section  
at sides. Sew the sleeves together, then weave the  
sleeves to front and back section, 1 st. in from each  
edge, leaving 4" on the upper left front open. Sew  
1 edge of collar to inside and 1 edge to outside of  
neckline. Work 1 row of single crochet around the  
opening and short ends of collar. Make 5 loops on  
1 side and sew 5 buttons to other side of opening.  
(See picture). Turn under 2" on lower edge and  
hem to wrong side. **PANTS:** Join sections at center  
back and center front. Sew leg seams together.  
Turn under 12 rows on leg edges and 12 rows on  
upper edge and hem to wrong side. Insert an elastic  
band into upper hem.

Cast on 135 sts. and work 50 rows K1,  
P1, Ribbing, then bind off all sts.

ON EACH SIDE, decrease 1 st. after  
Rows 216, 218, 220, 222, 224, 226,  
228, 230, 232, 234, 236, 238, 240, 242,  
244, 246, 248, 250, 252, 254, 256, 258,  
260, 262, 264, 266, 268, 270, 272, 274,  
(For the FRONT SECTION make the  
decreases after Row 274, then knit to  
Row 276) 276, 278, 280, 282, 284, 286,  
288, 290, 292, 294, 296, 298, then knit  
to Row 300 and bind off the remaining  
31 sts.

Continue to decrease 1 st. ON EACH  
SIDE after Rows 118, 132, 146, 160,  
174, 188, 202, then knit to Row 216.

ON EACH SIDE, decrease 1 st. after  
Rows 58, 74, 90, 104, then knit to Row  
110, turn the knitting and continue with  
stockinette st. (Row Counter at 110).

ROWS 23 to 58: Knit even.

ROWS 0 to 22: Knit even, then work the  
Weaving Design.

Cast on 137 sts. with Color 1 and work  
stockinette st.

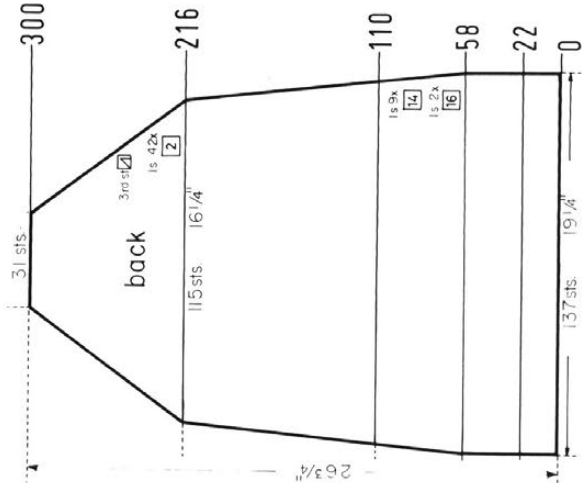
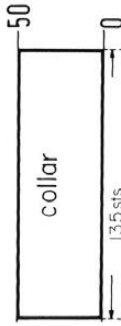

Work the second front section with re-  
verse shapings, casting on from right to  
left. (Cam Box will be on the LEFT side  
at Row 0).

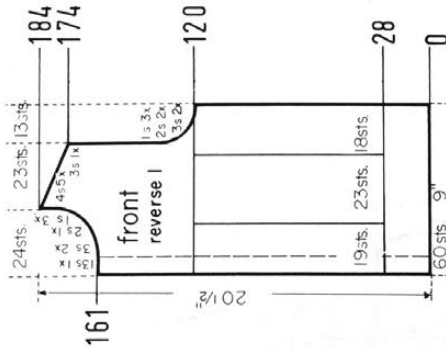

ON CAM BOX SIDE, bind off 3 sts.  
after Rows 126, 127, 128, 129; 2 sts.  
after Rows 130, 131, 132, 133, 134,  
135; 1 st. after Rows 136, 137, 138,  
139; 2 sts. after Rows 140, 141; 1 st.  
after Rows 142, 143, 144, 145; 2 sts.  
after Rows 146, 147; 1 st. after Rows  
148, 149, 150, 151; 2 sts. after Rows  
152, 153; 1 st. after Rows 154, 155,  
156, 157; 2 sts. after Rows 158, 159,  
160, 161; 3 sts. after Rows 162, 163; 10  
sts. after Row 164.

ON EACH SIDE, increase 1 st. after  
Rows 28, 36, 44, 52, 60, 68, 76, 84, 92,  
100, 108, 116, then knit to Row 126.

ROWS 0 to 28: Knit even, then change  
to stockinette st.

Cast on 52 sts. and work K1, P1,  
Ribbing.

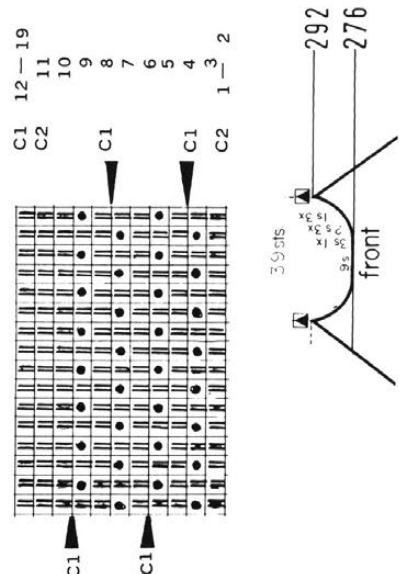
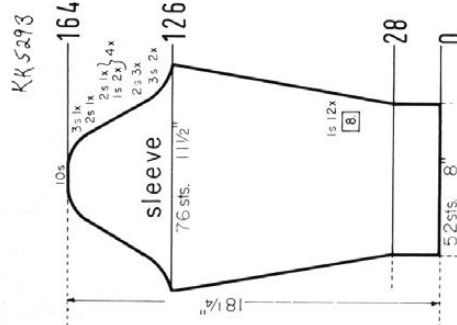

Move the Cam Box to the left side, turn  
the Row Counter back to 276 and com-  
plete the left half. Follow the instruc-  
tions from\*.

\*Continue to decrease 1 st. for RAG-  
LAN after Row 276, then again after  
Rows in ( ). ON NECK SIDE, bind off 3  
sts. after Row 277; (278), 2 sts. after  
Rows 279, (280), 281, (282), 283;  
(284), 1 st. after Rows 285, (286), 287,  
(288), 289, (290), then knit to Row 292  
and bind off the remaining 3 sts.

Work the front section the same as the  
back section to Row 276, then bind off  
the center 9 sts., put the needles on the  
left side into holding position and com-  
plete the right half first.

**SIZE** 8-10 (Chest 27"-28"). **MATERIAL:** 6-50gr. balls Color 1 and 3-50gr. balls Color 2 **KNITTING** Amore. **TENSION:** KNITTING 6 to 8. **GAUGE:** 16 sts, 2", 25 rows 2". **PATTERN:** Stockinette Stitch and Color Stripes as marked in the Diagrams. **COLLAR and SLEEVE EDGES:** K1, P1, Ribbing. **DECREASES:** After rows indicated, hang the 3rd st. on each side onto the 2nd st., then move the end sts. inward to fill the empty needle. Begin the DART decreases by hanging the sts. together as marked on the diagram, then move the end sts. inward to fill the empty needles. The following dart decreases lie directly above. **INCREASES:** After rows indicated, move the 2 end sts. on each side 1 needle outward, then place the 3rd st. from the row below onto the empty needle.

**FINISHING:** DRESS: Join front and back section at sides and shoulders; Sew sleeves together and set in. Join short ends of collar, then sew 1 edge of collar to inside and 1 edge to outside of neckline. Turn under 2" on lower edge and hem to wrong side. **LEOTITES:** Join sections at center back and center front. Sew leg seams together. Weave the open sts. together. Join sole to instep at sides and sew gusset in place. Turn under 10 rows on upper edge and hem to wrong side. Insert an elastic band.

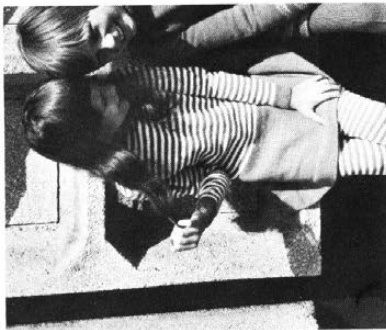
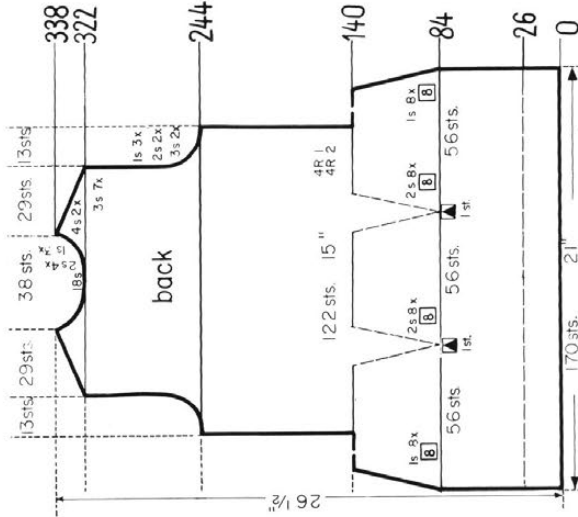
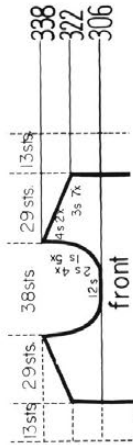

Move the Cam Box to the left side, turn the Row Counter back to 306 and complete the left half. Follow the instructions from\*.

\*ON CAM BOX SIDE, bind off 2 sts. after Rows 307, 309, 311, 313 (ODD ROWS = NECK SHAPING); 1 st. after Rows 315, 317, 319, 321; 3 sts. after Row 322 (EVEN ROWS = SHOULDER SHAPING); 1 st. after Row 323; 3 sts. after Rows 324, 326, 328, 330, 332, 334; 4 sts. after Rows 336, 338.

Work the front section the same as the back section to Row 306, then bind off the center 12 sts., put the needles on the left side into holding position and complete the right half first.

Move the Cam Box to the left side, turn the Row Counter back to 322 and complete the left half. Follow the instructions from\*.

\*ON CAM BOX SIDE, bind off 3 sts. after Row 322 (EVEN ROWS = SHOULDER SHAPING); 2 sts. after Row 323 (ODD ROWS = NECK SHAPING); 3 sts. after Row 324; 2 sts. after Row 325; 3 sts. after Row 326; 2 sts. after Row 327; 3 sts. after Row 328; 2 sts. after Row 329; 3 sts. after Row 330; 1 st. after Row 331; 3 sts. after Row 332; 1 st. after Row 333; 3 sts. after Row 334; 1 st. after Row 335; 4 sts. after Rows 336, 338.

ON CAM BOX SIDE, bind off 3 sts. after Rows 244, 245, 246, 247; 2 sts. after Rows 248, 249, 250, 251; 1 st. after Rows 252, 253, 254, 255, 256, 257, then knit to Row 322, bind off the center 16 sts., put the needles on the left side into holding position and complete the right half first. (For the Front Section knit to Row 306).

ROWS 141 to 244: Knit even.

Decrease 1 st. ON EACH SIDE and 2 sts. for EACH DART after Rows 84, 92, 100, 108, 116, 124, 132, 140. AT THE SAME TIME, change to Color 2 after Row 140 and work the repeated color stripes as marked in the diagram.

ROWS 0 to 84: Knit even.

Cast on 170 sts. with Color 1 and work stockinette st.

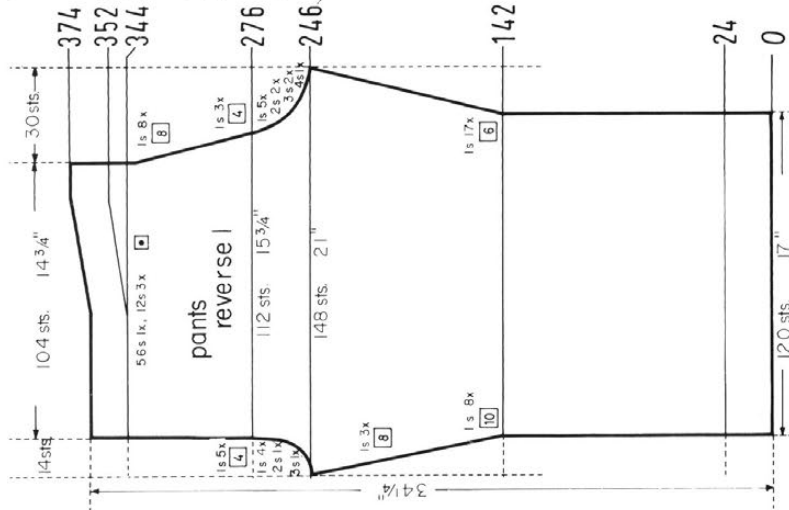

Work the second section with reverse shapings, casting on from right to left. (Cam Box will be on the LEFT side at Row 0).

ON CAM BOX SIDE, bind off 4 sts. after Row 246 (EVEN ROWS = CENTER BACK); 3 sts. after Rows 247 (ODD ROWS = CENTER FRONT); 248; 2 sts. after Row 249; 3 sts. after Row 250; 1 st. after Row 251; 2 sts. after Row 252; 1 st. after Row 253; 2 sts. after Row 254; 1 st. after Rows 255, 256, 257, 258, 259, 260, 262, 263, 264, 265, 266, 267, 270, 271, 274, 275, 278, 285, 294, 302, 310, 318, 326, 334, then knit to Row 344 and work Short Rows. ON OPPOSITE SIDE of CAM BOX put into holding position 56 needles after Row 344; 12 needles after Rows 346, 348, 350. After Row 352 bring all needles back into working position, then knit to Row 376 and bind off the remaining 104 sts.

ON OPPOSITE SIDE of CAM BOX, increase 1 st. after Rows in ( ). ON CAM BOX SIDE, increase 1 st. after Rows 142, (142), 148, (152), 154, 160, (162), 166, 172, (172), 178, (182), 184, 190, (192), 196, 202, (202), 208, (212), 214, 220, (222), 226, (230), 232, 238, (238), then knit to Row 246.

ROWS 0 to 142: Knit even.

Cast on 120 sts. and work stockinette st.

Work the second sleeve with reverse shaping. After turning the knitting, have the Cam Box on the LEFT side at Row 52.

ON EACH SIDE, decrease 1 st. after Rows 166, 170, 174, 178, 182, 186, 188, 190, 192, 194, 196, 198, 200, 202, 204, 206, 208, 210, 212, 214, 216, 218, 220, 222, 224, 226, 228, 230, 232, 234, 236, 238, 240, then knit to Row 242 and continue to decrease 1 st. ON CAM BOX SIDE after Rows in ( ). Work Short Rows. ON OPPOSITE SIDE of CAM BOX put into holding position 3 needles after Rows 242, (242), 244, (244), 246; (246), 2 needles after Row 248; (248). After Row 250 bring all needles back into working position, then bind off the remaining 14 sts.

Continue to increase 1 st. ON EACH SIDE after Rows 52, 62, 72, 82, 92, 102, 112, 122, 132, 142, 150, 158, then knit to Row 166.

ON EACH SIDE, increase 1 st. after Rows 22, 32, 42, then knit to Row 52, turn the knitting and continue with stockinette st.

ROWS 0 to 22: Knit even, then transfer the ribber sts. to the main machine and work the Weaving Design.

Cast on 54 sts. with Color 1 and work K1, P1, Ribbing.



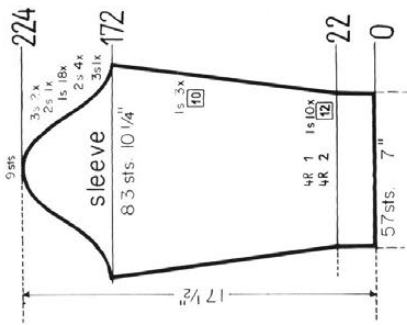

ON CAM BOX SIDE, bind off 3 sts. after Rows 172, 173; 2 sts. after Rows 174, 175, 176, 177, 178, 179, 180, 181. ON EACH SIDE, hang the 1st st. onto the 2nd st. after Rows 182, 184, 186, 188, 190, 192, 194, 196, 198, 200, 202, 204, 206, 208, 210, 212, 214, 216. ON CAM BOX SIDE, bind off 2 sts. after Rows 218, 219; 3 sts. after Rows 220, 221, 222, 223; 9 sts. after Row 224.

ON EACH SIDE, increase 1 st. after Rows 22, 34, 46, 58, 70, 82, 94, 106, 118, 130, 142, 152, 162, then knit to Row 172.

ROWS 0 to 22: Knit even, then change to stockinette st. and work the color stripes as marked in the diagram.

Cast on 57 sts. with Color 1 and work K1, P1, Ribbing.

Work the second section with reverse shapings, casting on from right to left. (Cam Box will be on the LEFT side at Row 0).

Work Short Rows. ON OPPOSITE SIDE of CAM BOX, put into holding position 1 needle after Rows 608, 609, 610, 611, 612, 613, 614, 615, 616, 617; 2 needles after Rows 618, 619, 620, 621, then bring back into working position 2 needles after Rows 622, 623, 624, 625; 1 needle after Rows 626, 627, 628, 629, 630, 631, 632, 633, 634, 635. Knit to Row 648, then put the 27 sts. onto a stitch holder.

ON EACH SIDE, increase 1 st. after Rows 586, 590, 594, 598, 602, then knit to Row 606. ON CAM BOX SIDE, bind off 5 sts. after Rows 606, 607, then knit to Row 608.

Knit even to Row 488, then continue with Color 1 and work Short Rows. ON OPPOSITE SIDE of CAM BOX, put into holding position 1 needle after Rows 488, 489, 490, 491, 492, 493, 494, 495, 496, 497, 498, 499, 500, 501, 502, 503, 504, 505, 506, 507, then bring back into working position 1 needle after Rows 508, 509, 510, 511, 512, 513, 514, 515, 516, 517, 518, 519, 520, 521, 522, 523, 524, 525, 526, 527, then knit even to Row 586.

# jac40 is a must

for fast easy knitting of Jaquard and Ski-sweater designs

Patterns are selected—row by row—through a pre-stamped card that is fed into the Jac. There are over 140 cards available and illustrations of them are included with each Jac. Jac 40's are made for most brands of machines. When ordering be sure to specify your brand of knitter as needle spacings vary. Simple to use and an essential tool for the modern knitter, Jac 40's are \$24.95 complete with 3 cards for practicing the 3 techniques, plus complete instructions.

Order from your dealer or direct from  
**KNITTING**  
 1128 Crenshaw Boulevard, Los Angeles, Calif. 90019  
 Shipping Cost \$1.50—California residents add 5% sales tax.

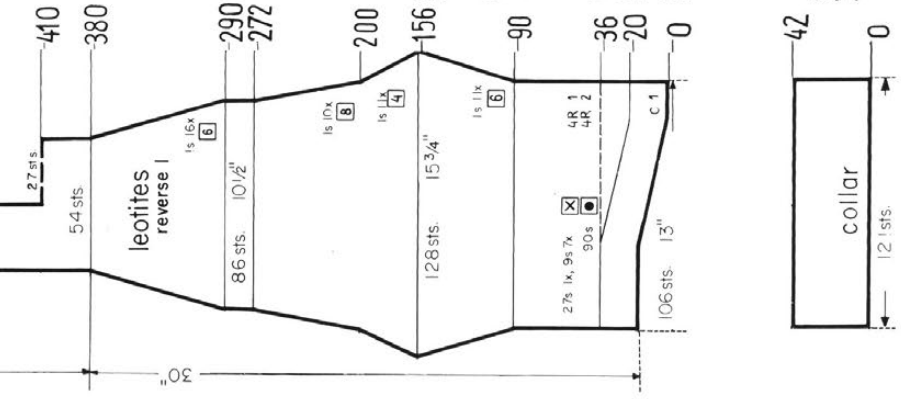

Knit even to Row 90, then increase 1 st. ON EACH SIDE after Rows 90, 96, 102, 108, 114, 120, 126, 132, 138, 144, 150. Knit to Row 156, then decrease 1 st. ON EACH SIDE after Rows 156, 160, 164, 168, 172, 176, 180, 184, 188, 192, 196, 200, 208, 216, 224, 232, 240, 248, 256, 264, 272, then knit to Row 290.

ROWS 0 to 20: Knit even, then work Short Rows. ON OPPOSITE SIDE of CAM BOX, put into holding position 90 needles after Row 20, then bring back into working position 9 needles after Rows 22, 24, 26, 28, 30, 32, 34. After Row 36 bring remaining 27 needles back into working position and work the repeated color stripes as marked in the diagram.

Cast on 106 sts. with Color 1 and work stockinette st.

Cast on 121 sts. with Color 1 and work 42 rows K1, P1, Ribbing, then bind off all sts.

# KK 5296

**SIZE 14** (Chest 32"-33", SIZE 16 (Chest 34"-35"). **SIZE 14:** MATERIAL: 5-50gr. balls white, 4-50gr. balls blue, 2-50gr. balls yellow and 2-50gr. balls black KNITTING Subita Crepe 2 x 4. **TENSION:** 6 to 8. **GAUGE:** 15 sts. 2", 20 rows 2". **SIZE 16:** MATERIAL: 5-50gr. balls white, 4-50gr. balls blue, 2-50gr. balls yellow and 2-50gr. balls black KNITTING Sonika Dralon. **TENSION:** 7 to 9. **GAUGE:** 14 sts. 2", 19 rows 2". The instructions are the same for both sizes. **PATTERN:** Norwegian Design according to Line Drawing, or use JAC 40 and Pattern No. 444. In the instructions, each row in the Norwegian Design is counted as 1 row, but several movements of the Cam Box are needed to complete 1 row. **EDGES:** K1, P1, Ribbing. **COLLAR:** K1, P1, Ribbing and Fisherman's Rib. **SLEEVE INCREASES:** ON EACH SIDE, after rows indicated, place the end st. from the row below onto the next empty needle. **FINISHING:** Join front and back section at sides and shoulders. Sew sleeves together and set in. Join short ends of collar, then sew bound-off edge of collar to neckline. Fold upper part of collar to inside and sew loosely to beginning of Fisherman's Rib.



# MK 5320

**SIZE 8** (Chest 27"), **SIZE 10** (Chest 28 1/2") **SIZE 8:** MATERIAL: PULLOVER: 4-50gr. balls Color 1 and 1-50gr. ball Color 2; JUMPER: 7-50gr. balls KNITTING Amore. **TENSION:** Stockinette Stitch 6 to 8, Pattern Stitch 4 to 6. **GAUGE:** Stockinette Stitch 16 sts. 2", 24 rows 2"; Pattern Stitch 16 sts. 2", 32 rows 2". **SIZE 10:** MATERIAL: PULLOVER: 5-50gr. balls Color 1 and 2-50gr. balls Color 2; JUMPER: 8-50gr. balls KNITTING Amore. **TENSION:** Stockinette Stitch 7 to 9, Pattern Stitch 5 to 7. **GAUGE:** Stockinette Stitch 15 sts. 2", 23 rows 2"; Pattern Stitch 15 sts. 2", 30 rows 2". The instructions are the same for both sizes. **PATTERN:** PULLOVER: Holding Position Design according to Line Drawing, worn on the knit side; EDGES: K1, P1, Ribbing. **JUMPER:** Stockinette Stitch, JUMPER DECREASES: Side Seam: After rows indicated, hang the 3rd st. on the appropriate sides onto the 2nd st., then move the end st. inward to fill the empty needle; Front Edge and Neckline: After rows indicated, hang the 9th st. on the front edge onto the 8th st., then move the end st. inward to fill the empty needle. **SLEEVE INCREASES:** ON EACH SIDE, after rows indicated, place the end st. from the row below onto the next empty needle. **FINISHING:** PULLOVER: Join front and back section at sides and shoulders. Sew sleeves together and set in. Sew 1 edge of collar to inside and 1 edge to outside of neckline. Work 1 row of single crochet around back opening. Make 4 loops on 1 side and sew 4 buttons to other side of opening. **JUMPER:** Join front and back sections at sides and shoulders. Weave the open sts. of the back facing together, then sew the facing to neckline. Turn under 7 sts. on front edges and around neckline and hem to wrong side. Turn under 4 sts. around armhole edges and 20 rows on lower edge and hem to wrong side. Sew the belt-loops in place. (See picture). Sew 2 rows of buttons to right front section. Sew snaps to wrong side of right section and right side of left section in line with buttons.

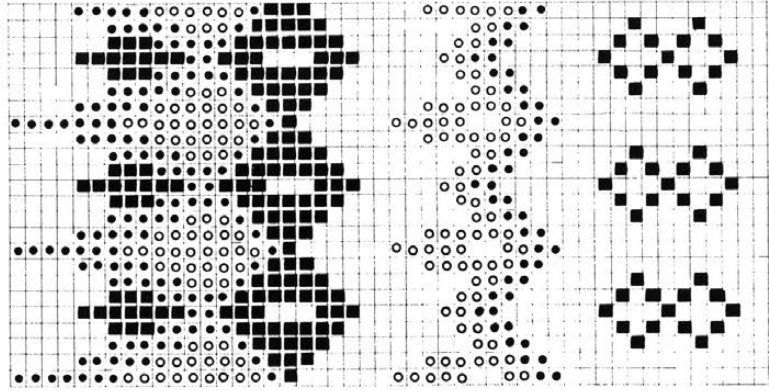

JAC 40

- = Yellow O
- = Black U
- = Blue E
- = White A

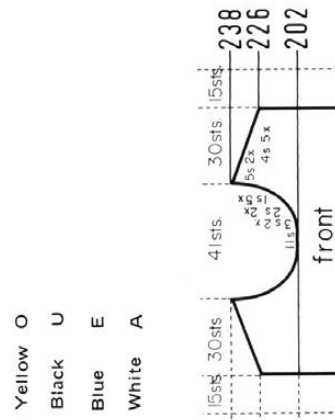
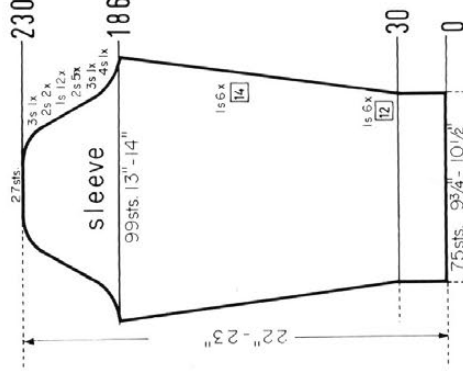

Bring the needles on the left side into working position, knit 1 row in PATTERN to the left side, turn the Row Counter back to 218 and complete the left half. Follow the instructions from\*.

\*ON CAM BOX SIDE, bind off 4 sts. after Rows 219, 221 (ODD ROWS = NECK SHAPING); 2 sts. after Rows 223, 225; 4 sts. after Row 228 (EVEN ROWS = SHOULDER SHAPING); 1 st. after Row 227; 4 sts. after Row 228; 1 st. after Row 229; 4 sts. after Row 230; 1 st. after Row 231; 4 sts. after Rows 232, 234; 5 sts. after Rows 236, 238.

ON CAM BOX SIDE, bind off 3 sts. after Rows 150, 151, 152, 153; 2 sts. after Rows 154, 155, 156, 157, 158, 159; 1 st. after Rows 160, 161, 162, 163, 164, 165, then knit to Row 218, bind off the center 11 sts., put the needles on the left side into holding position and complete the right half first. (For the Front Section knit to Row 202).

ROWS 31 to 150: Knit even.

ROWS 0 to 30: Knit even, then transfer the ribber sts. to the main machine and work the Norwegian Design.

Cast on 131 sts. with blue and work K1, P1, Ribbing.

ON CAM BOX SIDE, bind off 4 sts. after Rows 186, 187; 3 sts. after Rows 188, 189; 2 sts. after Rows 190, 191, 192, 193, 194, 195, 196, 197, 198, 199, 200. ON EACH SIDE hang the 1st st. onto the 2nd st. after Rows 200, 202, 204, 206, 208, 210, 212, 214, 216, 218, 220, 222. ON CAM BOX SIDE, bind off 2 sts. after Rows 224, 225, 226, 227; 3 sts. after Rows 228, 229; 27 sts. after Row 230.

ON EACH SIDE, increase 1 st. after Rows 30, 42, 54, 66, 78, 90, 102, 116, 130, 144, 158, 172, then knit to Row 186.

ROWS 0 to 30: Knit even, then transfer the ribber sts. to the main machine and work the Norwegian Design.

Cast on 75 sts. with blue and work K1, P1, Ribbing.

Bring the needles on the left side into working position, knit 1 row in PATTERN to the left side, turn the Row Counter back to 202 and complete the left half. Follow the instructions from\*.

\*ON CAM BOX SIDE, bind off 3 sts. after Rows 203, 205; 2 sts. after Rows 207, 209; 1 st. after Rows 211, 213, 215, 217, 219. For SHOULDER bind off 4 sts. after Rows 226, 228, 230, 232, 234; 5 sts. after Rows 236, 238.

Work the front section the same as the back section to Row 202, then bind off the center 11 sts., put the needles on the left side into holding position and complete the right half first.



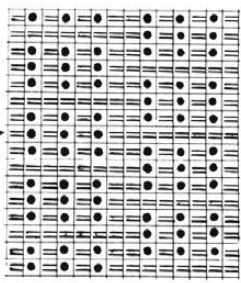

- 27 - 28 Color 1
- 25 - 26 Color 2
- 23 - 24 Color 1
- 21 - 22 Color 2
- 19 - 20 Color 1
- 17 - 18 Color 2
- 15 - 16 Color 1
- 13 - 14 Color 2
- 11 - 12 Color 1
- 9 - 10 Color 2
- 7 - 8 Color 1
- 5 - 6 Color 2
- 3 - 4 Color 1
- 1 - 2 Color 1

Cast on 17 sts. and work 18 rows K1, P1, Ribbing, then bind off all sts.

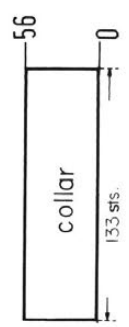
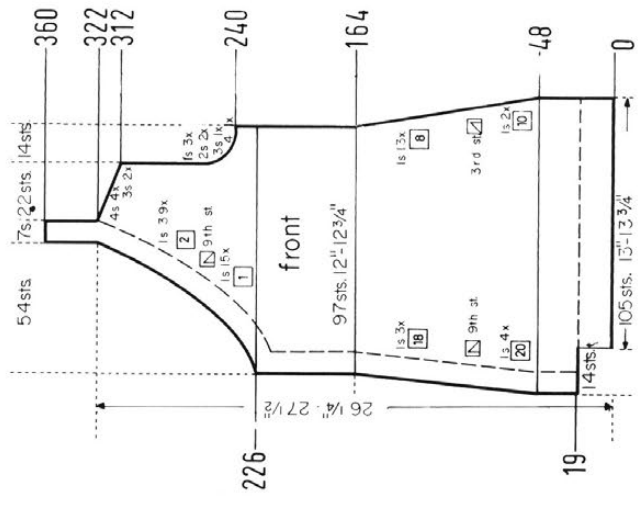
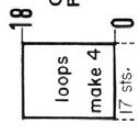

Cast on 133 sts. with Color 1 and work 56 rows K1, P1, Ribbing, then bind off all sts.

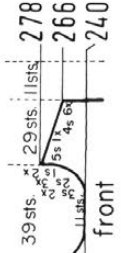

Work the second front section with reverse shapings, casting on from right to left. (Cam Box will be on the LEFT side at Row 0).

Continue to decrease 1 st. on NECK SIDE after Rows in ( ). On ARMHOLE SIDE, bind off 4 sts. after Row 240; (240), (241), 3 sts. after Row 242; (243), 2 sts. after Rows 244, (245), 246; (247), 1 st. after Rows 248, (249), 250, (251), 252. The Armhole Shaping is now completed. Continue to decrease 1 st. on NECK SIDE after Rows 253, 255, 257, 259, 261, 263, 265, 267, 269, 271, 273, 275, 277, 279, 281, 283, 285, 287, 289, 291, 293, 295, 297, 299, 301, 303, 305, 307, 309, 311, then again after Rows in ( ). For SHOULDER bind off 3 sts. after Rows 312, (313), 314; (315), 4 sts. after Rows 316, (317), 318, 320, 322. Continue to work over the remaining 7 sts. for the Neck Facing to Row 360, then put these sts. onto a stitch holder.

ON NECK SIDE decrease 1 st. after Rows 226, 227, 228, 229, 230, 231, 232, 233, 234, 235, 236, 237, 238, 239, then knit to Row 240.

ON FRONT EDGE, decrease 1 st. after Rows in ( ). ON CAM BOX SIDE, decrease 1 st. after Rows 48 (48), 58, 68, (68), 76, 84, (88), 92, 100, 108, (108), 116, 124, (128), 132, 140, (146), 148, 156, 164, (164), then knit even to Row 226.

ROWS 20 to 48: Knit even.  
ROWS 0 to 19: Knit even, then cast on 14 sts. ON CAM BOX SIDE.  
Cast on 105 sts. and work stockinette st.

Bring the needles on the left side into working position, knit 1 row in PATTERN to the left side, turn the Row Counter back to 240 and complete the left half. Follow the instructions from\*.

\*ON CAM BOX SIDE, bind off 3 sts. after Rows 241, 243; 2 sts. after Rows 245, 247, 249; 1 st. after Rows 251, 253. For SHOULDER bind off 4 sts. after Rows 266, 268, 270, 272, 274, 276; 5 sts. after Row 278.

Work the front section the same as the back section to Row 240, then bind off the center 11 sts., put the needles on the left side into holding position and complete the right half first.

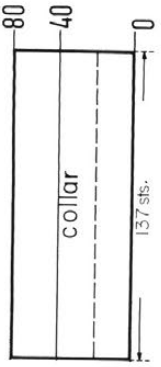

Cast on 137 sts. with blue, work 40 rows K1, P1, Ribbing, then place the Gate Cam Release Lever of the Ribber to the needle heels and work 40 rows Fisherman's Rib. After Row 80 bind off all sts.

Bring the needles on the left side into working position, knit 1 row in PATTERN to the left side, turn the Row Counter back to 228 and complete the left half. Follow the instructions from\*.

ON CAM BOX SIDE, bind off 4 sts. after Row 266 (EVEN ROWS = SHOULDER SHAPING); 8 sts. (7 sts. for the left half) after Row 267 (ODD ROWS = NECK SHAPING); 4 sts. after Row 268; 3 sts. after Row 269; 4 sts. after Row 270; 3 sts. after Row 271; 4 sts. after Row 272; 2 sts. after Row 273; 4 sts. after Row 274; 2 sts. after Row 275; 4 sts. after Row 276; 2 sts. after Row 277; 5 sts. after Row 278.

\*ROWS 229 to 266: Knit even.  
ON CAM BOX SIDE, bind off 3 sts. after Rows 170, 171, 174, 175; 2 sts. after Rows 278, 279; 1 st. after Rows 182, 183, 186, 187, 190, 191, then knit to Row 228, put 48 needles on the left side into holding position and complete the right half first. (For the FRONT SECTION knit to Row 240 and do NOT divide the sts.)

ROWS 23 to 170: Knit even.  
ROWS 0 to 22: Knit even, then transfer the ribber sts. to the main machine and work the Holding Position Design.

Cast on 119 sts. with Color 1 and work K1, P1, Ribbing.

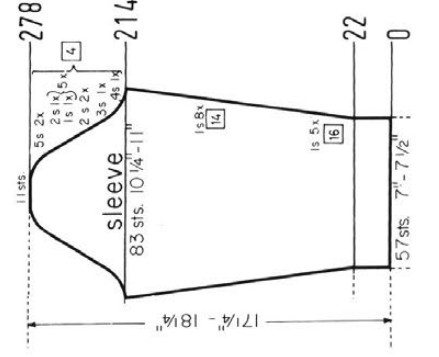

ON CAM BOX SIDE, bind off 4 sts. after Rows 214, 215; 3 sts. after Rows 218, 219; 2 sts. after Rows 222, 223, 226, 227; 1 st. after Rows 230, 231; 2 sts. after Rows 234, 235; 1 st. after Rows 238, 239; 2 sts. after Rows 242, 243; 1 st. after Rows 246, 247; 2 sts. after Rows 250, 251; 1 st. after Rows 254, 255; 2 sts. after Rows 258, 259; 1 st. after Rows 262, 263; 2 sts. after Rows 266, 267; 5 sts. after Rows 270, 271, 274, 275; 11 sts. after Row 278.

ON EACH SIDE, increase 1 st. after Rows 22, 38, 54, 70, 86, 102, 116, 130, 144, 158, 172, 186, 200, then knit to Row 214.  
ROWS 0 to 22: Knit even, then transfer the ribber sts. to the main machine and work the Holding Position Design.  
Cast on 57 sts. with Color 1 and work K1, P1, Ribbing.

Continued on next page

SIZE 3-4 (Chest 23"-24"). MATERIAL: 6-50gr. balls KNITTING Subita Crepe 2 x 3 or 7-50gr. balls Amore. TENSION: 3 to 5, GAUGE: Stockinette Stitch 18 sts, 2", 25 rows 2"; Pattern Stitch 18 sts, 2", 43 rows 2". PATTERN: Skirt and Sleeves: Stockinette Stitch, worn on the knit side; Yoke, Pockets and Cuffs: Holding Position Design according to Line Drawing, worn on the purl side. FINISHING: Join the skirt sections at sides. Gather the upper edge of the skirt using a running stitch, then join the skirt to the yoke. Sew sleeves together and set in. Gather the sleeve edges. Close short ends of cuffs, then sew 1 edge of cuff to inside and 1 edge to outside of sleeve edges. Work 1 row of single crochet and 1 row of back-ward single crochet around neckline. Work 1 row of single crochet around back opening. Close opening with loops and buttons. Sew the pockets in place. Turn under 20 rows on lower edge and hem to wrong side.

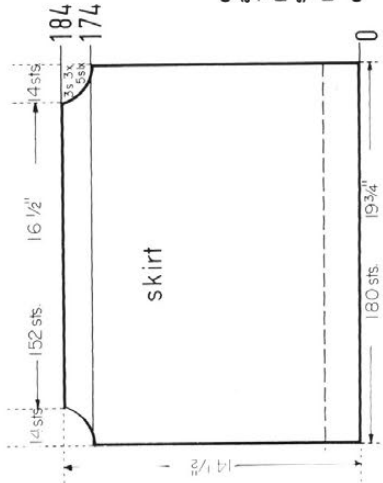
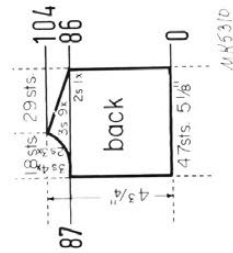
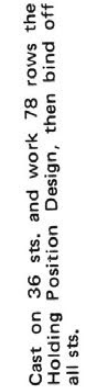
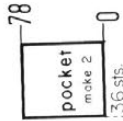
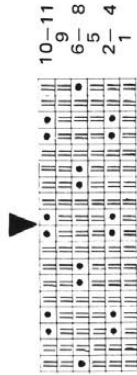

Cast on 50 sts, work 26 rows stockinette st. and 44 rows the Holding Position Design. After Row 70 bind off all sts.

ON CAM BOX SIDE, bind off 5 sts, after Rows 174, 175; 3 sts, after Rows 176, 177, 178, 179, 180, 181. After Row 184 bind off all 184 sts. Work the second skirt section the same. ROWS 0 to 174: Knit even. Cast on 180 sts, and work stockinette st.

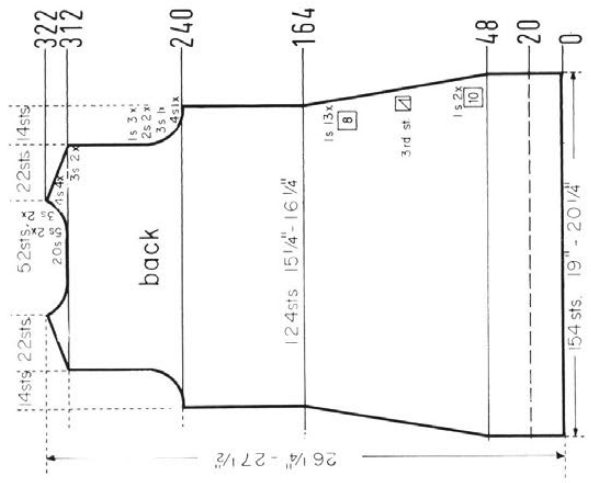

Work the second back section with reverse shapings, casting on from right to left. (Cam Box will be on the LEFT side at Row 0).

ON CAM BOX SIDE, bind off 2 sts, after Row 86 (EVEN ROWS = SHOULDERS SHAPING); 3 sts, after Rows 87 (ODD ROWS = NECK SHAPING), 88, 89, 90, 91, 92, 93, 94; 2 sts, after Row 95; 3 sts, after Row 96; 2 sts, after Row 97; 3 sts, after Row 98; 2 sts, after Row 99; 3 sts, after Rows 100, 102, 104. ROWS 0 to 86: Knit even. Cast on 47 sts, and work the Holding Position Design.

Bring the needles on the left side into working position, knit 1 row in PATERN to the left side, turn the Row Counter back to 60 and complete the left half. Follow the instructions from\*.

\*ON CAM BOX SIDE, bind off 2 sts, after Rows 61, 63, 65, 67; 1 st, after Rows 69, 71, 73, 75, 77, 79. For SHOULDER bind off 2 sts, after Row 86; 3 sts, after Rows 88, 90, 92, 94, 96, 98, 100, 102, 104.

ROWS 0 to 60: Knit even, then bind off the center 8 sts., put the needles on the left side into holding position and complete the right half first.

Cast on 94 sts, and work the Holding Position Design.

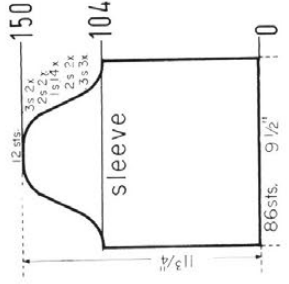

ON CAM BOX SIDE, bind off 3 sts, after Rows 104, 105, 106, 107, 108, 109; 2 sts, after Rows 110, 111, 112, 113. ON EACH SIDE, hang the 1st st. onto the 2nd st., after Rows 114, 116, 118, 120, 122, 124, 126, 128, 130, 132, 134, 136, 138, 140. ON CAM BOX SIDE, bind off 2 sts, after Rows 142, 143, 144, 145; 3 sts, after Rows 146, 147, 148, 149; 12 sts, after Row 150. ROWS 0 to 104: Knit even. Cast on 86 sts, and work stockinette st.



## KG 1928 AFGHAN

Approximate Size 50" x 70". MATERIAL: 22-50gr. balls main color; 3-50gr. balls 2nd color for Flowers; 3-50gr. balls Green for Leaves; KNITTING Somika Dralon. TENSION: 9 or 10 for squares, 8 for Flowers and Leaves. GAUGE: PATTERN STITCH: 12 stitches, 28 rows 2". Square measures 4½" x 4½".

FINISHING: With No. 7 crochet hook, crochet around each square as follows: ROW 1: Begin at corner, \*3 single crochet in corner, 25 single crochet along side, then REPEAT from \* ending with slip st. to first single crochet. ROW 2: Ch 3, dc, ch 2, 2 dc in same st. \* (ch 1, skip 3 sc, 3 dc in next st.) 6 times. Ch 1, skip 3 sc (2 dc, ch 2, 2 dc in corner st.) REPEAT from \* 3 times ending with ch 1, join to 3rd st. of ch 3.

Join squares so that each will have an alternate side. Hold 2 squares together, sc through the ch 2 space at corner. \*Ch 3, sc in each 8 spaces across. REPEAT from \* for attaching squares into strips. Make 13 strips of 9 squares. Join the long strips together in the same way. Join 4 leaves together and sew a flower in the center of each. (Form the flower by rolling the long strips into flower shape beginning at small end). Attach Flowers and leaves to each alternate square (see picture).

CROCHET EDGING: Begin at corner. In the ch 2 space, work ch 3, dc, p (picot) is made by ch 3, slip st. into top of last dc). 2 dc, p, 2 dc, p, 2 dc, p, 1 dc. \*In each center dc of previous row, work dc, p, 2 dc, p. Continue until corner, then dc, p, 2 dc, p, 2 dc, p, 2 dc, p. REPEAT from \* ending with a slip st. to top of ch 3 at last corner, make a p and break off.

PATTERN STITCH for SQUARES: \*Put the 2nd, then every other needle into holding position, knit 1 row. Bring all the needles back to working position, knit 1 row. Put the 1st, then every 2nd needle into holding position, knit 1 row, bring all the needles back to working position, knit 1 row. REPEAT from \* for pattern. KNITTING MACHINE OWNERS, use Wheel No. 6 and push in the RIGHT Retractor Button and leave it there.

Cast on 28 sts. Knit 64 rows in pattern stitch, then knit each stitch loosely by hand, then latch off the crochet method. Make 117 squares (13 rows of 9 squares).

FLOWER: Tension 8. Bring 7 needles into working position and push back to the out of work position needles 3, 4, 5, 6. Cast on over remaining 3 needles. \*Put the single needle on the left into holding position, knit 14 rows (always wrap the yarn around the holding position needle). Bring the needle back into working position and knit 2 rows. REPEAT from \* 6 x more. Move the single needle 2 sts. over to the right. \*Put the single needle into holding position, knit 8 rows (wrap the holding position needle each time). REPEAT from \* 2 x more. Bind off. Make 59 Flowers. LEAVES: Tension 8. Cast on 3 sts., knit 1 row, increase 1 st. beginning next 8 rows (11 sts.). Decrease 1 st. beginning each row till 1 remains. Bind off. Make 4 Leaves for each Flower.



knitknik  
Mighty Light

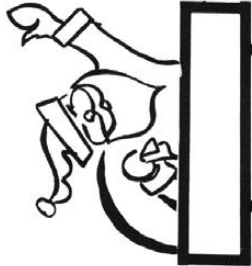

## KG 1929 BASSINETTE PURSE

MATERIAL: 2-50gr. balls KNITTING Subita Dralon 3-ply will make 3. Large size Ivory Liquid container. Small piece of Polyfoam for mattress. Small doil. TENSION: Pattern Stitch 7 or 8. Stockinette Stitch 4 or 5. GAUGE: Pattern Stitch 10 sts., 32 rows 2". Stockinette Stitch 16 sts., 22 rows 2".

FINISHING: Measure 2" from base of container, mark with pencil and cut off then discard top. With paper punch, make holes around top of oval approximately ½" apart. With No. 2 crochet hook, make 2 single crochet into each hole. Sew seam of Ruffle flat. Crochet around lower edge of Ruffle as follows: Attach yarn at top of first shell next to seam. Chain 3, single crochet in same space, (picot), \*Chain 3, single crochet into top of next shell, chain 3, single crochet in same space. REPEAT from \* all around. Pin Ruffle to top of Bassinette with seam at back, then slip st. into each single crochet on oval. Make picots across front of hood, then pin in place as shown in picture, and sew to Bassinette. Run Ribbon around through holes and tie in bow. Pull cords through top for a pull cord and tie ends then attach small pom-poms. Sew sides of Mattress Cover and after making mattress (use base to mark around foam for mattress and cut out). Insert into Mattress Cover and sew up end. Fold up lower edge of Bunting then sew up sides. Put Baby in Bunting then in Bassinette. Pull cords to make purse. Open and fold Ruffle down to show Baby in Bassinette.

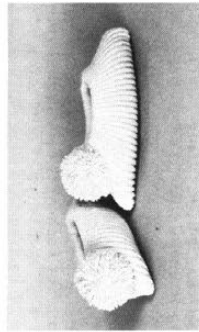
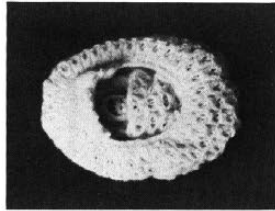

RUFFLE: Tension 7 or 8. Bring 182 needles into working position, then put back to the out of work position, the 3rd and 5th, then every 3rd and 5th needle. Cast on over remaining 110 needles left in work. \*Put every single needle into holding position and knit 6 rows. All needles in work, knit 2 rows. REPEAT from \* to Row 32. Bind off 2 sts. at a time (not too tight).

HOOD: Tension 4 or 5. Stockinette Stitch. Cast on 31 sts. Knit 2 rows, then knit Short Rows (always wrap the yarn around the inside needle in holding position when knitting Short Rows). \*On opposite side of Cam Box, put 1 needle into holding position beginning next 2 rows, and 2 needles beginning next 2 rows. REPEAT from \* till 5 needles are left in work. On opposite side of Cam Box, bring all the needles into work beginning next 2 rows. Bind off the crochet method.

MATTRESS: Stockinette Stitch. Cast on 25 sts. Knit short rows. (Wrap Yarn) On opposite side of Cam Box, put 10 needles into holding position beginning next 2 rows. On opposite side of Cam Box, bring back into work 2 needles beginning each row till all are in work. Knit 28 rows. On opposite side of Cam Box, put 2 needles into holding position beginning each row till 5 remain in work. Bring back 2 needles till all are in work. Knit 28 rows. On opposite side of Cam Box, put 2 needles into holding position beginning each row till all are in work. Knit 28 rows. On opposite side of Cam Box, put 2 needles into holding position beginning each row till 5 remain in work. Bind off.

BUNTING: Bring 19 needles into working position, then set up in Pattern as for Ruffle, having 3 needles at each end in work. Knit in Pattern with Tension 7 or 8 to Row 40. Change to Tension 4 or 5 and knit in stockinette stitch. Bring all empty needles into work. Knit to Row 74, then knit Short Rows (remember to wrap yarn). On opposite side of Cam Box, put 2 needles into holding position beginning next 6 rows. On opposite side of Cam Box, bring back into working position, 2 needles beginning each row till all are in work. Knit 8 rows. After Row 94, bind off the crochet method.

CORD: make 2. Set your machine for knitting a cord. KNITTING machine owners push in the right Cam Control Button. Cast on 2 sts. and with Tension 1, knit 300 rows. Bind off.



## KG 1932 FOOTEES

SIZE: Small for children; Medium for Women and Large for Men in (.). MATERIAL: 2-50gr. balls KNITTING Subita Dralon 3-ply. TENSION: 4 or 5. GAUGE: 16 sts., 44 rows 2", measured over pattern. PATTERN STITCH: K1, P1 and Brioché (double Fisherman's) Rib.

FINISHING: Fold in half with the cast-on and bind-off edges together. Sew back seam, gathering last 20 rows to form heel. Sew front edge together. Fold the K1, P1 ribbing in half and sew hem on the wrong side. Run elastic through hem and tie or sew to fit. Make pom-pom and fasten to toe of Footee's just below the hem. Trim boy's or men's with buttons instead of pom-poms.

Cast on 41 (67, 79) sts. ROWS 1-20 (24, 24) work K1, P1 ribbing. ROWS 21-120 (25-124, 25-144) Brioché Rib. (KNITTING Machine owners, put the Gate Cam Release Levers of both knitter and ribber to the needle heels). ROWS 121-140 (125-148, 145-168), K1, P1 ribbing (KNITTING Machine owners, put Gate Cam Release Levers of knitter and ribber to the needle heads). Bind off the crochet method for ribbing.

## KG 1930

### REINDEER DESIGN DRAWSTRING BAG

**MATERIAL:** 4-50gr. balls main color, 3-50gr. balls contrast color, KNITTING Double Knitting. 1 yd. medium weight drip dry fabric for lining and a 12" zipper for inside pocket, 14 — ½" Cafe curtain rings with Eye, TENSION 9 or 10. GAUGE: 12 sts. 17 rows to 2". JAC 40 and Pattern No. 310 (a 30 needle pattern). Finished Size 15" x 20".

**FINISHING:** After blocking, cut lining using the bag for a pattern and subtract the fold over at top of bag. Cut 3 more pieces of lining for pockets in the following measurements: 13" x 1½", 13" x 8½", 13½" x 14". Fold over and press 3/8" to wrong side of one of the 2 long edges of the 13" x 1½" and 13" x 8½" pieces. Pin the pieces to, and sew on either side of the zipper. Fold over 3/8" and press to wrong side, all around zippered piece; then pin and baste to lining so that zipper is 5" from top. Make a double row of stitching, with second row ¼" from edge. For large pocket, fold edges and press 3/8" to wrong side, then make a 1½" hem at the top and stitch across hem. Pin this section on other side of lining 6" from top. Make a double row of stitching around 3 sides. Sew up lining on the wrong side. Fold in half and weave carefully. Slide lining into bag and pin to hold. Bring the fold-over of top of bag to the wrong side and pin, then sew hem firmly by hand (be careful not to go through to the right side). With main color yarn, sew 5 rings spaced evenly on each side of bag and 2 rings at each side seam, just above the hemline and go through the inner lining but not all the way through bag. Do not pull the yarn too tight. Run the draw strings through rings, make tassels for each end of drawstring. Cut Fringe in 10" lengths, fold in half and using 8 strands, make fringe across bottom of bag.

### DRAWSTRING BAG

Open cast-on with waste yarn, 92 sts. Begin casting on at needle 46 to the left of the 0 needle and end with needle 45 to the right of the 0 needle. Mark the back of the needle rail at needle 20 on the left of 0, and needle 19 on the right of 0. These markings will be the guide for your JAC 40 design and you must place the red plastic foot at these marked needles. \*Knit 20 rows main color, then begin the stripes. \*\*Knit 4 rows contrast, 2 rows main color; 4 rows contrast, 2 rows main color; 4 rows contrast, 2 rows main color, 4 rows contrast. After Row 46, change to main color. Begin JAC Pattern after Row 52. JAC Pattern ends at Row 96. Knit 10 rows main color then REPEAT STRIPES from \*\* to Row 132. Continue stockinette stitch with main color to row 173, then change the last row knitted into a knit stitch (with your latch tool, catch each st. in the row below, allowing the one row to unravel, then latch it up into a knit stitch). Continue to knit to Row 186, then bind off the crochet method. Hang the sts. held on contrast yarn back onto the machine, remove contrast and knit the second side, following the instructions from\*.

**CORD:** Make 2. Tension 2 or 3. Set your machine for knitting a cord. KNITTING machine owners, push in the Right Cam Control Button. Knit 600 rows (empty rows do count). Bind off.

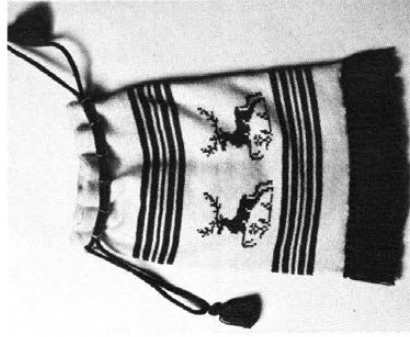

## KG 1933

### GOLF MITTS

**MATERIAL:** 3-50gr. balls KNITTING Double Knitting in main color; 1-50gr. ball contrast color for Pom-poms and Numbers. Will make 4 mitts, TENSION: 10 for Ribbing, 9 for Stockinette Stitch. GAUGE: 12 sts., 19 Rows to 2".

**FINISHING:** Weave the sts. held on contrast yarn and remove waste yarn. Weave side seam. Make a pom-pom for each Mitt by winding yarn 40 times around a 6" cardboard. Form cords into numbers and sew on each mitt.



Cast on 47 sts. and work K1, P1, ribbing to Row 50, change to Stockinette. Stitch and increase 1 st. (48 sts.).

Counter at 0: Knit 46 rows, then put 24 needles on the left side into holding position and knit short rows on the 24 needles in work.

**ON OPPOSITE SIDE** of Cam Box, put 3 needles into holding position after Rows 46, 47 (be sure to wrap yarn around inside needle in holding position to prevent a hole), then put 2 needles in holding position after Rows 48, 49, 50, 51, 52, 53.

Leave 9 needles on the right side in holding position, all other needles in work, knit 1 row to the left side.

Leave 24 needles on the left in working position, all other needles in holding position and work short rows.

**ON OPPOSITE SIDE** of Cam Box, put 3 needles in holding position after Rows 55, 56; 2 needles after Rows 57, 58, 59, 60, 61, 62.

Leave 9 needles on the left in holding position, all other needles in work, knit 1 row to the right side.

Put all the needles in work and knit 1 row. Knit 5 rows using contrast waste yarn and remove work from the machine. Make 3 more Mitts.

**CORD:** Set your machine for knitting a cord. KNITTING machine owners, push in the Right Cam Control Button. Tension 6. Cast on 3 sts.

For Number 1 — Knit 36 rows. For Number 2 — Knit 64 rows. For Number 3 — Knit 70 rows. For Number 4, make 2 cords; one 54 rows, and one 30 rows.

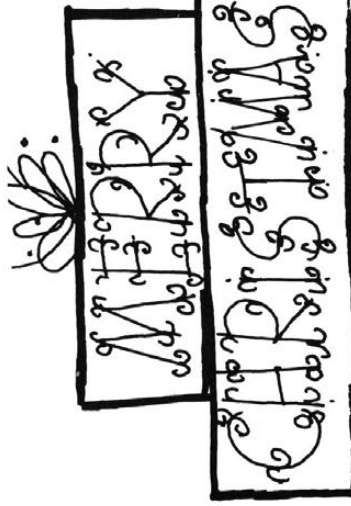

## KG 1931

### CHRISTMAS WREATH LAPEL PIN

**MATERIAL:** Small amounts of green and white KNITTING Subria Crepe 2 x 3. Small red sequins, beads for center of sequins, ¼" red ribbon, small safety pin.

**FINISHING:** Weave the seam from the right side, working first on the front side and then down the back to form a circle. Sew 3 red sequins with a bead in the center, close together in 3 separate spots. Make a tiny red bow with ribbon and attach at top. Sew a small safety pin to back.

Cast on 40 sts. with green;  
Knit 2 rows tension 1,  
Knit 2 rows tension 3,  
Knit 2 rows tension 5,  
\*Knit 2 rows tension 7,

Knit 4 rows tension 9; Working backwards, follow instructions from\*, then hang the cast on stitches onto the machine behind the latches (2 sts. on each needle). With white yarn, bind off tightly two stitches at a time using the crochet method.

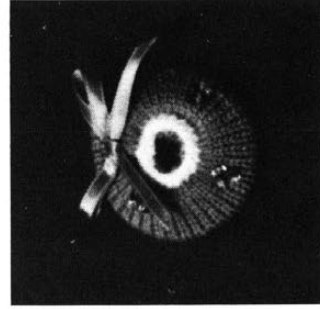





# KNITKING NEWS

November/December, 1971

## OUR READERS WRITE

Mrs. Anne Luchsinger of Lakewood N. Y. writes... "Why do you put darts in all of your pants patterns..." they just aren't necessary... check the most expensive ready-made ones... and they aren't flared at the bottom either..."

The ready-made pants without darts are usually made of the polyester stretch fabrics, which are naturally quite different from our knitted fabric. We put darts in our pants so that they will fit smoothly over the hips and up to the waistline... Knitted pants with darts hold their shape beautifully, are the most flattering to all figures and the majority of our subscribers prefer them. If you are going to wear a long tunic over the pants and want to leave the darts out... you can of course do so. We would suggest that you decrease a few more stitches on each side and turn the tension down slowly toward the waistline, then elastic run through a hem at the waist will pull the waistline in. Be certain that you make a sample swatch using the different tension numbers because some yarns will show the change in tension and also you might have to knit some extra rows. The decision is yours...!

If you do not want flared pants (we still see lots of them around Southern California), you can cast on the number of stitches given AFTER the flare then knit straight up to the row where you begin the shapings.

## PRACTICAL KNITTING HINTS

### THE CROCHET METHOD FOR BINDING OFF

Most experienced knitters know about and always use the crochet method for binding off the completed section of a garment. We are receiving requests for information about this method and since this is the preferred method we use in our KNITKING MAGAZINE, we are reviewing the procedure for both the Knitter and the Ribber...

### THE KNITTER

When you have completed a section of a garment and are ready to bind off, turn your Tension Control Dial up at least 3 to 5 numbers higher than you have been using for your garment and knit 1 row. If you want to be certain this will be a fairly loose row, remove the yarn from the Feed Finger and Yarn Container and feed this one row by hand, holding the yarn loosely across the OPEN latches of the needles. If you are using a Tension where you cannot turn the Tension Control Dial up at least 3 numbers, you must knit this one row manually one stitch at a time, making each stitch at least 1/4" long. After you have completed this bind off row, bring the needles into holding position, release the stitches from under the sinkers by pushing down on the back of the sinkers. You must always begin to latch off on the side OPPOSITE to your yarn end... so that if the yarn end is on the left side, begin on the right. Take your latch tool in your right hand, remove the first stitch on the right and allow it to slide behind the needle latch. Put your thumb on it to hold the stitch behind the needle latch. Now remove the second stitch and pull it through the first stitch, then allow it to go behind the

needle latch. Take the third stitch off onto your latch tool and pull it through the third, etc., etc. As you are pulling each stitch through you can see if your bind off is neat and even, with a smooth crochet edge. If it looks too loose, pull up on the stitches a bit as you crochet them off, but NEVER pull them up so that the edge is tight with no give. As you remove the stitches, push the empty needles back out of your way to make it easier for you.

### THE RIBBER

Finish your ribbing with both Cam Boxes at the right. Then remove the coupling hook from the machine and push the Ribber Cam Box up out of the way and to the right. Remove the yarn from the Yarn Container and lay it by hand over the needles from right to left, making sure that the yarn is directly under the hooks of the Ribber needles.

Now starting with the first Ribber needle at the right, pull it down to the bottom rail. It will pull the yarn with it and make a long loop. Pull each Ribber needle down and leave them down. Set the stitch size control at 10 (you will need the stitch to be loose for your bind off edge) and push the machine Cam Box from right to left.

Transfer the stitches from the Ribber needles to their corresponding needles on the main machine. Since the Ribber needles are already all the way down, you will need to pull them up with the Transfer Needle (while pushing them up by the heels with the other hand) then push them down again in order to transfer the stitch to the Transfer Needle.

When all the stitches are on the main machine, push the needles holding them forward into the holding position and remove the Ribber from the machine. Release the knitting from under the sinkers by pushing down on the backs of them (so that the fronts are lifted) and carefully ease the knitting forward. If you pull too hard on the knitting, it will slide right off the front of your needles. Break the yarn and leave approximately six inches hanging for tying at the end of your bind off. Now bind off the crochet method as explained for the Knitter.

## GIFT ITEMS in KNITKING MAGAZINE

Many subscribers to KNITKING MAGAZINE offer us Patterns of their own design for inclusion in KNITKING MAGAZINE, but in the normal way we have to refuse them... We are however interested in patterns and instructions for original Gift items and we will give a small reward to any reader who submits an original Gift Pattern that we are able to use.

One of our Teachers, Adeline Griffin of La Verne, California sent us the pattern for the Footies in this issue. They are simple to make and an ideal Christmas Tree Gift item.

## SPECIAL ON YARNS for COVER AFGHAN

The Afghan as shown on the Cover measures finished 50" x 70" and takes a total of 28-50gr. balls of Sonika Dralon, the easy care (machine wash and dry) miracle yarn from Germany. If you want to



make it in the size shown, the total Special Sale cost for all the yarn needed is \$26.88 (plus \$1.35 shipping). This is a saving of \$6.72 on the regular Sonika price. If you wish to make it in a larger size, the yarn will cost 96 cents for each additional 50gr. ball, plus 35 cents mailing costs for any number of balls up to 10. It can of course be made in any color combination and looks absolutely gorgeous as a Bed Spread... Be sure to order this and any other yarn you need for Christmas Gift knitting as soon as possible. The West Coast dock strike has prevented us from re-stocking yarns since July. Fortunately we stock-piled prior to that date, but stocks of many popular colors are getting low and we will sell on a first come, first served basis.

Here is a list of fantastic color combinations for knitting the Afghan.... all of them beautiful.

<u>Background</u>	<u>Flower</u>	<u>Leaves</u>
No. 411, pale pink	No. 404, rose	No. 436
No. 407, beige	No. 437, orange	No. 441
No. 413, aqua	No. 427, turq.	No. 436
No. 407, beige	No. 439, red	No. 441
No. 434, yellow	No. 437, orange	No. 441
No. 404, pink	No. 444, burgandy	No. 441
No. 441, green	No. 401, white	No. 436



# knitking

*Offers Complete Service To The Machine Knitter . . .*

**KNITKING KNITTING MACHINES** — The finest and most versatile automatic knitters available anywhere in the world — KNITKING is the worlds most honored machine with five gold medals for excellence. KNITKING Push-Button knitters produce a range of patterns and knit a variety of yarns unequalled by other machines.

**KNITKING MAGAZINE** — Without a doubt the finest Knitting machine magazine in the English language published anywhere in the world. Twenty original patterns in each issue and for all members of the family. Stylish designs photographed on world famous models. High fashion garments, handsome sweaters, sports outfits, baby clothes, plus accessories and knitting machine hints. All available to you in KNITKING MAGAZINE.

**KNITKING YARNS** — We searched the world over for the finest yarns obtainable and one look inside our catalogue will prove that we found them. A complete range of beautiful crepe machine washable 100% wool yarns...luxurious mohairs...handsome tweeds...pretty mixtures and luscious synthetics that are machine washable...easy to care for...and yet, can be knitted into the most glamorous of garments.

If you want your garments to look as good as those in KNITKING MAGAZINE and keep their appearance through dozens of washes, you must knit them with gorgeous KNITKING yarns. KNITKING yarns are the finest quality obtainable anywhere and the prices cannot be beaten. Try them once and you will always use them.

Send \$1.00 for LARGE COMPLETE YARN CATALOGUE (Refunded on your first \$10.00 order) to:

KNITKING YARNS, Dept. 19  
1128 Crenshaw Boulevard  
Los Angeles, California 90019



# NOTES TO KNIT BY . . .

## STITCH AND ROW GAUGE

KNIT A SAMPLE SWATCH . . . before you begin to knit any garment . . . for this is the MOST IMPORTANT STEP toward the correct size and the proper fit of any garment you wish to make. You MUST use the SAME YARN for your sample swatch that you will use to knit your garment and your sample swatch must be knitted large enough and using several different tension numbers on your machine. When you have done this, then you can determine the number of stitches and the number of rows in a two-inch measure. KNITTING MAGAZINE PATTERNS give you 3 tensions to try and one of them should give you the correct stitch and row gauge if you are using the yarn we recommend or a similar weight yarn. Here is the way to make your sample swatch.

Cast on over a sufficient number of needles to produce a swatch at least 4 inches wide. (If the pattern calls for 16 stitches to 2", then 16 x 2 = 32 stitches to cast on). Now knit 4 inches of rows at the first suggested tension number. (If the pattern calls for 22 rows to 2", 22 x 2 = 44 rows to knit). Knit 2 rows using a contrast color, change to the next higher tension and with garment yarn knit another 4", knit 2 rows with contrast color, change to the 3rd higher tension and knit another 4" and then bind off.



Roll the swatch into a cylinder over its length and pull on both ends, unroll it and stretch it diagonally by pulling on the four corners. Allow the swatch to rest and settle (preferably overnight) and then using a stitch gauge or a ruler, count the number of stitches over a 2" width, then the number of rows over a 2" length in EACH of the 3 tensions. Select the tension number that produces the stitches and rows called for in the pattern. If none of them are correct, you are most likely using the wrong weight of yarn.



## READING OF CHARTS

You will notice the instructions start at the bottom of the Chart and work UP. Follow the charts exactly as written and providing your sample stitch and row gauge is correct, your garment will come out the right size. Please remember that the section of garment as it is knitted on the machine, faces the same way as the Charts are in this magazine. Where two front pieces are needed, (or any other part of a garment that needs two sections) only one section is normally shown and the second section is usually made with reverse shapings. Set in sleeves are usually identical, but raglan sleeves have to be knitted with reverse shapings for the second sleeve.

## READING OF SYMBOLS

To simplify Pattern Knitting, we use Symbols in the Line Drawings and the Chart Diagrams. In the Line Drawings the symbols are shown and are to be read as you look at them while knitting a garment. For instance, if

a Purl stitch faces you, the Purl stitch Symbol  is shown; if a knit stitch faces you (as when using the Ribber) then this Symbol  is shown. The Symbol  at the top of the Line Drawing is the center of the garment section and you use this as a guide for setting up the needles.

The following Symbols    are used for Eyelet Designs in the Line Drawings and also for Full Fashion shaping on the Charts. The Line Drawings have row numbers on the right side. Missing Row numbers are always knitted straight or plain.

In Holding Position Designs  selected needles are pushed into holding position for the stated number of rows. The numbers of rows appear at the right of the Line Drawings; Example: 1-4 means knit Rows 1 to 4; 5 to 7 means knit Rows 5 to 7, etc. This same Symbol is also shown on the Charts and is used for putting needles into holding position for Short Rows. The

Symbol  on the Charts is used to put needles back into working position when knitting Short Rows.

A number in a box stands for the number of rows to be knitted between shapings. Make shapings first, then knit the necessary number of rows. If for instance it reads:

1 st. 8 x



1 st. 10 x



As you will be reading the instructions from the bottom up, here is the way you will follow them: . . . Decrease or increase (depending on the direction of the garment outline) 1 st. at the row where the shapings begins, then knit 8 rows, make the next decrease, then knit 8 rows, until you have decreased (or increased) 1 st. 10 x and you have knitted 8 rows after each decrease (or increase) (1 st. 10 x +8 rows 10 x). Now begin the first decrease (or increase) for the shapings (which has to be made 8 x) in every 6th row. Decrease (or increase) 1 st. first, then knit 6 rows until you have decreased 1 st. 6 x and after each decrease (or increase) have knitted 6 rows (1 st. 8 x + 6 rows 8 x).

Where shapings are given without a boxed number as on most armholes, necklines, etc., make the shapings on every second row (on each side of course).

(See below for more Pattern Stitch Symbols.)

### PATTERN STITCH SYMBOLS



= knit stitch



= purl stitch



= empty needle (leave in working position)



= needle not used (in the out of work position)



= needle in the holding position



= Needles back into working position.



= 2 stitches on 1 needle - either transferred from the right side or the left side, then put the needle into holding position



= needle holding 2 stitches. Stitch has been transferred from the LEFT



= needle holding 2 stitches. Stitch has been transferred from the RIGHT



= 3 stitches on 1 needle. The 1st and 3rd stitch in a group of 3 needles has been hung on the 2nd or center needle.



= Center of Garment Section.



= Number of rows to be knitted between shapings.

The diagrams (Line Drawings) for pattern work are followed just as they are shown and are to be read as you look at them while knitting the garment.

open darts



closed darts





YARNS  
by



# knitking



Send \$1.00 for LARGE COMPLETE YARN CATALOGUE  
(Refunded on your first \$10.00 order) to:

KNITKING YARNS, Dept. 19  
1128 Crenshaw Boulevard  
Los Angeles, California 90019