

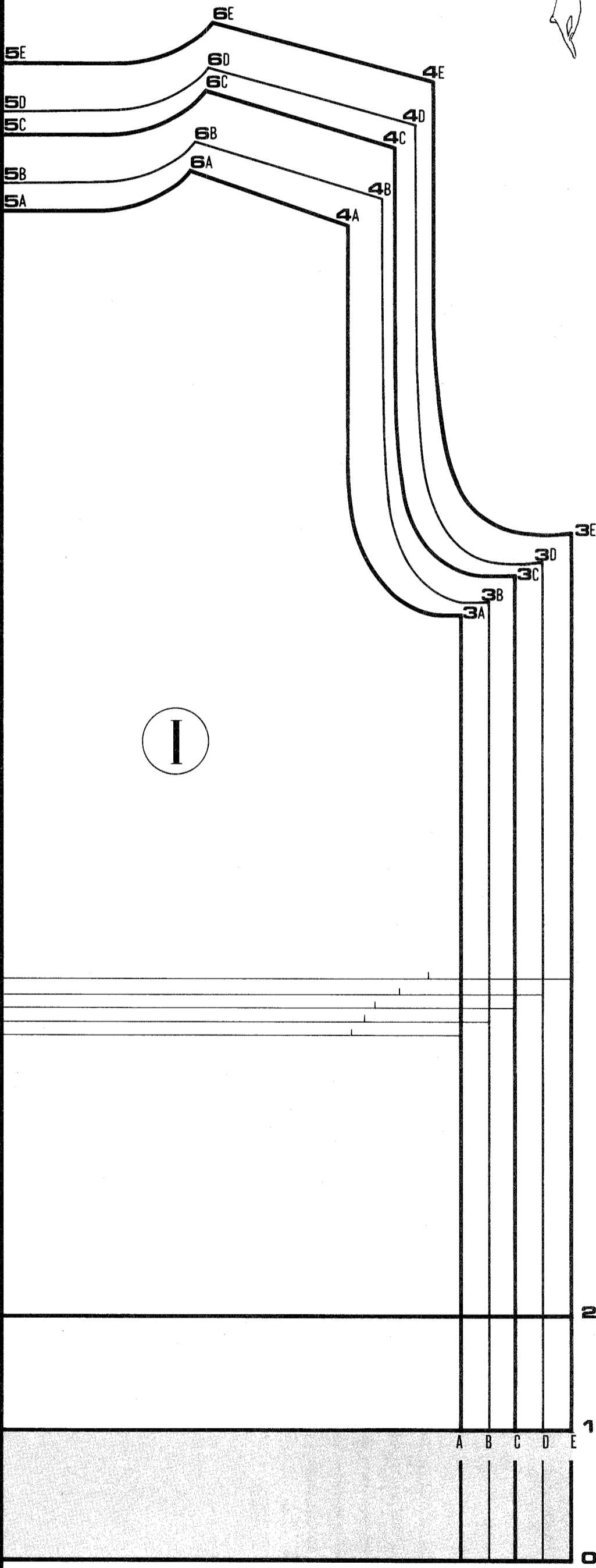

A-1



A-1

	A	B	C	D	E
	81cm (32")	86cm (34")	91cm (36")	96cm (38")	101cm (40")
	84 (33)	89 (35)	94 (37)	99 (39)	104 (41)
	55.5 (21 ³ / ₄)	56.5 (22 ¹ / ₄)	59 (23 ¹ / ₄)	60 (23 ⁵ / ₈)	62 (24 ³ / ₈)
	31.5 (12 ³ / ₈)	34.5 (13 ¹ / ₂)	35.5 (14)	37.5 (14 ³ / ₄)	39 (15 ³ / ₈)
	53 (20 ⁷ / ₈)	54.5 (21 ¹ / ₂)	56 (22 ¹ / ₈)	57 (22 ¹ / ₂)	58 (22 ⁷ / ₈)

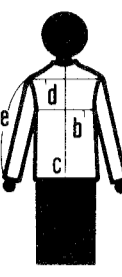
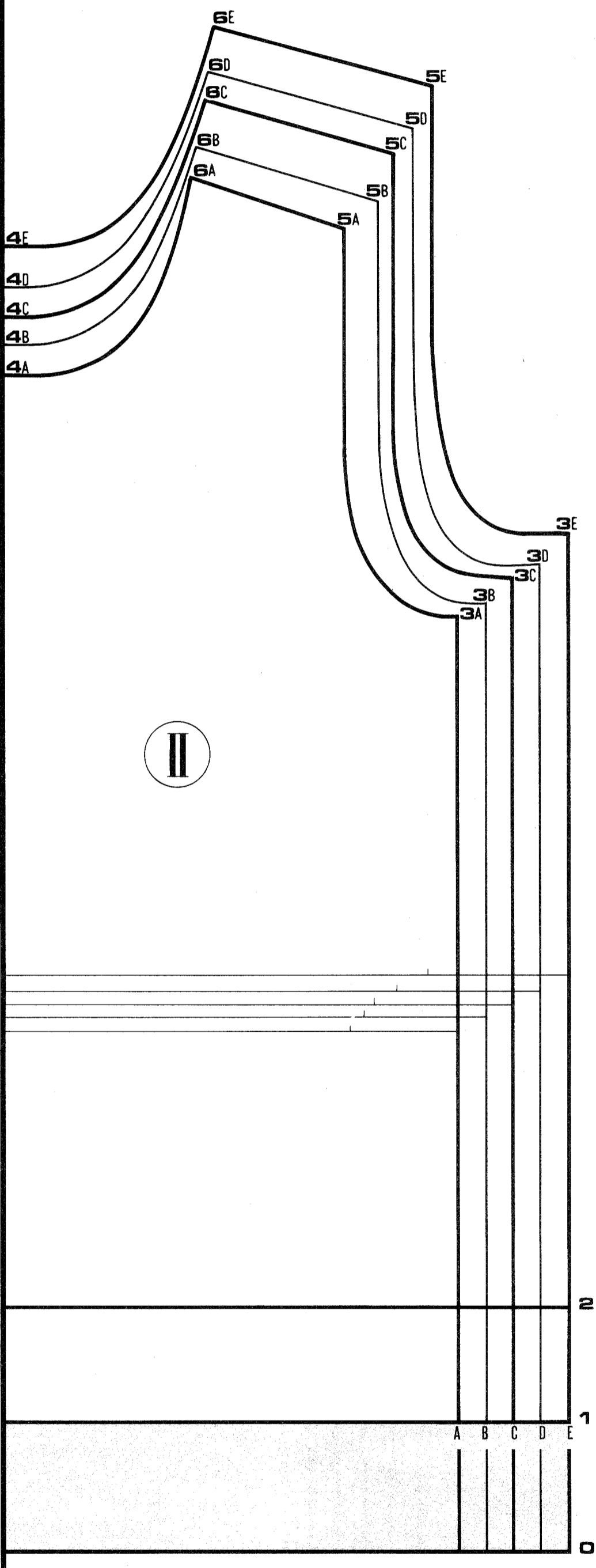

A-1

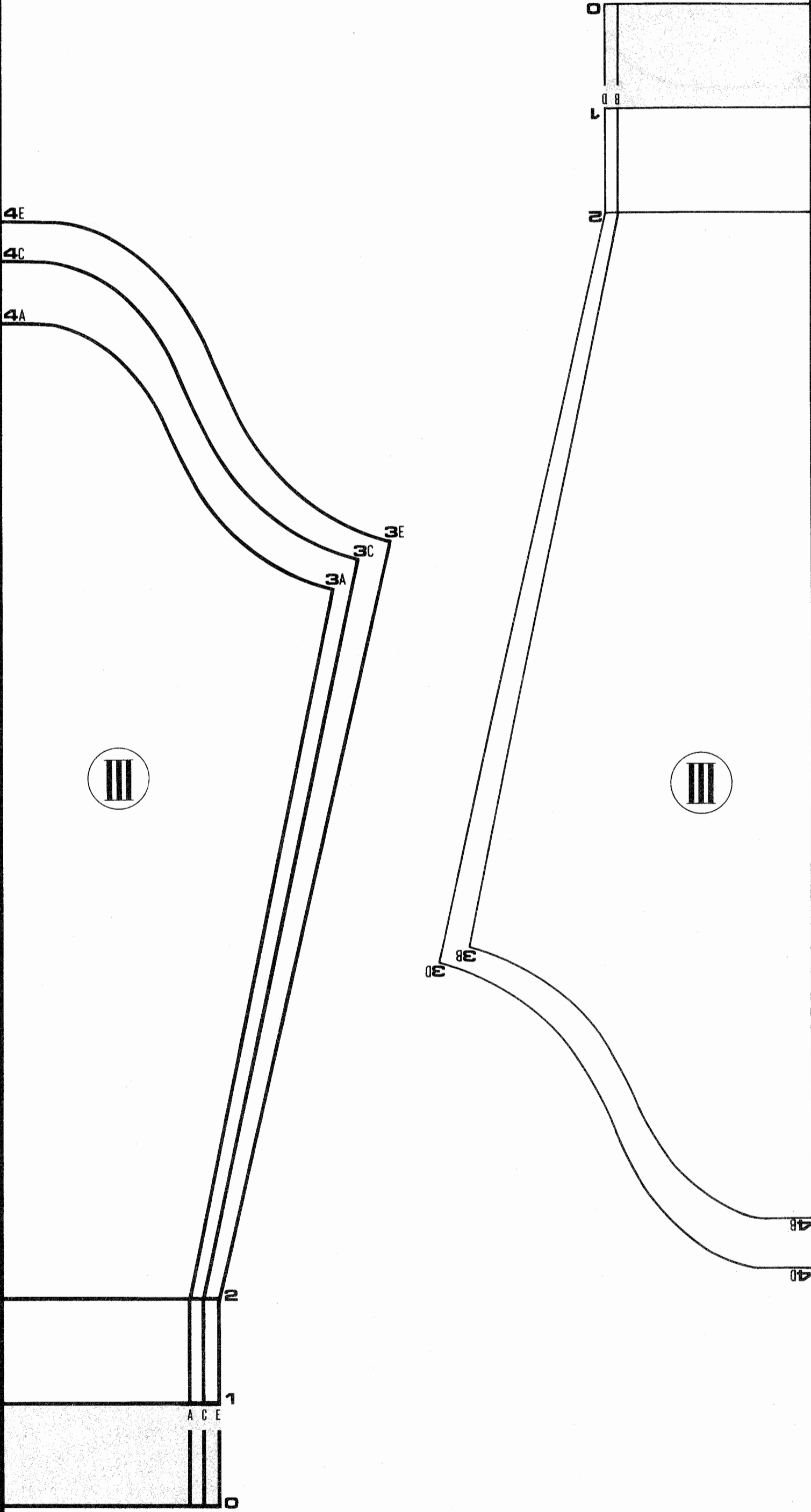
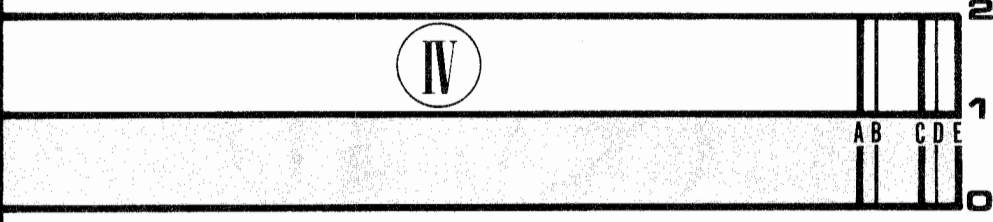

A-2

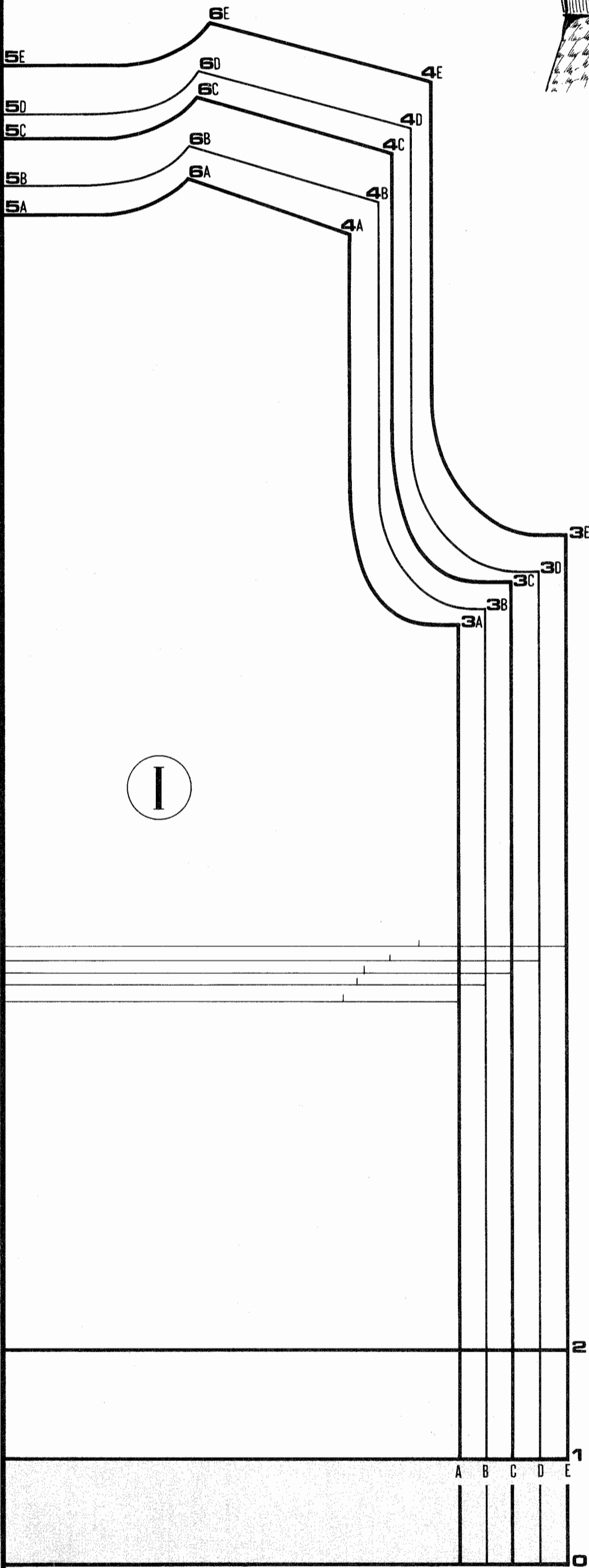

A-2

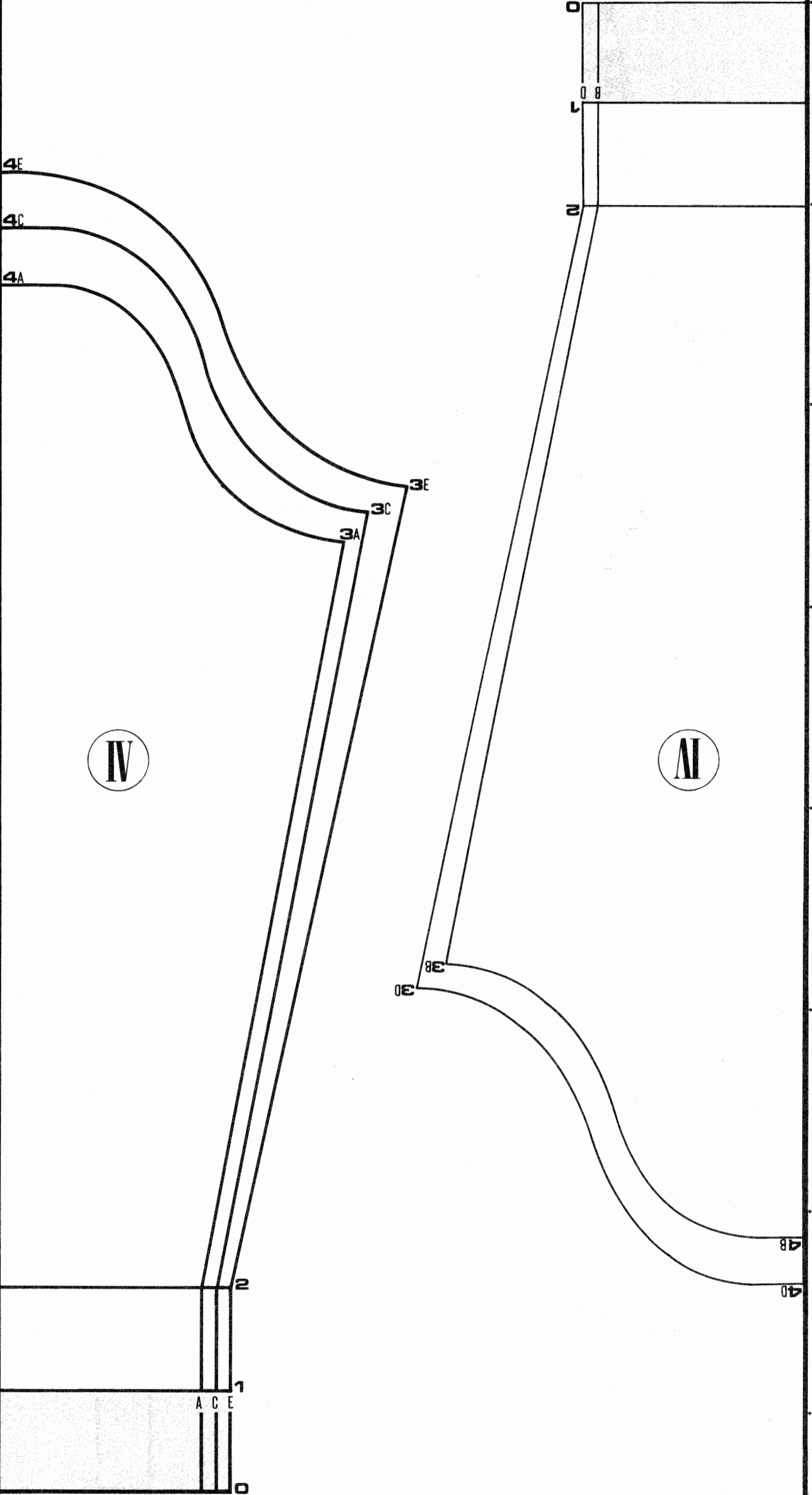
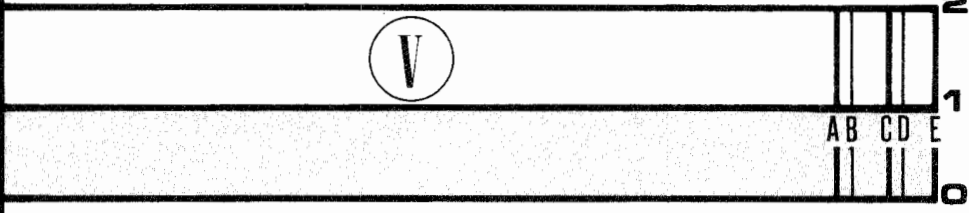

A-2

	A	B	C	D	E
a	81cm (32")	86cm (34")	91cm (36")	96cm (38")	101cm (40")
b	86 (34)	91 (36)	96 (38)	101 (40)	106 (42)
c	59 (23 $\frac{1}{4}$)	60 (23 $\frac{5}{8}$)	62.5 (24 $\frac{1}{2}$)	63.5 (25)	66 (26)
d	33 (13)	35.5 (14)	37 (14 $\frac{1}{2}$)	38.5 (15 $\frac{1}{4}$)	40.5 (16)
e	55 (21 $\frac{5}{8}$)	56.5 (22 $\frac{1}{4}$)	57.5 (22 $\frac{5}{8}$)	58.5 (23)	60.5 (23 $\frac{3}{4}$)

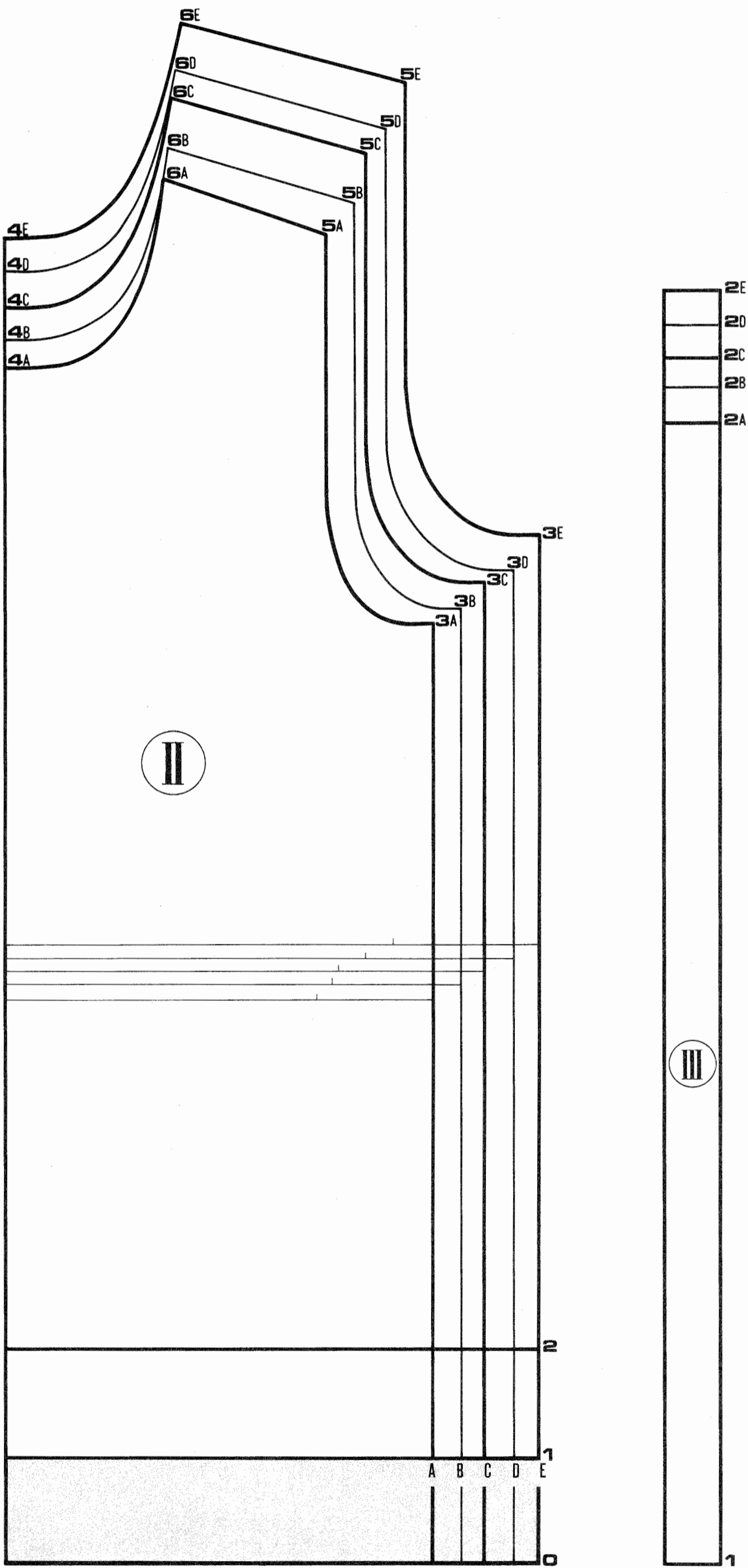
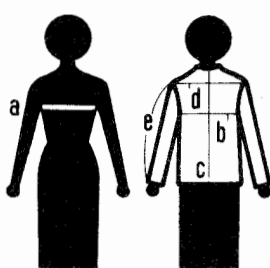

A-3

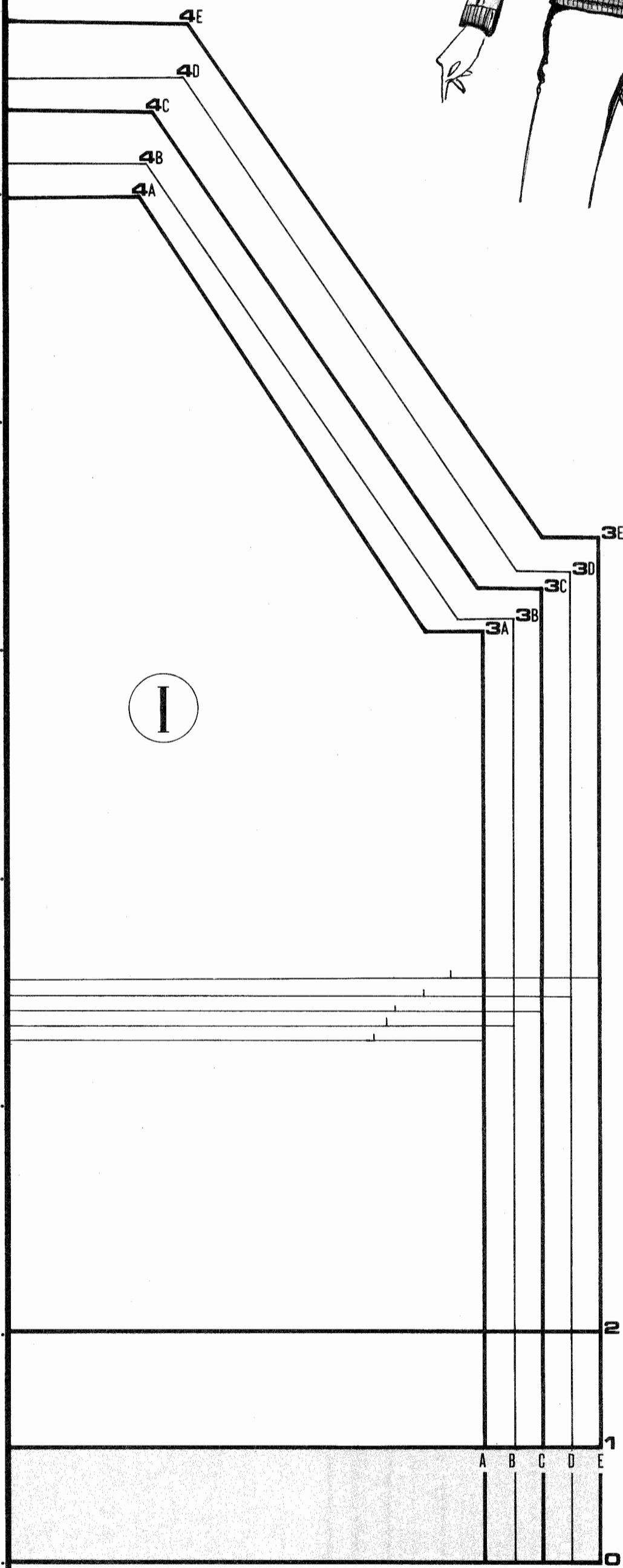
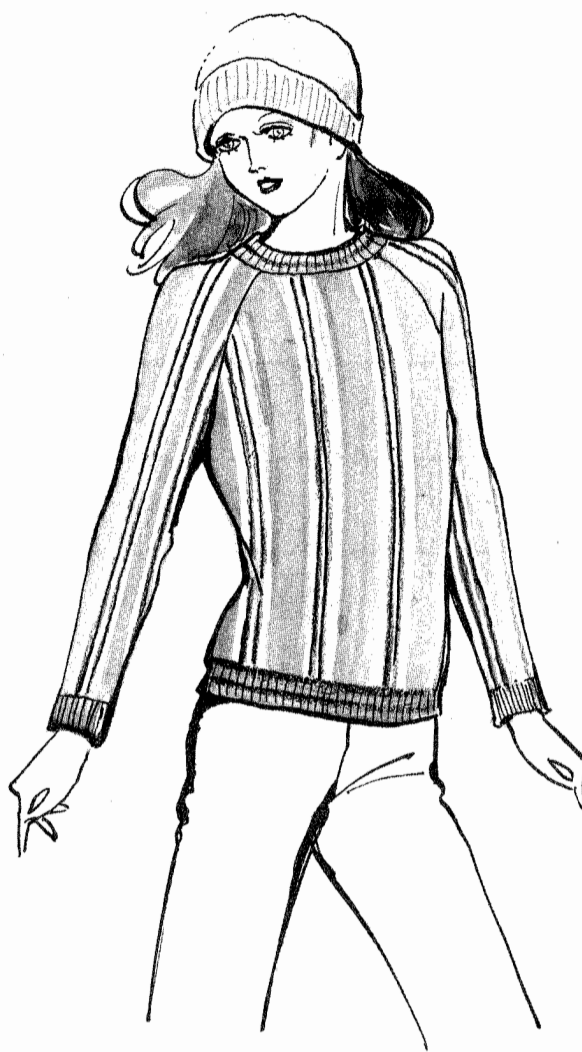

A-3

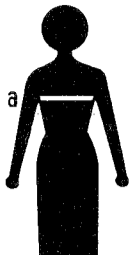
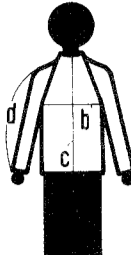
	A	B	C	D	E
	81cm (32")	86cm (34")	91cm (36")	96cm (38")	101cm (40")
	84 (33)	89 (35)	94 (37)	99 (39)	104 (41)
	55.5 (21 ³ / ₄)	56.5 (22 ¹ / ₄)	59 (23 ¹ / ₄)	60 (23 ⁵ / ₈)	62 (24 ³ / ₈)
	53 (20 ⁷ / ₈)	54.5 (21 ¹ / ₂)	56 (22 ¹ / ₈)	57 (22 ¹ / ₂)	58 (22 ⁷ / ₈)

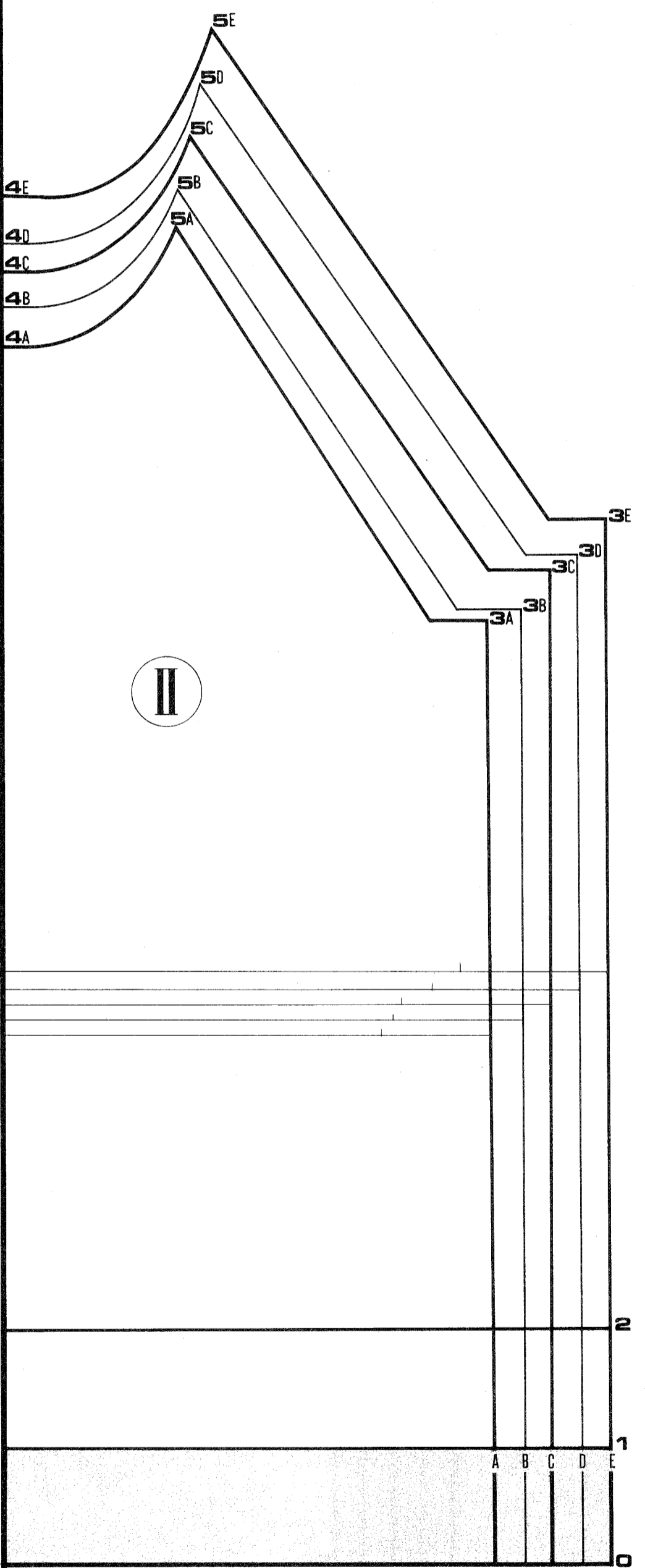
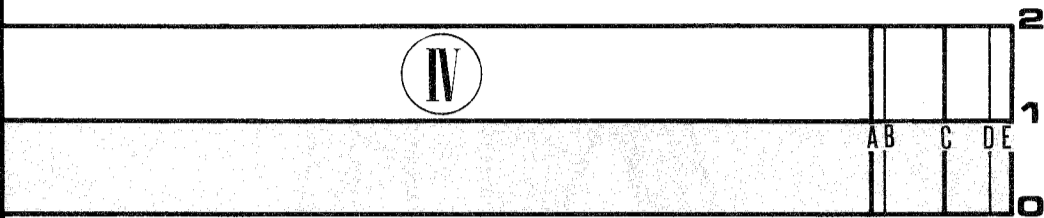

A-4

	A	B	C	D	E
a	86cm (34")	91cm (36")	96cm (38")	102cm (40")	107cm (42")
b	89 (35)	94 (37)	99 (39)	104 (41)	109 (43)
c	68.5 (27)	71 (28)	73.5 (29)	79 (31)	84 (33)
d	56.5 (22 1/4)	57.5 (22 5/8)	58.5 (23)	59.5 (23 3/8)	60.5 (23 3/4)

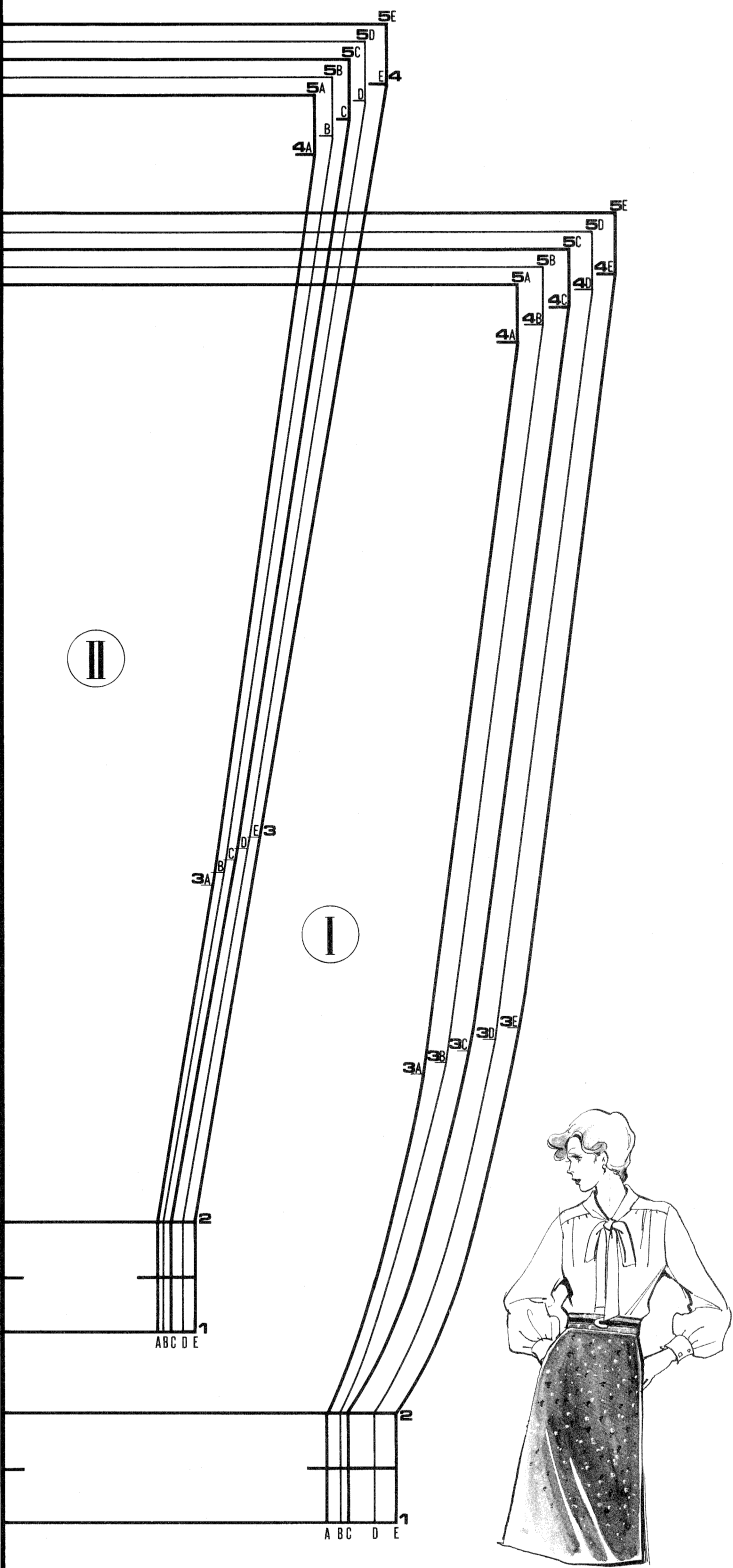
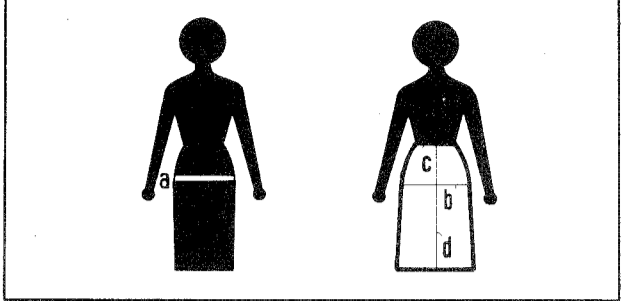

A-3

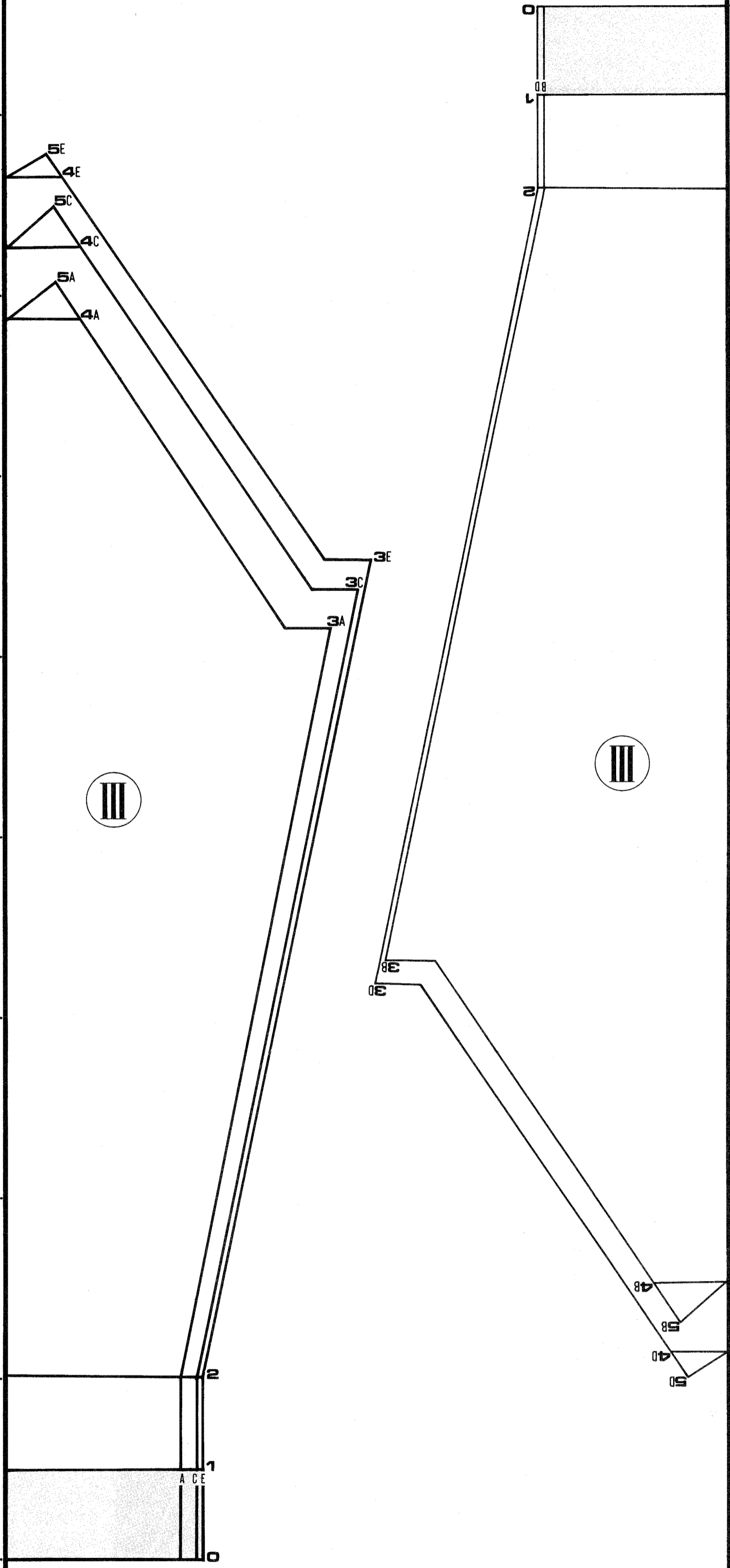

A-5

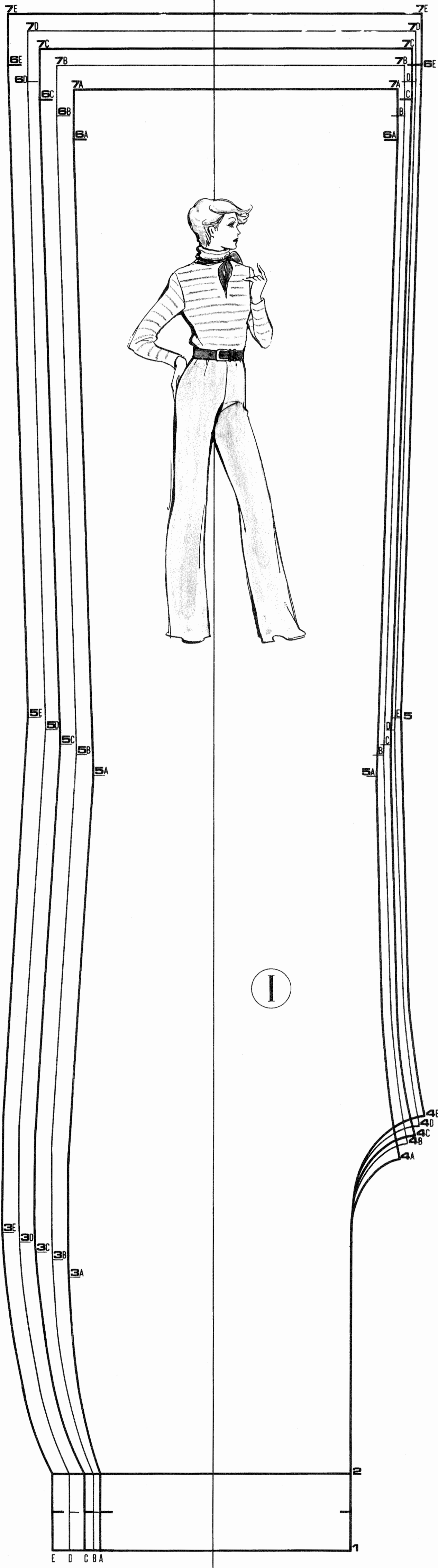

A-5

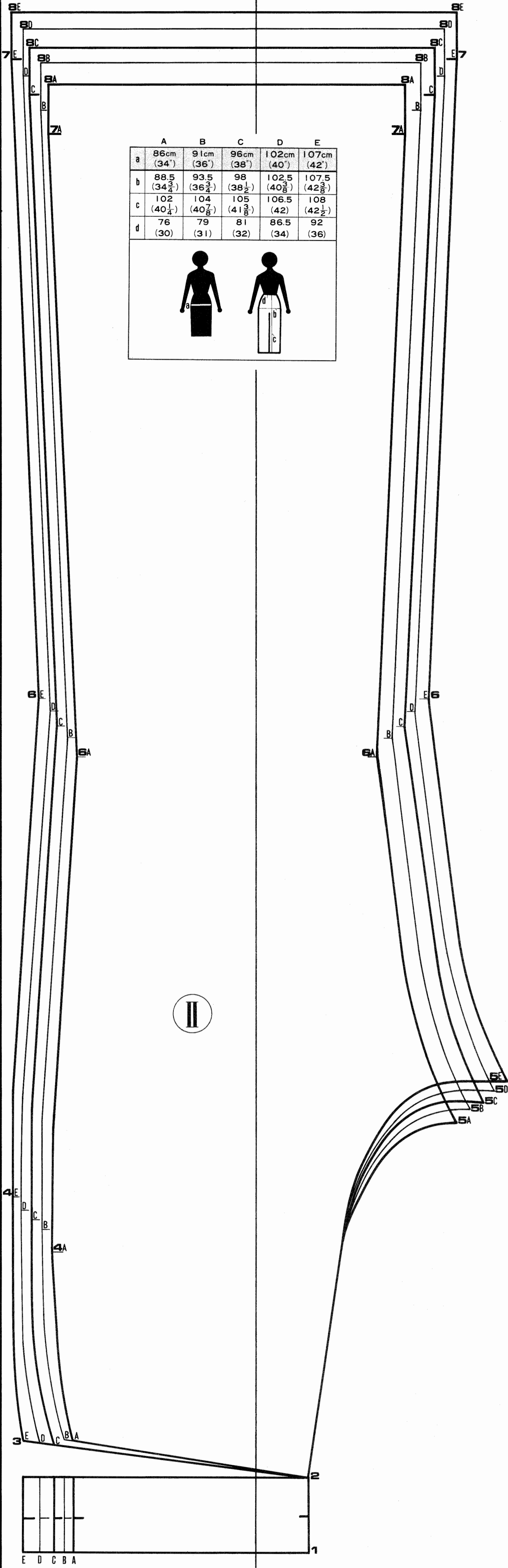

II



A-6

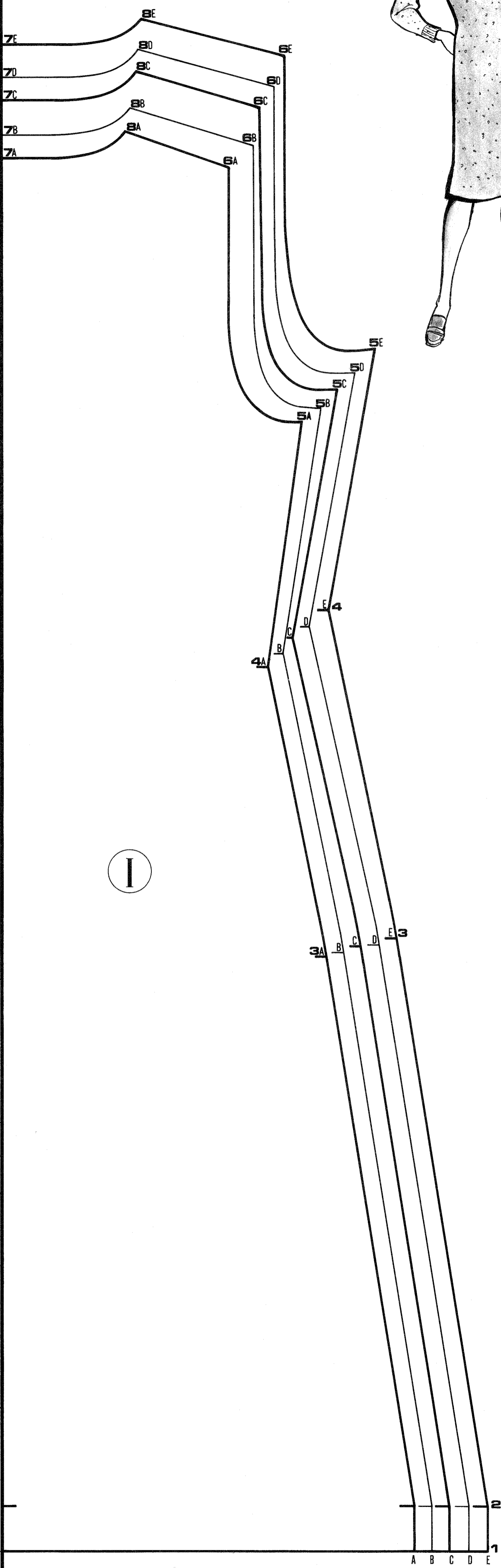

A-6

	A	B	C	D	E
a	81cm (32")	86cm (34")	91cm (36")	96cm (38")	101cm (40")
b	84 (33)	89 (35)	94 (37)	99 (39)	104 (41)
c	94 (37)	96 (37 $\frac{3}{4}$)	98 (38 $\frac{5}{8}$)	100 (39 $\frac{1}{4}$)	102 (40 $\frac{1}{4}$)
d	31.5 (12 $\frac{1}{4}$)	34.5 (13 $\frac{1}{2}$)	35.5 (14)	37.5 (14 $\frac{3}{4}$)	39 (15 $\frac{3}{8}$)
e	53.5 (21)	55 (21 $\frac{5}{8}$)	56 (22 $\frac{1}{8}$)	57.5 (22 $\frac{1}{2}$)	59 (23 $\frac{1}{8}$)
f	89 (35)	94 (37)	99 (39)	104 (41)	109 (43)

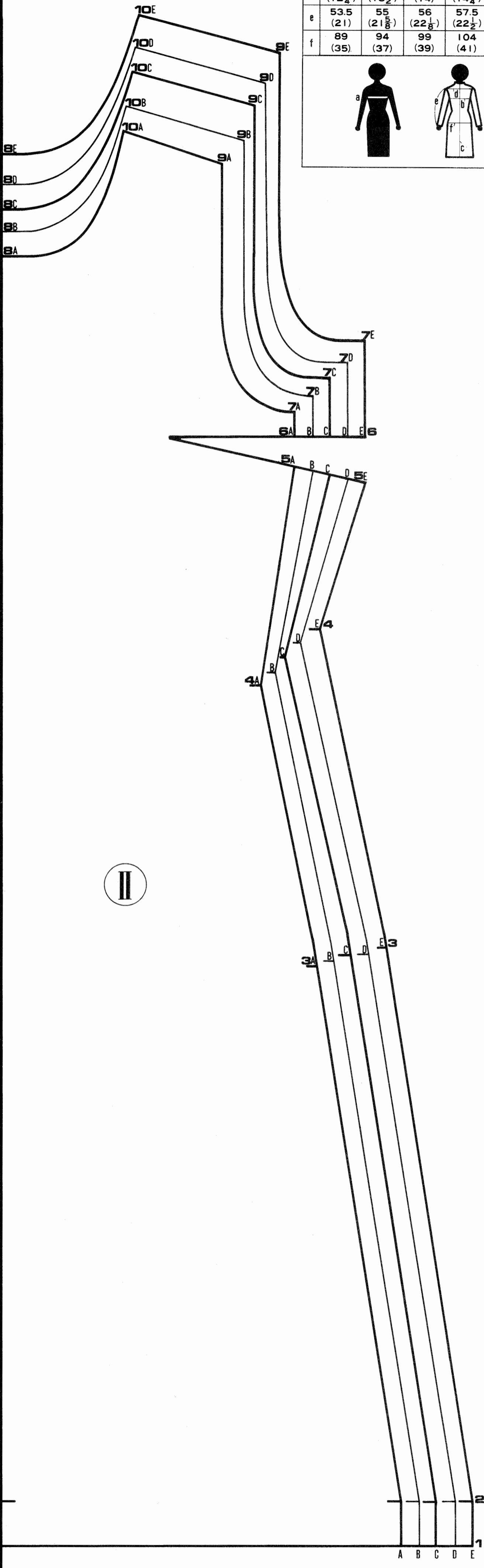
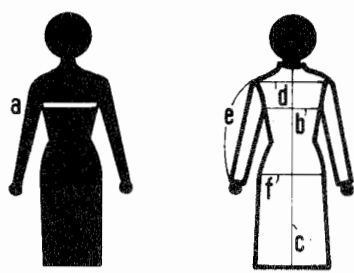

II



A-6



IV

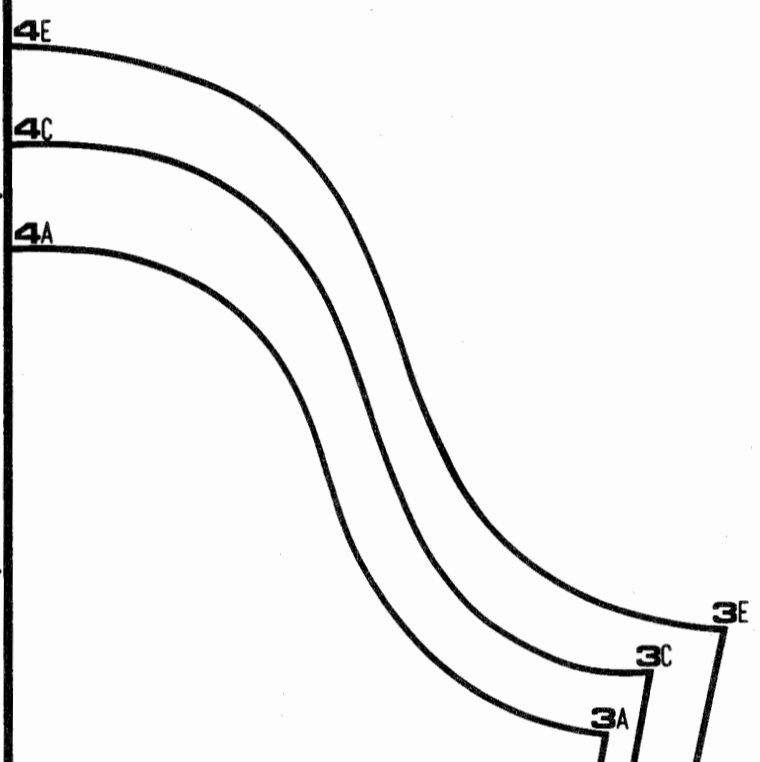
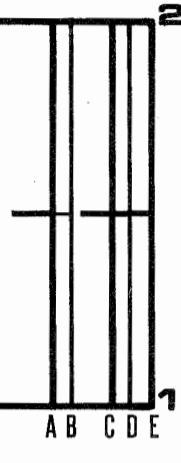

III

III

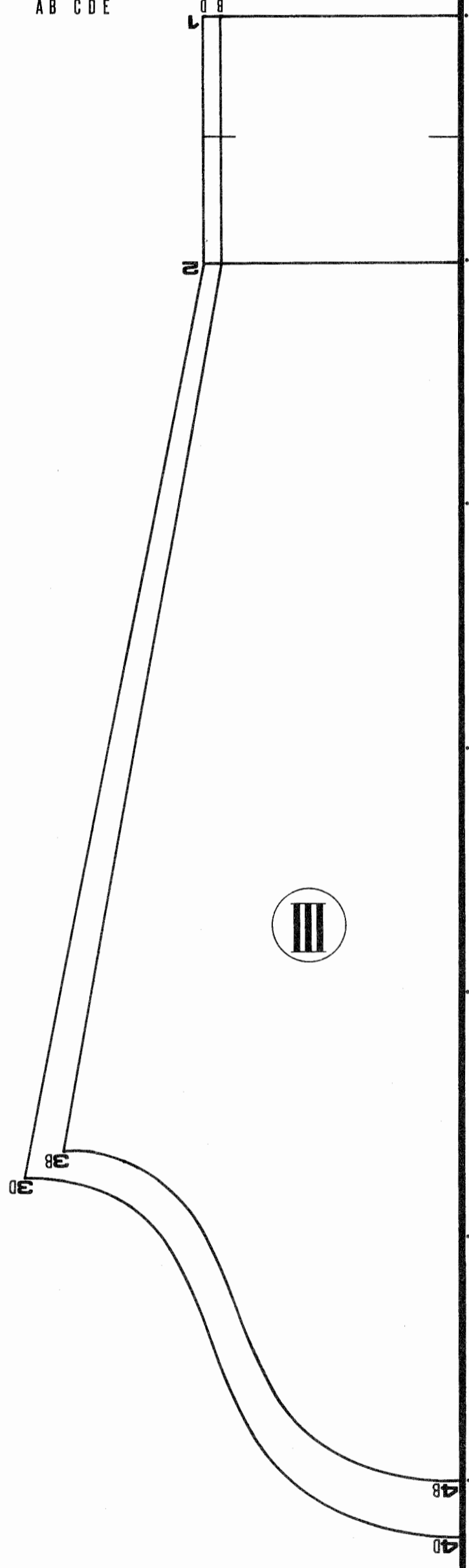

B-1

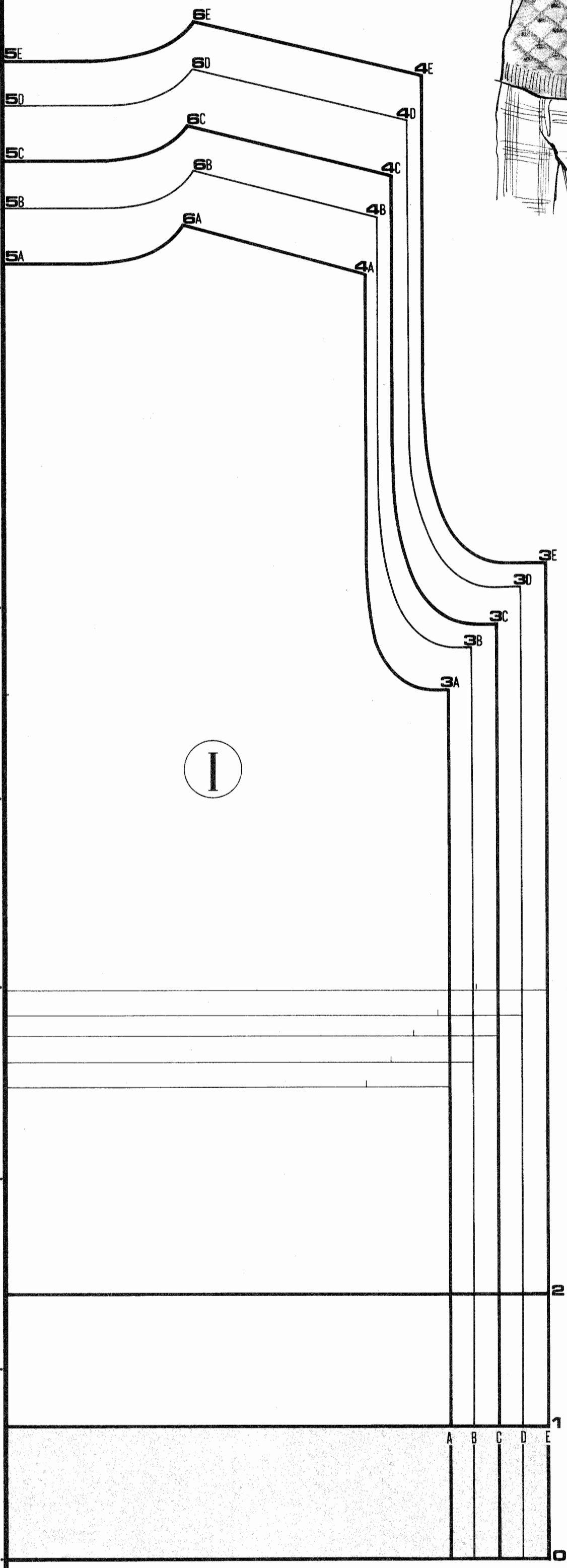

B-1

	A	B	C	D	E
a	91cm (36")	96cm (38")	101cm (40")	106cm (42")	112cm (44")
b	94 (37)	99 (39)	104 (41)	109 (43)	114 (45)
c	61 (24)	64 (25 $\frac{1}{4}$)	66.5 (26 $\frac{1}{4}$)	69.5 (27 $\frac{3}{8}$)	71.5 (28 $\frac{1}{8}$)
d	38 (15)	39.5 (15 $\frac{1}{2}$)	40.5 (16)	42.5 (16 $\frac{3}{4}$)	44 (17 $\frac{3}{8}$)
e	58 (22 $\frac{3}{4}$)	59 (23 $\frac{1}{4}$)	61 (24)	63 (24 $\frac{3}{4}$)	65 (25 $\frac{1}{2}$)

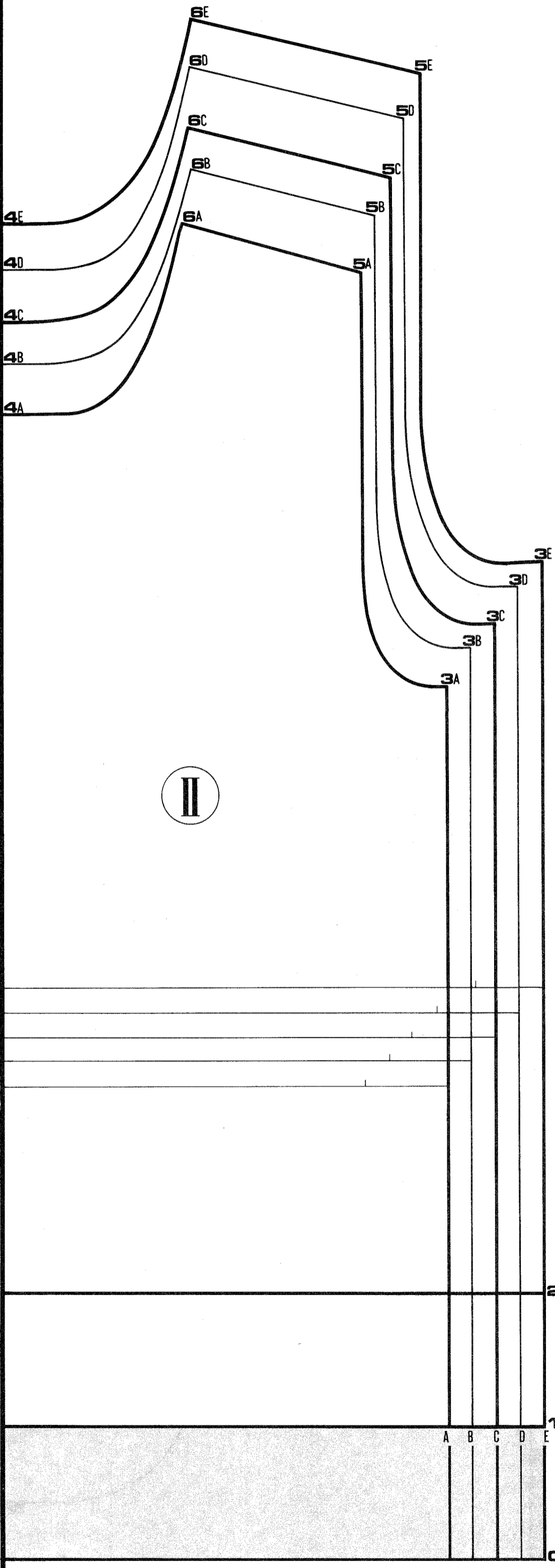
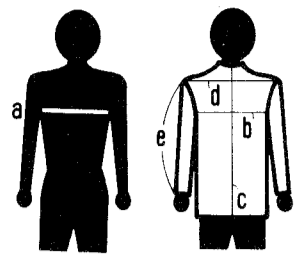

B-1



IV

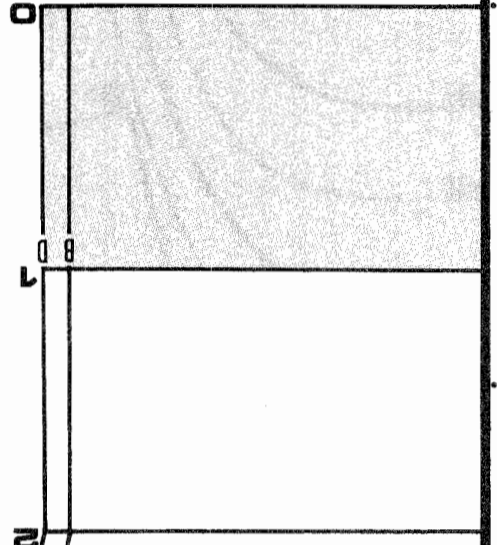
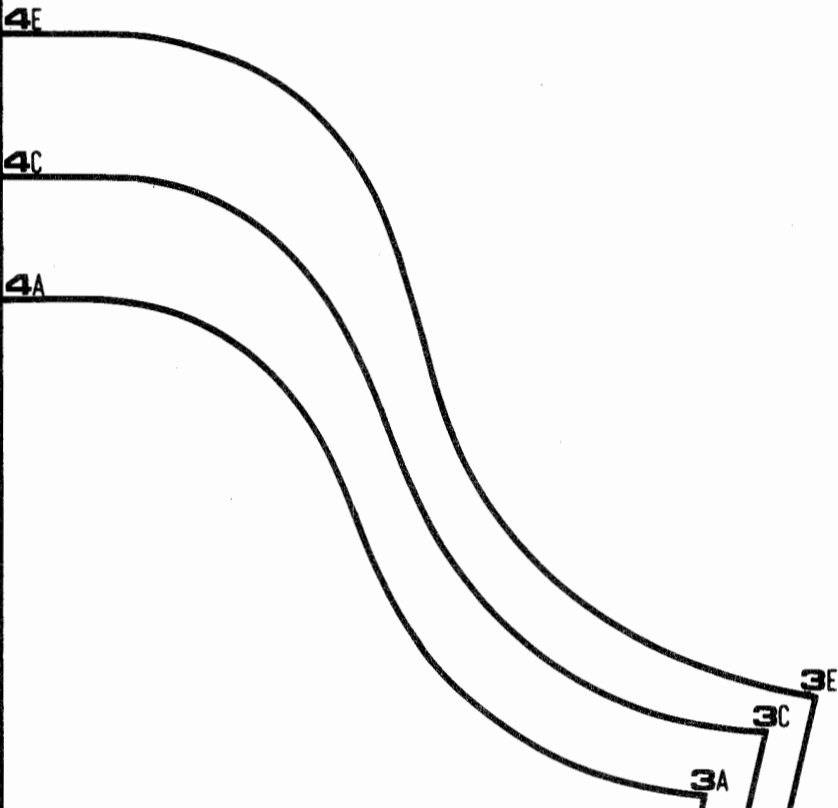

III

III

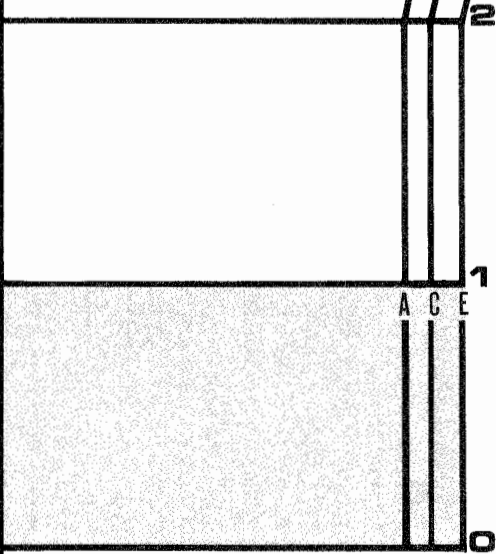
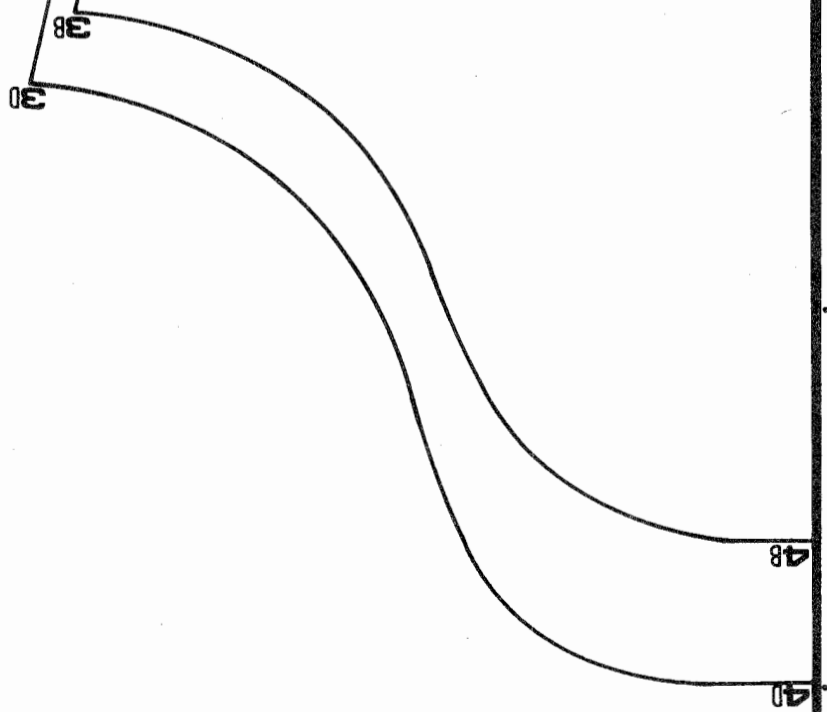

B-2

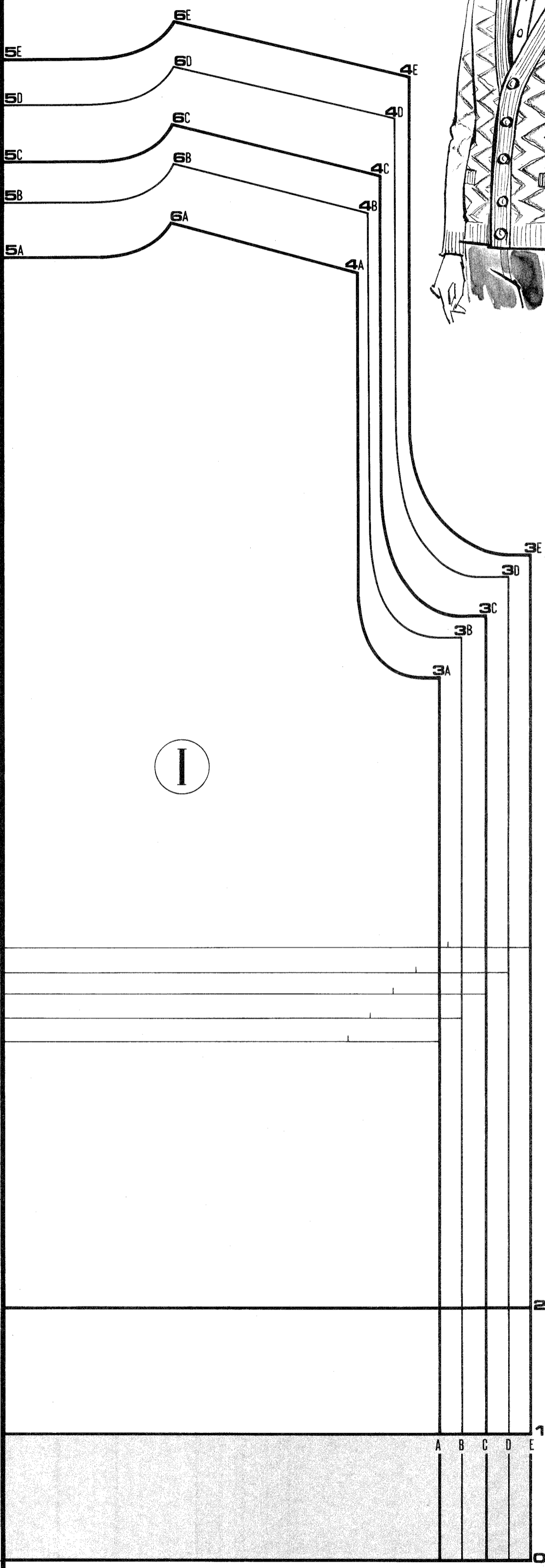

B-2

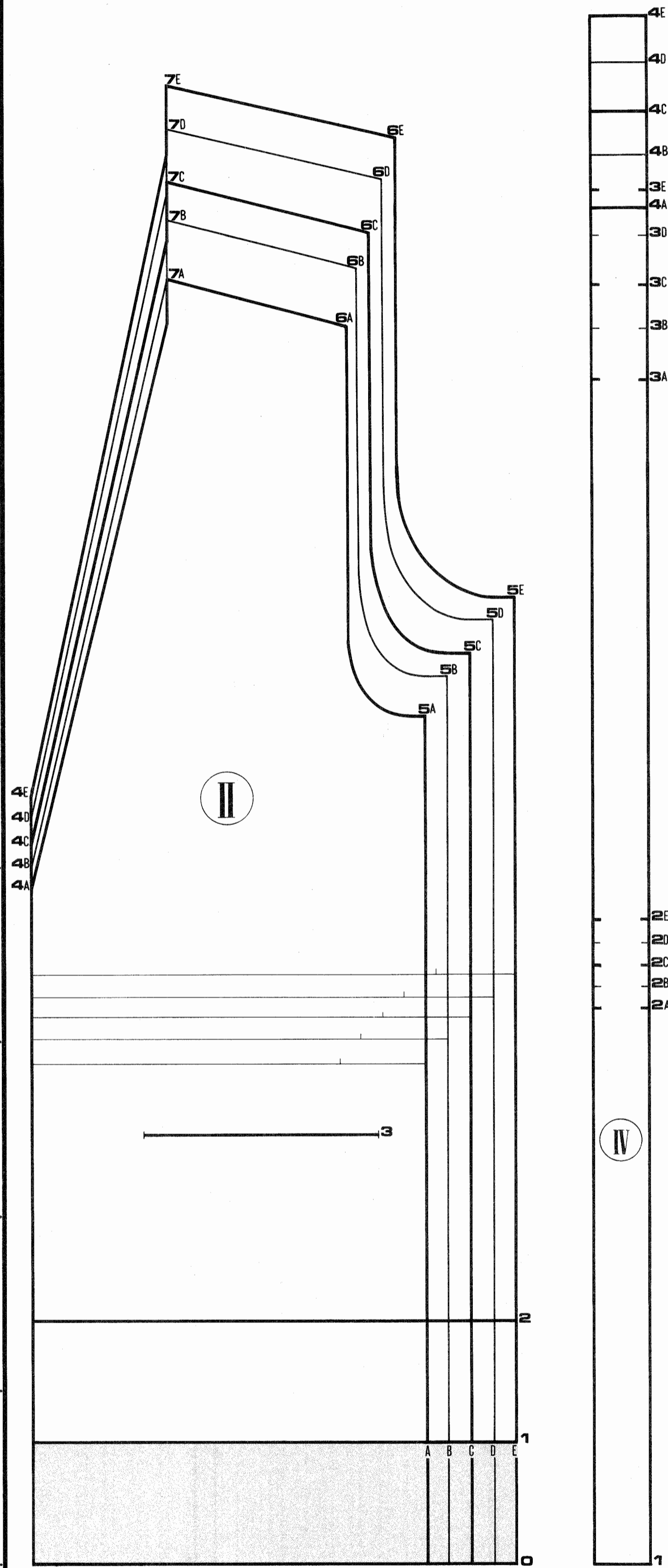
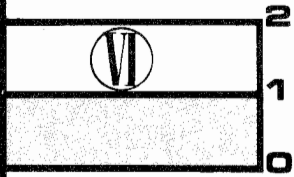

B-2



	A	B	C	D	E
a	91cm (36")	96cm (38")	101cm (40")	106cm (42")	112cm (44")
b	96.5 (38)	101.5 (40)	106.5 (42)	112 (44)	117 (46)
c	65 (25 ⁵ / ₈)	68 (26 ³ / ₄)	70.5 (27 ³ / ₄)	73.5 (28 ⁷ / ₈)	76 (29 ⁷ / ₈)
d	39 (15 ³ / ₈)	40.5 (16)	42 (16 ¹ / ₂)	43 (17)	45 (17 ³ / ₄)
e	59 (23 ¹ / ₄)	60.5 (23 ³ / ₄)	62 (24 ¹ / ₂)	64 (25 ¹ / ₄)	66 (26)

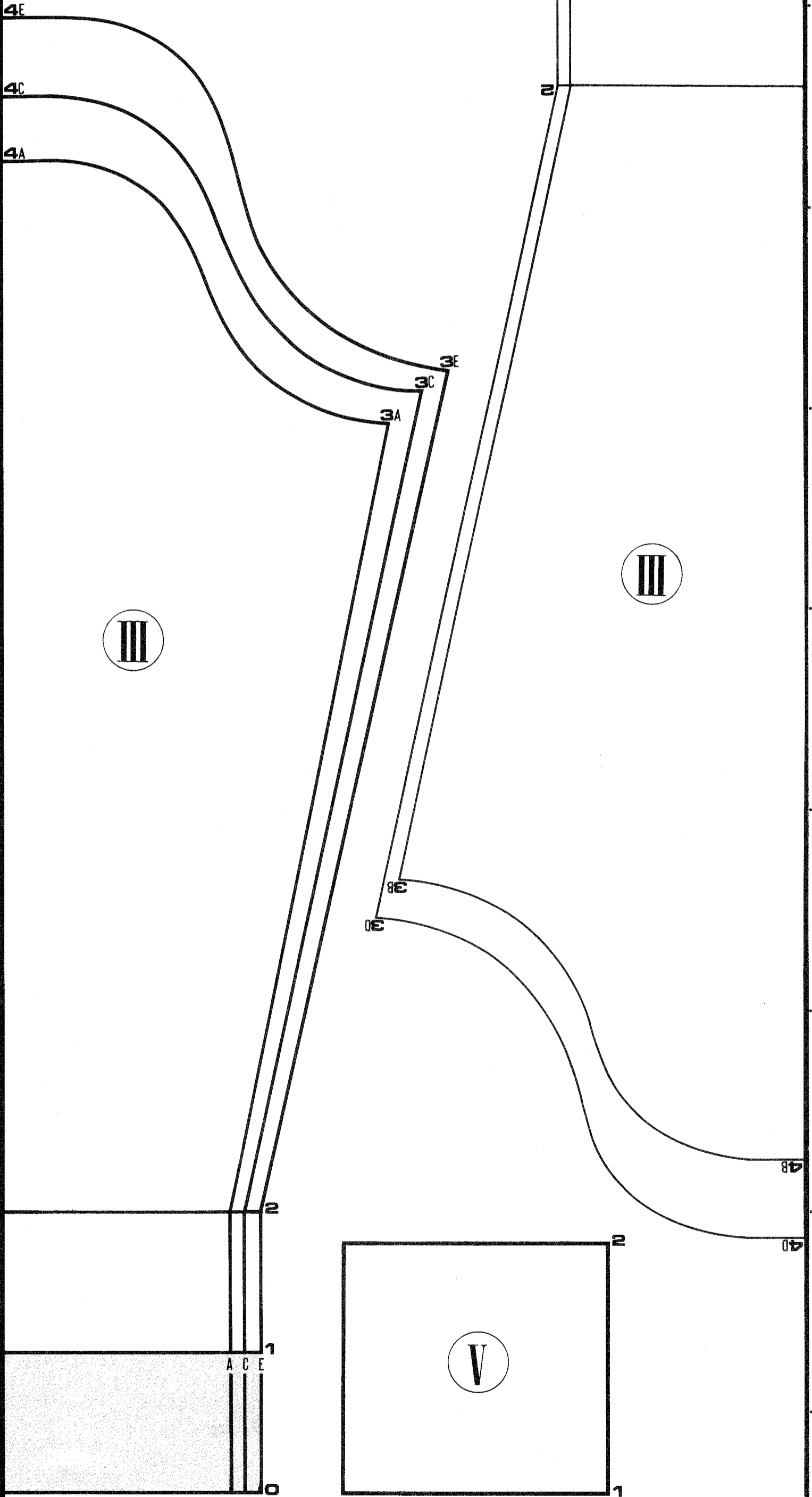
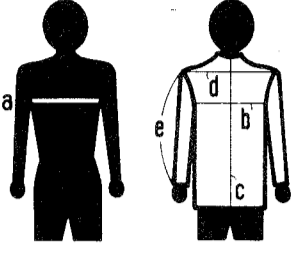

B-3

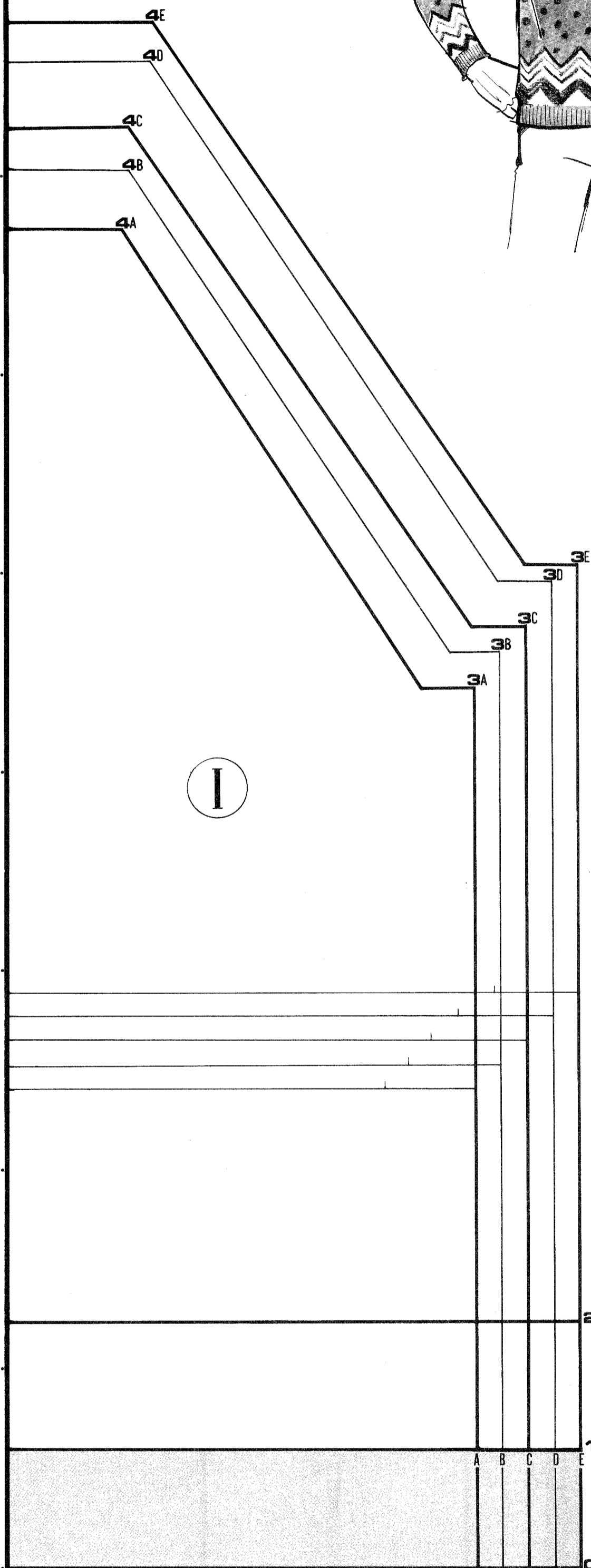

B-3

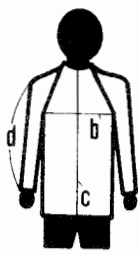
	A	B	C	D	E
	91cm (36")	96cm (38")	101cm (40")	106cm (42")	112cm (44")
	94 (37)	99 (39)	104 (41)	109 (43)	114 (45)
	61 (24)	64 (25 1/4)	66.5 (26 1/4)	69.5 (27 3/8)	71.5 (28 1/8)
	58 (22 3/4)	59 (23 1/4)	61 (24)	63 (24 3/4)	65 (25 1/2)

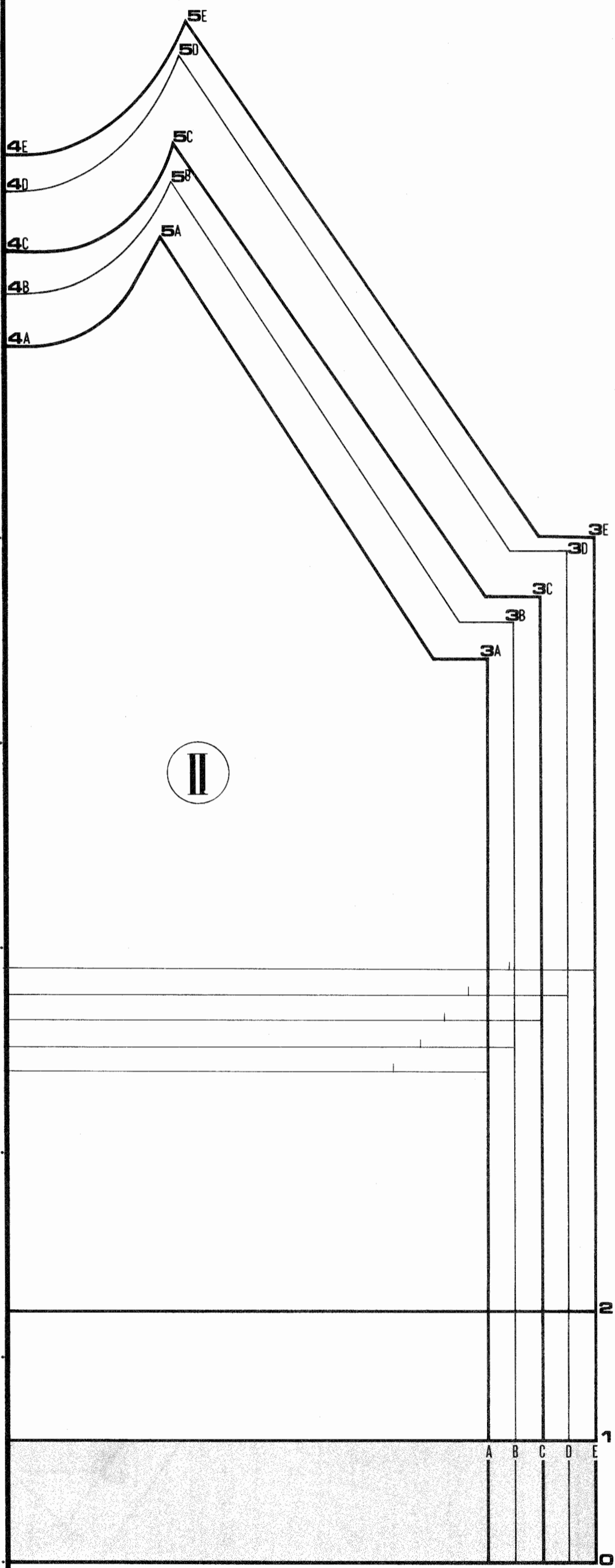
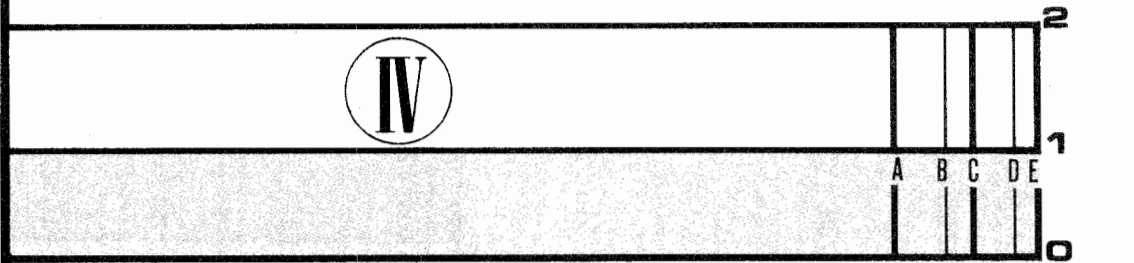

B-3

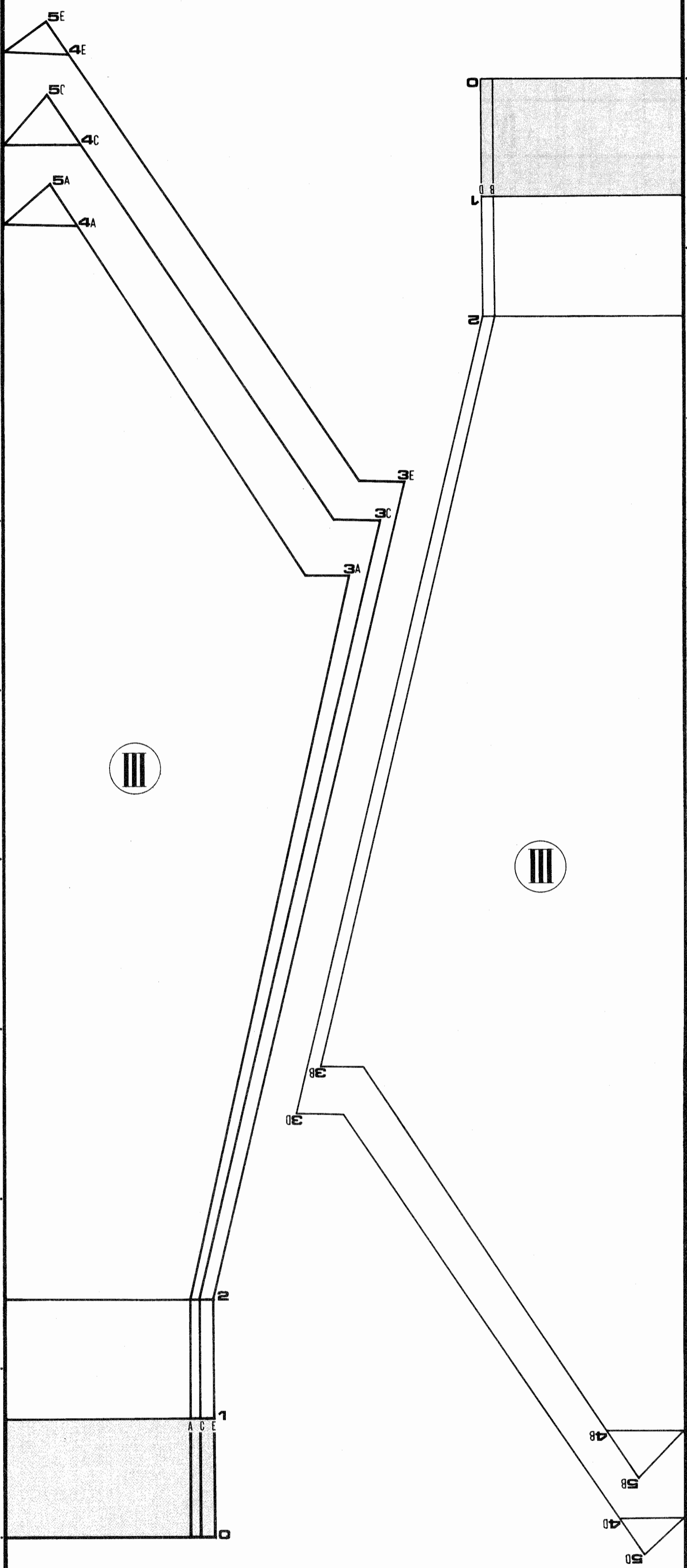

C-1

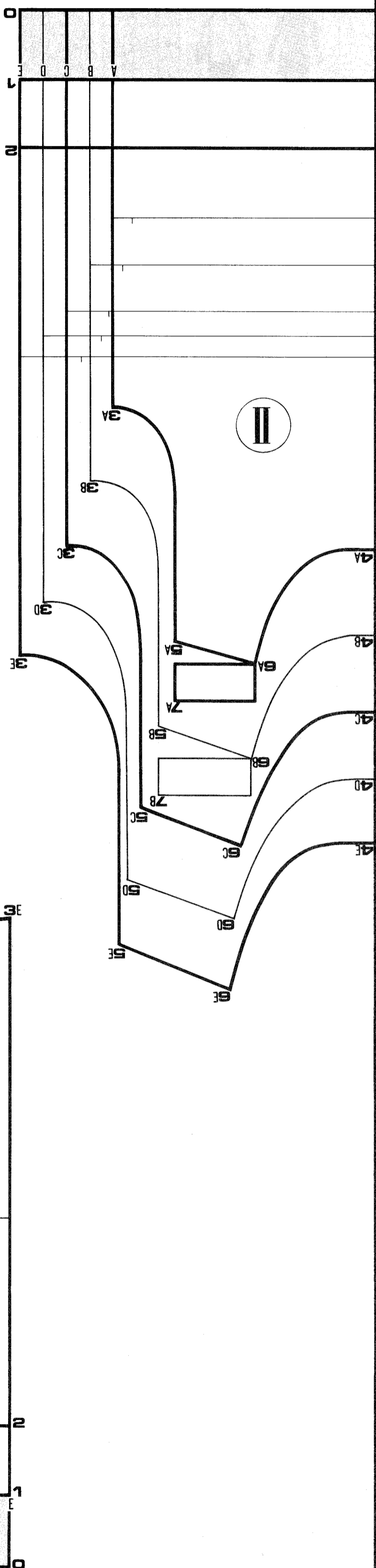

I

II



C-1

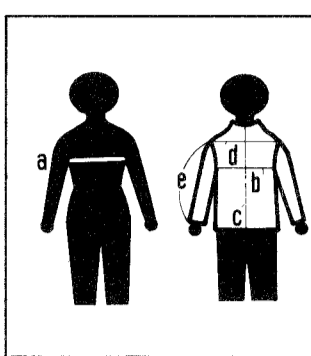

	A	B	C	D	E
a	56cm (22")	61cm (24")	66cm (26")	71cm (28")	76cm (30")
b	58.5 (23)	63.5 (25)	68.5 (27)	73.5 (29)	79 (31)
c	31 (12 1/4)	36.5 (14 3/8)	41.5 (16 3/8)	45.5 (18)	49.5 (19 1/2)
d	22 (8 3/4)	24 (9 1/2)	26 (10 1/4)	27.5 (10 3/4)	28.5 (11 1/4)
e	29 (11 1/2)	36 (14 1/4)	42 (16 1/2)	46 (18 1/8)	51 (20)

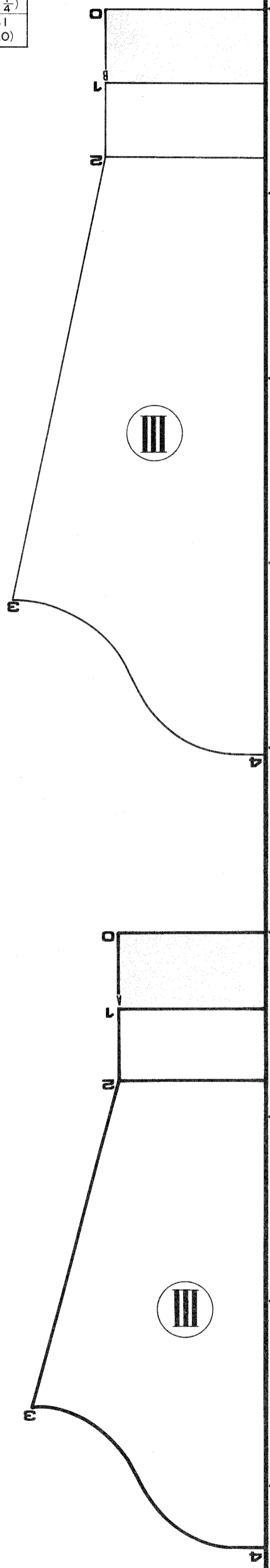
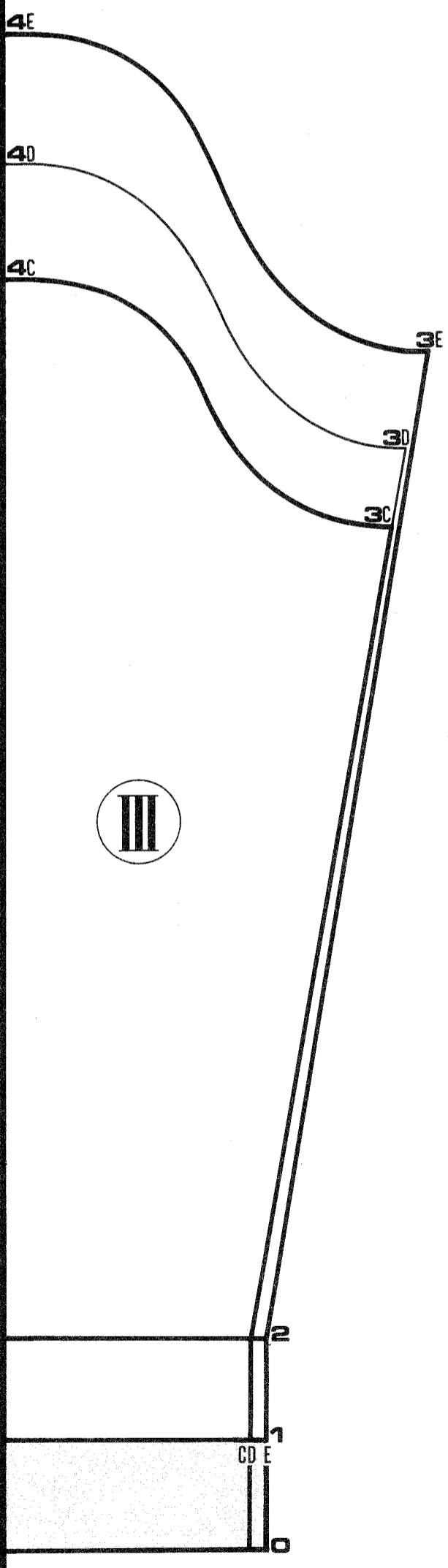
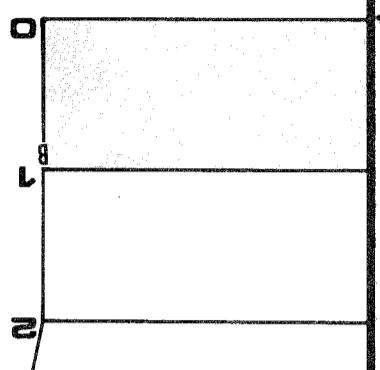
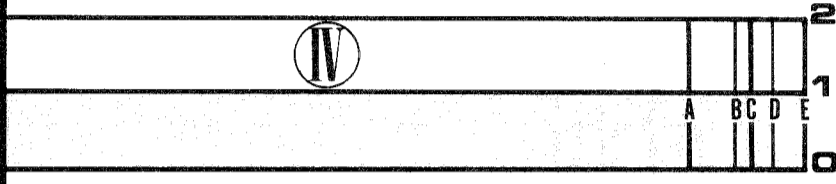

C-2

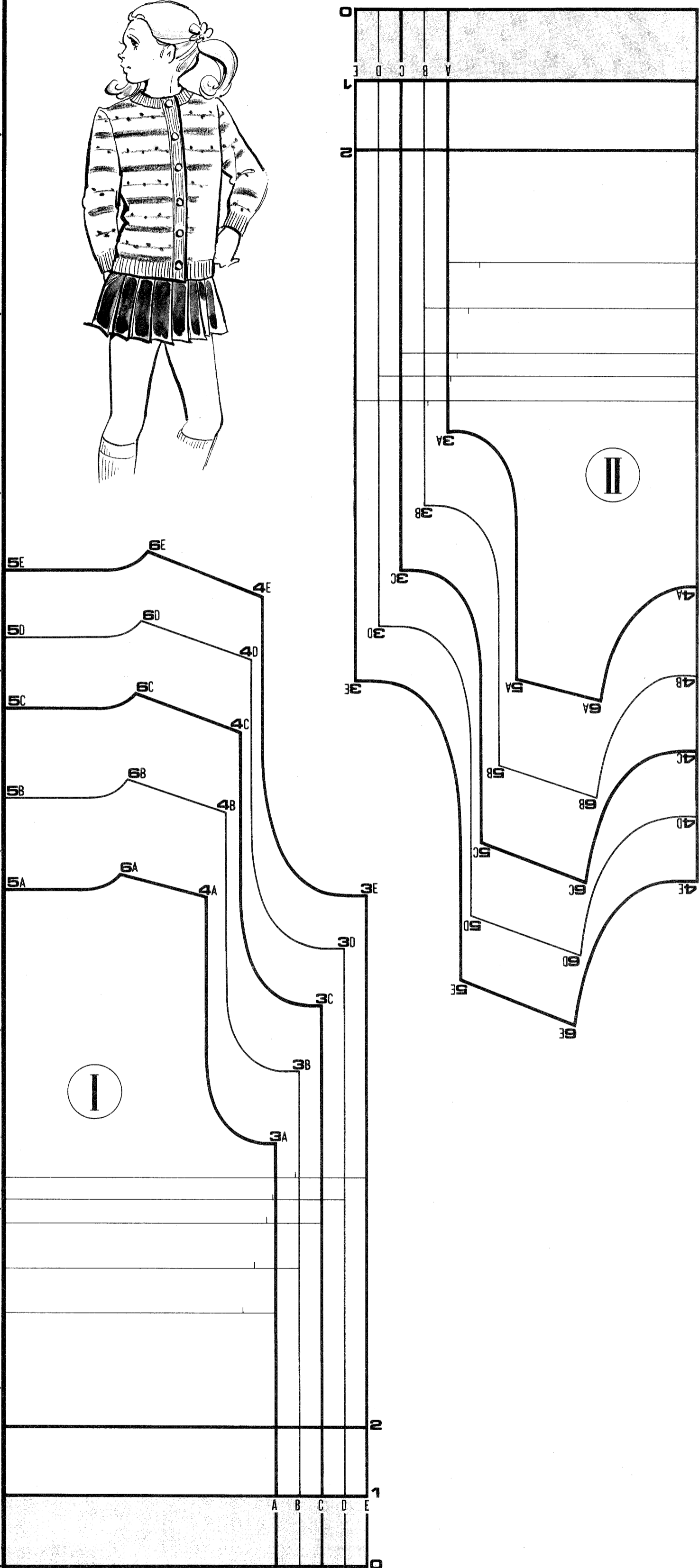

C-2



	A	B	C	D	E
a	56cm (22")	61cm (24")	66cm (26")	71cm (28")	76cm (30")
b	61 (24)	66 (26)	71 (28)	76 (30)	81 (32)
c	34 (13 ³ / ₈)	39 (15 ³ / ₈)	44 (17 ³ / ₈)	48 (19)	51.5 (20 ¹ / ₄)
d	22.5 (8 ⁷ / ₈)	24.5 (9 ³ / ₄)	26.5 (10 ¹ / ₂)	27.5 (10 ³ / ₄)	29 (11 ¹ / ₂)
e	30 (11 ⁷ / ₈)	37 (14 ⁵ / ₈)	43 (16 ⁷ / ₈)	47 (18 ¹ / ₂)	52 (20 ³ / ₈)

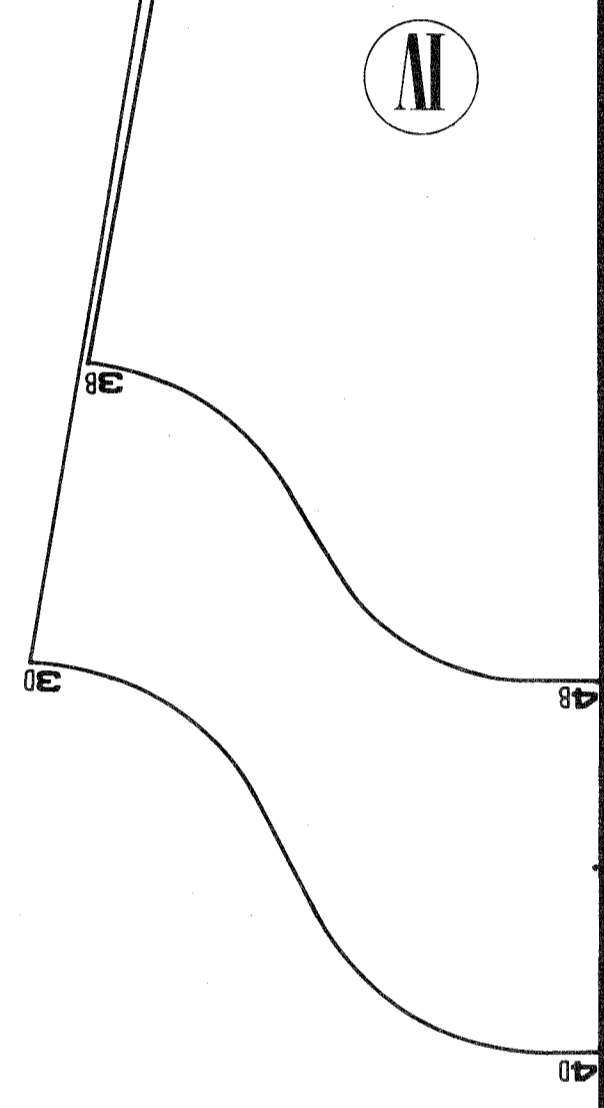
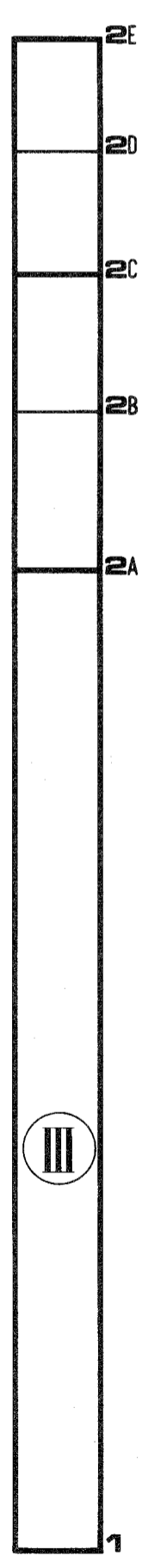
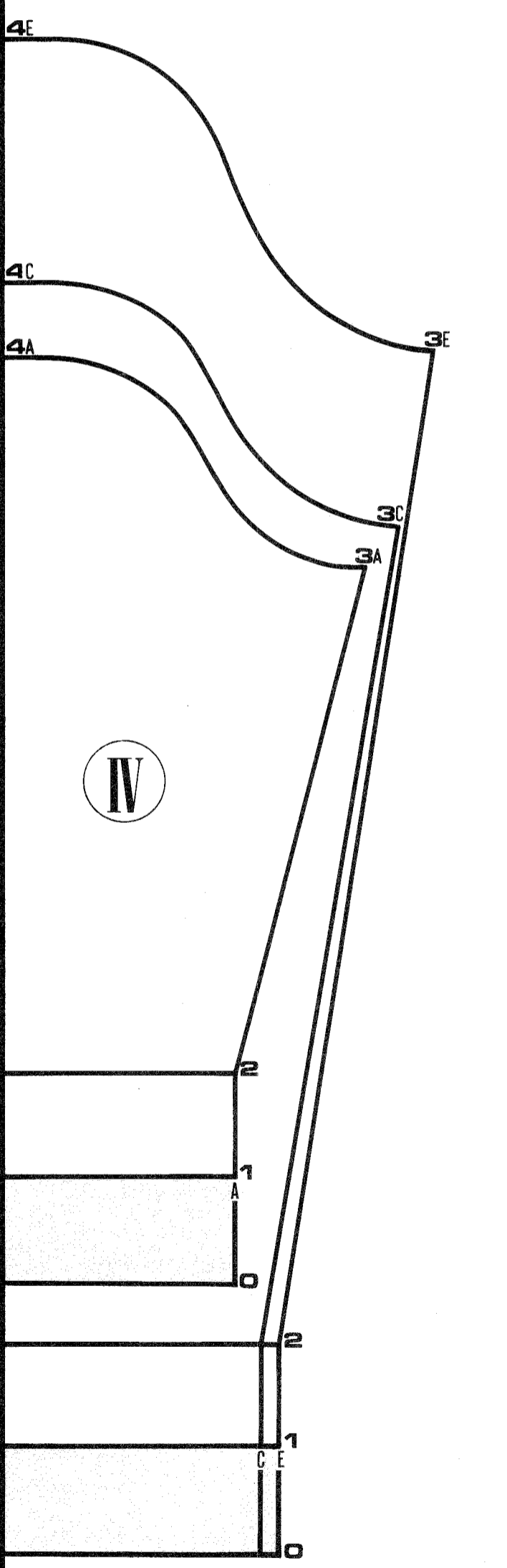
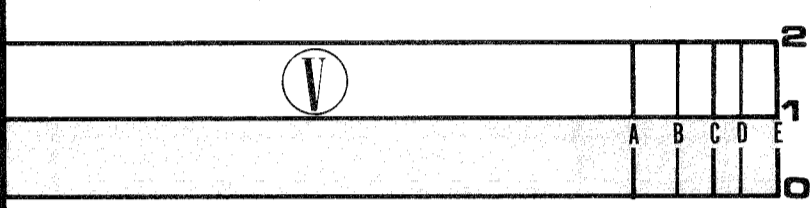
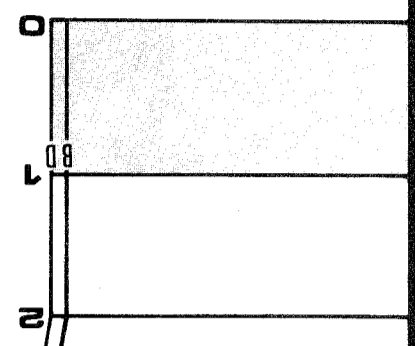
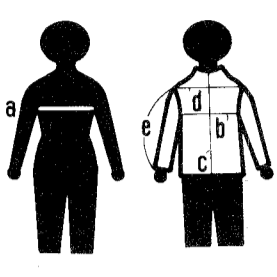

C-3

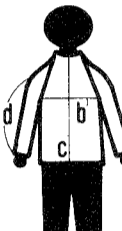

	A	B	C	D	E
 a	56cm (22")	61cm (24")	66cm (26")	71cm (28")	76cm (30")
 b	58.5 (23)	63.5 (25)	68.5 (27)	73.5 (29)	79 (31)
c	31 (12 $\frac{1}{4}$)	36.5 (14 $\frac{3}{8}$)	41.5 (16 $\frac{3}{8}$)	45.5 (18)	49.5 (19 $\frac{1}{2}$)
d	29 (11 $\frac{1}{2}$)	36 (14 $\frac{1}{4}$)	42 (16 $\frac{1}{2}$)	46 (18 $\frac{1}{8}$)	51 (20)

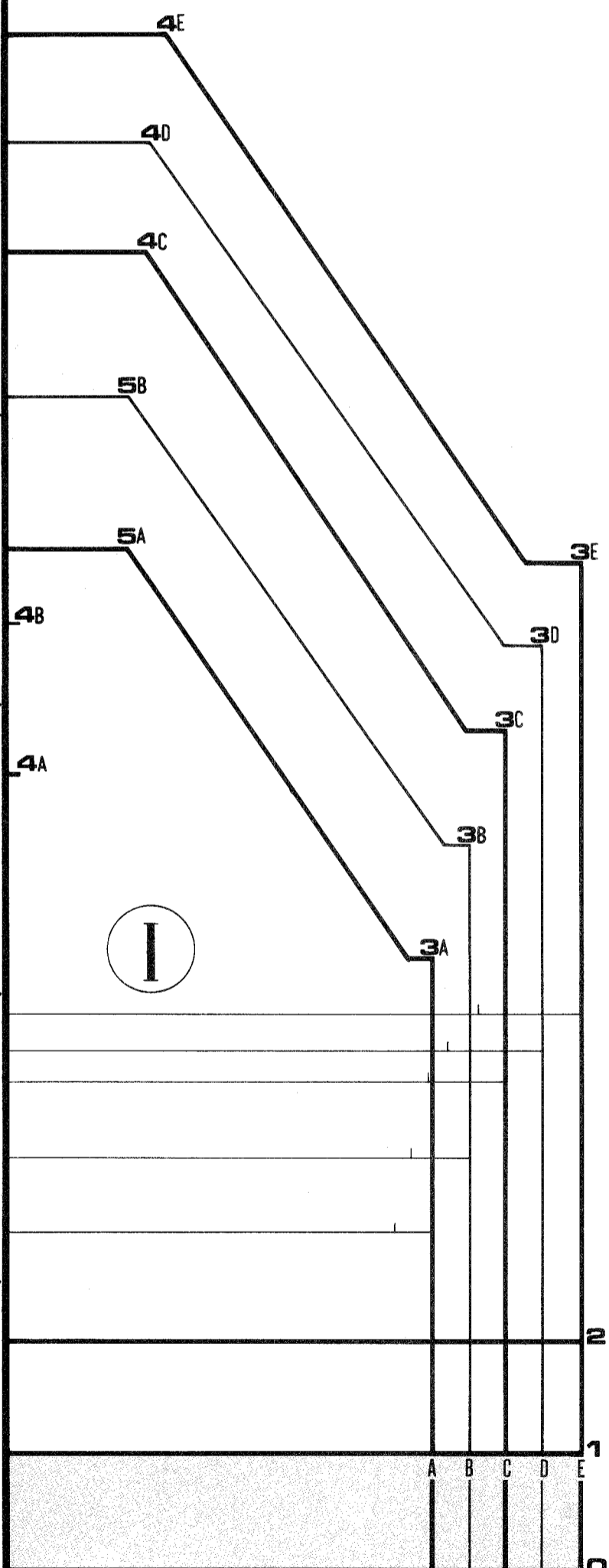

C-3

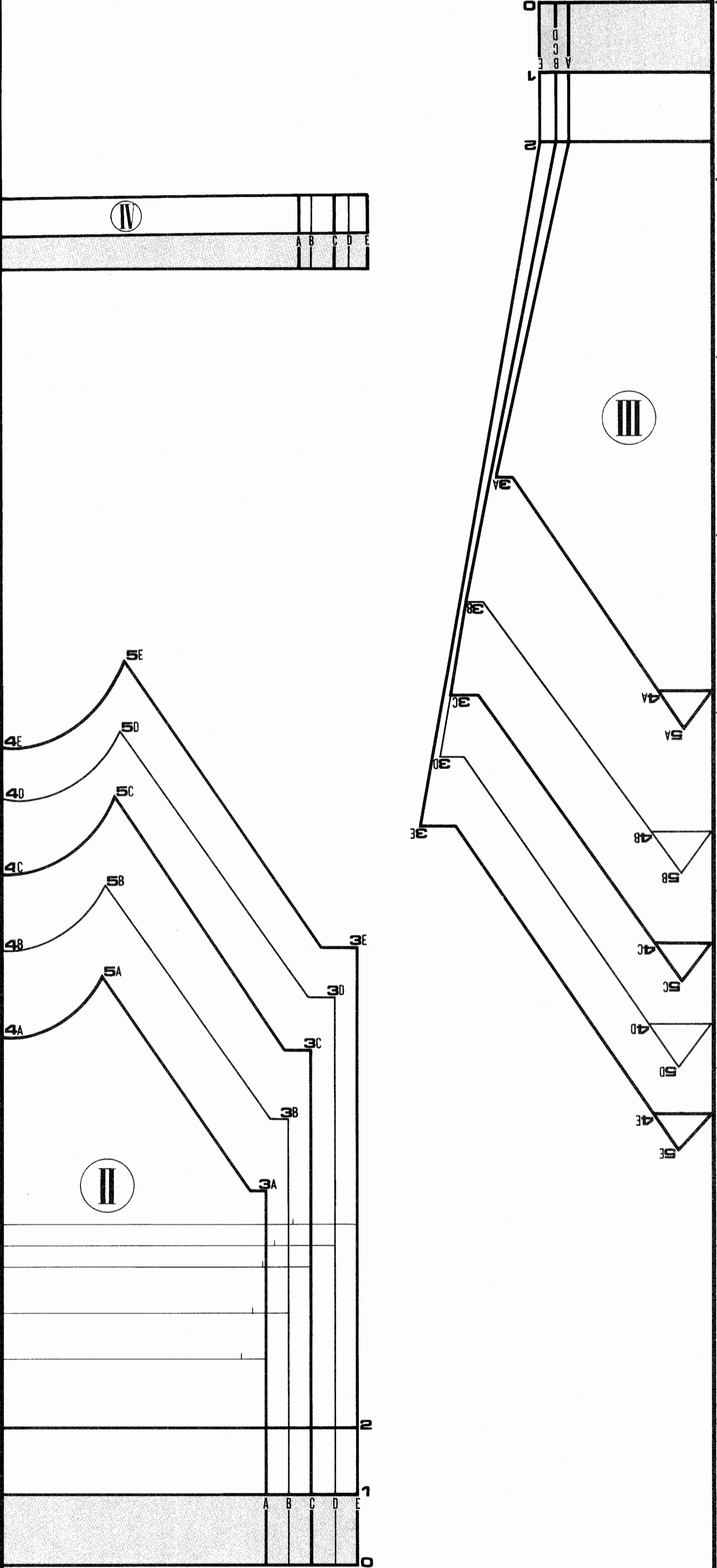

C-4

	A	B	C	D
a	62cm (24½")	69cm (27")	76cm (30")	81cm (32")
b	63.5 (25)	69 (27)	76 (30)	82.5 (32½)
c	67 (26¼)	81 (32)	89 (35⅛)	97 (38⅛)
d	62 (24½)	69 (27)	71 (28)	79 (31)

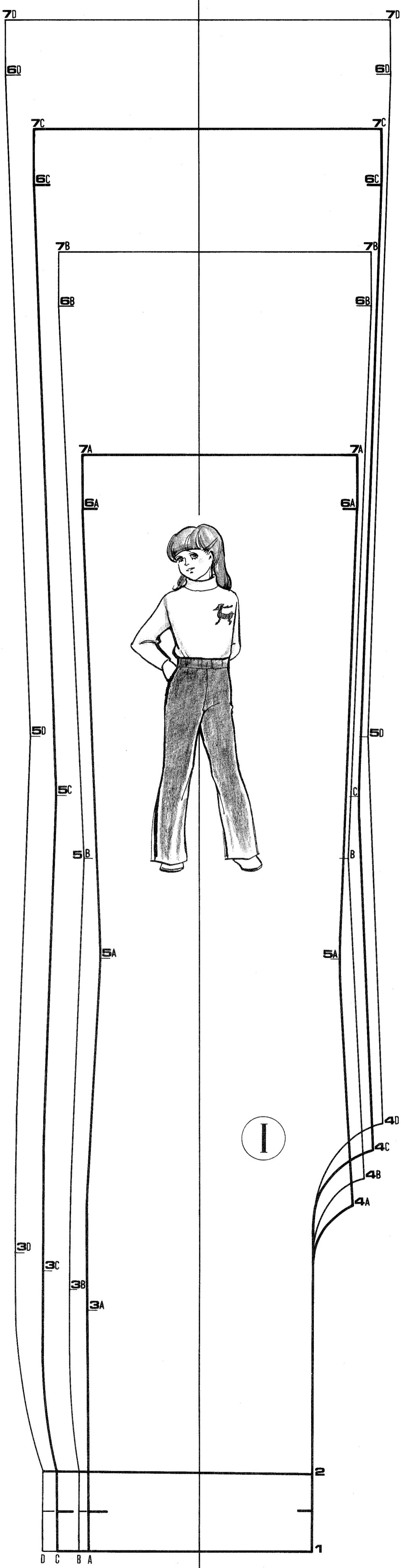
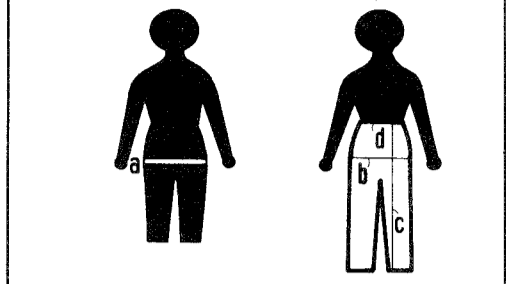

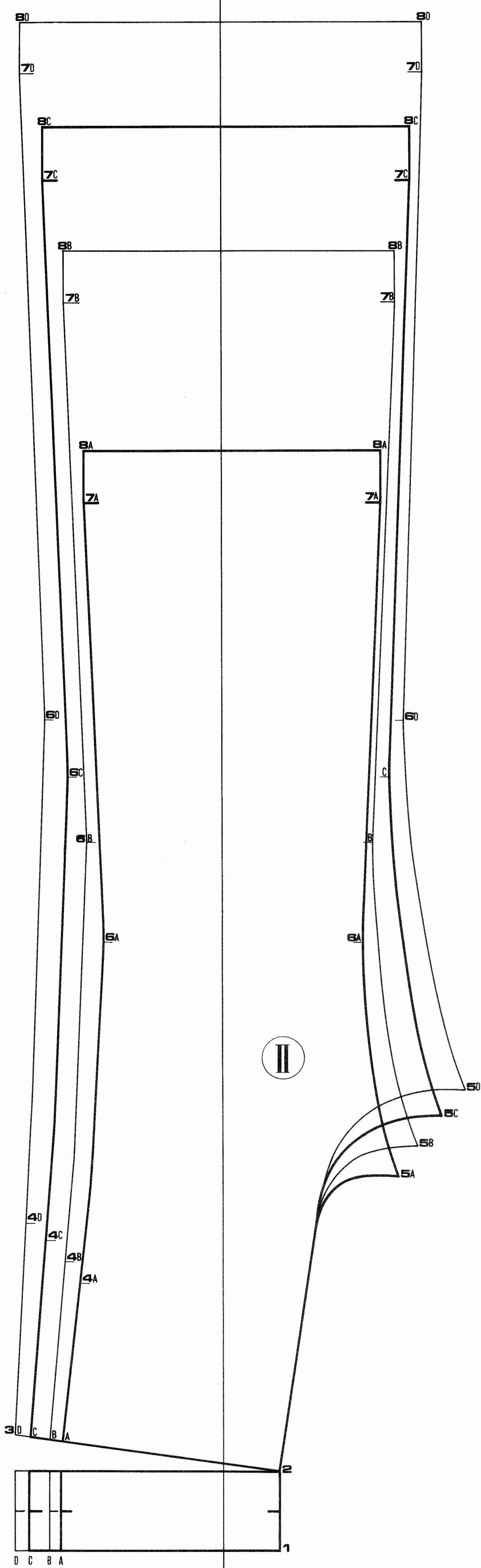

C-5

	A	B	C	D	E
a	57cm (22½")	62cm (24½")	69cm (27")	76cm (30")	81cm (32")
b	68.5 (27)	73.5 (29)	76 (30)	80 (31½)	88 (34½)
c	58.5 (23)	61 (24)	63.5 (25)	66 (26)	70 (27½)
d	21.5 (8½)	26.5 (10½)	34.5 (13½)	42 (16½)	49.5 (19½)

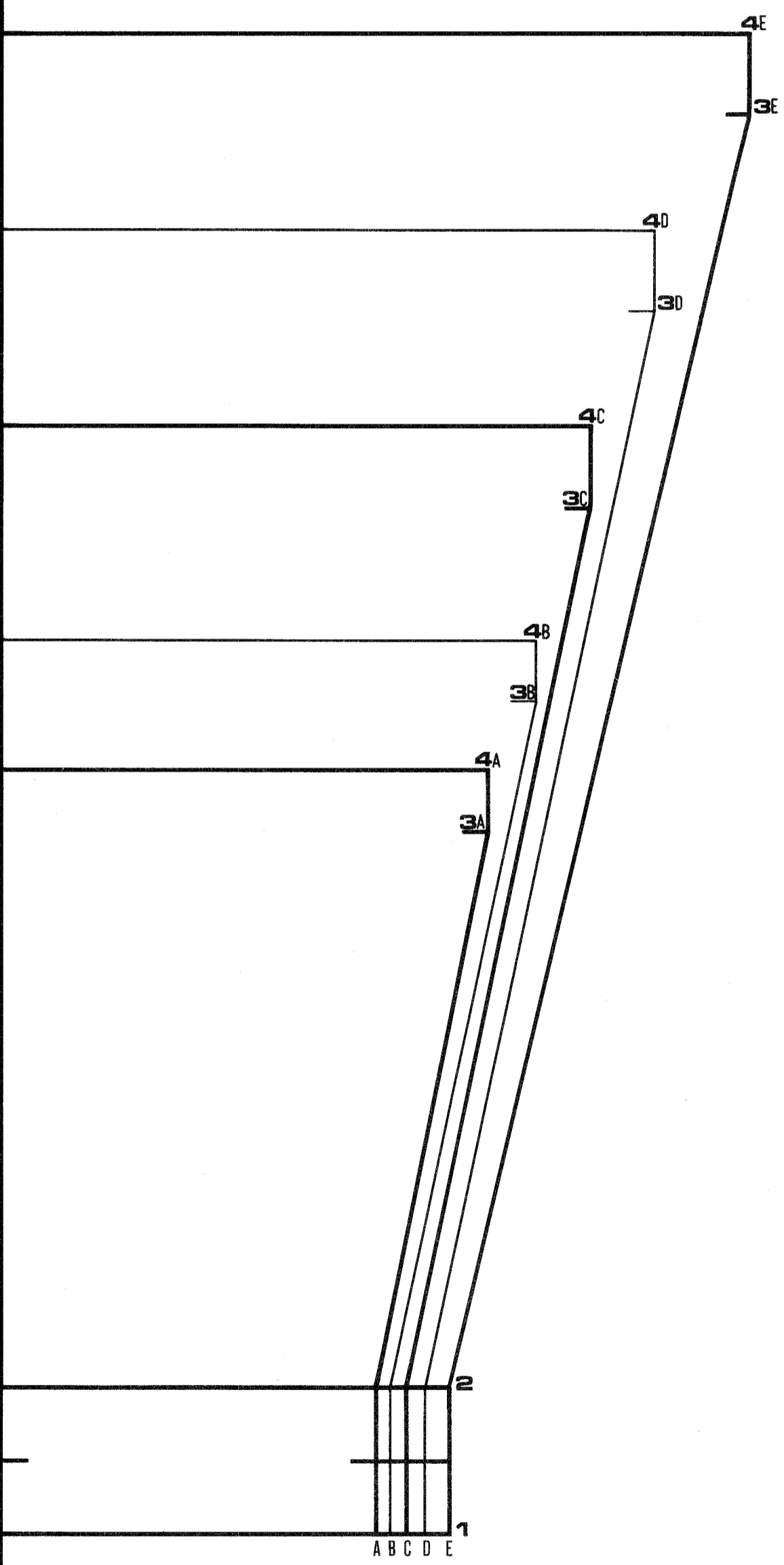
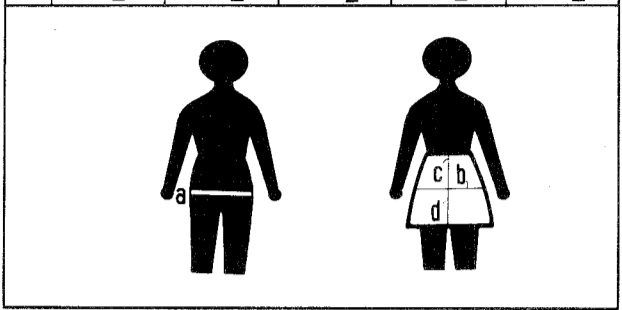

C-6



	A	B
a	46 cm (18")	51 cm (20")
b	48 (19")	53 (21")
c	27.5 (10 ³ / ₄)	30.5 (12)

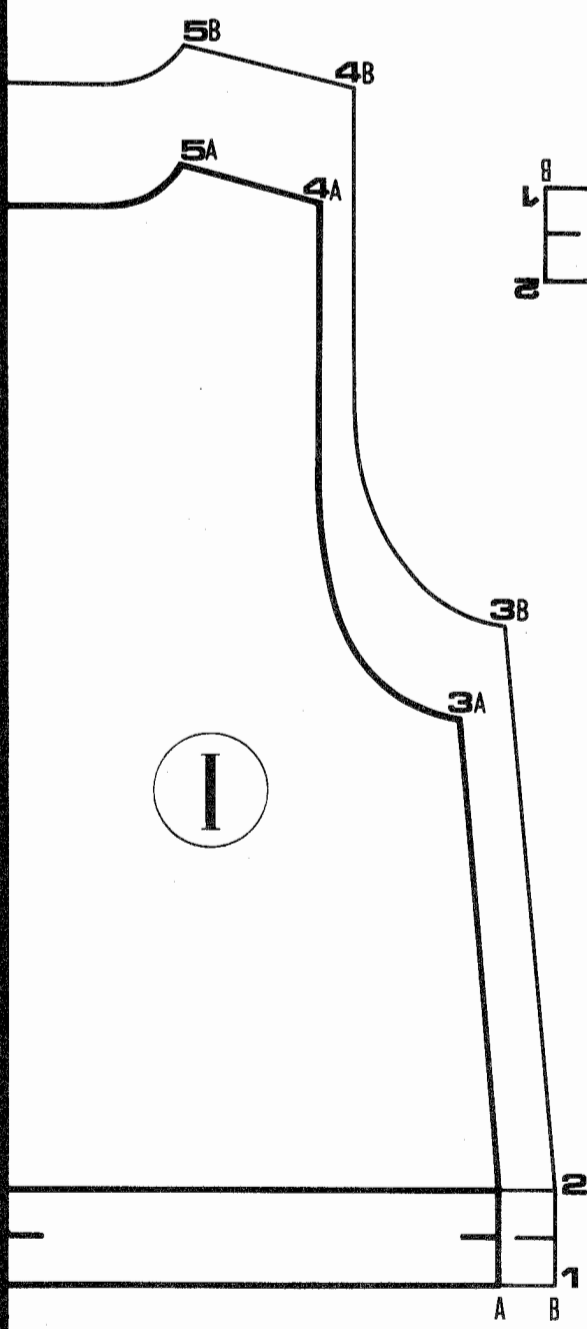
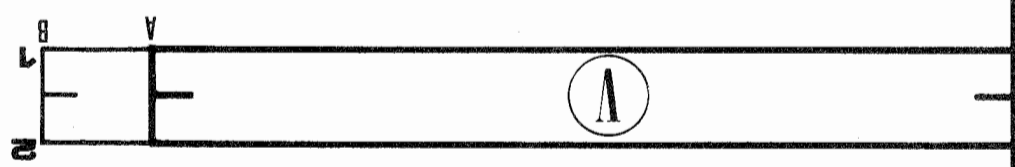
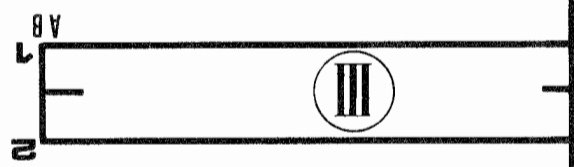
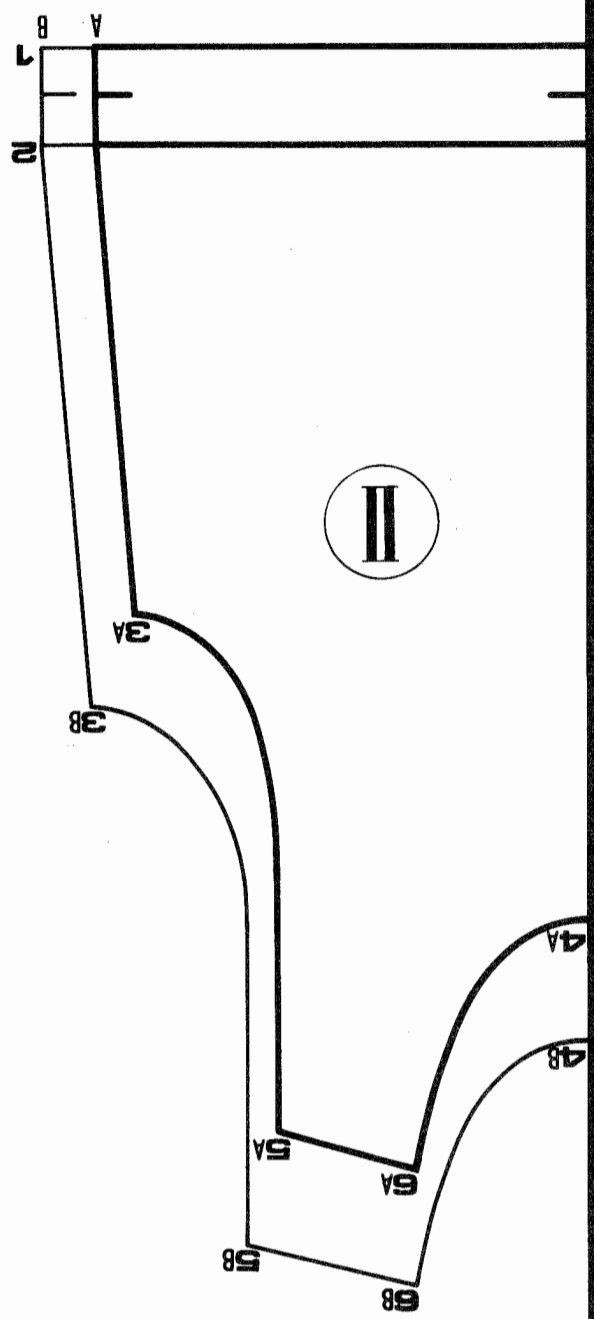
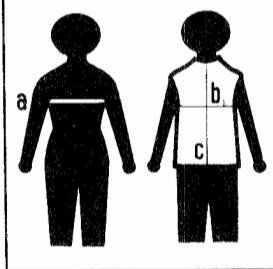

C-7

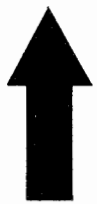

	A	B
a	46cm (18")	51cm (20")
b	52 (20½)	57 (22½)
c	28 (11)	32 (12½)
d	22.5 (8¾)	25.5 (10)

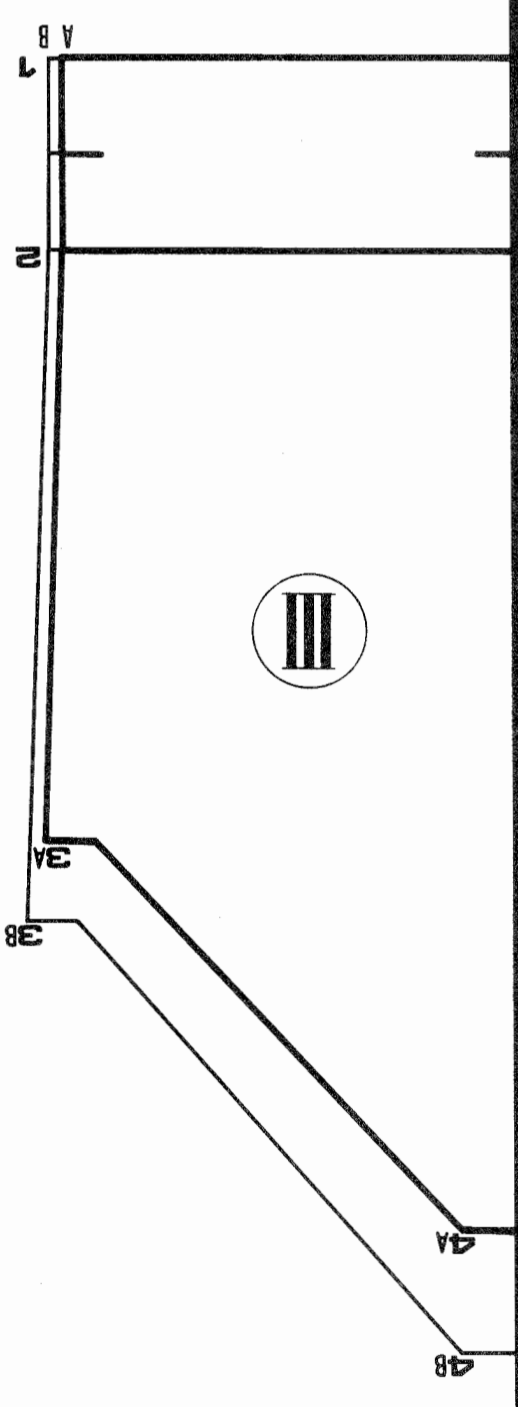
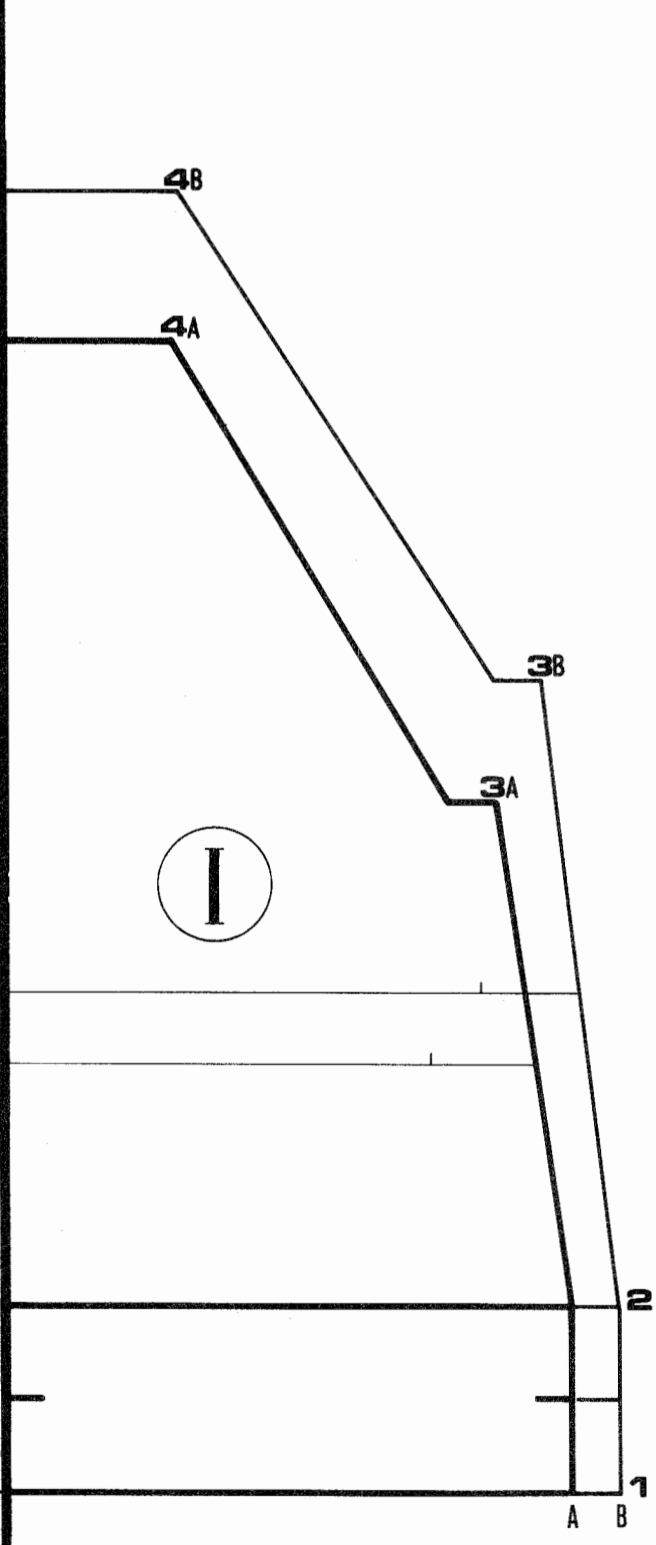
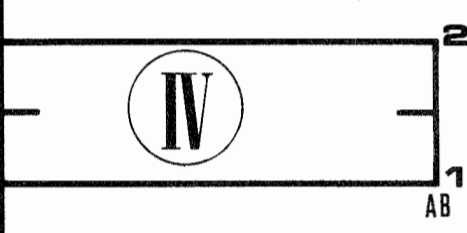
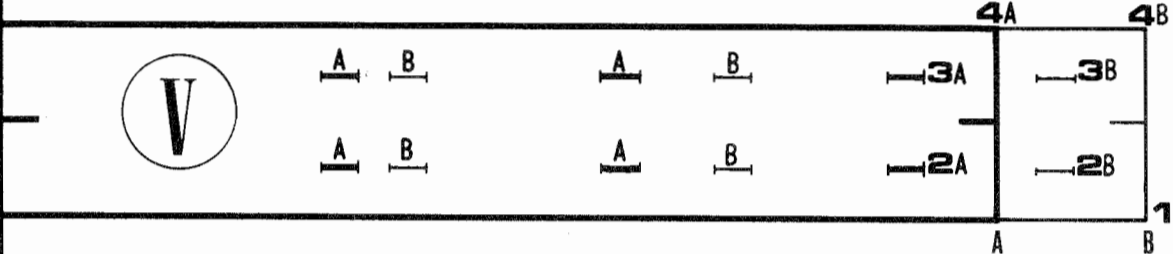
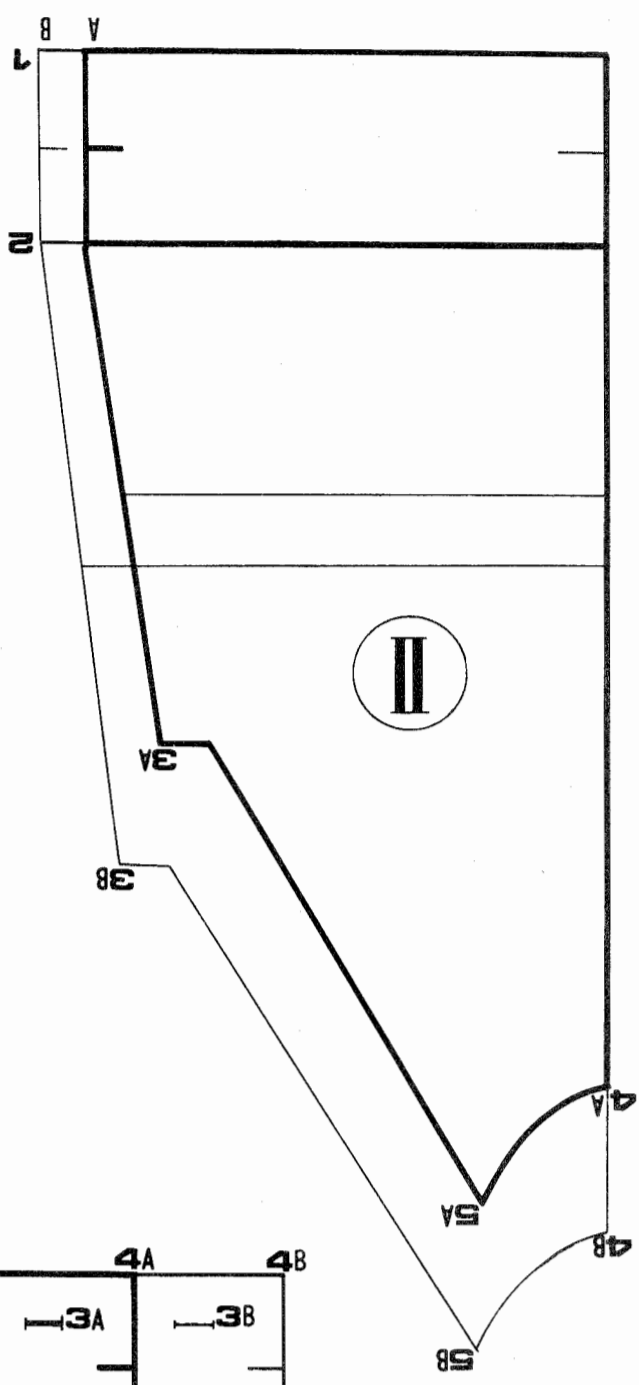
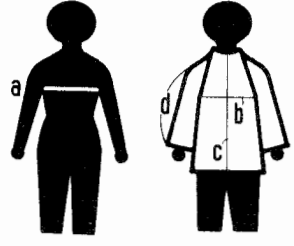

C-8



	A	B	C
a	46cm (18')	51cm (20')	57cm (22½')
b	48 (19)	53 (21)	57 (22½)

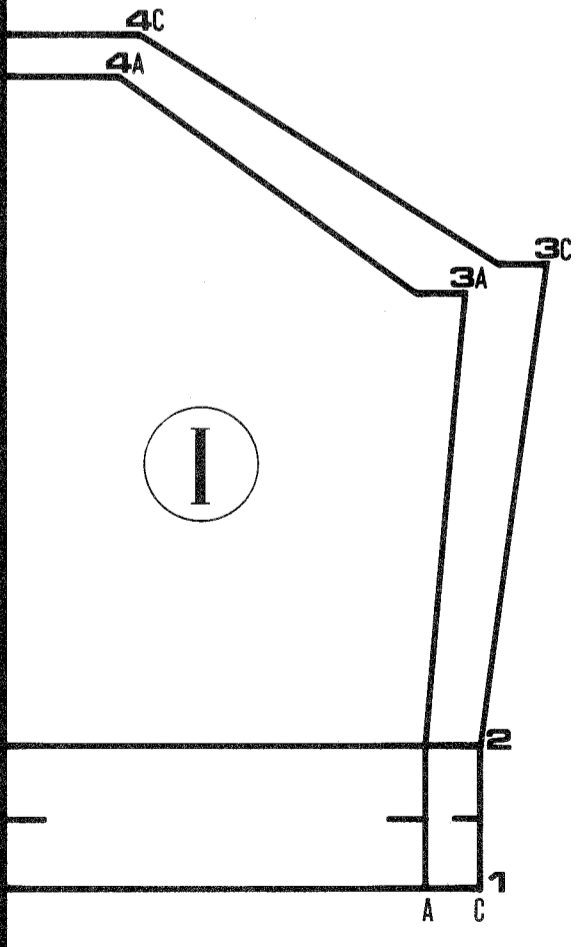
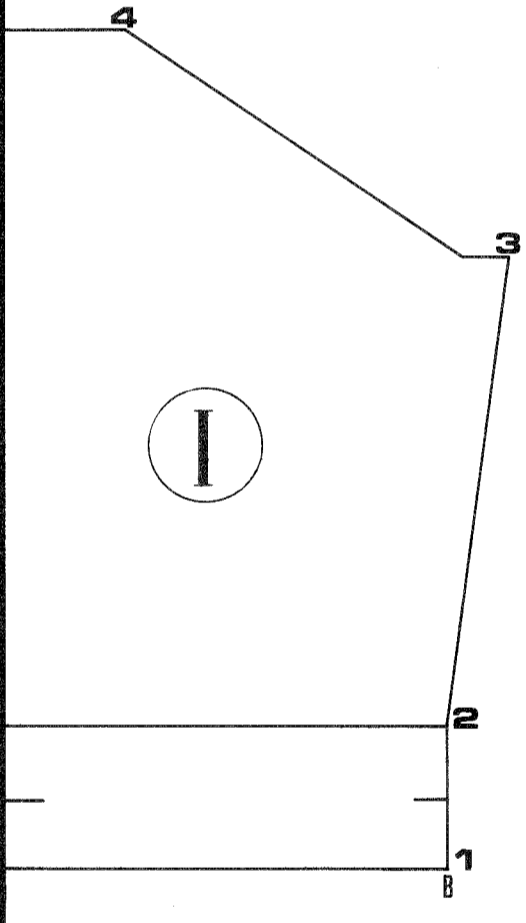
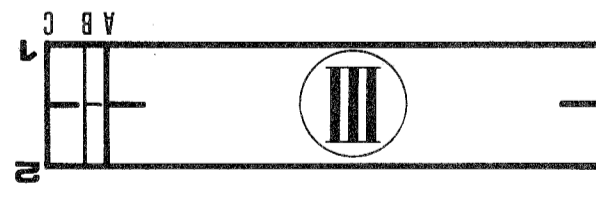
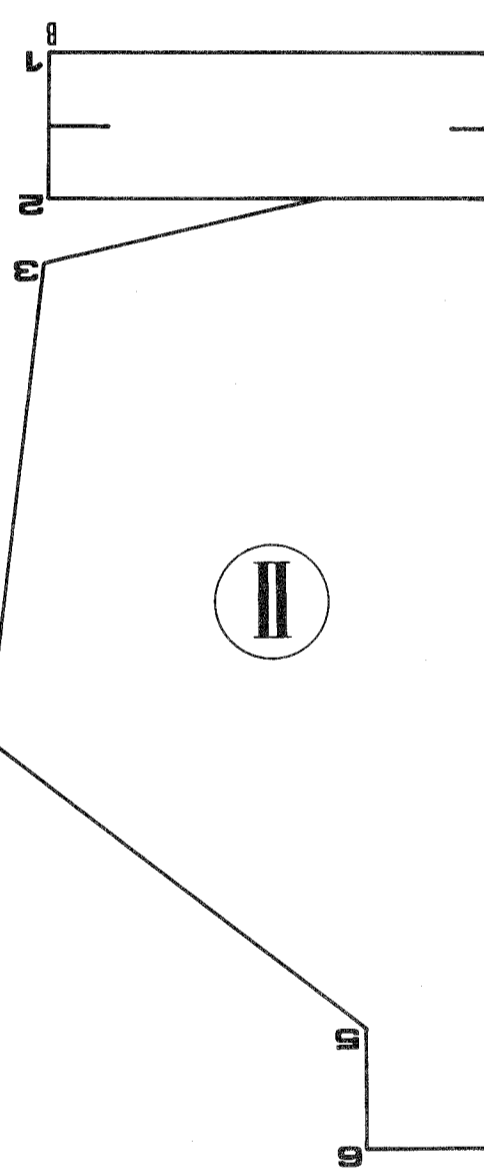
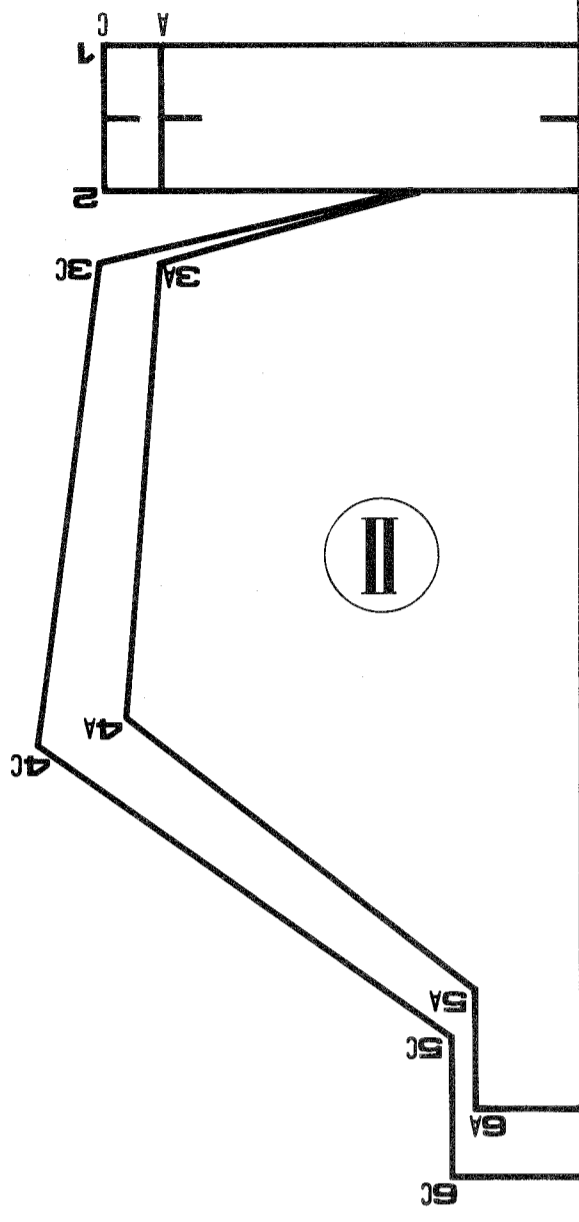
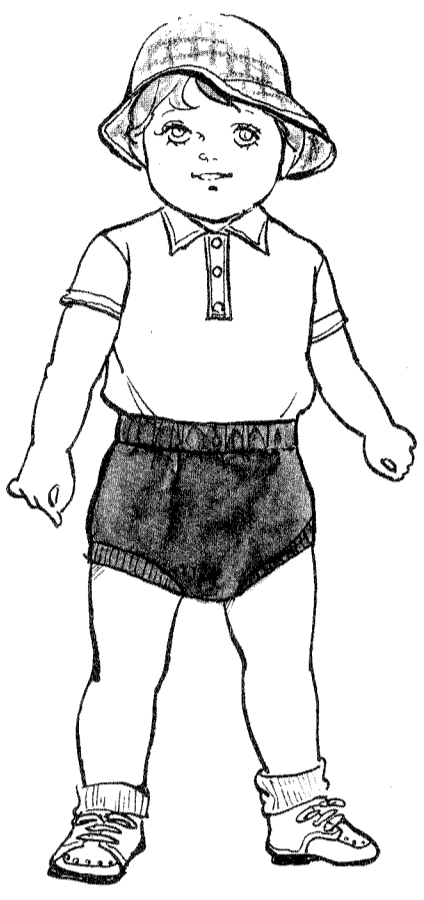
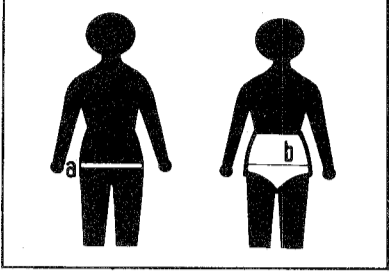

C-9

	A	B	C
a	46cm (18")	51cm (20")	57cm (22½")
b	51 (20)	56 (22)	60 (23½)
c	47 (18¾)	49 (19¼)	53.5 (21)

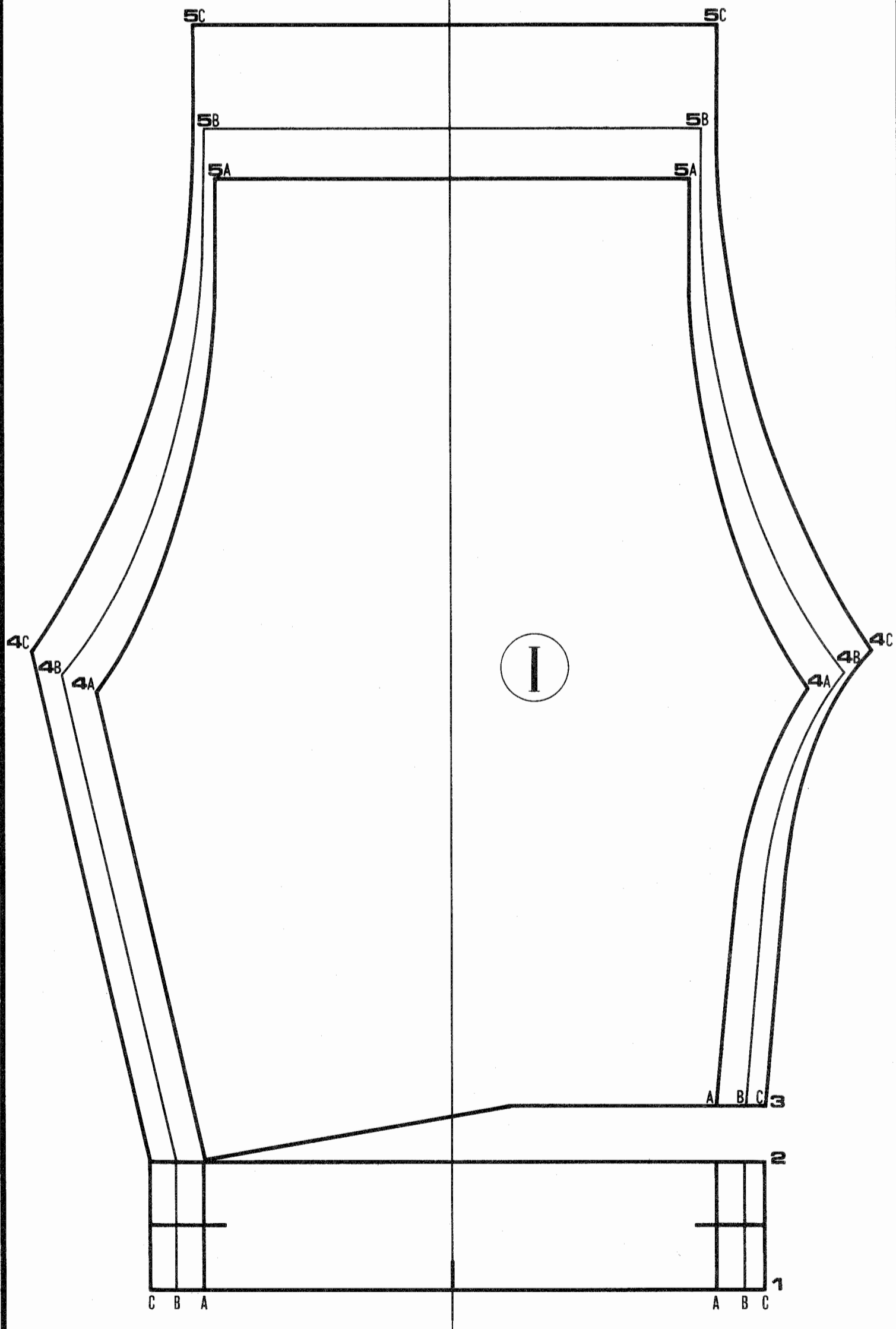
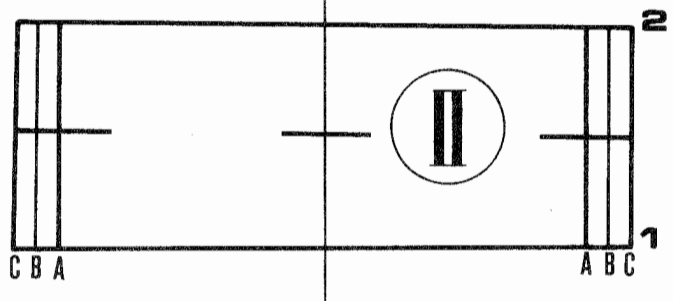
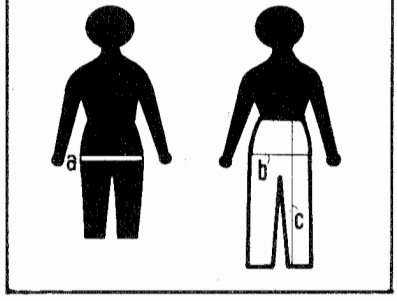

C-10



	A	B	C
a	46cm (18")	51cm (20")	57cm (22½")
b	48 (19)	53 (21)	57 (22½)

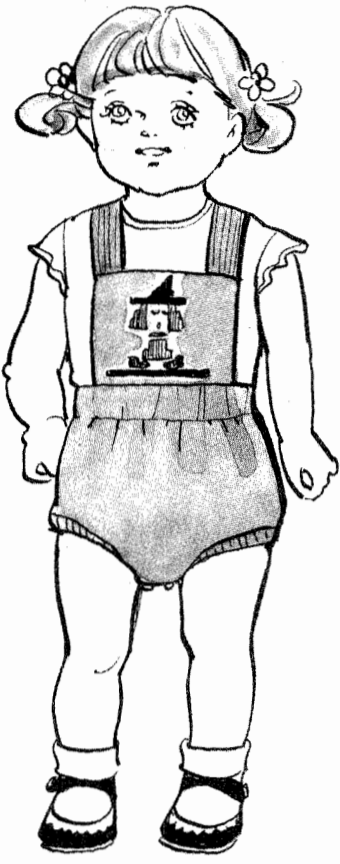

Λ

