

# PASSAP<sup>®</sup>

BABY  
BOOK

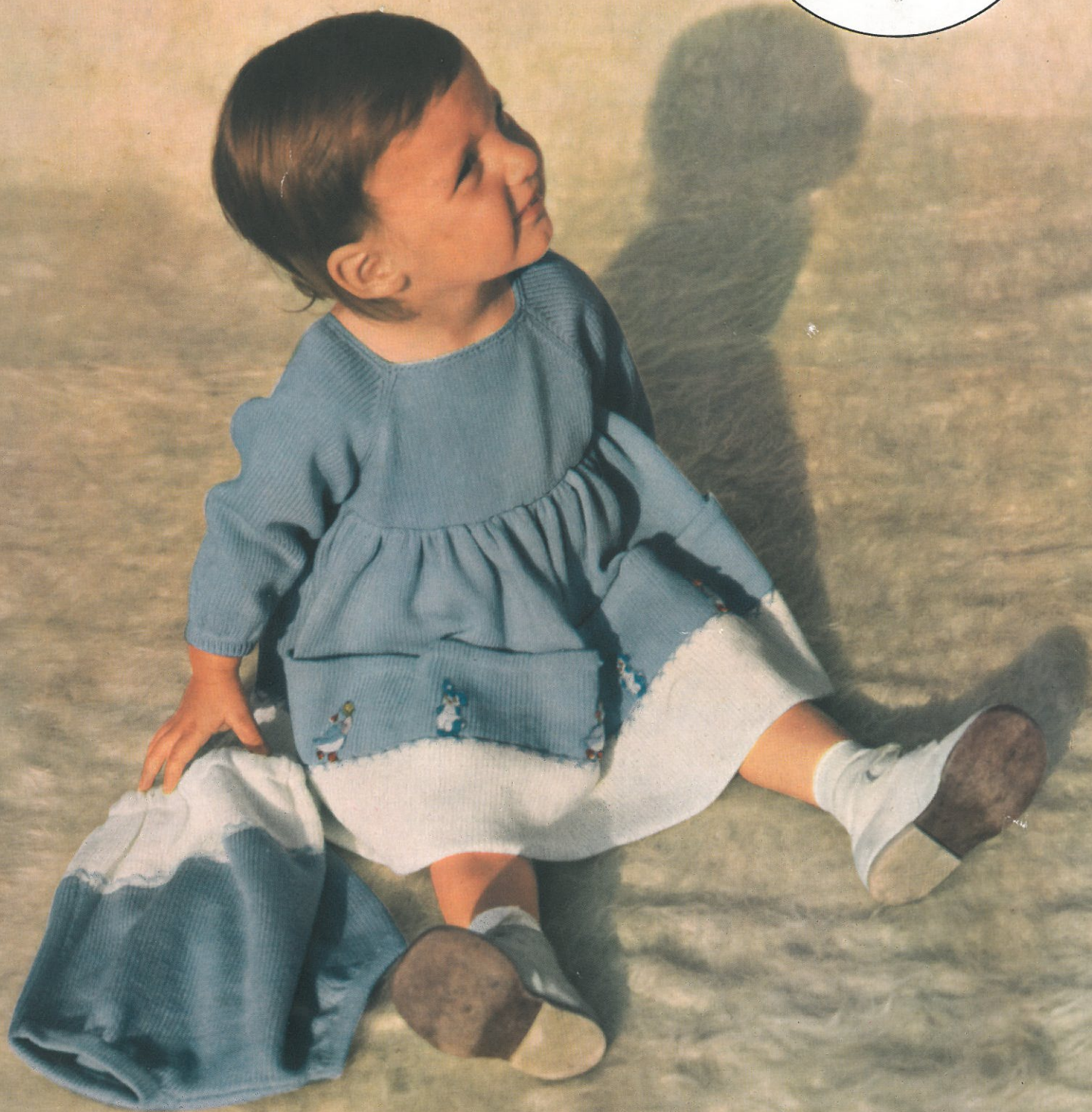





## Our cover-girl

## Little girls dress with matching bloomers

### for 1-2 years old

PASSAP-Model M 1201

Our little Cover Girl will have a lot to do, to fill all six pockets trimming the front of her new party-dress!

**FINISHED MEASUREMENTS:** Waist 22", chest 22", length of skirt 10¼", bloomers width 30¾".

**MATERIALS:** 9 ozs. baby-wool in sky-blue, approx. 2½ozs. in white. Patons Beehive Fingering—3 ply. 7 glass-buttons in blue, 7 gay ornaments—Donald Duck, Daisies, and such like—approx. 1¾" high to sew on to pockets. Approx. 24" narrow elastic, 4" taffeta for pocket lining.

**SIZE OF STITCH:** 4½.

**TENSION:** 16 sts. and 25 rows over 2 square inches. Knitted throughout in stocking-stitch.

#### Figure I Skirt Front

**SECTION A:** Using white wool cast on all 201 sts. knit 80 rows and *make hem*.

**SECTION B:** Now for pockets. Knit 40 rows using blue wool and cast off.

**SECTION C:** Pick up all purl-loops of the last white row and place on machine, purl side facing. Using blue wool knit 80 rows. Cast off all sts.

#### Figure II Skirt Back

**SECTION A:** Knit exactly as for Skirt front.

**SECTION B:** Using blue wool knit 55 rows.

**SECTION C:** Divide work in exact centre for back opening and using a second ball of wool cont. to knit both sides at the same time. Knit 25 rows and cast off all sts.

#### Figure III Bodice Front

**SECTION A:** Using blue wool cast on 84 sts. and knit 10 rows.

**SECTION B: Shape Armhole.** Dec. 4 sts. at the beg. of next 2 rows and 2 sts. at the beg. of the next 6 rows.

**SECTION C: Raglan Shaping.** Knit 32 rows, at the same time fashion dec. 1 st. at the beg. of the next 32 rows, i. e. put the 3rd st. on to the 4th needle and move up the 2 sts. Cast off the remaining 32 sts.

#### Figure IV Left Back

**Knit right back with reversed shapings**

**Section A:** Cast on 42 sts. using blue wool and knit 10 rows.

**SECTION B: Shape armhole.** At right dec. 4 sts. once and 2 sts. 3 times on every alt. row.

**SECTION C:** Knit 32 rows, at the same time at right, fashion dec. 1 st. at the beg. of every alt. row 16 times. Cast off the remaining 16 sts.

#### Figure V Sleeves

**SECTION A:** Using blue wool cast on 64 sts. and knit 80 rows, at the same time inc. 1 st. at both ends of every 10th row, 8 times (80 sts.).

**SECTION B: Shape Armhole.** Cast off 3 sts. at the beg. of the next 2 rows and 2 sts. at the beg. of the next 6 rows.

**SECTION C:** Knit 32 rows, at the same time fashion dec. 1 st. at the beg. of the next 32 rows, as described for bodice front. Cast off remaining 24 sts.

#### Figure VI Bloomers (Back)

**SECTION A:** Using blue wool cast on 28 sts. Knit 32 rows, at the same time inc. 3 sts. at the beg. of every row (124 sts.).

**SECTION B:** Knit 55 rows in blue without shaping.

**SECTION C:** Using white wool knit 30 rows without shaping. Now for the *seat* knit graduations as follows: \* Bring 15 needles into R.P. on both sides and knit the row. Repeat from \* twice.

**SECTION D:** Bring all needles into W.P. Set row counter at 0. Knit 15 rows and cast off.

#### Figure VII Bloomers (Front)

Knit exactly as for Bloomers Back, omitting graduations.

**To Make Up (Part):** Block and press each part using a warm iron over a damp cloth. Join side seams of the skirt. Line the pockets part at front of skirt with taffeta, slip stitch about ½" inside for hem. Divide the lined part into 7 small pockets and attach with back stitch. At upper part of the white seam make 1 row of fancy stitches using blue wool. Attach a gay coloured ornament to every pocket. Gather the skirt at waist to fit bodice. Join bloomers at cast-on edges (gusset). Make a row of fancy stitches in blue around lower edge of the white part.

**Borders:** Pick up all stitches along cast-on edges of *sleeves* on to a knitting needle and place on machine dec. evenly to 36 sts. each. Knit about 10 rows. Cast off all sts. Pick up all sts. around *leg openings* and place on machine dec. evenly to 92 sts. each. Knit 15 rows and cast off.

**To Make Up:** Fold all borders inside and slip stitch in place. Join side and sleeve seams. Set in sleeves using mattress stitch. Join skirt to bodice. Crochet two rows of single crochet along neckline and back opening. Make 7 loops and attach buttons. Join side seams of bloomers, make hem at waist, leaving a gap through which to thread elastic. Thread elastic through, press all seams.

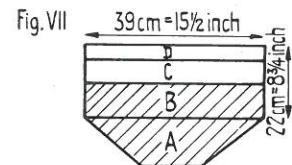
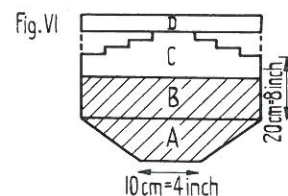
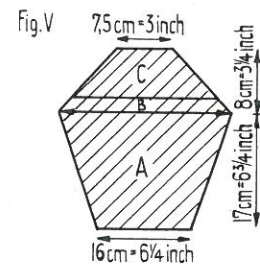
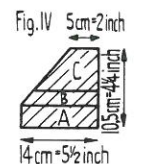
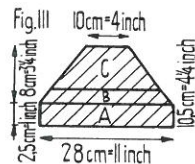
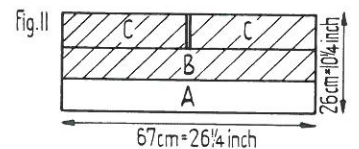
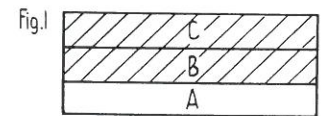

#### Abbreviations:

alt. = alternate  
beg. = beginning  
dec. = decrease  
inc. = increase  
st., sts. = stitch, stitches  
N.P. = neutral position  
W.P. = working position  
R.P. = rest position  
R/A = ribbing attachment

#### Definitions:

Group I = latch needles on machine  
Group II = latch needles on Ribbing Attachment

The following divisions refer to Group I only:

2-2 = 2 needles working position, 2 needles rest (neutral) position  
1-1 = 1 needle working position, 1 needle rest (neutral) position  
3-1 = 3 needles working position, 1 needle rest (neutral) position  
(see Instruction Book for PASSAP M 201, Figs. 68-78)

#### Needle division for Group I:

o = Needle in neutral position  
I = Needle in working position  
\* = Needle temporarily in rest position

#### Needle division for Group II:

1 = Needle put into Attachment  
- = No needle in Attachment



May we present our new Baby-Book —  
all ready in many languages to go out into the world  
in the wake of our Pattern Books to bring even more pleasure  
to all busy PASSAP-Knitters of the five continents.

When selecting the models for publishing,  
we took careful consideration of the fashion-taste of the various countries,  
and we sincerely hope  
that it will bring as much joy to all as we had creating it!



**Not only useful things**—even pretty little trifles can be knitted on PASSAP in no time.—Are you keen on handicraft?—Then buy a paper pattern for this happy trio, knit straight plain pieces on PASSAP with bright and gay materials. Sew around the contours according to the pattern using either your sewing-machine or do it by hand with very close backstitch, so that no stitches can slip! Cut out the pieces, join together, and before closing the last seam, stuff the animals with cotton wool or other stuffing. For knitting materials you can easily use almost everything: wool, silk- or cotton yarn, fine bast, etc. Our little PASSAP-Zoo was made according to “Simplicity printed Pattern No. 1404”, created in New York.



# Baby's Coat and Leggings

PASSAP-Model BM 1234a & b

**FINISHED MEASUREMENTS:** *Leggings:* Full length 19 $\frac{3}{4}$ " , leg seam 7" , chest 19 $\frac{3}{4}$ " , length of foot 4 $\frac{1}{4}$ " . *Coat:* Full length 8 $\frac{3}{4}$ " , height of yolk 2" , sleeve seam length with cuff 9" .

**MATERIALS:** 6 ozs. medium Baby-wool, 1 oz. silky cotton yarn and 6 mother-of-pearl buttons.

**SIZE OF STITCH:** 4.

**TENSION:** Pattern 1: 17 sts. and 24 rows over 2 square inches. Pattern 3: 16 sts. and 24 rows over 2 square inches.

**Pattern:** Pattern 1: Knitted on the R/A set for 3-1 division.

*1st series:* Group II in lowest position, knit 3 rows on Group I using wool.  
*2nd series:* Bring Group II into W.P. and knit 1 row with silky yarn, making only  $\frac{1}{4}$  turn of handle = Group II in lowest position again. Repeat these 4 rows throughout, using freesetter knob, if necessary. (Group II side is outside.)  
Pattern 2: 1 plain - 1 purl normal rib, knitted on the Ribbing Attachment.  
Pattern 3: Plain stocking stitch knitted on the machine only, plain side is the right side.

**Figure I Leggings Front**

Back of leggings is knitted exactly alike until and including Section C

**SECTION A:** Starting at waist and using an odd ball of wool cast on 80 sts. in the open method and knit a few rows. Now using main wool knit 68 rows without shaping.

**SECTION B:** Divide work in the exact centre for legs, and using a second ball of wool finish both parts at the same time. Knit 66 rows, at the same time at inside of legs dec. 1 st. on every 4th row, 13 times.

**SECTION C:** Fix R/A setting needles for 1 plain - 1 purl normal rib. Transfer every alt. needle from Group I on to Group II and knit 20 rows in pattern 2 for ankle. (When knitting the back of the leggings at this point take all sts. on to a woollen thread.)

**SECTION D:** Transfer the Group II sts. on to the Group I needles and remove R/A. Now over the 27 sts. each knit 30 rows straight for the in-step.

**SECTION E: Shape toe:** At the beg. of every row bring 2 needles into R.P. until 6 sts. remain in the centre, then, at the beg. of every row push 2 needles back into W.P. until all needles are in W.P. again.

**SECTION F:** For the sole knit 30 rows without shaping.

**SECTION G: Shape heel:** At the beg. of every row push 1 needle forward into R.P. until 6 sts. remain in the centre. Then, at the beg. of every row bring 1 needle back into W.P. until all sts. are in W.P. again. Take the sts. on to a woollen thread.

**Figure II Bodice**

Knit 2 identical parts for Front and Back

**SECTION A:** Unravel the odd wool at waist of leggings and place 80 sts. back on to machine. Fix R/A setting needles for 1 plain - 1 purl normal rib. Transfer every alt. st. from Group I to Group II and knit 20 rows in pattern 2 for waistwelt.

**SECTION B:** Transfer every 2nd st. from Group II to Group I and remove the respective needles on R/A, thus setting for 3-1 division. Knit 16 rows in pattern 1, at the same time inc. 1 st. at both ends of every 4th row, 4 times.

**SECTION C: Shape Armhole:** Dec. 2 sts. at the beg. of the next 2 rows and 1 st. at the beg. of the following 4 rows. Knit 54 rows in pattern 1 and cast off.

**Figure III Straps**

With R/A in 1-1 division cast on 30 sts., knit 40 rows and cast off.

**To Make Up:** Block and slightly press each part using a warm iron over a damp cloth. Close side seams. At heels join the sts. from the front with the sts. from the back part (all on woollen threads) with knit stitch. Turn in the upper edge of both bodice parts for about 1" for seam and slip-stitch inside. Crochet 1 row of single crochet along armholes using wool. Attach straps to back of bodice, then crochet 3 loops each at front edges of straps. Sew on 3 mother-of-pearl buttons each at bodice front. Twist 1 4-fold cord of 1 yd. 11 $\frac{1}{4}$ " length and 2 4-fold cords of 14" length each and draw through middle of waist-welt and through the ribbing at ankles.

**Figure IV Back and Front of Coat**

**SECTION A:** With R/A in 3-1 division cast on 180 sts. and knit 68 rows in pattern 1.

**SECTION B:** Divide work into three parts as follows: Leave 50 sts. for first back-part, then cast off 3 sts. Now leave 74 sts. for the front, cast off 3 sts. so that 50 sts. remain for second back part. Continue by knitting 16 rows in pattern 1, using 3 balls of wool and 3 balls of silky cotton.

**SECTION C:** On R/A set needles for 1 plain - 1 purl rib and transfer the corresponding sts. from Group I to Group II. Knit 25 rows in pattern 2 and cast off.

**Figure V Sleeves**

**SECTION A:** With R/A in 1-1 division cast on 60 sts. and knit 30 rows in pattern 2.

A classic set —  
three beautiful designs combining softest wool  
and silky cotton —  
the last word in baby's elegance.

**SECTION B:** Transfer every alt. st. from Group II to Group I and remove the respective needles from the R/A, thus setting for 3-1 division. Knit 60 rows in pattern 1.

**SECTION C:** Set R/A again for 1 plain - 1 purl rib and transfer the respective sts. from Group I to Group II. Knit 25 rows in pattern 2, cast off.

**To Make Up:** Block and slightly press all parts using a warm iron over a damp cloth. Join all parts and set in sleeves. Along upper edge crochet 1 row of double crochet making 4 loops between each crochet and using silky cotton yarn. Twist a 4-fold cord with wool and draw through insertion.

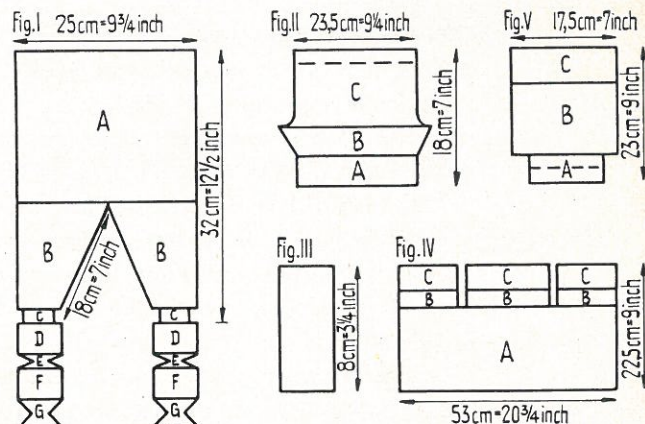





## Cosy double-faced wrapper

In two pieces, sky-blue and rose coloured, knitted from finest-softest wool and joined with loose stitches along the crocheted edges — the very best to give your darling warmth and protection against the rough outside world.



PASSAP-Model M 1214

FINISHED MEASUREMENTS:  $21\frac{3}{4}$ " wide,  $29\frac{1}{2}$ " long.

MATERIALS: 4 ozs. each blue and rose wool (Listers Lavenda baby wool).

SIZE OF STITCH: 7.

TENSION: 9 sts. and 40 rows over 2 square inches.

**Pattern:** Cast on in 1-1 division for patterning, set universal pattern selector as follows: 1 spade out - 11 spades in.

*1st Series:* Put every 6th needle into R.P. starting with 1st needle and knit 4 rows. All needles back into W.P.

*2nd Series:* Put every 6th needle into R.P. starting

with 4th needle (reverse to 1st series) and knit 4 rows. Repeat these 8 rows throughout.

### One Piece

With blue wool cast on 100 sts. in 1-1 division and knit 600 rows straight in pattern. Cast off. Knit a second piece exactly alike using rose wool.

**To Make Up:** Finish each piece separately as follows:

*1st row:* Single crochet.

*2nd row:* Six single crochet, in the 7th stitch work 4-double crochets making a loop between each of the four doubles crochets. Now join the 2 pieces, purl side outwards, matching crochet points carefully. Sew along row of single crochet with loose back stitches, block and press wrapper carefully, using a warm iron over a damp cloth.



# BABY'S WARDEROBE - 6 PIECE SET

PASSAP-Model M 1221

The charm of this little Baby-trousseau lies in the pretty combination of stocking stitch, rice pattern and ribbing.

**FINISHED MEASUREMENTS:** *Coat:* Full length 9", chest 19 3/4", sleeve seam 8". *Bonnet:* Unstretched width of top 15", upper width of cone 4", height 5 1/4". *Leggings:* Full length 21 3/4", leg seam 7 1/4", chest 20 1/2", length of foot 4". *Jacket:* Full length 9", chest 19 3/4", sleeve seam 6 1/4". *Mittens:* Height of cuff 2 1/4", length 3 1/4". *Bootees:* Length of sole 3 1/2".

**MATERIALS:** 11 ozs. Bairns Wear Baby Wool 3-ply, 1 oz. white silk for crochet.

**SIZE OF STITCH:** 5.

**TENSION:** Stocking Stitch: 15 sts. and 22 rows over 2 sq. inches. Rice Pattern: 15 sts. and 34 rows over 2 sq. inches.

**Pattern:** *Rice Pattern:* 1st and 2nd row: With pattern ruler in 1-1 division bring alt. needles forward into R.P. starting with the 1st needle, knit 2 rows.

3rd and 4th row: All needles W.P., knit 2 rows. 5th and 6th row: Bring every alt. needle into R.P., starting with the 2nd needle, knit 2 rows. 7th and 8th row: All needles W.P. knit 2 rows. Repeat these 8 rows throughout.

*Continental Ribbing:* 2 needles W.P., 1 needle N.P.

**COAT Figure I Back**

**SECTION A:** Cast on 120 sts. and knit 18 rows in rice pattern.

**SECTION B:** Knit 54 rows in stocking stitch without shaping.

**SECTION C:** *Shape raglan:* Dec. 1 st. at the beg. of the next 10 rows and take the remaining sts. on to a stitch-holder.

**SECTION D:** Place the sts. from the stitch-holder back on the machine dec. evenly to 60 needles and knit 44 rows in rice pattern. At the same time cont. raglan shaping by dec. 1 st. at both ends of every 4th row, 11 times. Cast off the remaining 38 sts.

**Figure II Right Front**

**Left Front with reversed shapings**

**SECTION A:** With size of stitch 5 cast on 68 sts. and knit 18 rows in rice pattern. At the same time at left of machine dec. 1 st. on every alt. row, 8 times.

**SECTION B:** Knit 54 rows stocking st. without shaping.

**SECTION C:** *Shape raglan:* At right of machine dec. 1 st. on every alt. row, 5 times, then take all sts. on to a stitch-holder.

**SECTION D:** Place the sts. from the stitch-holder on to the machine dec. evenly to 30 needles and knit 44 rows in rice pattern. At the same time at right cont. the raglan by dec. 1 st. on every 4th row, 11 times. Cast off the remaining 19 sts.

**Figure III Sleeves**

**SECTION A:** Set needles in 2-1 division for ribbing and cast on 44 sts. over 65 needles. Work 44 rows, then hang loops of cast on edge on to machine for hem. Bring needles from N.P. into W.P. and place the crossed links between each loop on to the empty needles.

**SECTION B:** Knit 72 rows in stocking st. without shaping.

**SECTION C:** *Shape raglan:* Dec. 1 st. at the beg. of the next 10 rows.

**SECTION D:** Knit 44 rows in rice pattern, at the same time dec. 1 st. at both ends of every 4th row, 11 times. Cast off the remaining 32 sts. straight.

**Figure IV Collar** Cast on 75 sts., knit 38 rows in rice pattern and cast off.

**Borders:** Pick up 50 sts. along one front part and place on to machine, purl side facing. Knit 18 rows in rice pattern. At the same time on lower edge, inc. 1 st. on every alt. row, 8 times for corner. After 10 rows have been knitted work in 3 buttonholes at side of neck as follows: Leaving 1 st. make 1st buttonhole over the 2nd to 4th needles, 2nd buttonhole over the 10th to 12th needles, and 3rd buttonhole over the 18th to 20th needles.—Knit border for other front part reversing all shapings and omitting buttonholes.

**To Make Up:** Block and slightly press each part using a warm iron over a damp cloth. Join all seams and set in sleeves. Turn up cuffs. Carefully mitre corners at front parts. Make 1 row of single crochet along both fronts and lower edge of coat. Around neckline work 1 row of double crochet, making 3 loops between each crochet. Attach the cast on edge of collar to insertion with 1 row of single crochet which is continued along outer edge of collar. Draw a 3 1/2" length of silk ribbon through insertion.

**BONNET Figure V**

**SECTION A:** With size of stitch 4 1/2 set needles in 2-1 division for Continental Ribbing and cast on 40 sts. over 59 needles. Knit 24 rows, make hem. Change size of stitch to 5.

**SECTION B:** Knit 82 rows in rice pattern. At the same time dec. 1 st. at both ends of every 5th row, 15 times. First half now being finished, knit second half reversing all shapings. Cast off.

**LEGGINGS Figure VI Leggings Front**

**For back of leggings knit only Sections A, B, C and D**

**SECTION A:** Using an odd ball of wool cast on 80 sts. with the open method and knit a few rows.

**SECTION B:** Now using main wool knit 60 rows in stocking st. without shaping.

**SECTION C:** Divide work in the exact centre and using a 2nd ball of wool, knit both legs at the same time as follows: At inside of legs dec. 1 st. on every 5th row, 14 times.

**SECTION D:** Transfer sts. for ribbing, i. e. place every 3rd st. on to the following needle and bring the empty needle into N.P. Knit 12 rows. Now bring the N.P. needles back into W.P. and place the crossed links between the sts. on to the empty needles. (For back of leggings knit 1 more row and take all sts. on to a piece of thread.)

**SECTION E:** Knit 30 rows straight in stocking st. with 26 sts. each leg.

**SECTION F:** *Shape each toe* by bringing 2 needles into R.P. at the beg. of every row until 6 sts. remain in the centre, then at the beg. of every row bring 2 needles back into W.P., until all needles are in W.P. again.

**SECTION G:** Knit 30 rows without shaping.

**SECTION H:** Now *shape each heel* by bringing 1 needle into R.P. at the beg. of every row until 6 sts. remain in the centre, then, at the beg. of every row, push 1 needle back into W.P., until all needles are back in W.P. again. Take all sts. on to a woollen thread.

**Figure VII Bodice Front**

**SECTION A:** Set needles for Continental Ribbing, i. e. 2 needles in W.P., 1 needle N.P. Unravel the odd wool at front of leggings pick up the 80 sts. and place back on machine dec. evenly to 54 needles. Knit 20 rows, then bring N.P.-needles into W.P. again and place the crossed links on to the empty needles.

**SECTION B:** Knit 52 rows in rice pattern.

**SECTION C:** *Shape armhole:* Dec. 2 sts. at the beg. of the next 4 rows and 1 st. at the beg. of the next 2 rows. Now divide work in the exact centre and, using 2 balls of wool cont. knitting both sides at the same time. At both neck and armhole edges dec. 1 st. on every 4th row, 17 times. Cast off the remaining 2 sts.

**Figure VIII Bodice Back**

**SECTIONS A and B:** Exactly like bodice front.

**SECTION C:** *Shape armhole:* Dec. 2 sts. at the beg. of the next 4 rows, and 1 st. at the beg. of the next 2 rows. Then cont. dec. 1 st. at both ends of every 4th row, 8 times.

**SECTION D:** Cast off 16 sts. at the exact centre of work and using a 2nd ball of wool cont. knitting both parts at the same time as follows: At both neck and armhole edges dec. 1 st. on every 4th row, 9 times, then cast off the remaining 2 sts.

**To Make Up:** Block and slightly press each part using a warm iron over a damp cloth. Join all seams. Join the sts. from the woollen thread at heels, Section H of front to Section D of back of leggings. Make 1 row of single crochet around armholes and neckline using main wool, then crochet 1 picot with white silk thread, making a loop at both front top edges for buttonholes. Twist 4-fold cords, one cord of 1 yd. 11 1/4" length, and 2 cords of 14" length each, and draw through middle of waist-welt and ankle. Attach 1 button to each end of back-straps.

**JACKET Figure IX Back-parts and Front**

**SECTION A:** Cast on 150 sts. with size of stitch 5 and knit 94 rows in rice pattern.

**SECTION B:** Divide the work into 3 parts as follows: 45 sts. for one back part, 60 sts. for front, and 45 sts. for the other back part. Now, using 3 balls of wool finish all parts,

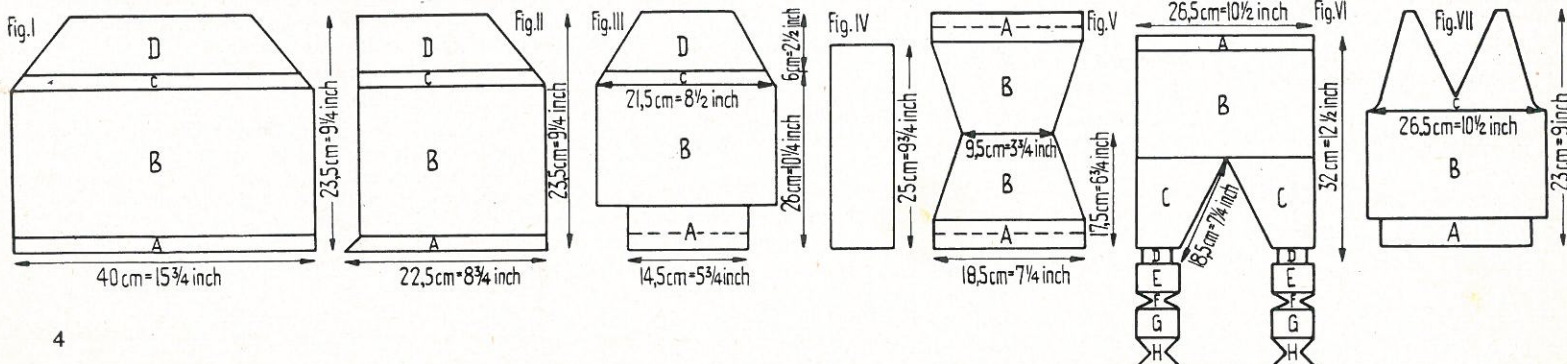





knitting in rice pattern. At the same time on each part, shape raglan as follows: Dec. 2 sts. once and 1 st. 6 times, then knit 18 rows without shaping. Change to size of stitch  $4\frac{1}{2}$ .

**SECTION C:** Transfer the sts. for Continental Ribbing, knit 22 rows and cast off.

**Figure X Sleeves**

**SECTION A:** Set needles for Continental Ribbing with size of stitch  $4\frac{1}{2}$  and cast on 40 sts. over 59 needles. Knit 22 rows. Now bring the N.P. needles into W.P. and place the crossed links on to the empty needles.

**SECTION B:** Change to size of stitch 5 and knit 82 rows in rice pattern.

**SECTION C:** *Shape raglan:* Dec. 2 sts. at the beg. of the next 2 rows, then 1 st. at the beg. of the following 12 rows. Knit 18 rows without shaping, then transfer the sts. for Continental Ribbing.

**SECTION D:** Change to size of stitch  $4\frac{1}{2}$  and work 22 rows in ribbing, then cast off.

**To Make Up:** Block and slightly press each part using a warm iron over a damp cloth. Join all seams and set in sleeves. Along neck-

line fold  $\frac{1}{4}$ " inside for hem and slip stitch in place. Work 1 row of single crochet along both back parts and lower edge of jacket using main wool. Along neckline make 1 row of double crochet working 4 loops between each crochet, then crochet a further row of picot. Twist a  $39\frac{1}{2}$ " long cord using silk and thread through insertion. Crochet 1 row of single crochet around cuffs.

**MITTENS Figure XI**

**SECTION A:** Cast on 40 sts. and knit 38 rows in rice pattern. Make 1 open-work row, leaving 3 sts. between.

**SECTION B:** Knit 30 rows stocking stitch without shaping.

**SECTION C:** Divide work in the exact centre and using 2 balls of wool finish both parts at the same time as follows: Dec. 1 st. at the beg. of the next 12 rows, then cast off the remaining 8 sts.

**To Make Up:** Block and slightly press the parts using a warm iron over a damp cloth. Make 1 row of single crochet along cuffs. Draw a  $19\frac{3}{4}$ " length of silk ribbon through open-work row.

**BOOTEES Figure XII**

**SECTION A:** Set needles in 2-1 division for Continental Ribbing with size of stitch  $4\frac{1}{2}$ , and cast on 44 sts. over 65 needles. Knit 60 rows and place loops of cast-on edge on to machine for hem of boot-top. Bring all needles into W.P. and knit 3 rows.

**SECTION B:** Change to size of stitch 5 and cast off 26 sts. at the beg. of the next 2 rows. With the remaining 13 sts. knit 20 rows in stocking stitch without shaping, for in-step.

**SECTION C:** Now cast on 28 sts. at the beg. of the next 2 rows (69 sts.). For sides knit 16 rows in stocking stitch and mark this row with an oddment of wool at the sides. Work a further 10 rows. Now place the loops of the marked rows on to machine to make the cord.

**SECTION D:** Now at right of machine cast off 37 sts., and at left cast off 4 sts. With the remaining 28 sts. knit 18 rows for the sole. Cast off.

**To Make Up:** Join back of bootees and sew the cast off sts. and edges of sole to cord. Join sides to in-step and top. Thread in a silk ribbon of  $21\frac{1}{4}$ " length at ankle between Continental Ribbing and stocking st.

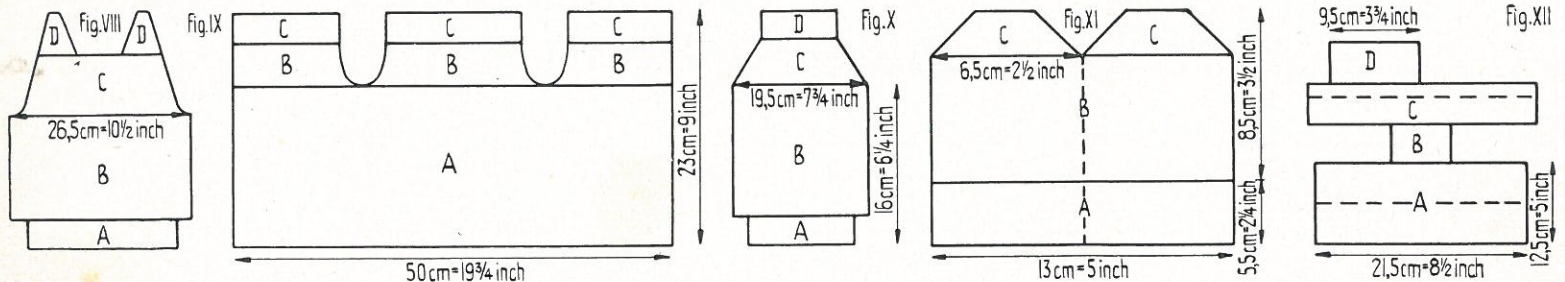



# Little girl's frock for 1-1½ years old

Model Liliane Gindre, Paris

PASSAP-Model M 1233

She still has to grow up a little more, yet she will always wear it with pride— this pretty frock on which open-work and pop-corn design make a most attractive contrast.

**FINISHED MEASUREMENTS:** Full length 14¼", length of skirt 10", length of bodice 4", chest 20½", width across back 8", inner sleeve length 2", width of skirt at hem approx. 59".

**MATERIALS:** 7 ozs. 3-ply Baby-wool (Paton & Baldwins 3-ply Fingering), 1 small button, small quantity Angora Wool.

**SIZE OF STITCH:** For hem 4, other parts 4½.

**TENSION:** Open-work pattern: 13 sts. and 25 rows over 2 square inches. Pop-corn design: 15 sts. and 40 rows over 2 square inches.

**Openwork Pattern for Skirt:** *1st Pattern Series:* Leaving 8 sts. place the 10th st. onto the 9th needle, \* leave 16 sts. place the 18th st. on to the 17th needle. Repeat from \*. Knit 2 rows.

*2nd Pattern Series:* \* Leaving 7 sts. place the 9th st. on to the 8th needle, leave 1 st. place the 11th st. on to the 12th needle and leave 6 sts. Repeat from \*. Knit 2 rows.

*3rd Pattern Series:* \* Leave 6 sts. place the 8th st. on to the 7th needle, leave 3 sts. place the 12th st. on to the 13th needle and leave 5 sts. Repeat from \*. Knit 2 rows.

*4th Pattern Series:* \* Leave 5 sts. place the 7th st. on to the 6th needle, leave 5 sts. place the 13th st. on to the 14th needle and leave 4 sts. Repeat from \*. Knit 2 rows.

*5th Pattern Series:* \* Leave 4 sts. place the 6th st. on to the 5th needle, leave 7 sts. place the 14th st. on to the 15th needle and leave 3 sts. Repeat from \*. Knit 2 rows.

*6th Pattern Series:* \* Leave 3 sts. place the 5th st. on to the 4th needle, leave 9 sts. place the 15th st. on to the 16th needle, and leave 2 sts. Repeat from \*. Knit 2 rows.

*7th Pattern Series:* \* Leave 2 sts. place the 4th st. on to the 3rd needle, leave 11 sts. place the 16th st. on to the 17th needle, and leave 1 st. Repeat from \*. Knit 2 rows.

*8th Pattern Series:* \* Leave 1 st. place the 3rd st. on to the 2nd needle, leave 13 sts. place the 17th st. on to the 18th needle. Repeat from \*. Knit 2 rows.

Repeat these 8 Pattern Series throughout.

**Pop-Corn Design for Bodice and Sleeves:** *1st and 2nd row:* With Pattern Ruler in 1-1 division, push every alt. needle into R.P. starting with the 1st needle, and knit 2 rows. *3rd and 4th row:* All needles W.P. Knit 2 rows. *5th and 6th row:* Push every alt. needle into R.P., starting with the 2nd needle, and knit 2 rows. *7th and 8th row:* As 3rd and 4th row.

These 8 rows form 2 patterns and are repeated throughout.

**Figure I Skirt Knit two identical parts**

**SECTION A:** Cast on 198 sts. and knit 40 rows. Make hem.

**SECTION B:** Knit 96 rows in openwork pattern and take sts. on to a knitting needle.

**SECTION C:** Place work back on machine reducing evenly to 85 needles and knit 4 rows plain stocking stitch. Make the 5th row an openwork row by placing the 4th stitch on to the 5th needle throughout the row. All needles W.P. and knit a further 5 rows in stocking st. Continue with knitting the bodice.

**Figure II Bodice Back Knitted in Pattern throughout**

**SECTION A:** Knit 14 rows in Pop-corn Pattern.

**SECTION B:** *Shape armhole:* Cast off 3 sts. at the beg. of the next 2 rows, 2 sts. at the beg. of the next 4 rows and 1 st. at the beg. of the next 2 rows (69 sts.). For back opening divide work in the exact centre by putting 35th st. on to 36th needle, and using a second ball of wool, continue to knit both parts at the same time. Knit 58 rows.

**SECTION C:** From the centre, cast off 13 sts. on both parts and knit 8 rows.

**SECTION D:** *Shoulder shaping:* At outer edges cast off 7 sts. on every row, 6 times.

**Figure III Bodice Front Knitted in Pattern throughout**

**SECTION A:** Knit as for Back.

**SECTION B:** *Shape armhole* exactly as for back, then knit 34 rows.

**SECTION C:** *Shape neckline:* Cast off 27 sts. at exact centre of work and using a second ball of wool knit 32 rows for both parts at the same time (21 sts. each side neck).

**SECTION D:** *Shoulder shaping:* At outer edges cast off 7 sts. on every row, 6 times.

**Figure IV Sleeves Knitted in Pattern throughout**

**SECTION A:** Using an odd ball of wool cast on 80 sts. and knit a few rows, then 2 rows in main wool.

**SECTION B:** Set row counter at 0 and knit 38 rows with main wool in Pop-corn Pattern.

**SECTION C:** *Shape top:* Dec. 2 sts. at the beg. of the next 4 rows, then dec. 1 st. at both ends of every following 4th row, 12 times. Continue by dec. 2 sts. at the beginning of the next 4 rows and cast off the remaining 40 sts.

**SECTION D:** Unravel the odd wool and place the work on to machine dec. evenly to 52 stitches. Knit 16 rows and cast off.

**To Make Up:** Block and slightly press each part using a warm iron over a damp cloth. Join all parts. Fold 8 rows of sleeve borders inside and slip stitch in place. Set in sleeves. Along neckline and back opening crochet 1 row of single crochet, then around neckline only make a picot, using white Angora wool for the crocheting. Now twist a 35½" long cord, thread through at waist and attach a pom-pom to each end of cord. Sew on a button at back-opening.

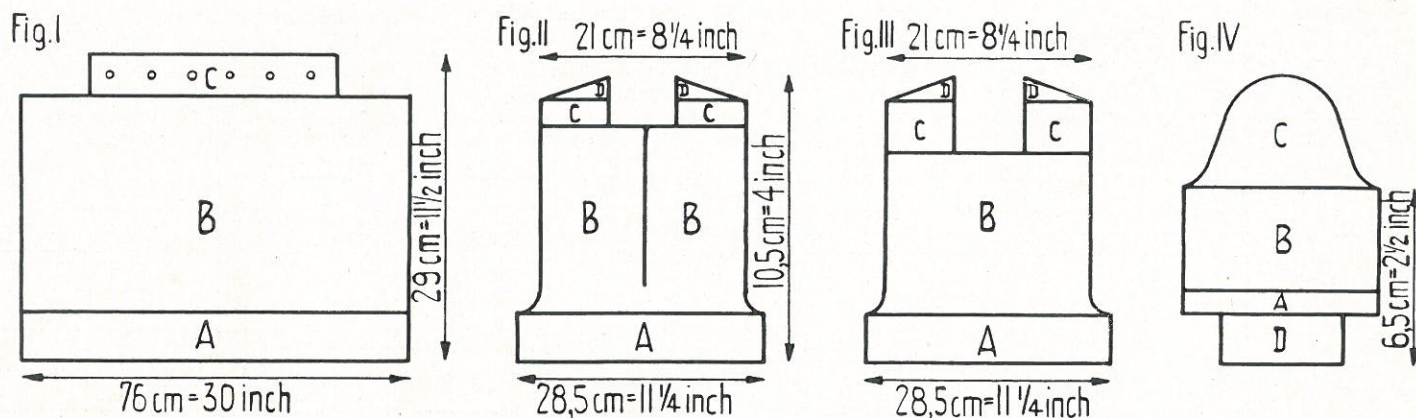







The whole set is knitted two times, once in rose and once in blue wool, and finished in such a way that either side can be worn outside.

The hood is trimmed with soft white Swan's down and a big Swan's down pom-pom is attached to each end of the cord.

All parts are patterned throughout, the purl side being the right side.

# Soft as down

## Baby's Hooded Coat, Bootees and Mittens

PASSAP-Model M 1232

**FINISHED MEASUREMENTS:** *Hooded Coat:* Full length 11", chest 23½", sleeve seam 7", height of hood 6¼", half width 6¾". *Bootees:* Circumference 8", height 1½", length of sole 2¾". *Mittens:* Width 2¼", length 2¾".

**MATERIALS:** 5 ozs. each of rose and blue 2-ply Baby-wool, 10 small white buttons, 31½" of white Swan's down.

**SIZE OF STITCH:** 6.

**TENSION:** 10 sts. and 40 rows over 2 square inches.



**Pattern:** 2 needles W.P., 2 needles N.P. For patterning use universal pattern selector (or blue tool): 2 spades out, 6 spades in. *1st series:* Place pattern selector behind 1st and 2nd needles and bring every alt. pair into R.P. Knit 2 rows. Bring all needles back into W.P. *2nd series:* Same as first, however reversed, i. e. starting with 3rd and 4th needles bring alt. pairs into R.P. Repeat both series throughout.

**COAT** Knit all parts once using rose and once using blue wool

**Figure I Back** For second back shape waist at left

**SECTION A:** Starting at sleeve and using blue wool cast on 18 sts. over 34 needles set in pattern division and knit 132 rows in pattern. At the same time, at right of machine = waist, inc. 1 st. at the beg. of every 16th row, 8 times (26 sts.).

**SECTION B:** Set row counter at 0. Now at right, cast on 28 sts. for side-seam (54 sts.) and knit 124 rows without shaping. Centre back now being reached, knit the other half with reversed shapings.

**Figure II Right Front** Left Front with reversed shapings (waist at left) and omitting buttonholes

**SECTION A:** Starting at sleeve and using blue wool cast on 20 sts. over 38 needles set in pattern division and knit 132 rows in pattern. At the same time, at right (waist-side) inc. 1 st. at the beg. of every 16th row, 8 times (28 sts.). Set row counter at 0.

**SECTION B:** At right, cast on 28 sts. for side-seam (56 sts.) and knit 112 rows.

**SECTION C: Shape neck:** At left of machine cast off 2 sts. at the beg. of every alt. row, 5 times (46 sts.), knit a further 10 rows and take all sts. on to a knitting needle.

**SECTION D:** Turn work so that the knit side is facing. Set needles in 1-1 division for border, place sts. back on to machine over every alt. needle and knit 8 rows. At the same time for corners inc. 1 st. at the beg. of the next 8 rows. When the first 4 rows have been knitted work in 5 buttonholes over the 2nd and 3rd, 12th and 13th, 22nd and 23rd, 32nd and 33rd, and 42nd and 43rd sts. Finish the next 4 rows.

**SECTION E:** Using rose wool knit 4 rows, dec. 1 st. at the beg. of every row. Now work in 5 buttonholes as before. Knit a further 4 rows, again dec. 1 st. at the beg. of every row. Then take all sts. on to a knitting needle.

**SECTION F:** Set row counter at 0. Turn work so that the purl side is facing, set needles in pattern division, i. e. 2 needles W.P., 2 needles N.P. Place the sts. on to machine and knit 10 rows in pattern. Now at left shape neck as follows: Inc. 2 sts. at the beg. of every alt. row, 5 times.

**SECTION G:** Knit 112 rows, then at right (waist-side) cast off 28 sts. for side-seam (28 sts.).

**SECTION H:** Knit 132 rows. At the same time at right (waist-side) dec. 1 st. at the beg. of every 16th row, 8 times. Cast off the remaining 20 sts. straight.

**Figure III Hood** Knit the second piece exactly the same, using rose-colour wool

Using blue wool cast on 28 sts. over 54 needles set in pattern division and knit 280 rows in pattern. Cast off.

**To Make Up (Part):** Join shoulder- and the upper sleeve seams on each coat separately.

**Borders:** When knitting the borders on both coats, the knit side should always be facing. *Neckband:* Along neck-edge pick up 50 sts. and place on to machine over 99 needles set in 1-1 division. Knit 8 rows, at the same time inc. 1 st. at the beg. of the next 8 rows. Take all sts. on to a knitting needle. *Border at lower edge of back:* Pick up 60 sts. and place on to machine over 119 needles set in 1-1 division. Knit 8 rows. Take all sts. on to a knitting needle. *Border at lower edge of front parts:* Pick up 32 sts. at each part and place on to machine over 63 needles set in 1-1 division. Knit 8 rows, at the same time at front edge inc. 1 st. at the beg. of every alternate row 4 times. Take all sts. on to a knitting needle. *Cuffs:* Pick up 20 sts. each and place on to machine over 39 needles. Knit 8 rows and place sts. on to a stitch holder. *Border along lower edge of hood:* Along 1 side-edge pick up 64 sts. and place on to machine over 127 needles. Knit 8 rows and take sts. on to a knitting needle.

**To Make Up:** Sew together rose and blue coat separately, then join borders (rose on to blue) with knit stitch, carefully mitreing corners. Buttonhole-stitch the buttonholes on each coat separately. Slip one coat into the other and join the double hood to neckband with invisible stitches. Make 5 cuff-links from 2 buttons each and insert into the double buttonholes. Knit 1 rose and 1 blue cord of 1 yd. length each (see sleeping bag page 11). Draw the rose-coloured cord through neckband, blue cord through border at hood. Make 2 Swan's down pom-poms and attach to both ends of cords. Trim front edge of hood with Swan's down.

**BOOTEES** Knit each bootee once in blue and once in rose wool

**Figure IV Top**

**SECTION A:** Cast on 40 sts. over 78 needles set in pattern division and knit 30 rows in pattern.

**SECTION B:** Work graduations as follows: *1st graduation:* At left bring 23 needles into R.P. (17 needles for 2nd graduation and 6 needles as centre needles). Knit 2 rows over the remaining 17 sts. at right. Now, following the centre sts. \* bring 2 needles into R.P. and knit 2 rows. Repeat from \* 6 times. Knit a further 2 rows over the re-

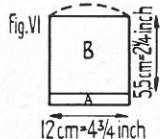
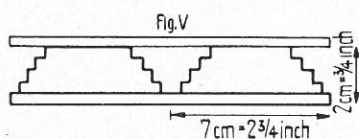
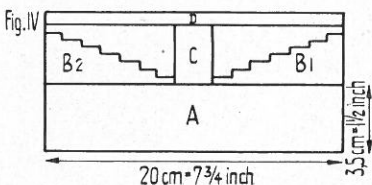
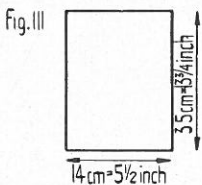
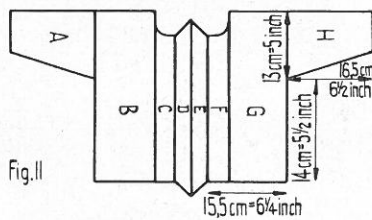
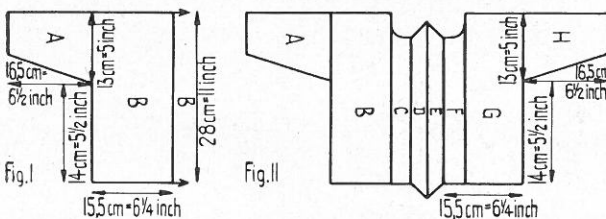



and ever so warm is this . . .



maining 3 sts. at right. Bring 14 needles back into W.P. (17 sts. W.P.), knit 2 rows and take these 17 sts. and the 6 centre sts. on to a knitting needle.

**2nd graduation:** Bring the remaining 17 needles at left back into W.P. and work the respective graduations starting from centre and working to the left. Then take the 17 sts. on to a knitting needle.

**SECTION C: In-step:** Set needles: 1 needle W.P., 1 needle N.P. Turn work, place the 6 centre sts. on to machine and knit 12 rows.

**SECTION D: Border:** Using same needle division, place the 17 sts. right and left of the centre sts. on to machine, knit 6 rows and place all sts. on to a knitting needle.

#### Figure V Sole

With size of stitch 3 and normal needle division, cast on 40 sts. and knit 2 rows. Divide work in the exact centre and using a second ball of wool, knit both parts at the same time as follows: Bring 2 needles forward into R.P. at the beg. of the next 8 rows. All needles back into W.P., knit 2 rows and cast off.

**To Make Up:** At top sew in-step (Section C) to Section B. Fold the sole in half, sew cast-on edge together and set in sole. Join borders of one blue and 1 rose bootee with knit-stitch. Join back seam of each part separately. Knit 4 cords in all of 15¾" length each, 2 cords using blue and 2 using rose wool. Draw cords through between border and patterned part of same coloured bootee. If you like twist a fine cord and sew around sole and in-step. Slip the finished parts one into the other to make double bootees.

#### Figure VI Mittens Knit each mitten once in rose and once in blue wool

**SECTION A:** For border set needles in 1-1 division and cast on 24 sts. Knit 12 rows and take sts. onto a stitch holder.

**SECTION B:** Set row counter at 0 and needles in pattern division. Turn work, place back on to machine. Knit 44 rows in pattern, then 2 rows in stocking stitch. Take the sts. on to a knitting needle and work 2 rows by hand knitting 2 sts. together throughout to reduce sts. Gather and sew up the remaining sts.

**To Make Up:** Join mittens, fold borders in half and slip-stitch inside. Knit 2 cords 15¾" long and thread in at border. The mittens can either be worn singly or one slipped into the other.

## Double-faced Cover for hot-water Bottle

PASSAP-Model BM 1222

Knitted on the Ribbing Attachment

The cover is knitted in one piece only, on the Ribbing Attachment in simple fisherman's rib, right half in blue, left half in rose wool. The Group I side is outwards.

**FINISHED MEASUREMENTS:** Circumference 11½", height 12¼"

**MATERIALS:** 3 ozs. each of blue and rose Baby-wool 4 ply.

**SIZE OF STITCH:** 4.

**TENSION:** 15 sts. and 45 rows over 2 square inches.

**Pattern:** Knitted on R/A in 1 plain - 1 purl simple fisherman's rib, Instruction Booklet figs. 40 and 40a.

#### Figure VII Cover for hot-water Bottle

Using blue wool cast on 182 sts. in 1 plain - 1 purl rib and knit 1 row. From now on knit 91 sts. using blue and 91 sts. using rose wool, being careful to cross the threads in the middle. Knit 280 rows in this manner and cast off.

**Bottoms:** Knit 2 strings 59" long, using blue wool for one and rose wool for the other. From these strings sew 2 flat round bottoms 4" in diameter.

**To Make Up:** With Group II side outwards (fisherman's rib), make a double tube from the one square you have knitted by sewing together each colour separately, thus forming one single seam along the middle (crossed changing of colours). Attach the bottoms at the same ends of the corresponding tubes. Crochet 1 row of single crochet around each opening and put the tubes one into the other. Knit a 47" long string, 23½" in blue and 23½" in rose wool, attach a pom-pom to each corresponding end of string. Now fold the string double and wind around bottle-neck.

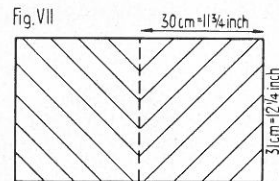

## Double-faced Milk-Bottle Warmer

PASSAP-Model BM 1223

Knitted on the Ribbing Attachment

The bottle-warmer is knitted in 2 parts in simple fisherman's rib. The Group II side is the right side.

**FINISHED MEASUREMENTS:** Circumference 6¾", height 6¾"

**MATERIALS:** 1 oz. each of rose and blue Baby-wool 4 ply.

**SIZE OF STITCH:** 4.

**TENSION:** 15 sts. and 45 rows over 2 square inches.

**Pattern:** Knitted on R/A in 1 plain - 1 purl simple fisherman's rib, Instruction Booklet figs. 40 and 40a.

#### Figure VIII Bottle-Warmer

Knit 1 part in blue and 1 part in rose

Cast on 41 sts. in 1 plain - 1 purl rib, knit 153 rows and cast off.

**Bottoms:** Knit exactly as described for hot-water bottle cover, but only 53" long.

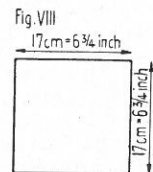

**To Make Up:** Join the two parts so that the Group II side is outside. Attach bottoms. Crochet 1 row of single crochet around both upper edges, then 1 row of insertion (1 double crochet, 5 loops, 1 double crochet, etc.). Knit a 24" long string, 12" in blue and 12" in rose. Put the parts one into the other, draw the string through insertions at both parts. Make a rose and blue pom-pom and attach one to each end of string.



# ... pretty Set for Baby's

## Baby's Sleeping Bag for 2-4 months old

PASSAP-Model M 1231 Model: Liliane Gindre, Paris

Isn't this a very nice little fish?

This warm sleeping bag with long sleeves is knitted in plain stocking stitch. The finishing touch gives a 4" wide patterned flounce, gathered with a silk ribbon.

**FINISHED MEASUREMENTS:** Full length 29½", width of bag 37½", width across back 10", inner sleeve length 7", upper sleeve width 8".

**MATERIALS:** 9 ozs. rose-coloured 3-ply Baby-wool. 3 yds. silk ribbon 1 inch wide.

**SIZE OF STITCH:** For plain and pattern 5, for Ribbing Attachment 4.

**TENSION:** 16 sts. and 26 rows over 2 square inches.

**Pattern for Flounce:** Set stripper to 3 and needles as follows: 3 needles W.P., 2 needles N.P., 1 needle W.P., 2 needles N.P., finishing with 3 needles W.P. Knit 1 row in this setting, then bring all the single needles into R.P. and knit 3 rows. Repeat these 4 rows throughout.

Figure I Back of Bag

**SECTION A:** Cast on in pattern division 79 sts. for the flounce and knit 152 rows in pattern. Place all sts. on to a stitch holder.

**SECTION B:** Turn work and hang back on machine. Bring the needles from N.P. into W.P. and knit 4 rows plain stocking stitch over all needles (155 stitches).

**SECTION C:** Work 8 buttonholes as follows: Divide the work in 9 parts, i. e. 18 needles once, 17 needles 7 times and 18 needles once, and using 9 balls of wool knit 8 rows.

**SECTION D:** For main part of bag knit 234 rows in stocking stitch with all needles and using 1 ball of wool. Take all stitches on to a knitting needle.

**SECTION E:** For Bodice: Hang all sts. back on machine, placing 2 sts. on every alt. needle. Knit 4 rows with 100 stitches.

**SECTION F:** Armhole: Dec. 3 sts. at the beg. of the next 4 rows, 2 sts. at the beg. of the following 4 rows and 1 st. at the beg. of the next 4 rows (76 sts.).

**SECTION G:** Knit 18 rows, at the same time inc. 1 st. at both ends of every 6th row, 3 times (82 sts.).

**SECTION H:** Knit 34 rows without shaping.

**SECTION J:** Shape shoulders by casting off 3 sts. at beg. of next 16 rows. Knit a further 6 rows with remaining 34 sts. for back-neck, cast off.

Figure II Front of Bag

Repeat from Section A to Section D (see Back of Bag).

**SECTION E:** Waist-welt: Fix R/A setting needles in 1-1 division. Transfer every alt. needle from Group I to Group II, knit 14 rows in 1 plain-1 purl normal rib, cast off.

Figure III Bodice Left Front

Right front knitted with reversed shapings

**SECTION A:** Cast on 75 sts. and knit 6 rows in stocking stitch. At the same time at right of machine inc. 1 st. on every alt. row, 3 times (78 sts.).

**SECTION B:** Knit 68 rows plain, at the same time at right, shape neck as follows: Dec. 1 st. on every alt. row, 34 times. At left, shape armhole by dec. on every alt. row 3 sts. twice, 2 sts. twice and 1 st. twice, then cont. armhole shaping by inc. 1 st. on every 6th row, 3 times.

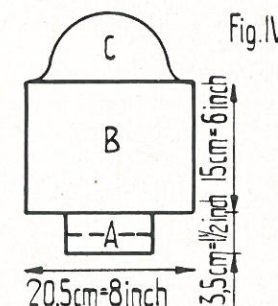
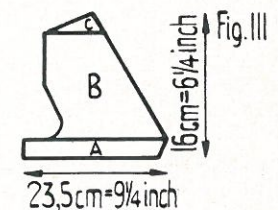
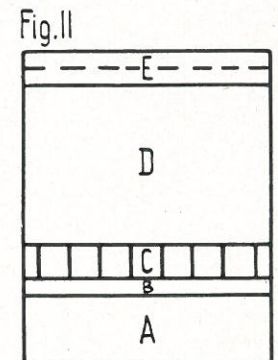
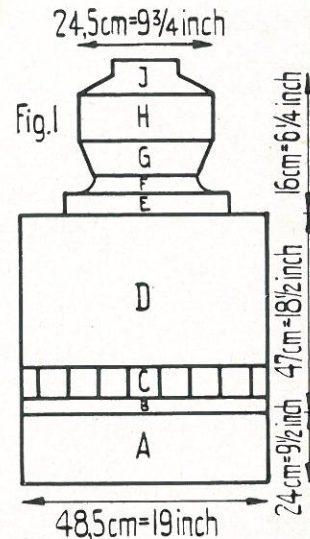



# first winter elegance

**SECTION C: *Shape shoulder:*** At left of machine cast off 3 sts. on every alt. row, 5 times, then 4 sts. on every alt. row 3 times. At right of machine cont. neckline by dec. 1 st. on every alt. row, 8 times.

**Figure IV Sleeves**

**SECTION A:** Cast on 40 sts. and knit 40 rows in stocking stitch, place loops of cast-on edge on to machine for hem and knit 1 row. Take all sts. on to a knitting needle inc. evenly 26 stitches (66 stitches).

**SECTION B:** Place these 66 sts. back on machine and knit 80 rows without shaping.

**SECTION C: *Shape top:*** Dec. 3 sts. at the beg. of the next 2 rows, 2 sts. at the beg. of the next 4 rows, 1 st. at beg. of following 6 rows, 2 sts. on next 4 rows, 4 sts. on next 4 rows and 5 sts. at beg. of following 2 rows. Cast off remaining 12 sts. at once.

**Neckband:** Along neck edge of bodice front pick up all sts., place on to machine and knit 6 rows, at the same time at lower edge dec. 1 st. on every alt. row, 3 times for corner.

**To Make Up:** Block and press each part using warm iron over damp cloth. Close side seams of bag. Fold flounce in half and slip-stitch inside. Buttonhole-stitch around buttonholes. Turn waist-welt inside and slip-stitch in place. On bodice, fold borders along neckline, and back-neck as well as the lower edge inside (6 rows each) and stitch in place. Join shoulders and sew front parts of bodice to bag as follows: Starting from side seam sew bodice to bag for about

1 inch only on top of waist-welt. Set in sleeves. Sew 3 1/2" of silk ribbon to each corner of bodice-parts. Draw 39" of silk ribbon through the buttonholes starting at front centre, gather flounce and make a nice bow.

## Baby's Sleeping Bag - double faced

PASSAP-Model BM 1212

### Knitted on the Ribbing Attachment

The bag is made up of two 2-coloured pieces and cleverly finished in such a way that either the blue or the rose coloured side can be worn outwards just as is required.

**FINISHED MEASUREMENTS:** Full length 20 1/2", width at lower edge 17 3/4", length of straps 7", length of cord 1 yd. 31 ins.

**MATERIALS:** 5 1/2 ozs. each blue and rose wool (Ladyship Babyship), 2 blue and 2 rose, mother-of-pearl buttons.

**SIZE OF STITCH:** Waist-welt and straps 5 1/2. Bag 6.

**TENSION:** 15 sts. and 24 rows over 2 square inches.

**Pattern:** The waist-welt and straps are knitted in 2 plain - 1 purl normal rib—the bag parts are in 2 plain - 1 purl fishermans rib. (See Instruction Book figs. 40 and 40a.) Group II side is the right side.

### Sleeping Bag

#### Knit 2 identical parts

**SECTION A:** Using rose wool cast on 149 sts. in 2 plain - 1 purl. With size of stitch 6, knit 200 rows in simple fishermans rib.

**SECTION B: *Waist-welt:*** With size of stitch 5 1/2 knit 60 rows in 2 plain - 1 purl normal rib.

**SECTION C: *Waist-welt:*** Set row counter at 0 and using blue wool knit a further 60 rows in normal rib.

**SECTION D:** With size of stitch 6 knit 200 rows in 2 plain - 1 purl simple fishermans rib. Cast off.

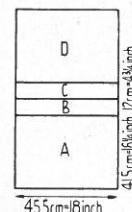

### Straps

#### Knit 2 identical parts

**SECTION A:** Using rose wool cast on 21 sts. and knit 90 rows in 2 plain - 1 purl normal rib.

**SECTION B:** Set row counter at 0 and using blue wool continue knitting another 90 rows in 2 plain - 1 purl normal rib. Cast off.

**Cord:** Using rose wool cast on 4 sts. over 7 needles in 1-1 division. Pull up right freesetter knob, keep this in position until cord is finished, i. e. from right to left knit, from left to right move lock back without knitting. Knit until 33 1/2" of cord is done. Now change colour of wool and work a further 33 1/2". Cast off.

**To Make Up:** Place the two bag pieces, one on the other, rose to rose and blue to blue and sew all round. On part of bag (front)—transfer lines from simple fishermans rib to normal rib—undo 12 stitches at exact centre of each piece for buttonholes. Pick up open stitches and crochet round thus making 1 rose and 1 blue buttonhole. Slightly press seams and buttonholes using a warm iron over damp cloth. Slip parts one into other making a double-bag. The normal ribbed waist-welt is now double and forms the small bodice. Starting from buttonholes which are now placed one on the other, draw the cord through at waist and attach a big rose-blue pom-pom at each end. Fold straps in half at change of colours, sew together with back stitch and attach to back of bodice approx. 3" away from side-seams. Close loose ends of straps for about 3/4" using openings as buttonholes. At front of sleeping bag sew on two buttons each at inside and outside.









# Charming Party-Dress for 12 to 18 months old

PASSAP-Model M 1215

**FINISHED MEASUREMENTS:** Full length 13 $\frac{3}{4}$ ", length of skirt 9 $\frac{3}{4}$ ", length of bodice 4", chest 20 $\frac{1}{2}$ ", width across back 8", sleeve seam  $\frac{3}{4}$ ", upper sleeve width 6 $\frac{1}{2}$ ".

**MATERIALS:** 7 ozs. medium baby-wool and 4 glass-buttons.

**SIZE OF STITCH:** For hem 4 $\frac{1}{2}$ , all other parts 5.

**TENSION:** 15 sts. and 25 rows over 2 square inches.

**Pattern 1 for Skirt:** Be careful to take off the stitches in exactly the given order so that when placing them back on the machine the chain-stitch is formed properly on the knit-side.

**1st pattern row:** \* Leaving 21 sts., take first the 22nd and then the 23rd sts. onto the decker-needle and put both sts. onto the 22nd needle (22nd st. underneath the 23rd st.). Bring the 24th needle into R.P. as centre-needle. Now take the 26th st. and then the 25th st. onto the decker-needle and place both sts. onto the 26th needle (25th st. underneath). Push the empty needles back into N.P. Repeat from \* to end of row. Knit 2 rows.

**2nd pattern row:** Leaving 20 sts., take the 21st st. and then the 22nd st. onto the decker-needle and place both sts. onto the 21st needle. Place the 27th st. and then the 26th st. onto the decker-needle and put both sts. onto the 27th needle. The 24th needle remains in R.P. Push the empty needles back into N.P. \* Leaving 19 sts. in W.P., repeat needle setting for open work \* until the whole row is set in pattern. Knit 2 rows.

**3rd pattern row:** Leaving 19 sts. take up the 20th and 21st sts. and place onto the 20th needle, then place the 28th and the 27th sts. onto the 28th needle. The 24th needle remains in R.P. Push the empty needles in N.P. \* 17 sts. in W.P. repeat pattern setting \* to end of row. Knit 1 row, all needles back into W.P., knit 1 row. With angled point of red tool cast on 3 new sts. from the uppermost loose loops of the treble-needle-groups. Knit 20 rows. Repeat the 3 pattern rows, however reversed.

**Pattern 2 for Bodice and Sleeves:** **1st pattern row:** \* Leaving 4 sts., take the 5th and 6th sts. onto the decker-needle and place both sts. onto the 5th needle. Bring the 7th needle into R.P. as centre needle. Place the 9th st. and then the 8th st. onto the 9th needle and push the empty needles back into N.P. Repeat from \* to end of row. Knit 2 rows. Work the next 2 pattern rows exactly as for Pattern 1, keeping the distance between the open-work accordingly smaller.

## Figure I Skirt

**SECTION A:** Cast on 201 sts. and knit 32 rows. Make hem.

**SECTION B:** Set row counter at 0. Knit 112 rows in pattern 1, setting the needles for 1st pattern row after 10 rows plain have been knitted. Be careful always to

Trifling butterflies  
knitted in delicate open-work pattern  
add gaiety to this lovely little dress

arrange pattern from the centre outwards, i. e. bring centre needles into R.P. After 122 rows in all have been knitted, cast off.

## Figure II Bodice Back

**SECTION A:** Cast on 81 sts. and knit 4 rows. *Shape armhole* as follows: Cast off 4 sts. at the beg. of next 2 rows, 2 sts. at the beg. of next 4 rows and 1 st. at the beg. of following 2 rows (63 sts.).

**SECTION B:** Work Pattern 2, carefully setting needles from centre outwards. Then knit 34 rows plain without shaping.

**SECTION C:** *Shape shoulder* by casting off 7 sts. at the beg. of the next 6 rows. Place the remaining 21 sts. onto a stitch holder.

## Figure III Bodice Front

**SECTION A:** Work exactly as for back.

**SECTION B:** Knit Pattern 2 as for back, then 20 rows plain without shaping. *Divide for neck:* Cast off 9 sts. at exact centre of work and using a second ball of wool continue to knit both sides at the same time as follows: Dec. at neck edge on alt. rows 3 sts. once, 2 sts. once, and 1 st. once.

**SECTION C:** *Shoulder shaping:* At armholes cast off 7 sts. on alt. rows, 3 times.

## Figure IV Sleeves

**SECTION A:** Using an odd ball of wool cast on 81 sts. and knit a few rows.

**SECTION B:** Set row counter at 0 and using main wool knit 6 rows.

**SECTION C:** *Shape top:* Cast off 3 sts. at the beg. of next 2 rows, 2 sts. at the beg. of following 2 rows, 1 st. at the beg. of the next 20 rows and 2 sts. at the beg. of the next 20 rows. Cast off remaining 11 sts. 4 rows after beg. of top-shaping work pattern 2, arranging needles from centre outwards.

**SECTION D:** Unravel the odd wool, pick up the sts. and place onto machine dec. evenly to 48 sts. Knit 16 rows and cast off.

**To Make Up (Part): Neckband:** At back take the 21 sts. from the stitch-holder and place onto machine. Knit 16 rows, cast off. At front pick up 36 sts. and place onto machine. Knit 16 rows. Cast off. Now block and press each part using a warm iron over a damp cloth.

**To Make Up:** Join all parts. Draw a string through upper part of skirt and gather to fit bodice. Sew bodice to skirt on right side with back-stitch so that the cast-on edge of bodice stands out as a small trimming ridge. Set in the puffed sleeves, gathering at top. Turn 8 rows at sleeves and neck-borders inside and slip-stitch in place. Join shoulders for  $\frac{1}{2}$ " only, and single crochet around opening. At front crochet a second row, working 2 loops, then attach buttons at back.

Fig. I

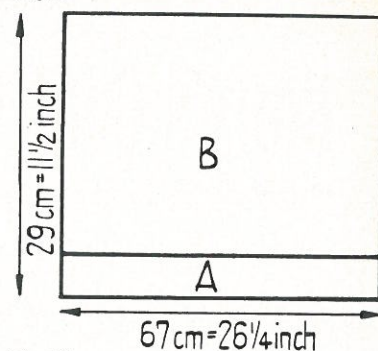

Fig. II

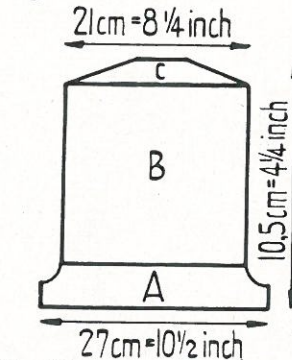

Fig. III

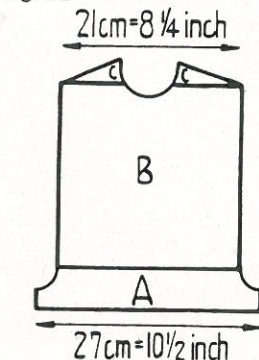
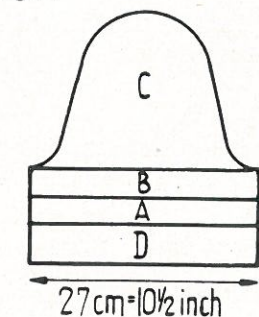

Fig. IV



Continued from page 24

## Baby-Pants for approx. 9 to 12 months old

PASSAP-Model M 1242

**FINISHED MEASUREMENTS:** Waist 20 $\frac{1}{2}$ ", side length 6 $\frac{1}{2}$ ".

**MATERIALS:** 4 ozs. Lyscordet.

**SIZE OF STITCH:** 3.

**TENSION:** 15 sts. and 62 rows over 2 square inches.

**Pattern:** **1st and 2nd row:** With pattern ruler in 1-1 division bring alt. needles into R.P. (starting with the 1st needle) and knit 2 rows. **3rd and 4th row:** Starting with the 2nd needle bring every alt. needle into R.P. and knit 2 rows. Repeat these 4 rows throughout.

## Working Order

**SECTION A:** At waist cast on 80 sts. and knit 5 rows plain. In order to obtain a neat hem-edge make 1 open-work row as follows: Place every

alt. st. on to the following needle and knit the row. Knit 5 rows plain, then place the loops of the cast on edge back on to machine for hem, and knit 1 row. Work another row of insertion as above for the draw-string, then knit 1 row and place all sts. on to a knitting needle. Turn the work and place back on to machine.

**SECTION B:** Knit 188 rows in pattern.

**SECTION C:** *To shape leg opening* dec. 1 st. at both ends of every 5th row, 31 times. For gusset knit 2 rows plain over the remaining 18 sts. First half of pants now being finished, work the second half reversing all shapings.

**Leg-Borders:** With size of stitch 3 $\frac{1}{2}$  pick up 62 sts. along leg opening and place on to machine plain side facing. Knit 5 rows plain, 1 open-work row (for edge), 5 rows plain. Cast off.

**To Make Up:** Block and slightly press pants using a warm iron over a damp cloth. Join side-seams (purl side outside). Fold borders inside and slip stitch in place. Twist a cord 37 $\frac{1}{2}$ " long and draw through insertion. Finish cord with 2 pom-poms.



# Baby's Coat with Matching Cap

PASSAP-Model M 1224



Both coat and cap are knitted in plain stocking stitch (the knit side is the right side) and edged all around with a silky cotton border. The coat is buttoned up at front neck with two buttons.

**FINISHED MEASUREMENTS:** *Coat:* Full length 10", chest 21¼", inner sleeve length 7½", upper sleeve width 8". *Cap:* Front height 6¼", width unstretched 12¾".

**MATERIALS:** 5½ ozs. Patons Quickerknit (to be roughed up with a teazel brush later) Coats Mercer Crochet Cotton No. 10. 2 buttons.

**SIZE OF STITCH:** 4 over alternate needles. **TENSION:** 13 sts. and 16 rows over 2 square inches.

**Pattern:** 1-1 division in plain stocking stitch (1 needle W.P. - 1 needle N.P.) and, when garment is finished, roughed up all over with a teazel brush. All borders are knitted with Coats Mercer Crochet Cotton in plain stocking stitch over all needles.

## Figure I Coat Back

**SECTION A:** Using an odd ball of wool cast on 70 sts. in 1-1 division over 139 needles and knit 6 rows. Set row counter to 0. Now using main wool knit 42 rows.

**SECTION B:** For *armhole shaping* dec. 3 sts. at the beg. of next 2 rows, 2 sts. at the beg. of the following 2 rows and 1 st. at the beg. of the next following 2 rows, then work 28 rows without shaping.

**SECTION C:** For *shoulder shaping* cast off 9 sts. at the beg. of next 4 rows and place the remaining 22 sts. onto a knitting needle.

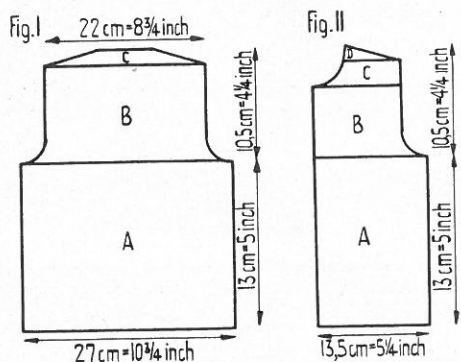

## Figure II Coat Right Front

Left front knitted with reversed shapings

**SECTION A:** Using an odd ball of wool cast on 35 sts. in 1-1 division over 69 needles and knit 6 rows. Set row counter to 0. Now using main wool knit 42 rows.

**SECTION B:** *Armhole shaping:* At right dec. on every alt. row 3 sts. once, 2 sts. once and 1 st. Knit 18 rows without shaping.

**SECTION C:** *Neckline shaping:* At left cast off on every alt. row 4 sts. once, 3 sts. once, 2 sts. once and 1 st. twice, 10 rows in all, finishing at armhole edge.

**SECTION D:** *Shoulder shaping:* At right cast off 9 sts. twice, no sts. remain.

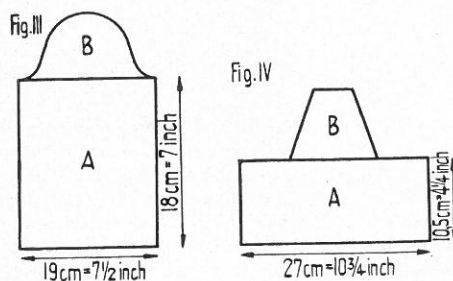

## Figure III Sleeves

**SECTION A:** Using an odd ball of wool cast on 50 sts. in 1-1 division over 99 needles and knit a few rows. Set row counter to 0. Now with main wool knit 55 rows.

**SECTION B:** Shape top as follows: Cast off 3 sts. at the beg. of next 2 rows, 1 st. at the

beg. of next 16 rows and 2 sts. at the beg. of next 4 rows. Cast off the remaining 20 sts.

**Borders:** Unravel the odd wool at back and front parts. Pick up all sts. onto a knitting needle and place on machine using normal needle division. Using cotton thread knit 20 rows as follows: Inc. 1 st. at the beg. of first 10 rows, knit following 10 rows dec. in same manner for corners. Along front edges pick up 60 sts. and place on machine, with cotton thread and knit 20 rows. At the same time for corners inc. 1 st. at the beg. of first 10 rows, dec. next 10 rows in same manner. At one front border work 2 buttonholes 3 sts. wide, starting approx. 12 sts. from neck edge, on rows 5 and 15. Join shoulder seams. Now along neck edge, right and left of sts. on knitting needle (back neck) pick up 26 sts. each and place all 74 sts. on the machine. With cotton thread knit 20 rows for neckband. At the same time, for the corners inc. 1 st. at the beg. of first 10 rows, dec. on following 10 rows in same manner. Unravel the odd wool on sleeve edges, pick up all sts. and place on machine. Knit 20 rows with cotton thread. Cast off.

**To Make Up:** Block and slightly press each part using a warm iron over a damp cloth. Join seams. Carefully mitre corners except those on buttonhole-band. Join the latter at upper and lower edge only keeping the middle open for another buttonhole. Fold borders in half and slip stitch inside. Stitch around double buttonholes and attach buttons. Set in sleeves. Now with a teazel brush rough up the wool thoroughly on right side of garment.

## Figure IV Cap

**SECTION A:** Using an odd ball of wool cast on 70 sts. in 1-1 division over 139 needles and knit a few rows. Set row counter to 0. Knit 34 rows with main wool.

**SECTION B:** Cast off 20 sts. at the beg. of next and following row and with the remaining 30 sts. knit 34 rows, at the same time dec. 1 st. at both ends of every 6th row 5 times. After all 34 rows have been knitted cast off.

**Border:** Unravel the odd wool, pick up the sts. and place on machine. With cotton thread, knit 20 rows as follows: at the beg. of the first 10 rows inc. 1 st. and at the beg. of the following 10 rows dec. in same manner.

**To Make Up:** Join the sides of Section B to the 20 cast off sts. on both sides of Section A. Work neck border as described above, carefully mitre the corners. Fold border in half and slip stitch inside. Pull an elastic thread through neck border to ensure proper fit. Attach a 15¾" length of silk ribbon to each corner of cap. Attach thoroughly rough up the wool with teazel brush.



# Leggings for approximately one year old

PASSAP-Model M 1140

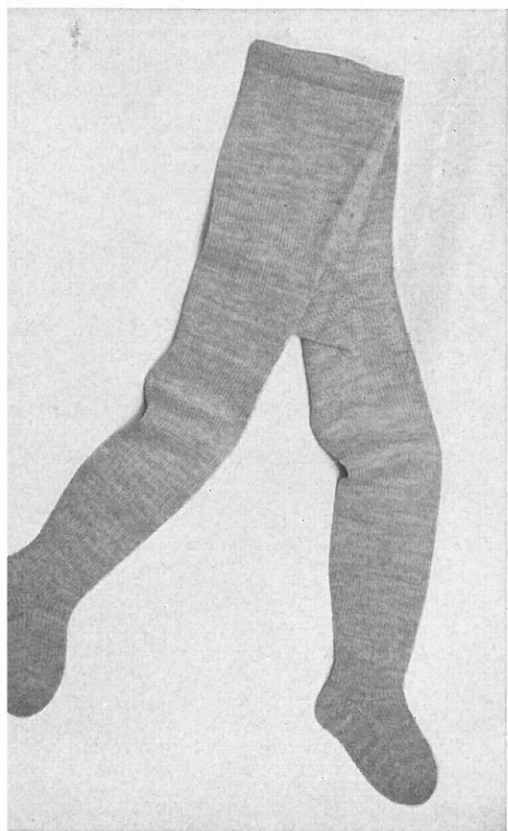

**FINISHED MEASUREMENTS:** Waist 20½". Front length from waist to gusset 7½". Inner leg length 10".

**MATERIALS:** 5½ ozs. of non-shrink medium wool (Patons 4-Ply Nylox), approximately 20 ins. elastic

**SIZE OF STITCH:** 4½.

**TENSION:** 16 stitches and 24 rows over 2 sq. ins.

**Pattern:** Plain stocking stitch, plain side is outside.

**Left Leg: Right leg is knitted with reversed shapings**

**SECTION A:** Cast on 80 stitches and knit 20 rows. Make hem by placing loops of cast-on edge back on to machine.

**SECTION B:** On right side of machine (back centre) make 6 graduations for back as follows: At left (front centre) bring 75 needles into R.P. and knit two rows over the remaining 5 stitches. \* Push 5 needles back into W.P. and knit 2 rows. Repeat from \* 4 times.

**SECTION C:** Bring all needles back into W.P. and knit 90 rows without shaping. End of centre back now being reached, displace back seam so that it now comes at back centre of the leg: At left (front centre) bring 55 needles into R.P. and using an odd ball of wool knit a few rows over the remaining 25 sts. at right (back centre). Throw off the stitches. Using an odd ball of wool cast on 25 stitches at the left and knit a few rows. Bring the 55 sts. from R.P. back into W.P. (later on, unravel the odd wool and join the thrown off sts. and the newly cast on sts. with knit-stitch).

**SECTION D: Leg:** Knit 4 rows straight.

**SECTION E: For upper leg:** Decrease 1 st. at the beg. of the next 18 rows.

**SECTION F:** Knit 16 rows without shaping.

**SECTION G: For calf dec.** 1 st. at both ends of every 4th row, 9 times.

**SECTION H:** Knit 16 rows straight.

**SECTION J:** Push 22 needles into R.P. at the exact centre of work and, using an odd ball of wool, knit a few rows over the 11 sts. remaining at each side. Then throw off the sts. Bring the 22 needles from R.P. back into W.P. and knit 30 rows without shaping, for the in-step.

**SECTION K: Shape toe:** At the beg. of every following row bring 1 needle into R.P. until only 5 needles remain in the centre. Now, again at the beg. of every following row, push 1 needle back into W.P. until all needles are in W.P. again.

**SECTION L:** Continue by knitting 30 rows without shaping for sole.

**SECTION M:** Work the heel exactly like the toe, being careful however, that 7 sts. remain in the centre. Place the sts. on to a stitch-holder.

**Gusset:** Cast on 26 stitches and knit 37 rows. Cast off loosely.

**To Make Up:** Block and press both parts using a warm iron over a damp cloth. Unravel the odd wool at Section J, place the 22 sts. (2 times 11 sts.) on to a knitting needle and join them to the heel sts. with knit-stitch. Close the seam at back of leg. At each leg join the open sts. of Section C with knit-stitch. Sew the in-step on to the sole, then join the two parts—front centre to front centre—back centre to back centre—. Set in gusset like this ♦ thread in elastic.

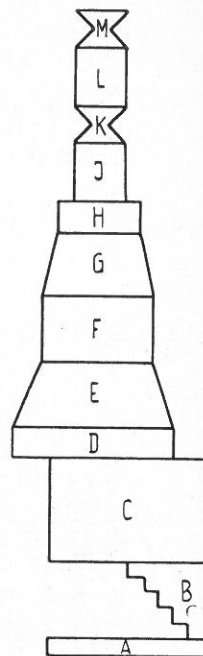

# Double-faced Pram-Cover

PASSAP-Model BM 1241

**Knitted with the Ribbing Attachment**

This softest of all covers can be used both sides and consists of two 2-coloured parts slip-stitched together.

**FINISHED MEASUREMENTS:** 23¾" long and 21" wide.

**MATERIALS:** 4 ozs. each of rose and blue Baby-Crepe-wool, 4 ozs. Quilting Cotton in white.

**SIZE OF STITCH:** 6.

**TENSION:** 13 sts. and 21 rows over 2 square inches.

**Pattern:**

Needle division: 1-1 for Group I, 3-1 for Group II.

Group I: N.P. I ° I ° I ° I ° I ° I ° I ° I ° etc.

Group II: -I---I---I---I-

Knit 3 rows, bringing Group II into lowest position (¼ turn) when knitting 3rd row. Place Quilting Cotton between Group I and Group II and finish full turn = working position. Repeat these 3 rows throughout. Group II side is the right side.

**Cover Knit two identical parts**

Cast on 141 sts. in rose and knit 254 rows (84 patterns). Cast off. Knit second part exactly alike using blue wool instead of rose.

**To Make Up:** Join both covers with slip stitch and block to measure. Cover with damp cloth and let rest until dry. Twist a 4-fold cord with Quilting Cotton and trim neatly around all 4 sides of cover.

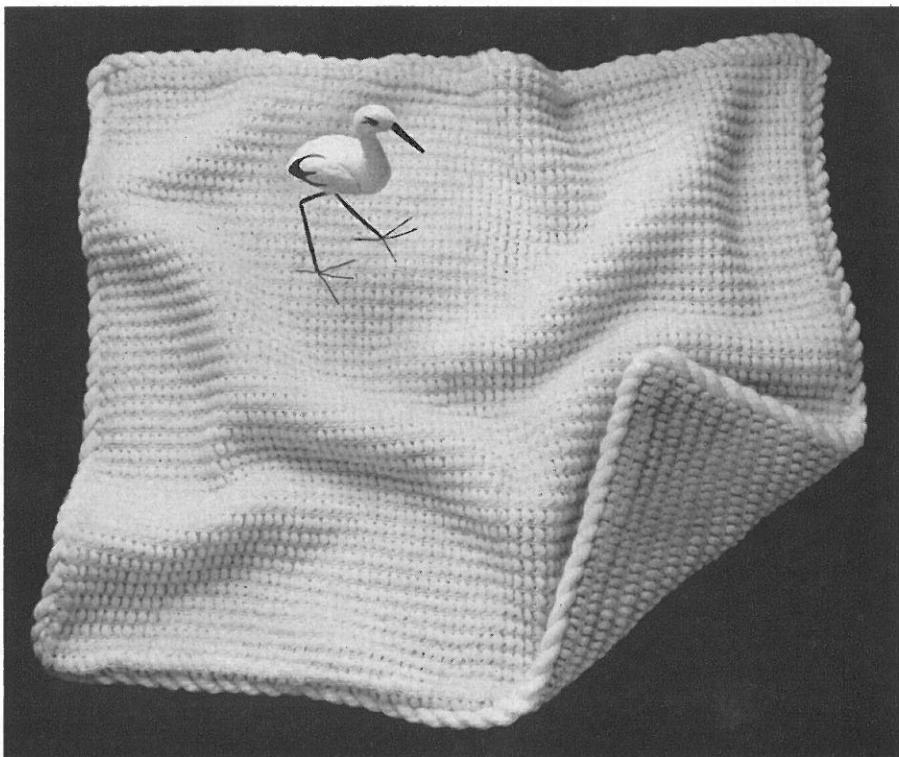



# Dressy skirt with bolero for 2-3 years old

PASSAP-Model M 1217

The skirt is knitted in plain stocking stitch with gay red and white trimmings. It has straps and is fully gathered in at the waist.

The bolero is plain red and edged with a red and white border.

## FINISHED MEASUREMENTS:

*Skirt:* Length without straps  $9\frac{1}{2}$ " , full length with straps  $13\frac{1}{2}$ " , waist  $20\frac{1}{2}$ " .

*Bolero:* Width at lower edge 22" , width across back  $10\frac{3}{4}$ " , full length  $8\frac{1}{4}$ " .

**MATERIALS:** 7 ozs. red and 2 ozs. white medium wool (Patons Super Fingering 3-ply).

**SIZE OF STITCH:** 4.

**TENSION:** 8 sts. and 12 rows over 1 square inch.

**Pattern for Trimmings:** Place pattern ruler in 2-2 division behind first pair of needles and bring the corresponding needle-pairs into R.P., knit 3 rows red. Before knitting the 3rd row lift the outside freesetter-knob, knit the row, now push freesetter down and lock back. Knit 2 rows white. Repeat these 5 rows however reversed, i. e. starting with 3rd and 4th needle.

*Broad stripe:* Before knitting 3rd, 5th, 13th, 15th, 23rd, 25th rows, use freesetter. Knit 28 rows ending with 3 rows red.

*On small stripe,* 3rd, 5th rows only freesetter needed. Knit 13 rows also ending with 3 rows in red.

## Figure I Skirt

### Knit 2 identical pieces

**SECTION A:** Cast on 201 stitches and knit 40 rows. Then place loops of cast-on edge one by one into the open latches to make hem. Set row counter at 0.

**SECTION B:** Knit 6 rows plain red.

**SECTION C:** Knit 28 rows in pattern for broad stripe.

**SECTION D:** Knit 12 rows plain.

**SECTION E:** Work 13 rows in pattern for small stripe.

**SECTION F:** Knit 12 rows plain, repeat Sections C and D, cast off all stitches.

## Figure II Waistband

**SECTION A:** Cast on 160 stitches and knit 6 rows.

**SECTION B:** For pattern stripe knit 13 rows in pattern ending with 3 rows red.

**SECTION C:** Knit a further 24 rows plain and cast off.

## Figure III Straps (two)

**SECTION A:** Cast on 82 sts. and knit 12 rows plain red.

**SECTION B:** For stripe knit 13 rows in pattern.

**SECTION C:** Knit 12 rows plain and cast off all stitches.

**To Make Up:** Block and press each part using a warm iron over a damp cloth. Join side seams. Now gather skirt in at the waist and attach waistband. Slip stitch waistband seam inside. Make seam at centre of back-side of straps and attach straps to skirt.

## Figure IV Bolero Back

**SECTION A:** Cast on 70 sts. and knit 12 rows, inc. 1 st. at both ends of every 3rd row, 4 times, for corners.

**SECTION B:** Knit 2 rows, dec. 1 st. at both ends of 2nd row.

**SECTION C:** Work 13 rows in pattern, dec. 1 st. at both ends of every 5th row, twice.

**SECTION D:** Knit a further 2 rows, dec. 1 st. at both ends of the 2nd row. Now hang loops of cast-on edge into latches, thus making hem.

**SECTION E:** Knit 82 rows, at the same time inc. 1 st. at both ends of every 12th row, 6 times.

**SECTION F: Shoulder shaping:** Cast off 5 sts. at beginning of next 12 rows.

**SECTION G:** Work with remaining 22 sts. as follows: Knit 2 rows plain red, 13 rows in pattern, then 14 rows plain. Cast off.

## Figure V Right Front

### Left front knitted with reversed shapings

**SECTION A:** Cast on 34 sts. and knit exactly as for Section A Back.

**SECTIONS B, C and D:** Ditto as for back.

**SECTION E:** Knit 24 rows at the same time at *right* inc. 1 st. on rows 12 and 24.

**SECTION F:** Knit 58 rows. At *right* cont. to inc. 1 st. on every 12th row, 4 times and at *left* dec. 1 st. on every 5th row, 10 times.

**SECTION G: Shoulder shaping:** At *right* cast off 5 sts. at beginning of next 6 alternate rows.

**Borders: Sleeves (knit 4 identical parts):** At *Back* pick up 54 sts. along sleeve edge and side edge and place on machine. Knit border as follows: 2 rows plain, 13 rows in pattern, 2 rows plain. At the same time inc. 1 st. at both ends of every 4th row, 4 times. Now work a further 12 rows for hem, dec. 1 st. at both ends of every 3rd row 4 times.

At *Front:* Pick up 54 stitches at sleeve edge and knit borders in same manner as for back.

**Front Centre:** (Knit 2 identical parts.) Pick up 60 stitches along front centre and place on machine. Knit as follows: 2 rows plain, 13 rows in pattern, 2 rows plain. At the same time at *waist* inc. 1 st. on every 4th row, 4 times, work shoulder without shaping. Knit a further 12 rows. *Dec. at waist* 1 stitch on every 3rd row, 4 times. Keep shoulder straight.

**To Make Up:** Block and press each part using a warm iron over a damp cloth. Join shoulder seams and centre front and back borders. Fold all borders inside and slip stitch in place. Join sides for 2 inches only.

Fig. I

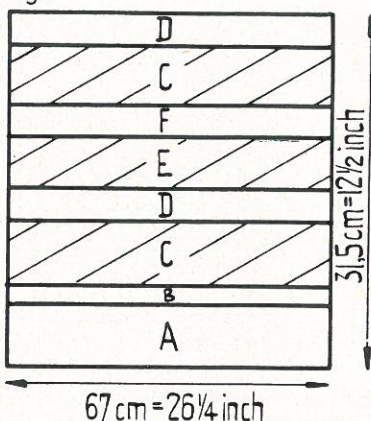

Fig. II

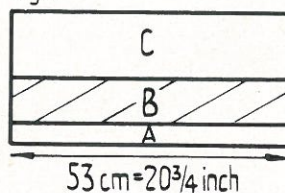

Fig. III

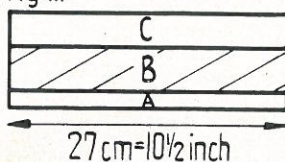

Fig. IV

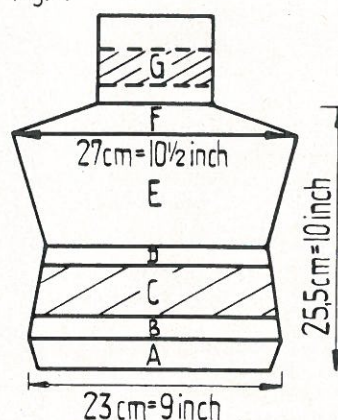
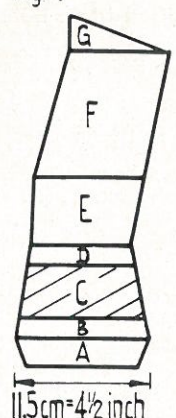

Fig. V









# Play-dress and Rompers for 1-1½ years old

Bodice knitted with the Ribbing Attachment

PASSAP-Model BM 1236

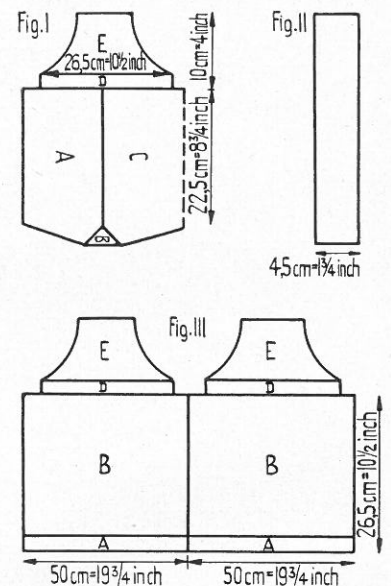
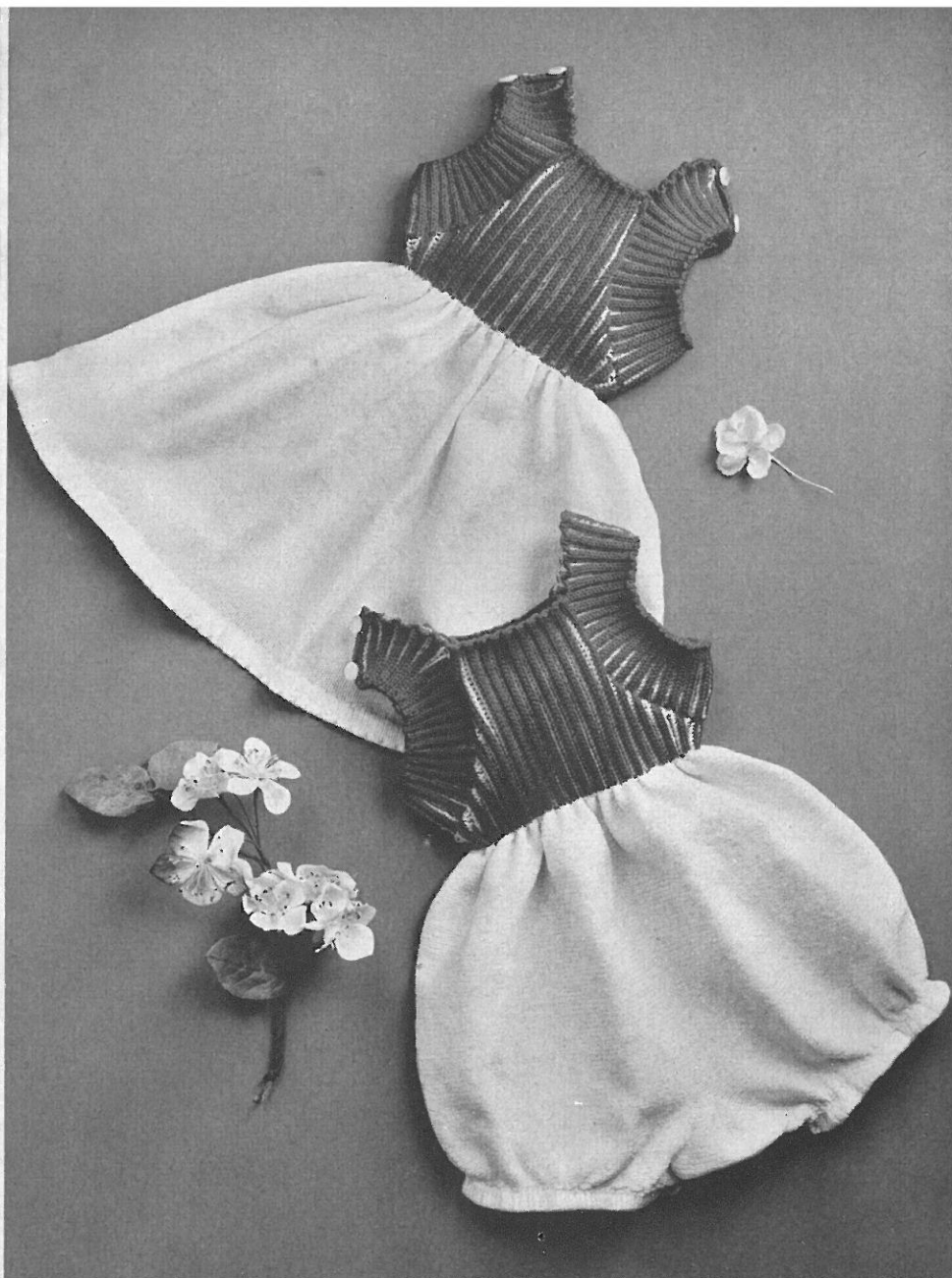

**Rompers:** The pants are white and knitted lengthwise in plain stocking stitch, closed with 4 mother-of-pearl buttons at gusset. The bodice is knitted on R/A in 2 plain - 2 purl simple fisherman's rib in red and white, and buttoned up at the shoulders with 2 mother-of-pearl buttons each side. **Dress:** The wide round skirt is white and knitted in plain stocking stitch. Bodice same as for rompers.

**FINISHED MEASUREMENTS:** *Rompers:* Full length 15", length of pants 8¾", length of bodice 4", chest 20½". *Dress:* Full length 15", length of skirt 8¾", length of bodice 4", chest 20½".

**MATERIALS:** 8 ozs. Patons Beehive Fingering 3-ply in white, 3 ozs. ditto in red, buttons, length of elastic.

**SIZE OF STITCH:** 5 for stocking stitch, 5½ for pattern.

**TENSION:** Stocking stitch: 16 sts. and 30 rows over 2 square inches  
Pattern: 16 sts. and 39 rows over 2 square inches.

**Pattern 2 colours:** With R/A in 2 plain - 2 purl, starting with white. *1st row:* With Group II in upper position knit 1 row in white, give ¼ turn to handle = W.P. and lift outside freesetter. *2nd row:* Knit with red. Push freesetter down, lock back, give ¼ turn to handle = upper position. Repeat these 2 rows throughout.

## ROMPERS Figure I Pants

**SECTION A:** Cast on 72 sts. for sideseam and knit 120 rows, at the same time at right *shape leg* as follows: inc. 1 st. on every 8th row, 15 times.

**SECTION B:** *Gusset:* Lock and wool at right. Leaving 2 needles at right in W.P. bring other needles into R.P. and knit 2 rows. Work

graduations as follows: From the right \* push 2 needles back into W.P. and knit 2 rows. Repeat from \* 8 times. Now \* at left bring 2 W.P. needles into R.P. and knit 2 rows. Repeat from \* 8 times.

**SECTION C:** Bring all needles back into W.P. and knit 120 rows to finish first half of pants. At the same time at *right* dec. 1 st. on every 8th row, 15 times. Repeat Sections A, B and C for second half of pants. Cast off.

**SECTION D:** *The bodice in red and white is knitted in two parts.* For each part, pick up all stitches along Sections A and C, using white wool, and place on machine (plain side facing), dec. evenly to 86 sts. Fix R/A and set needles for 2 plain - 2 purl rib and transfer every 3rd and 4th sts. from Group I to Group II. Knit 16 rows in pattern red/white.

**SECTION E:** *Shape armholes* by dec. 2 sts. at the beg. of the next 18 rows, then knit 44 rows without shaping. Knit a further 2 rows in normal rib and using red wool. Cast off.

## Figure II Fancy Sleeves

With R/A and white wool cast on 160 sts. in 2 plain - 2 purl. Knit 36 rows in pattern red/white and cast off.

**Leg Borders:** Join side seam on pants. For each leg border, pick up 102 sts., starting at gusset and using white wool, and place on machine in 2-1 division (2 needles W.P., 1 needle N.P.). Knit 20 rows, cast off.

**To Make Up:** Press with hot iron over damp cloth. Join side seams on bodice. Attach cast-on edge of sleeves to armholes, centre of sleeve



# Woollen Comforter with matching Pants

PASSAP-Model M 1210

This Baby set is knitted in plain stocking stitch, the comforter sideways, and has a small white trimming along neckline, armholes and legs. If you don't have a Ribbing Attachment knit borders on the machine with needles set in 2-1 division and size of stitch  $3\frac{1}{2}$ .

**FINISHED MEASUREMENTS:** *Comforter:* Full length 9", chest  $19\frac{3}{4}$ ", width across back 7".

*Pants:* Width 20", length at sideseams  $7\frac{1}{4}$ ".

**MATERIALS:** 4 ozs. of blue and an oddment of white 4-ply Baby-wool, 4 white mother-of-pearl buttons.

**SIZE OF STITCH:**  $4\frac{1}{2}$ , ribbing  $3\frac{1}{2}$ .

**TENSION:** 16 sts. and 26 rows over 2 square inches.

**Pattern:** Plain stocking stitch, the knit-side is the right side.



**Figure I Comforter Back**

**SECTION A:** Cast on 20 sts. and knit 12 rows.

**SECTION B:** At right side of machine for armhole inc. on every alt. row 1 st. once, 2 sts. twice, 3 sts. once, and 5 sts. once, then cast on another 25 sts. (58 sts.).

**SECTION C: Shape shoulder:** At right side of machine inc. 1 st. on every 4 th row, 3 times (61 sts.).

**SECTION D:** Knit 24 rows without shaping. Centre back is now reached, knit second half reversing all shapings.

**Figure II Comforter Right Front**

(The illustration shows the part as worn)

**Left front knitted with reversed shapings**

**SECTIONS A, B and C:** Knit as for back.

**SECTION D:** Knit the bias at front with graduations as follows: At right of machine (side of armhole) \* bring 3 sts. into R.P. and knit 2 rows. Repeat from \* 18 times. Push all needles back into W.P., knit 1 row and place all sts. onto a stitch-holder.

**SECTION E: Waistwelt:** Join side seams. Now, along back and both front parts pick up 160 sts. and place onto machine. Fix R/A setting needles for 1-1 division and transfer every 2nd st. from Group I to Group II. Knit 30 rows in 1 plain - 1 purl rib, at the same time on left front part make one buttonhole each at the 3rd and 27th row over the 27th-30th sts. as follows: Transfer the corresponding 2 sts. from Group II to Group I, knit the 4 sts. with an odd thread and replace the 2 sts. from Group I back onto Group II again.

**Figure III Pants**

**SECTION A: Waistwelt:** With R/A in 1-1 division, cast on 84 sts. and knit 30 rows in 1 plain - 1 purl rib. Transfer the Group II sts. to the corresponding Group I needles and remove R/A.

**SECTION B:** Knit 66 rows without shaping.

**SECTION C: Shape legs:** Cast off 4 sts. at the beg. of the next 16 rows and 3 sts. at the beg. of following 2 rows.

**SECTION D:** Knit 4 rows over the remaining 14 sts. for gusset.

**SECTION E: Shape legs:** Inc. 3 sts. at the beg. of next 2 rows and 4 sts. at the beg. of the next 16 rows.

**SECTION F:** Knit 66 rows without shaping.

**SECTION G: Waistwelt:** Knit 30 rows on R/A in 1 plain - 1 purl rib. Cast off.

**Trimming:** Knit all trimmings as follows: 1 row in blue, 6 rows white. Now make a cord by placing the loops of the 1st white row into the open latches. Knit 8 rows in blue wool and cast off.

**For front parts** place sts. from the stitch holder onto machine. **For back-neck** pick up 20 sts. using blue wool. **For armhole** pick up all sts. 4 times. **For legs** pick up all sts. around each leg-opening, place on to machine and knit all trimmings as described above.

**To Make Up:** Block and press each part using a warm iron over a damp cloth. Join all parts. On all trimmings fold the 8 rows in blue inside and slip stitch in place. Buttonhole-stitch around buttonholes and sew on buttons. At left waistwelt-edge crochet two loops for the first 2 buttons. Crochet 1 row of insertion (1 double crochet, 4 loops, 1 double crochet etc.) along waist of pants. Make a 47" long cord and draw through insertion.

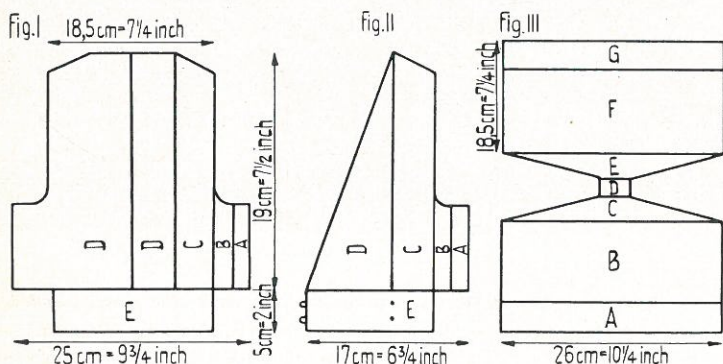

## PLAY-DRESS

**Figure III Skirt**

**Knit two equal parts**

**SECTION A:** Cast on 108 sts. in 2-1 division (2 needles W.P., 1 needle N.P.) and knit 10 rows. Bring N.P. needles into W.P. and knit a further 10 rows with 161 sts. Make hem.

**SECTION B:** Knit 150 rows without shaping and take all sts. onto a knitting needle and place back, main side facing reducing evenly to 86 sts.

**SECTIONS D and E:** Knit as for fig. I, sections D and E, one half of the skirt each for bodice front and back.

**To Make Up:** Join side seam at skirt. Finish the dress as described for rompers.



# Child's Pullover to fit a 1 year old

PASSAP-Model M 1218

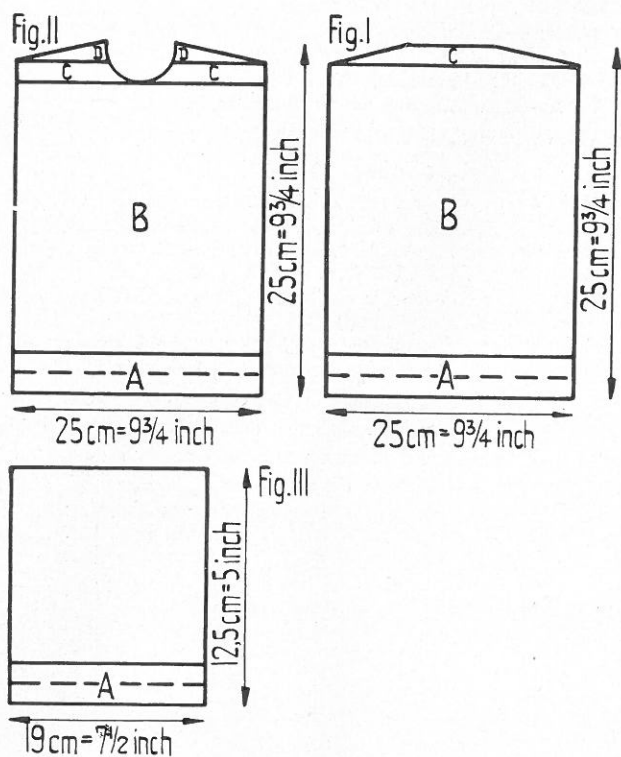

Junior is ready to start off, warm and at ease in this comfortable pullover which Mum quickly knitted in Honey-comb design.

**FINISHED MEASUREMENTS:** Full length  $8\frac{3}{4}$ ", chest  $19\frac{3}{4}$ ", sleeve seam 4".

**MATERIALS:**  $2\frac{1}{2}$  ozs. medium baby-wool.

**SIZE OF STITCH:** 5.

**TENSION:** 14 sts. and 33 rows over 2 square inches.

**Pattern:** Welts: 2 needles W.P., 1 needle N.P. Main parts: Bring every 4th needle in R.P. = 3-1 division, and knit 3 rows. All needles W.P. and knit 1 row over all needles. These 4 rows are repeated throughout, however reversed.

## Figure I Back

**SECTION A:** Cast on 48 sts. over 71 needles, leaving every 3rd needle in N.P., knit 32 rows. Make hem.

**SECTION B:** Bring all needles in W.P. (71 needles) and knit 128 rows in pattern.

**SECTION C: Shoulder shaping:** Cast off 8 sts. at the beg. of the next 6 rows, place remaining 23 sts. onto a stitch-holder.

## Figure II Front

**SECTION A:** Work as for fig. I back.

**SECTION B:** Bring all needles in W.P. and knit 116 rows in pattern.

**SECTION C: Divide for neck:** Cast off 9 sts. at exact centre of work and, using a second ball of wool, continue to knit both sides at the same

time as follows: At neck edge, on alt. rows, dec. 3 sts. once, 2 sts. once, and 1 st. twice.

**SECTION D: Shoulder shaping:** Cast off 8 sts. at the beg. of the next 6 rows.

## Figure III Sleeves

**SECTION A:** Cast on 36 sts. over 53 needles, leaving every 3rd needle in N.P., knit 26 rows and make hem.

**SECTION B:** All needles in W.P. (53 sts.), knit 56 rows in pattern. Cast off.

**Neckband:** At front, around neck-edge pick up all sts. and hang on to machine reducing evenly to 26 sts. over 38 needles, leaving every 3rd needle in N.P. Knit 20 rows, cast off. At back, place the 23 sts. from the stitch-holder on to the machine over 32 needles, leaving every 3rd needle in N.P. Knit 20 rows, cast off.

**To Make Up:** Block and press each part using a warm iron over a damp cloth. Join side and sleeve seams with back stitch (the purl side is the right side). Fold neckband and slip stitch inside, leaving both shoulder seams open. Set in sleeves. Crochet 1 row of single crochet around both shoulder openings, then, at back, work 2 more rows of single crochet for under-step and, at front, 1 row single crochet making 3 buttonholes at each front shoulder. Sew on 3 buttons to each back shoulder.



# Downy Angora Bolero for 1-1½ years old

PASSAP-Model M 1235

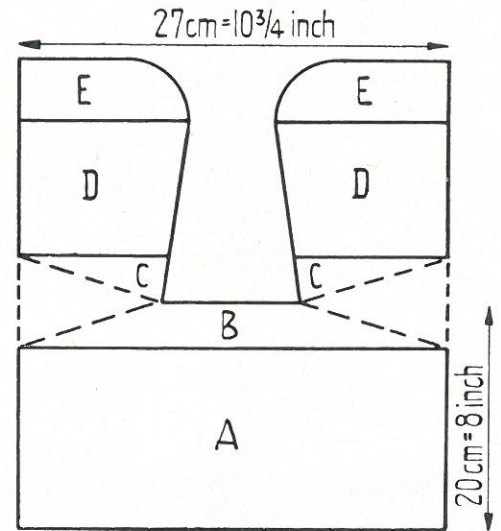

A Little One enters a great protest! But don't worry—he will soon be sweet tempered again wearing this lovely comforter of softest downiest Angora-wool. It is made all in one piece and edged with knitted bias bands.

**FINISHED MEASUREMENTS:** Full length 8", chest 21", width across back 10½".

**MATERIALS:** 2 ozs. white Patons Fuzzy Wuzzy Angora wool.

**SIZE OF STITCH:** 4.

**TENSION:** 16 sts. and 24 rows over 2 square inches.

**Pattern:** Plain stocking stitch, the knit side is the right side.

## Figure I Back and Front Parts

**SECTION A:** Cast on 86 sts. and knit 72 rows straight without shaping.

**SECTION B:** *Shape shoulders* with graduations as follows: At the end of every row \* put 2 needles into R.P. and knit. Repeat from \* 11 times. Now at the end of every row \* put 3 needles into R.P. and knit. Repeat from \* 11 times, leaving 26 sts. in W.P. Cast off these 26 sts. for back neckline.

**SECTION C:** The two front parts can either be knitted separately or at the same time using two balls of wool. Work graduations in reverse to Section B as follows: At neck edge \* put 3 needles into W.P. and

knit 2 rows. Repeat from \* 5 times. Continue to \* put 2 needles into W.P. and knit 2 rows. Repeat from \* 5 times. At the same time at neck edge inc. 1 st. every 8th row, 3 times.

**SECTION D:** Knit 38 rows. Continue to inc. on every 8th row at neck edge 4 more times.

**SECTION E:** To round off the front edges dec. 1 st. on every 5th row 2 times, then on every 2nd row 10 times. Cast off remaining 25 stitches.

**Bias Bands:** *For neck-, front- and lower edges use Tension no. 4.* Cast on 10 sts. on left side of machine and knit approximately 395 rows (39½"), inc. at right 1 st. on every 2nd row and dec. at left 1 st. on every 2nd row. Cast off. The knitting to be transferred back to left side *once*.

**For armholes:** Knit 2 identical parts as described above, but only knit approximately 90 rows (9") and for the last 6 rows omit increasing at right. Cast off.

**To Make Up:** Block and slightly press garment using a warm iron over a damp cloth. Join side seams for 2½". Sew long bias band to neck, front, and lower edges of bolero, short bias bands to armholes, fold bands in half and slip stitch inside.



# Our little Ballerina

## Baby Dress with Bag (for 1½-2 years old)

PASSAP-Model M 1180

MEASUREMENTS OF FINISHED DRESS: Length 15½", skirt length 10", bodice length 5", waist approx. 21", back width 8½", skirt width 83", shoulder width 2½".

MATERIALS: 13 balls Coats Mercer Crochet No. 10 or Dewhurst's Sylko Perle No. 8. 8 glass buttons, 1¾ yds. ribbon, 1 yd. tarlatan for underskirt.

SIZE OF STITCH: 3½.

TENSION: 9 sts. and 32 rows per 2 square inches.

**Knitting Pattern:** *Alternate needles are used throughout.* Knit two rows over all sts. \*\* Put every alt. needle forward into R.P. starting with the first needle from the right and knit 3 rows. All needles W.P. knit 2 rows. Repeat the pattern row but beginning with the 2nd needle from right in R.P. and knit 3 rows. All needles W.P. knit 2 rows. Repeat from \*\* throughout.

### Figure I Skirt

Cast on 55 sts. over alt. needles (109 needles) and knit 1500 rows in pattern. Cast off loosely (when casting off, crochet a chain st. between each stitch).

### Figure II Bodice Front

Cast on 48 sts. (95 needles) and knit 48 rows in pattern *at the same time* dec. 1 st. at each end of every alt. row 9 times and 1 st. at each end of every 4th row 7 times. Cast off the remaining 16 sts. loosely.

### Figure III Bodice (Half-back) Other half knitted with reversed shapings

Cast on 24 sts. (47 needles) and knit in pattern. At the right dec. 1 st. on every 4th row 16 times (64 rows). Cast off remaining 8 sts.

### Figure IV Side Part (Knit two)

Cast on 44 sts. (87 needles) and knit in pattern, dec. 1 st. at both ends of every 4th row 15 times. Knit 2 rows (62 rows). Cast off the remaining 14 sts. loosely.

### Figure V Wing-shaped Sleeves

Cast on 66 sts. (131 needles) and knit 3 rows in pattern continue in pattern and \* dec. 1 st. at beg. of next 4 rows, knit 2 rows without decreasing. Repeat from \* until 69 rows have been knitted. Cast off the remaining 20 sts.

**To Make Up:** Crochet 6 rows of firm sts. along side edges of front and both back parts. Sew the side parts on to the crocheted edges so that the cast-on edge forms the armhole and the cast-off edge forms the neckline. This forms a hollow square when laid out flat. Crochet 2 rows of firm sts. round the outer edges of sleeves and neckline. Starch all parts and pin out wrong side uppermost, and press, until dry.

**To Complete:** Join the sidearms for approx. 1". Gather the sleeves and sew into armhole. Turn in and sew an 1½" hem on skirt. Gather the skirt at the waist to about 21" then crochet 3 rows of firm sts. round waist. Crochet 3 rows of firm sts. round bodice waist then join bodice to skirt using treble crochet through which to thread ribbon, matching the back opening. Join the skirt seams leaving 4" open at top. Crochet 3 rows around back opening, working 8 buttonholes in the 2nd row of crochet. Sew on buttons. Thread ribbon through waist and tie at back. Line finished dress with a stiff petticoat.

### Figure VI Bag

Cast on 30 sts. (59 needles) and knit 90 rows in pattern. Cast off loosely.

**To Make Up:** Starch, block and press until dry. Join sides together, gather top edge a little and crochet round with 3 rows of firm sts. Crochet an 11" chain and attach bag to waist of dress. Line bag with same material as dress.

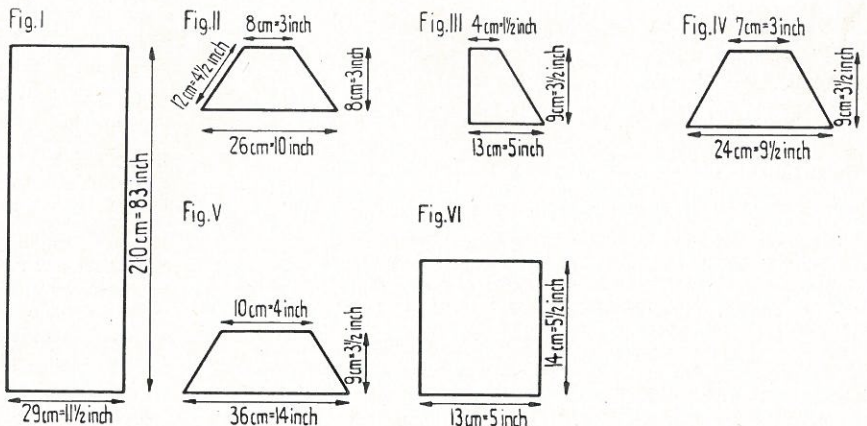

Doesn't she look

exactly like a

little Prima-Ballerina? —

wearing this charming

summer-frock

knitted with

fine cotton-yarn

in a very attractive

flimsy lace-design.

A coloured

petticoat

blinks coquettishly

through the

pretty open-work.



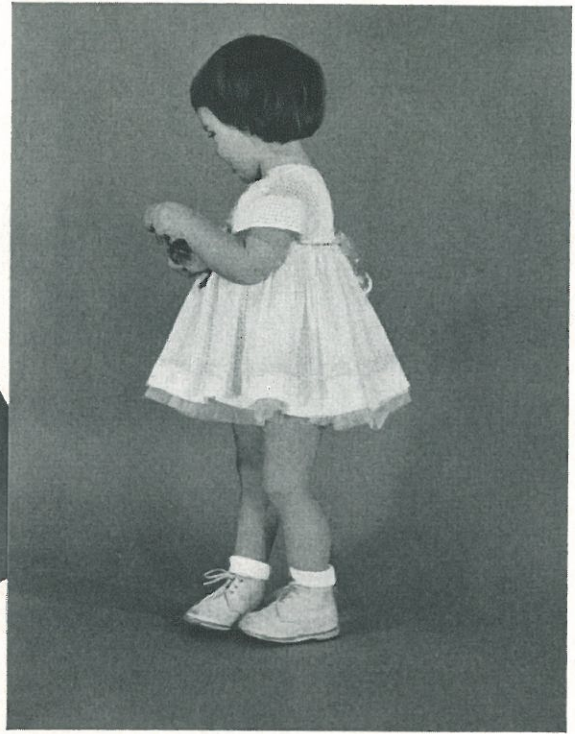



# Nothing stays clean for ever . . .



## Children's Vest and Pantees PASSAP-Model M 1250

**FINISHED MEASUREMENTS:** *Vest:* Full length 17", chest 21". *Pantees:* Waist 20", side length 7½".

**MATERIALS:** 6 ozs. Patons Halcyon, a length of elastic.

**SIZE OF STITCH:** For borders 3½, other parts 4.

**TENSION:** 16 sts. and 24 rows over 2 square inches.

**Pattern:** Plain stocking stitch, plain side outside. *For yolk: 1st and 2nd row:* With pattern ruler in 1-1 division bring every alt. needle into R.P. starting with the 1st needle. *Knit 2 rows. 3rd and 4th row:* All needles back into W.P. and knit 2 rows. *5th and 6th row:* Bring every alt. needle into R.P., starting with the 2nd needle and knit 2 rows. *7th and 8th row:* Same as 3rd and 4th rows. Repeat these 8 rows = 2 patterns throughout.

### Vest Back

**SECTION A:** With size of stitch 4 cast on 47 sts. over every alt. needle and knit 24 rows. Place loops of cast-on edge on to machine for hem.

**SECTION B:** Bring the needles from R.P. into W.P. and knit 130 rows over 93 sts., at the same time dec. 1 st. at both sides of every 12th row, 5 times.

**SECTION C:** *Shape armhole:* Cast off at the beg. of the next 8 rows as follows: 4 sts. twice, 3 sts. twice, 2 sts. twice and 1 st. twice.

**SECTION D:** Set pattern for yolk as follows: Knit 8 rows, at the same time, at exact centre of work, knit in pattern over 10 sts. Knit a further 8 rows, at the same time enlarging the pattern over 10 more sts. each side, so that a total of 30 sts. is knitted in pattern. From now on work in pattern over all needles until 56 rows have been knitted in all, at the same time for armhole cont. to dec. 1 st. at both ends of every 4th row, 8 times.

**SECTION E:** *For neck* cast off 11 sts. at the exact centre of the work and using a second ball of wool cont. to knit both sides at the same time in pattern as follows: At neck edge dec. at every alt. row 4 sts. once, 3 sts. once, 2 sts. once and 1 st. once. With the remaining 8 sts. on each side knit 20 rows without shaping, then place the sts. on to a stitch-holder.

### Vest Front

Knit exactly as for back, dividing for neck after 36 rows in pattern have been knitted.

**To Make Up:** Sew the parts together and join the shoulder seams. Around armholes and neckline crochet 1 row of single crochet and one picot.

### Pantees

**SECTION A:** The pantees are knitted sideways. For sideseam cast on 30 sts. on size of stitch 4 and knit 50 rows in plain stocking st., at the same time at right shape for the leg as follows: Inc. 1 st., at the beg. of every alt. row, 25 times.

**SECTION B:** Knit 48 rows in pattern.

**SECTION C:** Knit 50 rows in plain stocking st. At the same time at right shape second leg as follows: Dec. 1 st. at the beg. of every alt. row, 25 times. First half of pantees now being finished, repeat Sections A, B, and C for second half. Cast off.

## Knee-length Socks for approx. 9 to 12 months old

PASSAP-Model M 1251

**FINISHED MEASUREMENTS:** Length of leg 7", length of foot 5¼".

**MATERIALS:** 2 ozs. Patons Beehive Fingering 4-ply, an oddment of elastic.

**SIZE OF STITCH:** 4½.

**TENSION:** 15 sts. and 28 rows over 2 square inches.

**Open-work Pattern:** Set needles as follows:

Neutral Position:

○ ○ ○ ○ ○ ○

Working Position: III I III I III I III etc.

\* \* \*

\*\* Knit 2 rows in this division, then bring the needles marked with \* into R.P. and knit 2 rows. Push needles from R.P. back into W.P. and repeat from \*\*. When dec., count only needles in W.P.

### WORKING ORDER

**SECTION A:** Cast on 55 sts. and knit 6 rows in stocking st. In order to obtain a neat hem-edge make 1 open-work row as follows: Place every alt. st. on to the following needle and knit 1 row. Cont. to knit 6 rows in stocking st., place loops of cast-on edge on to machine for hem and knit 1 row. Place sts. on to a stitch holder, turn the work and hang back on the machine.

**SECTION B:** *Leg:* Set needles for open-work pattern, starting with 2 needles in W.P. and from now on work in pattern. Knit 32 rows without shaping.

**SECTION C:** Knit a further 32 rows, at the same time dec. 1 st. at both ends of every 8th row, 4 times.

**SECTION D:** Knit 20 rows without shaping.

**SECTION E:** Bring 15 sts. at the exact centre of work into R.P. From the 7 sts. remaining at both sides, bring the 4 needles each from N.P. into W.P. and knit 1 row over the 2 times 11 sts. thus obtained. Using an odd ball of wool knit a further few rows and throw off the sts. Push the 15 middle needles from R.P. back into W.P. and knit 32 rows in pattern for the *in-step*. Place all sts. on to a stitch holder, turn work and hang back on to machine.

**SECTION F:** Bring needles from N.P. into W.P. and knit 1 row plain over all 21 sts. From now on work in plain stocking st. *Shape toe* as follows: At beg. of every row bring 1 needle into R.P. until 5 sts. remain in the centre. Then, at the end of every row, bring 1 needle back into W.P.

**SECTION G:** *For the sole* knit 32 rows without shaping.

**SECTION H:** Work *the heel* exactly like the toe being careful, however, that 7 sts. remain in the centre. Place the sts. on to a stitch holder.

**To Make Up:** Unravel the odd wool at Section E (2 times 11 sts.), place the 22 sts. on to two knitting needles with points at both ends, and graft. Close the seam at back of leg, and sew in-step to sole. Now block and slightly press socks using a warm iron over a damp cloth. Thread in the elastic.

Description for Baby Pants M 1242 see page 13.



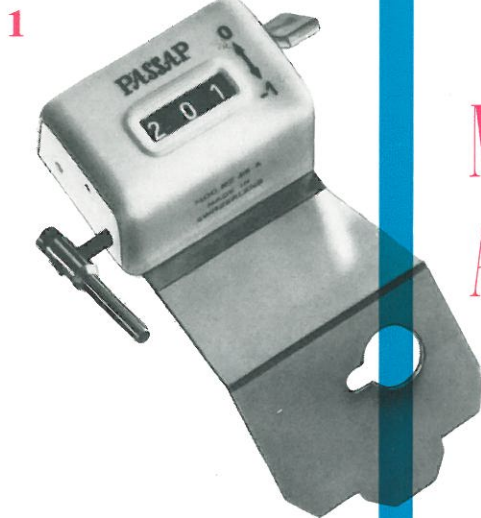

## New Accessories

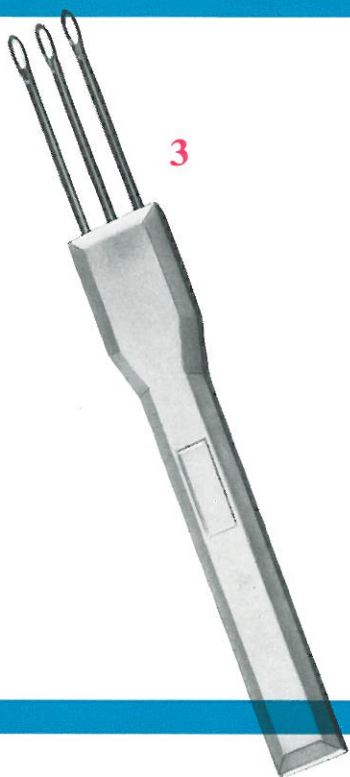
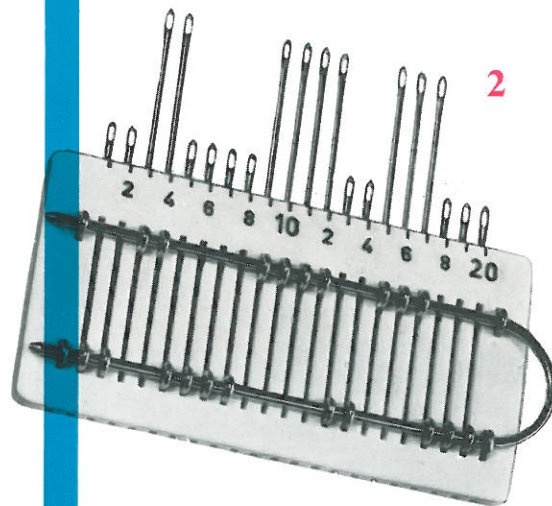

- 1** PASSAP — as usual one step ahead — the first to bring out the new row-counter with 0- and backwards motion.  
Pos. RZ 56-A
- 2** Transfer Comb with 20 interchangeable decker needles for open-work patterns, decreasing in the row etc.  
Pos. WDK 1910-A
- 3** Treble-deckerneedle — ever so useful for fashion-decreasing, cabling, etc.  
Pos. 7364-K
- 4** Universal Pattern Selector with 70 interchangeable spades for Fairisle-patterns, needle-setting on Ribbing Attachment, etc.  
Pos. WMK 1920-A

Enquire with your PASSAP-Dealer!

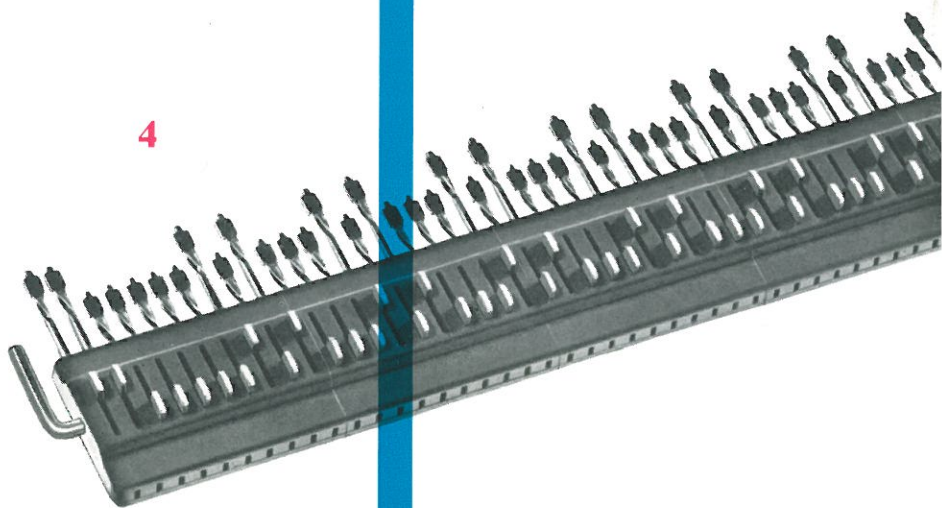

PASSAP



All  
over the  
world



PASSAP

PASSAP-Export, Zürich 27, Switzerland  
1 Bederstr., Post Box 350

Knitwear Machinery & Supplies Ltd.

98-100 Jervois Road Auckland, W. 1  
Telephone: 14-744 P.O.Box 2932, Auckland, C. 1