

MACHINE KNITTING CHIC

No. 10 · £1.75

Isabel's Knittery
4 Millstream Lane
Stony Brook, NY 11790
516-751-1830

a Sabrina
PUBLICATION

**Model Designs
for the
Knitting Machine**



**CHEERFUL
PATTERNS -
UP-TO-DATE
AND VARIED**

**THE LATEST DESIGNS
FOR CHILDREN**

Simple instructions and Reader Service

ISSN 1015-7948



9 771015 79400

Contents

Here it is, the
knitting
machine
pattern
book just
for children.

There are pattern
for the smallest,
cheerful picture
knits and easy-care
The instructions are
materials. in several sizes, making knitting for

the youngsters

a pleasure.

Choosing one is not
easy, so let them
help you.

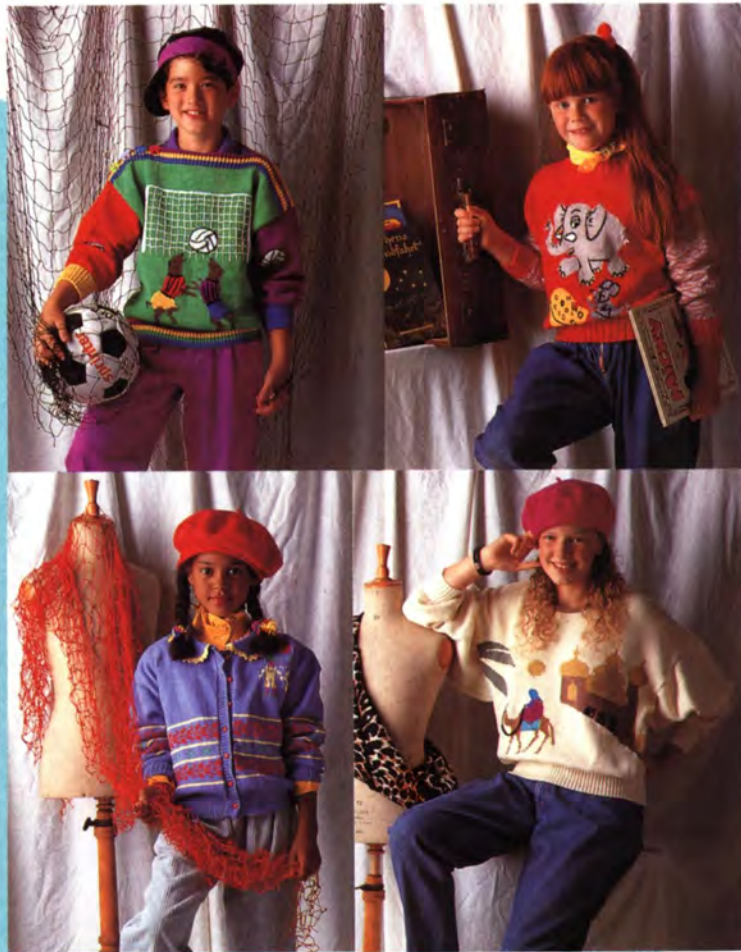

Abbreviations,
Size chart and
manufacturers page 17



If you have
any queries
about any of
the patterns in
this issue, please write to:

READERS' SERVICE
7 Laurels Avenue
Bangor-On-Dee
Wrexham, CLWYD, LL13 0BB

For urgent enquiries you
can telephone Monday to
Friday from 6 pm to 9 pm.
Tel: (0978) 780 354

This magazine is published by **BPV Medweth & Co.**, Gewerbezone Eichli 29, CH-6370 Stans.

Publishing Directors: H. + E. Medweth.
Editorial: Christl Haegele. **Design:** Ch. Haegele and C. Grube. **Desk editor:** M. Leiblinger. **Distribution:** BPV Medweth & Co., Gewerbezone Eichli 29, CH-6370 Stans. Distributed in Great Britain by: MMC, Magazine Marketing Company, Octagon House, White Hart Meadows, Ripley, Woking, Surrey GU23 6HR. Tel. 0483 - 211222. Printed in West Germany by OZ-Druck- und Verlags-GmbH Rheinfelden. Copyright 1991 by BPV Medweth & Co., CH-6370 Stans.

All models are under unlimited copyright protection ©. Commercial copying prohibited. Publishers and editors assume no liability for the unrequested contribution of photos, designs and manuscripts.

HAPPY KIDS

Model 1, Size 122/128cm



This cheeky
elephant from the
Zoo is helping with
the apple harvest.
Leave some for us!

CLOWN AND ANIMALS

Just look at his lovely wig! This clown will make both boys and girls smile. And who has been at the cheese? Everyone is under suspicion, but it must have been the mouse. Jumbo wasn't watching!

Model 2, Size 128/134 (140/146)cm





Model 3, Size 140/146cm

Model 4, Size 116/122cm



FLIGHTS OF FANCY

Model 5, Size 134/140cm

Rosa, the little pig
flies away on a
white cloud. The
golden stars are
now within reach.
Tell me, why do
cats need a
shower?



EVERYBODY'S DARLING

Please, tell me another story! In my pretty jacket, I can't get enough of them. Granny knitted it for me because, in confidence, since my arrival Mummy has been too busy. If that isn't a hint!

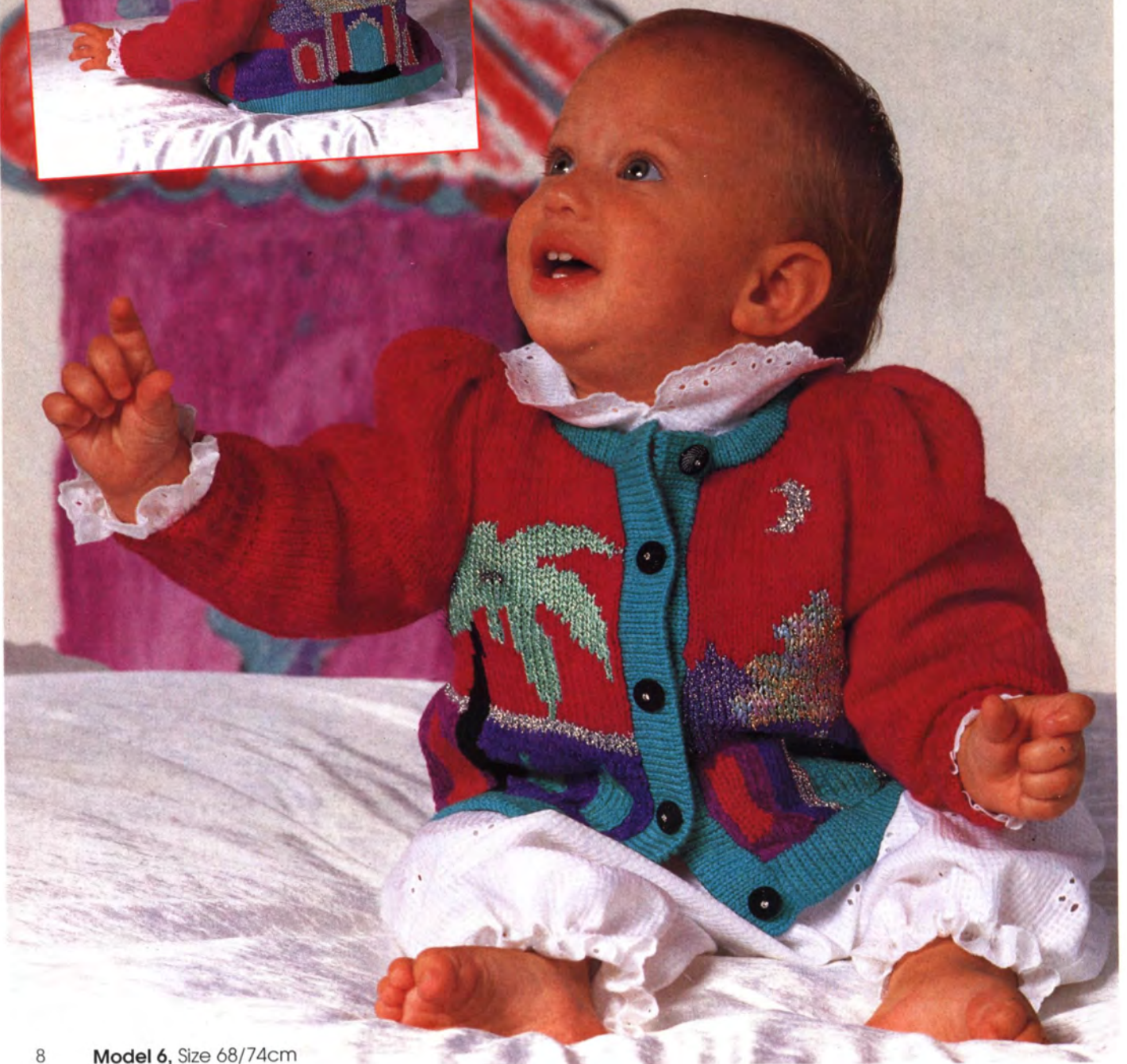
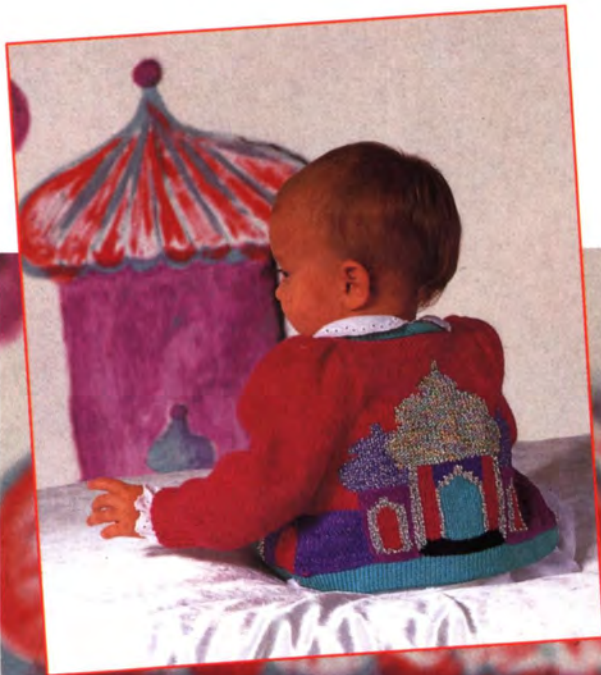

No, you can't have my Teddy! Another darling might prefer this brilliant Bird of Paradise. It doesn't matter which outfit you prefer, these sweaters will remind you of happy times. And who knows, they will perhaps be passed on.

Model 8, Size 62/68cm



Model 7, Size 62/68cm



WHITE IS DELICATE

Tutti Frutti for the youngest. Should I take the strawberry or the pineapple? Perhaps I had better ask! The cheeky lad in the middle has decided on the zebra. Knitted in intarsia, it really suits him.



Model 10, Size 62cm

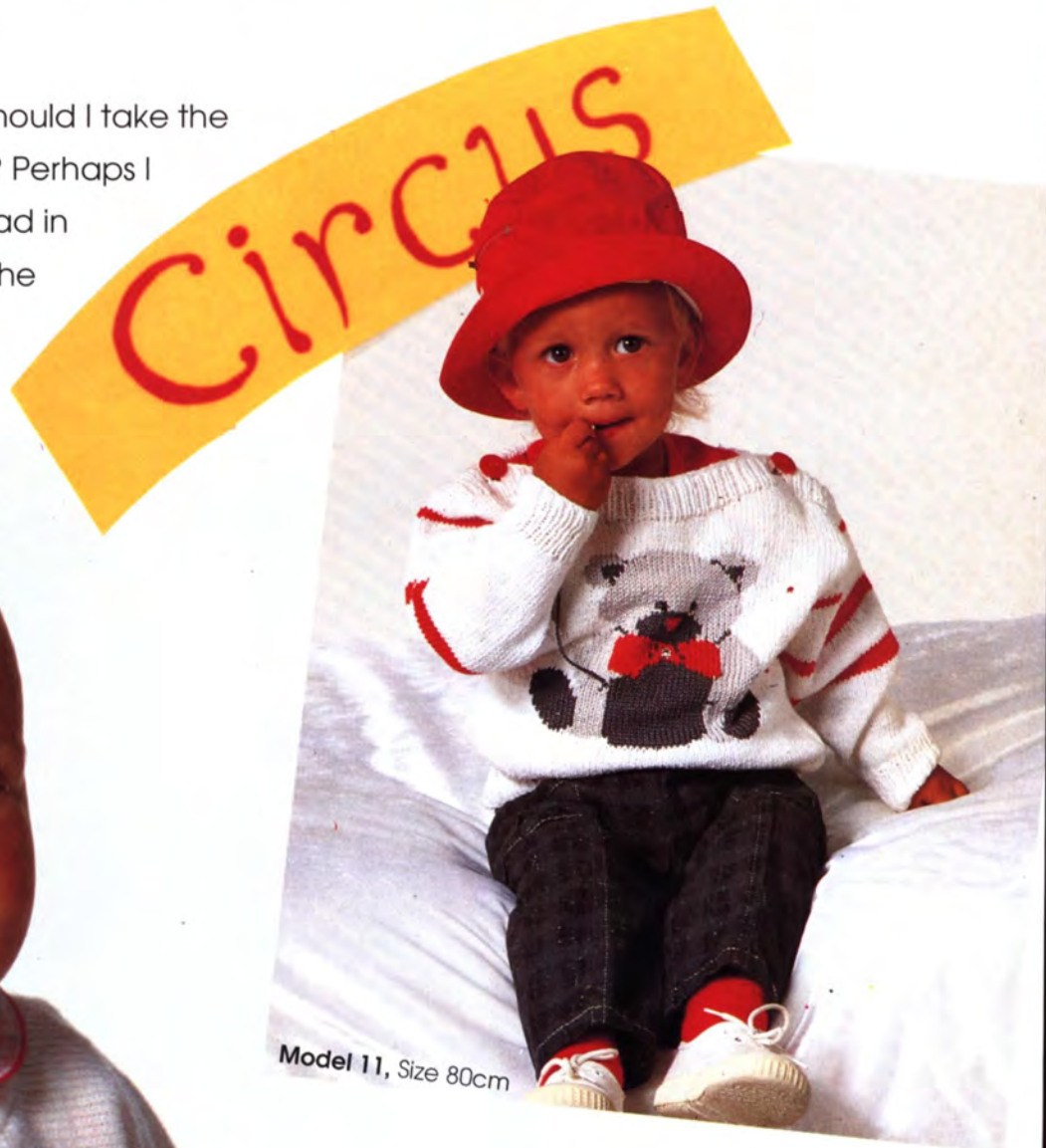

Model 11, Size 80cm

I love the circus. The question is, with this big hat, will they take me for the clown? I can entertain, but in front of all these people?



Model 12, Size 128cm

PINK AND PEP

Now, when I have learned to drive, this is the car I want. Till then, my little kitten can have a go. Little ladies put on a good show with a (borrowed) straw hat and a lacy collar.



Model 13, Size 116/122cm



SEAFARERS

Model 14, Size 158 - 164cm

Once hooked, surfers like the wind in their faces. Divers like it the same. These shells and starfish were the largest. Let's hope summer comes soon.





Model 15, Size 152/158 (164/170)cm

BLACK CATS

Model 16, Size 152 (158)cm

Haven't got a cat? Why don't you knit this one? Even without his boots, he will soon become a favourite.



Instructions

On the following pages you will find all the instructions, charts and diagrams for the models under their relevant numbers.

It is possible to knit some of the designs by hand. Please use our Reader Service and telephone Mondays to Fridays between 6pm and 9pm or write to the address given.

Abbreviations:

st (s)	= stitch(es)
R	= row(s)
alt.	= alternate
C	= colour
COL	= carriage on left
COR	= carriage on right
cont.	= continue
decr.	= decrease
incr.	= increase
rep.	= repeat
N	= needle(s)
MB	= mainbed
RB	= ribber bed
st.st.	= stocking stitch
HP	= holding position
WP	= working position
NWP	= non-working position
UWP	= upper working position
RC	= row counter
TD	= tension dial
000	= set RC to 000
MT	= main tension
RT	= rib tension
rem	= remaining
trans.	= transfer
m.	= metre
cm.	= centimetre
dc	= double crochet
crabstitch	= dc from left to right

Numbers on patterns denote measurements in centimetres

Yarn Manufacturers

Junghans Wollversand
Auf der Hüls 205
5100 Aachen

Pingouin

French Woools Ltd.
Station House
81-83 Fulham High Street
London SW6 3JW
Tel.: 01.731.4215

Size chart

Height	cm	86	92	98	104	110	116	122	128	134	140	146	152	158	164	170
	ins	34	36	38.5	41	43	45.5	48	50	53	55	57.5	60	62	64.5	67
Chest	cm	55	56	57	58	59	60	62	64	66	68	72	76	80	84	88
	ins	21.5	22	22.5	23	23	23.5	24.5	25	26	27	28.5	30	31.5	33	34.5
Back	cm	22	23	24	25	26.5	27.5	29	30	31.5	32.5	34	36	38	39.5	41.5
length	ins	9	9	9.5	10	10.5	11	11.5	12	12.5	13	13.5	14	15	15.5	16.5
Sleeve	cm	28.5	31	33.5	36	38.5	41	43.5	46	48.5	51	53	55	57	59	61
length	ins	11	12	13	14	15	16	17	18	19	20	21	21.5	22.5	23	24

Schachenmayr
Postfach 1160
D - 7335 Salach
Tel.: 07162/140

WSM-Westima / Wolltex
Rheinstraße 28
D - 6100 Darmstadt

BUTTONS
Union Pro Fashion GmbH

Accessoires
Postfach 11 09 55
D- 4800 Bielefeld 11
Tel.: 05205/12-0

All yarns are also obtainable from:

Wollstudio Jutta Hinrichs
Wormser Str. 5
6550 Bad Kreuznach
W.-Germany
Tel.: 0671/42625

KNITTINGMACHINE MANUFACTURERS

Brother
Jones Sewing Machines Ltd.
Manchester Office
Shepley Street
Manchester M34 5JD
Tel.: 3300111

Empisal
Knitmaster
39-45 Cowleaze Road
Kingston-Upon-Thames
Surrey KT2 2DT
Tel.: 01 546 2444

Singer from
Mr. K. Dickinson
European Home Products
John Scott House
Market Street
Bracknell / Berkshire RG12 2JB

1

MODEL

SWEATER WITH

ELEPHANT

Size: 122/128cm

Machines: Suitable for standard gauge machines with intarsia carriage and ribber. We used a Brother KH 930.

Materials: SCHACHENMAYR "Nomotta Regia 4 ply" (75% wool, 25%polyamid, 210m/50g) approx. 150g lt.green, 100g dk.green, 50g each red, brown, lt.grey, yellow and dk.grey. Small amount of white and black. Small amount of white Angora for the cloud.

Tension: 30 sts and 39 R = 10cm.

Wells: 1X1 rib at TD 3.

Intarsia: knitted according to the chart at TD 8.

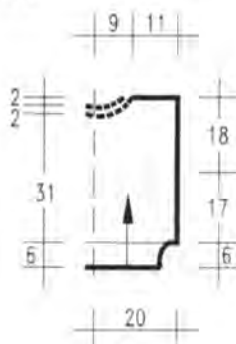

1/2 front/back

Arrows on pattern denote direction of knitting.

Front: Cast on 102 sts in lt.green and knit 26 R rib. Transfer all sts to MB, increasing to 120 sts. Set RC 000 and knit intarsia, following the chart. At RC 66, mark both edges for armhole. Knit to RC 120 and shape neck. Set carriage to HP and knit as shown on chart, putting needles into HP. Cast off rem. 33 sts at RC 136. Knit 1 R over needles in HP. Transfer sts for rib and knit 10 rows. Cast off loosely.

Back: Cast on and knit as for front, however knit only areas marked 1 and 6. Shape neck, when RC shows 128. Knit neckband as on front.

Sleeves: Cast on 48 sts for 1X1 rib and knit 26 rows. Transfer sts to MB and increase to 68 sts. Set RC 000. Knit in lt.green to RC 70 and then in lt.grey to RC 102. At the same time, shape sides by incr. 1 st at each side on every 5th row 20 times = 108 sts. Cast off at RC 102.

Finishing: Embroider pieces as shown. Large apples only on sleeves. Close shoulder and neckband seams. Set sleeves between markers and close side seams.

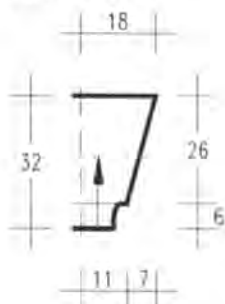

1/2 sleeve

Using the measurements table:

The sizes given in the pattern are heights. You must therefore compare the other measurements in the chart below with those of the child. The backlength is taken from the back of the neck to the required length of the garment. The chest is measured over the widest part below the armholes. The sleeve length is measured from the centre back of neck over the shoulder to the wrist. This will give you 1/2 the back or front width plus the length of the sleeve. Deduct 1/2 the back or front measurement and you will be left with the sleeve length. Compare this with the figures in the table.

Baby sizes:

62cm = 1-3 months
68cm = 3-6 months
72cm = 6-9 months
80cm = 9-12 months

Chart

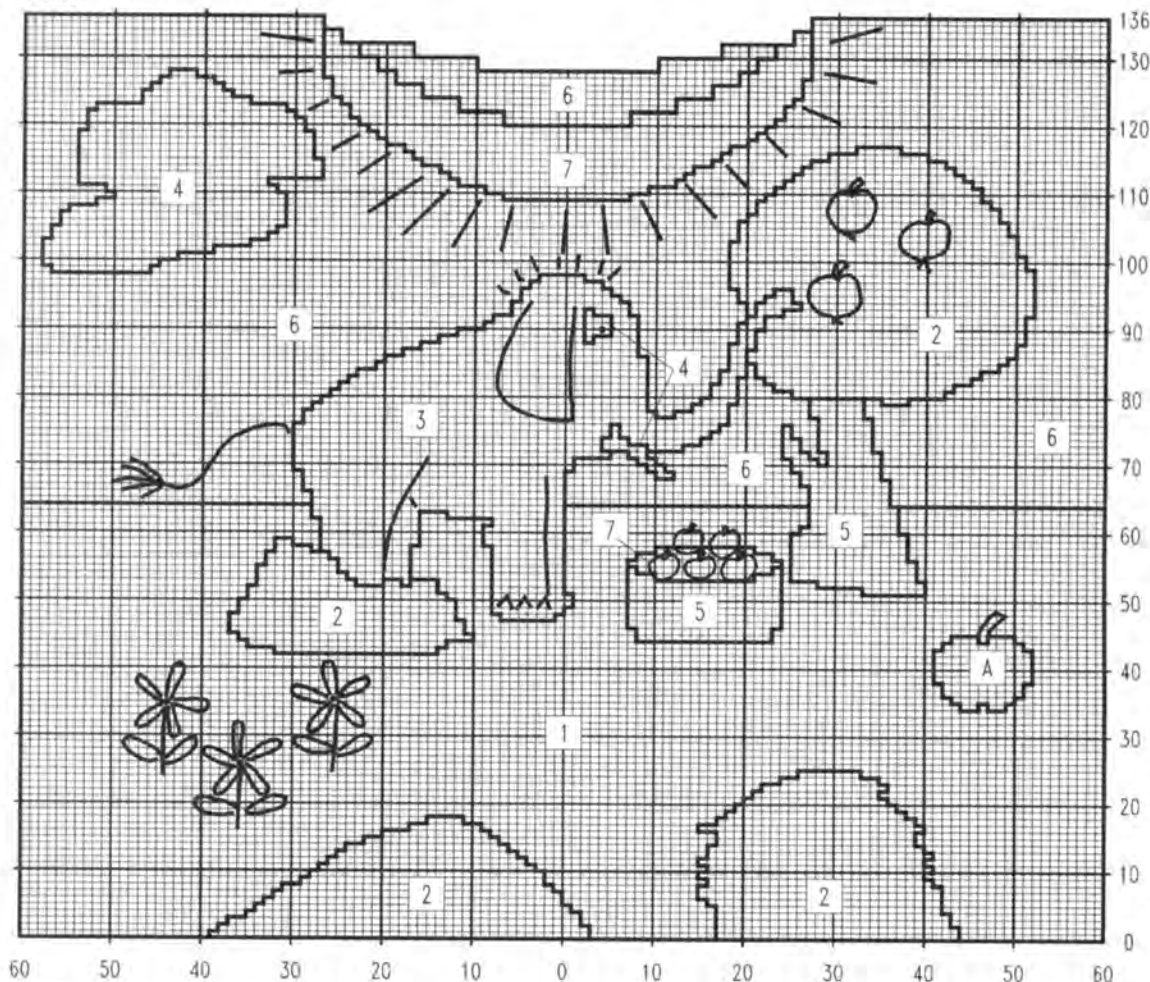

- Key:**
 1 = lt. green
 2 = dk. green
 3 = dk. grey
 4 = white
 5 = brown
 6 = lt. grey
 7 = yellow
 A = apple swiss-darned on sleeves only
 1 square = 1 R and 1 st.

Embroider remaining apples in red satin stitch, contours in black stem stitch, rays of sunshine in yellow. See photo.

MODEL 2

SWEATER WITH CLOWN

Size: 128/134 (140/146) The instructions for the larger size are in brackets. One figure only applies to both sizes.
Machines: Suitable for standard gauge machines with intarsia carriage and ribber or garter carriage. We used a Brother KH 930 with garter carriage.
Material: SCHACHENMAYR "Rondino" (100% wool, 165m/50g) 250(300)g white, 50g each in turquoise, blue, red and yellow. Small amount of pink for the face. For the embroidery a small amount of black. Crochet hook 3mm, 4 buttons, 1 press stud.
Tension: 26 sts and 33 rows = 10cm at TD 10**.
Ribs: For the garter carriage, use the card for 1 X1 rib or pattern 532 from *Stitch World*. TD approx 8.
Intarsia: Following chart 1 at TD 10**. Cross all threads when changing colour. Place the motif according to the needle arrangement at bottom of chart. Chart 2: These motifs are placed at random on the sleeves in your own arrangement with your own colours.
Arrows on pattern denote direction of knitting.

Back: Cast on 98(108) sts and knit 20 rows rib. Incr. sts to 110(120) and continue in white st st to RC 66 (70). Mark both edges for armhole. Knit to RC 134 (138) and shape neckline. Set carriage for HP. Push to HP the centre 30(34) needles and all sts at side opposite to carriage. At neck edge push to HP on alt. rows 4 sts once and 3 sts once. When RC shows 140 (144) cast off rem. 33(36) sts. Repeat shaping on other side. For the neckband knit 1 R white over the needles in HP. Knit several rows waste yarn and release work from machine.
Front: Cast on and knit rib as on back. Start intarsia on first row and follow chart. At RC 106(112) cast off stitches 27(29) - 0 - 22(24) for the insert. Knit each side separately, casting off the rem. 33(36) sts. on one side or 28(31) sts on other side when RC shows 140(144).
Sleeves: Cast on in yellow or red 56 (60) sts and knit 20 R rib. Increase to 68 (72) sts and set RC 000. Continue in white, placing motifs at random. At the same time, incr. 1 st at each side on every 4th row 22 times and on every 2nd row twice (on every 6th row 4 times and on every 4th row 20 times) = 116 (120) sts. At RC 94 (110) cast off all sts.
Insert: RC 000. Cast on 26 sts and knit 2 rows in rib. At left edge cast off 2 sts for the neckline. Decr. at left edge on alt. rows 2 sts once and 1 st 4 times = 18 sts. Knit 44 rows straight. At left edge incr. on alt. rows 1 st 4 times and 2 sts twice = 26 sts at RC 56. Knit 4

rows. Make 4 buttonholes at equal distances over 2-3 sts. Knit 4 rows and cast off.
Buttonband: Cast on in yellow 26 sts. Knit 8 rows rib and cast off.
Neckband: With purl side out, hang the 44 (48) sts from the waste yarn on the needles. With buttonholes at left, pick up 54 (58) sts from insert and hang on needles. Knit 11 rows in rib over these 98 (106) needles and cast off with latch tool.
Finishing: Sew the insert to the front. Sew the buttonband to front edge below buttonhole band. Sew on buttons. Close shoulder seams. Finish the clown: embroider the detail in stem stitch. For the bobbles, crochet 3 chains in black or red. Make 3 or 4 half

trebles in first chain, leaving the last loops on the hook. With a slipstitch pull all loops together and fasten off. For the tie cast on 15 sts and knit 4cm in st st. Pick up loops from 1st row to make a hem and cast off. Tie in the centre with a thread. For the hair make a chain approx. 20cm in length. For the second row, make dc's in every stitch taking the yarn around a narrow ruler to from the fringe. Make a second row of loops into the same stitches. Sew around the face. Set in sleeves between markers. Close side and sleeve seams.

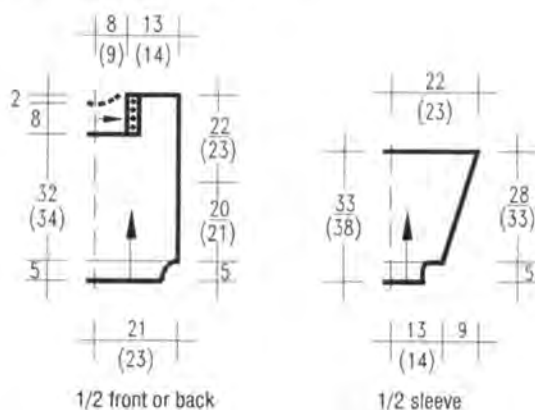

Chart 1

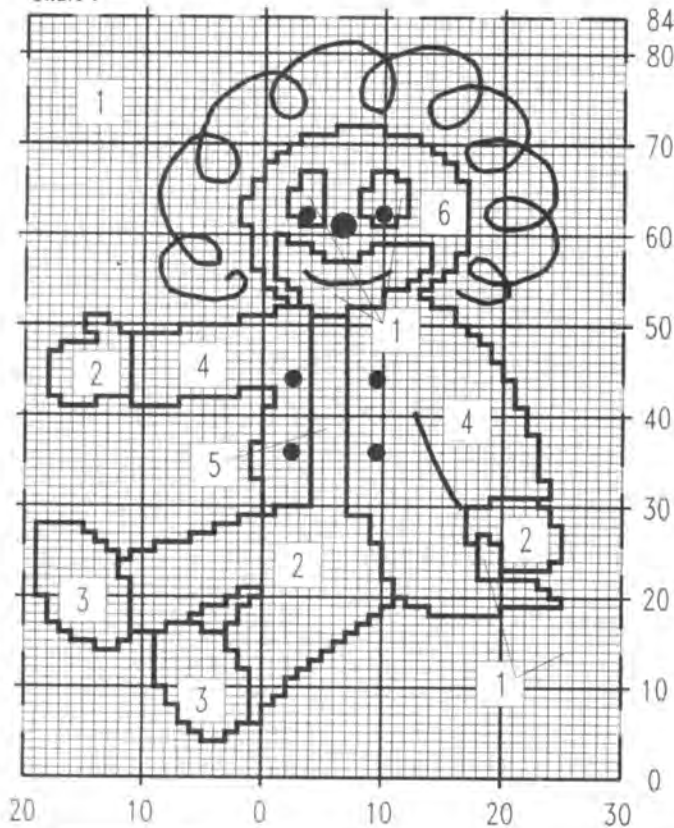
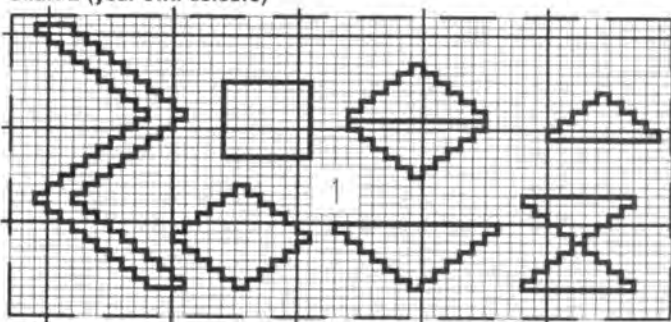

Chart 2 (your own colours)



Key:
1 = white
2 = blue

3 = yellow
4 = red
5 = turquoise

6 = pink
1 square = 1 R and 1 st.

MODEL 3

SWEATER WITH ELEPHANT AND MOUSE

Size: 140/146cm

Machines: Suitable for standard gauge machines with intarsia carriage and ribber or garter carriage. 24 st machines should substitute a similar fairisle pattern. We used a Brother KH 930.

Material: SCHACHENMAYR "Nomotta Universa" (55% wool, 45% polyacryl, 125m/50g) approx. 300g red, 150g grey and 50g yellow. "Puschka" (50% Mohair, 50% polyacryl, 150m/50g) approx. 50g dk grey and lt grey. A small amount in black and white. 3mm crochet hook.

Tension: 26 sts and 33 R = 10cm in st st on TD 10** 28 sts and 34 R = 10cm over fairisle.

Ribs: 2/2 rib with garter carriage at TD 8. Stitch World pattern 534

Intarsia: knitted following the chart given. Take care to cross threads to avoid holes. Smaller areas may be swiss-darned. The outlines are embroidered in black stemstitch. For the tails, crochet short chains in the correct shade of grey and sew on.

Fairisle: For electronic machines, mark the mylar sheet or enter the program. For 24 st machines, use a similar punchcard. Repeat the pattern in the height.

Arrows on diagram denote direction of knitting.

Back: Cast on 110 sts and knit 20 rows rib. Set RC 000 and continue in red to RC 72. Mark both edges for the arm-hole. At RC 130, shape the neck. Set carriage to HOLD. Push to HP the centre 30 sts and all needles at side opposite to carriage. Knit each side separately, putting to HP at neck edge on alt. rows 4 sts once, 3 sts once and 2 sts once. Cast off rem. 36 sts at RC 138. Repeat for other side.

Neckband: Knit 1 row over all needles in HP in red. Change to rib and knit 9 rows. Knit last row on loosest TD setting and cast off with latch tool.

Front: Cast on and knit rib as for back. Set RC 000 and knit 5 rows. Start intarsia and knit till RC 122. Shape neck by putting centre 14 sts to HP. Knit each side separately, putting to HP at neck edge on alt rows 4 sts once, 3 sts once and 2 sts 5 times. Cast off rem. 36 sts at RC 138. Repeat for other side. Knit neckband as for back.

Sleeves: Close shoulder and neckband seams. With purl side facing, pick up 116 sts between markers on side edge. Set RC 000 and knit in fairisle pattern, decr. 1 st at each side on every 4th row 25 times = 66 sts. At RC 102, reduce sts to 50. Knit 1 row st st and change to rib knitting. Knit 20 rows and cast off.

Finishing: Embroider on front as described. Close rem. seams.

cont. next page

Fairisle pattern

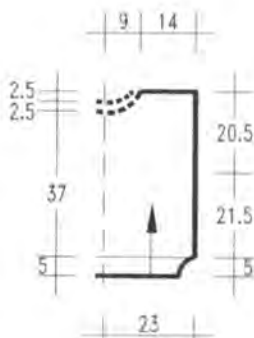
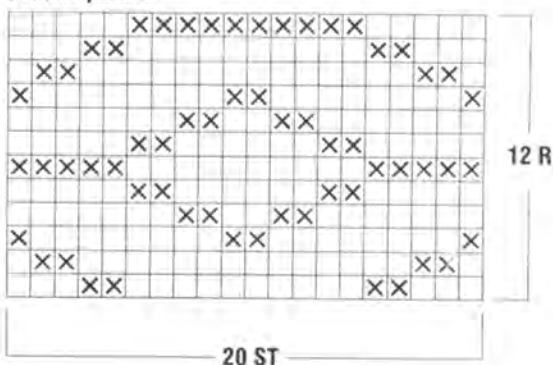

1/2 front and back



1/2 sleeve

Chart

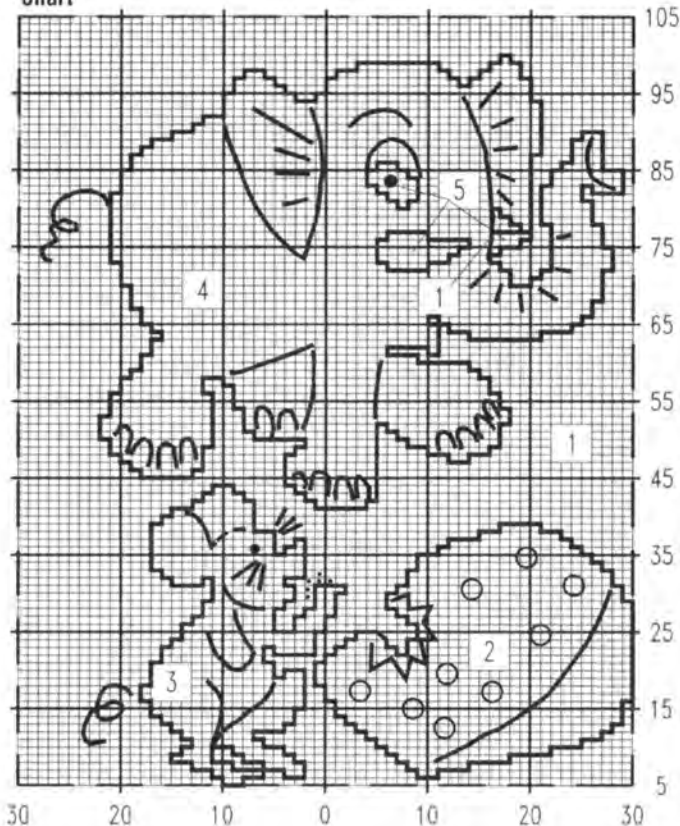

Key to chart: 3 = dk. grey 1 square = 1 R and 1 st
 1 = red 4 = lt. grey
 2 = yellow 5 = white

MODEL 4

SWEATER WITH FLYING PIG

Size: 116/122cm
Machines: Suitable for standard gauge machines with intarsia carriage and ribber or garter carriage. We used a Brother KH 930 with garter carriage.
Material: JUNGHANS "Holiday" (40% cotton, 40% wool, 150m/50g) approx. 250g blue, 100g white, 50g yellow. Small amount pink Angora for the pig, black and lt. green for the embroidery. 3mm crochet hook.
Tension: 25-26 sts and 35-36 rows = 10cm. TD approx. 10**.
Ribs: 1/1 rib at TD approx. 8. The ribs are started with blue and knitted in stripes of 2 rows each blue and white.
Intarsia: Knitted following the chart. Smaller areas can also be swiss-darned.
Arrows on diagrams denote direction of knitting.

Back: Cast on 100 sts and knit 20 R rib. Increase to 106 sts and continue in st st. At **RC 58** mark both edges for armhole. At **RC 120** shape neck. Set carriage for HP and put centre 26 sts and all sts at side opposite to carriage to HP. On first side push to HP on alt. rows at neck edge 6 sts once and 3 sts twice. At **RC 128** cast off rem. 28 sts. Repeat for other side.

Neckband: Knit 1 row in blue over the 50 sts in HP. Arrange for rib and knit 7 rows white and 2 rows blue. Knit the last row as loose as possible and cast off with latch tool.

Front: Cast on and knit rib as for back. Knit in st st to **RC 23** and work intarsia from the chart. Knit neckline starting on **RC 113** as shown on chart. Knit the neckband as on back.

Sleeves: Cast on 50 sts and knit rib as on back. Change to st st and incr. 10 sts evenly across the row. Set **RC 000**. Continue in blue st st, adding the white clouds shown as "6" on chart at random. Shape the sides by incr. 1 st st each side on every 6th row 5 times and on every 4th row 15 times = 100 sts. Knit to **RC 96** and cast off.

Finishing: Embroider the front. For the tail, crochet a chain in pink of 16 sts. Crochet 2 dc's in each chain to produce the curl. Crochet two stars using

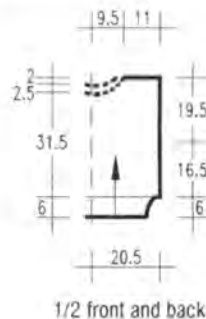

1/2 front and back

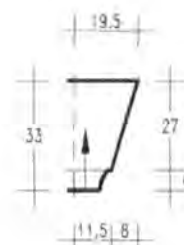

1/2 sleeve

Chart (front/back)

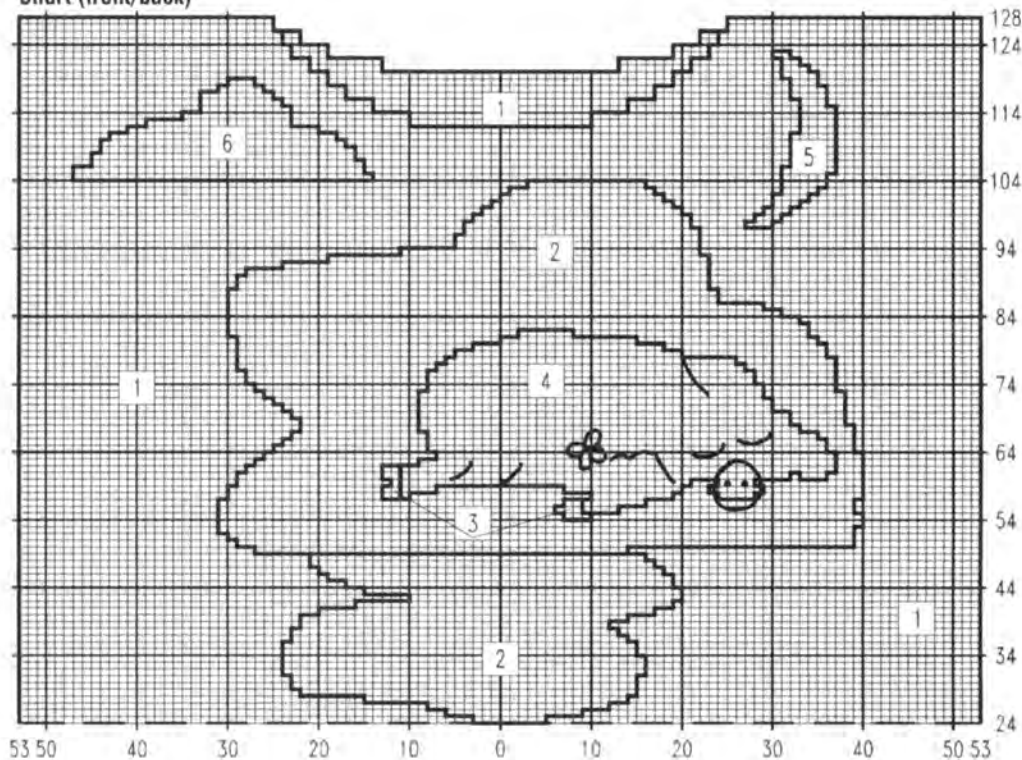

the crochet chart. For the clover leaf make 3 chains. 2nd row: * 2 chains, 1 dc in the chain. Repeat from * 3 times. Fasten off. Close shoulder and neck band seams. Set sleeves between markers. Close rem. seams.

Key to chart:

1 = blue
 2 = white
 3 = black
 4 = pink
 5 = yellow
 6 = white cloud on sleeve only
 1 square = 1 R and 1 st.

Star



**Key to
crochet chart:**

- = 1 chain
- ~ = 1 slip stitch
- | = 1 dc
- l = 1 half treble
- † = 1 treble

Make 8 chains and close into a ring.
Make 2 chains and work from chart.
Arrows denote direction of work.

MODEL 5

SWEATER WITH CATS

Size: 134/140cm

Machines: Suitable for standard gauge machines with intarsia carriage and ribber or garter carriage. We used a Brother KH 930 with garter carriage.

Material: SCHACHENMAYR "Bagnola" (100% mercerised cotton, 180m/50g) approx. 250g white, 100g yellow, 50g blue, small amount black. Drop beads for the shower, 4 buttons, 2.5mm crochet hook.

Tension: 32 sts and 40 R = 10cm, TD approx. 7.

Ribs: 1/1 rib at TD approx. 4. Stitch World pattern 532.

Garter stitch: Knitted over 2 rows in blue. Use Stitch World pattern 537 or punchcard. Could also be knitted by transferring all sts to RB for 1 row and then transferring back to MB.

Fairisle: Use Stitch World pattern 547 or punch a card according to the diagram, repeating the design once in width and once in height.

Intarsia: Follow the chart given, using TD approx. 7.

Embroidery: Enlarge the design and embroider in stemstitch in black. Embroider along bath and over the window. Embroider water drops in blue lazy-daisy stitch.

Back: Cast on in yellow 126 sts and knit 25 R rib. Change to fairisle and knit 32 rows in yellow and white. Continue in white st st. At RC 76 mark both edges for armholes. At RC 156 shape neck. Push to HP the centre 36 sts and knit each side separately. At neck edge push to HP on alt, rows 5 sts once, 4 sts once and 3 sts once. Cast off rem. 43 sts at RC 164. Repeat for other side.

Neckband: Knit 1 row white over sts in HP. Knit several rows waste yarn and release from machine.

Front: Cast on and knit as for back till RC 44. Start intarsia and knit to RC 155. Shape neck as on back.

Neckband: Hang sts from waste yarn on back next to sts in HP on front. Knit 12 rows rib over all 120 sts and cast off with latch tool.

Sleeves: Cast on in yellow 66 sts and knit 25 rows rib. Increase to 84 sts and knit 2 rows yellow. Knit 32 rows in fairisle. * Knit 18 rows white, 2 rows garter stitch in blue. Repeat from * to the end. At the same time, increase 1 st at each side on every 4th row 28 times = 140 sts. Cast off at RC 122.

Finishing: Close left shoulder seam. Crochet along right shoulder 2 rows of dc. At front edge make 4 buttonholes with 5-6 chains each. Sew buttons to backedge and fasten. Embroider the cats. Set sleeves between markers. Close rem. seams.

Chart

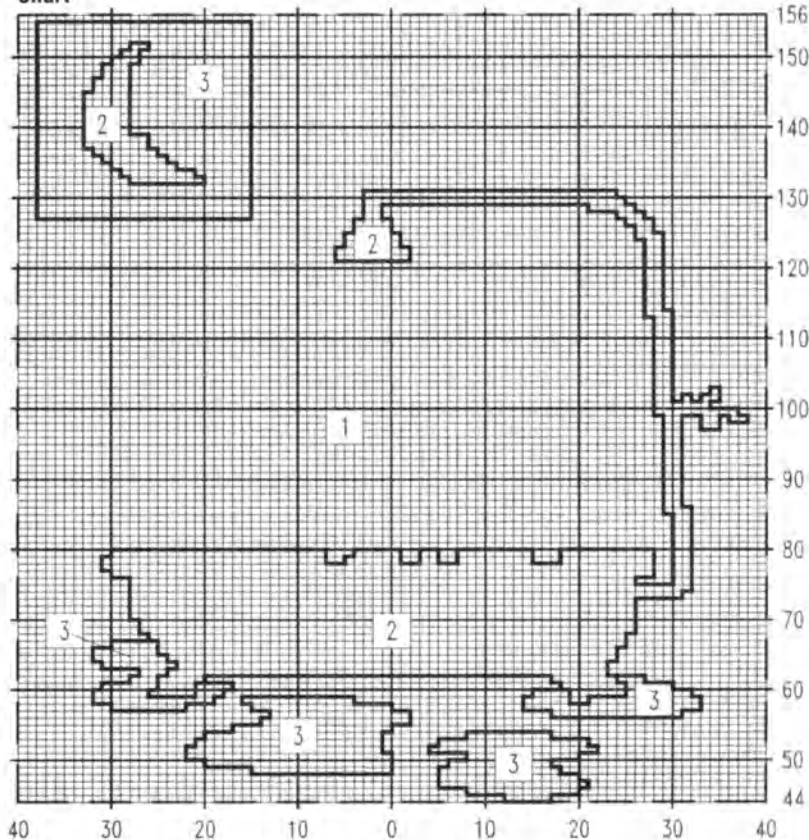

Key to chart:

- 1 = white
- 2 = yellow
- 3 = blue
- 1 square = 1 R and 1 st

Embroidery chart

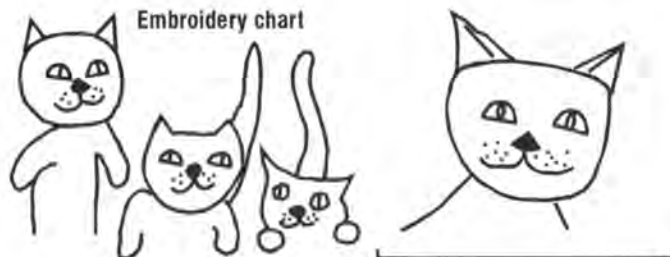

Fairisle pattern 547

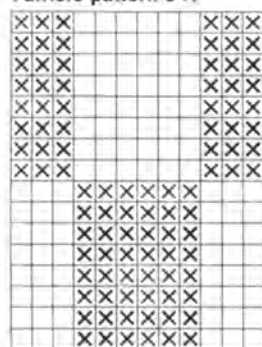

537 garter stitch

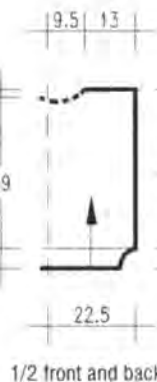
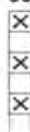

1/2 front and back

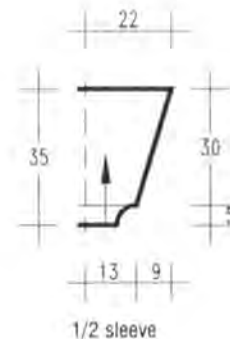

1/2 sleeve

MODEL 6

ORIENTAL BABY JACKET

Size: 68/74cm

Machines: Suitable for chunky machines with intarsia carriage. We used a Brother KH 260.

Material: WSM "Filini" (100% merino wool, 160m/50g) approx. 150g pink, 50g each in lilac, green and fuchsia. Small amounts of viscose yarn in green and green/lilac flecked. Lurex in silver and lilac. Black wool. 5 buttons. 2.5mm knitting needles for welts and bands.

Available as a kit from E&S STRICK-STUDIO, Zinngießergasse 9, 8015 Markt Schaben. Tel.:(010 49) 8121 5302. Send Eurocheque for DM 84,20.

Tension: 22 sts and 34 R = 10cm. TD approx. 0.

Ribs: Knitted by hand as k1, pl rib.

Intarsia: Knitted from the chart. Read all increases and decreases from the chart. Smaller areas can be swiss-darned.

Arrows on pattern denote direction of knitting.

Back: Cast on 70 sts with waste yarn and knit several rows. Set RC 000 and knit following chart 1.

Right front: Cast on 35 sts with waste yarn and knit several rows. Change to main yarn and knit according to chart 2.

Left front: Knit as for right front, using chart 3.

Sleeves: Cast on 50 sts with waste yarn and knit several rows. Change to main yarn and knit in st st in pink. Increase 1 st at each side every 5th row 7 times = 64 sts. At RC 40, shape top. Cast off at each side on alt. rows 5 sts once and 2 sts once. Knit straight to RC 70. Cast off at each side on alt. rows 1 st twice, 3 sts twice, 4 sts once and 5 sts once. Cast off rem. 16 sts at RC 84.

Cuffs: Pick up sts from bottom of sleeves and knit 5cm in kl, pl rib, using pink. Cast off.

Finishing: Close all seams. Set in sleeves, gathering the top to fit. For the **neckband**, pick up 68 sts from neck edge knit 3cm in stocking stitch. Cast off. Fold in half to inside and slipstitch in position. Pick up 140 sts from **lower edge of jacket** and knit 5cm in st st. Cast off and fold to inside. Sew down. For **button bands** pick up 62 sts and knit 4 cm st st. Fold in and sew down. For **buttonhole band** pick up as before.

Make 5 buttonholes after 1cm and 3 cm width by casting off 3 sts on one row and casting on again on the return row. Stitch around the buttonholes to finish. Sew on buttons.

Key:

- 1 = Filini pink
 - 2 = Filini lilac
 - 3 = Filini green
 - 4 = Filini fuchsia
 - 5 = viscose green
 - 6 = viscose green/lilac flecked
 - 7 = silver Lurex
 - 8 = lilac Lurex
 - 9 = black
- 1 square = 1 R and 1 st

Chart 1 (back)

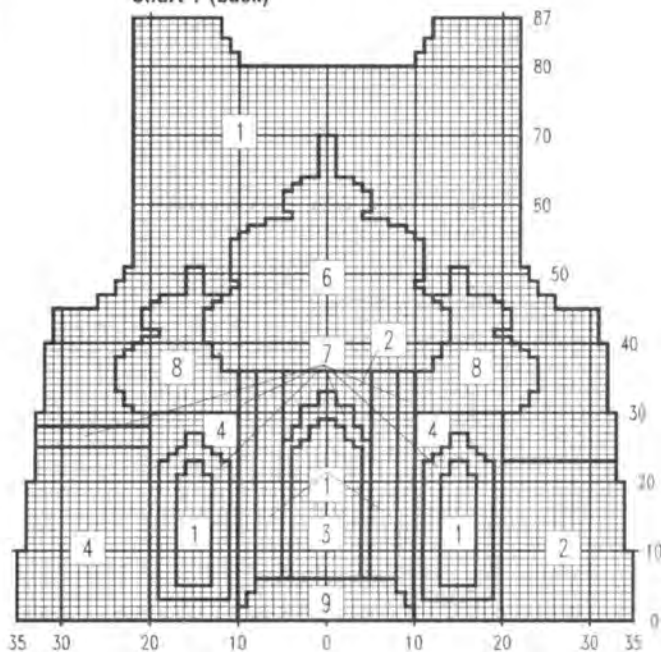

Chart 2 (right front)

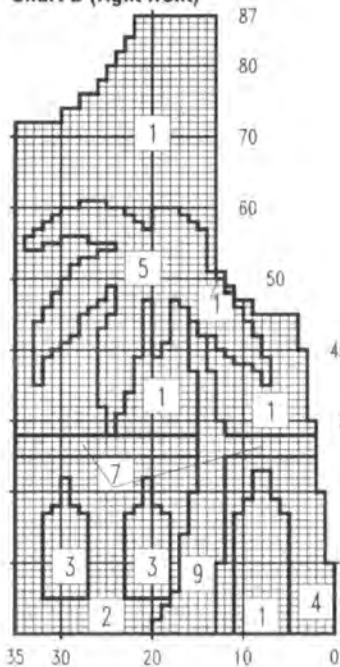
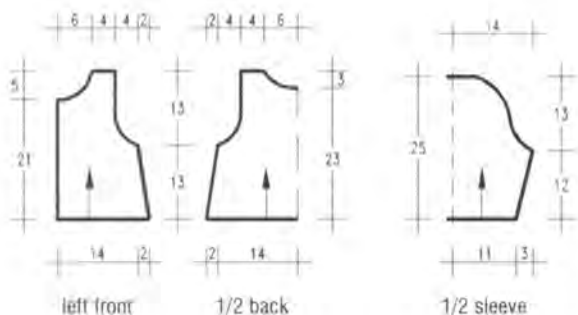
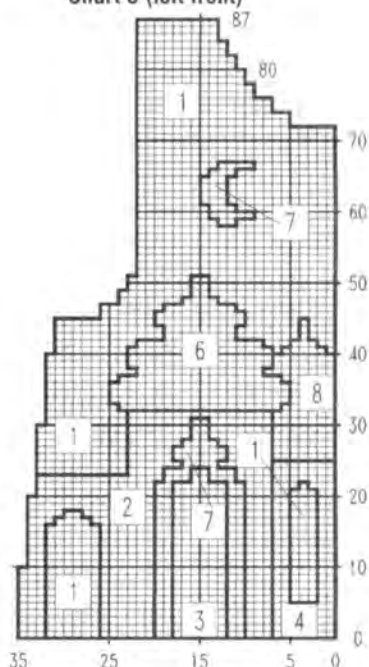

Chart 3 (left front)



MODEL 7

PURPLE SWEATER WITH TEDDY

Size: 62/68 (122/128) The instructions for the larger size are in brackets. One figure only applies to both size.

Machines: Suitable for chunky machines with intarsia carriage. Ribs are knitted by hand. We used a Brother KH 260.

Material: WSM "Filini" (100% mercerised cotton, 160m/50g) approx. 150 (300)g purple. Small amounts of shiny yarn in turquoise and lilac. Angora in grey. Lurex in purple. 2(4) press studs. 2 black beads for the eyes. 1 turquoise bead for teddy's bow. 3mm knitting needles.

Available as complete package from E&S STRICKSTUDIO, Zinngießergasse 9, 8015 Markt Schaben. Tel.:(010 49) 8121 5302. Send Eurocheque for DM 56,10 (84,20).

The sweater is worn with a white T-shirt with lace collar. Lace collars are available at haberdashery shops.

Tension: 22 sts and 34 R = 10cm at TD approx. 0.

Ribs: Knitted by hand as kl, pl rib.

Intarsia: Knitted from the chart. Small areas may be swiss-darned. The chart shows the centre 50 sts only. Continue the diagonal stripes on both sides to the edge of the garment.

Arrows on diagrams denote direction of knitting.

Back: Cast on in waste yarn 56 (86) sts and knit several rows. Change to purple and knit in st st. to **RC 44 (54)**. Shape armholes by casting off 5 (6) sts at beg. of next 2 rows. Decr. at both sides on alt. rows 2 sts once (twice) and 1 st 3 (4) times = **36 (58) sts**. Knit straight to **RC 70 (92)** and shape neck. Push to HP the centre 6 (12) sts and knit each side separately. At neck edge decr. on alt. rows 4 (7) sts once, 3 sts twice and 2 sts once. 3 (8) sts remain at **RC 80 (102)**. After knitting the second side, knit 12 rows purple over the **36 (58) sts** in HP and cast off. Fold band in half to inside and sew down.

Front: Cast on and knit as for back, starting the intarsia on row 1 of st st. Shape the neck and knit the band as on back.

Sleeves: Cast on with waste yarn **40 (48) sts** and knit several rows. Set RC 000 and continue in purple. Incr. at both sides 1 st on every 5th (4th) row 7 (14) times = 54 (76) sts. At **RC 40 (62)** shape top. Cast off 5 sts at beg. of next 2 rows. Cast off 2 (4) sts at beg. of next 2 rows. Knit straight to **RC 70 (90)**. Cast off at each side on alt. rows 1 st 3 (8) times, 2 sts once, 3 sts once and 4 (5) sts twice. Cast off rem. 8 (12) sts at **RC 85 (116)**.

For the **welts** and **cuffs** pick up the sts from the waste yarn and knit 5cm kl, pl rib in purple.

Finishing: Sew on press studs at both sides of neck shaping and close. Sew beads on teddy on front. Close all seams. Set in sleeves, gathering top to fit. If liked, knit a strip over 4-6 sts and stitch around neckline.

Chart

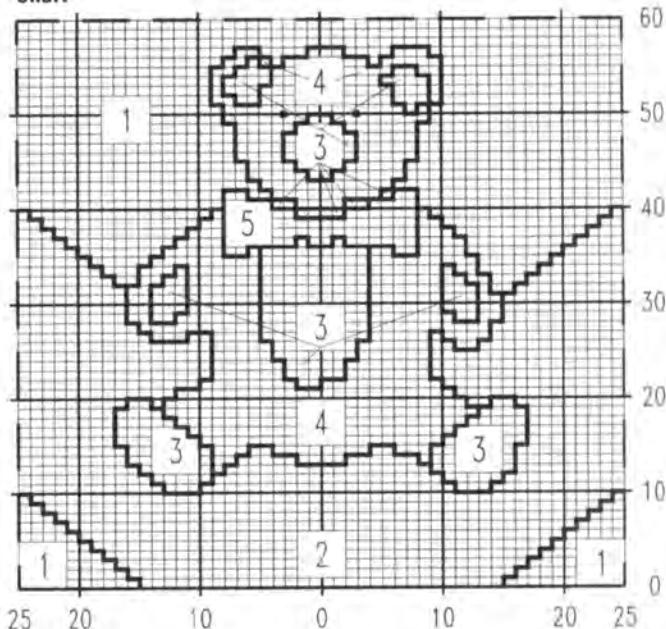

Key:
 1 = lilac
 2 = turquoise
 3 = Angora grey

4 = purple
 5 = lilac Lurex
 1 square = 1 R and 1 st.

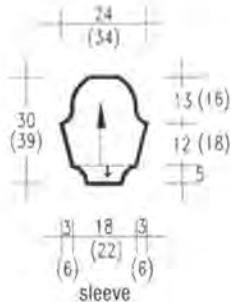
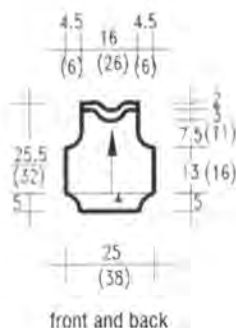

MODEL 8

SWEATER WITH BIRD

Size: 62/68 (122/128)cm. Instructions for the larger size are in brackets. One figure only applies to both sizes.

Machines: Suitable for chunky machines with intarsia carriage. We used a Brother KH 260.

Materials: WSM "Filini" (100% merino wool, 160m/50g) approx. 150 (300)g black. Small amounts of shiny yarn in golden yellow, gold blue, red and green. Some brown flecked yarn. 1 small black bead for the eye, 3mm knitting needles.

The complete yarn kit is available from E&S STRICKSTUDIO, Zinnigbergasse 9, 8015 Markt Schwaben, Tel.: (010 49) 8121 5302. Send Euroque for DM 51,10 (DM 77,20).

Tension: 22 sts and 34 R = 10cm. TD approx. 0.

Ribs: Knitted by hand as kl, pl rib.

Intarsia: Knitted following the chart. Cross threads when changing colour to avoid holes. Small areas may be swiss-darned. The chart applies to the smaller size only. For the larger size

follow instructions below.

Arrows on diagrams denote direction of knitting.

Back: Cast on **60 (84) sts** with waste yarn and knit several rows. Set RC 000 and knit in black st st. At **RC 44 (54)** mark both edges for the armholes. Knit to **RC 90 (110)** and cast off 15 (22) sts at each side on next 2 rows. Take rem. 30 (40) sts on knitting needle and knit 3cm in kl, pl rib in black. Cast off loosely.

Front: Cast on and knit as for back to **RC 2**. Start intarsia and knit to **RC 75 (95)**. Shape neck. Set carriage to HP. Push to HP the centre 10 (20) sts and all sts at side opposite to carriage. Knit each side separately. At neck edge push to HP on alt. rows 3 sts once, 2 sts twice and 1 st 3 times. Cast off rem. 15 (22) sts at **RC 90 (110)**. Knit **neckband** over rem. 30 (40) sts as on back.

Sleeves: Cast on 50 (54) sts with waste yarn and knit several rows. Change to black and knit in st st. Incr. 1 st at side on every 10th row 5 (9) times = 60 (72) sts. At **RC 60 (92)** cast off all stitches.

Welts: pick up sts from waste yarn and knit in kl, pl rib approx. 5cm on all edges.

Finishing: Embroider the front as necessary. Close shoulder and neckband seams. Fold band in half to inside and slipstitch in position. Set sleeves between markers. Close rem. seams.

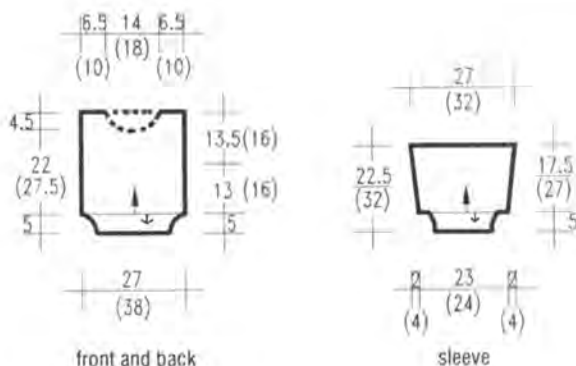

cont. next page

Chart (front) for model 8

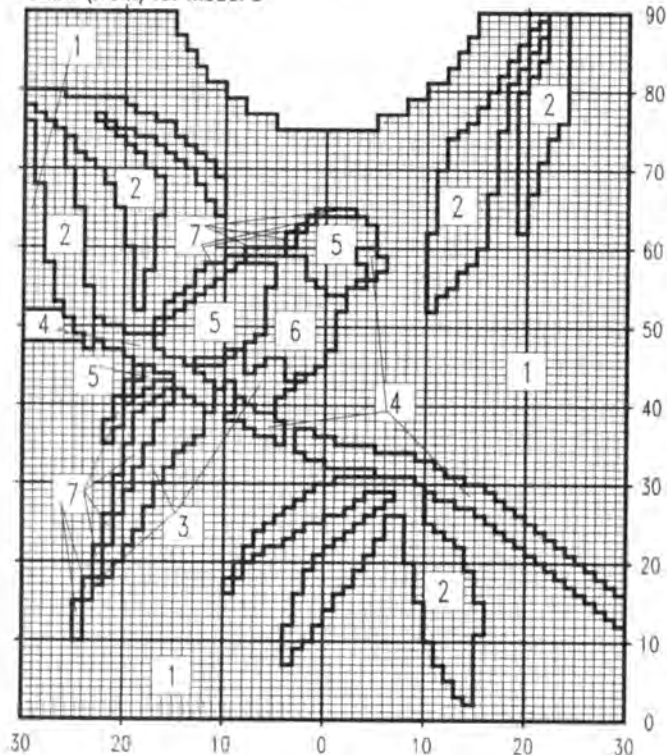

Key:
 1 = black
 2 = brown flecked
 3 = golden yellow
 4 = gold

5 = blue
 6 = red
 7 = green
 1 square = 1 R and 1 st.

Chart for model 9

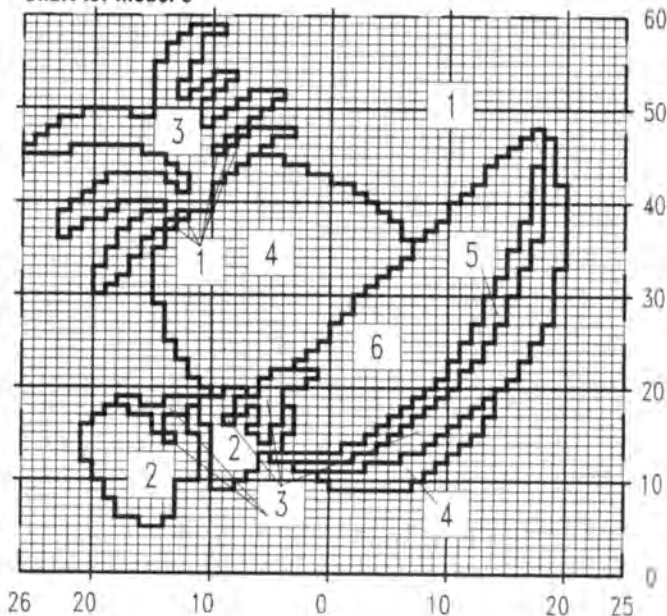

Key:
 1 = white
 2 = red
 3 = green

4 = gold
 5 = yellow
 6 = pink
 1 square = 1 R and 1 st.

Finishing: Close shoulder and neckband seams. Fold band in half to inside and slipstitch in position. With knitting needles pick up 16 (22) sts from one front edge and knit 4 (4.5)cm in white st st. On second front edge, make 2 buttonholes. Lay the two bands on top of each other and sew to the cast off sts at centre front. For the **wells**, pick up sts from waste yarn, reducing them to 50 (70) on back and front. Knit 4 cm in kl, pl rib and cast off. For the **cuffs** pick up the sts and reduce them to 40 (46). Knit 2-4 cm in kl, pl rib and cast off. Set in sleeves between markers. Close rem. seams.

9

MODEL 9

WHITE SWEATER WITH FRUIT

Size: 62/68 (122/128). The instructions for the larger size are in brackets. One figure only applies to both sizes.

Machines: Suitable for chunky machines with intarsia carriage. Ribs are knitted by hand.

Material: WSM "City" (100% cotton, 125m/50g) approx. 150 (300)g white and 50g red. Small amounts in green, gold, yellow and pink. 2 strawberry shaped buttons. Small black beads for the melonseeds. 3.5mm knitting needles.

Available as a kit from E&S STRICK-STUDIO, Zinnigbergasse 9, 8015 Markt Schwaben. Tel.: (010 49) 8121 5302. Send Eurocheque for DM 48,60 (DM 66,30).

Tension: 21-22 sts and 34 R = 10cm at TD approx. D.

Intarsia: Knitted following the chart. Small areas may be swiss-darned. Sew the black beads on as melonseeds.

Arrows on diagrams denote direction of knitting.

Back: With waste yarn cast on 56 (82) sts and knit several rows. Set RC 000 and continue in st st in white. At RC 40 (54) mark both edges for armhole. Knit to RC 80 (102) and shape back neck. Set carriage for HP and push to HP the centre 14 (18) sts at side opposite to carriage. Knit each side separately. At neckline push to HP on alt. rows 4 sts once, 3 sts once and 1 st once (4 sts once, 3 sts once, 2 sts once and 1 st once). Cast off rem. 13 (22) sts at RC 88 (112). Knit other side to match. For the **neckband** knit 10 (12) rows st st over the 30 (38) needles in HP and cast off loosely.

Front: Cast on and knit as for back to RC 5. Start intarsia pattern and work till RC shows 55 (67). Cast off the centre 8 (10) sts for the opening and knit each side separately. On right side knit straight to RC 73 (95). At left edge push to HP for the neck on alt. rows 2 (3) sts once, 2 sts 3 (4) times and 1 st 3 times. Cast off rem. 13 (22) sts at RC 88 (112). Knit **neckband** as described for back. Knit left side, reversing all shapings.

Sleeves: Cast on 50 (52) sts with waste yarn and knit several rows. Set RC 000 and knit in st st: 31 (41) rows white, 2 (4) rows red, 5 (8) rows white, 2 (4) rows green, 5 (8) rows white, 2 (4) rows red, 13 (23) rows white = 60 (92) rows. At the same time, increase 1 st at each side on every 10th row 5 (9) times = 60 (70) sts. At RC 60 (92) cast off all sts.

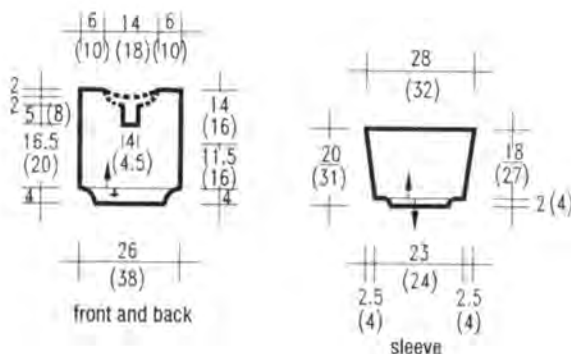

Use yarn with similar meterage when substituting other yarns.

MODEL 10

WHITE JACKET

WITH ZEBRA

Size: 62cm
Machines: Suitable for standard gauge machines with ribber and intarsia carriage. We used a Brother KH930.
Material: WSM "Baby Schulana" (100% merino wool, 205 m/50g) approx 150g white and 50g black. Small amounts of black fluffy yarn and pink shiny yarn. 4 bow-shaped buttons. 1 black button for the eye.
 Available as a kit from E&S STRICK-STUDIO, Zingiebergasse 9, 8015 Markt Schwaben. Tel.: (010 49) 8121 5302. Send Eurocheque for DM 54,60.
Tension: 31 sts and 44 R = 10cm at TD approx. 7.

Ribs: 1/1 rib at TD approx. 3.
Intarsia: Knitted following the chart. Smaller areas may be swiss-darned. The jacket is knitted sideways starting at one sleeve edge.
Arrows on diagram denote direction of knitting.
Cast on 70 sts with waste yarn in centre of bed. Knit several rows. Set RC 000 and change to main yarn. Work intarsia from the chart and also increase at both edges as shown. At **RC 34 and 35**, cast on the additional sts by E-wrap. At **RC 75**, cast off the centre 4 sts and knit each side separately. Knit the right side (back) first. At **RC 100**, read the chart from top to bottom till you reach the end of the neckshaping. Push the needles to HP. Return needles at left to WP and continue to knit the front. At **RC 94**, cast off. Cast on by E-wrap over the same 67 needles and knit the other front, reading the chart from top to bottom and increasing as shown. At **RC 125**, Continue to knit over all stitches but without the intarsia. At **RC 200**, reduce sts to 52. Transfer sts for rib and knit 25 rows. Cast off. Hang sts from waste yarn at beginning on to 52 needles and knit rib as above.

Finishing: Close side and sleeve seams. Pick up 160 sts from lower edge and hang on needles. At TD 7, knit 12 rows. At TD 4, knit 1 row. At TD 10, knit 1 row. At TD 4, knit 1 row. At TD 7, knit 12 rows. Pick up loops from first row and put on needles. Knit 1 row and cast off. Alternately, you may cast off and stitch the hem to the inside.
Neckband: Pick up 84 sts from neckline and hang on needles. At TD 6, knit 6 rows. At TD 3, knit 1 row. At TD 8, knit 1 row. At TD 3, knit 1 row. At TD 6, knit 6 rows. Pick up loops from first row to from hem and cast off.
Button band: Pick up 80 sts from left front edge and place on needles. At TD 6, knit 10 rows. At TD 4, knit 1 row. At TD 10, knit 1 row. At TD 4, knit 1 row. At TD 6, knit 10 rows. Pick up loops from first row and cast off.
Buttonhole band: Pick up sts and knit as for button band, making 4 buttonholes on rows 8 and 16 in your preferred method. Sew on buttons.

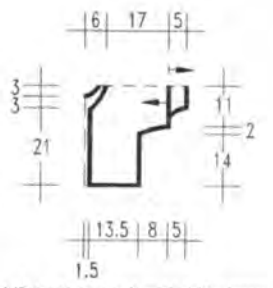

1/2 front or back with 1/2 sleeve

MODEL 11

WHITE SWEATER

WITH TEDDY

Size: 80cm
Machines: Suitable for standard gauge machines with intarsia carriage and ribber or garter carriage. We used a Brother KH 940 with garter carriage.
Material: WSM "City" (100% cotton, 125m/50g) approx. 200g white, 50g each in red, lt. grey and dk. grey. 2 small black beads for the eyes. 6 small red beads. 1 rhine stone for the bow. 2 red buttons.
 Available as a kit from E&S STRICK-STUDIO, Zingiebergasse 9, 8015 Markt Schwaben. Tel.: (010 49) 8121 5302. Send Eurocheque for DM 63,30.
Tension: 26-27 sts and 34 rows = 10cm at TD approx. 10".
Ribs: 1/1 rib with garter carriage at TD approx. 9.
Stripe pattern: 34 R white, 56 R red, 10 R white, 4 R red, 14 R white, 2 R red and 10 R white.

Intarsia: Knitted following the chart. Smaller areas may also be swiss-darned.
Arrows on diagrams denote direction of knitting.
Back: Cast on 80 sts with waste yarn and knit several rows. Set RC 000 and knit in white st st to **RC 51**. Mark both side edges. At **RC 96**, change to rib knitting and knit 12 rows. Cast off.
Front: Cast on 80 sts with waste yarn and knit several rows. Set RC 000 and knit intarsia, following the chart. At **RC 51**, mark both side edges for the armhole. At **RC 84**, shape the neck according to the chart, putting the needles to HP. Knit each side separately. Both sides finish at **RC 96**. Knit 1 row over 80 sts in HP. Change to rib knitting and knit the band as for back, making a buttonhole at each side 10 sts in on row 6.
Sleeves: Cast on 40 sts with waste yarn and knit several rows. Set RC 000 and knit in the stripe pattern, increasing 1 st at each side on every 4th row 17 times and on every 3rd row 3 times = 80 sts. Cast off all sts at **RC 80**.
Cuffs and welts: For back and front welts, pick up sts from waste yarn, reducing them to 72 sts. Knit 1 row st st in white and 18 rows rib. For the cuffs reduce sts to 38 sts and knit as above.

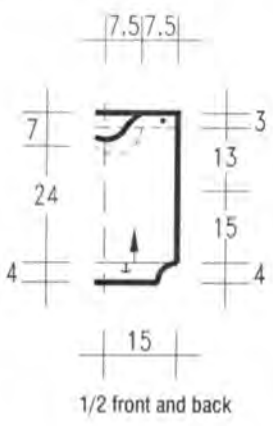

1/2 front and back

cont. next page



1/2 sleeve

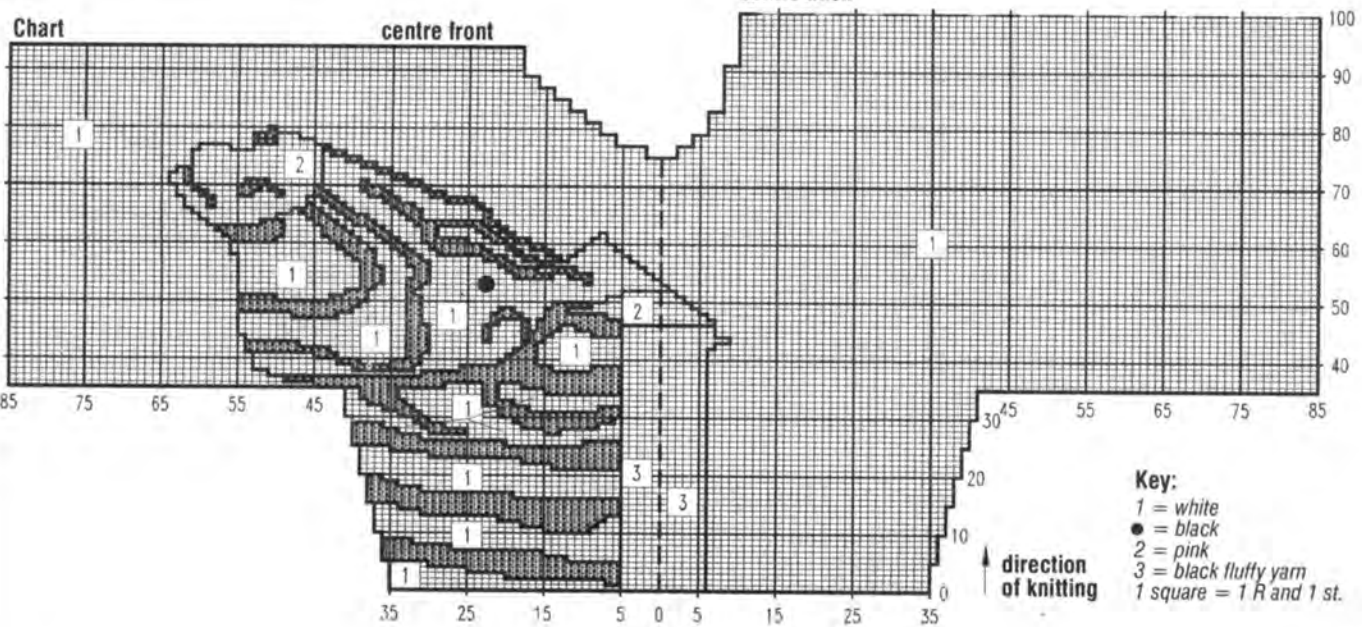

Key:
 1 = white
 ● = black
 2 = pink
 3 = black fluffy yarn
 1 square = 1 R and 1 st.

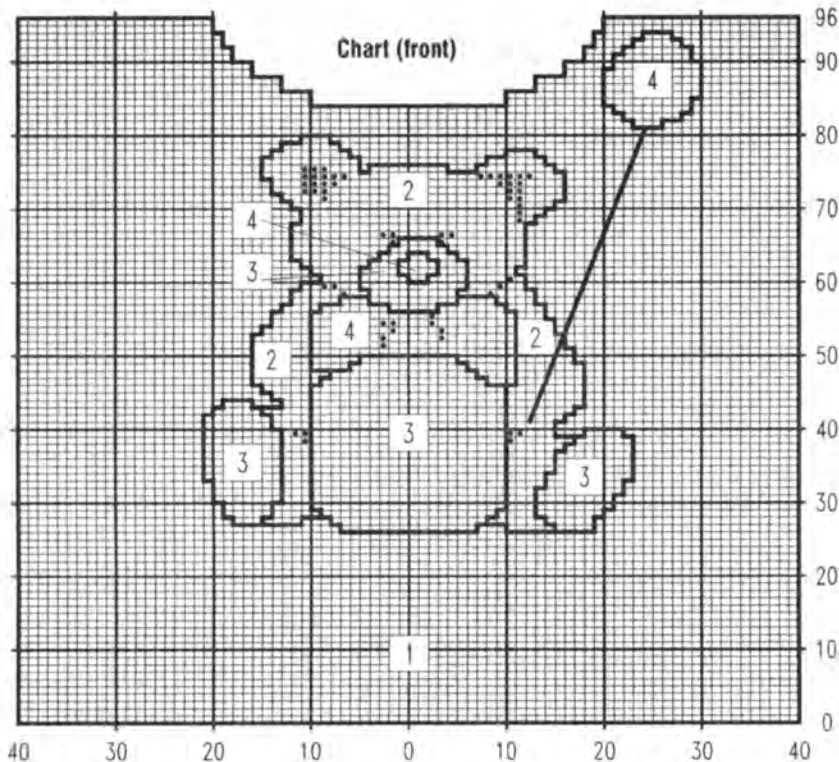

Finishing: Embroider where necessary. Make a chain in dk grey and sew on. Sew on beads. Sew buttons to back neckband. Set in sleeves between markers. Close rem. seams.

Key:
 1 = white
 2 = lt. grey
 3 = dk. grey
 4 = red
 1 square = 1 R and 1 st.

MODEL 12

SWEATER WITH CAT IN CAR

Size: 128cm

Machines: Suitable for standard gauge Brother machines with intarsia carriage and garter carriage. We used a Brother KH 930.

Material: JUNGHANS "Holiday" (60% cotton, 40% wool, 150m/50g) approx. 250g white, 50g each blue, green, yellow and black. "Terzett" (55% polyacryl, 45% polyamid, 385m/100g) approx. 50g pink. 2 small buttons. 2.5mm crochet hook.

Tension: Front and back: 25 sts and 35 R = 10cm. at TD 10. Sleeves: 25 sts and 35 R = 10cm at TD 9* over garterstitch pattern.

Ribs: Knitted with garter carriage 1/1 rib at TD approx. 5.

Intarsia: Knitted following the chart. Small areas may be swiss-darned. The outlines are embroidered in black stemstitch.

Garterstitch pattern: Mark mylar sheet or program machine as shown. The pattern is used over all sts on the sleeves. On the front work 4 single motifs only.

Stripe sequence: 4 R white, 2 R pink, 4 R white, 2 R blue, 4 R white, 2 R green and 4 R white = 22 rows.

Arrows on diagrams denote direction of knitting.

Back: E-wrap cast on 94 sts and with garter carriage knit 22 rows rib in stripe sequence. Take off machine and replace, incr. to 110 sts. Set RC 000 and knit to RC 63. Mark both side edges. Knit to RC 120 and shape neck. Set carriage for HP and push to HP the centre 18 sts and all sts at side oppo-

site to carriage. Knit each side separately. Push to HP at neck edge on alt. rows 4 sts once, 3 sts once and 2 sts once. Cast off the rem. 37 sts at RC 128. Repeat for other side. Knit 1 row over sts in HP. Arrange for rib and knit 2 rows green, 2 rows white, 2 rows blue, 2 rows white, 2 rows pink and 1 row white. Cast off loosely.

Front: Cast on and knit as for back to RC 16. Start the intarsia pattern over the centre 60 sts. At RC 63 mark both side edges. At RC 104, change to garter carriage. Knit the single motifs in garter stitch starting on stitches 45 and 31 left and 21 and 35 right of centre 0. At RC 116, shape neck: Set carriage for HP and push to HP the centre 10 sts and all sts at side opposite to carriage. Knit each side separately. At neck edge push to HP on alt. rows 4 sts once, 3 sts once and 2 sts 3 times. Cast off rem. 37 sts at RC 128. Repeat for other side. Knit neckband as described for back.

Sleeves: Cast on in white E-wrap 58 sts and with the garter carriage knit in garter stitch pattern. Set RC 000. Increase 1 st at each side on every 5th row 19 times = 96 sts. Cast off at RC 99.

Cuffs: Pick up 46 sts from lower edge of sleeve and hang on needles. Knit 22 rows in rib and stripe sequence, reversing the colours. Cast off loosely.

Finishing: Embroider the front. Close shoulder seams, leaving the neckband open on left side. Crochet along the edges with 1 row dc and making 2 buttonholes at front edge. Sew on buttons. Set sleeves between markers and close rem. seams.

Garter stitch pattern

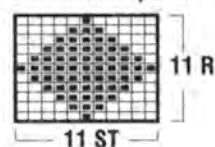

Key:
 1 = white
 2 = pink
 3 = black
 4 = blue
 5 = yellow
 6 = green
 1 square = 1 R and 1 st.

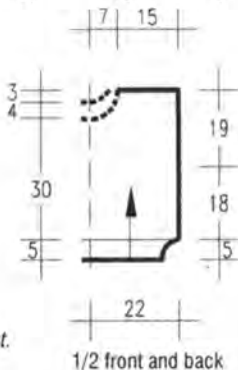
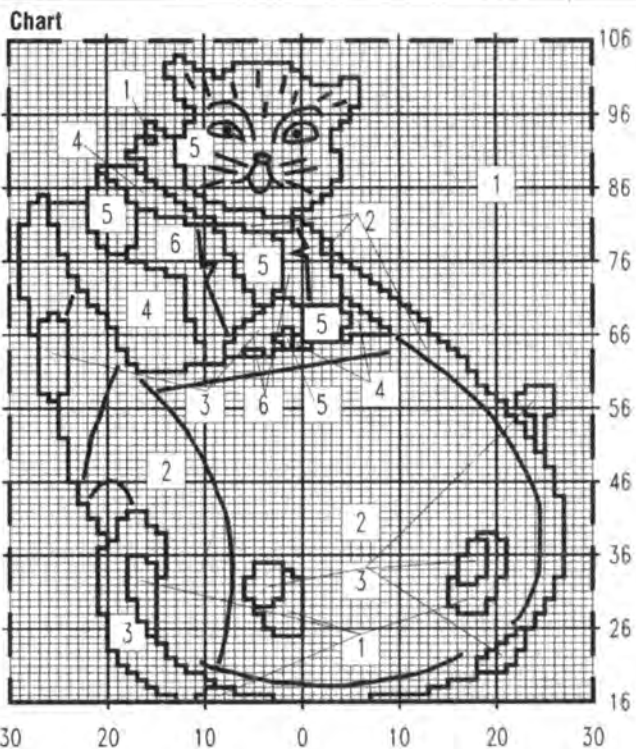

MODEL 13

PINK RAGLAN SWEATER

Size: 116/122cm.
Machines: Suitable for Brother Electronic machines with garter carriage. We used a Brother KH 930.

Material: PINGOUIN "Corrida" (60% cotton, 40% acrylic, 210m/50g) approx. 250g in pink.

Tension: 30 sts and 38 rows as average over all patterns. TD approx. 8.

Cable pattern for welts: Program Stitch World pattern No.536 (k4, p4) and knit at TD 6. Cable the knit sts on every 4th row, taking care to cable always in the same direction. Right side of pattern is facing you.

Basic pattern: Mark mylar sheet or program machine from diagram. Knit at TD 8. On every 4th row cable the 2 sts of cable A. On rows 12, 24, 36, 48 etc. cable the 6 sts of cable B.

Garter stitch pattern No.490: Knitted at TD 8. Move switch No.6 UP to reverse the pattern.

Arrows on diagrams denote direction of knitting.

Back: Cast on 127 sts with the garter carriage and knit 26 rows in cable pattern. Set RC 000 and continue in basic pattern to **RC 92**. Change to Garter stitch pattern No.490 and start raglan shaping. Cast off 6 sts at beg. of next 2 rows. Decr. 1 st at each side on alt. rows 40 times = 35 sts remain. Cast off these sts at **RC 174**.

Front: Cast on and knit as for back to **RC 144**. Cast off the centre 21 sts and knit each side separately. At neck edge cast off on alt. rows 3 sts once, 2 sts twice and 1 st 4 times. At **RC 162**, cast off rem. 3 sts. You will have only made 33 raglan decreases. Repeat for other

Basic pattern over 127 sts and 4 rows

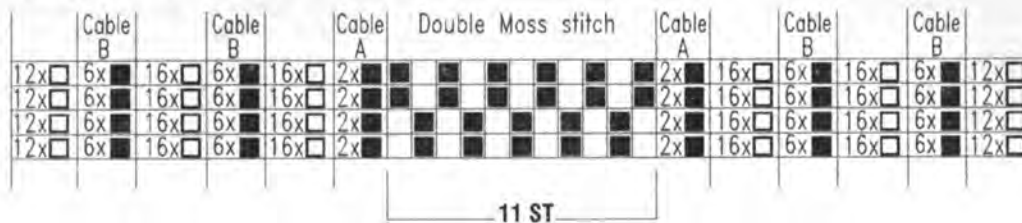

side.

Right sleeve: Cast on with garter carriage 50 sts and knit 26 rows in cable pattern. Knit several rows waste yarn and release from machine. Cast on with waste yarn 63 sts and knit several rows. Change to garter carriage and knit in basic pattern. Increase 1 st at each side on every 4th row 22 times = 107 sts. At **RC 92**, change to garter stitch pattern No. 490 and start the raglan shaping. At left edge decrease as on back, at right edge as on front. At **RC 162**, shape the top. Cast off at right edge 6 sts, and then on every alt. row 5 sts once, 3 sts twice and 2 sts once. At **RC 174**, cast off rem. 3 sts.

Left sleeve: Knit as for right sleeve, reversing all shapings. Attach cuffs to sleeves either by grafting or by machine.

Neck band: Cast on 10 sts over needles 22 to 31 the left of centre. This will knit as purl 2, knit 6 and purl 2. Cable the 6 knit sts as given for basic pattern. Knit **168 rows** and cast off.

Finishing: Close all seams. Sew neckband to neck with the seam at a back raglan seam.

Garter stitch pattern 490

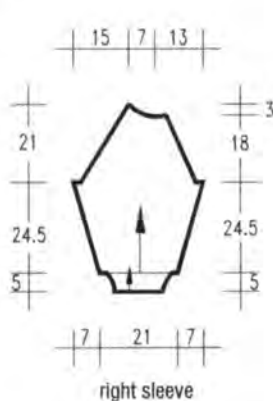
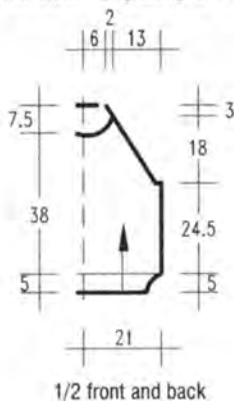
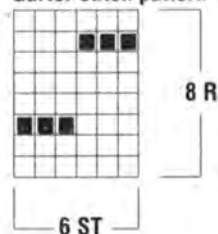

MODEL 14

SWEATER WITH SURFER

Size: 158- 164cm
Machines: Suitable for standard gauge machines with ribber and intarsia carriage. We used a Brother KH 930.

Material: WSM "City" (100% cotton, 125m/50g) approx. 500g black, 100g turquoise and 50g white. Small amounts in fuchsia, yellow and purple. Available as a kit from E&S STRICK-STUDIO, Zingiebergasse 9, 8015 Markt Schwaben. Tel.: (010 49) 8121 5302. Send Eurocheque for DM 96,70 incl. postage.

Tension: 27-28 sts and 37-38 rows = 10cm. TD approx. 9**

Ribs: 1/1 rib at TD approx. 4-5.

Intarsia: Knitted following the chart at TD 9**. Use a separate ball of yarn for each colour. The single stitch lines in black and white can be swiss-darned after knitting.

Arrows on diagrams denote direction of knitting.

Back: Cast on 160 sts with waste yarn and knit several rows. Set RC 000 and change to main yarn. Knit in black st st to **RC 80**. Mark both edges for armholes. Knit to **RC 170** and shape back neck. Set carriage for HP. Push to HP the centre 30 sts and all sts at side opposite to carriage. Knit each side separately. At neck edge push to HP on alt. rows 5 sts once, 4 sts once, 3 sts once and 2 sts once. At **RC 180**, cast off rem. 51 sts. Repeat for other side. Knit 1 row st st over needles in HP. Arrange for rib and knit 22 rows. Cast off loosely.

Front: Cast on and knit as for back, starting the intarsia pattern on first row. Continue in black after the pattern to **RC 142**. Shape neck. Push to HP the centre 24 sts and all sts at side opposite to carriage. Knit each side separately. Push to HP at neck edge on alt. rows 1 st 17 times. Knit to **RC 180** and cast off. Repeat for other side. Knit neckband as described for back.

Welts: Cast on in black for 1/1 rib 126 sts. Knit 36 rows. Transfer all sts to MB. With purl side facing, hang sts from lower edge of back or front on same needles, decreasing as necessary. Knit 1 row and cast off.

Sleeves: Cast on with waste yarn 78 sts and knit several rows. Set RC 000 and continue in black st st. Shape sides by incr. 1 st at each side on every 4th row 18 times and then on every 3rd row 18 times = 150 sts. Knit to **RC 128** and cast off.

Cuffs: Cast on in 1/1 rib 64 sts and knit

36 rows. Transfer all sts to MB. Hang sts from lower edge of sleeve on same needles, decreasing as necessary. Knit 1 row and cast off.

Finishing: Close shoulder and neck band seams. Turn band to inside and slipstitch in position. Set in sleeves between markers. Close rem. seams.

cont. next page

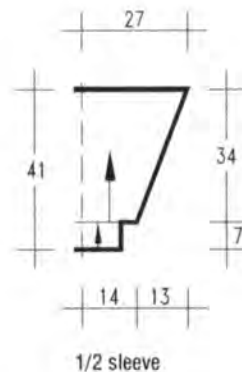
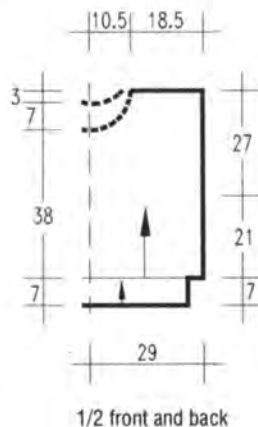

Chart

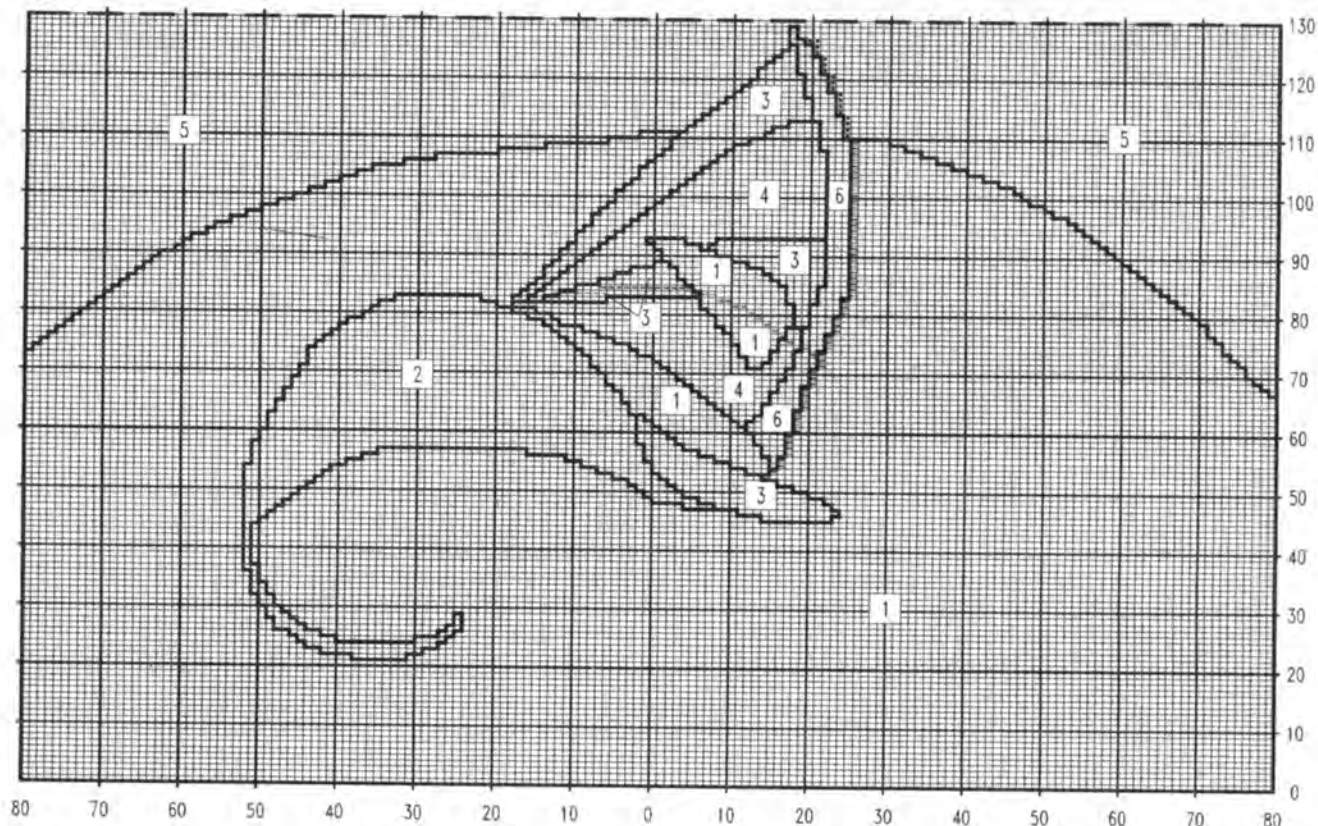

Key:
 1 = turquoise 2 = white 3 = fuchsia 4 = yellow 5 = black 6 = lilac
 1 square = 1 R and 1 st

MODEL 15

BLACK SWEATER WITH FISH

Size: 152/158 (164/170)cm
Machines: Suitable for standard gauge punchcard or electronic machines with ribber. We used a Brother KH 836.
Materials: WSM "Ella" (54% cotton, 46% viscose, 140m/50g) approx. 350(400)g turquoise. WSM "Swing" (100% cotton, 140m/50g) approx. 50g each yellow, lilac and turquoise. WSM "City" (100% cotton, 125m/50g) approx. 200(250)g black. 6 black beads for eyes and 6 glass beads. Available as a kit from E&S STRICKSTUDIO, Zingiebergasse 9, 8015 Markt Schwaben. Tel.: (010 49) 8121 5302. Send Eurocheque for DM 107,00 (DM 118,80) incl. postage.
Tension: 29 sts and 39 R = 10cm over sts st at TD approx. 8. 28-29 sts and 38-39 R over fairisle at TD approx. 9**
Ribs: 1/1 rib at TD approx. 4-5.
Fairisle pattern: Punch card as shown. With black in feeder A, change colours in feeder B as follows:
 Rows 1+2 black st st
 Rows 3-51 black and turquoise
 Rows 52-61 black st st
 Rows 62-68 black and lilac - 3 fish as single motif in centre.
 Rows 69-71 black st st
 Rows 72-76 black and lilac - 3 fish as single motif in centre.

Rows 77-80 black and turquoise
 Rows 81-87 black and lilac
 Rows 88-108 black st st
 Rows 109-154 black and yellow - octopus as single motif in centre.
 Continue in black st st.
 Remember to select needles for fairisle on last row of st st.

Arrows on diagrams denote direction of knitting.

Back: Cast on with waste yarn 150(162) sts and knit several rows. Set RC 000 and knit in turquoise st st to RC 82 (94). Mark both edges for armholes. At RC 180(196) change to black and knit to RC 204(220). Pick up sts from first row in black and hang on needles. Knit 1 row and cast off.

Front: Cast on 150(162) sts as on back. Set RC 000 and knit as given for fairisle pattern. At RC 82(94) mark both sides for armholes. At RC 166(182) shape neck. Set carriage for HP. Push to HP the centre 30(36) sts and knit each side separately. At neck edge HP on alt. rows 2 sts twice and 1 st 4 times. Repeat for other side. Return needles from HP to WP and knit the band as on back. Cast off. Fold band in half to inside and slipstitch in position. Alternately, pick up loops from first row of band onto the same needles, knit 1 row and cast off.

Welts: Cast on in black 120(130) sts in 1/1 rib. Knit 40 rows. Transfer all sts to MB. Pick up sts from lower edge of back or front and hang on same needles, decr. evenly. Knit 1 row and cast off.

Sleeves: Cast on with waste yarn 80 sts and knit several rows. Change to turquoise and knit in st st, increasing 1 st at each side on every 3rd row 40(44) times = 160(168) sts. Cast off at RC 122(136).

Cuffs: Cast on in 1/1 rib 52(56) sts in black and knit 36 rows rib. Attach to lower edge of sleeves as described for front and back.

Finishing: Close shoulder seams for 18(19)cm at each side, set in sleeves between markers. Close rem. seams. Sew on button and glass beads.

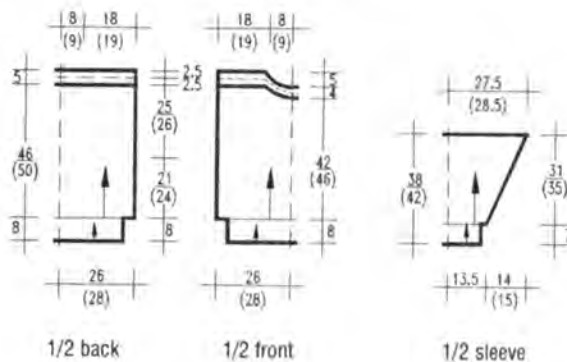

Punchard for model 15



The yarn is available as a kit from E&S STRICKSTUDIO, Zinnigieflergasse 9, 8015 Markt Schwaben. Tel.: (010 49) 8121 5302. Send Eurocheque for DM 85,60 (DM 105,30) incl. postage.

Tension: 29-30 sts and 39-40 R = 10cm. (27-28 sts and 37-38 R = 10cm). TD approx 8** (9**).

Ribs: 1/1 rib at TD approx 4(5).

Intarsia: Follow charts 1-3, using a separate ball of yarn for each colour.

Arrows on diagrams denote direction of knitting.

Front: Cast on 150 sts with waste yarn and knit several rows. Set RC 000 and work according to chart 1. At RC 84 mark both edge for armholes. At RC 170, shape neck and knit both sides separately. Use HP shaping, reading the decreases from the chart. At RC 190, cast off rem. 47 sts. When both sides have been knitted, knit **neck-band**. Return needles to WP and knit 1 row in the respective colours. Knit 1 row in red. Transfer sts for rib and knit 20 rows. Cast off with latch tool.

Back: Cast on and knit as for front, reversing the pattern. Shape the neck as shown for the higher neckline.

Right sleeve: Cast on 82 sts with waste yarn and knit several rows. Set RC 000 and knit, following chart 2 and reversing the pattern for the left side of sleeve. Increase at side edges as shown on chart. At RC 126 cast off.

Left sleeve: Knit as above, using chart 3.

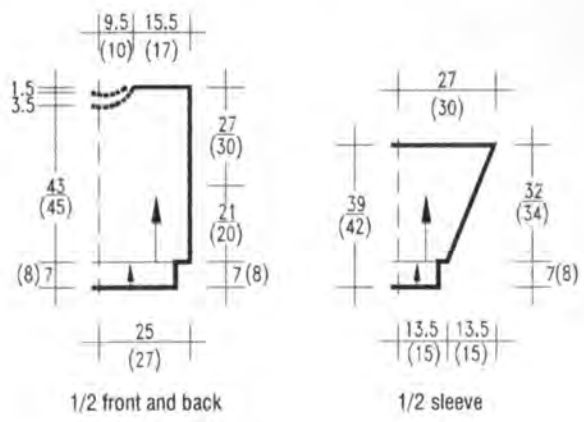

Welts: With red and with RB in position, cast on 120 sts in 1/1 rib and knit 36 rows. Transfer all sts to MB. Pick up sts from edges of back or front and hang on needles, dec. as necessary. Knit 1 row and cast off.

Cuffs: Knit as above over 66 sts.

Finishing: Embroider the whiskers in black. Sew on the 2 buttons above the cat. Close shoulder and band seams. Set in sleeves between markers. Close rem. seams.

cont. next page

16

MODEL
BLACK/WHITE/RED
SWEATER WITH CAT

Size: 152(158)cm. The instructions for the larger size are in brackets. The larger sweater is knitted with the same number of stitches, but on a looser TD setting.

Machines: Suitable for standard gauge machines with ribber and intarsia carriage. We used a Brother KH 930.

Material: WSM "City" (100% cotton, 125m/50g) approx. **300(350)g** red and **150(200)g** each in black and white. 2 small "Cat" buttons.

Chart 1 (front)

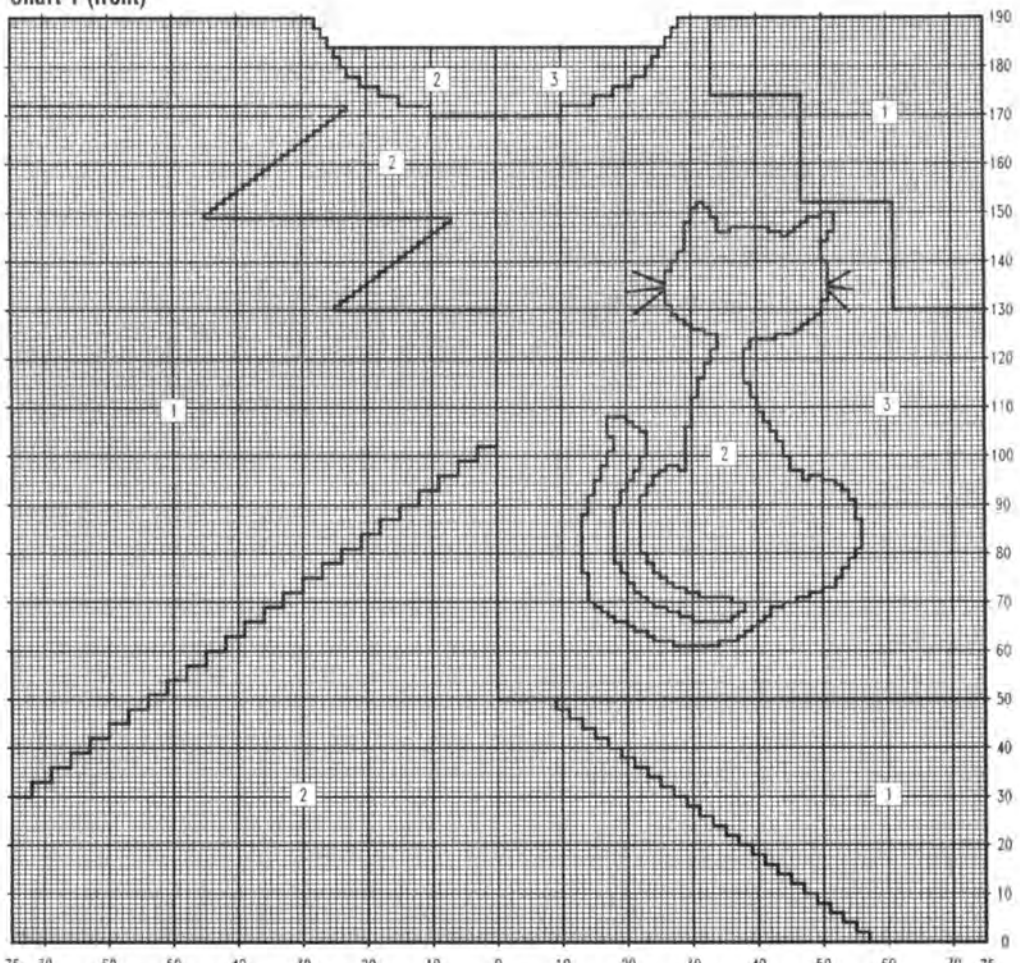

Key:
1 = red
2 = black
3 = white
1 square = 1 R and 1 st

Chart 2 (right sleeve)

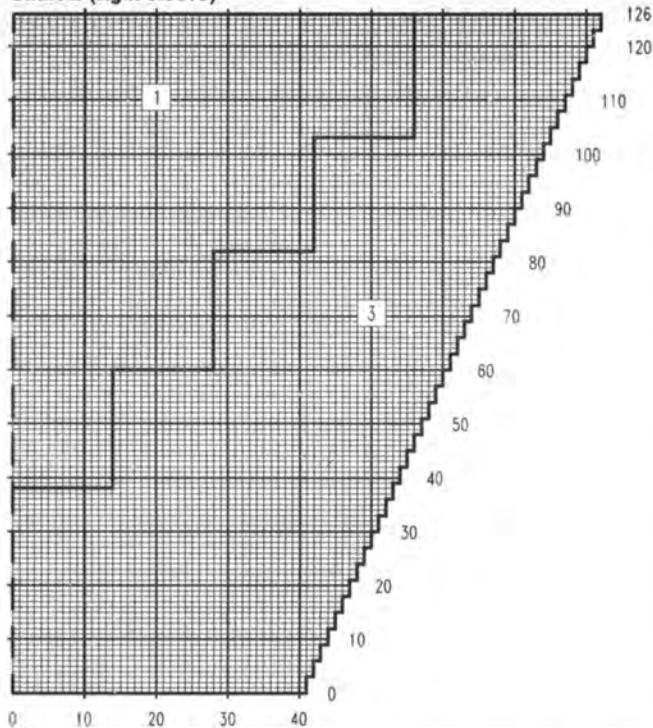
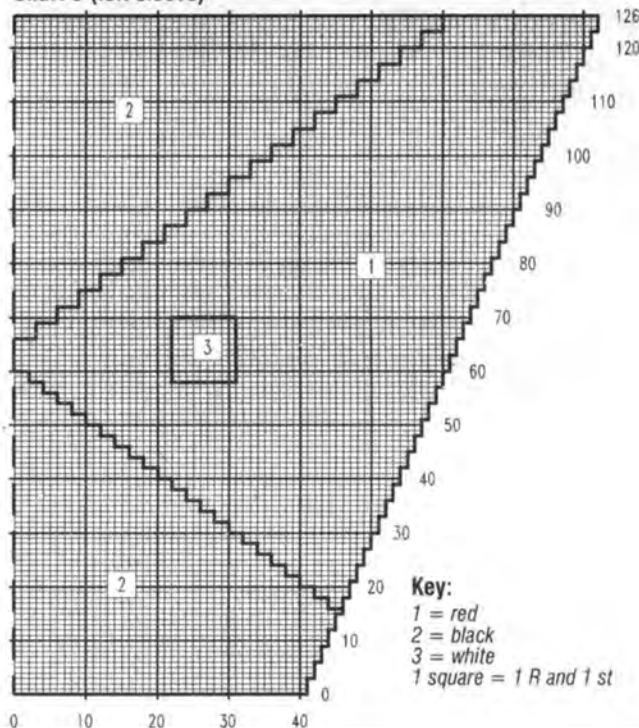

Chart 3 (left sleeve)



Key:
 1 = red
 2 = black
 3 = white
 1 square = 1 R and 1 st

17

MODEL
LANDSCAPE
SWEATER

Size: 158/164cm

Machines: Suitable for standard gauge machines with intarsia carriage and ribber. We used a Brother KH 930.

Material: WSM "Filini" (100% merino wool, 160m/50g) approx, 700g royal and 50g white. "Angora Nova" (75% Angora, 25% lamswool, 95m/20g) approx, 40g purple, 20g each in royal,

dk.grey, lt.grey and white. Small amounts of glitter yarn in silver, gold and blue/black. Pink Angora. Some green and black. Black beads for the snowman.

Available as a kit from E&S STRICK-STUDIO, Zinnigießergasse 9, 8015 Markt Schwaben. Tel.: (010 49) 8121 5302. Send Eurocheque for DM 248,20 incl. postage.

Tension: 29 sts and 39 R = 10cm over st st Filini. TD approx. 8.

Ribs: 1/1 rib at TD approx. 4.

Intarsia: Using the chart, knit at TD 8 with separate balls of yarn for each colour. Smaller areas may be swiss-darned. Stitches marked A and B are cabled as follows: Cable A over 6 sts. Move 3 sts at right to the left and 3 sts at left to the right. Cable B over 6 sts. Move 3 sts at left to the right and 3 sts

at right to the left. Take care to open the latches after cabling, before knitting intarsia again.

Arrows on diagram denote direction of knitting.

Back: Cast on 156 sts in Filini royal and knit 54 rows in 1/1 rib. Transfer all sts to MB. Set RC 000 and continue in st st to **RC 104**. Mark both edges for armholes. Knit straight to **RC 218**. Knit 1 row at TD. 10. Knit 19 rows at TD. 8. Pick up loops from loose row and hang on needles. Cast off.

Front: Cast on and knit rib as on back. Transfer all sts to MB. Set RC 000 and work from chart in intarsia. Mark both edges at **RC 104**. At **RC 194**, shape neck. Set carriage for HP. Push to HP centre 20 sts and all sts at side opposite to carriage. Knit each side separately, pushing to HP at neck edge on

alt. rows 3 sts once, 2 sts twice and 1 st 8 times. Do not cast off rem. shoulder sts, but after knitting the second side, return all needles to WP. Knit neckband as for back over all sts.

Sleeves: Close shoulder seams. With purl side facing you, pick up 188 sts between markers on side edges. With Filini royal knit in stocking stitch, decreasing at each side 1 st on every 2nd row 20 times and on every 3rd row 30 times = 88 sts. At **RC 136**, decrease to 50 sts and knit 1 row. Transfer sts for rib. Knit 35 rows and cast off with latch tool.

Finishing: Embroider the broom in black stemstitch and sew on the beads. Close side and sleeve seams.

Tip:

To keep Mohair and Angora sweaters in good condition, wash them in egg shampoo. When they are dry, put them in a plastic bag in the freezer for 2 hours. Bring them out to thaw gently till they are dry.

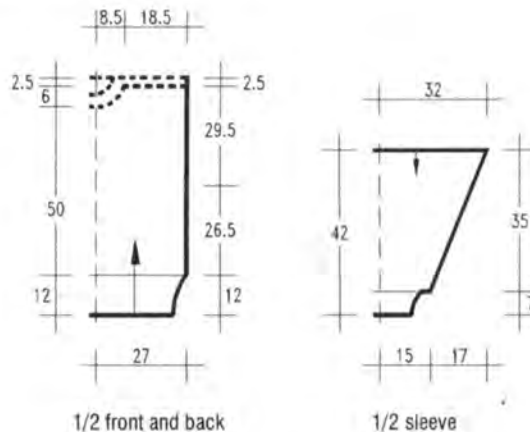
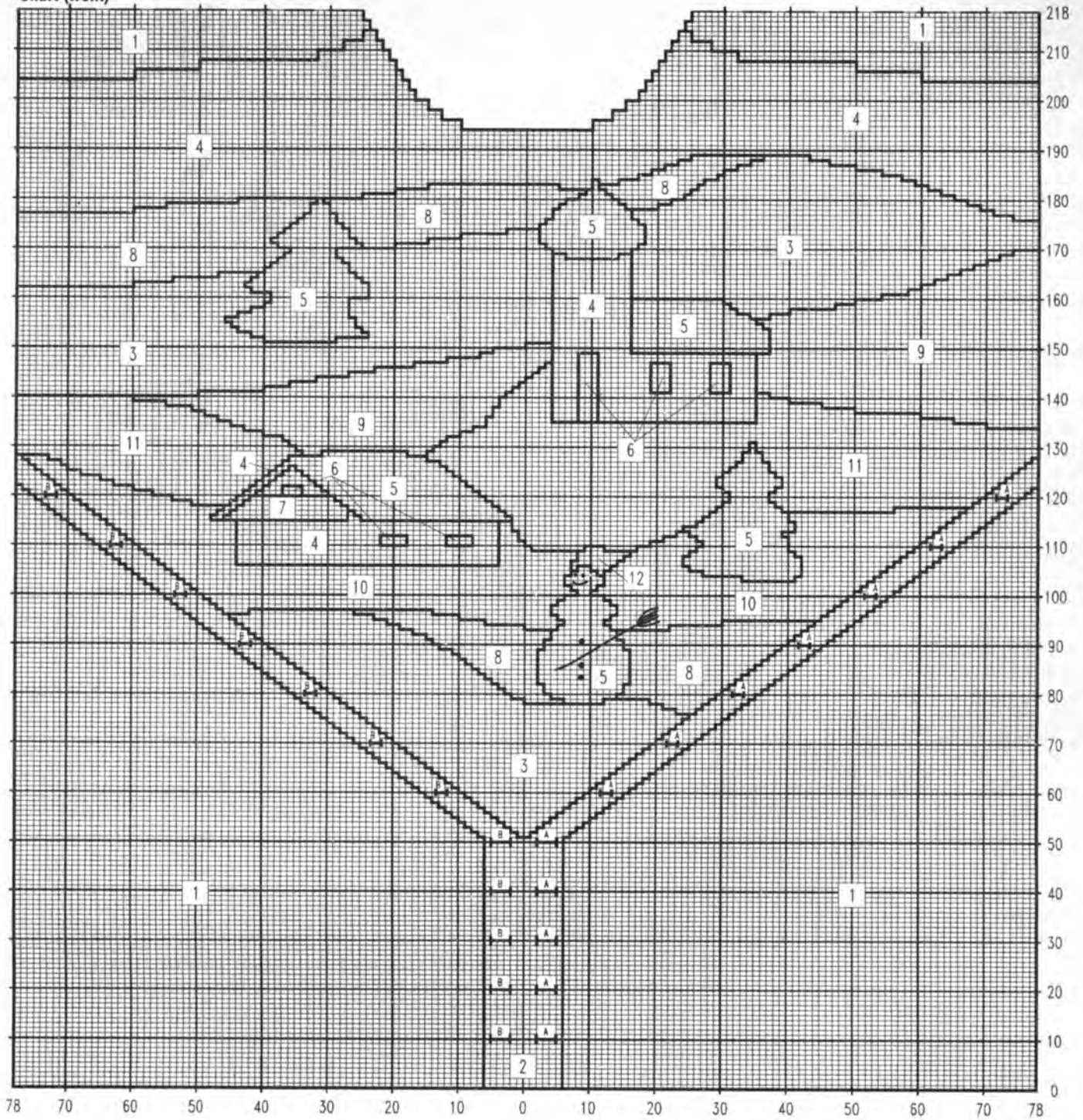

Chart (front)



- | | | | | |
|------------------|-----------------------|----------------------|---------------------------|--------------------------|
| Key: | 3 = Angora Nova royal | 6 = gold Lurex | 9 = Angora Nova ll. grey | 12 = green |
| 1 = Filini royal | 4 = Angora Nova lilac | 7 = pink Angora | 10 = Angora Nova dk. grey | 1 square = 1 R and 1 st. |
| 2 = Filini white | 5 = Angora Nova white | 8 = blue/black Lurex | 11 = silver Lurex | |

MODEL 18

SNOWMAN SWEATER

Size: 149/146cm
 Machines: Suitable for standard gauge

machines with intarsia carriage and garter carriage. We used a Brother KH 930.

Material: SCHACHENMAYR "Regia 4 ply color" (75% wool, 25% polyamid, 210m/50g) approx, **300g** blue flecked. "Regia 4 ply" **50g each** in yellow, white, red, green and blue. 2.5mm crochet hook.

Tension: 28 sts and 35 R = 10 cm. TD approx. 9.

Ribs: 1/1 rib with garter carriage at TD

cont. next page

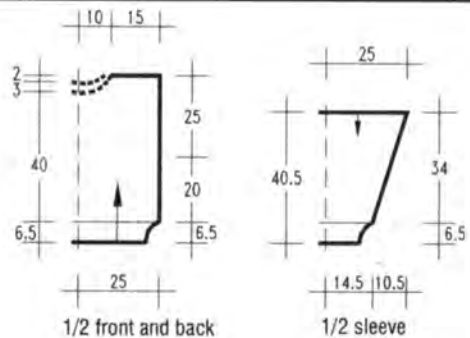

approx. 4.

Stripe sequence: 4 rows each in red, green, yellow and blue = 16 rows.

Intarsia: Knitted following the chart, using separate balls of yarn for each colour.

Garter stitch pattern: For electronic machines use Stitch World pattern No.504. For punchcard machines, punch a card, repeating the design 3 times across the width of the card.

Arrows on diagram denote direction of knitting.

Back: Cast on 120 sts with garter carriage using the blue flecked yarn and knit 30 rows rib. Increase sts to 140 and continue in st st. Knit 16 rows stripe sequence and continue in main colour to **RC 70**. Mark both edges for armholes. At **RC 150**, shape neck. Set carriage for HP and push to HP centre 36 sts and all sts at side opposite to carriage. Knit each side separately. At neck edge push to HP on alt. rows 4 sts once, 3 sts once and 2 sts once. Knit to **RC 158** and cast off rem. 43 sts. Repeat for other side. Return needles to WP and knit 1 row in red. With garter carriage knit 14 rows rib. Cast off with latch tool.

Front: Cast on and knit as for back to **RC 30**. Start intarsia from the chart. At **RC 140**, shape neck. Push to HP centre 10 sts and all sts at side opposite to carriage. Knit each side separately. At neck edge push to HP on alt. rows 5 sts once, 4 sts once, 3 sts once and 2 sts 5 times. After knitting the other side, knit **neck band** as for back.

Sleeves: Close shoulder and neck band seams. Pick up 140 sts from one edge between markers with purl side facing. Knit 16 rows stripes in reverse colour sequence. Change to garter carriage and knit in garter stitch pattern. At the same time decr. 1 st at each side on every 4th row 29 times = 82 sts. At **RC 120**, reduce sts to 64 and knit 1 row. Knit 30 rows in rib and cast off.

Finishing: Sew around the outline of the snowman in black stemstitch. For the eyes and buttons crochet bobbles; make 3 chains and make 3-5 half trebles into the chain, leaving the last loop of each on the hook. Pull the yarn through all the loops and fasten off. The scarf is knitted over 12 sts in stripe pattern. Make 1 piece 30cm long and

one 6cm long. For the broom, make a cord 14cm long. Sew on at edge of snowman. With a crochet hook pull it through behind the hand and sew down. Make a yellow tassel for the top. Embroider a row of red chainstitch along the hat. Close side and sleeve seams.

Garter stitch pattern 504

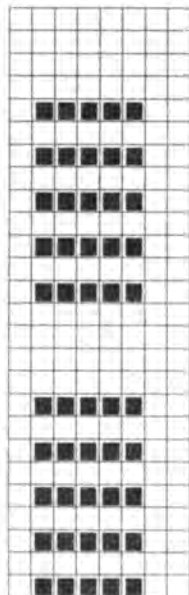

Chart

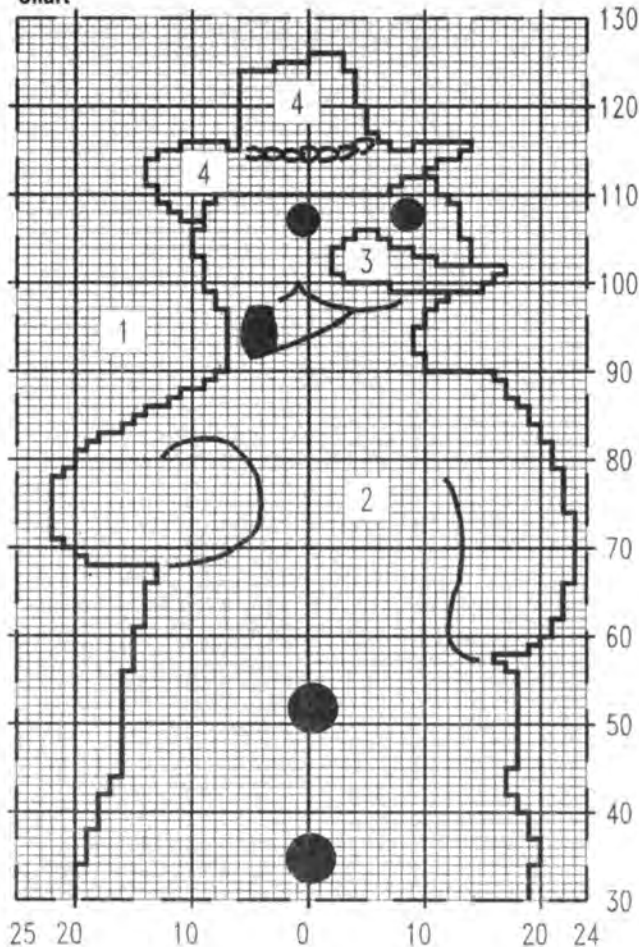

Key to chart:
1 = blue flecked
2 = white

3 = red
4 = green
1 square = 1 R and 1 st.

19

MODEL

CARDIGAN WITH FAIRISLE BORDERS

Size: 140/146cm

Machines: Suitable for standard gauge machines with ribber or garter carriage. We used a Brother KH 930 with garter carriage.

Material: PINGOUIN "Corrida" (60% cotton, 40% polyacryl, 210m/50g) approx. 250g lt.blue, 50g each red, green and yellow. 7 buttons. 3mm crochet hook.

Tension: 30 sts and 38 rows = 10cm at TD approx. 8.

Ribs: 1/1 rib on garter carriage at TD approx. 5.

Fairisle pattern: Program the machine or punch a card to suit your machine. The various symbols show the colours

to be used. The single motif is too large for a punchcard, but can be swiss-darned after knitting. Alternately select the needles by hand prior to knitting each row or substitute a smaller design.

Arrows on diagrams denote direction of knitting.

Back: In lt.blue cast on and knit 24 rows in rib. Set RC 000 and knit 20 rows st st. Knit 54 rows in fairisle and then continue in lt.blue st st. At **RC 98**, mark both edges for armhole. At **RC 152**, cast off centre 40 sts and knit each side separately. Cast off at neckline on alt. rows 2 sts once and 1 st twice. cast off rem. 41 sts at **RC 162**.

Right front: In lt.blue cast on 65 sts and knit as on back, marking the right edge on **RC 98**. At **RC 141**, cast off at left edge 14 sts for the neck. Decr. at left edge on foll. alt. rows 3 sts once, 2 sts twice and 1 st 3 times. Cast off rem. 41 sts at **RC 162**.

Left front: Knit as for right front, reversing all shapings and including the single motif at **RC 94**.

Sleeves: Cast on 50 sts in lt.blue and knit 24 rows in rib. Set RC 000 and knit

pattern as for back. At the same time, incr. 1 st at each side on every 5th row 13 times and on every 4th row 13 times = 102 sts. At **RC 120**, cast off.

Button band: In lt.blue cast on 130 sts and knit 10 rows rib. Cast off with latch tool.

Buttonhole band: Knit as above, making 7 buttonholes at equal distances on the 5th row.

Collar: With lt.blue, cast on by E-wrap 140 sts and knit in st st. to **RC 14**.

Shape front edge by casting off at each side on alt rows 1 st 4 times and 2 sts 3 times. Cast off rem. 120 sts. The collar will lie flatter, if the TD setting is lower at the start and increased gradually towards the end.

Finishing: Sew the bands to the fronts. Close the shoulder seams. Sew on the collar. Set the sleeves between the markers. Close rem. seams. Crochet in yellow around collar: 1st row: dc's. 2nd row: 3 dc's and 1 picot. Sew on buttons.

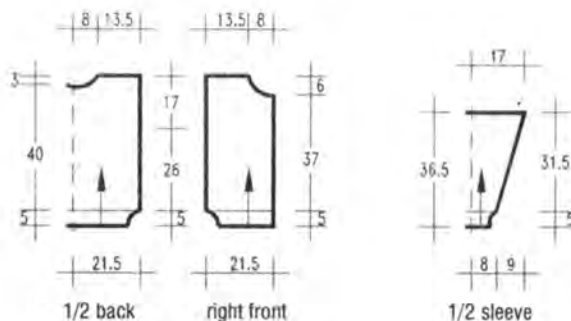

Pattern 91

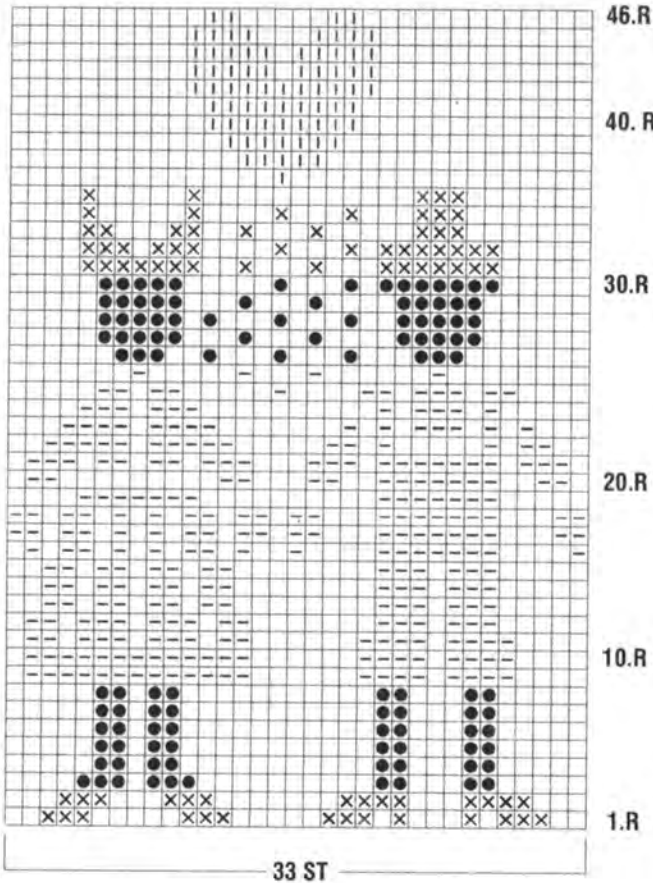

33 ST

Fairisle pattern

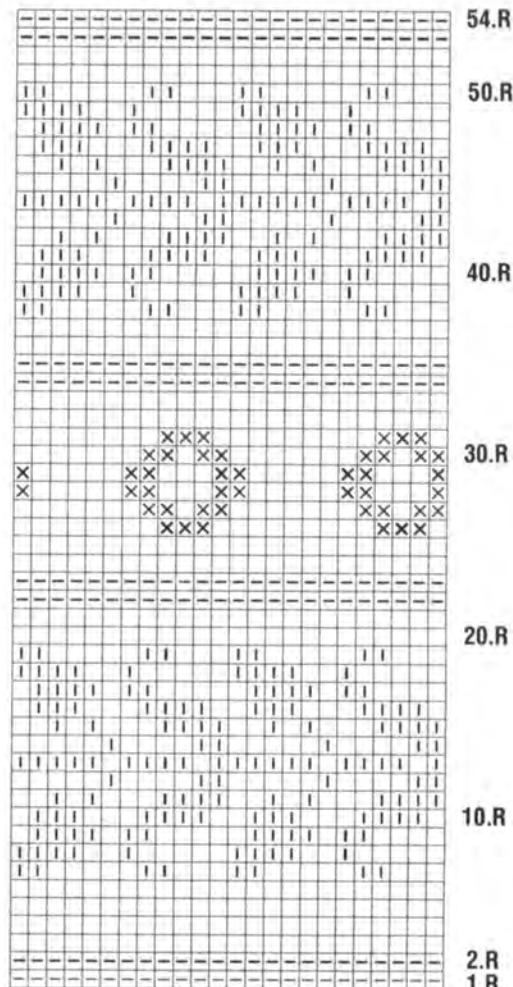

24 ST

Key:

- = yellow
- = lt. blue
- = red
- ⊗ = green
- = pink

1 square = 1 R and 1 st.

MODEL 20

SWEATER WITH MUSICAL MOUSE

Size: 140/146cm

Machines: Suitable for standard gauge machines with intarsia carriage and garter carriage or ribber. We used a Brother KH 930.

Material: JUNGHANS "Baumwoll Color" (51% cotton, 25% viscose, 24% polyaryl), 105m/50g approx. 300g mustard. 50g each in pink, turquoise and purple. Small amount of brown Angora and black wool. 4 guitar shaped buttons.

Tension: 26-27 sts and 34 R = 10cm over st st. TD approx 10**.

Ribs: 1/1 rib with garter carriage at TD approx. 8.

Stripe sequence: 3 rows mustard, 2 rows pink, 3 rows mustard, 2 rows turquoise, 3 rows mustard, 2 rows purple and 3 rows mustard = 18 rows.

Intarsia: Knitted following the chart. Small areas such as the music notes can be swiss-darned. The black lines are embroidered in black stemstitch. The hat has a narrow strip of chainstitch in pink.

Garter stitch pattern: Program machines as in diagram or use a similar punchcard.

Garter stitch band: Consists of 1 row purl and 1 row knit stitches.

Sleeve pattern: 18 rows garter stitch pattern in mustard, * 2 rows pink garter stitch band, 4 rows mustard st st, 2 rows turquoise garter stitch band, 4 rows mustard st st, 2 rows pink garter stitch band **. Knit 24 rows garter stitch pattern in mustard. Repeat from * to **. Knit 30 rows mustard garter stitch pattern = 100 rows.

Back: Cast on in mustard 106 sts and knit in 1/1 rib the 18 rows in stripe pattern. Increase to 116 sts and knit in mustard st st to RC 70. Mark both edges for armholes. At RC 128, shape

neck. Set carriage to HP and push to HP the centre 22 sts and all sts at side opposite to carriage. Knit each side

cont. next page

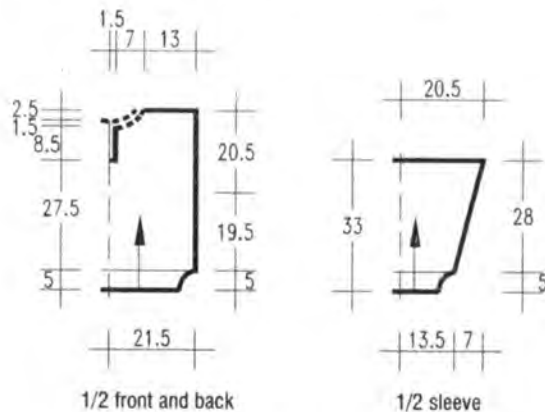

separately. Push to HP at edge on alt. rows 5 sts once, 4 sts once and 3 sts once. Cast off rem. 35 sts at **RC 136**. Repeat for other side. Knit 1 row over needles in HP. Change to rib and knit 6 rows in mustard and 3 rows pink. Knit last row at looser tension and cast off with latch tool.

Front: Cast on and knit as on back to **RC 9**. Start intarsia, taking care to place pattern as shown. At **RC 94**, cast off the centre 8 sts and knit each side separately, right side first. At **RC 123**, push to HP at left edge on alt. rows 5 sts once, 3 sts twice and 2 sts 4 times. Cast off rem. 35 sts at **RC 136**. Knit the neckband over needles in HP as described on back. Knit other side to match.

Sleeves: In mustard cast on 56 sts and knit 18 rows in stripe pattern. Increase sts to 72 and set **RC 000**. Continue in pattern as given above, increasing 1 st at each side on every 5th row 19 times = 110 sts. Cast off at **RC 100**.

Front bands: Cast on in mustard 34 sts and knit 10 rows rib. Cast off. Knit other band the same, making 4 buttonholes at equal distances.

Finishing: Embroider the front. Sew the bands to front opening, overlapping them at the bottom. Sew on buttons. Close shoulder and neckband seams. Set in sleeves between markers. Close rem. seams.

Garter stitch pattern

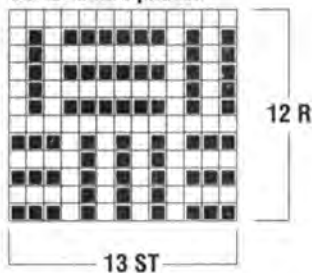

537 Garter stitch



Chart

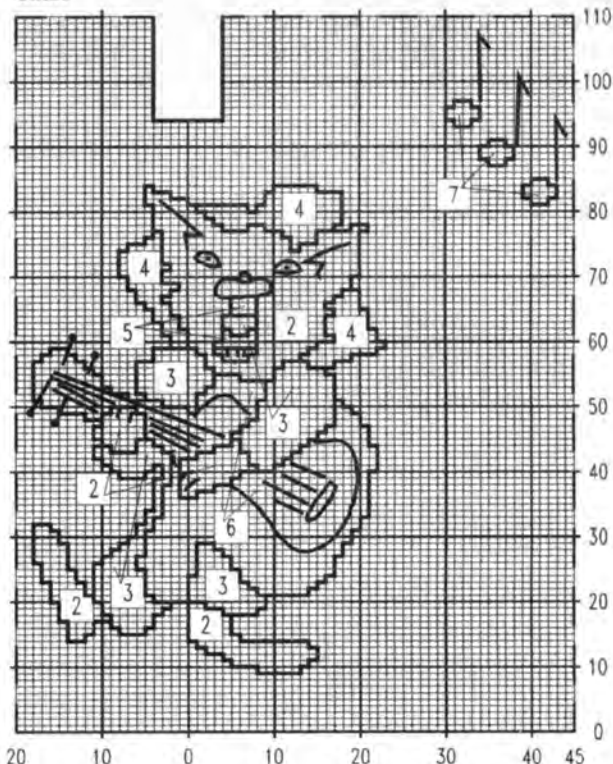

Key to chart:

- 1 = mustard
- 2 = Angora brown
- 3 = pink
- 4 = lilac
- 5 = white
- 6 = turquoise
- 7 = black swiss-darned
- 1 square = 1 R and 1 st.

MODEL 21

SWEATER

WITH TORTOISE AND MOUSE

Size: 116/122 (128/134)cm. The instructions for the larger size are in brackets. One figure only applies to both sizes.

Machines: Suitable for chunky machines with intarsia carriage. We used a Brother KH 260.

Material: JUNGHANS "Karibik" (56% cotton, 25% viscose, 19% polyacryl, 120m/50g approx. **200(250)g** in red, **50g** each olive and ochre. Small amount grey Angora and black. 2.5mm crochet hook. 2.5mm knitting needles.

Tension: 20 sts and 28 R = 10cm. TD approx. 1

Ribs: 1/1 rib knitted by hand.

Intarsia: Knitted from the chart, using separate balls of yarn for each colour.

Arrows on diagram denote direction of knitting.

Back: Cast on 80(88) sts with waste yarn and knit several rows. Set **RC 000** and knit in red st st to **RC 64(72)**. Mark both edges for armholes. Knit to **RC**

108 (120) and shape neck. Set carriage for HP. Push to HP centre 22(26) sts and all sts at side opposite to carriage. Knit each side separately. Push to HP at neckedge on alt. rows 4 sts once and 3 sts once. Cast off rem. 22(24) sts at **RC 116(128)**. Repeat for other side. Knit several rows waste yarn over needles in HP and release from machine.

Front: Cast on and knit as for back to **RC 7(13)**. Start intarsia and knit to **RC 104(116)**. Shape neck. Push to HP centre 16(20) sts and all sts at side opposite to carriage. At neck edge push to HP on alt. rows 5 sts once, 3 sts once and 1 st twice. Cast off shoulder sts as on back. Repeat for other side. Release sts in HP from machine with waste yarn.

Neckband: Close one shoulder seam. Pick up sts from waste yarn and put on knitting needle. **72(80) sts**. Knit in 1/1 rib 6 rows red, 2 rows olive. Cast off loosely. Close second shoulder seam and neckband seam.

Sleeves: With waste yarn cast on 44(46) sts and knit several rows. Set **RC 000** and knit in red st st, increasing 1 st at each side on every 6th row 14(15) times = **72(76) sts**. At **RC 86(96)** cast off all sts.

Welts: From back or front, pick up 72(74) sts and with olive knit 1 row st. Change to 1/1 rib and knit 2 rows olive, 16 rows red and 2 rows olive. Cast off.

Cuffs: Pick up 40(42) sts and knit as

for front or back.

Finishing: Embroider the black lines on the front. Crochet a short chain and

sew on for the tail of the mouse. Set in sleeves between markers. Close side and sleeve seams.

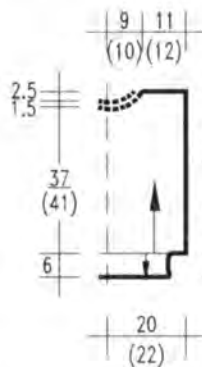

1/2 front and back

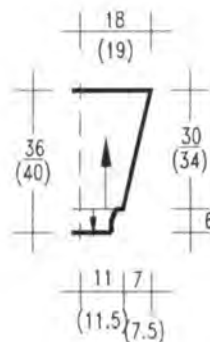

1/2 sleeve

Chart

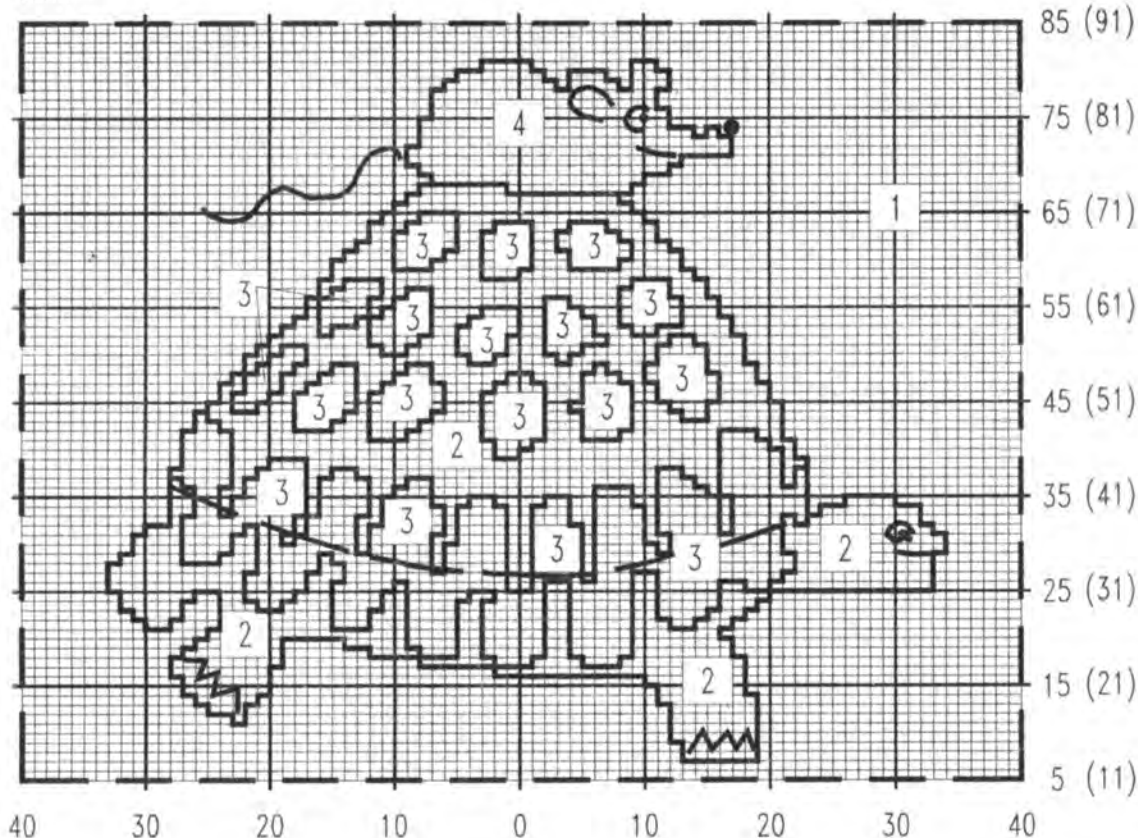

85 (91)
75 (81)
65 (71)
55 (61)
45 (51)
35 (41)
25 (31)
15 (21)
5 (11)

Key:
1 = red
2 = olive
3 = ochre
4 = grey
1 square = 1 R and 1 st.

MODEL 22

SWEATER

WITH BEAR

Size: 122/128 (134/140)cm. The instructions for the larger size are in brackets. One figure only applies to both sizes.

Machines: Suitable for chunky machines with intarsia carriage. We used a Brother KH 260.

Materials: SCHACHENMAYR Jaeger "Kimona" (100% cotton, 100m/50g) approx. 300(350)g mint, 100g pink, 50 g each yellow, gold, violet, green, rose and black. 2 small buttons. 3mm crochet hook. 3mm knitting needles.

Tension: 20 sts and 27 rows = 10cm. TD approx. 1.

Ribs: 1/1 rib knitted by hand.

Intarsia: Knitted from the chart. Use separate balls of yarn for each colour. The black outlines etc. are embroidered after knitting.

Arrows on diagram denote direction of knitting.

Back: Cast on with waste yarn 88(96) sts and knit several rows. Set RC 000 and knit in mint st st to RC 62(68).

Mark both edges for armhole. Knit to RC 116(124). For the shoulder cast off 25(27) sts at each side and leave the centre 38(42) sts as waste yarn.

Front: Cast on as for back. For the smaller size follow the diagram for the decreases and shapings. For the larger size knit the motif over the centre sts. At RC 102, cast off the centre 8 sts for the opening and knit each side separately. At RC 118, cast off at neck edge on alt. rows 9 sts once, 5 sts once and 3 sts once. Knit to RC 124 and cast off. Repeat for other side.

Sleeves: With waste yarn cast on 50 sts and knit several rows. Set RC 000 and continue in mint st st. Incr. 1 st at each side on every 5th row 16(18) times = 82(86) sts. Cast off all sts at RC 84(92).

Wells: Pick up 80(88) sts from lower front or back and knit in rib 16 rows pink and 2 rows green. Cast off in rib.

Cuffs: Pick up 42 sts from lower edge of sleeves and knit as for wells.

Front bands: Pick up 17 sts from front opening and knit 3.5cm in rib. Cast off. In the left band make 2 buttonholes at equal distances.

Collar: Pick up sts from waste yarn on back neck. Pick up 22(24) sts at each side from front neck and half of front band = 82(90) sts. Knit 7cm in green 1/1 rib. Knit 2 rows in pink and cast off.

Finishing: Swiss-darn on sleeves "paw prints" as shown on chart top left. Embroider on front. Set in sleeves be-

tween markers, close side and sleeve seams. Overlap front bands and sew to

cast-off sts at bottom. Sew on buttons.

cont. next page

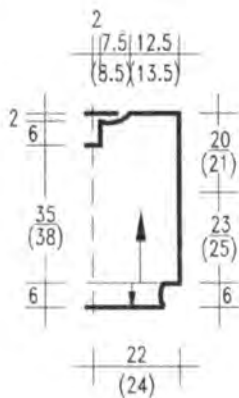

1/2 front and back

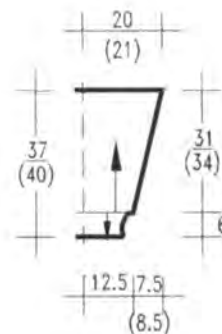

1/2 sleeve

When substituting yarns, use yarns of similar length!

Chart (front)

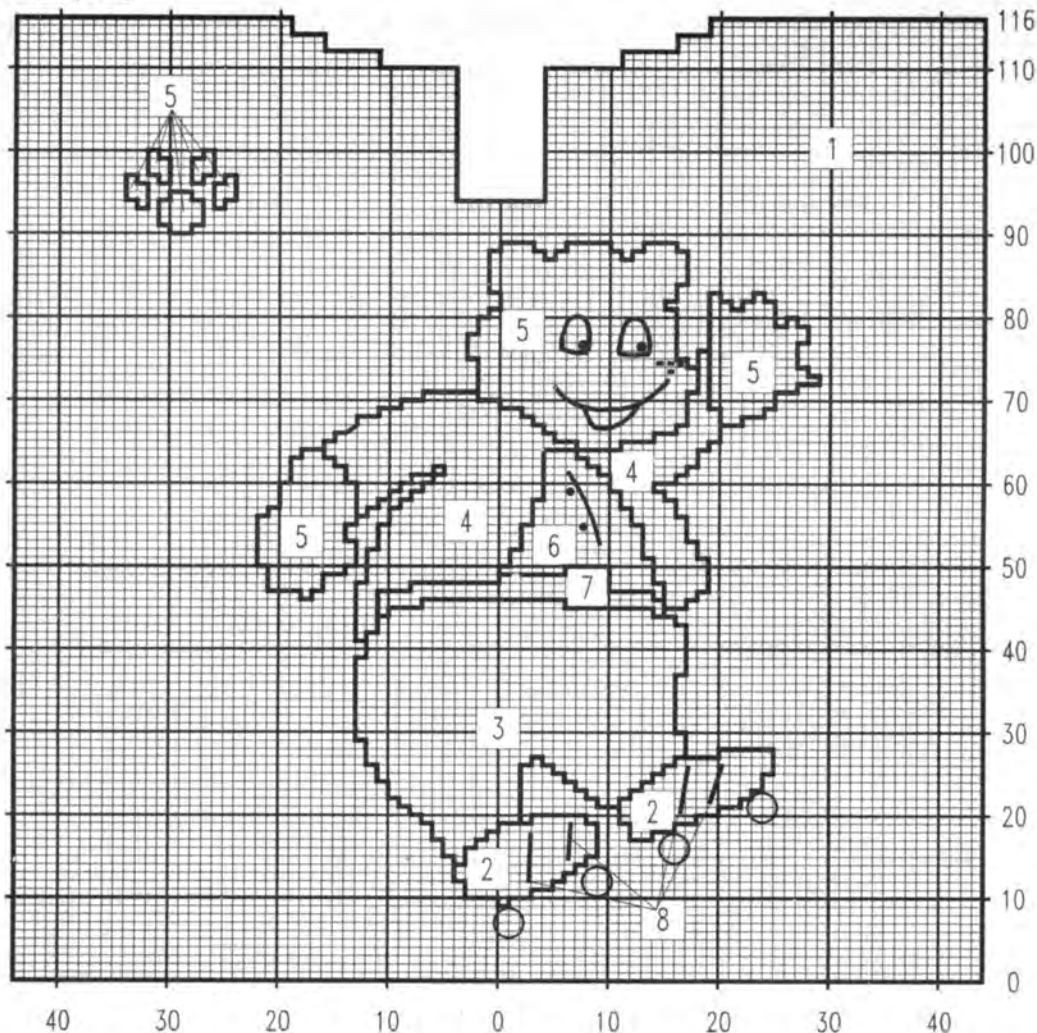

Key:
 1 = mint
 2 = yellow
 3 = violet
 4 = pink
 5 = gold
 6 = rose
 7 = green
 □ = black swiss-darned
 8 = pink chainstitch
 ○ = make 3 chains in black and close to circle. Make 8-10 dc's in circle for the wheels. Embroider contours in stem stitch, french knots in black. Sew on bow. 1 square = 1 R and 1 st.

MODEL 23

BLUE RABBIT SWEATER

Size: 146/152cm
Machines: Knitted on a Singer Double Bed Standard gauge machine.
Material: SCHACHENMAYR "Cherie" (100% cotton, 115m/50g) approx. 400g blue, 50g each green and red.
Tension: 24-25 sts and 30 R = 10cm. TD approx. 10**
Ribs: 2/2 rib. TD approx. 5**.
Arrows on diagrams denote direction of knitting.
Back: Cast on in red 100 sts and knit 26 rows 2/2 rib. Transfer all sts to MB and increase to 114 sts. Set RC 000. Change to blue and knit in st st to RC 65. Mark both edges for the armholes. Knit to RC 128 and shape neck. Set carriage for HP. Push to HP the centre 26 sts and all sts at side opposite to carriage. Knit each side separately, casting off at neck edge on alt. rows 4

sts once and 3 sts once. Cast off rem. 37 sts at RC 134. Return needles to WP and arrange for rib. Knit 8 rows green and cast off.

Front: Cast on and knit as for back to RC 116. Push centre and all sts at side opposite to carriage to HP. Knit each side separately. At neck edge push to HP on alt. rows 3 sts once, 2 sts 4 times and 1 st 3 times. Cast off rem. sts at RC 134. Repeat for other side. Knit neck band as on back over needles in HP.

Sleeves: Close shoulder and band seams. With purl side out, pick up 110 sts along side edge between markers. Knit in blue st st, decreasing 1 st at each side on every 6th row 17 times = 76 sts. At RC 104, reduce these sts to 46. Knit 1 row in blue. Transfer sts for 2/2 rib and knit 26 rows in red. Cast off.

Finishing: Swiss-darn 4 rabbits on front, following the chart. Close side and sleeve seams.

Chart

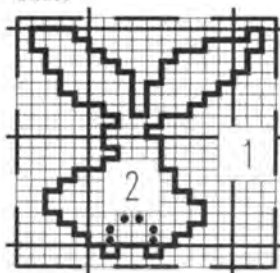

Key:
 1 = blue
 2 = green or red
 3 = red or green
 1 square = 1 R and 1 st.

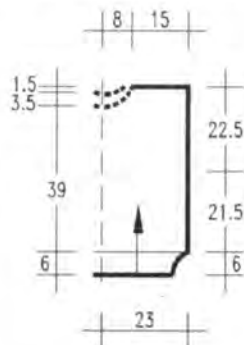

1/2 front and back

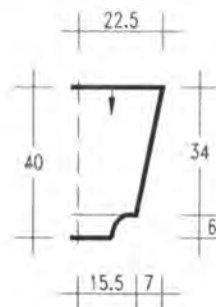

1/2 sleeve

MODEL 24

SWEATER WITH BALLOON

Size: 134/140cm

Machines: Suitable for standard gauge machines with intarsia carriage and ribber or garter carriage. We used a Brother KH 930.

Material: JUNGHANS "Apollo" (50% viscose, 50% polyacryl, 112m/50g) approx. 350g turquoise, 50g each red, blue, white, green and yellow. Small amount of black and grey Angora for the mouse. 3mm crochet hook.

Tension: 25 sts and 33 R = 10cm. TD approx. 10**

Ribs: 1/1 rib with garter carriage at TD 8. Knitted in stripes of 2 rows each turquoise, white, yellow, white, blue, white, green, white and red.

Intarsia: Knitted following the chart. Use separate balls of yarn for each colour.

Arrows on diagrams denote direction of knitting.

Back: Cast on 100 sts and knit 18 rows rib as described. Set RC 000 and increase sts to 110. Continue in turquoise st st to RC 64. Mark both edges for armholes. Knit to RC 124 and shape neck. Set carriage to HP. Push to HP the centre 28 sts and all sts at side opposite to carriage. Knit each side separately, pushing to HP on alt. rows at neck edge 4 sts once, 3 sts once and 2 sts once. Cast off rem. 32 sts at RC 132. Repeat for other side. Knit 1 row st st in turquoise over needles in HP. Change to yellow and knit 20 rows. Cast off.

Front: Cast on and knit as for back to RC 2. Start intarsia and knit to RC 116. Shape neck. Push to HP the centre 10 sts and knit each side separately. At neck edge push to HP on alt. rows 4 sts twice and 2 sts 4 times. Cast off shoulder sts at RC 132. Knit neck band as for back.

Sleeves: Cast on in turquoise 50 sts and knit 18 rows rib in stripe sequence. Set RC 000 and incr. 18 sts evenly across the row = 68 sts. Continue in turquoise to RC 72, incr. 1 st at each side on every 5th row 17 times and on every 4th row twice. From RC 72, knit 6 rows each in red, green, yellow and turquoise. At RC 96, cast off all sts.

Finishing: Embroider the front with black - see photo. Make bobbles: Make 3 chains, make 6 half trebles in first

Chart

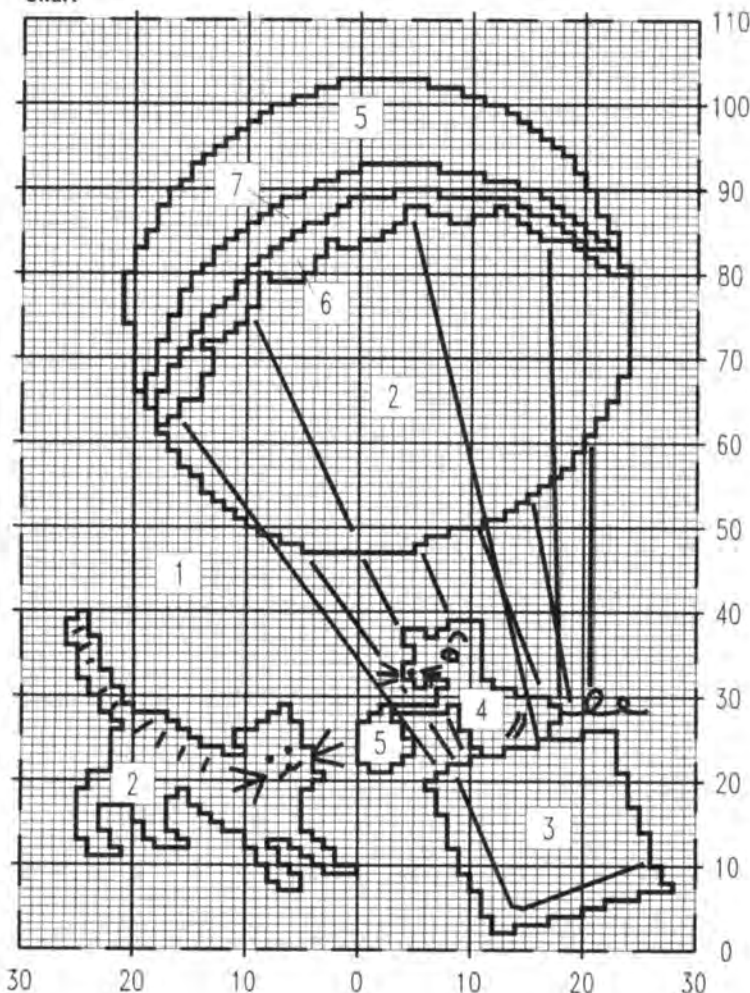

Key:

- 1 = turquoise
- 2 = white
- 3 = yellow
- 4 = Angora grey
- 5 = red
- 6 = green
- 7 = blue
- 1 square = 1 R and 1 st.

chain, leaving the last loop of each on the hook. Pull yarn through all loops and fasten off. Make these bobbles in red, green, blue and yellow and stitch to balloon. Close shoulder and band seams. Set in sleeves between markers. Close rem. seams.

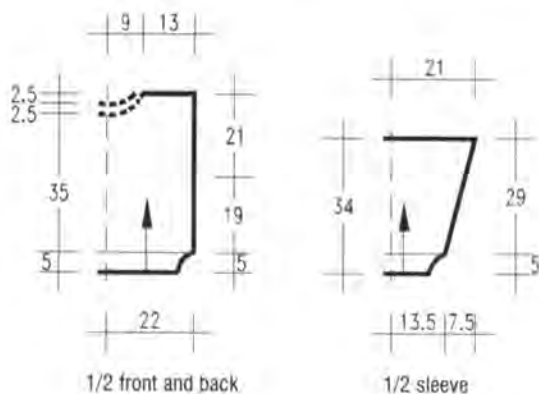

MODEL 25

TURQUOISE GARTER STITCH SWEATER

Size: 146/152 (158/164)cm. The instructions for the larger size are in brackets. One figure only applies to

both sizes.

Machines: Suitable for Brother standard gauge machines with garter carriage. We used a Brother KH 930.

Material: PINGOUIN "Fimp" (50% wool, 50% polyacryl, 185m/50g) approx. 350(400)g turquoise. 2 buttons.

Tension: 28-29 sts and 47 R = 10cm. TD approx. 8.

Ribs: 1/1 rib. TD approx. 5.

Garter stitch: Stitch World pattern No. 540 or mark mylar sheet or punch a card from chart given.

Arrows on diagrams denote direction of knitting.

Back: Cast on 130(132) sts by E-wrap and knit 30 rib. Set RC 000 and continue in pattern. At RC 99(117) mark both edges for armholes. At RC 200(229) cast off all stitches.

Front: Knit as for back to RC 126(140). Divide work for V-neck and knit each side separately. At neck edge cast off 1 st on every 4th row 17(20) times. Cast off rem. 43(46) sts at RC 200(229).

Sleeves: Close shoulder seams. With purl side out, pick up 126(138) sts from one edge between markers. Knit 1 row st st. RC 000. Put switch 5 UP

or set punchcard upside down. Continue in garter stitch pattern, decr. 1 st at each side on every 6th row 27(30) times = 72(78) sts. At RC 170(188), decrease to 46(50) sts and knit 30 rows rib. Cast off.

V-neck band: Cast on 180(190) sts and knit 24 rows rib. On rows 8 and 16, make buttonholes at right edge over needles 6, 7 and 8. Cast off.

Finishing: Sew band into V-neck. Close rem. seams. Sew on buttons.

cont. next page

Pattern 540

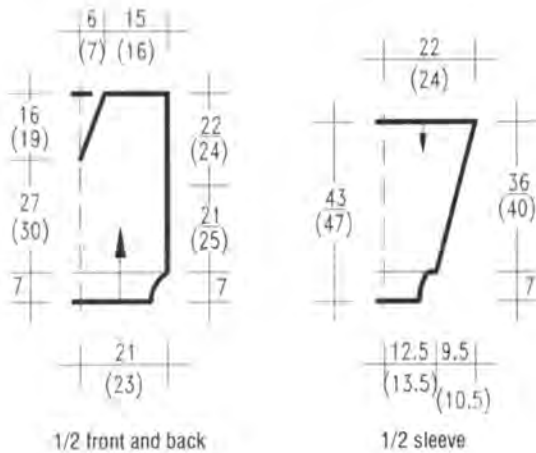
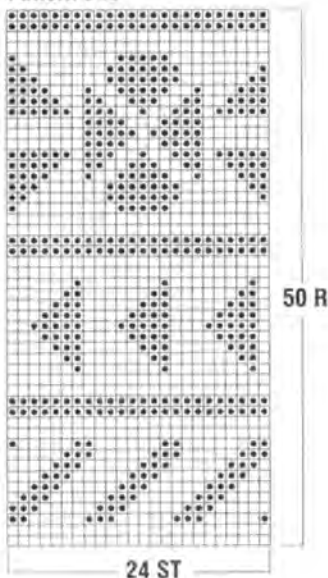

MODEL 26

SWEATER

WITH BEDOUIN

Size: 164-170cm
Machines: Suitable for standard gauge machines with ribber and intarsia carriage. We used a Brother KH 930.
Material: WSM "City" (100% cotton, 125m/50g) approx. **750g** natural, **50g** each brown, lt.brown and grass green. Small amounts of gold for the towers, turquoise, fuchsia, purple, blue, black and black with Luxe. Available as a kit from E&S STRICKSTUDIO, Zinglberggasse 9, 8015 Markt Schwaben, Germany. Tel.: (010 49) 8121. Send Eurocheque for DM 136,20 incl. postage.
Tension: 26-27 sts and 34 R = 10cm, TD approx. 10".
Ribs: 1/1 rib at TD approx. 4-5.
Intarsia: Knitted following the chart. Use separate balls of yarn for each colour. The lead is crocheted in black and the tail in brown. They are sewn on to hang loose. Small areas may also be swiss-darned.
Arrows on diagrams denote direction of knitting.
Front: Cast on with waste yarn 150 sts and knit several rows. Set RC 000 and continue in st st and intarsia. At **RC 78**, mark both edges for armholes. At **RC 140**, shape neck. Set carriage for HP and push to HP the centre 20 sts and all sts at side opposite to carriage. Shape neck as shown on chart, casting off rem. sts at **RC 170**. After knitting second side, return all needles to WP and knit 1 row natural. Knit 20 rows brown and cast off. The band will roll to the outside.
Back: Cast on and knit as for front, omitting the intarsia. Shape neck at **RC 160**. Knit band as for front.
Welts: In natural cast on 116 sts in 1/1 rib. Knit 50 rows. Transfer all sts to MB. Hang sts from back or front, decreasing evenly across the row. Knit 1 row and cast off.
Sleeves: Cast on 80 sts with waste yarn and knit several rows. Set RC 000 and knit in natural and st st. Increase 1 st at each side on every 4th row 32 times = 144 sts. Cast off at **RC 130**.
Cuffs: Cast on 54 sts in 1/1 rib and knit 40 rows. Transfer all sts to MB. Hang sts from lower edge of sleeve, dec. evenly across the row. Knit 1 row and cast off.
Finishing: Close shoulder and band seams. Set in sleeves between markers. Close rem. seams.

Chart

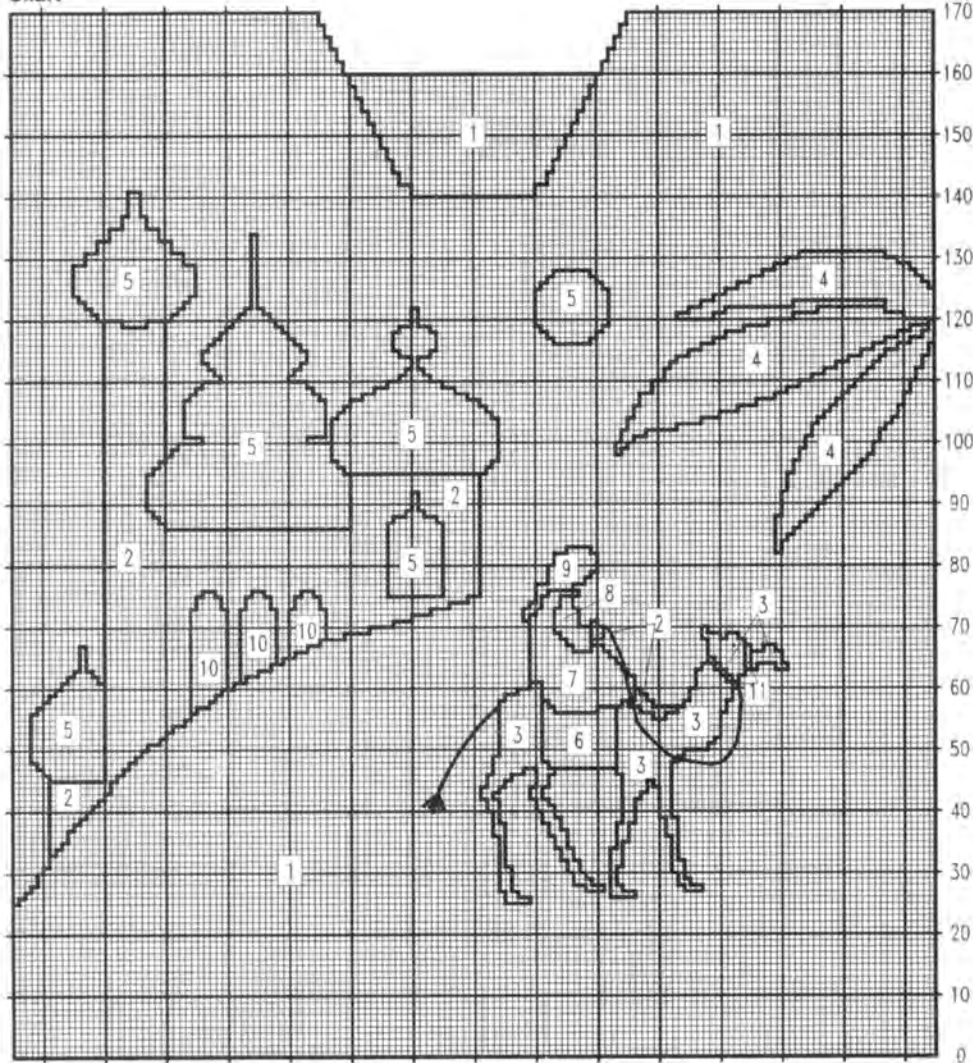

Key:
 2 = brown 4 = grass green 6 = turquoise 8 = lilac 10 = black with lux
 J = natural 3 = lt.brown 5 = gold 7 = fuchsia 9 = blue 11 = black
 1 square = 1 R and 1 st.

MODEL 27

FAIRISLE SWEATER

Size: 146/152 (158/164)cm. The instructions for the larger size are in brackets. One figure only applies to both sizes.

Machines: Suitable for standard gauge machines with ribber or garter carriage. We used a Brother KH 930. Punchcard machines will have to adapt the fairisle pattern.

Material: PINGOUIN "Plai" (100% wool, 200m/50g) approx. 300(350)g gold ochre, 50g each in purple, petrol, dk. red and grey/green.

Tension: Fairisle 30-31 sts and 45 R = 10cm. Stocking stitch 30-31 sts and 42 R = 10cm at TD approx. 7.

Ribs: 2/2 rib on garter carriage at TD approx. 5.

Fairisle pattern: Punch a card or mark mylar sheet or program machine according to the charts. Remember to select needles on last row of stocking stitch. Gold ochre is used as main colour.

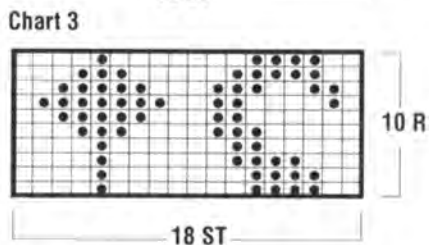
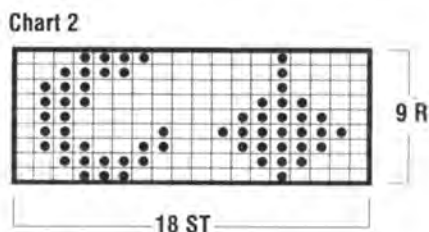
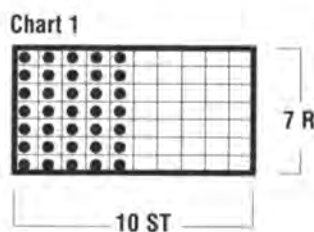

Pattern sequence: 14(20) rows gold ochre, 7 rows purple, 7 rows from chart 1, 13(15) rows gold ochre, 9 rows from chart 2, 8 rows dk red, 15(17) rows gold ochre, 7 rows from chart 1, 9 rows grey/green, 7 rows from chart 1, 15(17) rows gold ochre, 8 rows purple, 10 rows from chart 3, 14(16) rows gold ochre, 7 rows from chart 1, 8 rows petrol, 13(15) rows gold ochre, 8(10) rows grey/green = 180(198) rows.

Arrows on diagrams denote direction of knitting.

Back: Cast on with gold ochre 130(142) sts and knit 30 rows rib. Set RC 000 and knit, following the pattern sequence. At RC 99(108), make both edges for armholes. At RC 180(198), change to rib and knit 20 rows in gold ochre. Cast off.

Front: Knit as for back.

Sleeves: Close shoulder seams except for 22(24)cm in centre. With purl side facing, pick up 134(146) sts from side3 edge between markers. Knit in main colour and st st, decr. 1 st at each side on every 5th row 27(30) times = 80(86) sts. At the same time, when RC shows 84(90), knit a stripe of 8 rows purple. At RC 140(156), reduce sts to 50(54) and knit 30 rows rib. Cast off.

Finishing: Close side and sleeves seams.

MODEL 28

SWEATER WITH FOOTBALLING DOGS

Size: 146/152cm

Machines: Suitable for standard gauge machines with intarsia carriage and ribber or garter carriage. We used a Brother KH 930 with garter carriage.

Material: SCHACHENMAYR Jaeger "Silia" (100% cotton, 140m/50g) approx. 250g green, 50g each in red, yellow, purple, brown, blue, white and black, 4 buttons, 2.5mm crochet hook.

Tension: 27 sts and 36 rows = 10cm. TD approx. 10**.

Ribs: 1/1 rib on garter carriage at TD approx. 8.

Intarsia: Knitted following the chart. Take care to cross the yarns, when

changing colours. The black outlines are embroidered in black stem stitch. The goalposts and cross bar in chain-stitch. For the net, stretch white threads in straight lines across the goalmouth. With sewing cotton fasten down at the crossing points. The goal measures 15X26cm.

Arrows on diagrams denote direction of knitting.

Back: Cast on 120 sts and knit rib in stripes of 4 rows each in blue, green, yellow, purple and 3 rows red. Increase sts to 130 and set RC 000. Continue in green to RC 65. Mark both edges for armholes. At RC 142, knit 1 row blue. Change to rib and knit 4 rows each in blue, yellow and purple. Cast off 90 sts at right. On rem. 40 sts knit 12 rows rib in green for buttonband. Cast off.

Front: Cast on and knit rib as on back. Set RC 000 and work intarsia as charted. In upper rib make 4 buttonholes on the 3rd row of yellow, distributing them evenly over the first 40 sts at right.

Sleeves: Close left shoulder seam. Sew on buttons on right side and

fasten. With purl side facing, pick up 130 sts between markers on side edge. Set RC 000 and knit in red or purple st st, decr. 1 st at each side on every 4th row 19 times and on every 6th row 6 times = 80 sts. At RC 116, reduce the

sts to 60 and change to rib. Knit 20 rows rib in blue or yellow. Cast off. Swiss-darn a football on each sleeve.

Finishing: Embroider the front. Close side and sleeve seams.

cont. next page

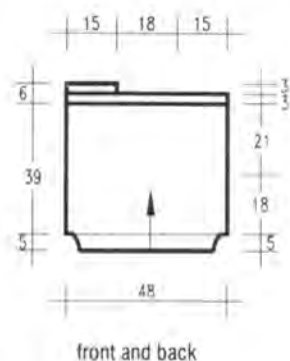

Chart

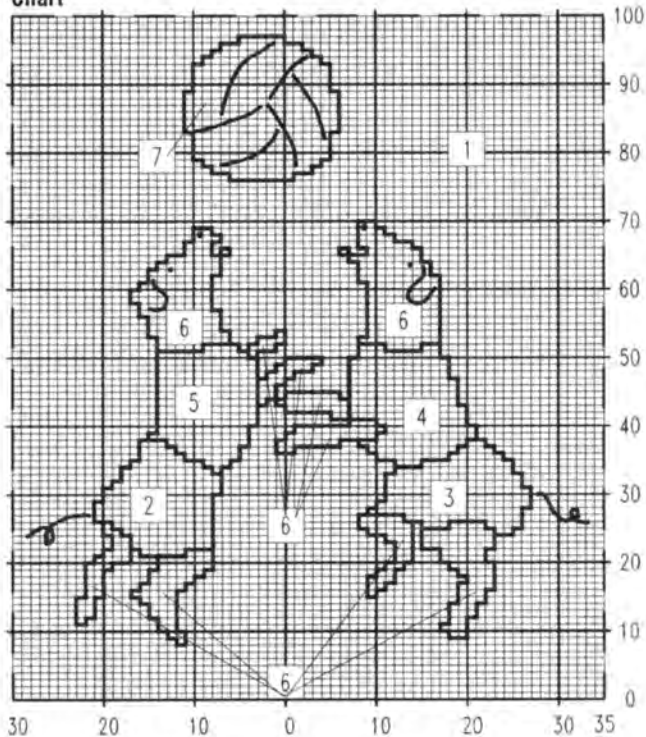

Key:
 1 = green
 2 = blue
 3 = yellow
 4 = red
 5 = lilac
 6 = brown
 7 = white
 1 square = 1 R and 1 st.

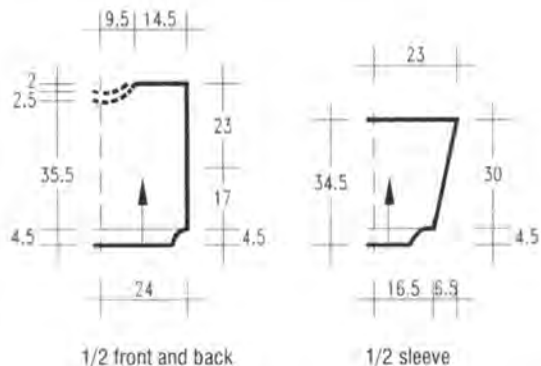

once. Cast off rem. 39 sts at **RC 142**. Repeat for other side. Knit 1 row pink over 52 sts in HP. Knit several rows waste yarn and release from machine. **Front:** Cast on and knit as for back to **RC 38**. Start intarsia and knit to **RC 124**. Push to HP the centre 14 sts and all sts at side opposite to carriage. At neck edge push to HP on alt. rows 4 sts once, 3 sts once and 2 sts 6 times. Repeat for other side. Knit 1 row in pink over 52 sts in HP. For the **neck band**, replace the 52 sts from back neck next to the sts on the machine, **104 sts**. Knit 11 rows in rib and cast off with latch tool.

Sleeves: Cast on in pink 60 sts and knit 20 rows rib. Increase to 90 sts. Set **RC 000** and knit 2 rows in st st. Knit 25 rows fairisle pattern. **At the same time,**

increase 1 st at each side on every 6th row 17 times = 124 sts. Cast off at **RC 106**.

Finishing: Close left shoulder seam. At right side crochet 2 rows dc's making 6 buttonholes on front edge at equal distances. Sew on buttons and fasten them. Set in sleeves between markers. For the scarf, knit a strip over 8 sts approx. 20cm long. For the tie, knit a strip over 12 sts and 20 rows. Tie in centre with a thread and sew on. Pull the scarf through the sweater and sew down on front. Embroider the black outlines. Close rem. seams.

MODEL 29

SWEATER WITH BEAR ON BIKE

Size: 140/146cm

Machines: Knitted on a Brother KH 930 with intarsia carriage and garter carriage. Suitable for other standard gauge machines with ribber and adapted pattern card.

Material: SCHACHENMAYR Jaeger "Silia" (100% cotton, 140m/50g) approx. 350g pink, 50g each black, green, white and purple. 6 buttons in various colours. 2.5mm crochet hook.

Tension: 27 sts and 35 R = 10cm. TD approx. 10**

Ribs: 2/2 rib on garter carriage at TD approx. 6.

Intarsia: Knitted from the chart, using separate balls of yarn for each colour. Smaller areas could be swiss-darned.

Fairisle: Program the machine or mark the mylar sheet. Knit the pattern across the width of the knitting, but only once in height. With pink in feeder 1, change colours in feeder 2 as follows: Rows 1-5 purple; rows 6-12 green; rows 13-20 purple and rows 21-23 green.

Back: Cast on in pink 116 sts and knit 20 rows rib. Increase sts to 130 and set **RC 000**. Knit 2 rows pink. Knit the 25 rows of fairisle and continue in pink to **RC 60**. Mark both edges for armhole. Knit to **RC 134** and shape neck. Set carriage for HP and push to HP the centre 28 sts and all sts at side opposite to carriage. Knit each side separately. At neck edge push to HP on alt. rows 5 sts once, 4 sts once and 3 sts

Chart

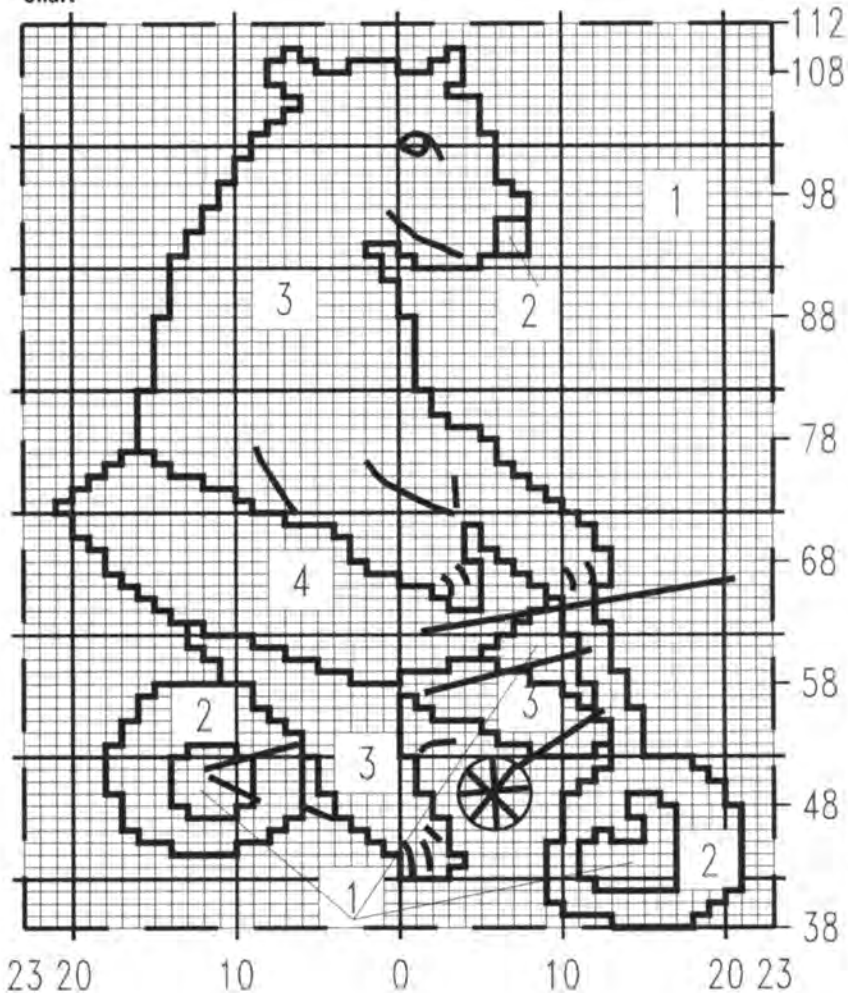

Key to chart:
 1 = pink
 2 = black
 3 = white
 4 = lilac
 1 square = 1 R and 1 st.

Fairisle pattern for model 29

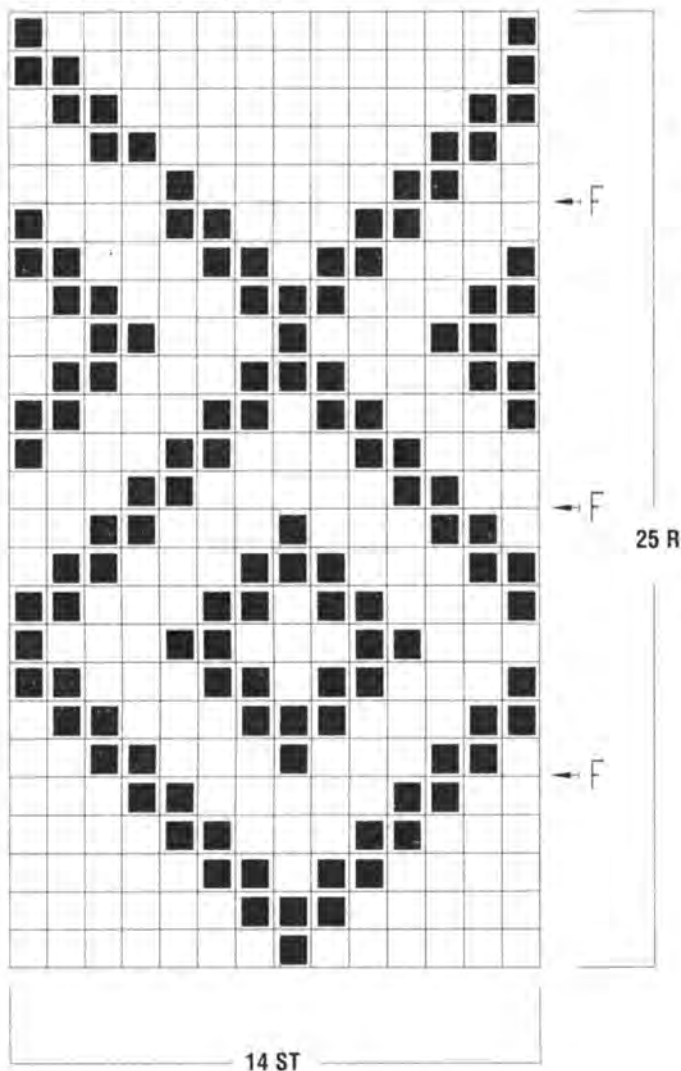

MODEL 30

SWEATER WITH DOG AND BEE

Size: 116/122cm

Machines: Knitted on Brother KH 260 with intarsia carriage. Ribs and moss stitch pattern knitted on standard gauge Brother machine with garter carriage. This part can also be knitted by hand.

Material: JUNGHANS "Apollo" (50% viscose, 50% polyacryl, 112m/50g) approx. 250g turquoise, 50g each yellow, red, green, black and white. Small amount of brown. 3 Or 3.5mm knitting needles if knitting ribs by hand.

Tension: Intarsia 20 sts and 27 R = 10cm. Moss stitch on machine 21 sts and 37 R = 10cm.

Ribs: with garter carriage: 1/1 rib at TD approx. 9.

Moss stitch with garter carriage: Insert punchcard or program machine and knit at loosest possible TD setting.

Intarsia: Knitted on chunky machine at TD. 0 according to the chart. Smaller areas may be swiss-darned. For details of embroidery see key to chart.

Arrows on diagrams denote direction of knitting.

Back: Cast on with waste yarn 84 sts and knit several rows. Set RC 000 and knit in turquoise st st. to RC 62. Mark both edges for armholes. Knit to RC 104, and shape neck. Push to HP the centre 24 sts and all sts at side opposite to carriage. Knit each side separately. At neck edge push to HP on alt. rows 4 sts once, 2 sts once and 1 st once. At RC 112, cast off rem. 23 shoulder sts. Repeat for other side. Return needles from HP to WP and knit 1 row st st. Move sts to standard gauge machine and knit 10 rows in 1/1 rib for neckband with garter carriage. Alternately take sts on knitting needles and knit by hand.

Front: Cast on and knit as for back, but starting the motif from row 1. At RC 62 mark both edges for armholes. Knit to RC 92 and make two pleats as follows: With knitting carriage and using red, knit 8 rows. Pick up loops from first row of red and hang on needles. Knit 4 rows turquoise. Knit 8 rows yellow and pick up loops from first row of yellow and hang on needles. Knit 1 row tur-

cont. next page

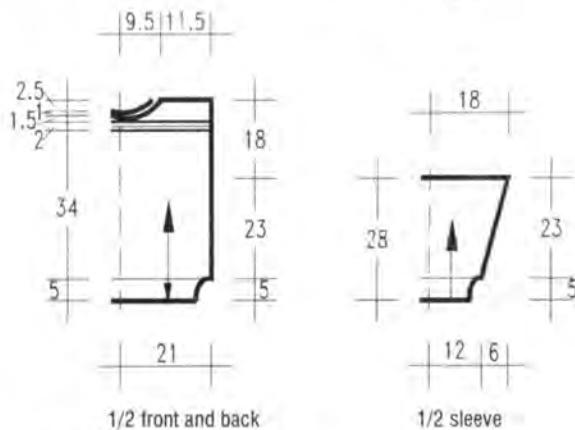
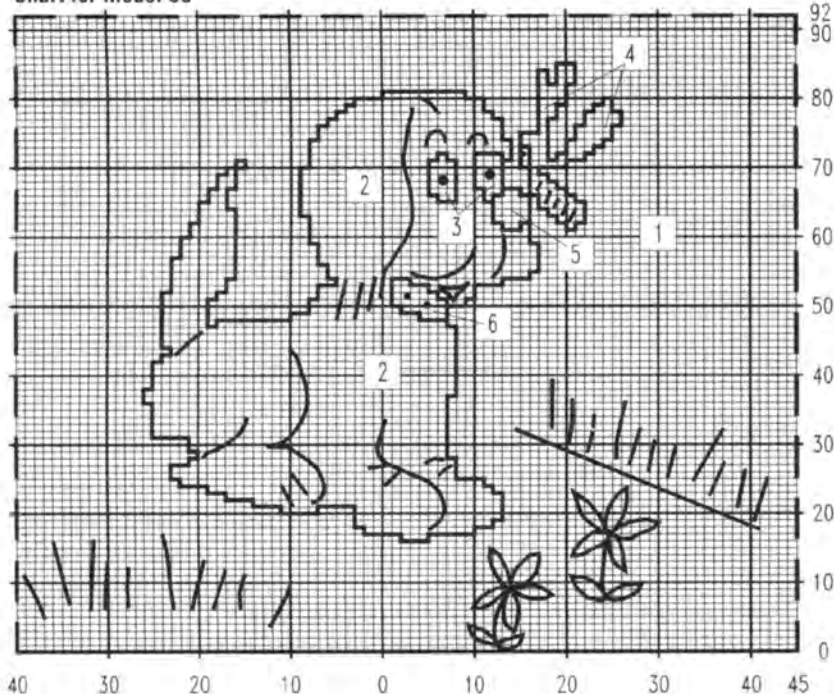

Chart for model 30



Key:

- 1 = turquoise
- 2 = yellow
- 3 = white
- 4 = brown
- 5 = black
- 6 = red

Embroider around the dog in black stemstitch as in photo. Embroider the bee in yellow satin stitch. Make lazy-daisy stitches for the flowers in red and green. Make single stitches in green for the grass. 1 square = 1 R and 1 st.

quoise. Move sts to standard gauge machine or put on knitting needles to knit moss stitch. Knit 6 rows in pattern and shape neck. Push the 10 sts in centre and all sts at side opposite to carriage to NWP on nylon cord. At neck edge push to NWP on alt. rows 5 sts once, 4 sts once, 3 sts once and 1 st twice. After row 18 of moss stitch cast off rem. 23 sts. Repeat for other side. Knit neck band as on back.

Sleeves: With garter carriage cast on 42 sts in turquoise and knit 20 rows rib.

Increase to 50 sts and set RC 000. Continue in moss stitch, increasing 1 st at each side on every 6th row 13 times = 76 sts. Cast off at RC 84. **Welts:** Pick up sts from waste yarn at lower edge of front or back. Hang on needles of standard gauge machine, decreasing evenly to 76 sts. Knit 20 rows rib in turquoise and cast off. **Finishing:** Embroider the front. Close shoulder and neck band seams. Set in sleeves between markers. Close rem. seams.

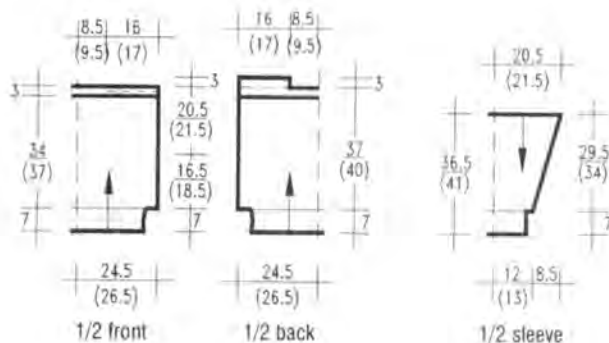

MODEL 31

MODEL 31

SWEATER

WITH HEDGEHOG

Size: 134(146)cm. The instructions for the larger size are in brackets. One figure only applies to both sizes.

Machines: Suitable for standard gauge machines with intarsia carriage and ribber. We used a Brother KH 930.

Material: SCHACHENMAYR PATONS "Sunrise" (100% cotton, 125m/50g) approx. 200(250)g red, 100g each grey, turquoise and dk. blue. Tasselyarn "Laisa" (52% acetate, 30% metalised polyester, 18% polyamid, 65m/25g) approx. 25g grey, 4 buttons.

Tension: Front and back: 25 sts and 35 R = 10cm. Sleeves: 26 sts and 34 rows = 10cm. TD approx. 10**.

Ribs: 2/2 rib at TD approx. 7. **Fairisle pattern:** Punch a card repeating the design 3 times across the card or mark mylar sheet. After knitting 8 rows of pattern, knit 4 rows st st, selecting needles for next fairisle pattern on last row.

Colour sequence: With red in feeder 1, change colours in feeder 2 as follows: Rows 1-4 turquoise. Rows 5-8 dk. blue. Repeat this sequence throughout. For sleeves use grey in feeder 1, and colours in feeder 2 in reverse.

Intarsia: Knitted following the chart. It may be necessary to adjust the TD setting when changing from intarsia to st st.

Arrows on diagrams denote direction of knitting.

Back: In dk. blue cast on 106(116) sts and 24 rows rib. Transfer all sts to MB, increasing evenly to 124(134) sts. * Knit 4 rows red st st. Knit 8 rows fairisle *. Repeat from * to *. Continue in red st st to RC 58(66) and mark both edges for armhole. Knit to RC 118(130). Change to turquoise and knit 1 row. Arrange needles for rib and knit at TD 8* 10 rows. Cast off sts 41-124(43-134) at left. On rem. sts knit 10 rows for button band and cast off.

Front: Cast on and knit as for back to RC 28(34). Start intarsia, continuing in st st after knitting the hedgehog. At RC 118(130), change to turquoise and knit 1 row. Arrange needles for rib and knit 5 rows. Counting from left edge, make 4 buttonholes at even distances in first 40 sts. Knit 5 rows and cast off.

Sleeves: Close right shoulder seam. Sew on buttons and fasten them. Pick

up 108(114) sts between markers and hang on needles. Knit in fairisle pattern as given for sleeve, decreasing 1 st at each end on every 4th row 12 times and every 5th row 10 times (on every 5th row 22 times) = 64(70) sts. At RC 100(116), reduce sts to 50(54) and knit 1 R red. Arrange needles for rib and knit 24 rows. Cast off. **Finishing:** Embroider the front. Close remaining seams.

Fairisle pattern

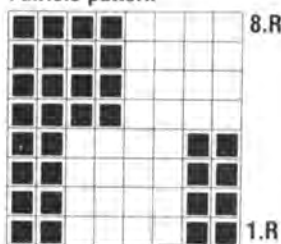

REPEAT = 8 ST

Key to chart:

- 1 = red
 - 2 = turquoise
 - 3 = grey
 - 4 = dk. blue
 - 5 = tassel yarn
- The patch is embroidered in red. Outline mouth, glasses, braces and trousers in black stemstitch. Belt in turquoise stemstitch. Nose and dots in black
 1 square = 1 R and 1 st.

Chart

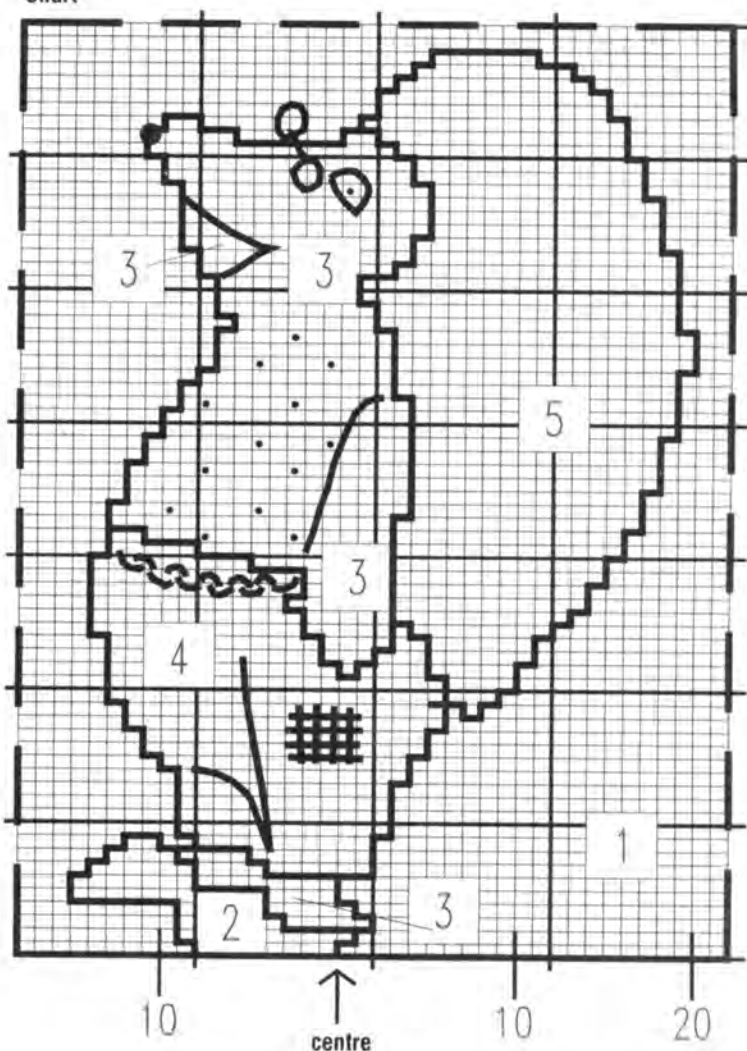

MODEL 32

BALLOON SWEATER

Size: 140/146cm

Machines: Knitted on Singer Double bed Standard Gauge machine with intarsia carriage.

Material: SCHACHENMAYR "Cherie" (100% cotton, 115m/50g) approx. 250g white, 150g lt. blue and 50g blue. Small amounts in red, yellow, turquoise, pink and black.

Tension: 24-25 sts and 30 R = 10cm. TD approx. 10**

Ribs: 1/1 rib at TD approx. 4**

Intarsia: Knitted from the chart at TD 10**. The balloons are swiss-darned after knitting. The strings are embroidered in stemstitch.

Arrows on diagrams denote direction

of knitting.

Back: Cast on 106 sts in 1/1 rib and knit 20 rows. Transfer all sts to MB. Set RC 000 and knit, following chart 1. At RC 51, mark both edges for armholes. At RC 114, knit back neckline with needles in HP, using the chart to read the number of needles. At RC 120, cast off rem. 29 sts for the shoulders. Return the 48 needles from HP to WP and transfer for rib. Knit 24 rows for the neckband and cast off loosely.

Front: Cast on and knit as for back, but use the shapings for the lower neckline. Knit neckband as on back.

Sleeves: Close shoulder and neckband seams. Fold neckband in half to inside and slipstitch in position. With purl side facing, pick up 116 sts along one side edge between markers. Knit from chart 2, reversing the pattern for the left side. Decrease as shown on chart. At RC 92, reduce sts to 48. Knit 1 row. Transfer sts for rib and knit 20 rows. Cast off.

Finishing: Embroider balloons on front only. Close side and sleeve seams.

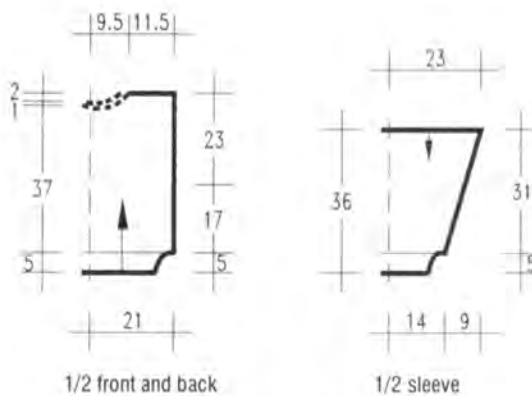

cont. next page

Chart 1 (front and back)

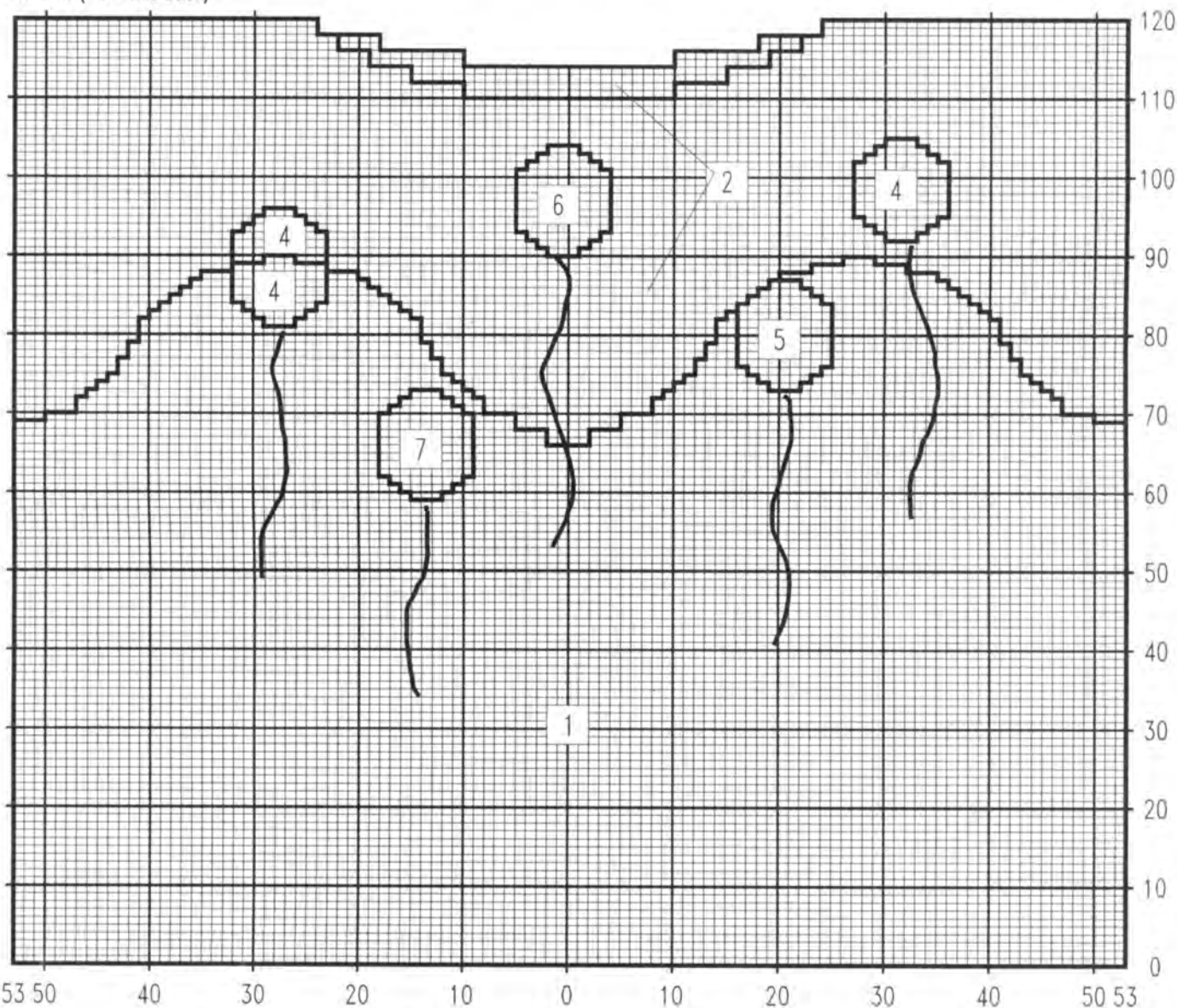

Key: 1 = white, 2 = blue, 3 = lt. blue, 4 = yellow, 5 = rose, 6 = red, 7 = turquoise. 1 square = 1 R and 1 st.

Chart 2 (1/2 sleeve) for model 32

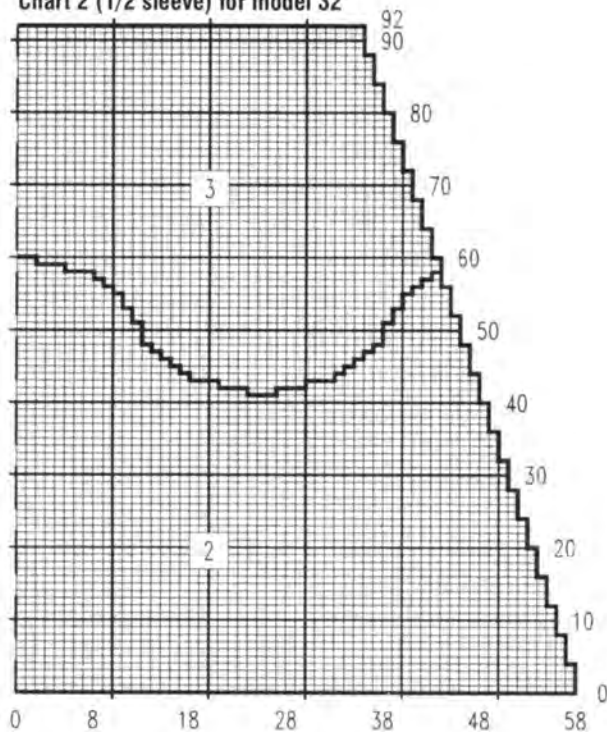

Key: 3 = lt. blue
2 = blue
1 square = 1 R and 1 st.

MODEL 33

PETROL SWEATER WITH TEDDY

Size: 140/146cm
Machines: Knitted on Singer Double bed Standard Gauge Machine with intarsia carriage.
Material: SCHACHENMAYR "Cherie" (100% cotton, 115m/50g) approx. 550g petrol blue, 50g beige. Small amounts in yellow and black.
Tension: 24-25 sts and 30 R = 10cm.

TD approx. 10**
Ribs: 2/2 rib at TD 5**
Intarsia: Knitted from the chart. Use separate balls of yarn for each colour and cross threads when changing colour. Small areas may be swiss-darned. The black outlines are embroidered in stemstitch.
Arrows on diagrams denote direction of knitting.
Back: Cast on in petrol blue 110 sts and knit 20 rows rib. Transfer all sts to MB and set RC 000. Continue in petrol blue st st. At **RC 75**, mark both edges for armholes. At **RC 138**, shape neckline. Push to HP the centre 20 sts and all sts at side opposite to carriage. Knit each side separately. At neck edge push to HP on alt. rows 8 sts once and 6 sts once. Cast off rem. 31 sts at **RC 144**. Knit other side to match. Return

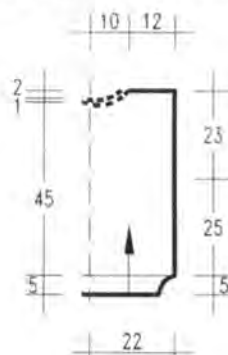

1/2 front and back

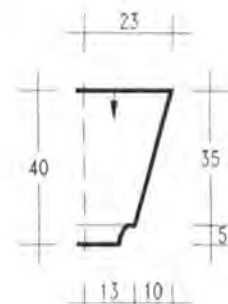

1/2 sleeve

Chart

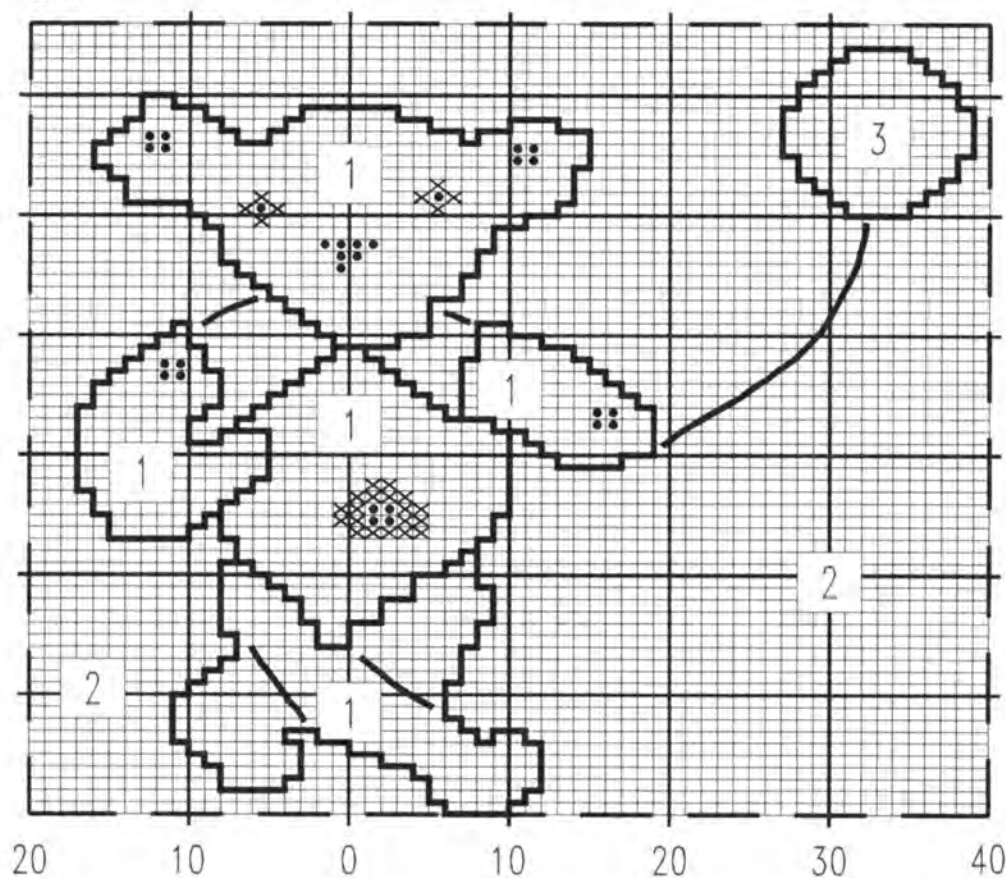

the 48 sts from HP to WP. Arrange for rib and knit 18 rows for the neckband. Cast off loosely.

Front: Cast on and knit rib as on back. Transfer all sts to MB. set RC 000. Knit 40 rows petrol, 3 rows beige and 8 rows petrol. Knit 66 rows in intarsia. Knit 11 rows petrol. * Knit 2 rows petrol and 2 rows beige. Repeat from * 3 times = 144 rows. At the same time, when **RC 75**, mark both sides for armholes. At **RC 134**, shape neck. Push to HP centre 20 sts and all sts at side opposite to carriage. Knit each side separately. At neck edge push to HP on alt. rows 5 sts once, 4 sts once, 3 sts once and 2 sts once. Knit on rem. sts to **RC 144** and cast off. Knit neckband as described for back.

Sleeves: Close shoulder and neckband seams. With purl side facing, pick up 114 sts from side edge between markers. Set RC 000 and knit with petrol blue in st st. Decrease 1 st at each side on every 4th row 25 times = 64 sts. At **RC 104**, reduce sts to 48. Arrange needles for rib and knit 20 rows. Cast off.

Finishing: Embroider the front. Close side and sleeve seams.

Key:
 1 = beige
 2 = petrol
 3 = yellow
 x = petrol swiss-darned
 ● = black swiss-darned
 1 square = 1 R and 1 st.

When substituting yarns, use yarns of similar length!

SNOWFLAKES

Model 17, Size 158/164cm



We tell a Winter's Tale and add a snowman to prove it. A landscape painted in knitting appeals to romantic girls.

HAPPY QUINTETT

Model 18, Size 140/146cm

This is my snowman with a red nose and a yellow broom. The scarf is mine, but that doesn't matter, because we are inseparable till spring.

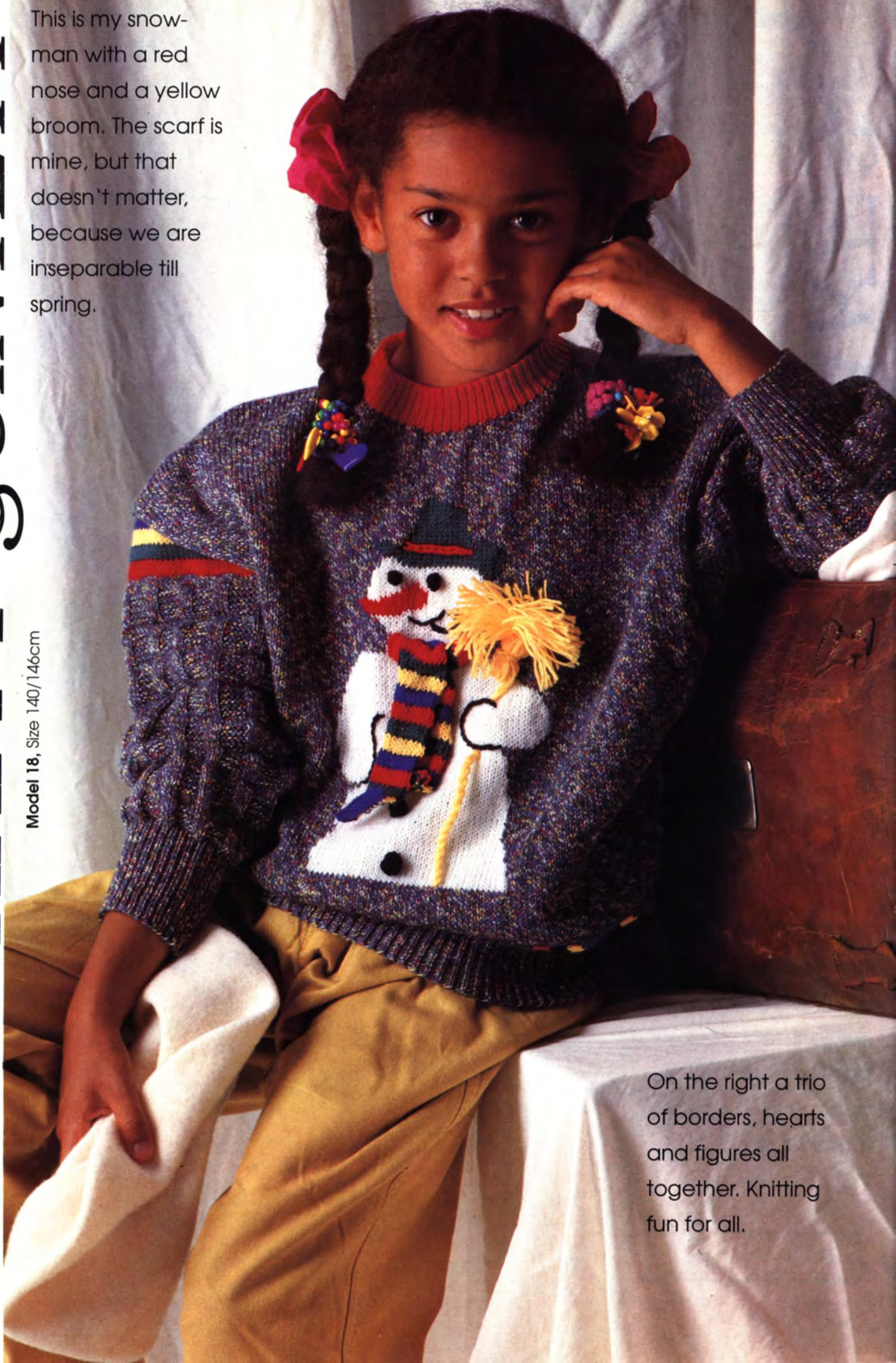

On the right a trio of borders, hearts and figures all together. Knitting fun for all.



Model 19, Size 140/146cm



Model 20, Size 140/146cm

HIGH-SPIRITED MICE AND BEARS



Model 21, Size 116/122 (128/134)cm



Stories and fairy tales - knitted to last longer than one season. Tell the truth, have you ever seen a pink mouse playing the guitar? Or a white mouse on a tortoise? A bear on roller skates is almost normal. Lots of witty ideas!

Model 22, Size 122/128 (134/140)cm

SMALL PEOPLE - LARGE PEOPLE

Model 23, Size 146/152cm

Just look, this is me as a baby. These days I take pictures myself. My mother knows what I like, she has knitted this for me.



Model 24, Size 134/140cm

I always wanted to fly away in a colourful balloon with bobbles. Simple, my birthday is soon.



STITCHES WITH

Three sweaters all different. Garter stitch in fresh turquoise can be worn with many outfits. An oasis and lots of sand not only for bedouins, but also for teenagers. And in my job clothes are important, else I get the cold shoulder.



Model 25, Size 146/152 (158/164)cm

Model 26, Size 164 - 170cm

STYLE



Model 27, Size 146/152 (158/164)cm

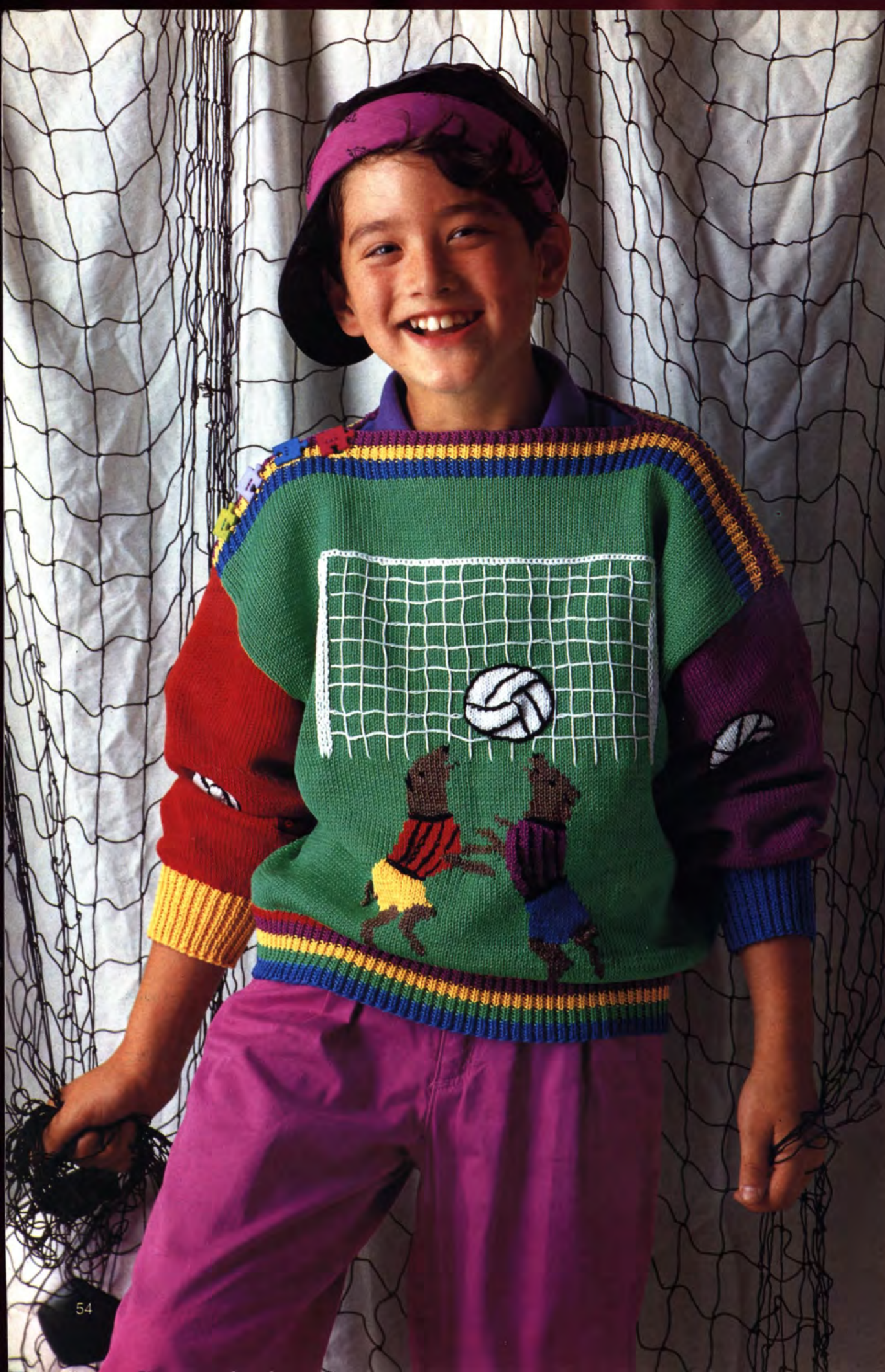

Model 28, Size 146/152cm

SPORTS PEOPLE IN ACTION

Football sweater
with a real net and
large balls. This
future football star
is sure his team will
go to the top, if it
weren't for all that
home work. And I
will of course cycle
to the Final!



CHEERFUL COMPANIONS

Everything that crawls or flies attracts the youngsters. They know what they like. Whether a dog with a bee or a hedgehog with silver prickles, both boys and girls will love them. Why not knit your child's best friend on a sweater, you will be very popular.

Model 30, Size 116/122cm





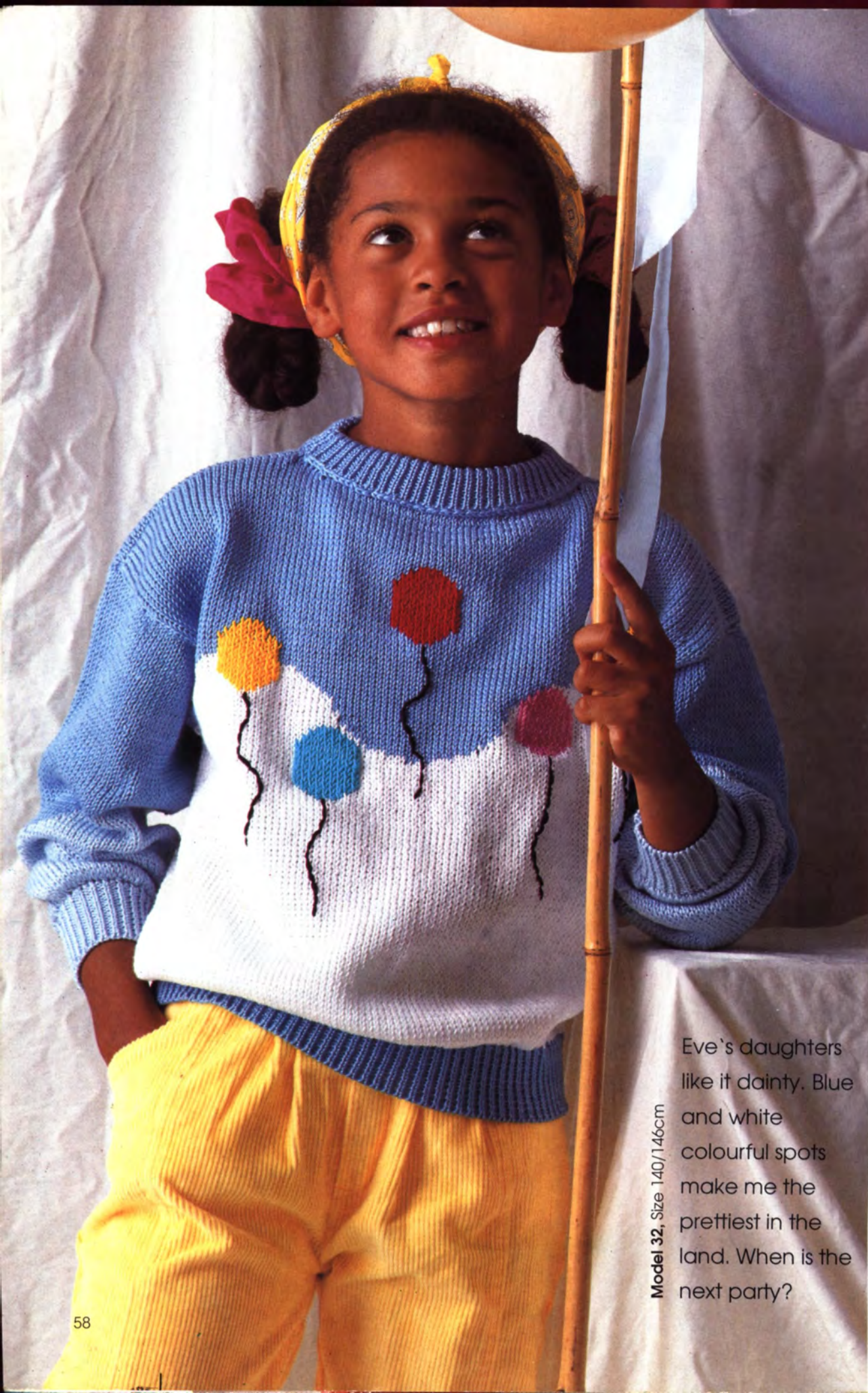

COLOURFUL BALLOONS

Eve's daughters like it dainty. Blue and white colourful spots make me the prettiest in the land. When is the next party?

Model 32, Size 140/146cm

Knitted in or embroidered, stripes, motifs or balloons, the variations in colour are endless. You can have lots of fun!

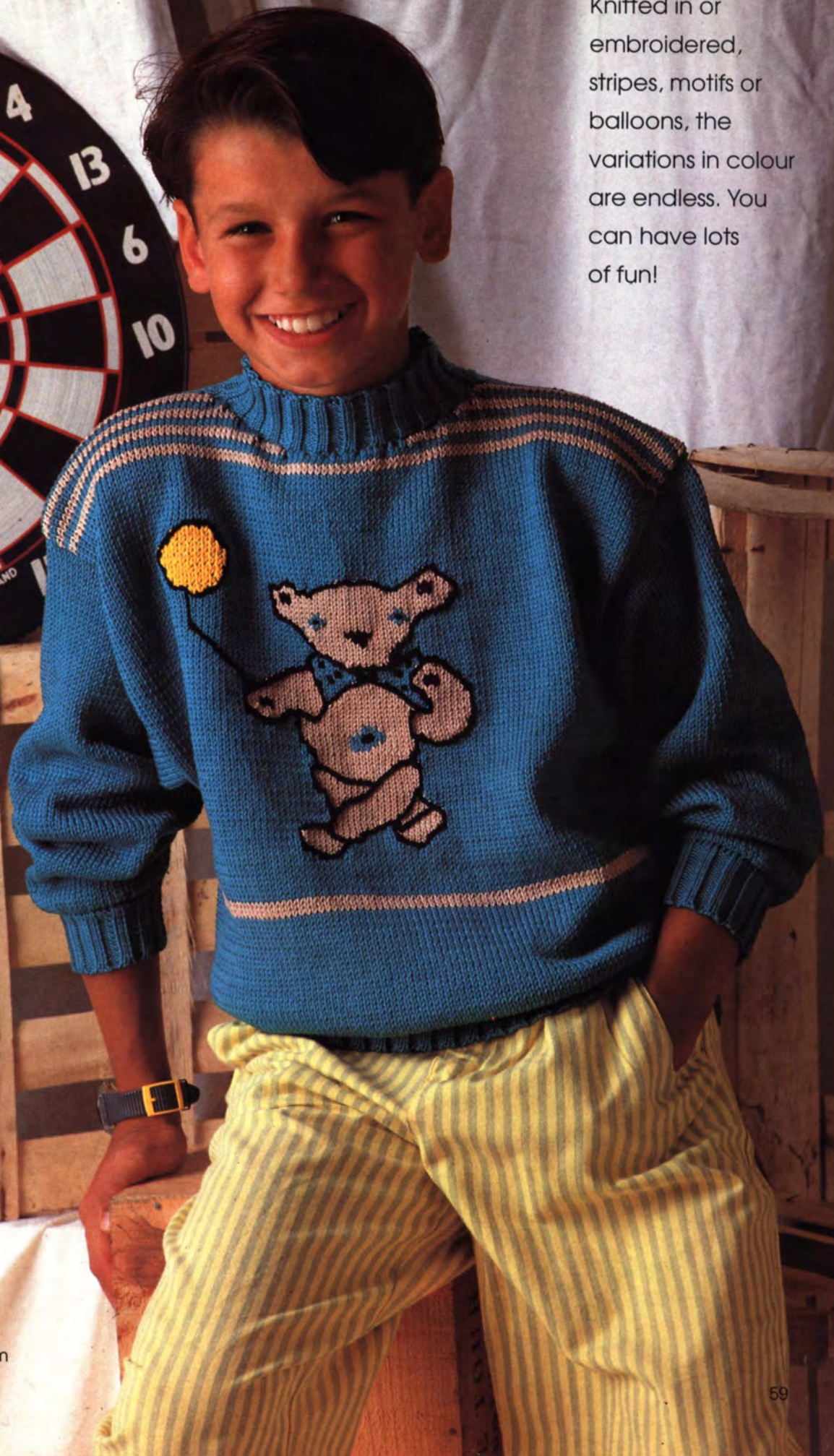

Model 33, Size 140/146cm

On sale at all
newsagents!

Elegant Knitting No. 10 · £1.70

VERY SPECIAL SWEATERS AND JACKETS

DREAMY WHITE SWEATERS
with gold, silver and special effects

Simple Instructions
Readers Helpline

ISSN 1016-1341

9 771016 134010

Is published bi-monthly · £1.70

HEALTHY COOKING No. 13 · 95 p

New Wholefood Cooking

WHOLEGRAIN PASTA

Only 95p

ISSN 1015-793X

9 771015 793007

New spaghetti ideas · Home-made cheese spaetzles · Quick and easy pasta squares
Sauces and dips · Quick pasta recipes
Fresh lasagne

Microwave spaghetti ring

95 p

Sabrina CREATIVE No. 14 · 95 p

The prettiest Doilies

EXQUISITE OPENWORK

Only 95p

MORE NEW IDEAS FOR EXPERTS AND BEGINNERS ALIKE

ISSN 1015-7972

9 771015 797001

The knitting and crochet magazine with a difference for you TO COLLECT

Is published monthly · 95 p