

MODEL

# KH 341

INSTRUCTION MANUAL

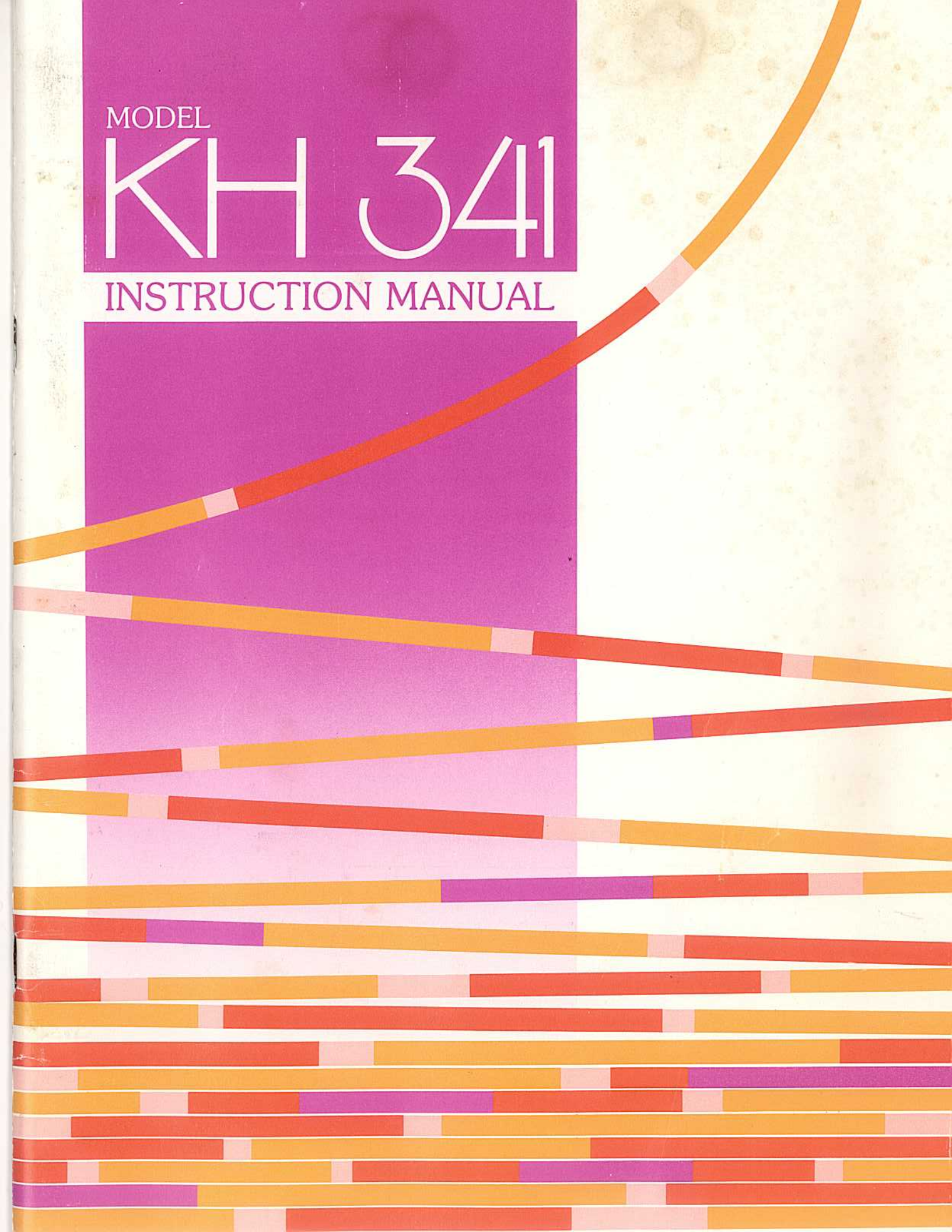



# INDEX

1	HOW TO USE YOUR KNITTING MACHINE	
1	Setting up your machine .....	1
2	Folding up your machine .....	3
2	BEFORE STARTING TO KNIT	
1	Needle position .....	7
2	How to use the tension dial .....	7
3	How to use the row counter .....	7
3	BASIC OPERATION PRACTICE	
1	Plain knitting .....	9
2	Intarsia knitting .....	13
3	Striped pattern .....	19
4	Skip stitch pattern .....	21
5	Pull-up stitch pattern .....	23
6	Skip stitch pattern in two colour .....	27
7	Pull-up stitch pattern in two colour .....	30
4	HOW TO TAKE A TENSION GAUGE	
1	Tension gauge .....	33
2	How to knit a tension swatch .....	33
3	How to measure the tension swatch .....	39
5	HOW TO USE THE KNIT-LEADER	
1	How to set the gauge dial .....	41
2	How to set the stitch measure scale .....	41
3	How to trace the pattern .....	42
4	How to set the sheet .....	44
5	How to read the stitch measure scale .....	45
6	MAKING GARMENTS	
1	How to use the transfer tool and the latch tool .....	47
2	Increasing and decreasing stitches .....	49
3	Picking up dropped stitches .....	52
4	How to make a hem .....	54
5	Binding off .....	58
6	How to make a button hole .....	62
7	How to shape a round neck line .....	63
8	Sewing procedure .....	64
9	Partial knitting .....	66
7	USEFUL HINTS	
1	If the carriage should jam up .....	69
2	In case of moving the carriage without yarn .....	70
3	Replacing the needles .....	70
4	Cleaning and maintenance .....	71



# PARTS NAME

## MACHINE BODY

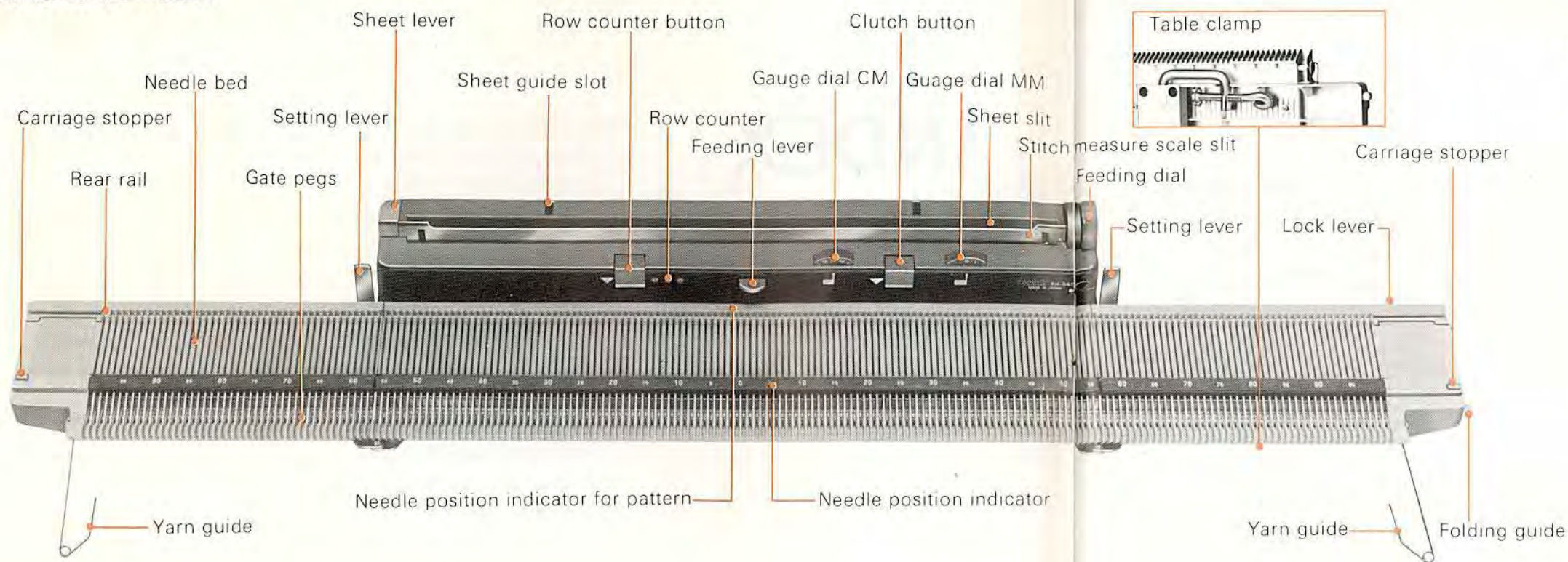

## CARRIAGE



## ACCESSORIES

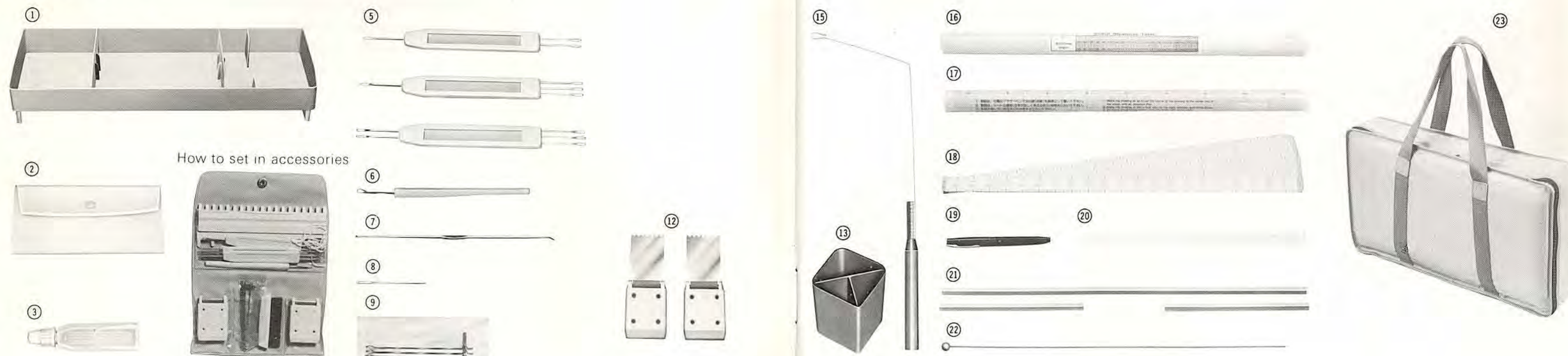

- |                                                    |                     |                        |
|----------------------------------------------------|---------------------|------------------------|
| ① Storage case                                     | ⑧ Tapestry needle   | ⑰ Sheet                |
| ② Accessories bag                                  | ⑨ Spare needles     | ⑱ Stitch measure scale |
| ③ Oil                                              | ⑩ Cast-on thread    | ⑲ Felt pen             |
| ④ 0 x 1/1 Needle pusher<br>2/2 x 1/3 Needle pusher | ⑪ Hand brush        | ⑳ Ruler                |
| ⑤ Transfer tool<br>(1 x 2, 1 x 3 and 2 x 3)        | ⑫ Claw weights      | ㉑ Gate pegs' covers    |
|                                                    | ⑬ Accessories stand | ㉒ Binding wire         |
|                                                    | ⑭ Sheet guide       | ㉓ Carrying bag         |



# HOW TO USE YOUR KNITTING MACHINE

## 1 Setting up your machine

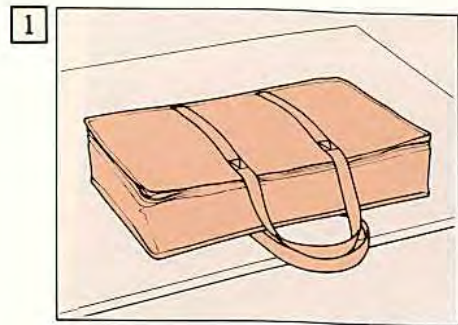

1 Place the carrying bag on a table as shown in the figure.

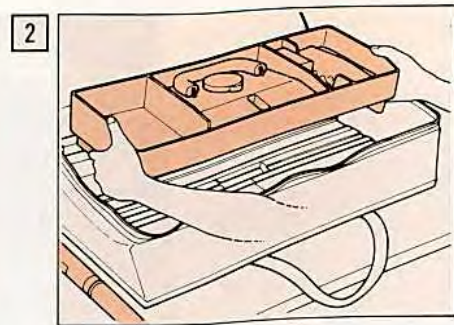

2 Open the carrying bag. Take out the storage case and the sheet case.

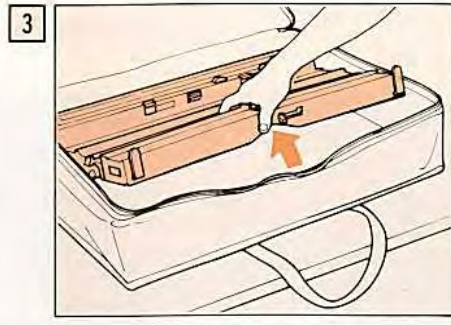

3 Take out the machine from the carrying bag and place it on a table.

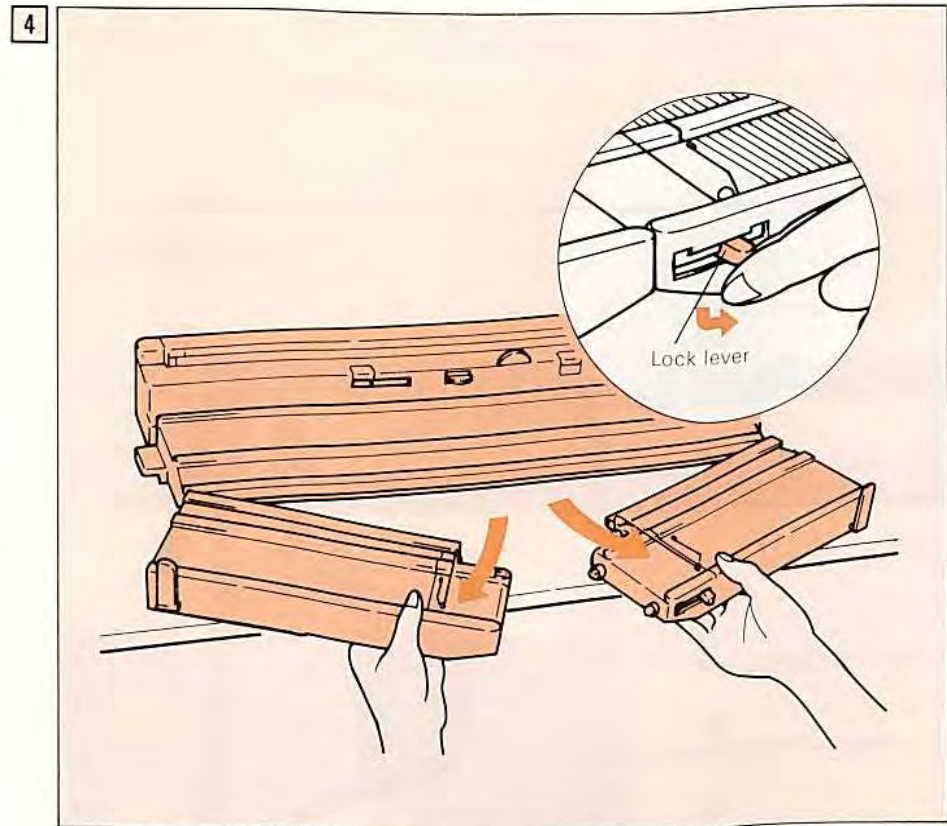

4 Push down the lock lever and slide it to the right. Open the machine as shown in the figure.



5 Connect the both sides to the center body closely and pull out the setting levers.

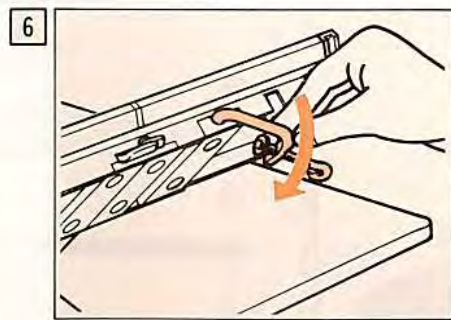

6 Lift the front side of the machine. Make the table clamps stand. (Table clamps are beneath of the machine.)

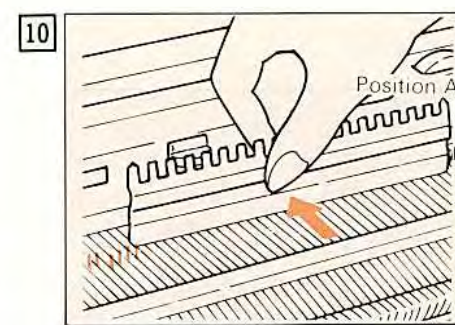
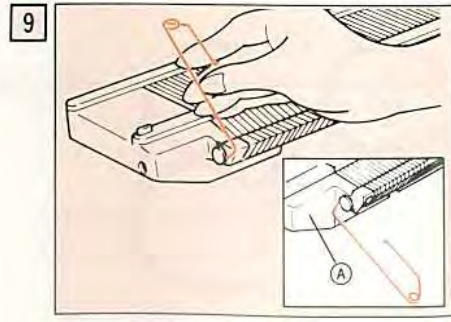
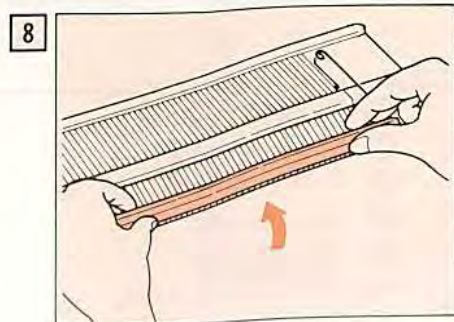
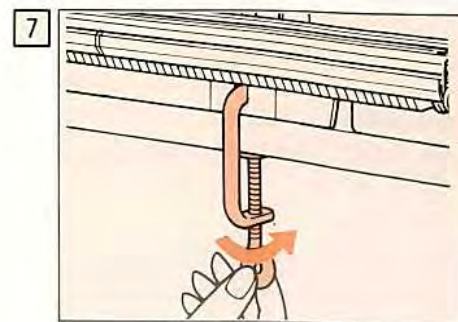

10 Arrange all the needles at position A by using needle pusher.

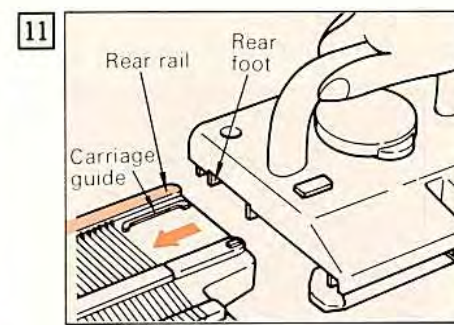

11 Remove the carriage from the storage case. Pull the handle toward you. Set the rear foot of carriage between the rear rail and carriage guide and slide it into the machine. Make sure that the front foot of carriage is set inside of the front rail.

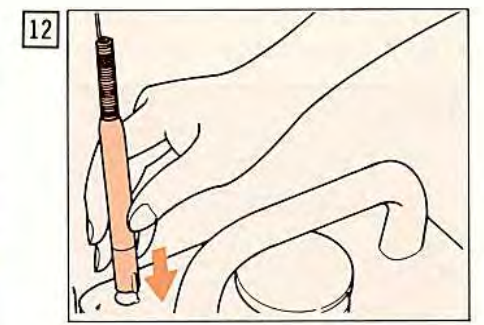

12 Insert the tension spring into the left stand hole of the carriage. (Insert it into the right stand hole, if you prefer the right hole to use it.)

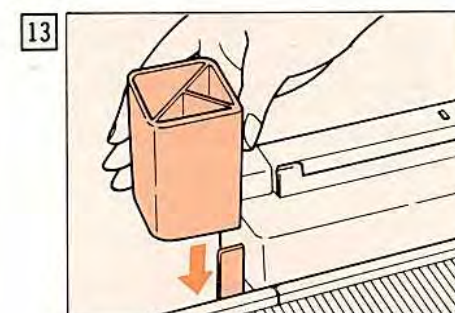

13 Insert the accessories stand to the setting lever. (You can use both setting levers.)

After setting up your machine.

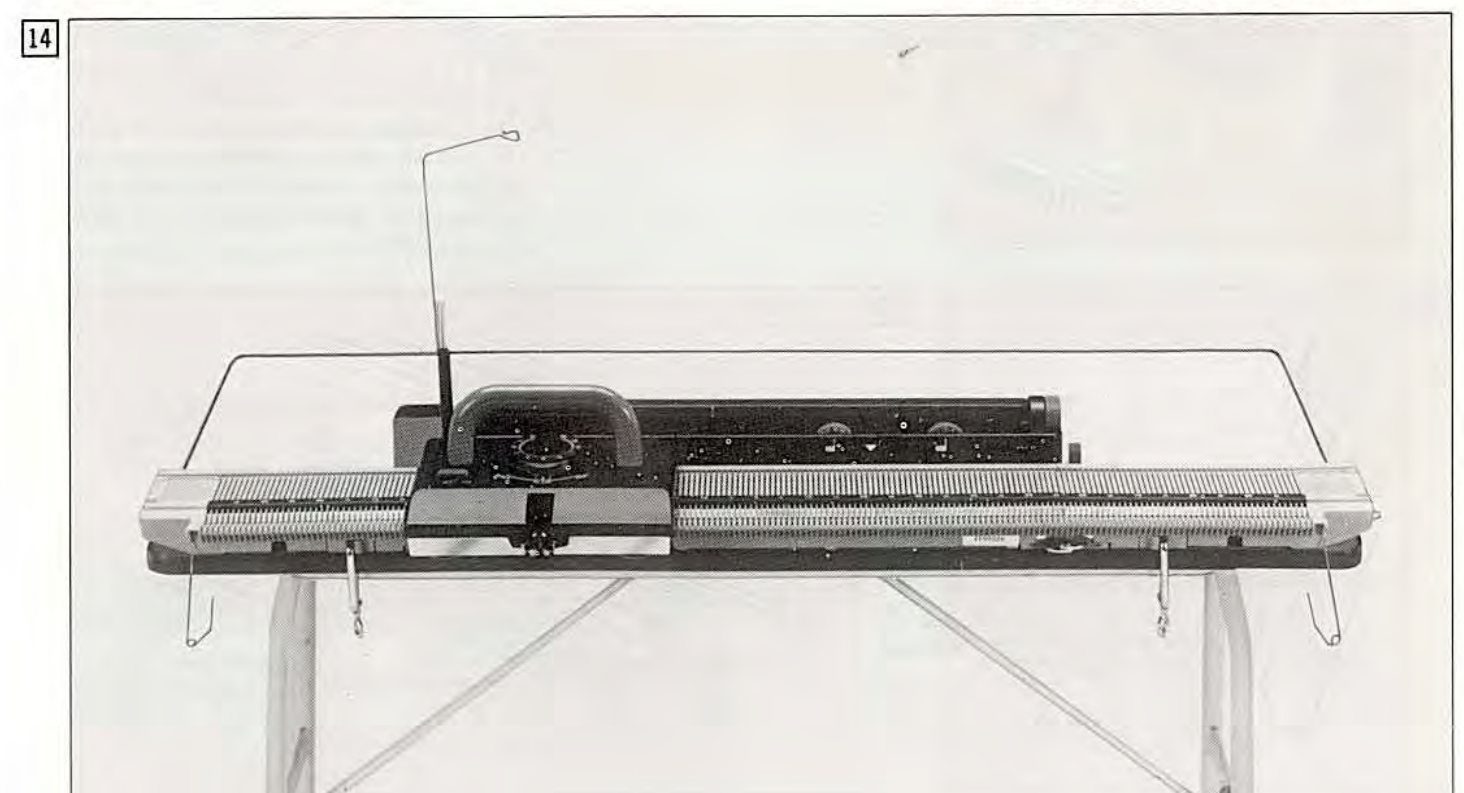



## 2 Folding up your machine

- You can replace this machine with a knitting swatch so that it is very convenient to start knitting again.
- Put the machine in the carrying bag when you carry it.
- The \* marked items should be done when a knitting swatch hangs on the machine.

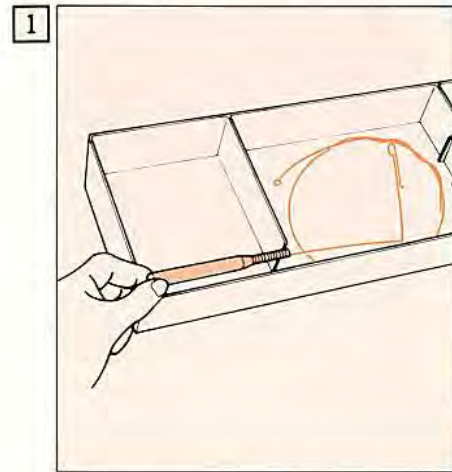

\*Take off the yarn from the carriage without pulling stitches. Replace the binding wire in the storage case. Take off the tension spring and replace it in the storage case.

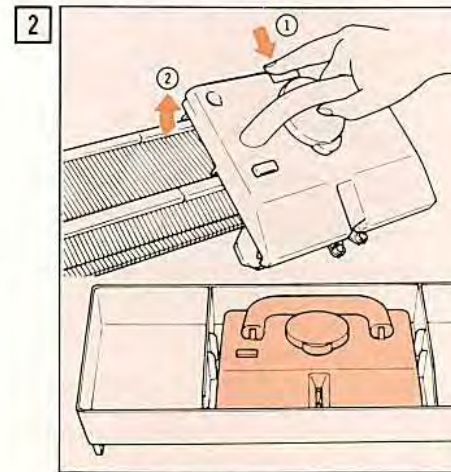

Take off the carriage by pushing the release lever. Fold up the carriage handle and replace it in the storage case.

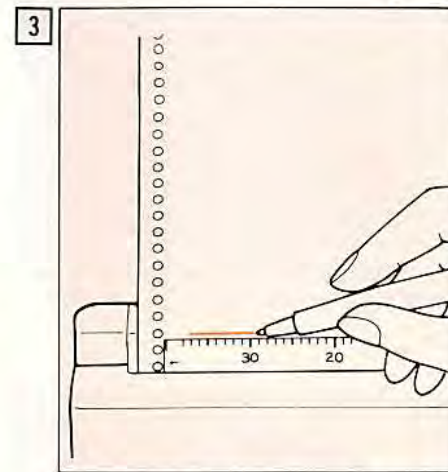

\*Mark on the sheet and write down the count number of the row counter.

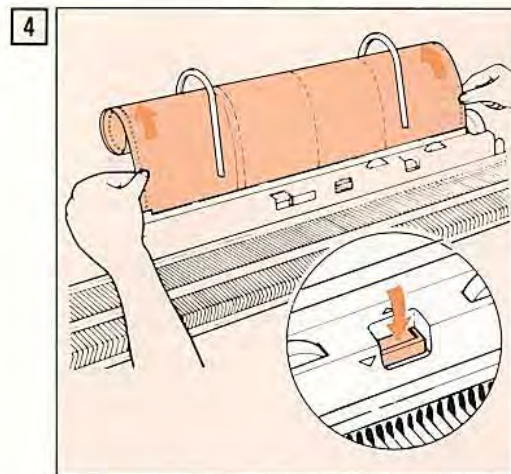

Push down the clutch button and pull out the sheet with holding both sides of it.

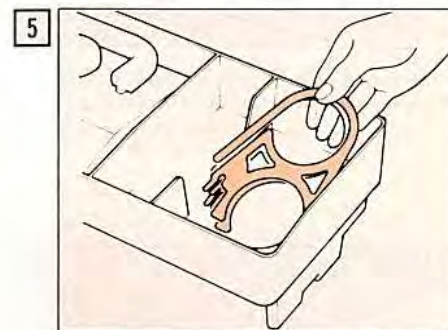

Replace the sheet and the stitch measure scale into the sheet case. Take off the sheet guides and replace them in the storage case.

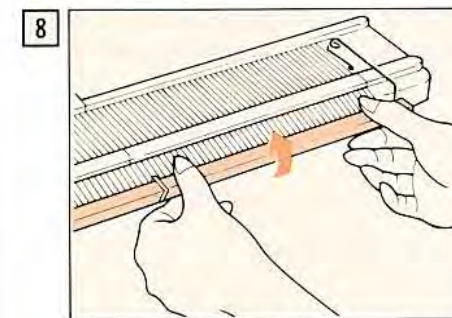
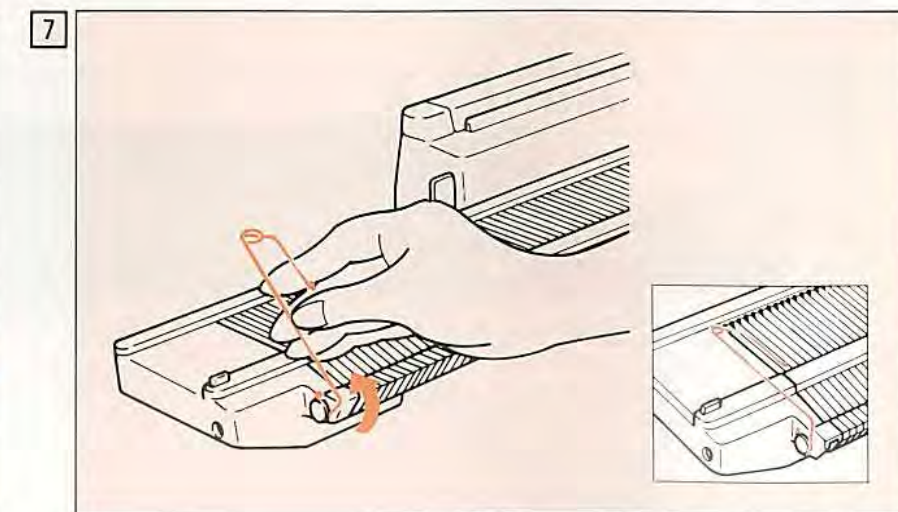
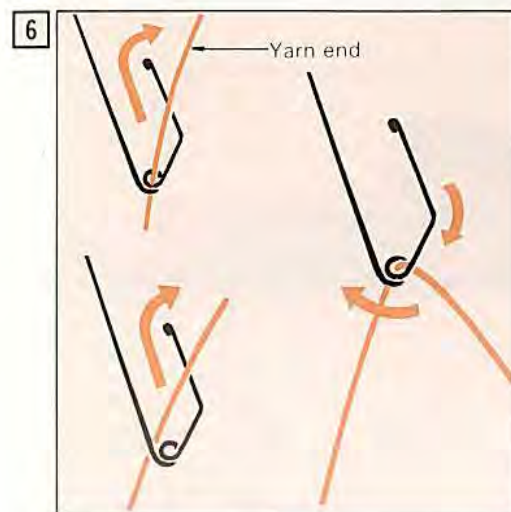

\*Return the needles to position A or B and close the opened latch by hand brush. Whenever you fold up the machine make sure that you put the gate pegs' covers. Push the gate pegs' covers onto the gate pegs as shown in the figure. Replace the accessories in the accessories bag. Take off the accessories stand and push back the both setting levers.



Take off the accessories stand and push back the both setting levers.

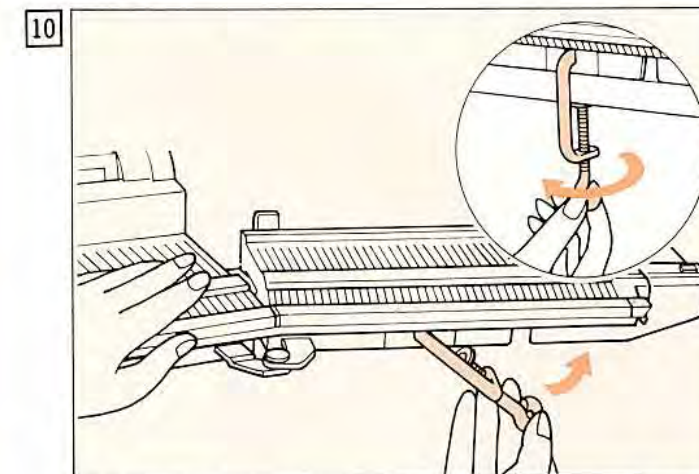

Loosen the knobs of table clamps. Pull the right side of the machine toward you and replace the table clamps. (Do the left side as same as the right side.) Hold down the center body not to fall it down.

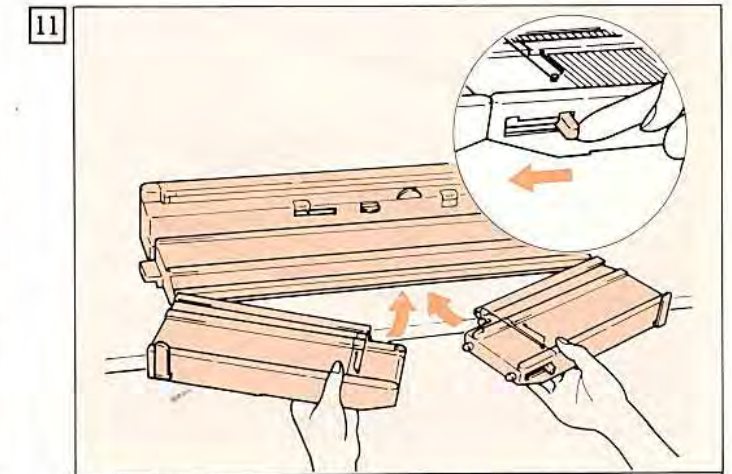

Move the machine backward and fold up the both sides. After setting the folding guide, slide the lock lever to the left.

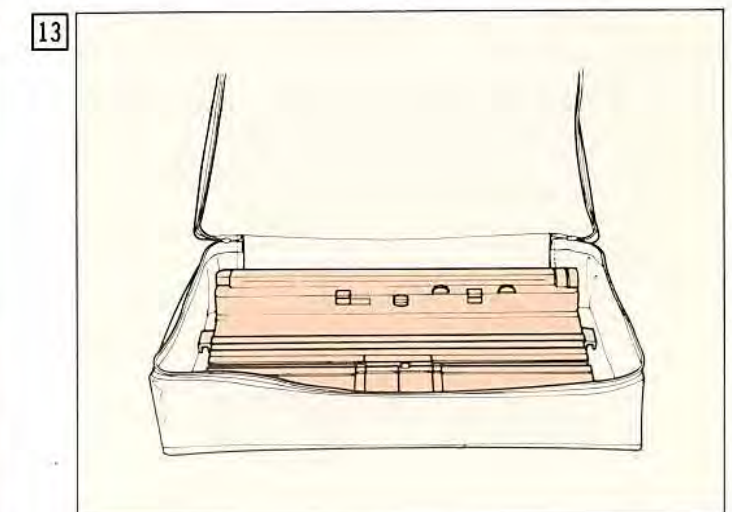
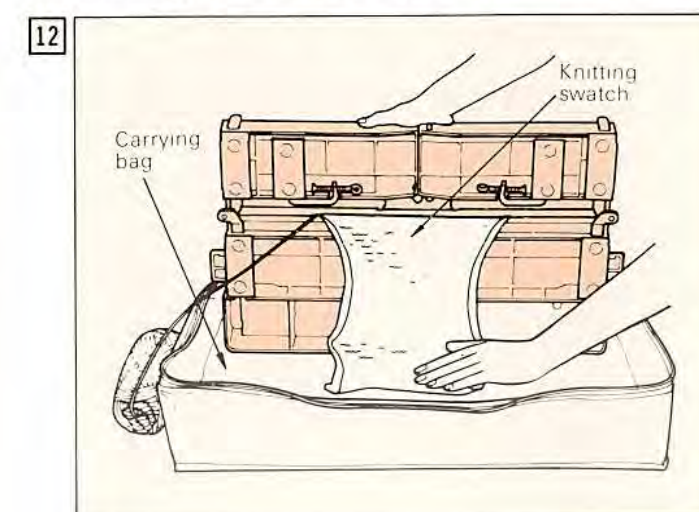



14

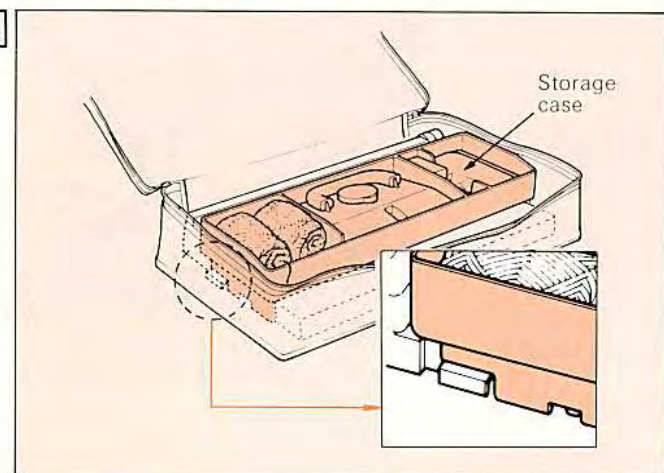

Replace the accessories bag and the accessories stand in the storage case, and put the storage case on the machine.

\* Put the rest yarn in the storage case.

15

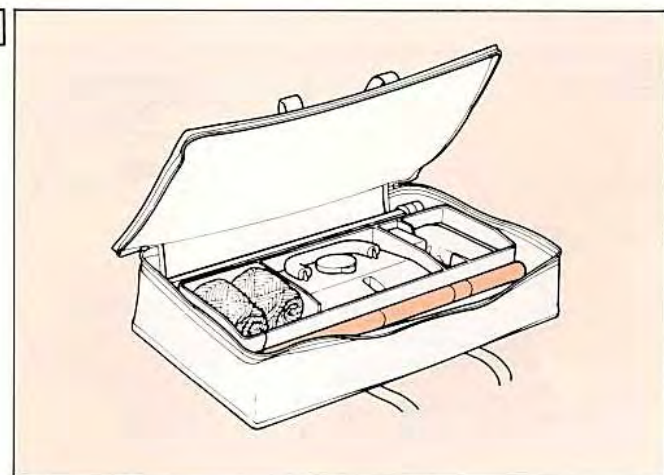

Replace the sheet case and close the carrying bag.

\* Be careful not to jam the knitting swatch and yarn in the zipper.



# BEFORE STARTING TO KNIT

## 1 Needle position

You can enjoy various knitting according to the needle position.  
(On either side of the needle bed there appears the marks A, B, D and E.)

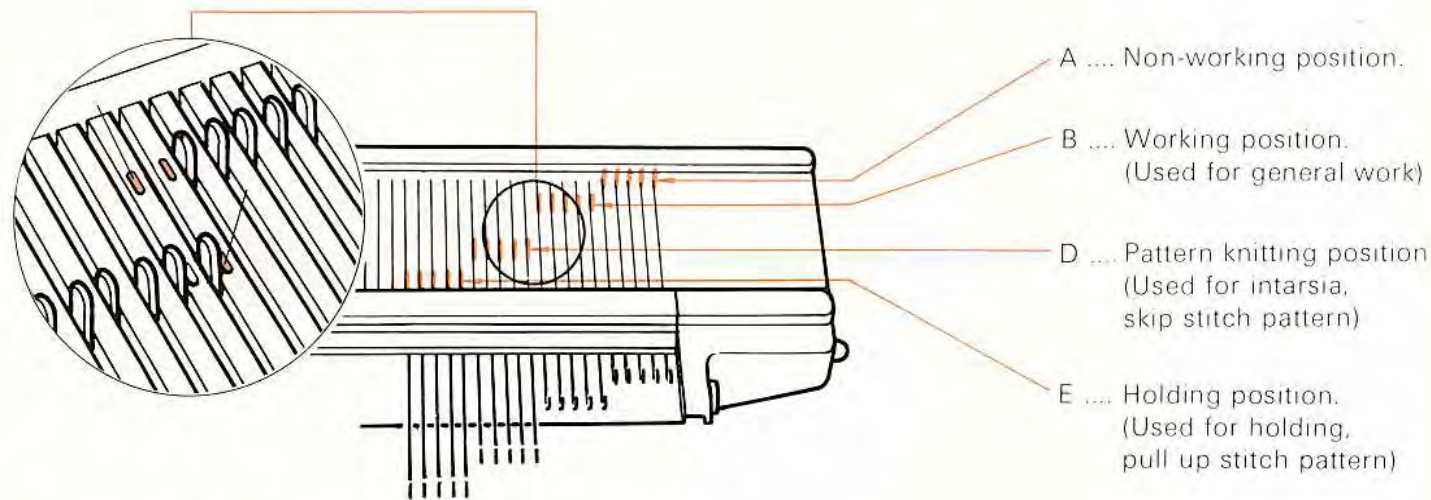

There are marks of position B, D every 10 needles.  
Bring forward the needles at the position mark correctly.

## 2 How to use the tension dial

\* Adjust the tension dial according to the thickness of yarn.  
\* Set the figure or • mark to the | mark.

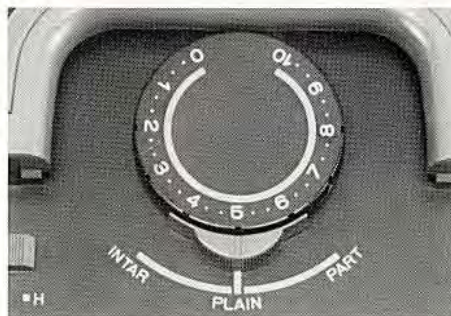

Type of yarn	T.D. number
Very fine yarn	0-3
Fine yarn	3-5
Medium yarn	4-6
Thick yarn	7-10

## 3 How to use the row counter

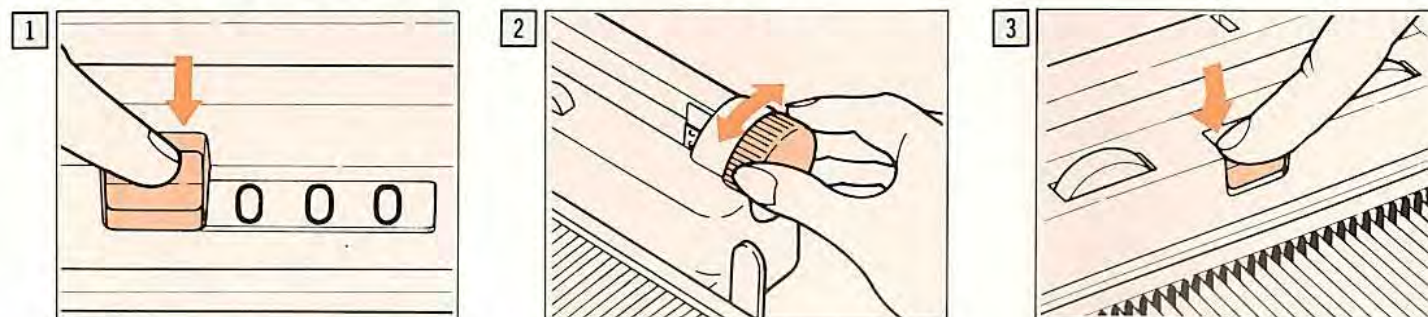

1 Set the figure of row counter to zero (000) by pushing the row counter button.

2 Change the figure of row counter by turning the feeding dial.

3 Set the figure of row counter without feeding the sheet.

1. Push down the clutch button to lock.
2. Set the figure by turning the

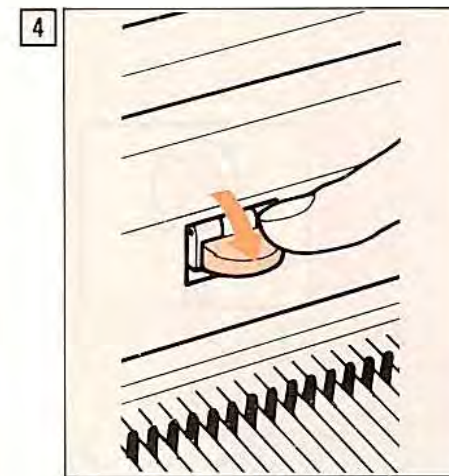

4 When you use the row counter, set the feeding lever.

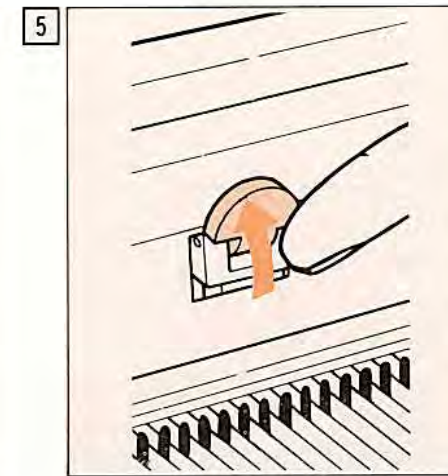

5 When you do not use the row counter, fold up the feeding lever.

*Tension (whatever your garment tension is)  
Set change lever to PLAIN  
Needles  
Position E*



# BEFORE STARTING TO KNIT

## 1 Needle position

You can enjoy various knitting according to the needle position.  
(On either side of the needle bed there appears the marks A, B, D and E.)

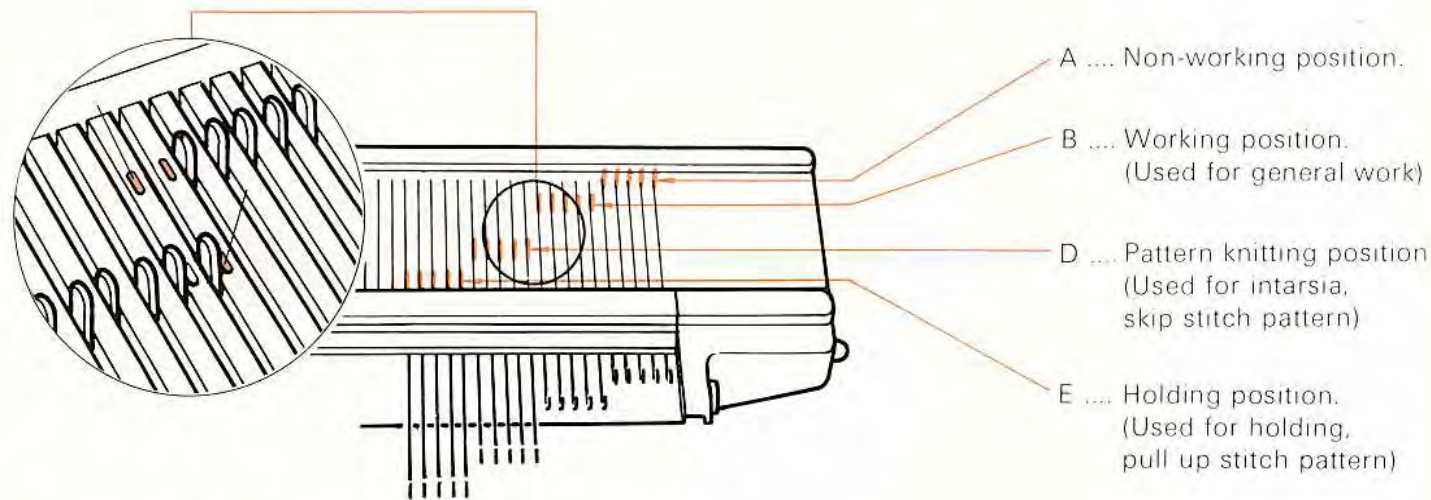

There are marks of position B, D every 10 needles.  
Bring forward the needles at the position mark correctly.

## 2 How to use the tension dial

\* Adjust the tension dial according to the thickness of yarn.  
\* Set the figure or • mark to the | mark.

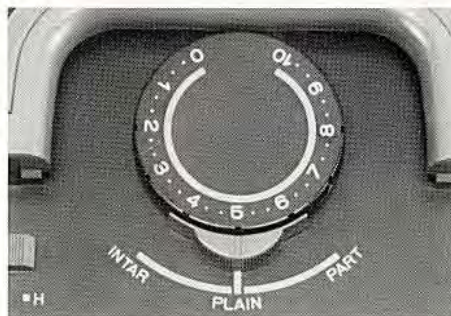

Type of yarn	T.D. number
Very fine yarn	0-3
Fine yarn	3-5
Medium yarn	4-6
Thick yarn	7-10

## 3 How to use the row counter

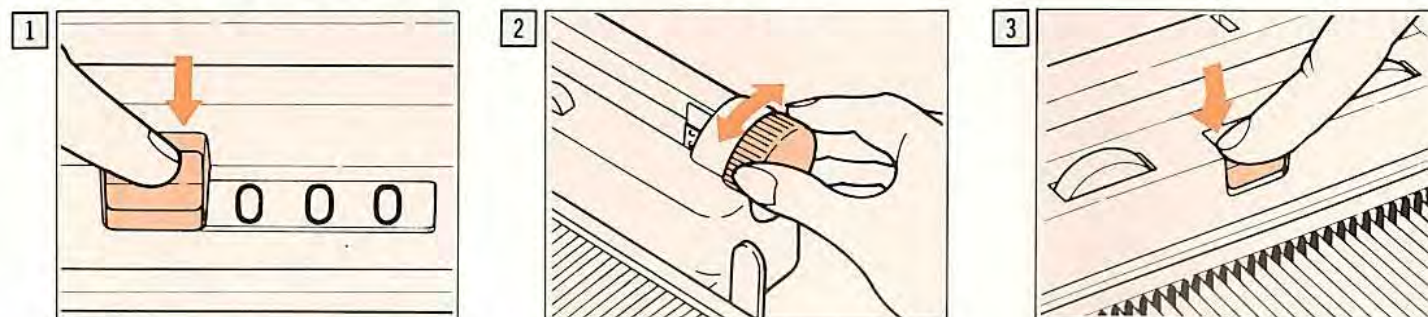

1 Set the figure of row counter to zero (000) by pushing the row counter button.

2 Change the figure of row counter by turning the feeding dial.

3 Set the figure of row counter without feeding the sheet.

1. Push down the clutch button to lock.
2. Set the figure by turning the

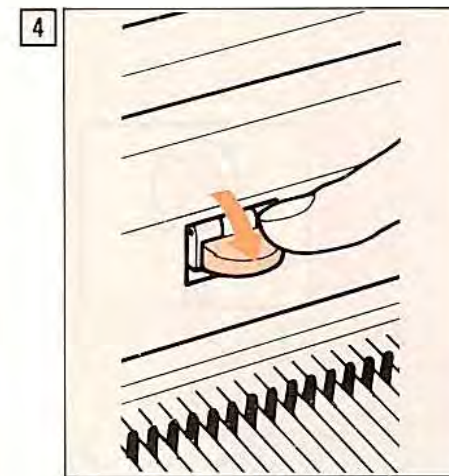

4 When you use the row counter, set the feeding lever.

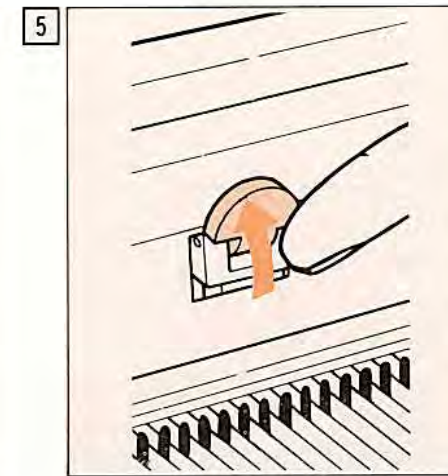

5 When you do not use the row counter, fold up the feeding lever.

*Tension (whatever your garment tension is)  
Set change lever to PLAIN  
Needles  
Position E*



# BASIC OPERATION PRACTICE

## 1 Plain knitting

\* Let's knit with medium thickness yarn.

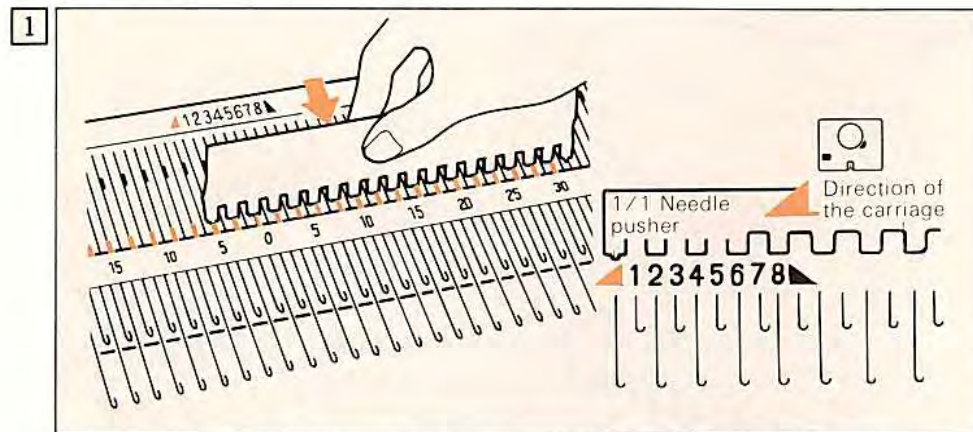

Set the carriage at the right side of the machine. Bring forward every other needle to position E by using 1/1 needle pusher. (30 needles on either side of the center mark "0".)

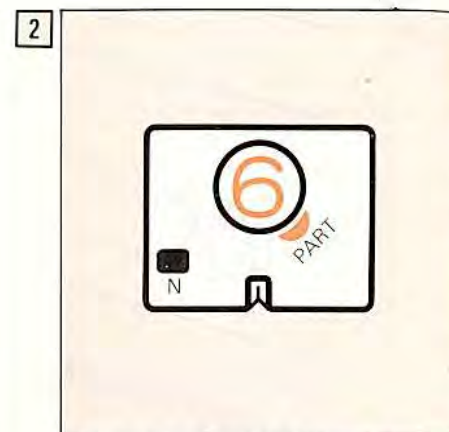

Set the change lever to "PART" and the Tension Dial at 6.

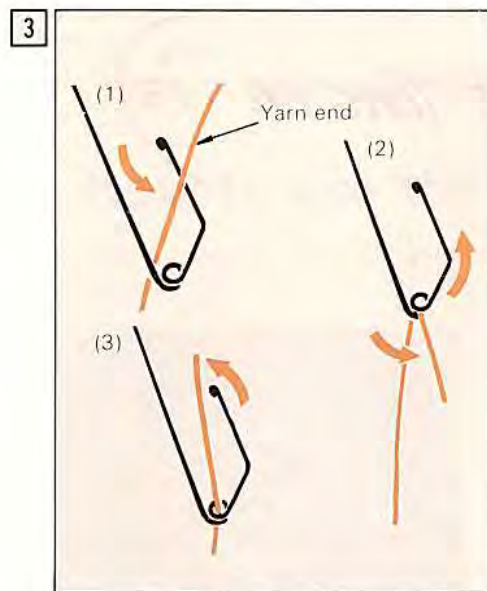

Thread the yarn guide which is at the left side of the machine in the order as shown in the figure. Place the yarn under the yarn guide.

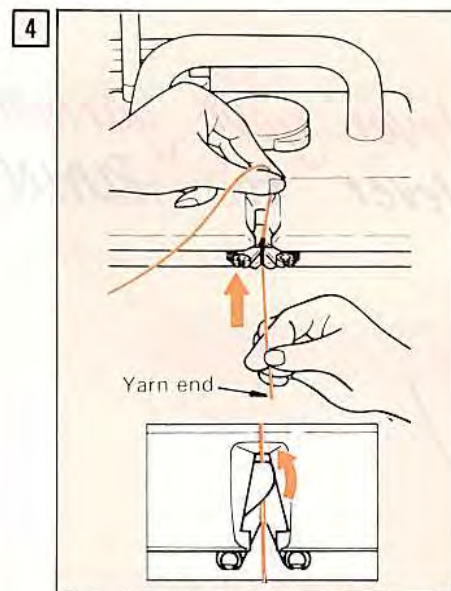

Press the yarn into the yarn feeder.

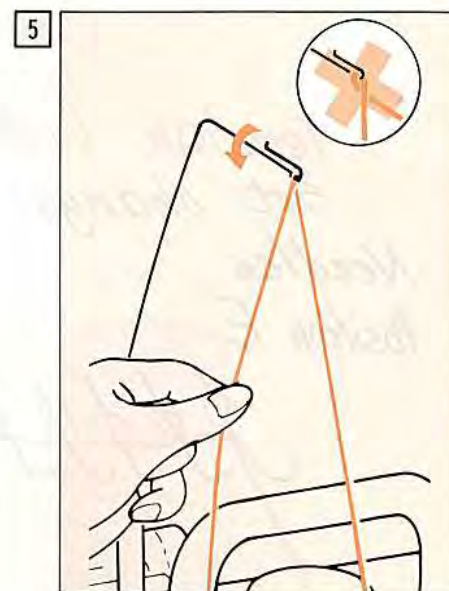

Thread the tension spring.

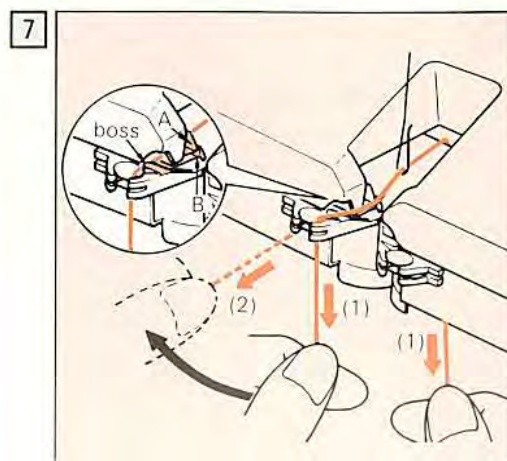
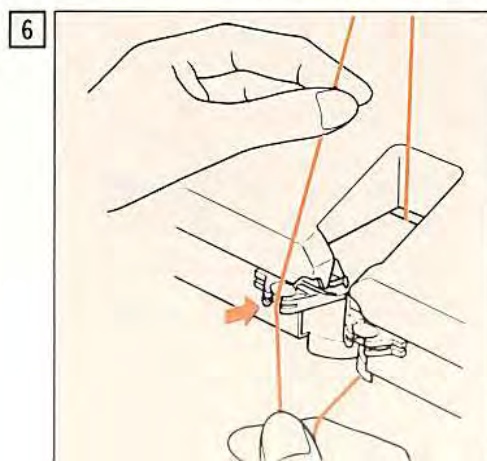

(1) Pull down the yarn by hands.  
(2) Then put the yarn behind the boss with pulling it and make sure that the yarn passes between the metal plate A and B.

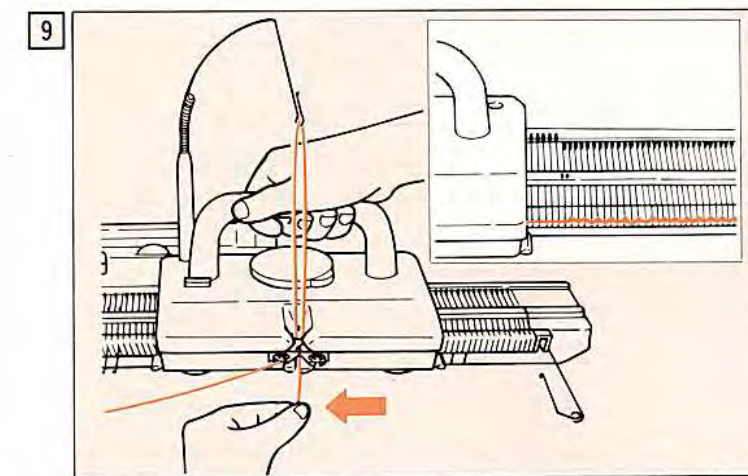
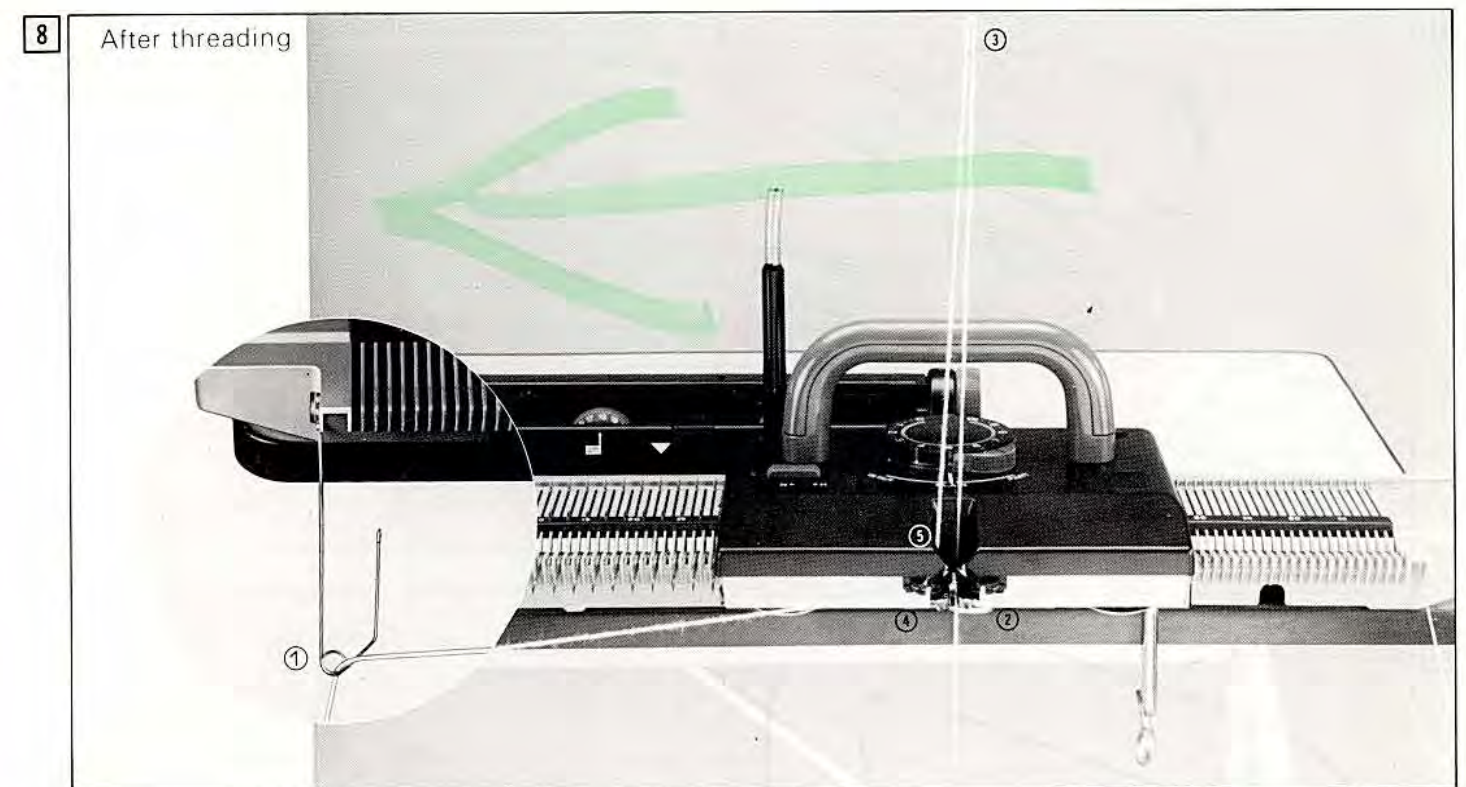

Move the carriage slowly to the left until it passes the needle of left 30. Release the yarn end.

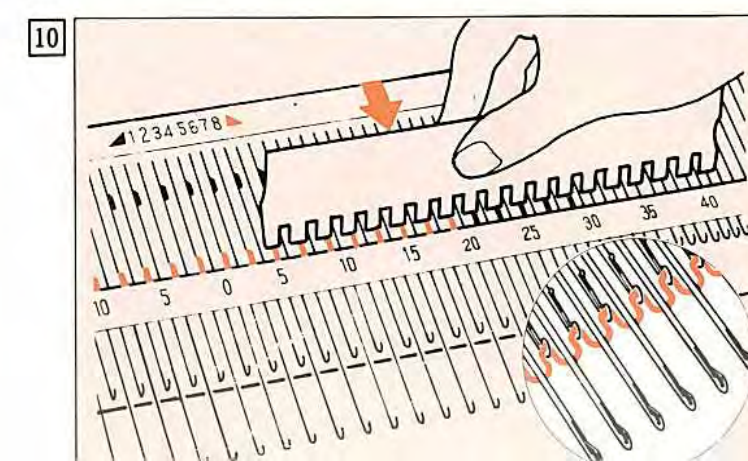

Bring forward the needles which are at position A to position E by using 1/1 needle pusher.



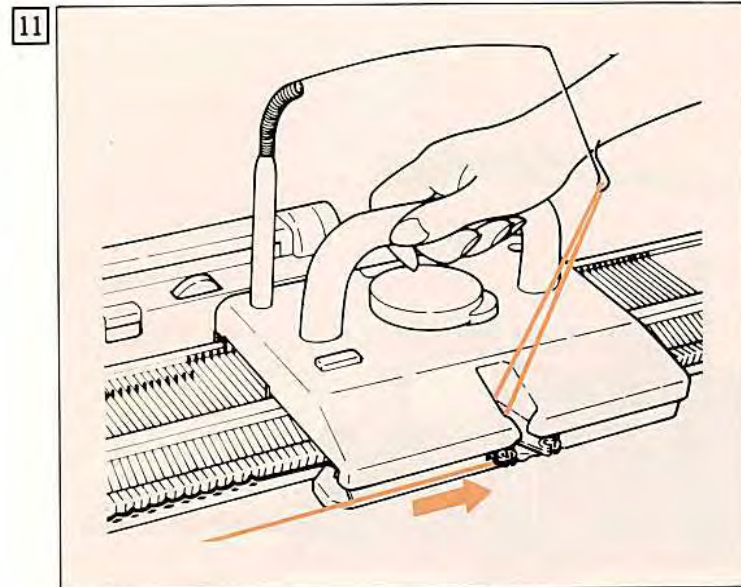

Move the carriage slowly to the right. Repeat 1, 9, 10, and 11 once more. (This time the needles are at position B instead of position A.)

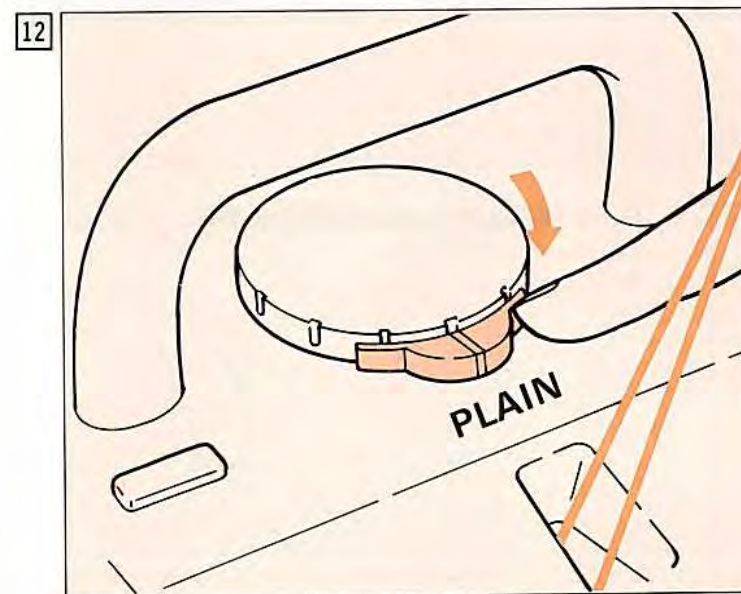

Set the change lever to "PLAIN".

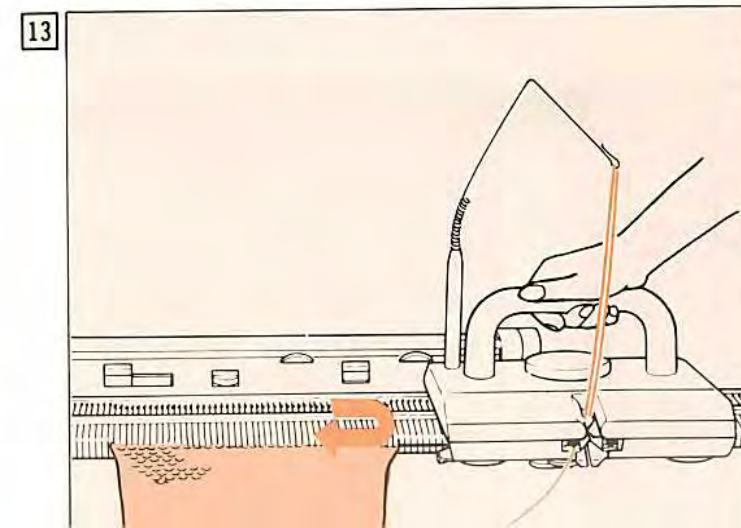

Continue to operate the carriage back and forth. This is called plain knitting. (Return the carriage after it passed the needle of the position B.)

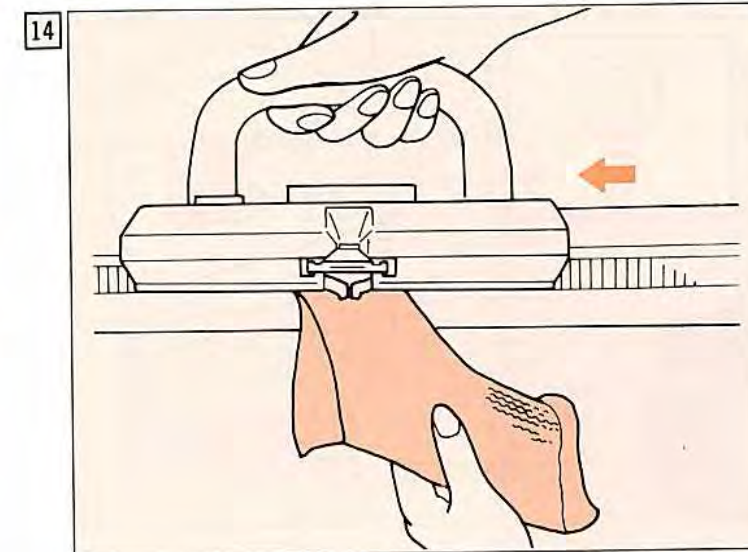

Remove the knitting swatch from the machine. Take off the yarn from the carriage and move the carriage to the other side, then the knitting swatch will be removed from the machine.

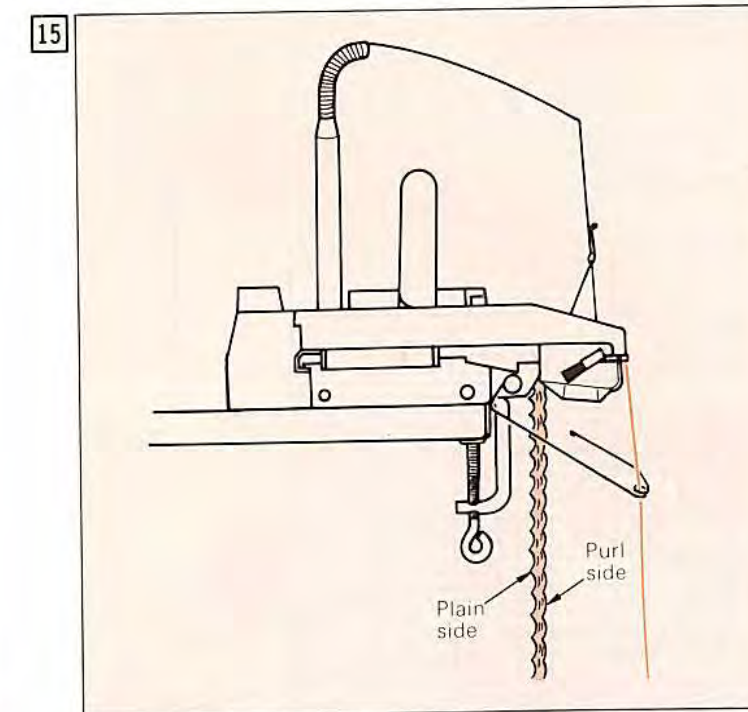

The plain side. This side is away from you, when you are knitting.

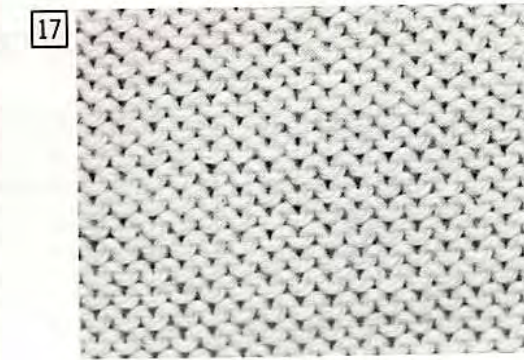

The purl side. This side is facing you, when you are knitting.



## 2 Intarsia knitting

- \* This pattern is knitted without traversing yarn at the back.
- \* You can knit multi-colour yarns in one row, and also you can decide the size of pattern which you like to knit into the garment.
- \* Prepare yarns for the number of times that you want to change.
- \* Use the intarsia diagram or the knit-leader.
- \* If the whole swatch is the intarsia knitting, make the tension swatch according to the operation of intarsia knitting.

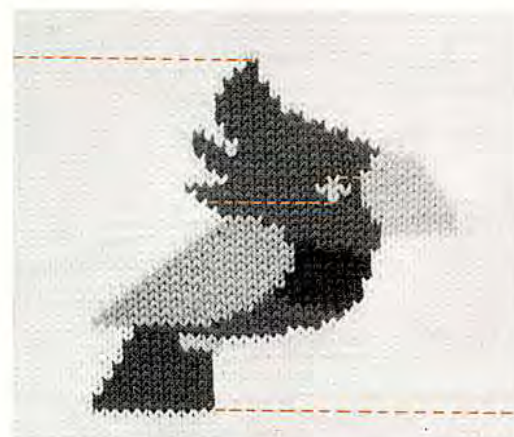

### Intarsia diagram

(Draw the pattern in the opposite side of completion.)

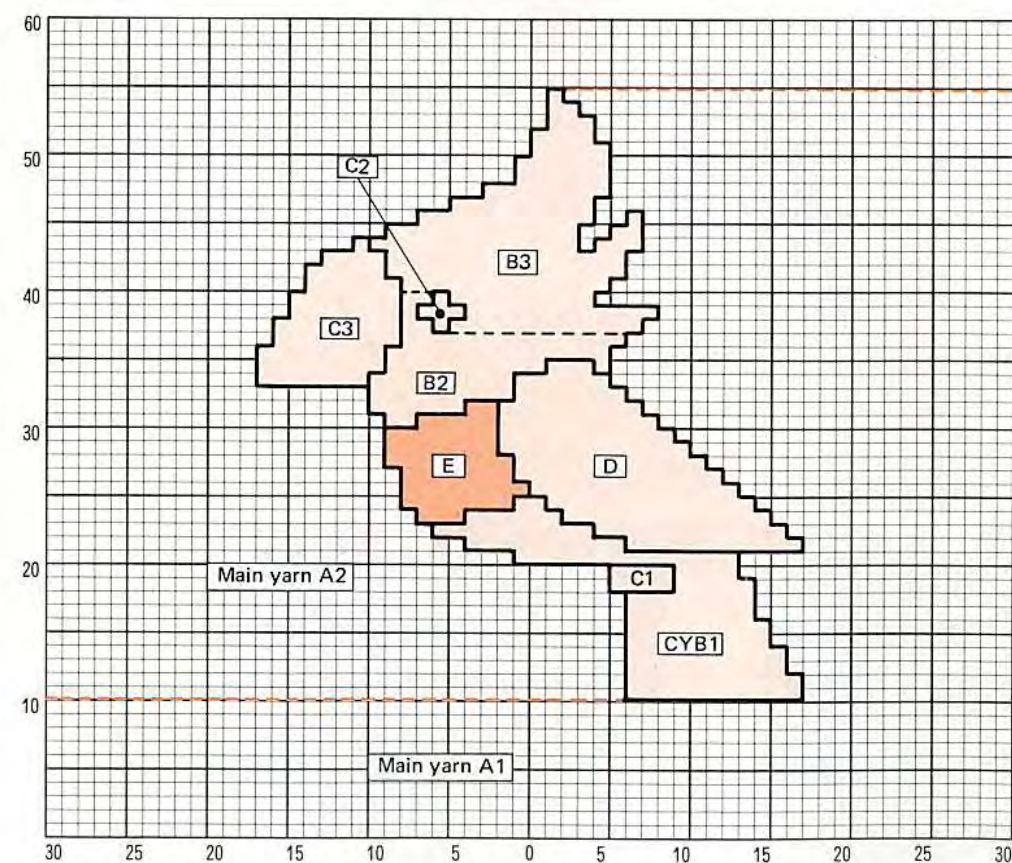

Knit the intarsia knitting according to the intarsia diagram.

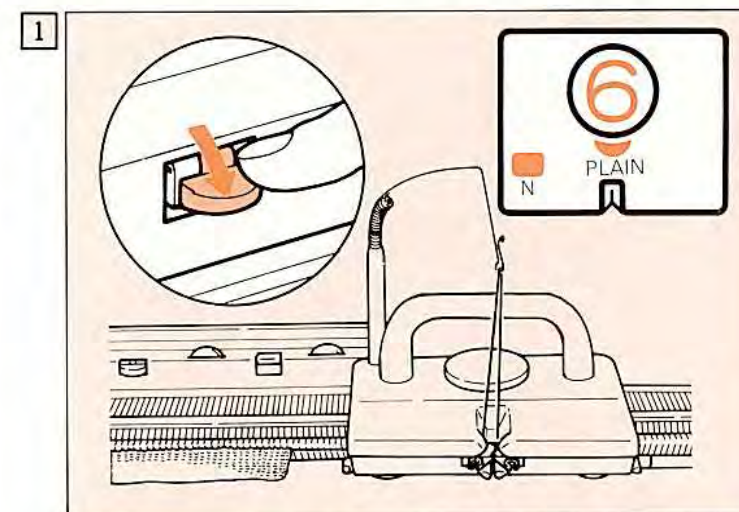

Bring forward 60 needles (30 needles on either side of the center) to position B.  
Set the feeding lever and knit 10 rows in plain knitting with the main yarn A1.  
Place the carriage at the right.

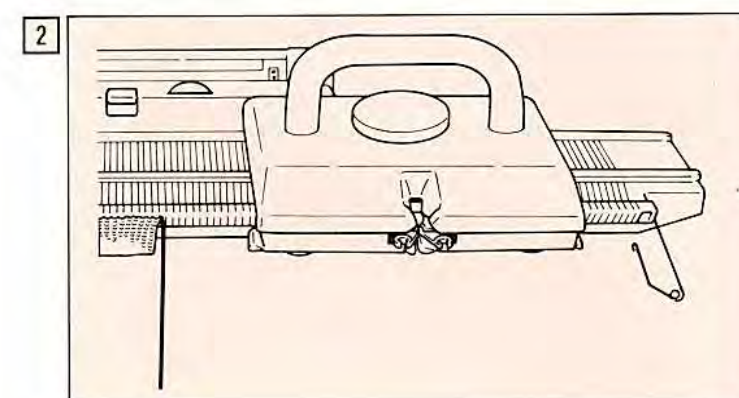

Take off the yarn from the carriage and the yarn guide.  
(Take off the tension spring from the carriage.)

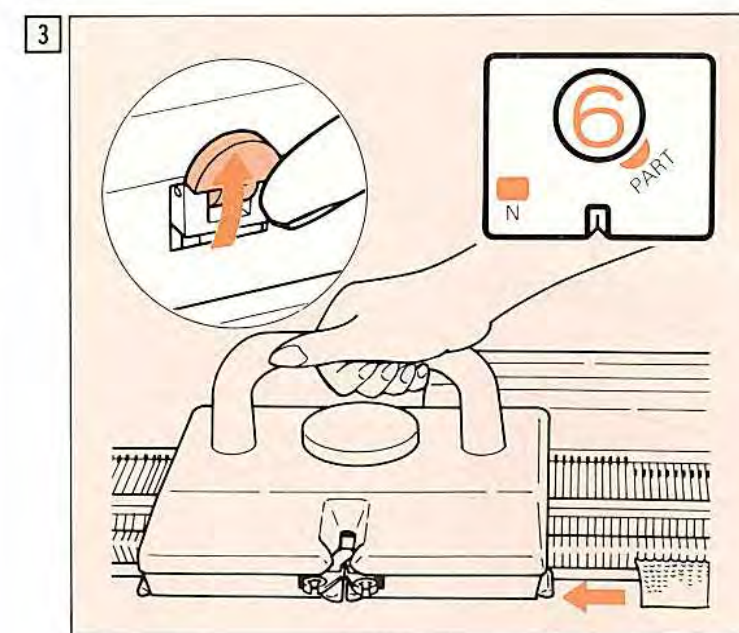

Fold up the feeding lever and set the change lever to "PART".  
Move the carriage to the left.



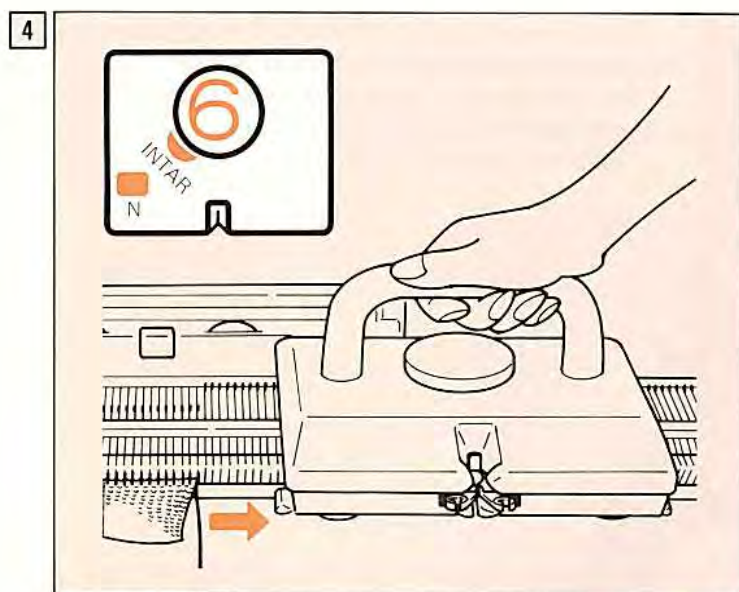

Set the change lever to "INTAR".  
Move the carriage to the right.  
(Make sure that the latch of needle is open and needles are selected to position D.)

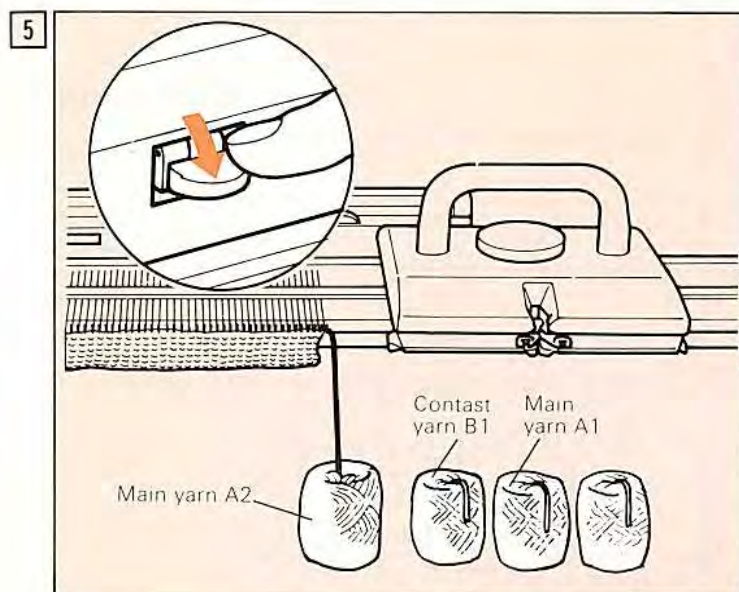

Set the feeding lever.  
Place the contrast yarns which you want to knit at your feet.

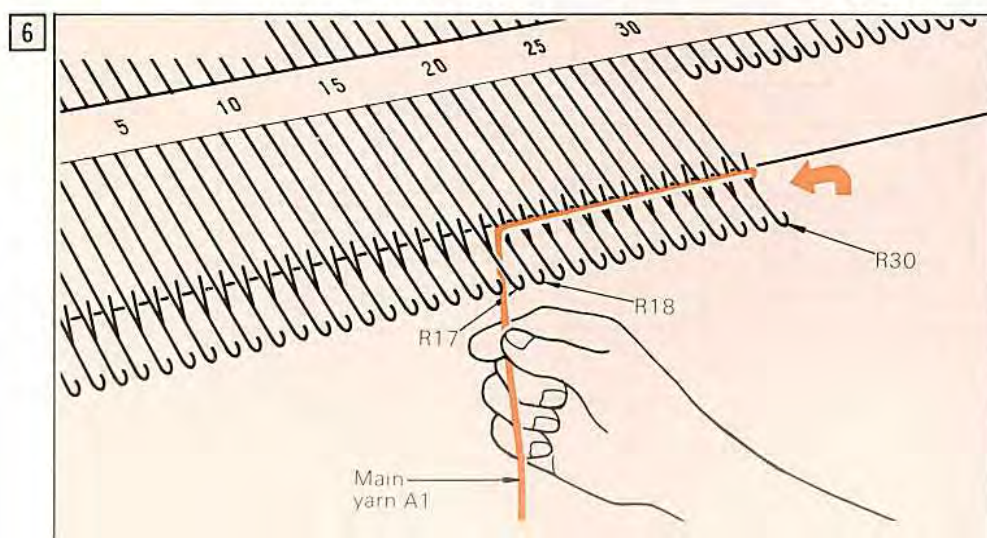

Lay the main yarn A1 on the needles, from right end to 18th right needle, and drop it between 18th and 17th needle.

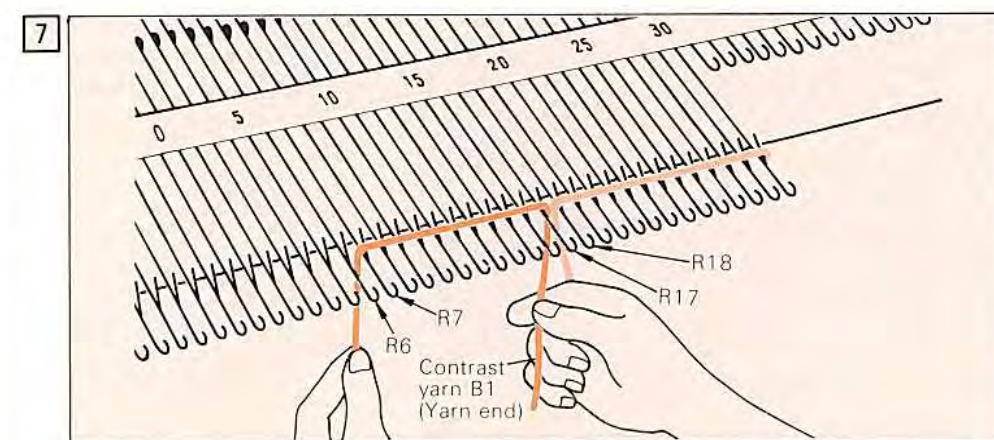

Lay the contrast yarn B1 on the needles, from 17th right needle to 7th right needle.

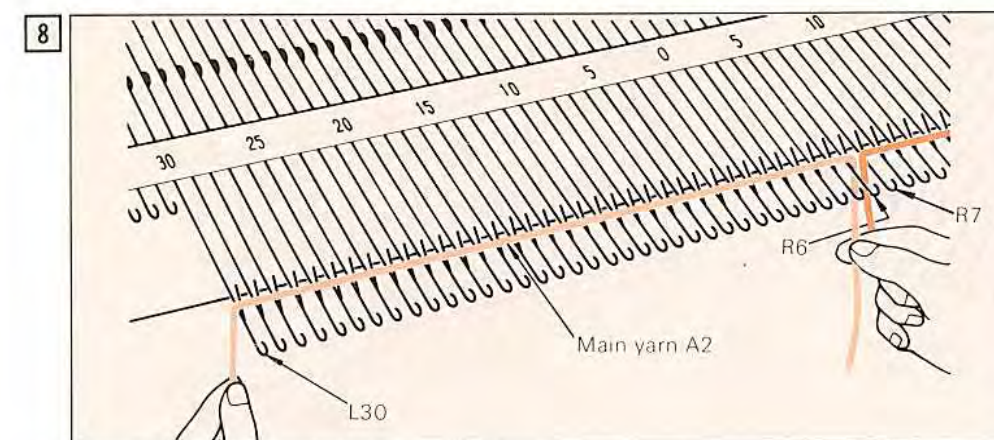

Lay the main yarn A2 on the needles, from 6th right needle to the left end needle.

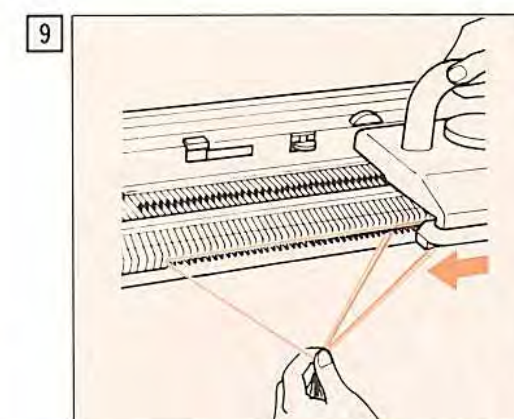

Pull the all yarns down slightly and move the carriage to the left.

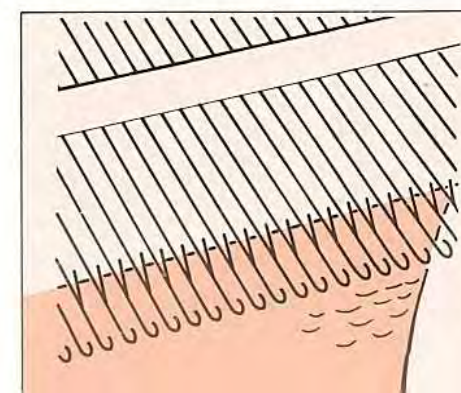

\*After the yarns were knitted, the latches of needles are open and needles are selected to position D.



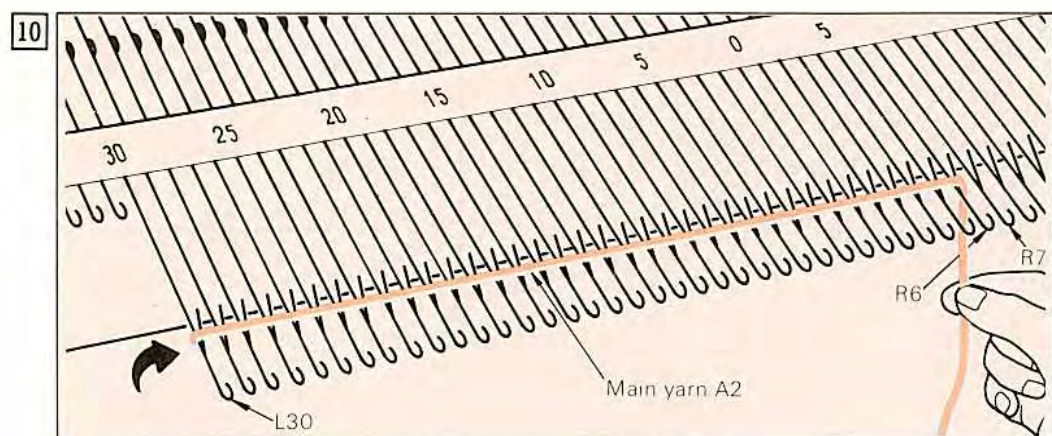

Lay the main yarn A2 on the needles, from the left end needle to 6th right needle.

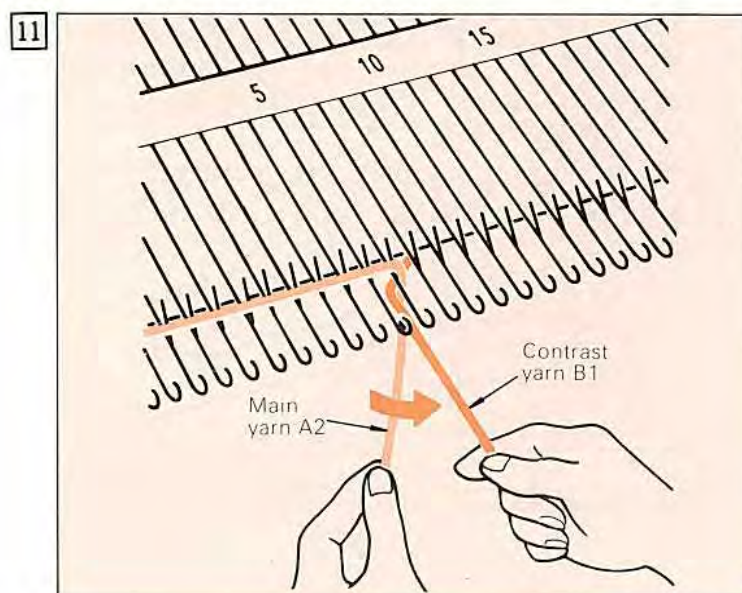

Cross the main yarn A2 and the contrast yarn B1 as shown in the figure.

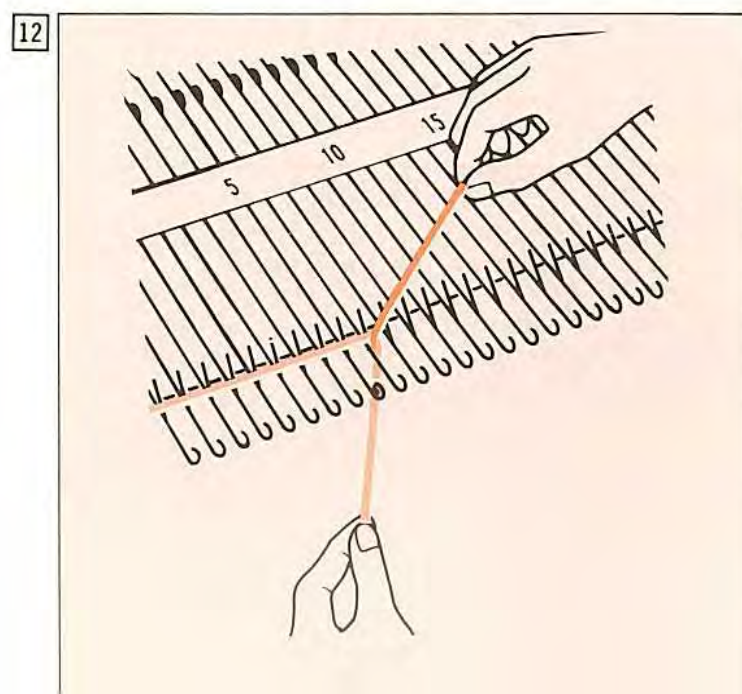

Crossing part should be between 6th and 7th right needle, and lay the contrast yarn B1 on the needles, from 7th right needle to 17th right needle.

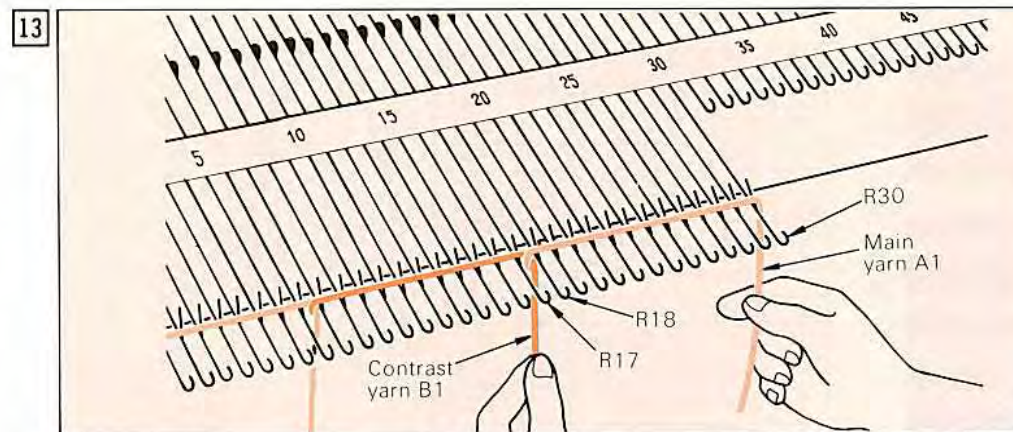

Cross the contrast yarn B1 and the main yarn A1 between 17th and 18th right needle in the same way as the 11 and 12. Lay the main yarn on the needles, from 18th right needle to the right end needle.

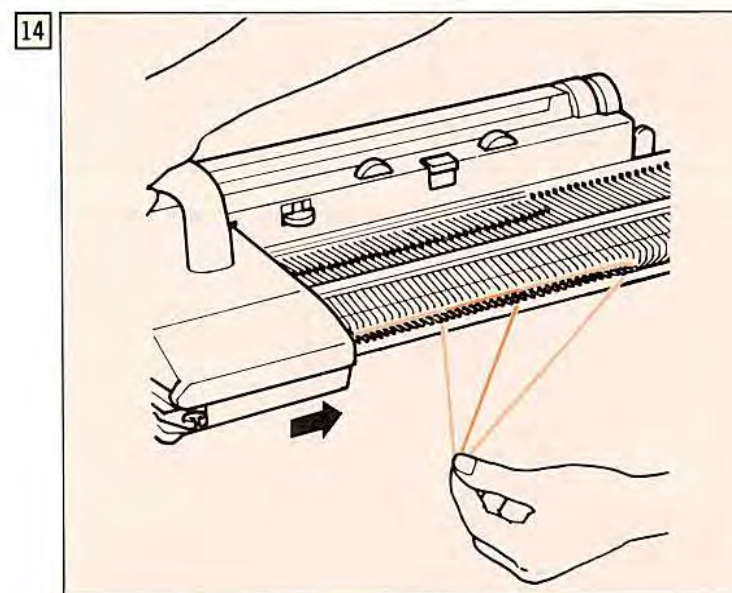

Pull the all yarns down slightly and move the carriage to the right.

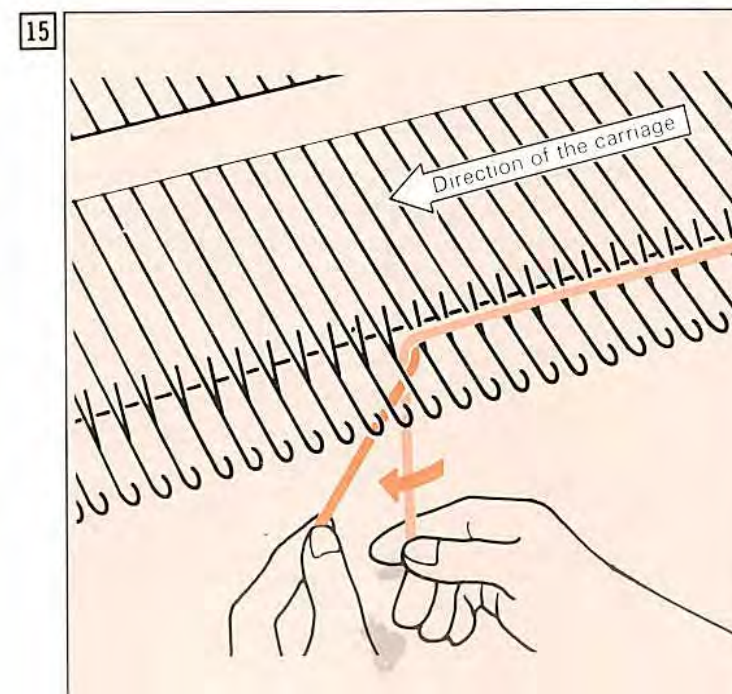

On and after the 13th row, operate according to the intarsia diagram in the same way as the 12th row. (When you move the carriage right to left, cross the yarns as shown in the figure.)



### 3 Striped pattern

\*This is a pattern which is knitted by changing yarns every even number row.

\*If there are lots of striped patterns, it is much easier to use the way of intarsia knitting.

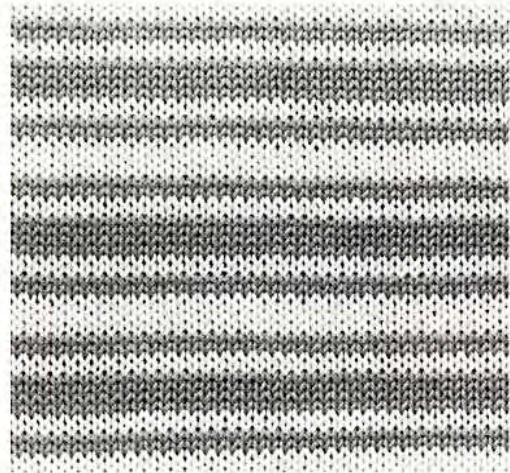

Main yarn ..... medium  
 Contrast yarn ..... medium  
 Tension Dial ..... 6

"	"	"	"	→
"	"	"	Contrast	←
"	"	"	"	→
"	"	"	"	←
"	"	"	"	→
"	"	"	Main	←
"	"	"	"	→
"	"	"	Contrast	←
"	"	"	"	→
"	"	"	Main	←
"	"	"	"	→
"	"	"	"	←
"	"	"	"	→
"	"	"	Contrast	←
"	"	"	"	→
"	"	"	"	←
N	PLAIN	6	Main	←

(Operation chart)

Direction of the carriage

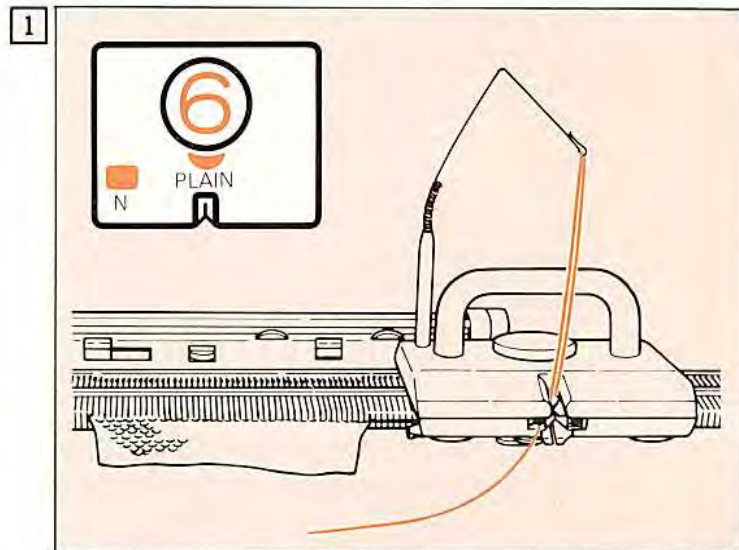

Knit several rows in plain knitting with main yarn.  
 Place the carriage at the right.

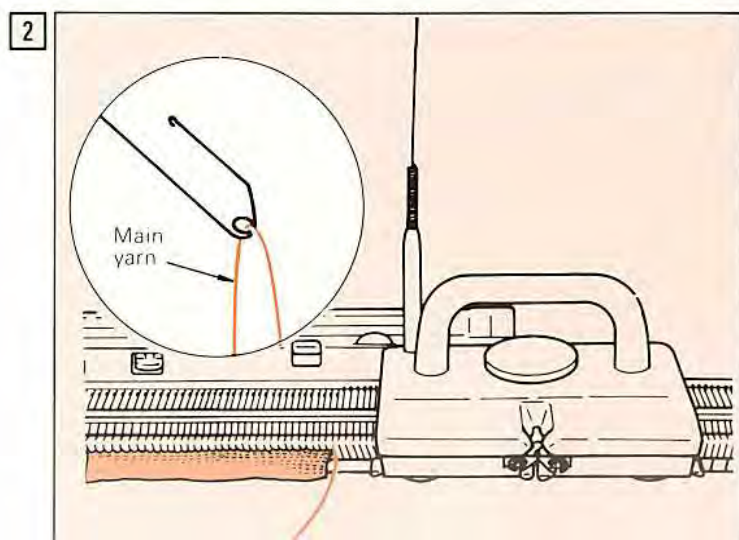

Knit 2 rows with main yarn and take off the main yarn from the carriage without pulling the stitches.  
 (Do not take off the yarn from the yarn guide.)

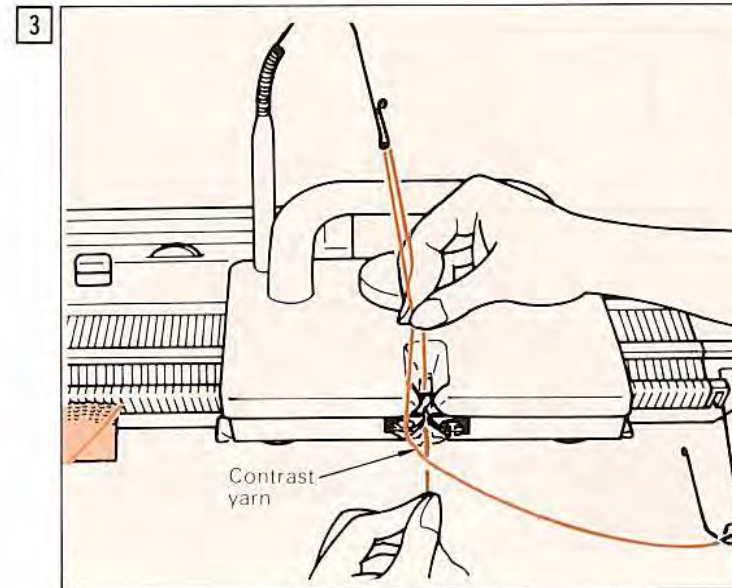

Thread the contrast yarn into the yarn feeder through the right side yarn guide and knit 4 rows.

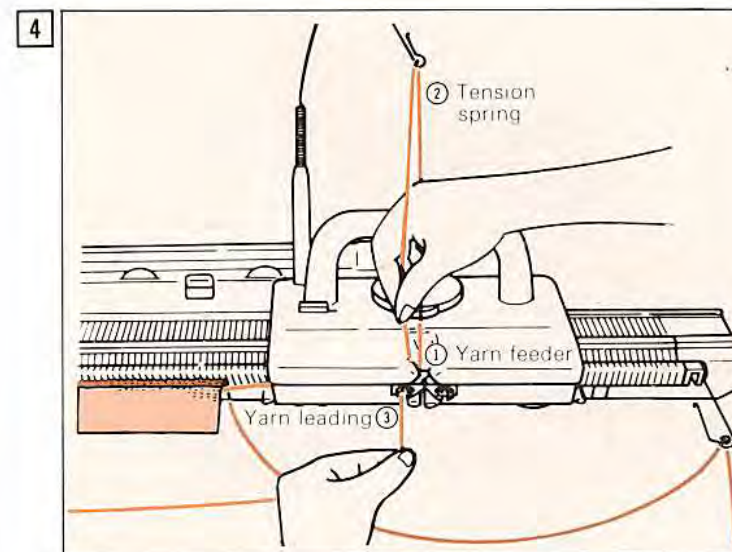

Take off the contrast yarn from the carriage.  
 (Do not take the yarn from the yarn guide.)  
 Thread the main yarn from the knitting switch in order as shown in the figure.  
 Knit 2 rows.

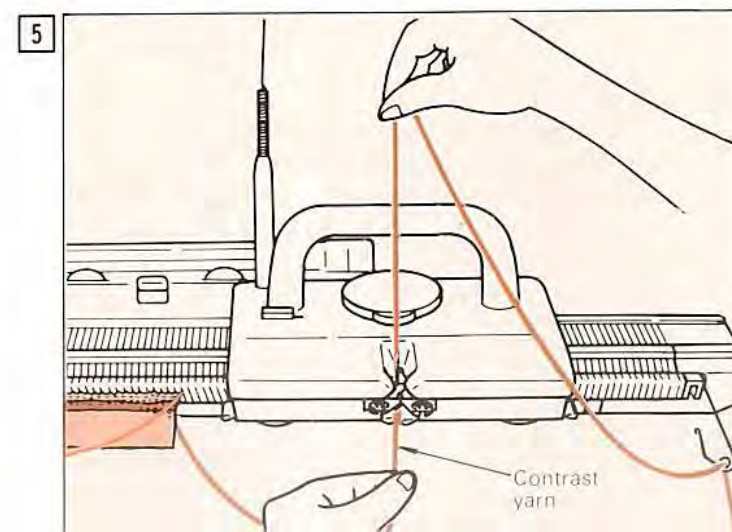

Change the yarn from the main yarn to the contrast yarn.  
 Knit 2 rows.  
 Continue to operate according to the operation chart.



## 4 Skip stitch pattern

\*This pattern is knitted by sliding 1/3 selected needles from side to side.

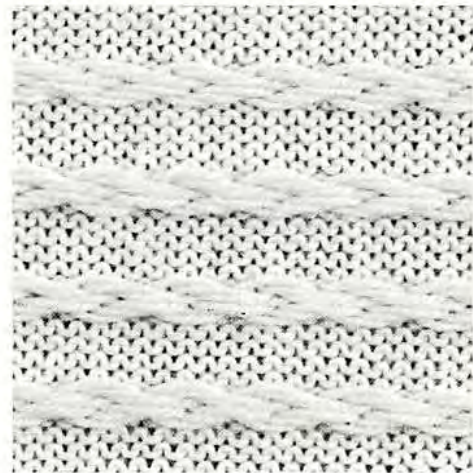

yarn ..... medium  
Tension Dial — PLAIN 6  
                  — PART 7

(Operation chart)

12	"	"	"	"											→
11	"	"	"	"											←
10	"	"	"	"											→
9	"	"	"	"											→
8	"	PLAIN	6	"											←
7	"	"	"	"											→
6	"	"	"	"											←
5	"	"	"	"											→
4	"	"	"	"											←
3	"	"	"	"											→
2	"	"	"	"											←
1	N	PART	7	M.Y											→

Steps

1 2 3 4 5 6 7 8

▲ 1 2 3 4 5 6 7 8 ▲

The figure (1-8) shows the needle position for pattern.

Direction of the carriage

(Do not use the mark ▲ when you knit a pattern.)

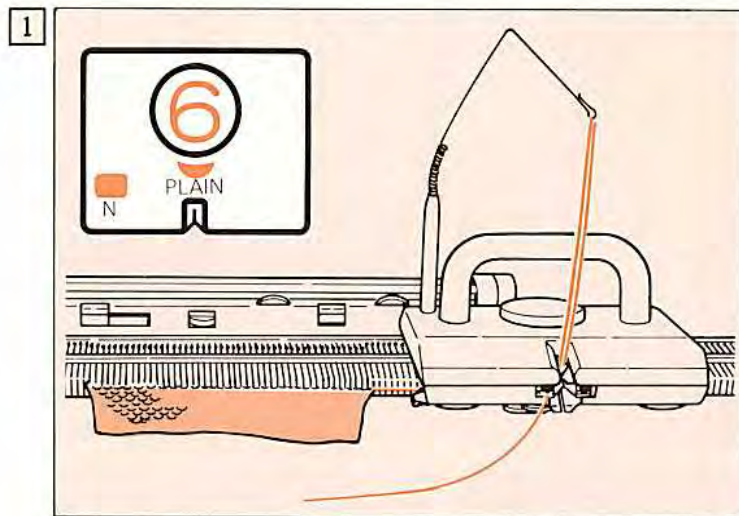

Knit several rows in plain knitting.  
Place the carriage at the right.

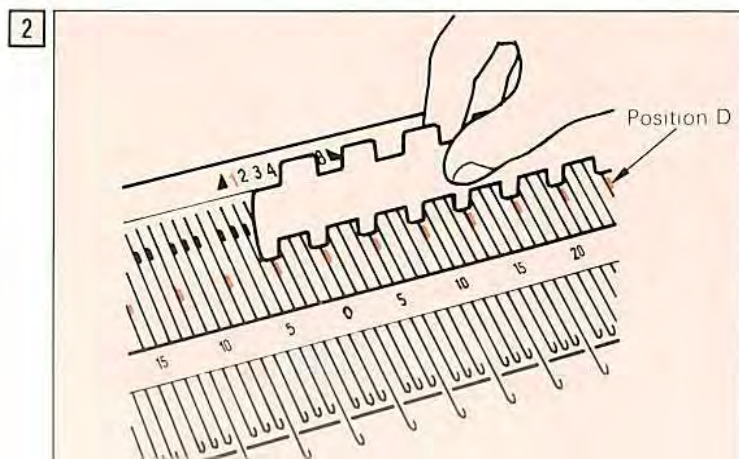

(1st row)  
By using 1/3 needle pusher, bring forward needles indicated in the chart to position D.  
Also bring forward the end needles of the knitting swatch.

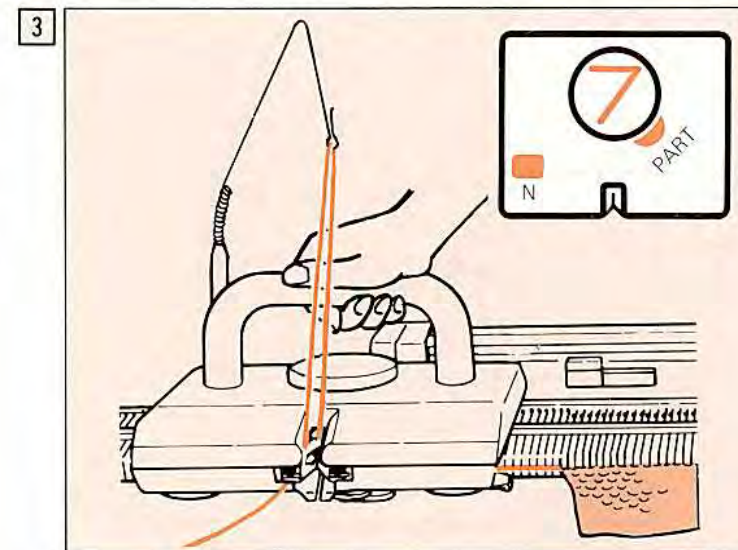

Set the change lever to "PART".  
Change the T.D. number from 6 to 7.  
Move the carriage to the left.

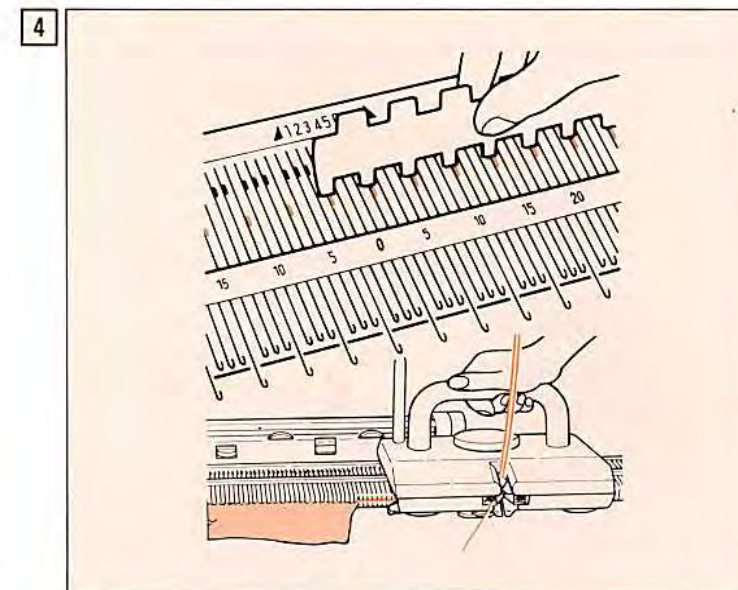

(2nd row)  
Bring forward the needles indicated in the chart to position D.  
Move the carriage to the right.  
According to the operation chart, continue to operate 3rd row to 7th row.

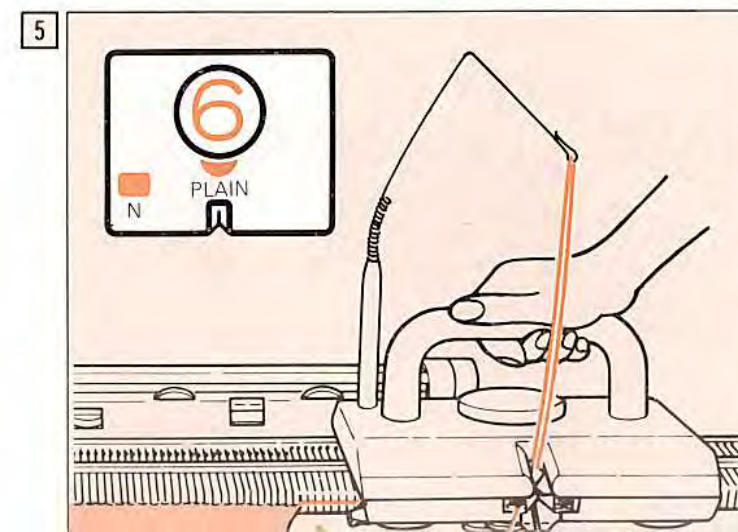

Set the change lever to "PLAIN".  
Change the T.D. number from 7 to 6.  
Knit 5 rows in plain knitting.  
Repeat 2 to 5.



# 5 Pull-up stitch pattern

\*This pattern is knitted by selecting 1/3 needles alternately.

(Operation chart)

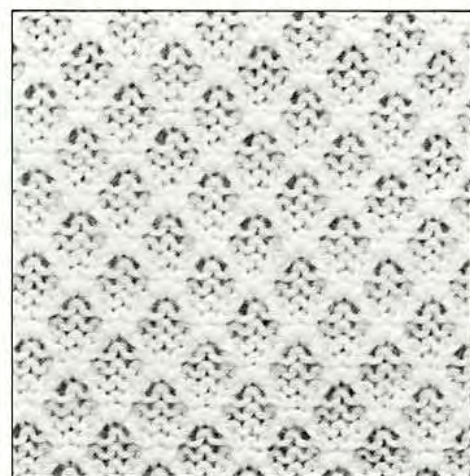

8	N	"	"	"													→
7	"	"	"	"													←
6	"	"	"	"													→
5	H	"	"	"													→
4	N	"	"	"													→
3	"	"	"	"													←
2	"	"	"	"													←
1	H	PLAIN	6	MY													→

Yarn .... medium  
Tension Dial 6

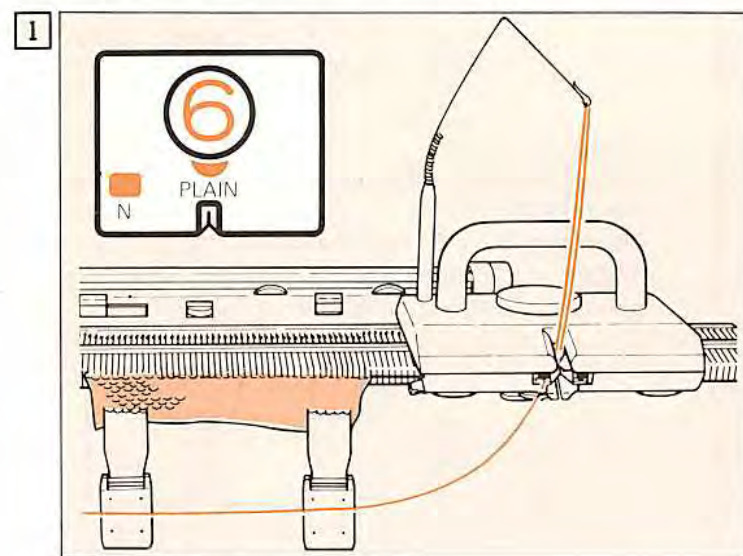
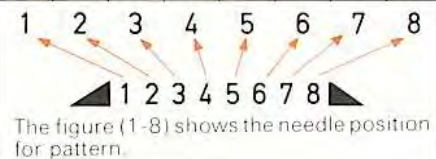

Knit several rows in plain knitting.  
Place the carriage at the right.  
Before starting the pull-up stitch pattern, hang the claw weights on the knitting switch.

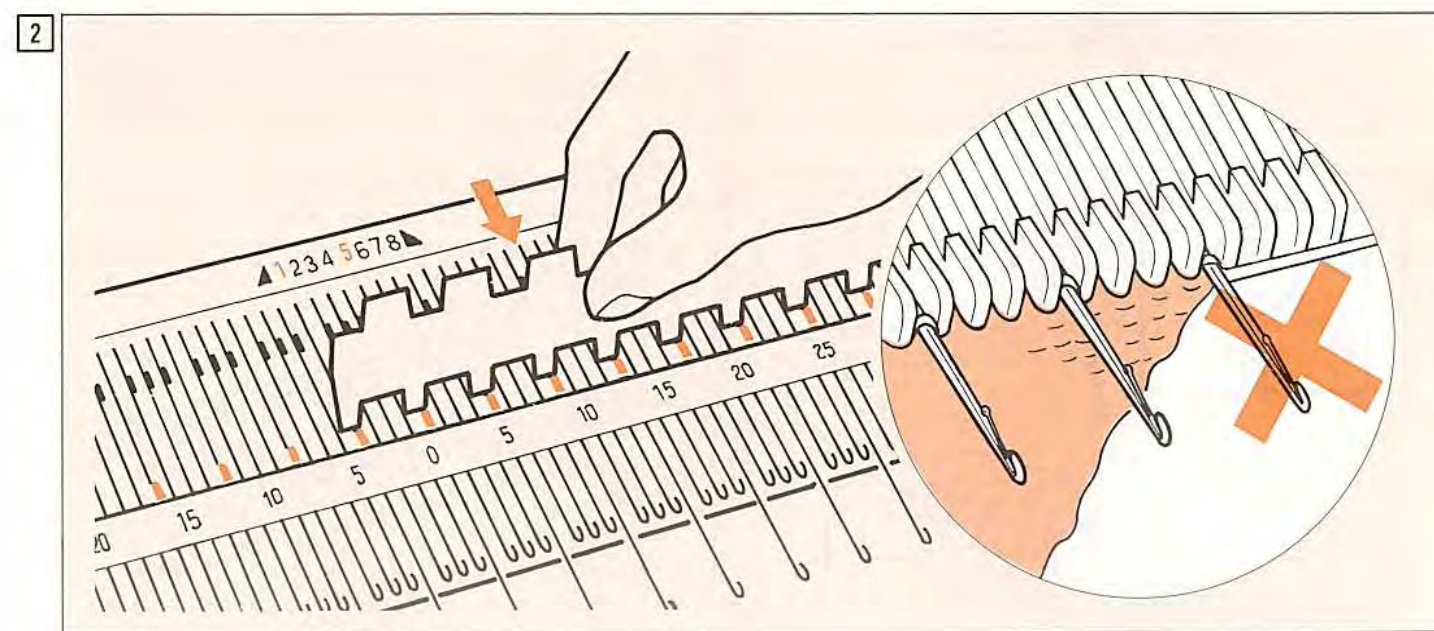

(1st row)

2. ... 1/3 needles bring forward needles indicated in the chart to position E

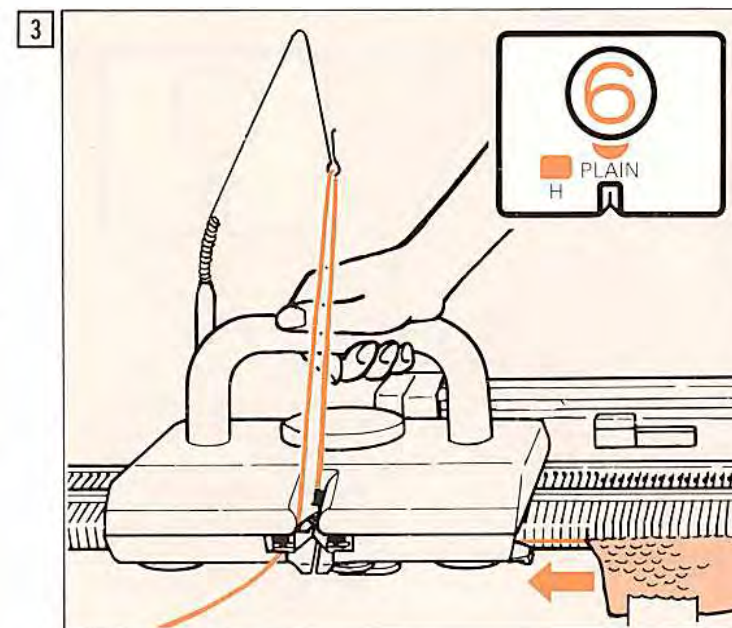

Set the cam lever to H.  
Move the carriage to the left.

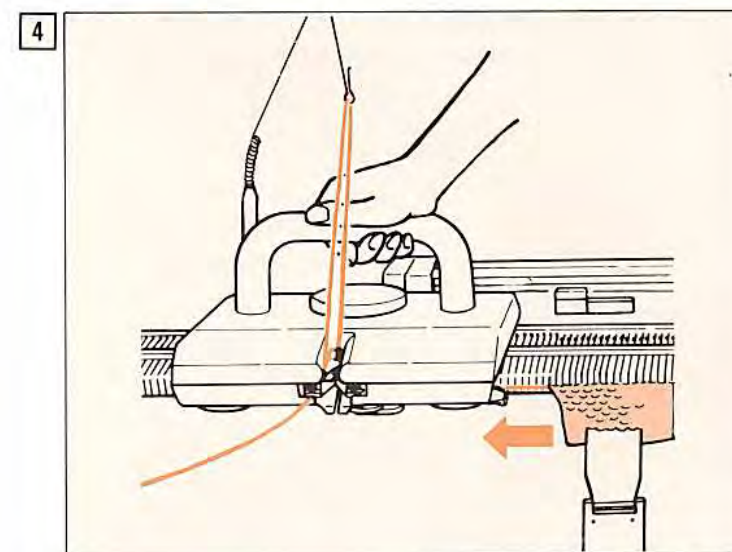

Continue to knit 2 rows.

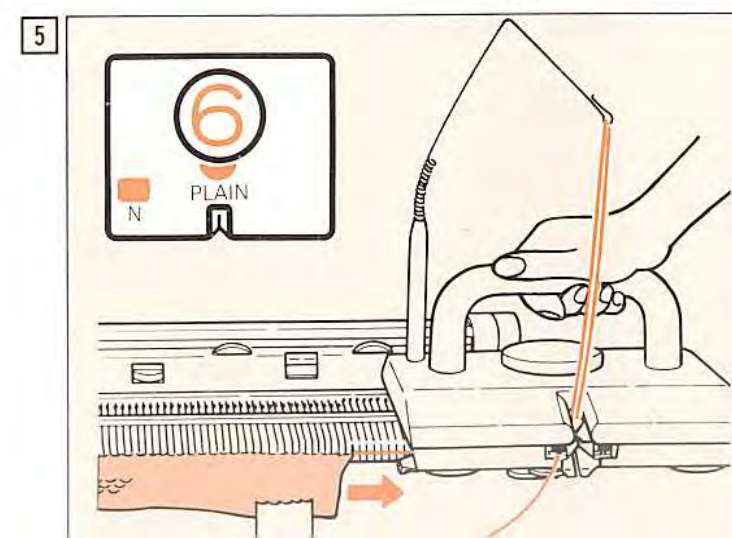

Set the cam lever to N.  
Move the carriage to the right.



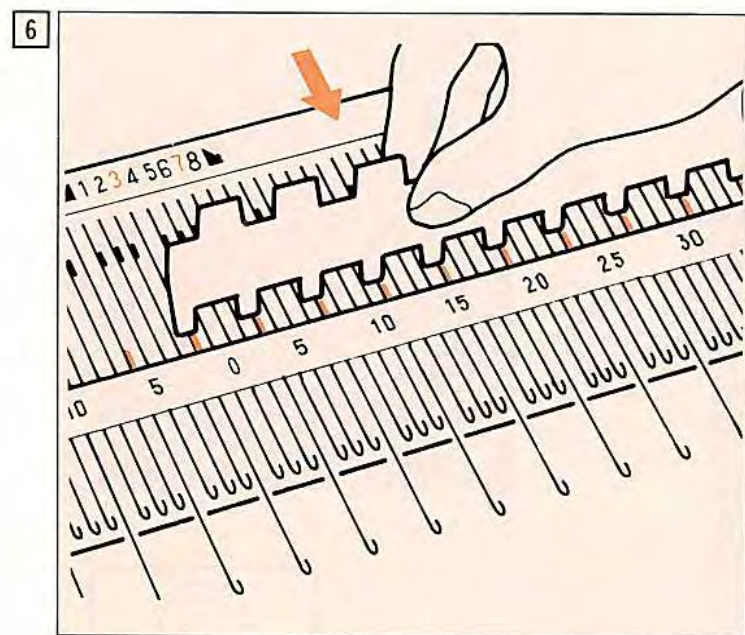

6 (5th row)  
Bring forward the needles indicated in the chart to position E.

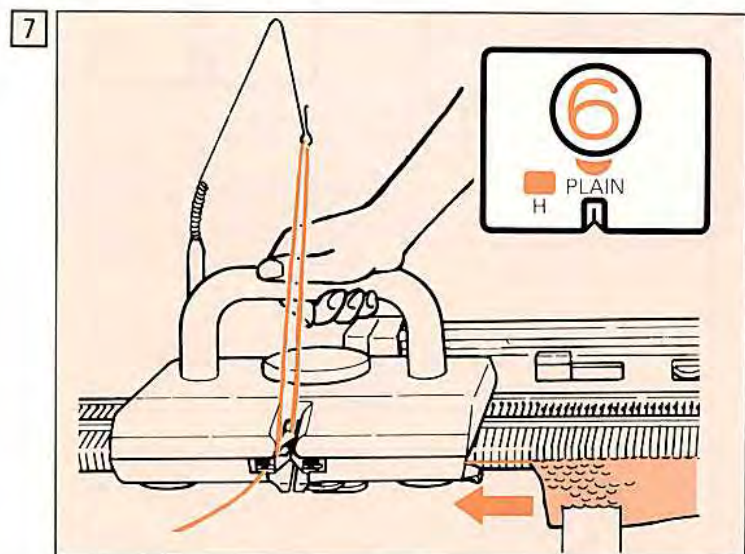

7 Set the cam lever to H.  
Move the carriage to the left.

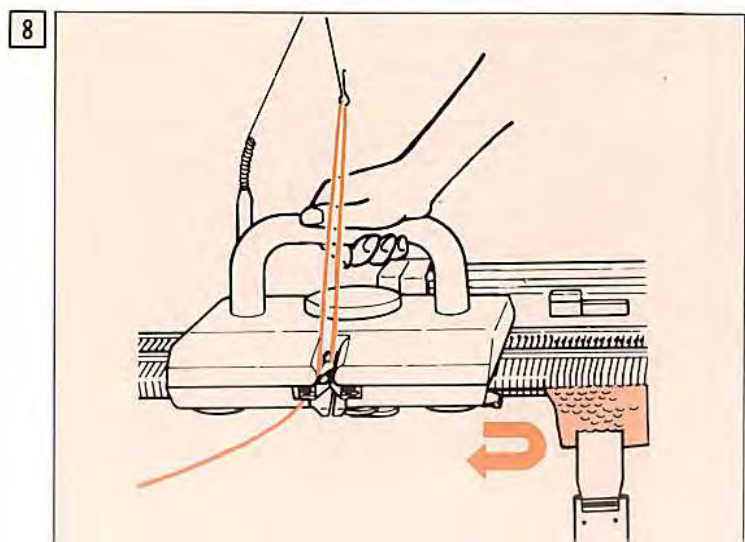

8 Continue to knit 2 rows.

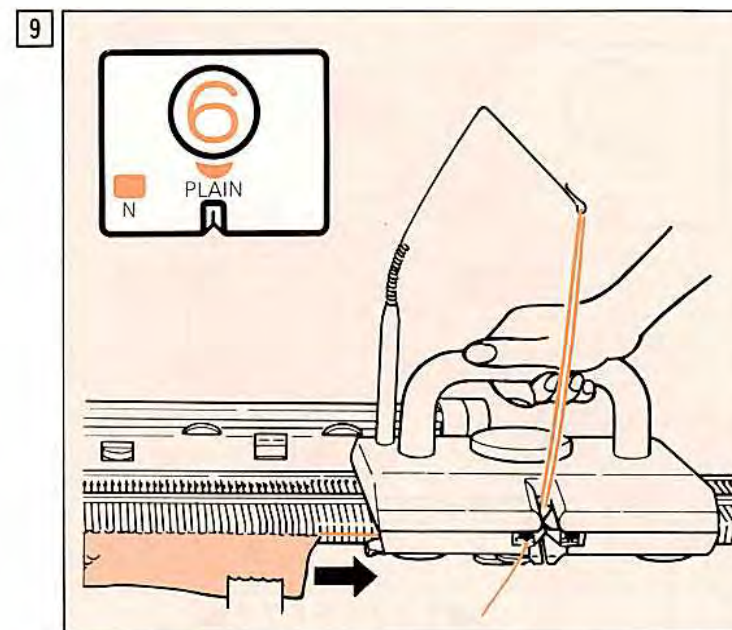

9 Set the cam lever to N.  
Move the carriage to the right.  
Continue to operate 1 to 8.

General guide to the thickness of yarn in conjunction with pull up loops per needle;	
Very fine yarn .....	up to 4 loops per needle
Fine yarn .....	up to 4 loops per needle
Medium yarn .....	up to 3 loops per needle
Thick yarn .....	up to 2 loops per needle



## 6 Skip stitch pattern in two colour

\*This pattern is knitted by changing 2 colour yarns every 2 rows.

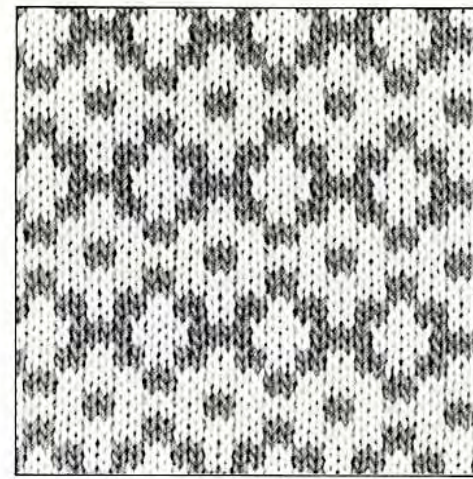

Main yarn ..... medium  
 Contrast yarn ..... medium  
 Tension Dial ..... 6

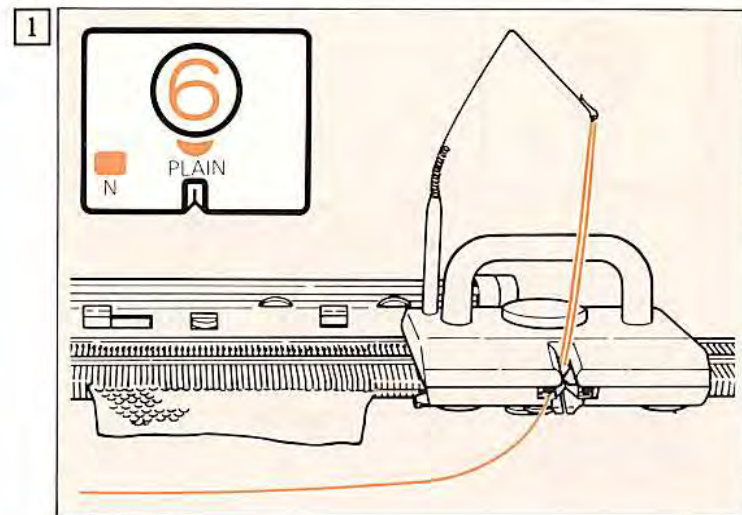
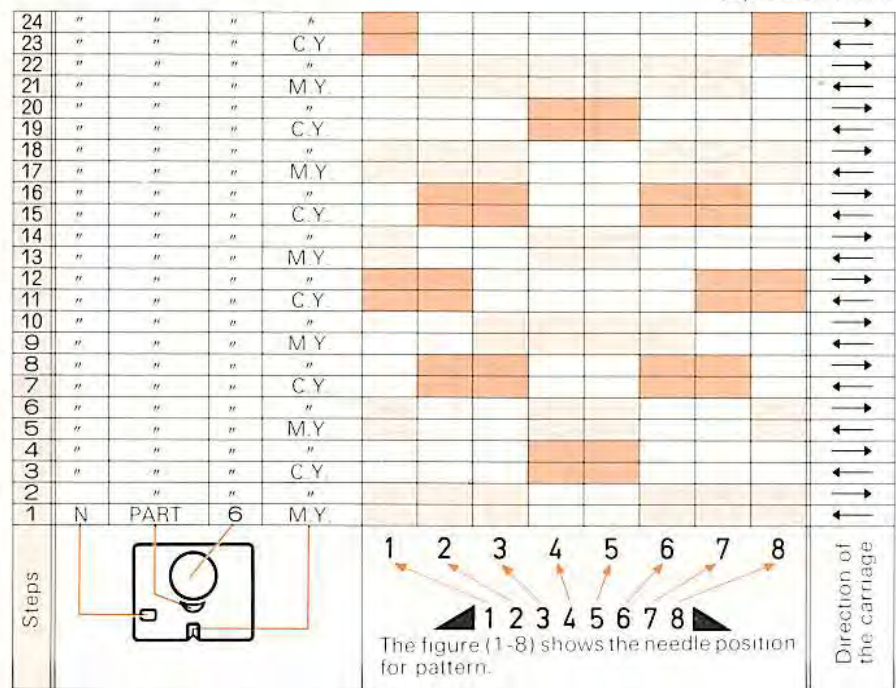

Knit several rows in plain knitting with main yarn and place the carriage at the right.

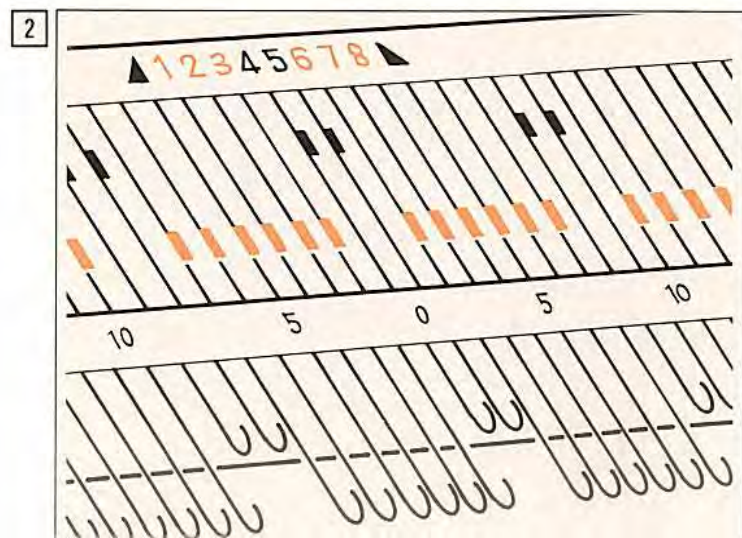

(1st row)  
 Bring forward the needles indicate in the chart to position D.

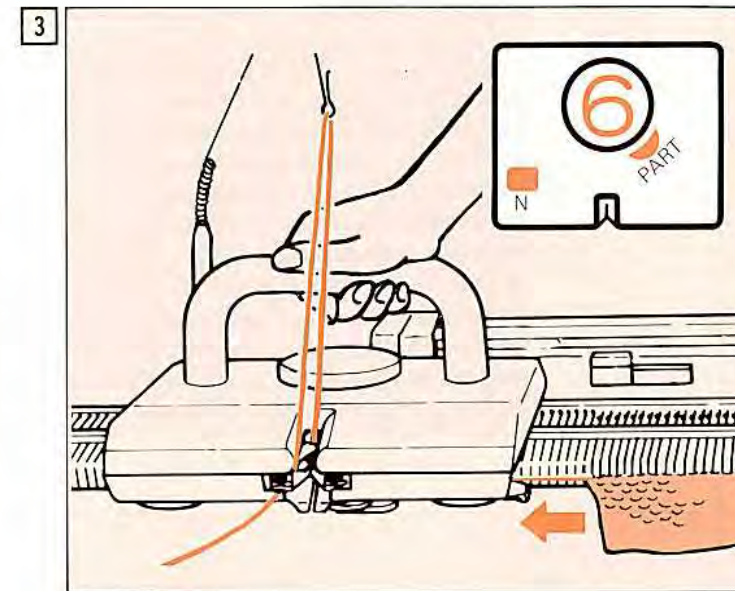

Set the change lever to "PART" and move the carriage to the left.

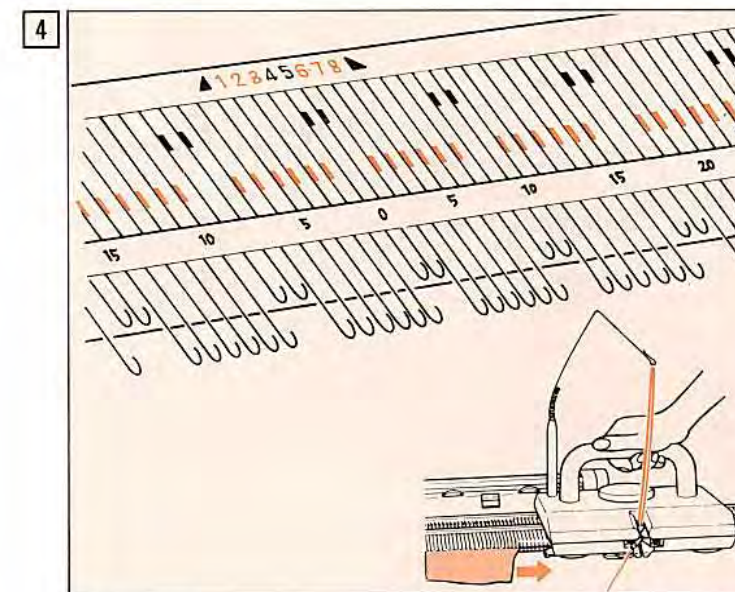

(2nd row)  
 Bring forward the needles indicated in the chart to position D.  
 Move the carriage to the right.

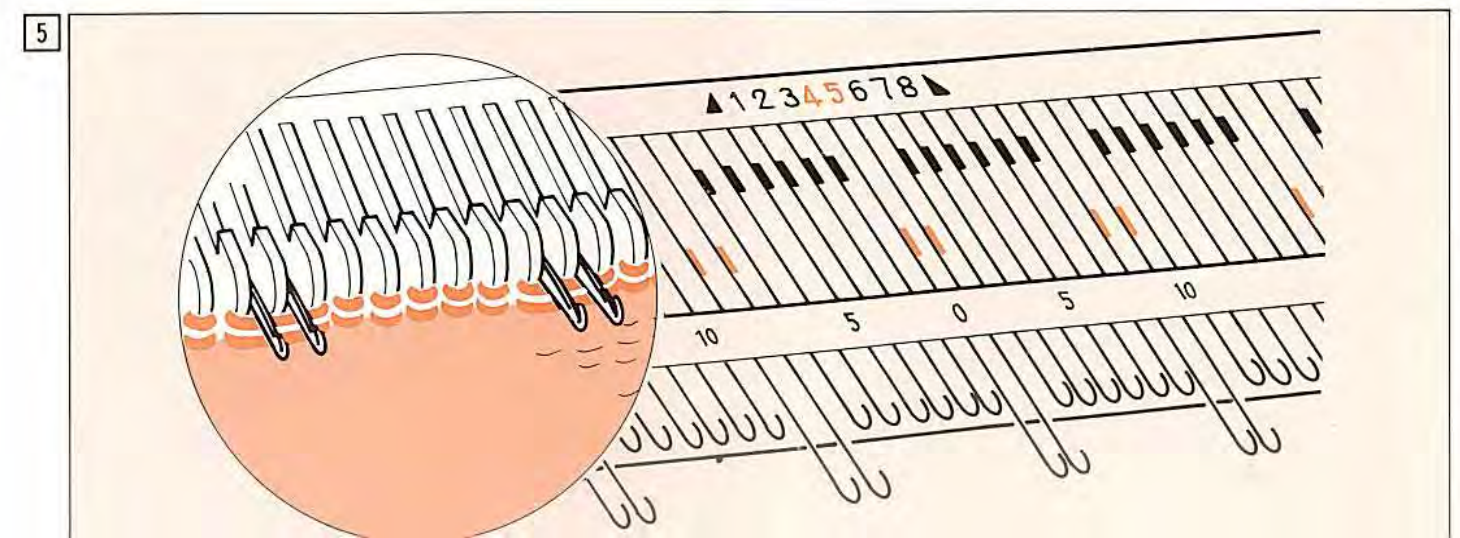



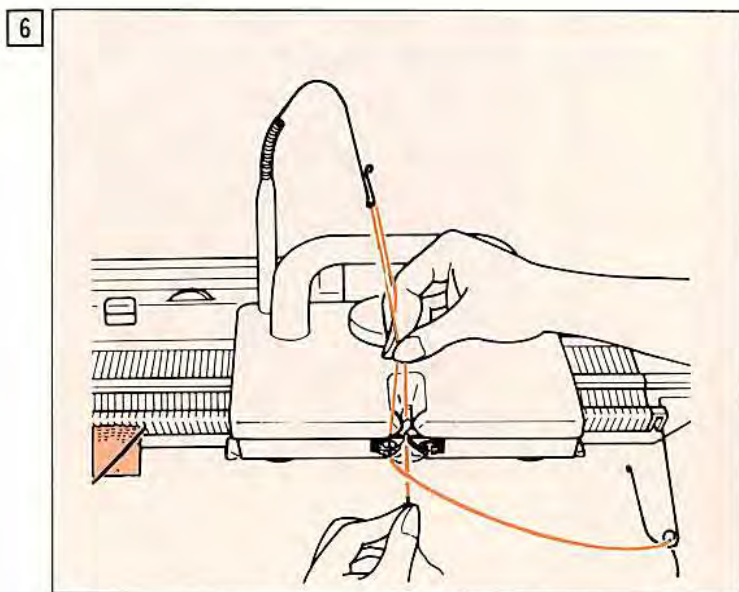

Take off the main yarn from the carriage.  
Pass the contrast yarn through the yarn guide and thread it into the carriage.  
Move the carriage to the left.

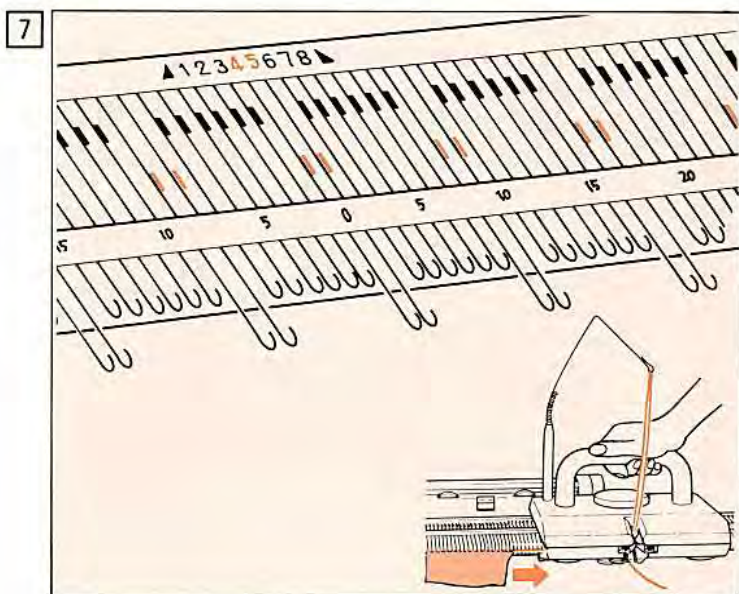

(4th row)  
Bring forward the needles indicated in the chart to position D.  
Move the carriage to the right.  
Continue to operate according to the operation chart.  
Continue to operate 5th row to 24th row.

## 7 Pull-up stitch pattern in two colour

\*This pattern is knitted by changing 2 colour yarns and selecting 1/3 needle.

(Operation chart)

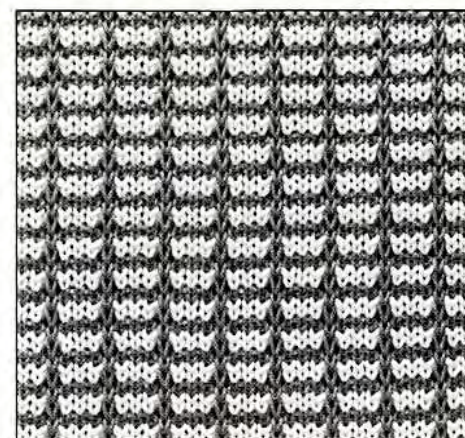

4	"	"	"	"														→
3	N	"	"	"	C.Y.													←
2	"	"	"	"	"													→
1	H	PLAIN	6	"	M.Y.													←

Steps	Diagram	1	2	3	4	5	6	7	8	Direction of the carriage
		→	→	→	→	→	→	→	→	←
The figure (1-8) shows the needle position for pattern.										

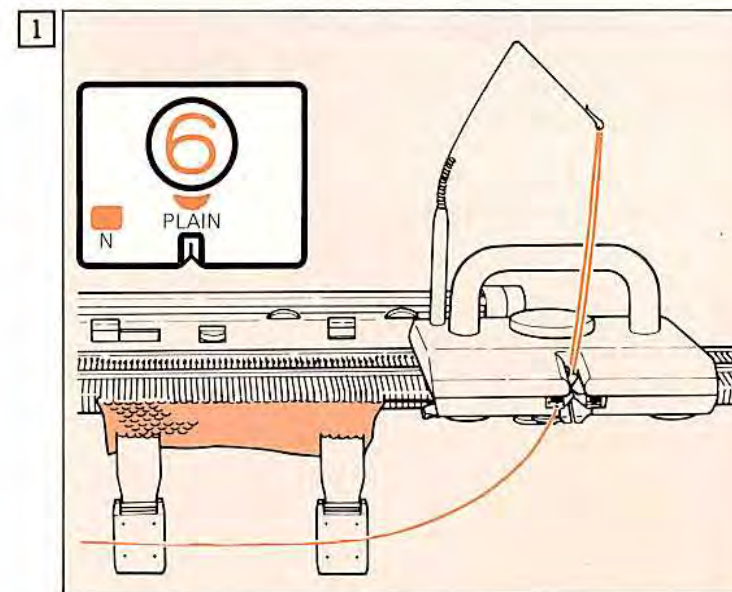

Knit several rows in plain knitting with main yarn and place the carriage at the right.  
(Before starting the pull-up stitch pattern in two colours, hang the claw weights on the knitting switch.)

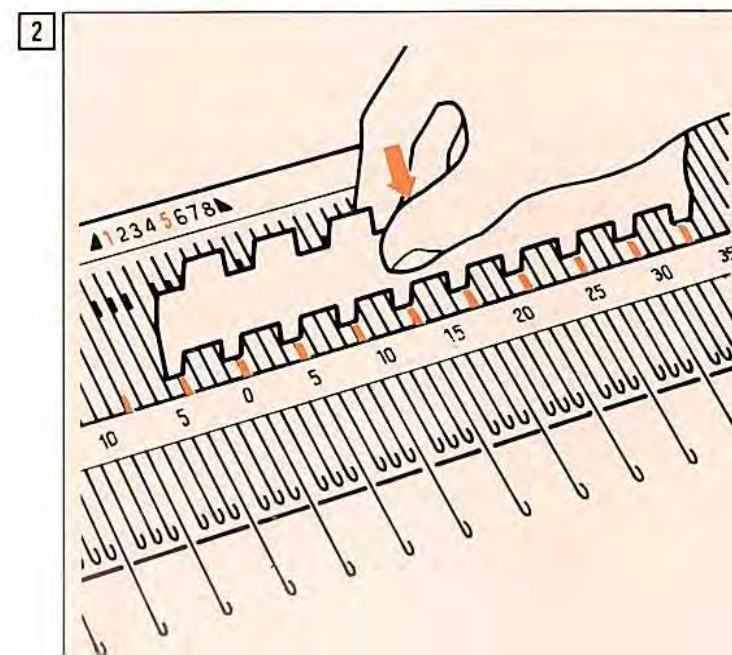

(1st row)  
By using 1/3 needle pusher, bring forward the needles indicated in the chart to position E.  
Do not bring forward the end needles of the knitting switch to position E.



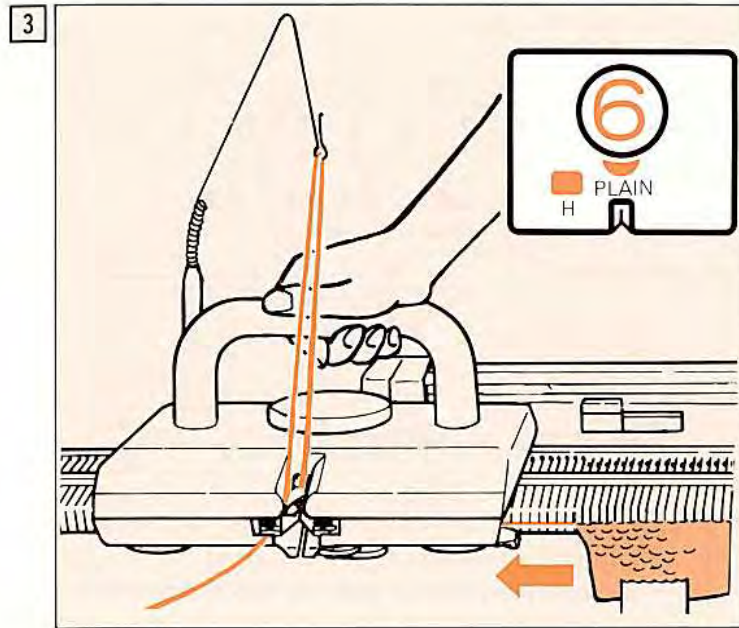

Set the cam lever to H.  
Move the carriage to the left.

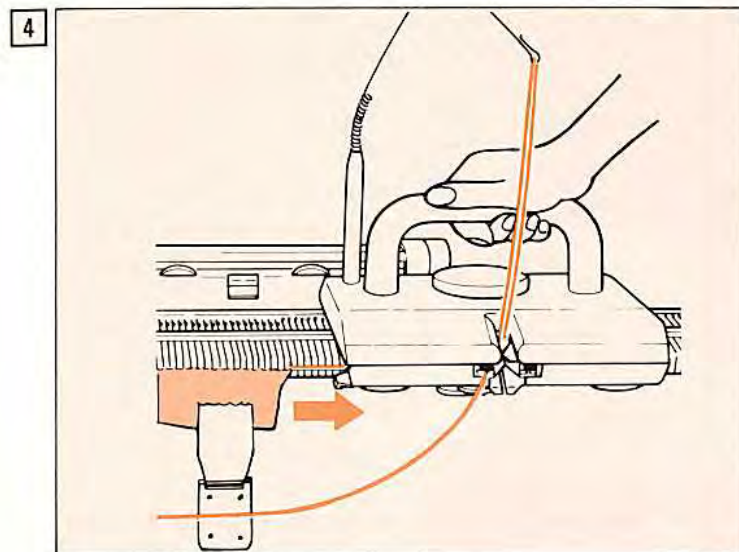

(2nd row)  
Move the carriage to the right.

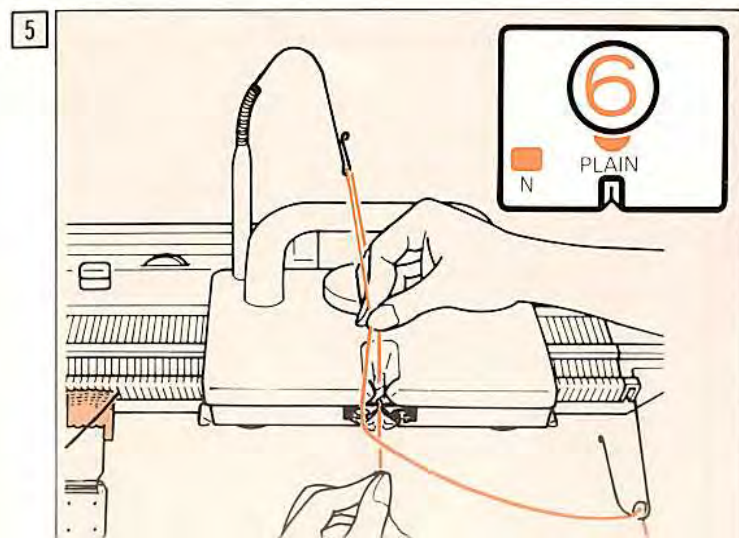

(3rd row)  
Set the cam lever to N.  
Change the Yarn from the main yarn to the contrast  
yarn and move the carriage to the left.

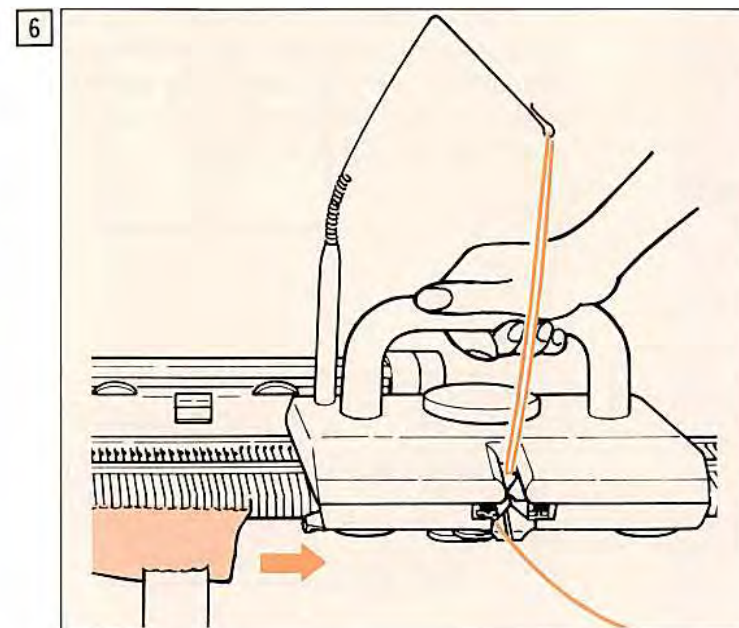

(4th row)  
Move the carriage to the right.  
Repeat 1 to 4.

General guide to the thickness of yarn in conjunction with pull up loops per needle;	
Very fine yarn .....	up to 4 loops per needle
Fine yarn .....	up to 4 loops per needle
Medium yarn .....	up to 3 loops per needle
Thick yarn .....	up to 2 loops per needle



# HOW TO TAKE A TENSION GAUGE

## 1 Tension gauge

\* Gauge in knitting means the density of stitches (or number of stitches and rows).



In order to make a garment in the correct measurement, you need to make a tension swatch first, using the same yarn, same type of stitches and the same tension setting at which you are going to knit.

\* Following instructions are base on using medium yarn.

## 2 How to knit a tension swatch

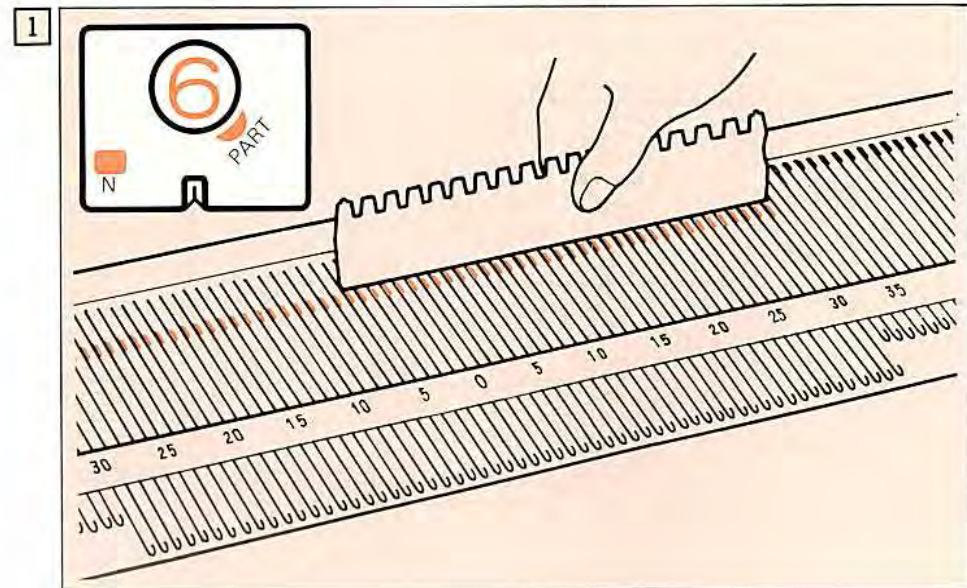

Bring forward 60 needles to position B. (30 needles on either side of the center mark "0".)

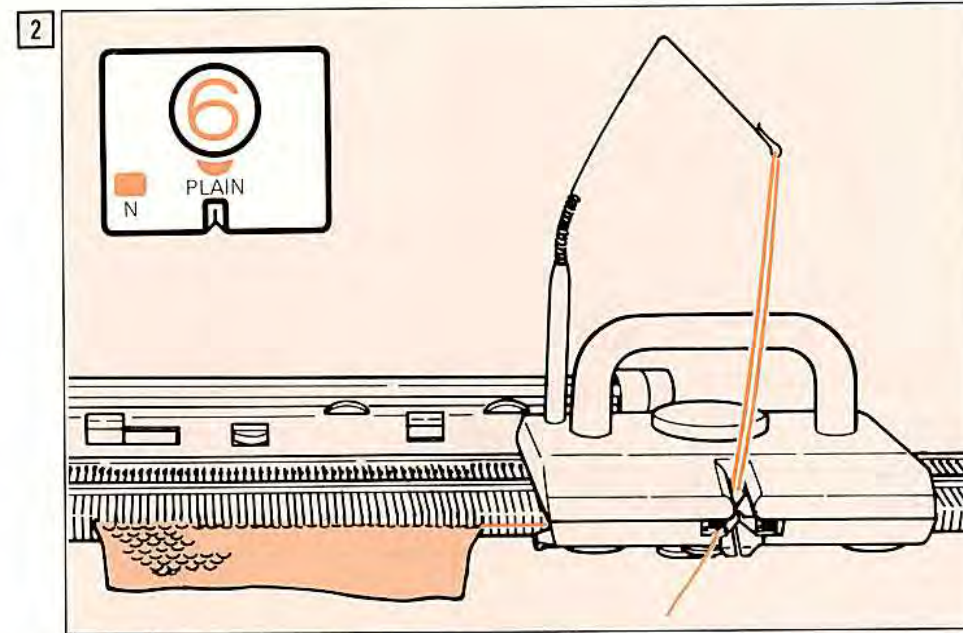

Knit several rows in plain knitting and place the carriage at the right.

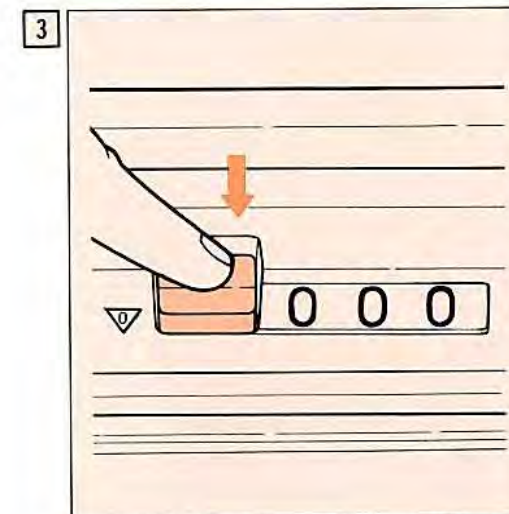

Set the row counter to the number zero.

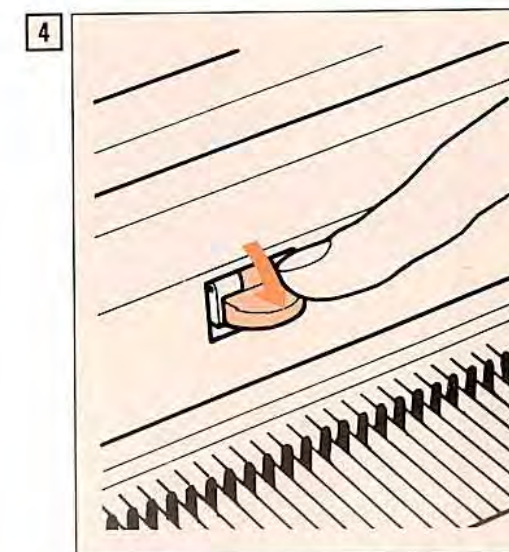

Set the feeding lever.



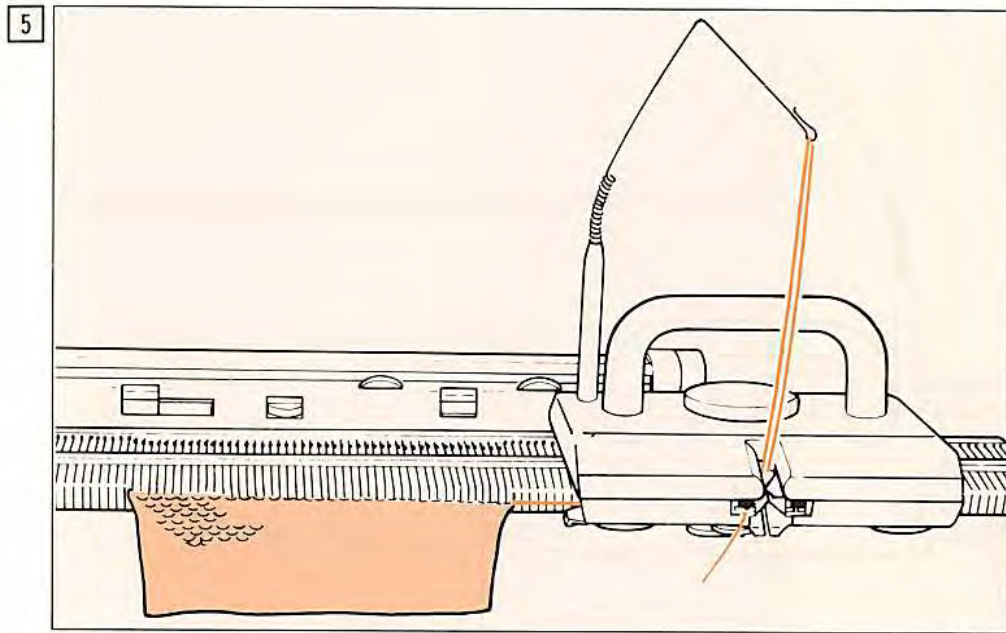

Knit 20 rows.  
The row counter shows 20.

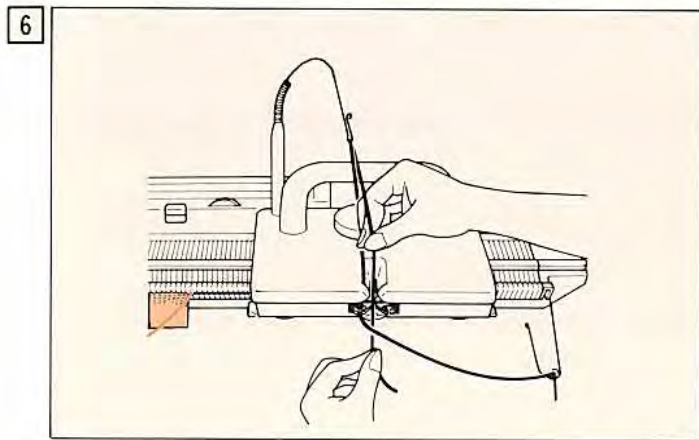

Change the yarn from the main yarn to different colour yarn.

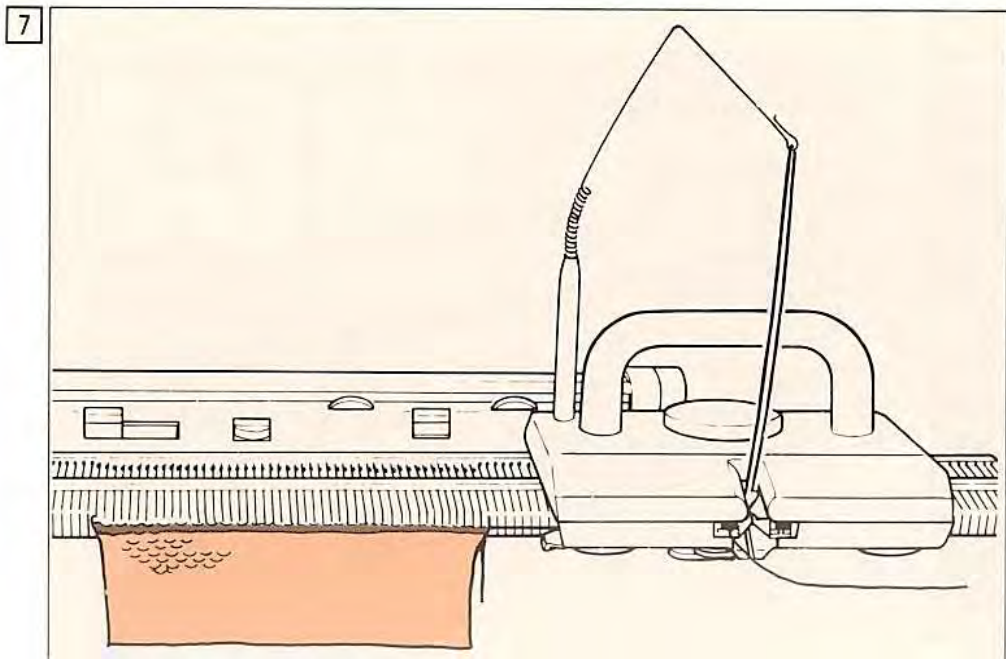

Knit 2 rows.  
The row counter shows 22.

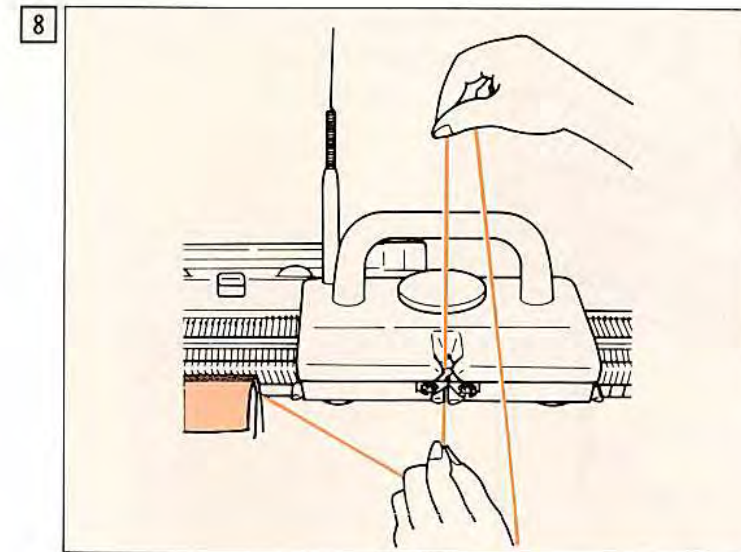

Change the yarn from the different colour yarn to the main yarn.  
(Cut the different colour yarn, then leave it about 5 cm.)

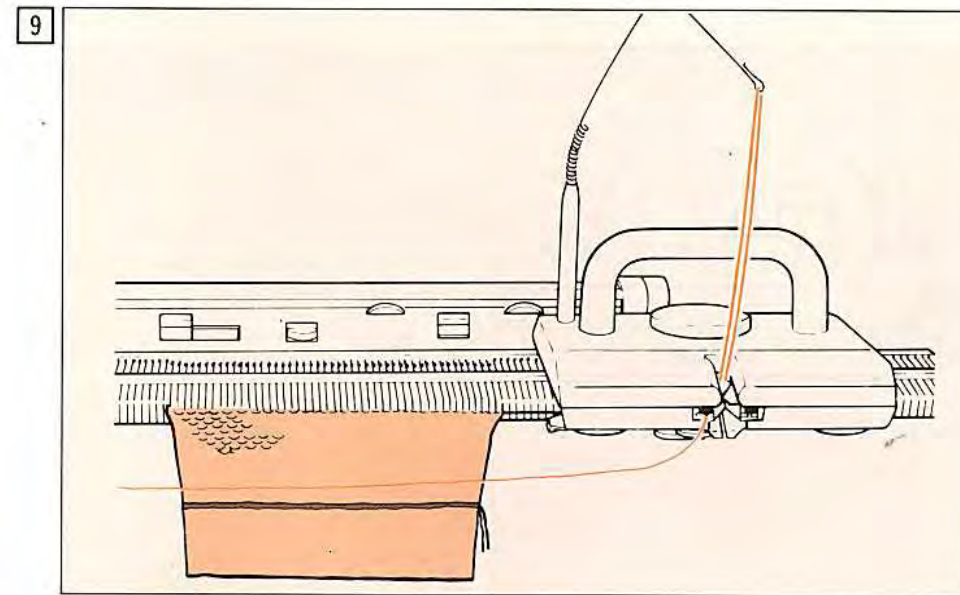

Knit 30 rows.  
The row counter shows 52.

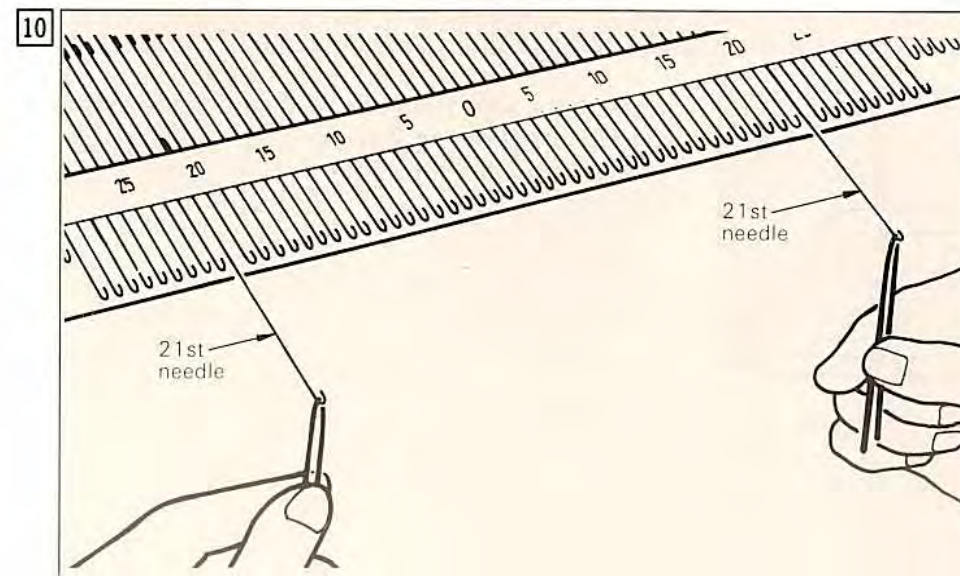

Bring forward both 21st needles from the center to position E.  
Hook the different colour yarn into the hooks of these two needles.



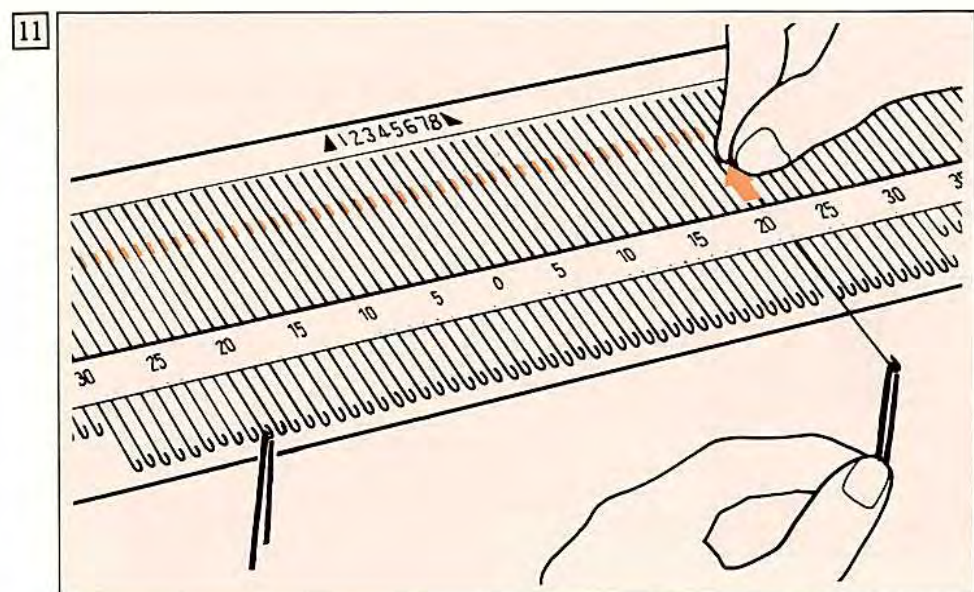

Return these two needles to position B and make stitches.

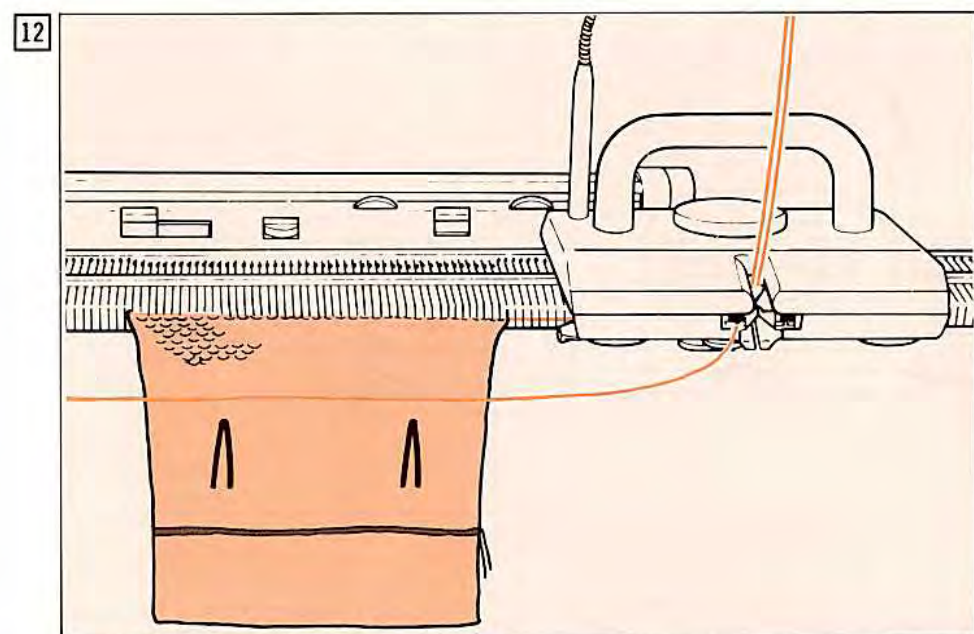

Knit another 30 rows.  
The row counter shows 82.

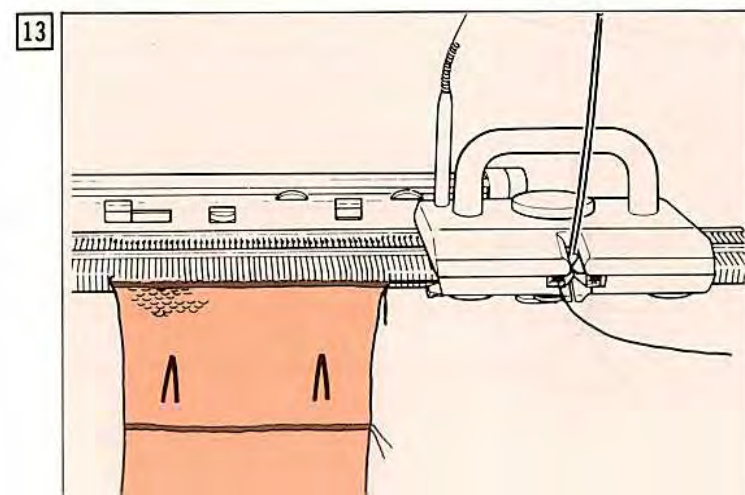

Change the yarn from the main yarn to the different colour yarn and knit 2 rows.  
The row counter shows 84.

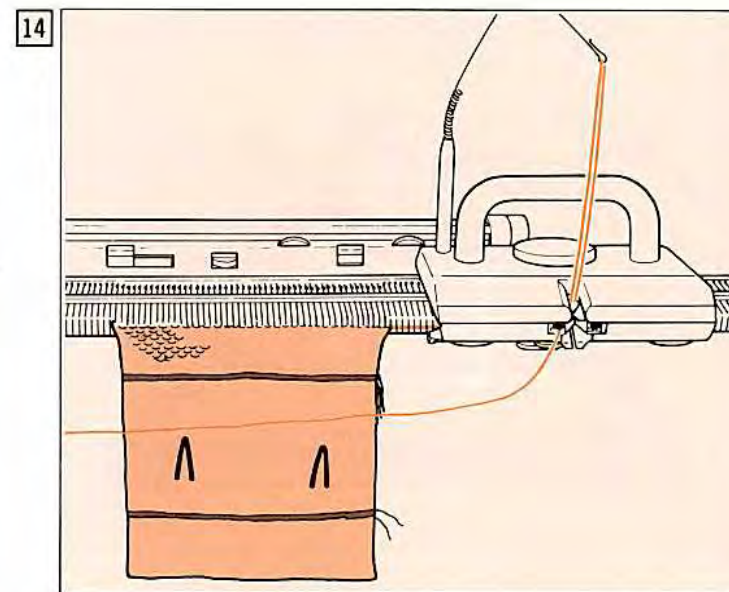

Change the yarn from the different colour yarn to the main yarn and knit 20 rows.  
The row counter shows 104.

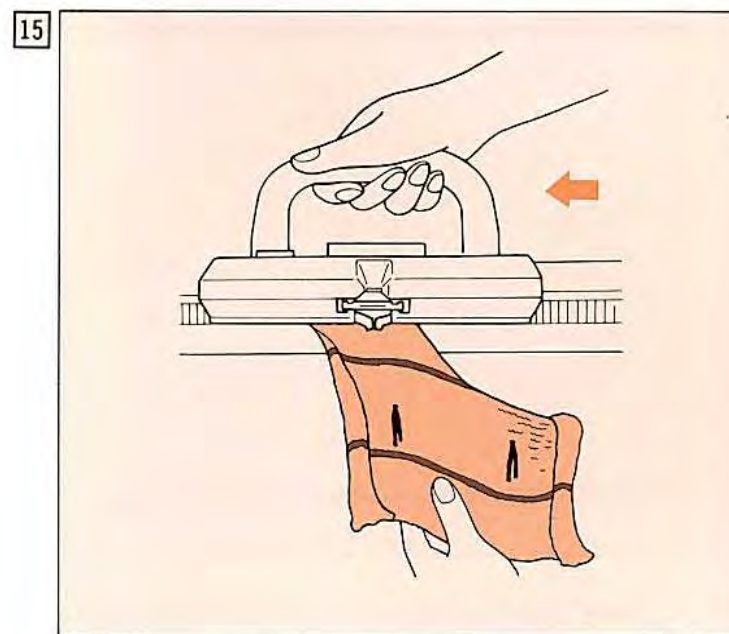

Take off the main yarn from the yarn feeder and move the carriage to remove the knitting swatch from the machine.



### 3 How to measure the tension swatch

This swatch is in a stretched condition right after it has been knitted and must to be restored to its natural state.

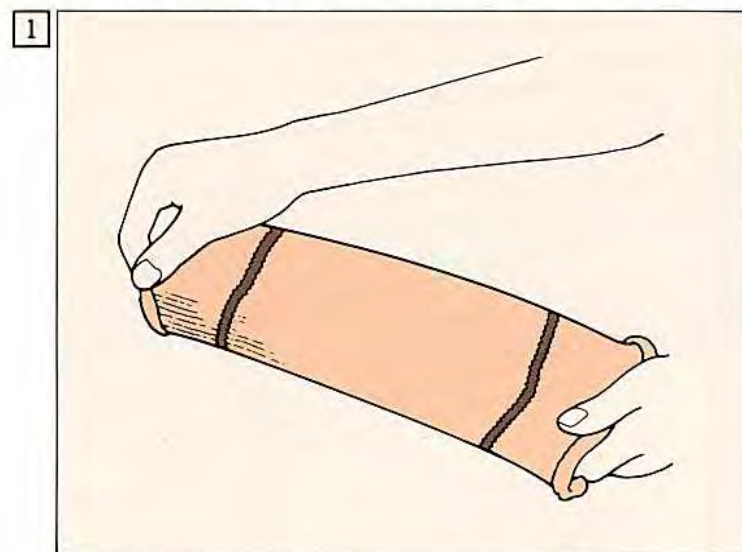

Stretch the swatch lengthwise 2 or 3 times.

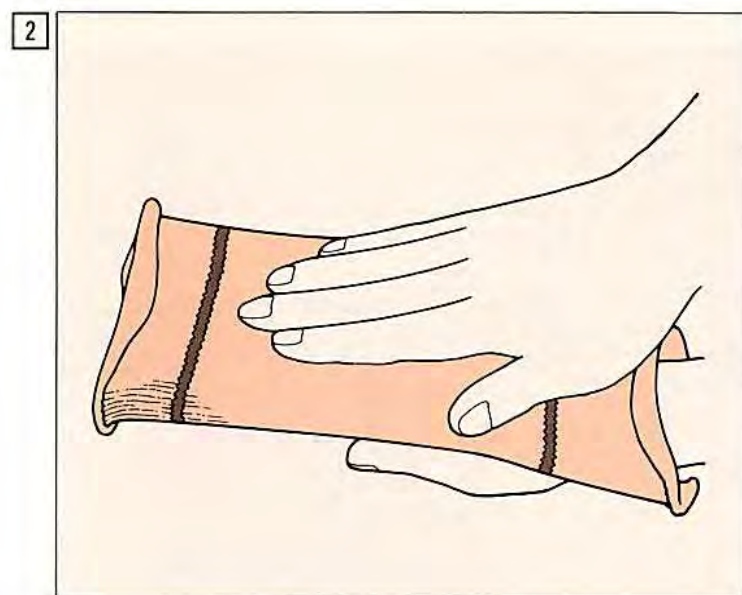

Pat lightly with your hands to restore the stretched stitches.

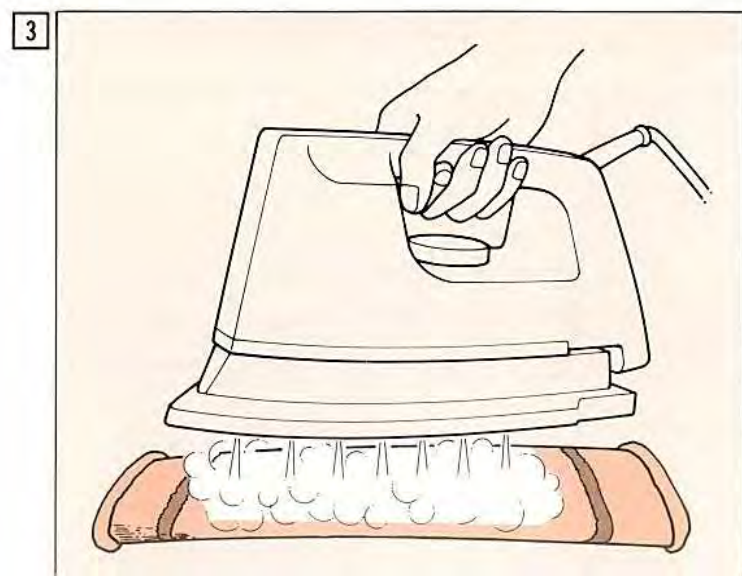

Apply steam to the swatch with a steam iron for a few minutes.

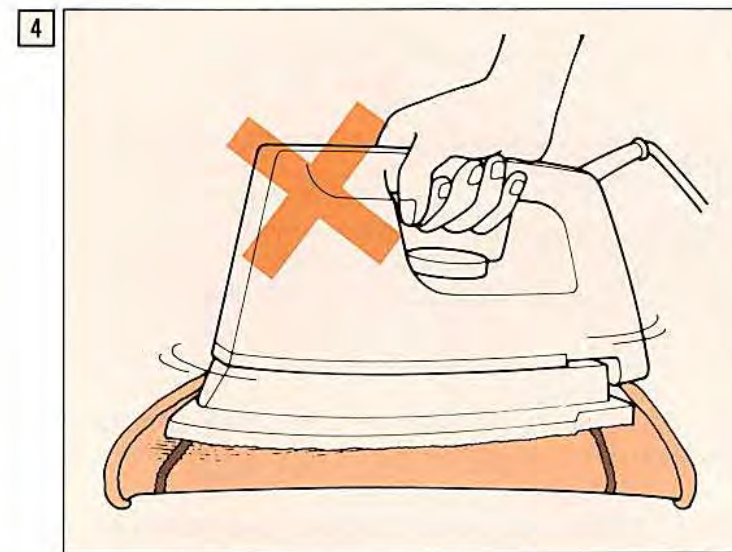

Do not iron the swatch strongly.

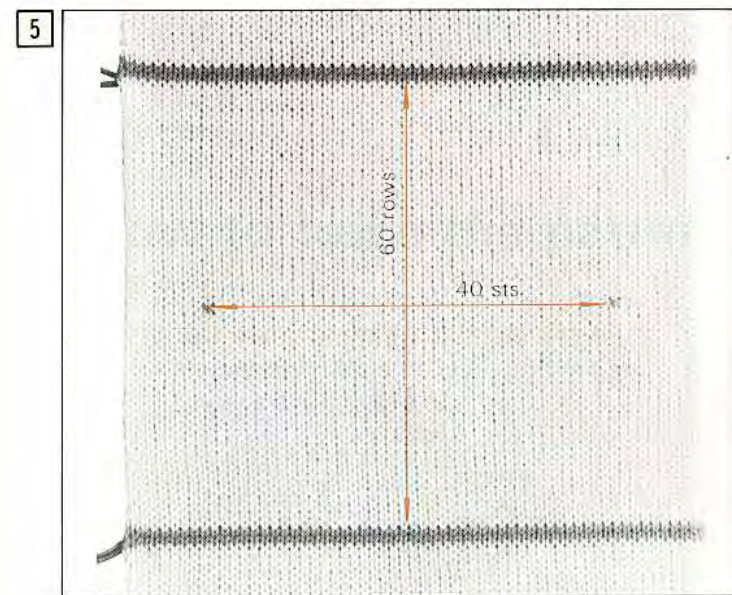

Leave the swatch for 5—10 minutes after applied steam to it and take the measure.

1. Measure the length of 60 rows.  
(inside of the different colour yarn)
2. Measure the width of 40 stitches.  
(inside of the 2 different colour stitches)

For swatches of cotton, linen and synthetic fiber yarn, more accurate measurements will be obtained if the swatch is soaked in water, squeeze lightly and dried before taking measurement.

For better accuracy, it is preferable to take the above-mentioned measurements at 3 different places on the swatch and use the average figure.



# HOW TO USE THE KNIT-LEADER

## 1 How to set the gauge dial (12 cm 4mm for 60 rows)

- \*The length (60 rows) is set by the gauge dial.
- \*The width (40 stitches) is set by the stitch measure scale.
- \*Suppose a swatch measurements 12 cm 4 mm for 60 rows and 12 cm 2 mm for 40 stitches.

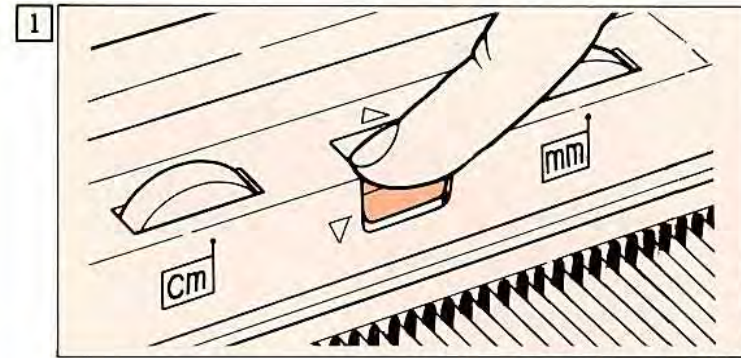

Push down the clutch button to lock.

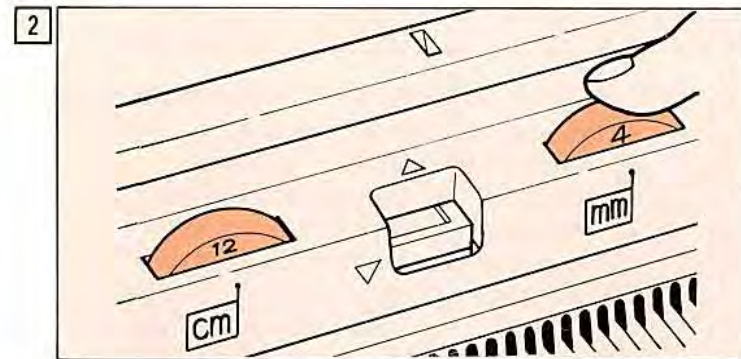

Set the gauge dial CM to 12 and MM to 4.

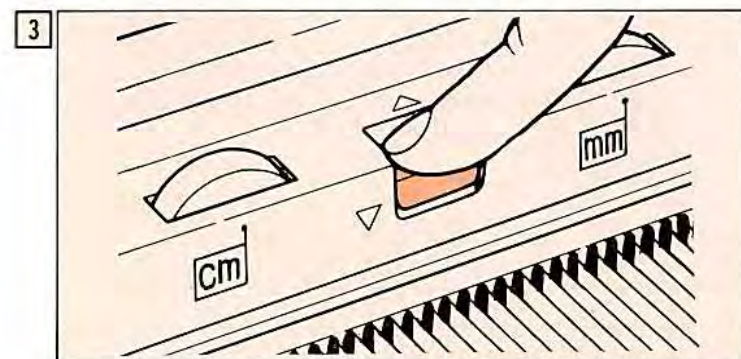

Push the clutch button to release the lock and set the feeding lever to working position.

## 2 How to set the stitch measure scale (12 cm 2 mm for 40 stitches)

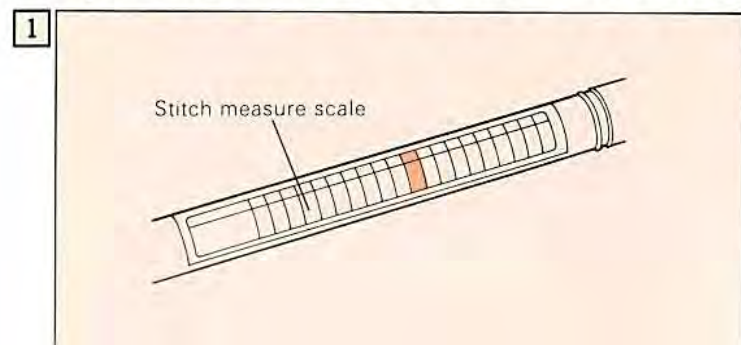

Refer to the stitch measure scale table on the sheet case.  
For 122 mm (12.2 cm), see the column which shows the figure 122. You can see that 122 mm (12.2 cm) belongs to "No. 11 of yellow".

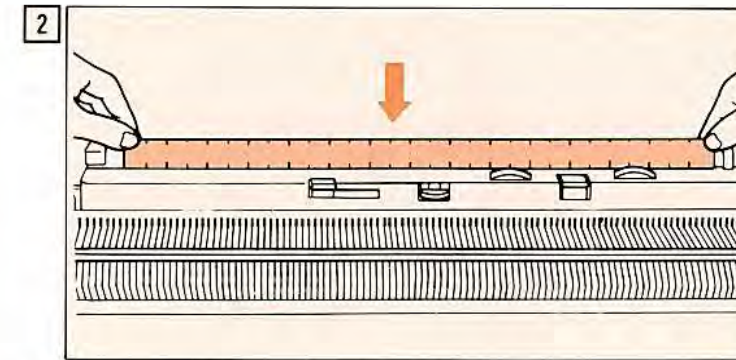

Take out No. 11 stitch measure scale.  
(There are 2 kinds of scales, center datum line and R,L datum line. Select it according to the pattern.)

3 Insert the scale in the slit as shown in the figure.  
(Set the R datum line to the right side, the L datum line to the left side.)

## 3 How to trace the pattern



Select a pattern from Home Knitting Pattern Vol. 1, 2, 3 and 4 (that are available separately) or any suitable sewing pattern, and place it on the table.



Take a sheet out of the sheet case and place it over the pattern as shown in the figure.



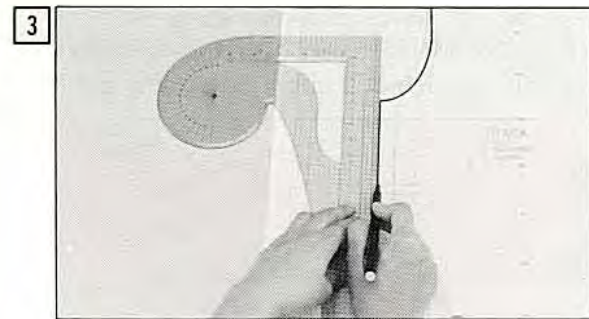

3 Trace the pattern with the felt pen which is included in the sheet case.

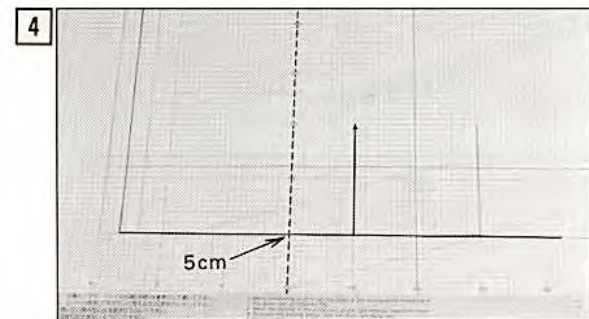

4 The drawing should start with a reference line 5 cm above the bottom.

There are 3 different datum line which is Center, Right or Left on the sheet, select the datum line on the sheet according to the pattern.



(Center datum line)

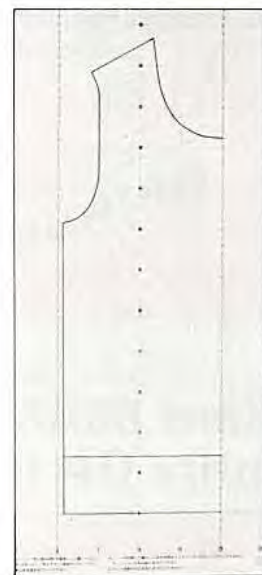

(R datum line)



(L datum line)



When tracing several patterns on the same sheet, it is advisable to use felt pens of different colour.

If you make mistake in tracing, you can wipe the sheet with damp cloth. Wait until the Sheet is dry before redrawing lines.

## 4 How to set the sheet

The \* marked item should be done when a swatch hangs on the machine.

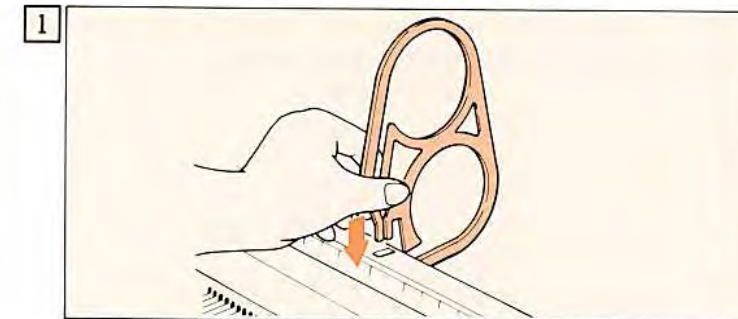

1 Insert the sheet guides into the slots at the back of the machine.

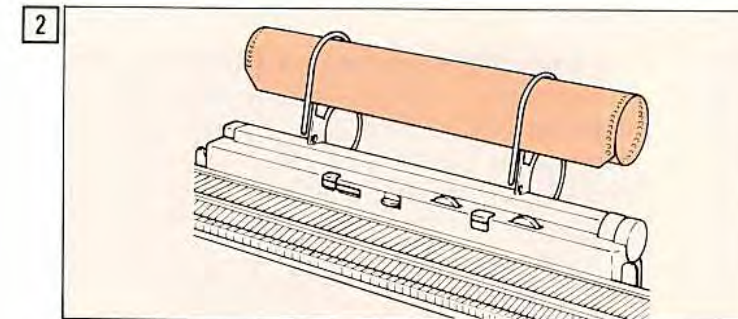

2 Insert the sheet into the sheet guides as shown in the figure.

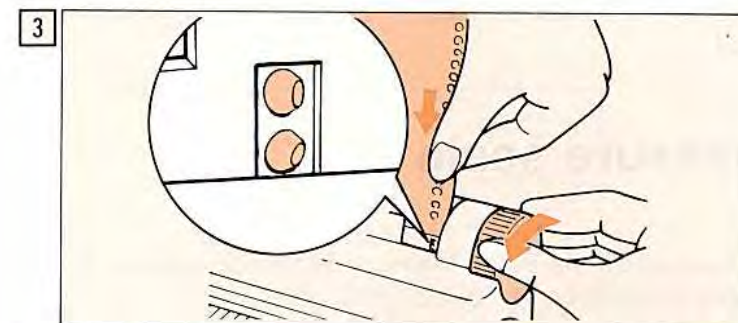

3 Insert the right end of the sheet into the slit as shown in the figure. Hold the right end of the sheet with your hand and fit the sheet's perforations over the teeth of the right feed wheel with turning the feeding dial.

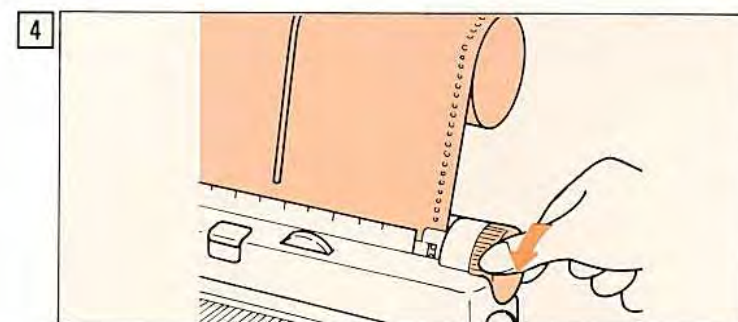

4 Turn the feeding dial a few pitches.

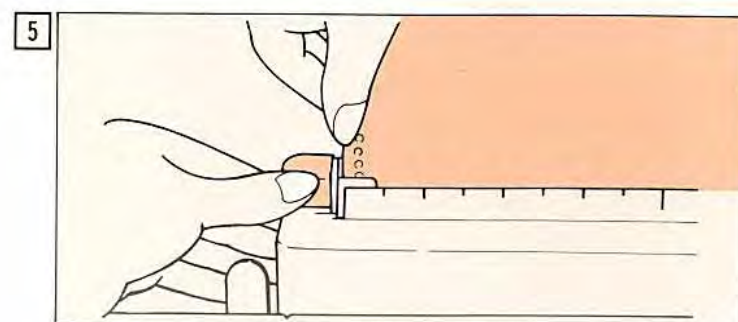

5 Move the left end of the sheet down with pushing the sheet lever to correct inclination of the sheet.



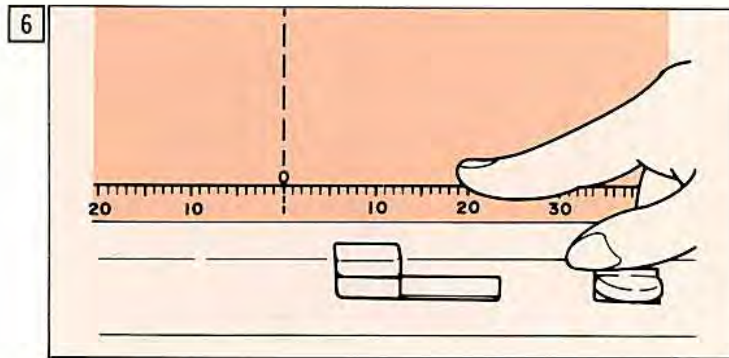

Put the stitch measure scale upon the datum line of the sheet as shown in the figure.

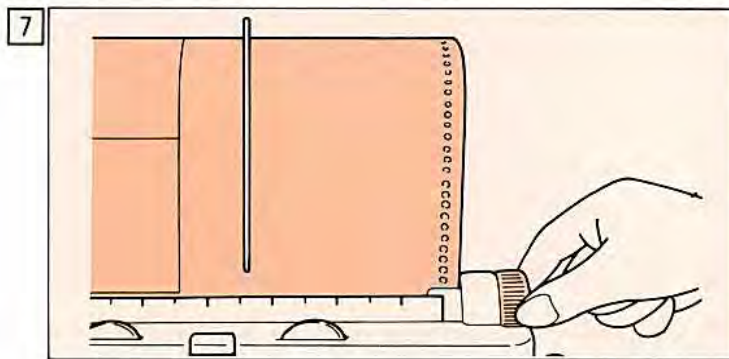

Turn the feed dial and set the starting line as shown in the figure.  
 \*(If you started knitting already, set the sheet to the marked line.)  
 \*(Set the row counter after setting the sheet.)

## 5 How to read the stitch measure scale

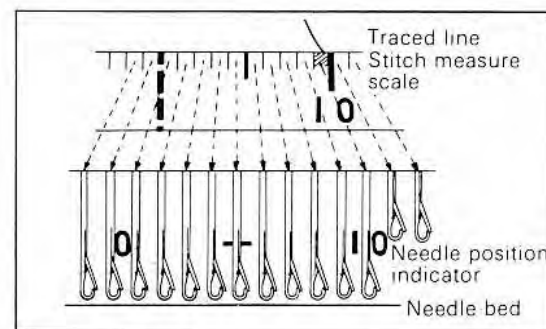

The number on the Stitch Measure Scale corresponds to the number on the Needle Position Indicator. Namely, the number on the Stitch Measure Scale corresponds to the number of the needles.

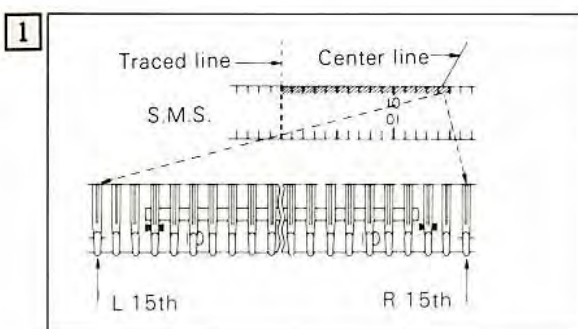

Increasing the stitch when the line traced on the sheet goes over to higher graduation.

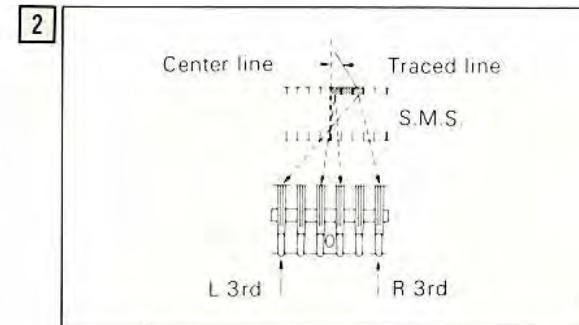

Decreasing the stitch when the line traced on the sheet goes over to lower graduation.

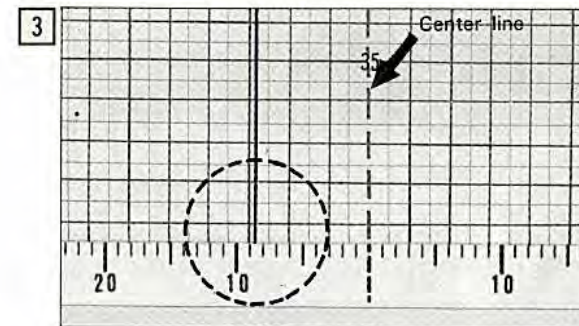

If the line traced on the sheet falls somewhere between graduations on the Stitch Measure Scale take the higher graduation.

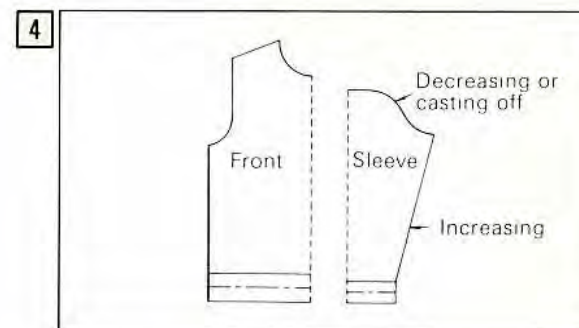

If the only half of pattern is traced on the sheet, do not forget to increase or decrease the stitches on the other side.



# MAKING GARMENTS

## 1 How to use the transfer tool and the latch tool

Transfer tools

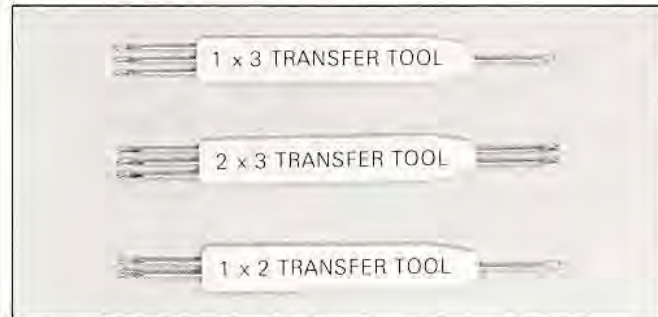

How to hold the transfer tool.

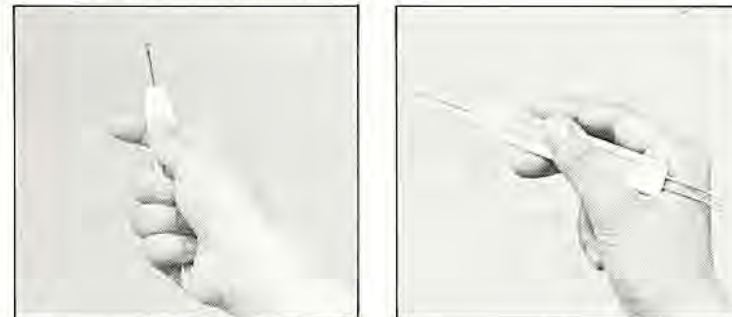

Decreasing stitches with Transfer Tool.

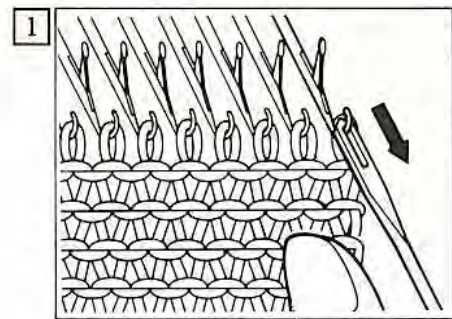

1 Hook the eye of the TRANSFER TOOL on the hook of the needle and pull it toward you.

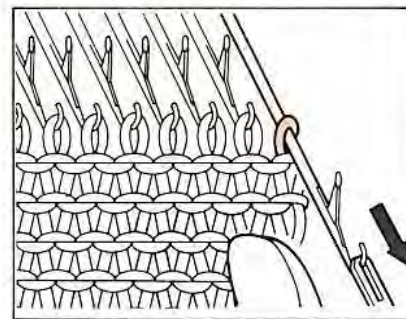

2 Hold your other hand against the knitting so that it will not be brought forward. The stitch in the hook of the needle will slide behind the latch and onto the stem of the needle.

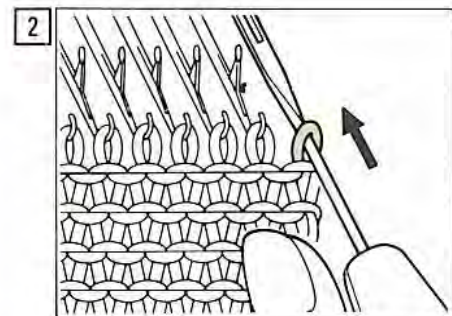

3 Hold the transfer tool parallel with the needle and push it all the way back until the stitch is transferred onto the TRANSFER TOOL.

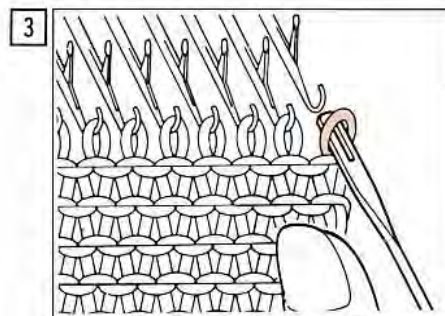

4 Remove the TRANSFER TOOL from the hook of the needle taking care not to drop the stitch from the TRANSFER TOOL.

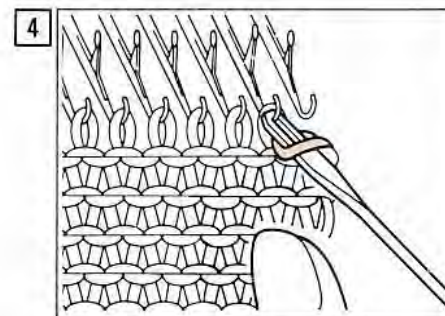

5 Hook the transfer tool onto the hook of the adjacent needle.

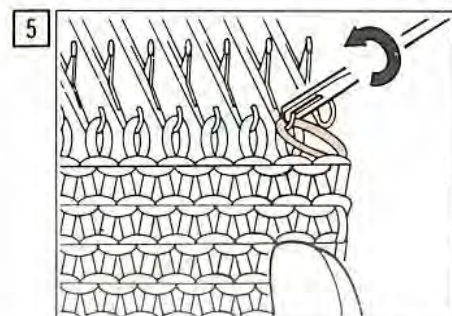

6 Transfer the stitch from the transfer tool onto the hook of the

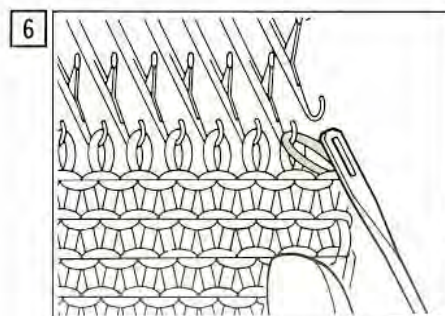

7 Remove the transfer tool from the hook of the needle and return the empty needle to position A.

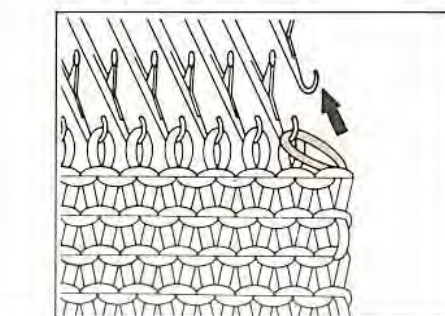

Latch tool



How to hold the latch tool.

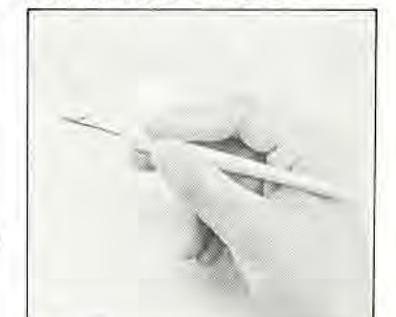

Ribbing with the Latch Tool.

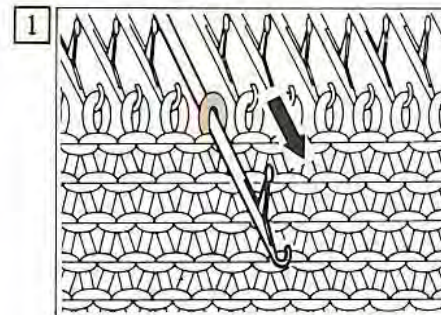

1 Bring one needle forward to position E by hand and return it to position A.

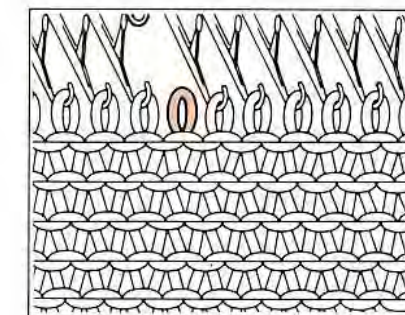

2 One stitch has been dropped from the hook of the needle.

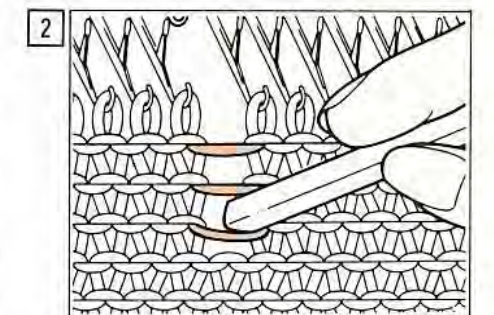

3 Using the tip of LATCH TOOL, unravel knitting.

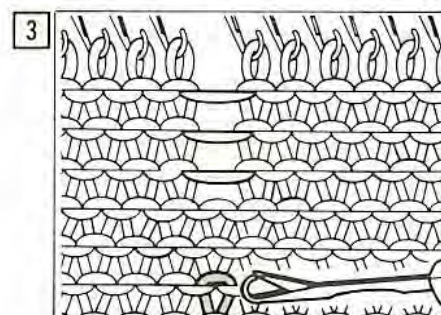

4 Drop the stitch in the line you wish to rib to a few rows above where you are to start ribbing. Then place the LATCH TOOL in the stitch where you wish to start ribbing.

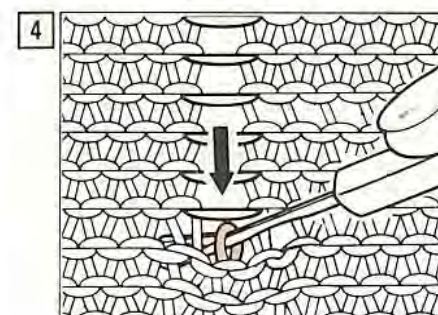

5 Depress the LATCH TOOL to drop the last few stitches. The stitch is on the stem of the latch tool.

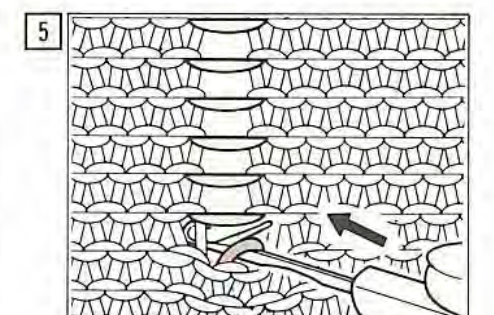

6 Hold the knitting firmly. Push the LATCH TOOL away from you until the stitch on the latch tool is behind the latch.

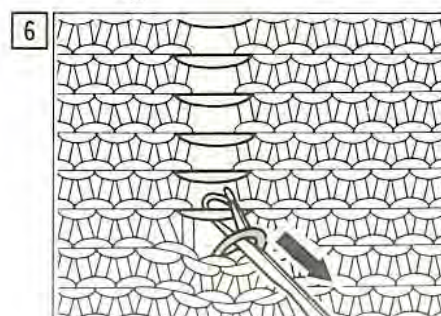

7 Catch the next parallel thread with the hook of the latch tool

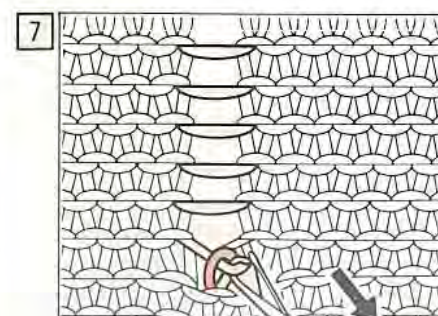

8 The latch will close with the new yarn in the hook. Pull this new

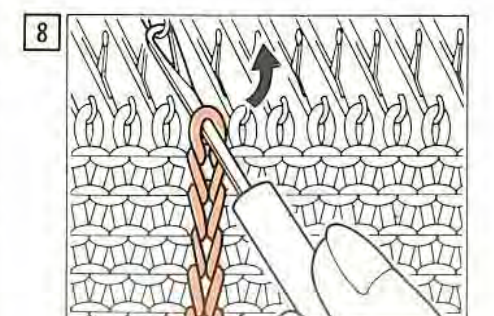

9 Repeat this until you reach the top, and hook the last stitch on



## 2 Increasing and decreasing stitches

### Increasing stitches

Increasing one stitch at either edge of the knitting. Simple method.

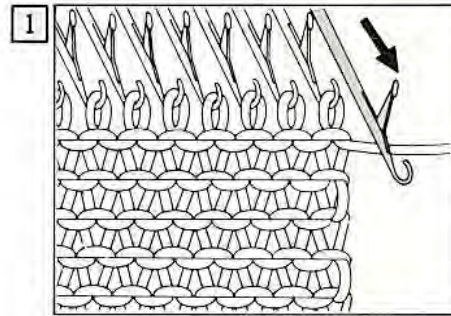

1 On the carriage side, push one needle into working position B from position A.

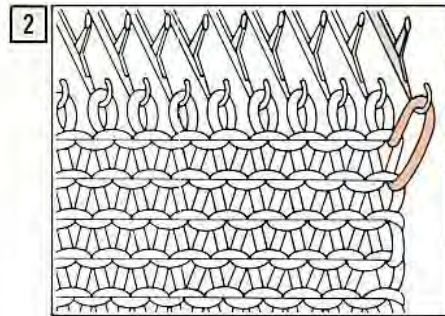

2 Operate the carriage and knit one row. The empty needle will pick up the yarn.

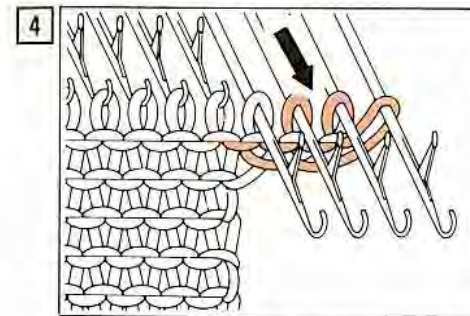

4 Push the needles with the increased stitches to position E and knit one row.

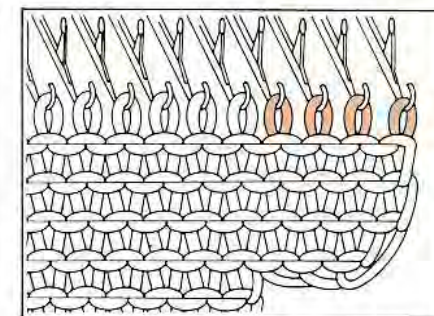

Repeat the two or three rows, and then continue to knit.

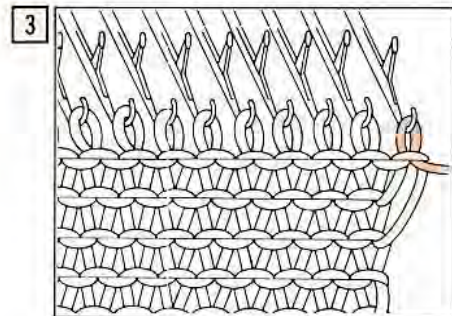

3 Knit another row. You have increased one stitch.

Increasing one stitch at either edge of the knitting. Full fashioned method.

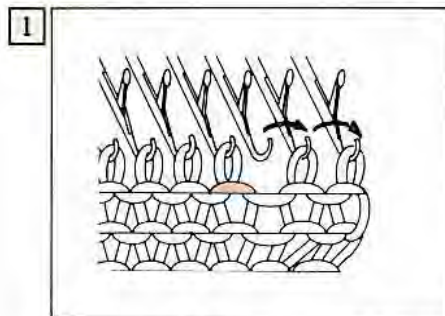

1 Using the 1 x 2 TRANSFER TOOL move the stitches out one needle so that the third needle from the end becomes empty.

### Decreasing stitches.

Decreasing one stitch at either edge of the knitting. Simple method.

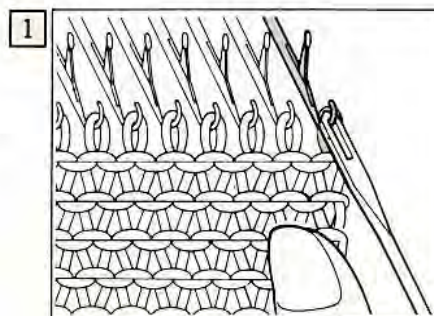

1 Hook the EYE of the TRANSFER TOOL on the hook of the needle, then pull it toward you. Hold your other hand against the knitting so that it is not brought forward.

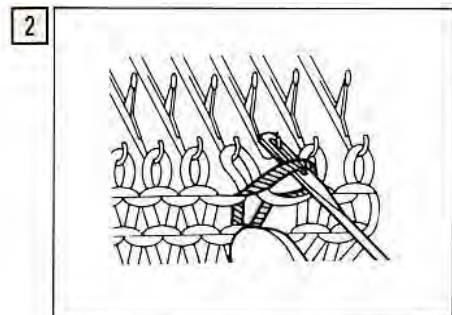
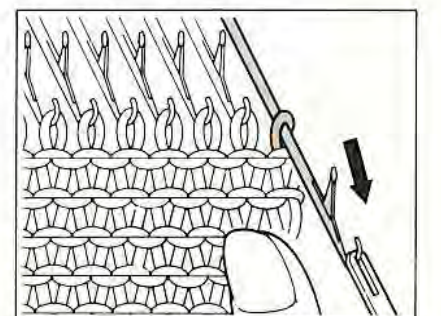

2 To fill in the empty needle pick up the purl side of either adjacent stitch on the lower row.

Increasing several stitches at either edge of the knitting

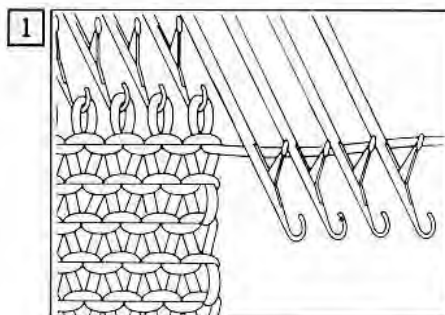

1 On the carriage side, push the needles to be increased to position E from A.

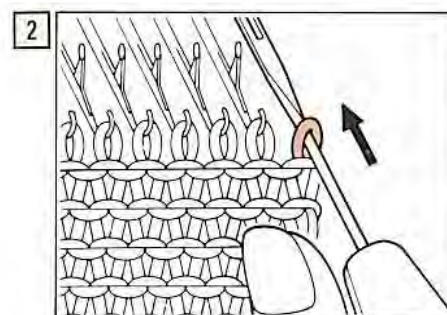

2 Hold the TRANSFER TOOL parallel with the needles and push it all the way back. Then the stitch will be transferred to the TRANSFER TOOL.

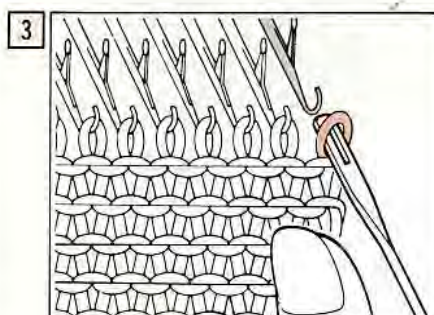

3 Remove the TRANSFER TOOL from the hook of the needle taking care not to drop the stitch from the TRANSFER TOOL.

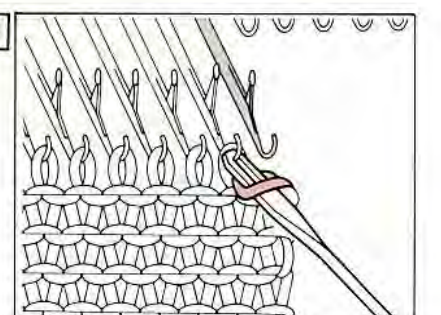

4 Hook the transfer tool on the hook of the adjacent needle.

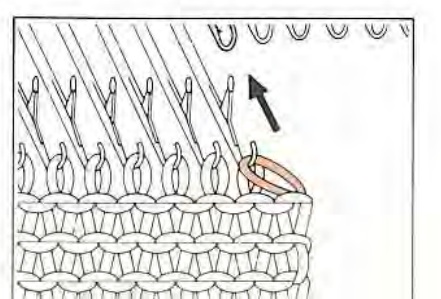
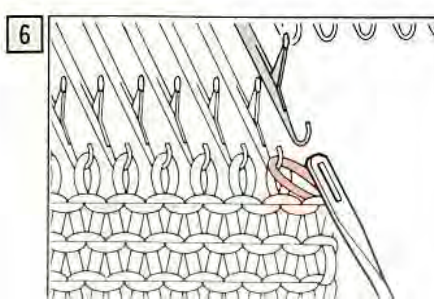
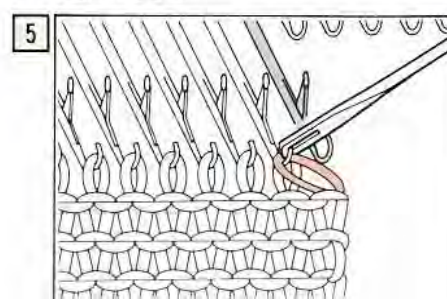
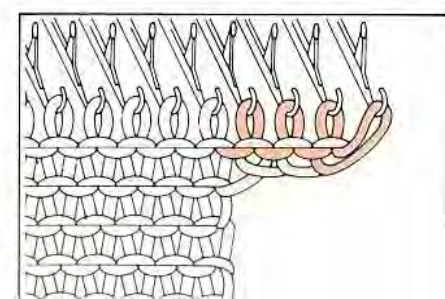
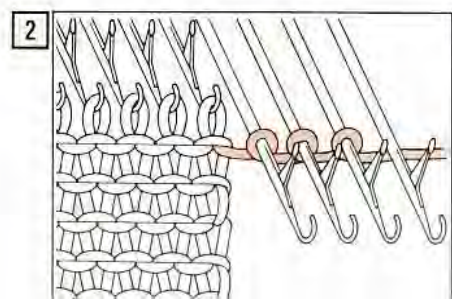



Decreasing one stitch at either edge of the knitting. Full fashioned method.

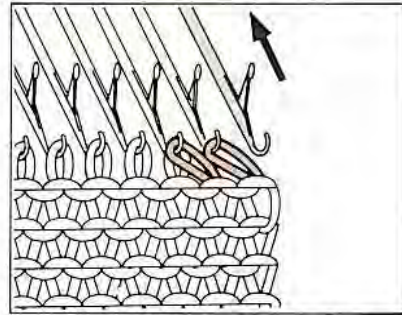

Use the 1 x 2 TRANSFER TOOL to transfer two stitches at the end to the inside needles, and place empty needle out of action to position A.

Decreasing several stitches at either side of the knitting.

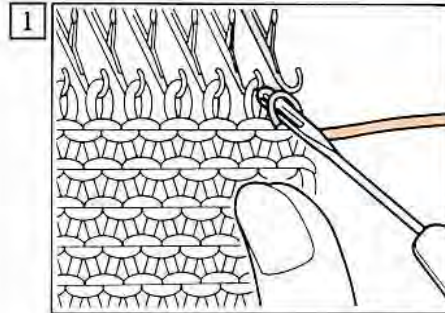

1 On the same side as the CARRIAGE, transfer the end stitch to the 2nd needle.

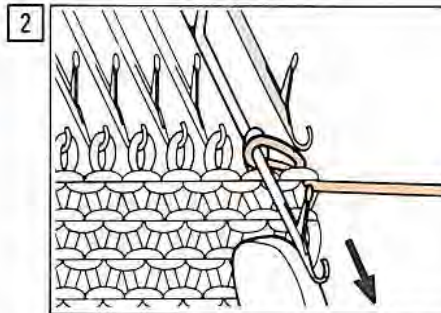

2 Bring forward the needle with the two stitches so that the stitches fall behind the needle latch.

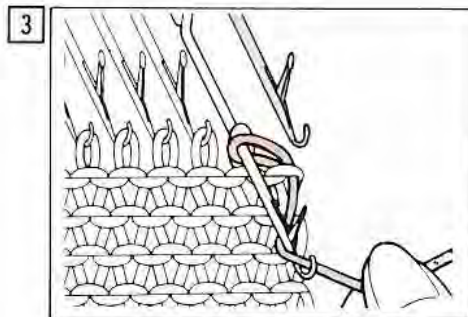

3 Place the yarn in the needle hook, in front of the latch and push the needle back manually to form a single stitch.

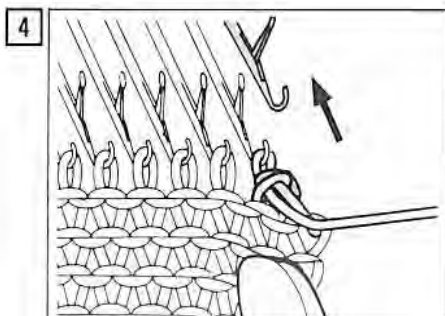
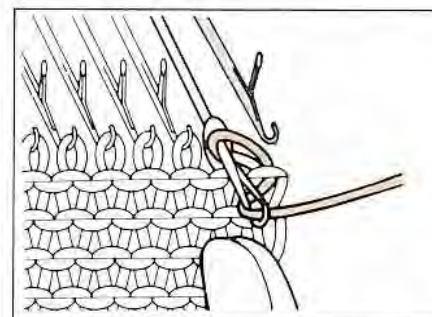

4 Return the empty needle to position A.

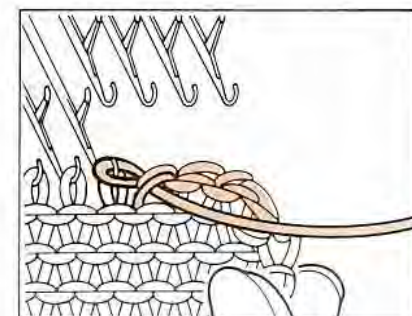

Repeat this process for each stitch. Take care not to make the stitches too tight. When you

### 3 Picking up dropped stitches

Repairing a dropped stitch

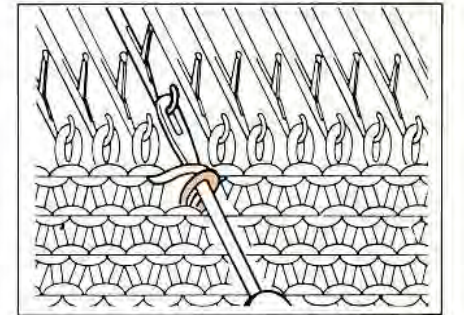
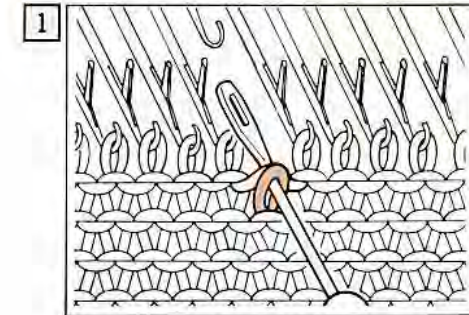

1 Using a TRANSFER TOOL, pick up the stitch (the row below the dropped stitch) and the unknitted yarn and put both of them on the empty needle.

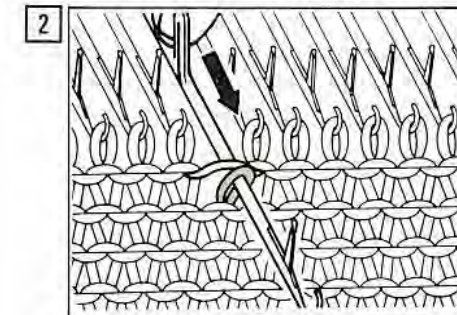
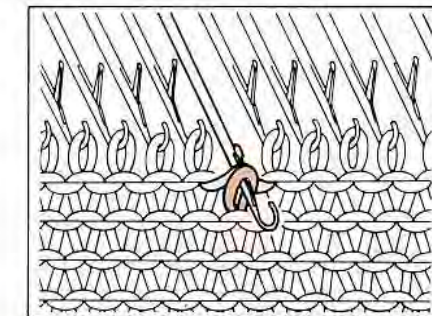

2 Push the needle to position E. Stitch and unknitted yarn are now behind the latch.

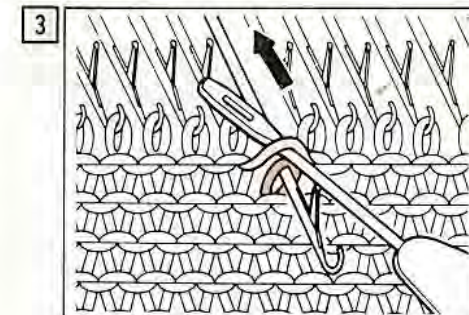

3 Push the needle back until stitch is just behind the latch. Using a TRANSFER TOOL, catch the unknitted yarn into the hook of the needle.

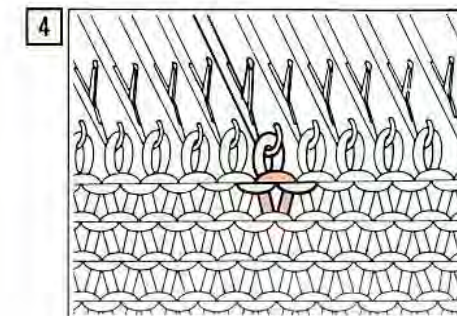
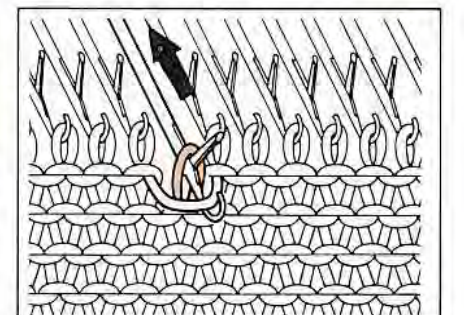

4 Then return the needle to position B, pulling the yarn in the



Repairing a stitch that has dropped several rows.

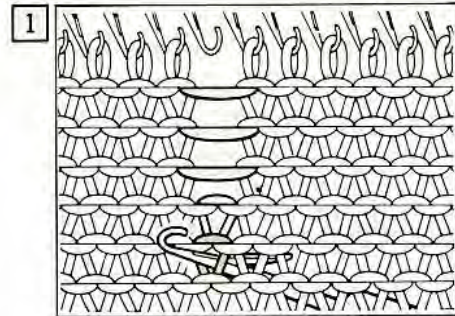

1 Insert the latch tool from behind knitting through the last stitch that has not dropped.

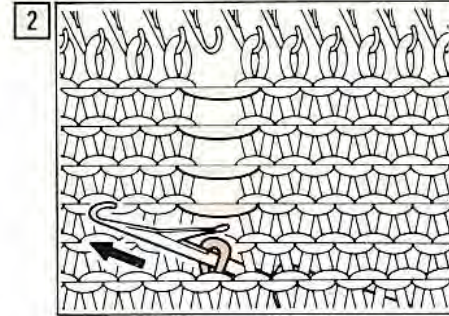

2 Push the latch tool towards you pulling slightly down on knitting so that the stitch comes behind the latch.

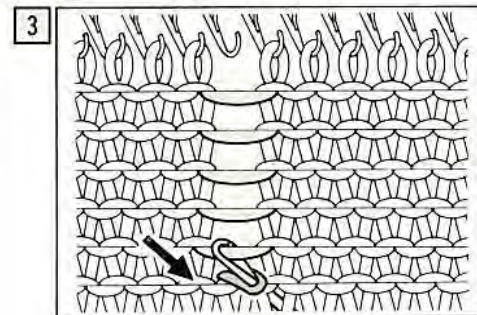

3 Catch the next cross thread into the hook and pull back the LATCH TOOL through the stitch on the stem. There is now one stitch.

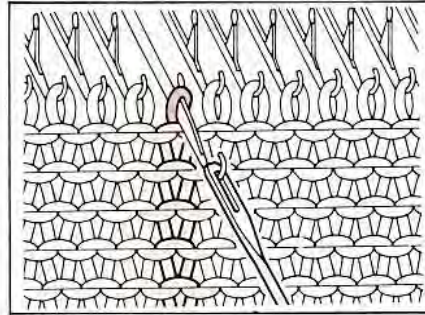
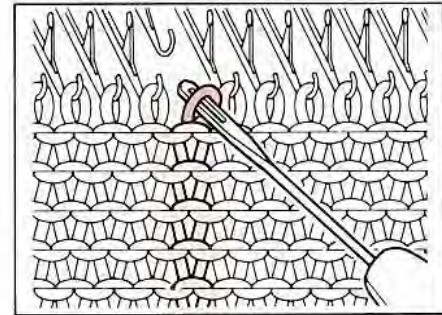
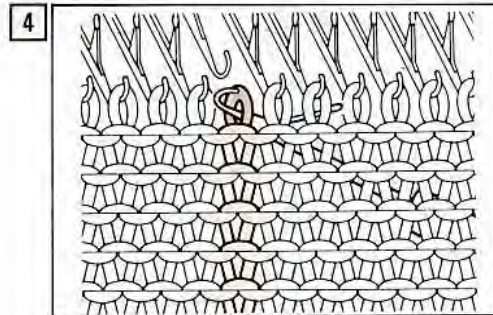
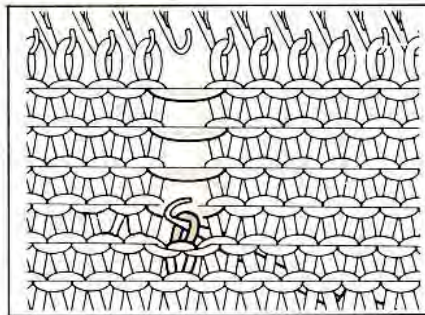

4 Repeat this until you reach the top. Pull the last stitch rather tight to make a bigger loop. Insert the transfer tool into the loop from the front. Carefully remove this stitch from the latch tool and place it on the hook of the needle with your transfer tool.

## 4 How to make a hem

Plain hem



1 Using the 1/1 NEEDLE PUSHER bring forward to position E the required number of needles, after selecting an equal number of needles on either side of the center "0". Refer to the way how to cast-on and start knitting on p.p. 9 ~ 11.

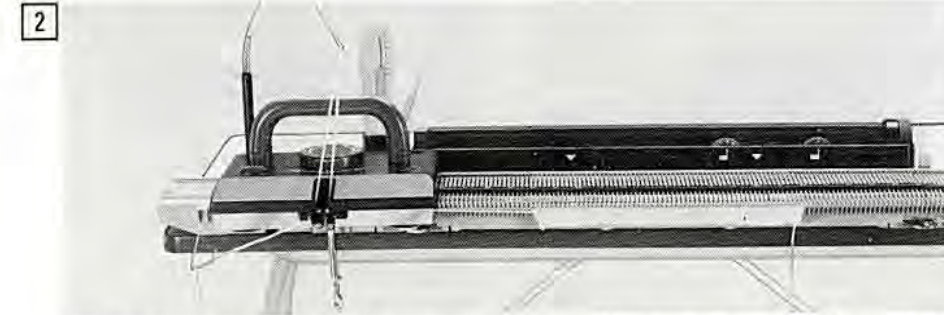

2 Knit about ten rows of plain knitting with waste yarn and put the CARRIAGE on the left side of the machine.

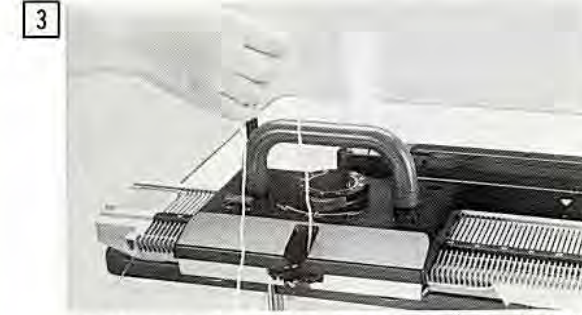

3 Pull the waste yarn out of the YARN FEEDER. Remove the CAST-ON THREAD from the accessory box.



CAST-ON THREAD

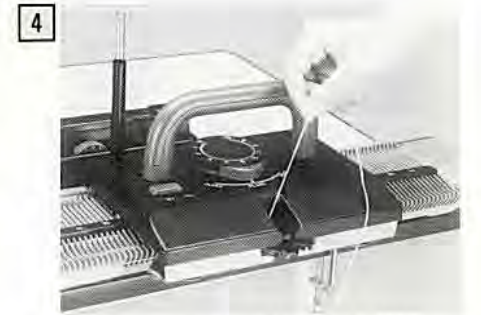
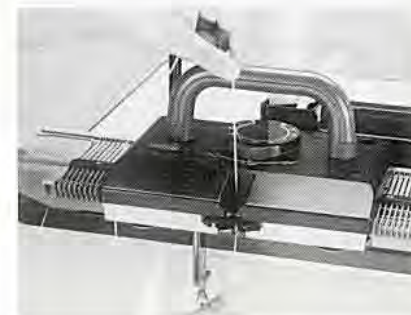



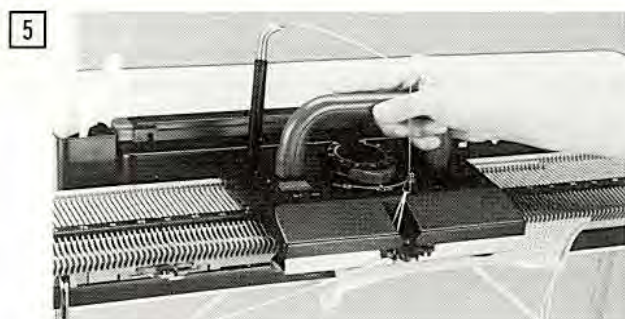

5 Knit in plain knitting with the yarn. For the first row, move the CARRIAGE holding the yarn under the YARN FEEDER with your left hand at the right edge of the knitting. Knit the number of rows required, for double the length of the hem.

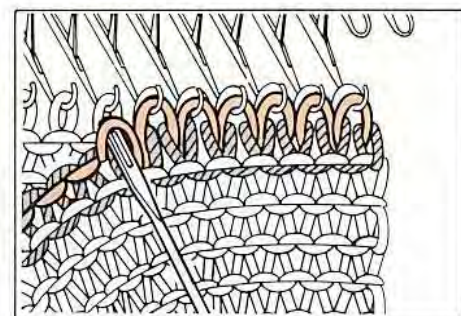
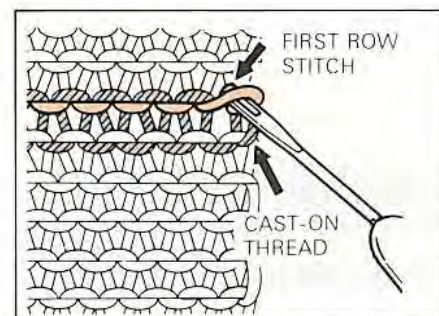

6 Pick up the first stitch of the first row where it meets the CAST-ON THREAD. Insert the TRANSFER TOOL. Hook the stitch onto the first needle. Repeat across the row.



7 After picking up all the stitches, bring all the needles forward to position E. (There will be one less stitch to be picked up than the number of the needles.)



8 Operate the carriage and continue to knit in plain knitting.



9 After knitting several rows, pull out the CAST-ON THREAD. Then the part



Picot hem



1 After knitting with waste yarn and CAST-ON THREAD, knit up to half the length of the hem.



2 Transfer every other stitch to the next needle by using the TRANSFER TOOL as shown in the figure. Be careful not to move the both end stitches. Remain them.



Align the needles (including empty needles) to position B.

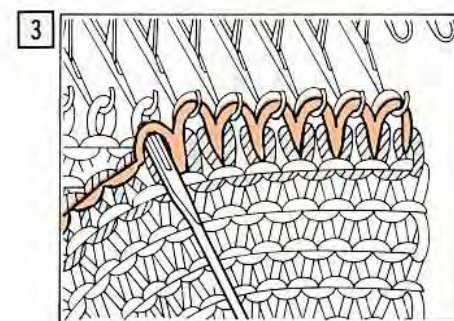

3 Knit the other half of the hem and pick up the stitches in the same way as for the PLAIN HEM. After picking all the stitches up, bring the needles to position E.



4 After knitting several rows, pull out the CAST-ON THREAD. The part knitted with waste yarn is





## 5 Binding off

### Binding off by using the tapestry needle

After finishing the knitting, bind off last row taking care not to unravel the knitting.

#### When the yarn is on the left side

1 Pull the yarn out of the YARN FEEDER. Cut the yarn leaving a length of three times the width of the knitting.

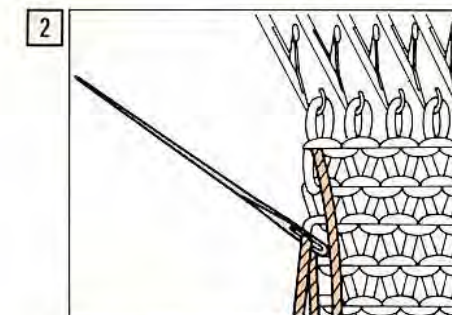

Thread the yarn into the TAPESTRY NEEDLE.

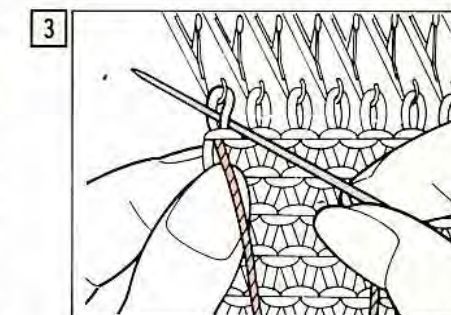

Pass the TAPESTRY NEEDLE through the left side stitch.

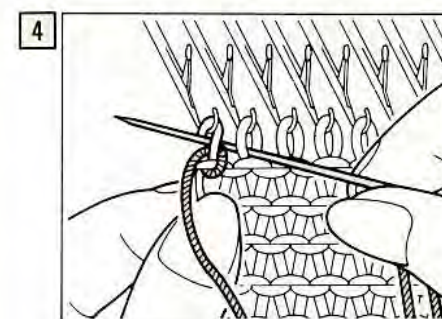

Insert the TAPESTRY NEEDLE into the second stitch from left and pass it back through the left side stitch.

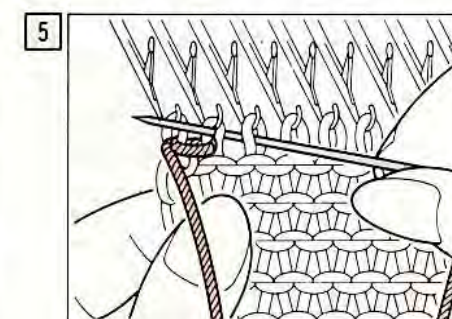

Insert the TAPESTRY NEEDLE into the third stitch from left and pass it back through the second stitch from left.

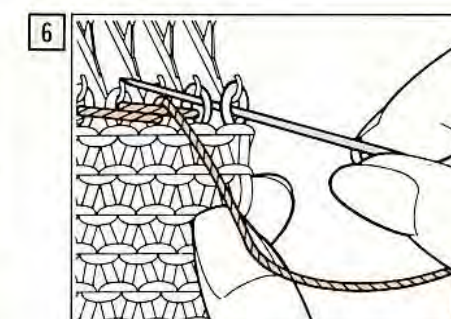

Repeat this until you reach to the right side of the knitting.



Now, the binding off is completed and the knitting switch can be removed from the machine.

### 1 x 1 Elastic hem

1 Knit a few rows with waste yarn in the same way as for plain hem.

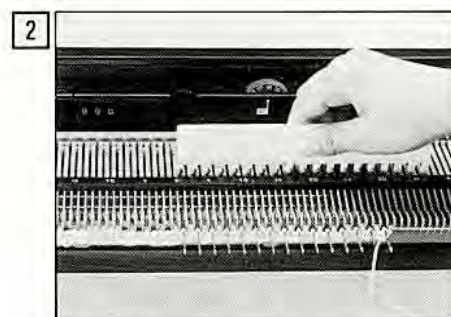

Bring every other needle to position E and return it to position A by using 1/1 needle pusher. (Dropping stitches)

3 Knit ten rows with waste yarn. (You knit every other stitch.) Then knit one row with the Cast-on thread and change the yarn.

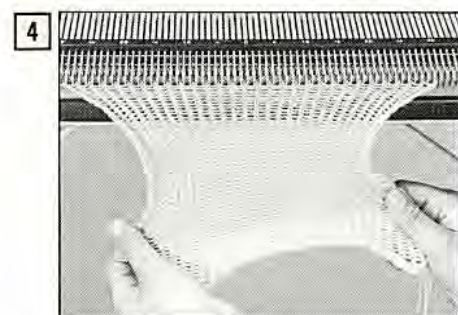

Knit the number of rows required for double the length of the hem in plain knitting with the yarn.



Bring forward the needles in position A to position B.

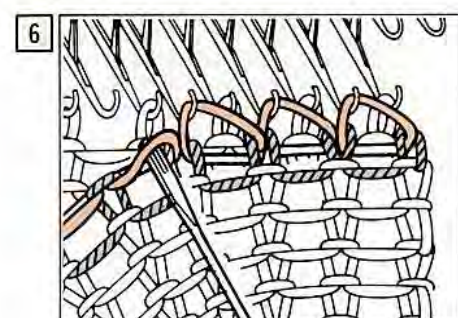

Pick up the stitches in the same way as for the plain hem and hook them onto the empty needles.



After picking up all the stitches, bring the needles to position E. Knit one row.



CAST-ON THREAD

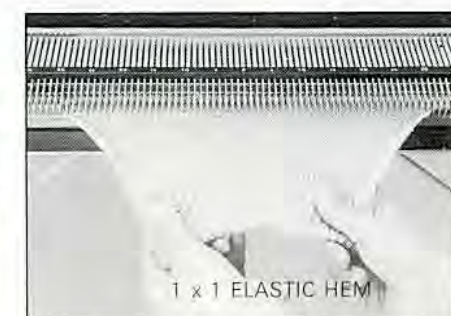

1 x 1 ELASTIC HEM



When the yarn is on the right side

1 Pull the yarn out of the YARN FEEDER. Cut the yarn leaving a length of three times the width of the knitting.

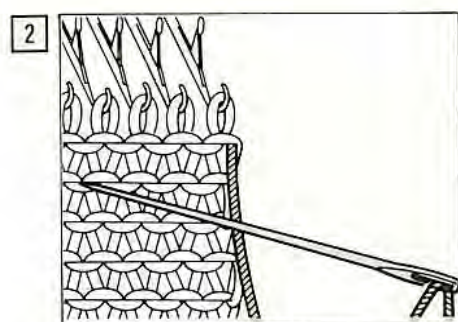

2 Thread the yarn into the TAPESTRY NEEDLE.

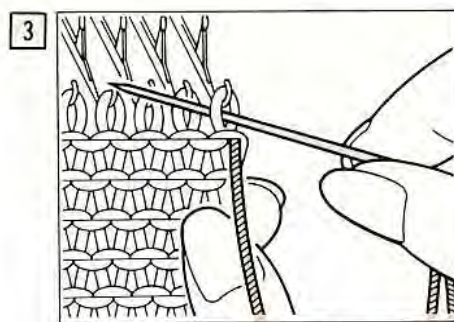

3 Pass the TAPESTRY NEEDLE through the right side stitch.

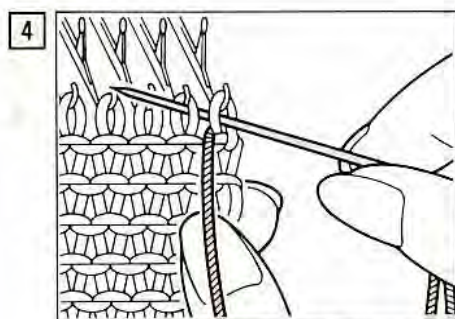

4 Insert the TAPESTRY NEEDLE into the right side stitch and pass it through the second stitch from right.

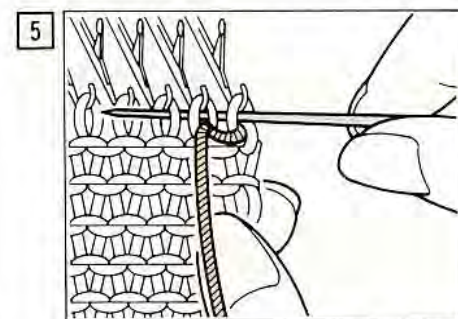

5 Insert the TAPESTRY NEEDLE into right side stitch and pass it through the third from right in the figure, making sure you pass the tapestry needle BEHIND the second stitch and enter the third stitch from behind.

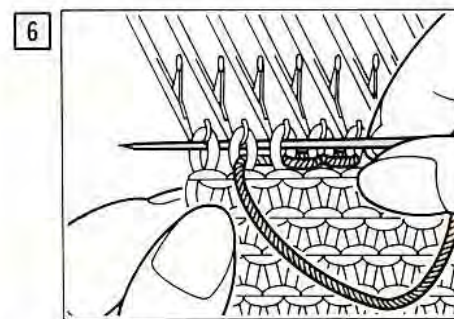

6 Repeat this until you reach the left side of the knitting.

7 Now, the binding off is completed.

Cast-off using the latch tool

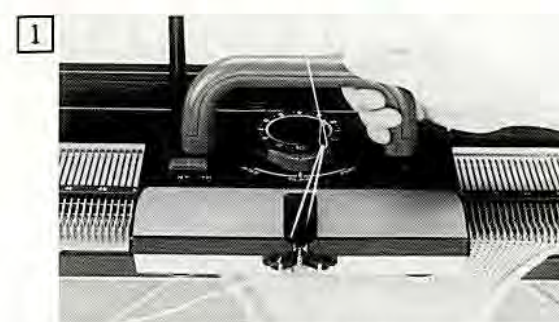

1 Loosen the TENSION DIAL and knit the last row. (For example, when you knit with tension dial number 4—6, set the number to 9—10.)

2 Place the carriage on the left side of the machine.



3 Bring the needles forward to position E.

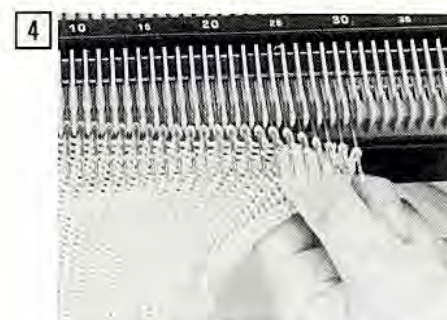

4 Bring the knitting toward you taking care not to drop the stitches.

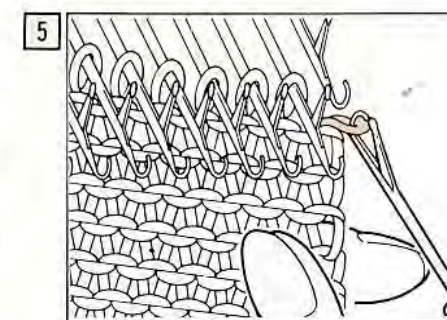

5 Hook the right side stitch on the hook of the LATCH TOOL.

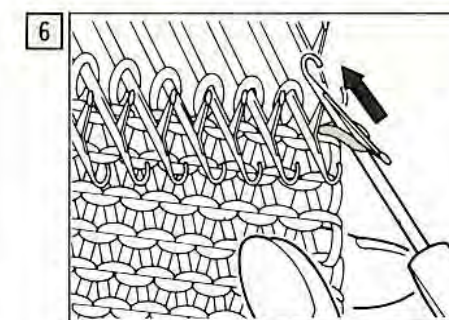

6 Make the stitch fall behind the latch of LATCH TOOL.

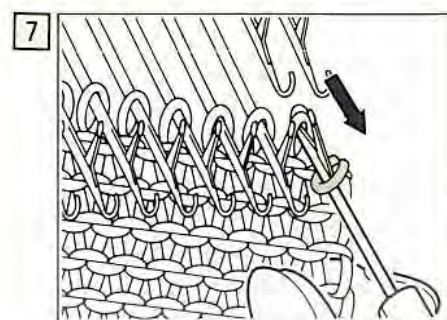

7 Then hook the second stitch from the right in the hook of the

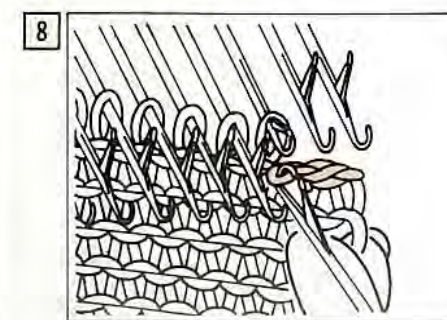

8 Pull the LATCH TOOL and make a new stitch (with the stitch over

Take care not to drop the other stitches from the needles.



## 6 How to make a button hole

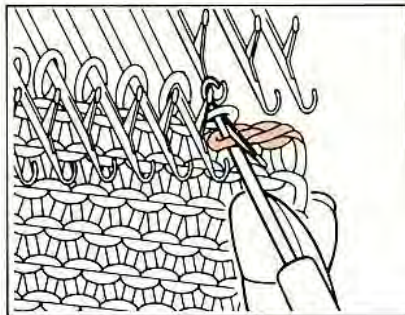

Repeat this until you reach the left side making new stitches across the row.

Make the new stitch fall behind the latch of LATCH TOOL, and hook the third stitch on the hook of the latch tool.

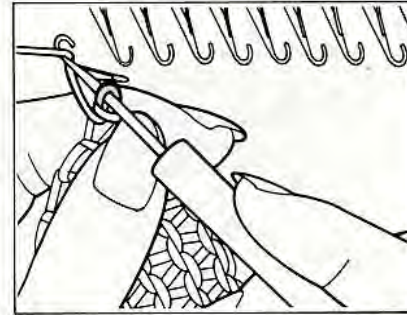

When you reach the last stitch, hook the end of the yarn on the hook of the LATCH TOOL and pull the end of the yarn through the stitch on the stem.

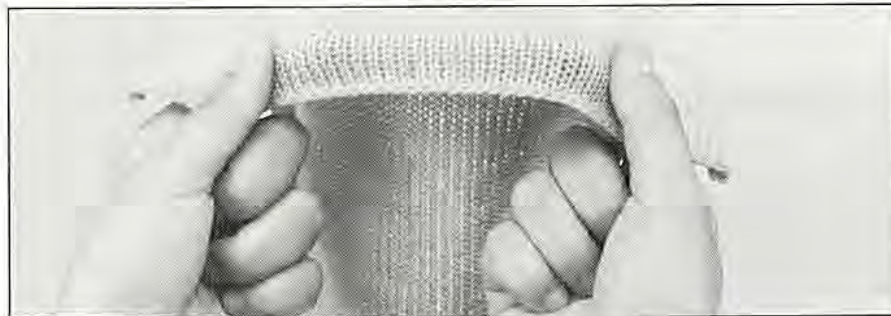

Now, the binding off is completed.

### Vertical seaming of plain stitch

1. Left hand piece—Pass the tapestry needle under threads of 1st and 2nd rows, bringing tapestry needle through the upper side.
2. Right hand piece—Pass the tapestry needle under threads of 2nd and 3rd rows, bringing tapestry needle through the upper side.
3. Left hand side—Pass the tapestry needle under threads of 3rd and 4th rows, bringing tapestry needle through to upper side.
4. Right hand side—Pass the tapestry needle under threads of 4th and 5th through the upper side.
5. Continue to seam in this way.

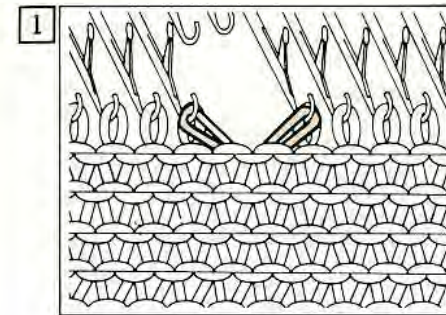
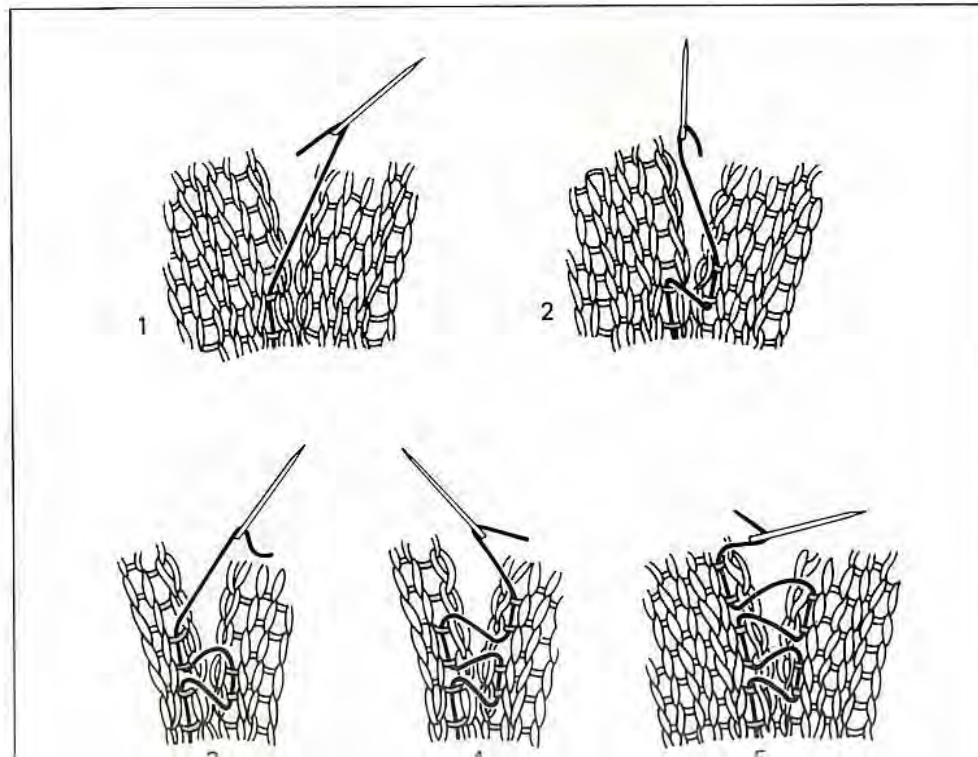

Using the 1 x 2 TRANSFER TOOL move the stitches, where you are going to make a button hole, to adjacent needles as shown in the figure.

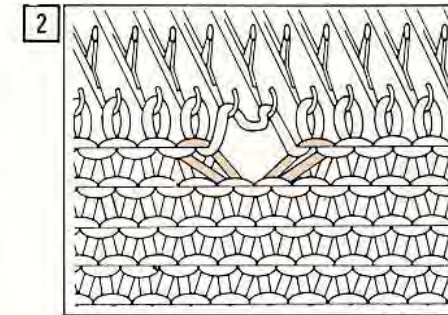

Bring back the empty needles to position B, and knit one row. The yarn will hook on the two needles.

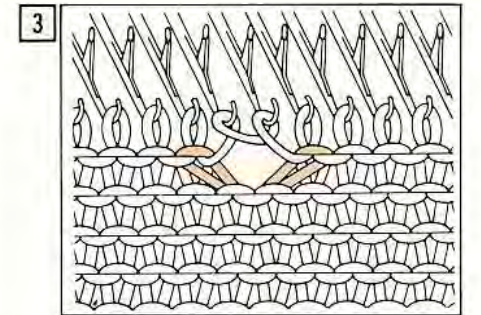

Loop the yarn around the two needles by hand as shown in the figure.

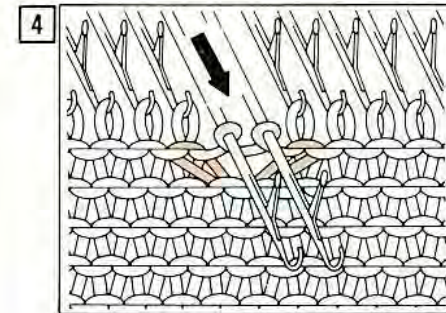

Bring the two looped needles forward to position E and operate the CARRIAGE.

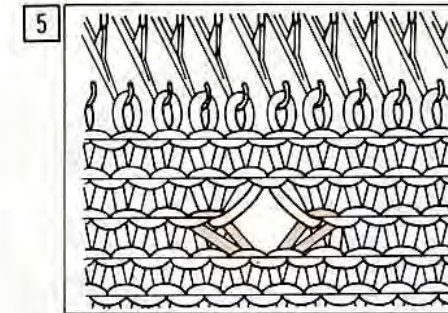

Then you have made a button hole.



## 7 How to shape a round neck line

Using the holding cam lever  
Plain knitting.

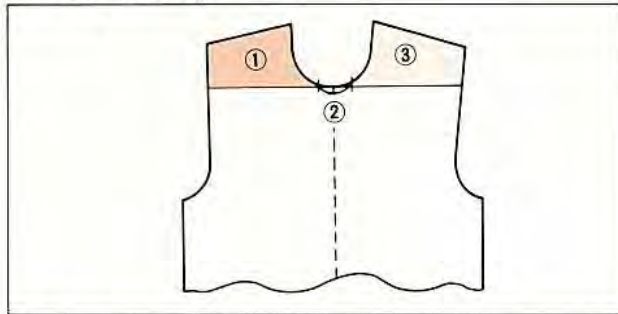

Knit the left and right side of the round neck line separately.

★ The example is showing that the yarn end is on the left side. When starting to knit the Neck line, if yarn end is on the right side, knit part ③ first by regarding the RIGHT as LEFT in following instructions.



Set the CAM LEVER of the CARRIAGE to position H.



Bring forward to position E all the needles on the opposite side of the CARRIAGE including the stitches for the center neck line and opposite shoulder. These needles will not knit.

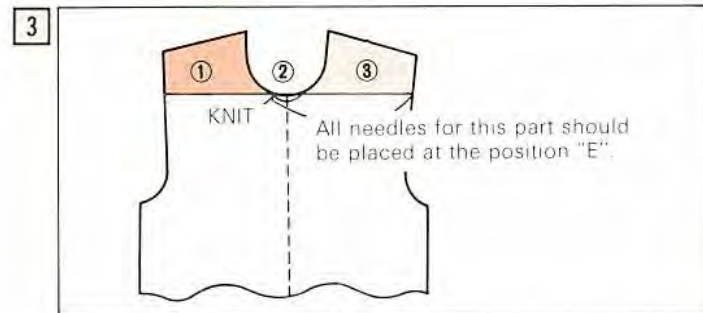

Knit part ① according to your pattern. Decreasing at the neck edge will be done by using the TRANSFER TOOL. Decrease in this manner until you have the required number of stitches left for the shoulder. Bind off the shoulder stitches.

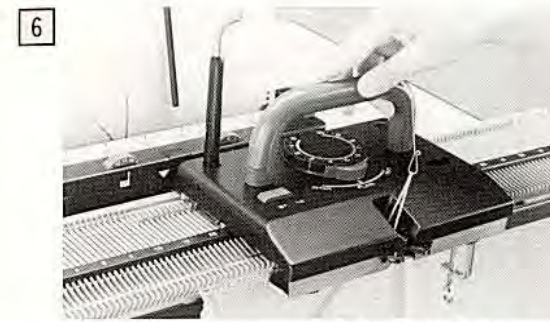
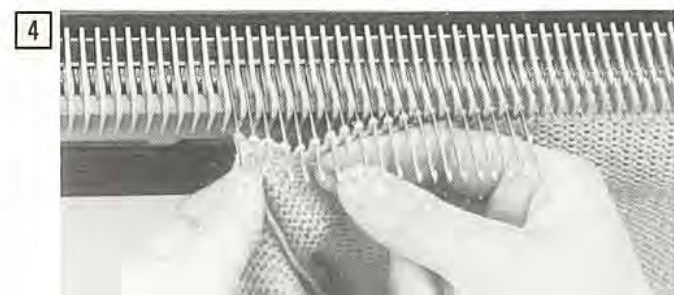

Thread the yarn into YARN FEEDER and knit the other side of the neck and shoulder for part ③.



The neck line is completed.

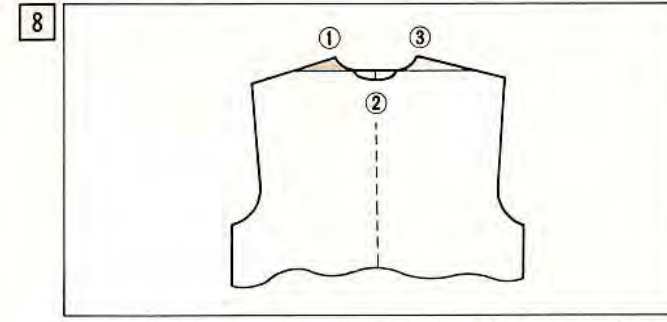

Knit the back in the same way. (Knit the left and right sides separately.)

## 8 Sewing procedure

Baste the knitting with binding wire or basting thread

In order to produce a neat garment easily, it is recommendable to use a sewing machine for all necessary sewing. As only straight stitch sewing is necessary, any type of sewing machine can be used. Stretchy thread of the same color as the yarn used for knitting is most suitable for sewing (or silk thread can be also used.)

Pin the parts to be basted.

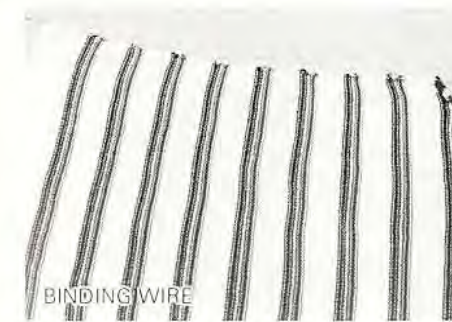
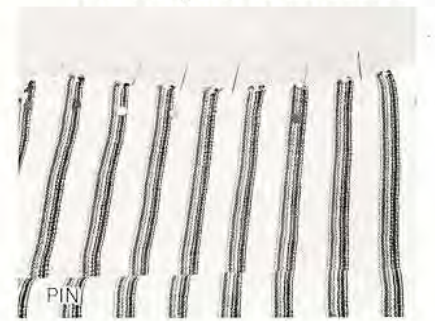

BINDING WIRE



BASTING THREAD

Baste the parts with basting thread or the binding wire which is an option.

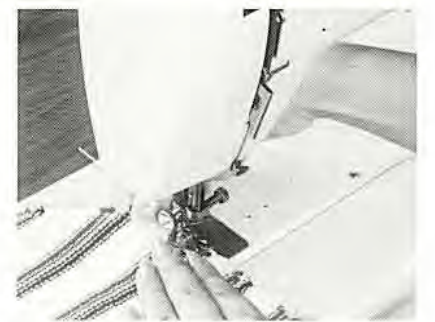

After basting, sew with a sewing machine. Slowly and naturally sew with a slight push along the



## 9 Partial knitting

When you knit socks, skirts, darts, etc., do partial knitting.

→ DECREASING STITCHES  
 ← INCREASING STITCHES

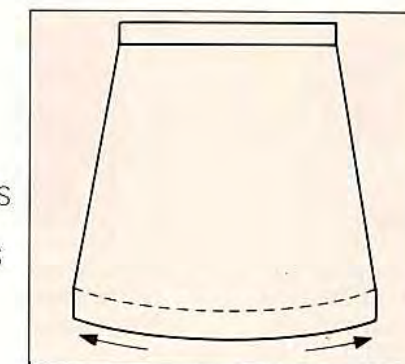

Skirt

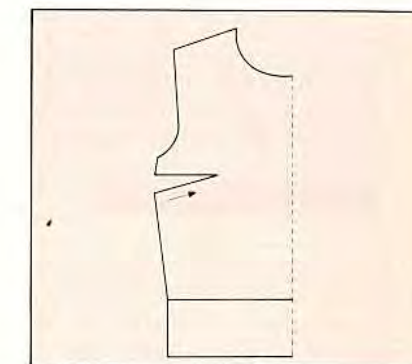

Dart

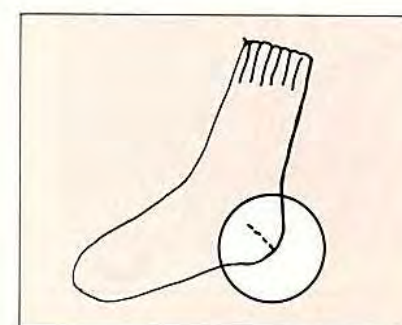

Socks  
 \* Let's knit the heel with Partial Knitting.

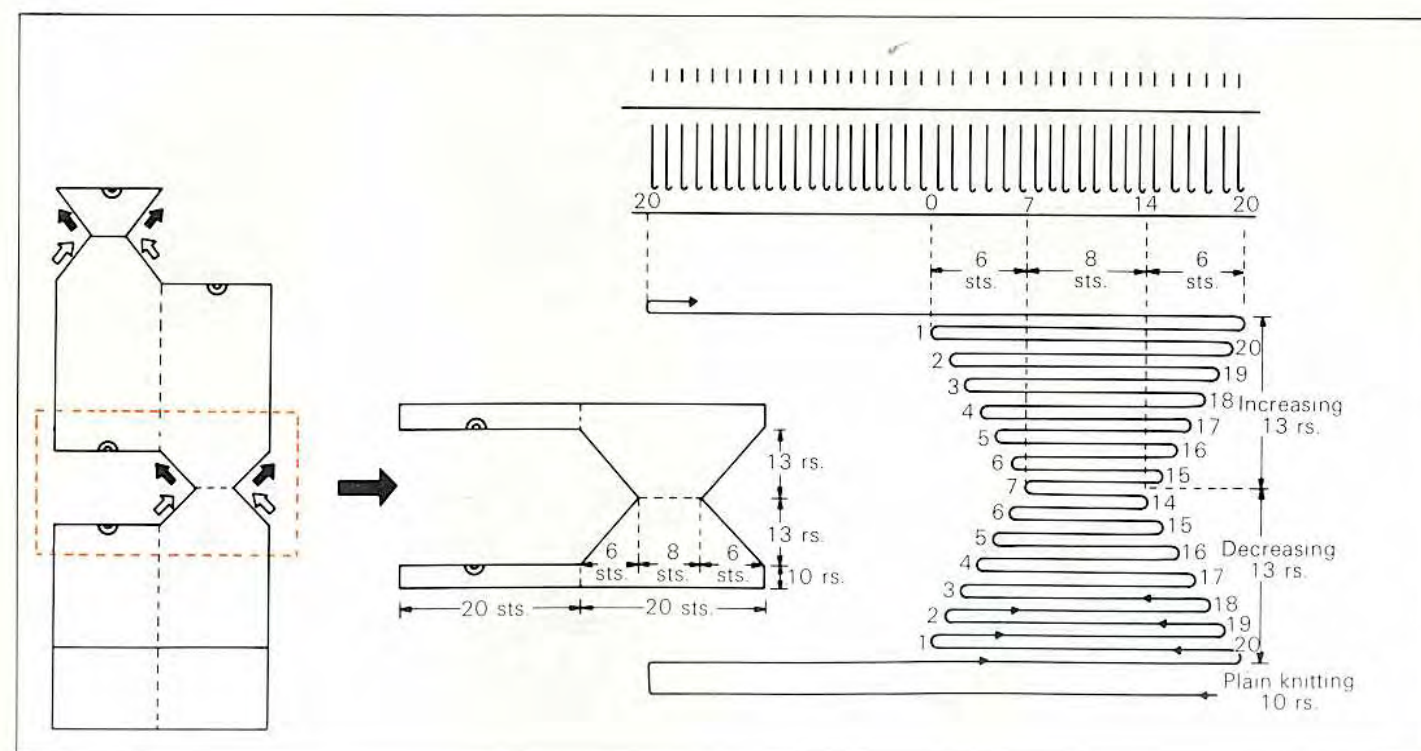

Sewing procedure

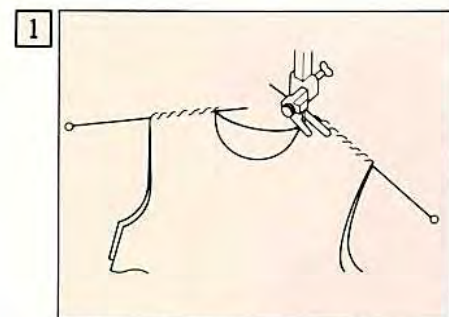

Shoulders (right and left)

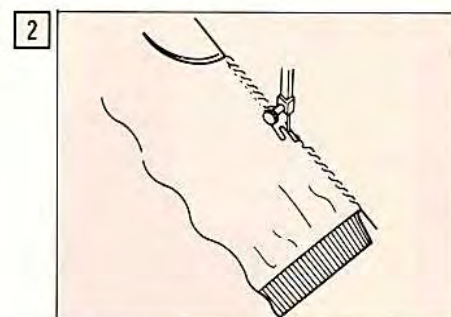

Sides

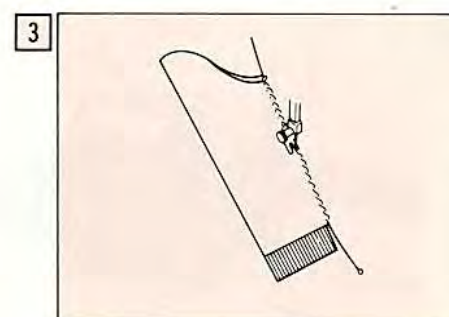

Sleeves

\* Sew ribbing together by hand.

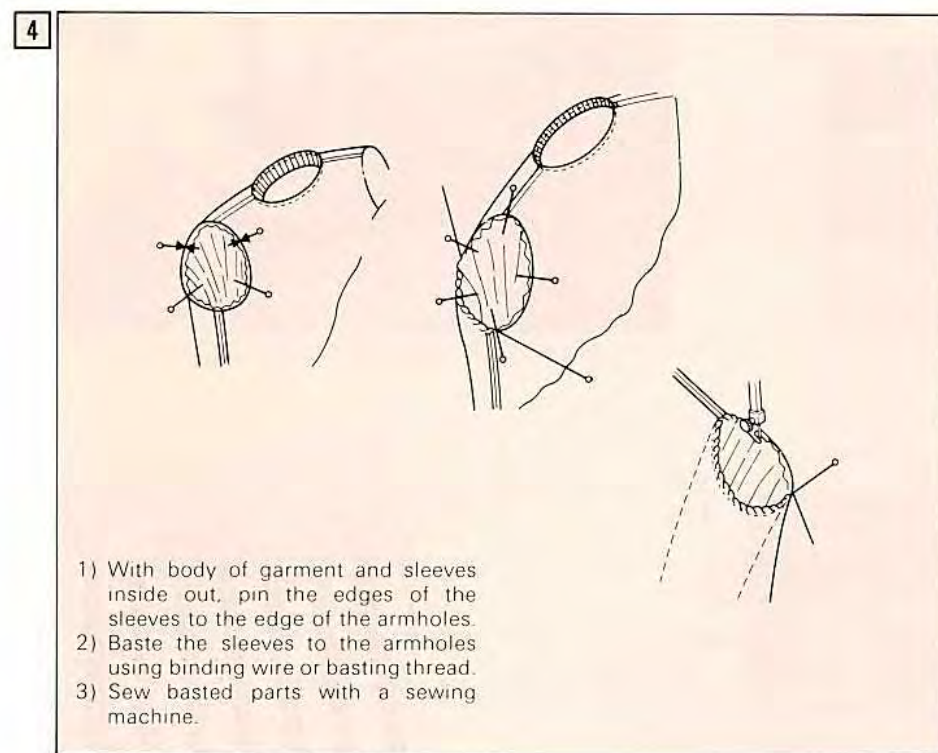

- 1) With body of garment and sleeves inside out, pin the edges of the sleeves to the edge of the armholes.
- 2) Baste the sleeves to the armholes using binding wire or basting thread.
- 3) Sew basted parts with a sewing machine.

Attach sleeves to armholes.

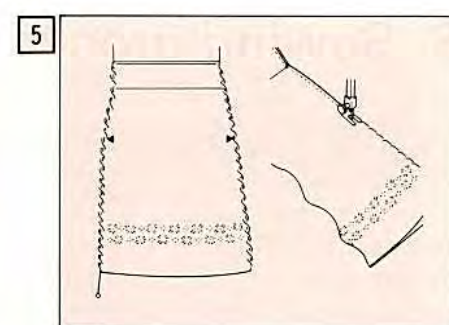

Skirt.



Decreasing stitches

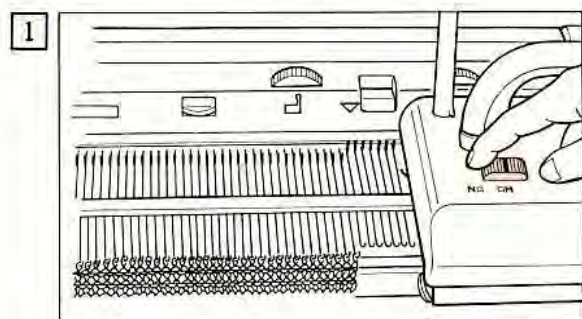

1 Bring forward 20 needles on either side of the center mark "0", knit 10 rows of Plain Knitting and place the CARRIAGE on the right side of the machine. Then, set the CAM LEVER of the CARRIAGE to position H.

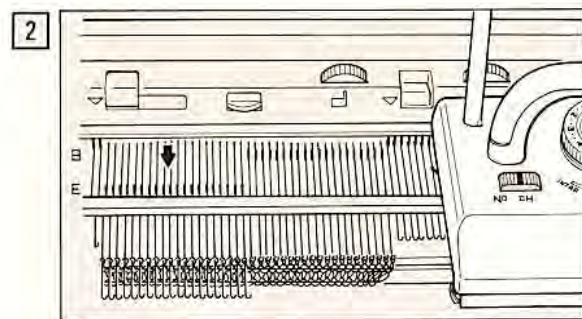

2 On the opposite side of the CARRIAGE, bring forward 20 needles to position E as above figure. (These needles will not knit.)

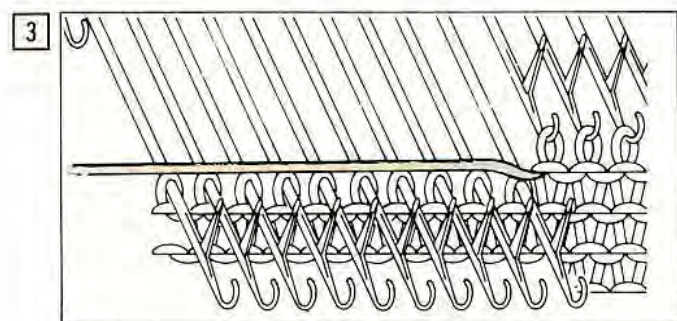

3 Knit one row. The yarn lies across on the stem of the position E needles at the time.

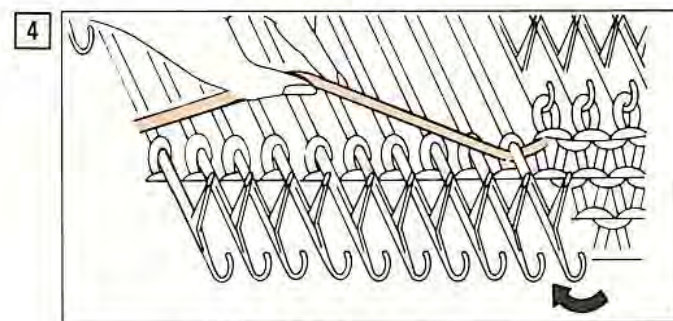

4 For stopping the gap which appears between stitch of position B and E, pass the yarn under the stem of the first needle at position E.

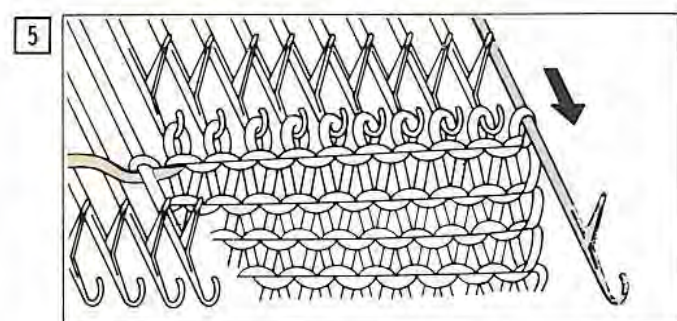

5 On the opposite side of the CARRIAGE, bring forward one needle to position E by hand, which will be decreased.

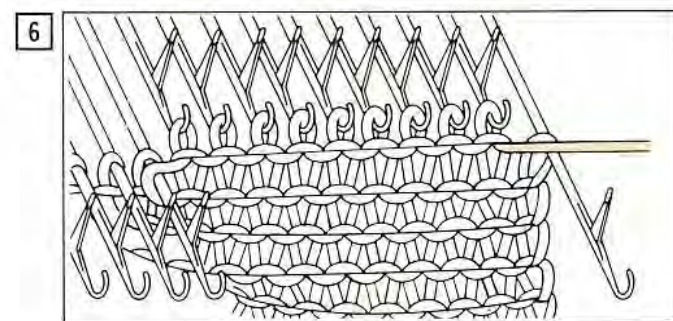

6 Knit one row.

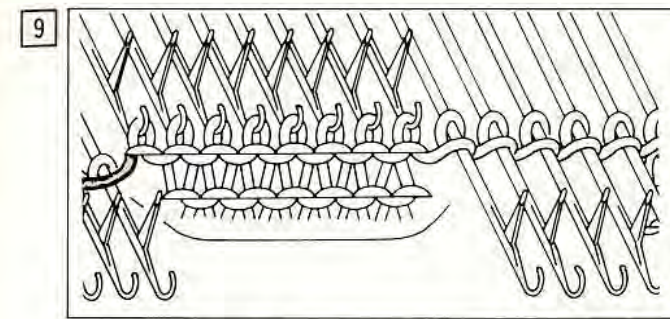
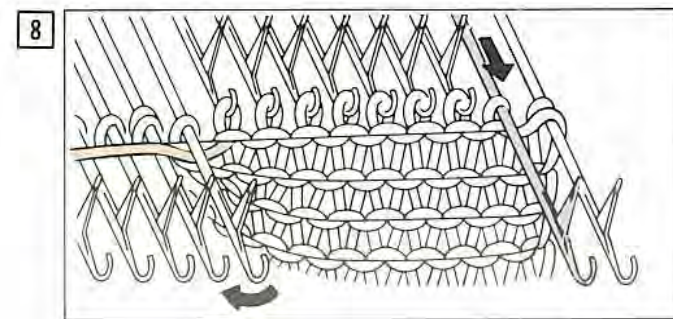
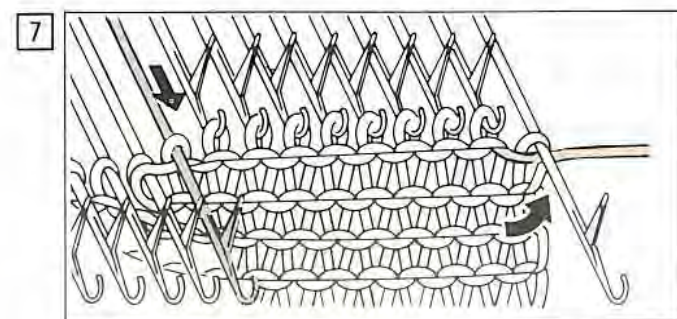

9 Repeat 4 ~ 8 until the remaining needles at position B will be 8 stitches, and knit one row as the finish. (The CARRIAGE is on the left side of the machine at that time.)

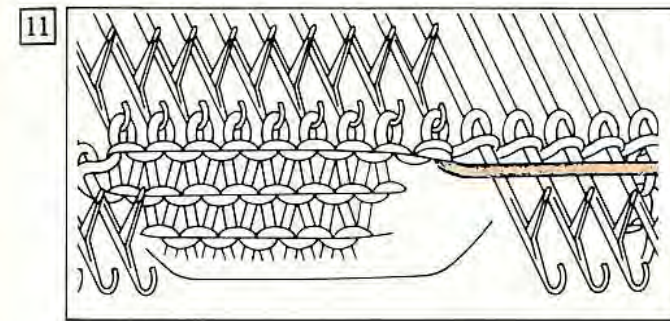

11 Knit one row

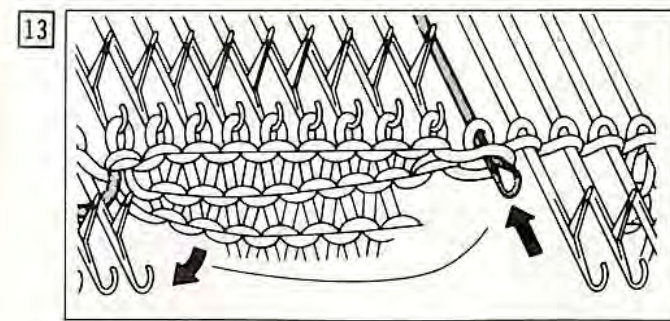

13 Knit one row.

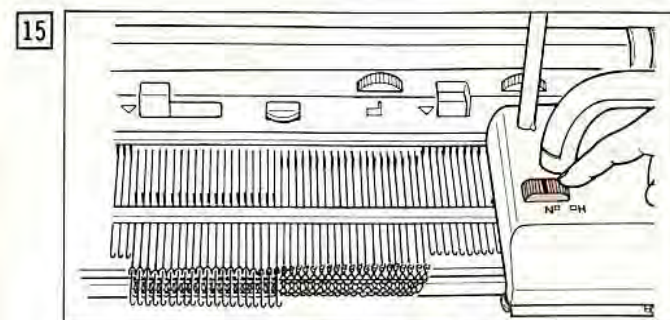

15 When the Partial Knitting is completed, change the CAM LEVER to position N, and knit 10 rows of plain knitting. Now, the heel of the socks is completed.

Increasing stitches

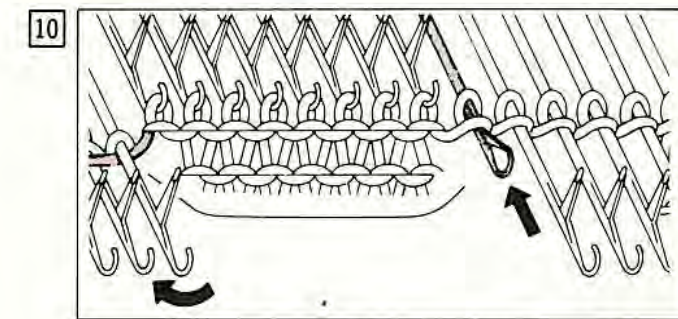

10 Now, start Increasing Stitches. Pass the yarn at the CARRIAGE's side under the stem of the first needle at position E. Then, push back to position D first needle on the opposite side of the CARRIAGE. (This stitch will be knitted.) Take care not to drop the stitch.

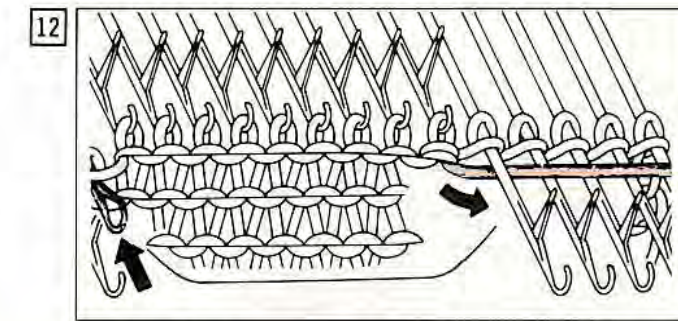

12 Repeat 10 but notice that the CARRIAGE is now on the opposite side of the position of 10.

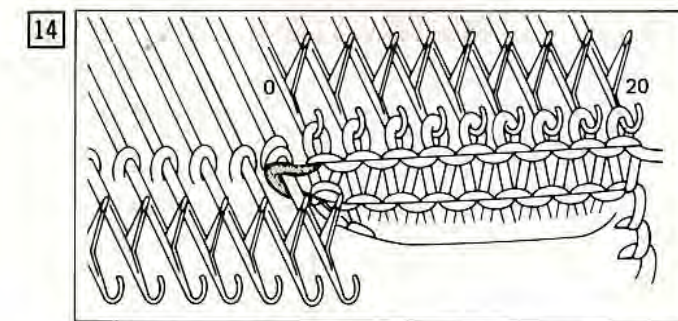

14 Repeat 10 ~ 13 until the needles at position B will be 20 stitches, and knit one row as the finish. (The CARRIAGE is on the right side of the machine at that time.)



# USEFUL HINTS

## 1 If the carriage should jam up

\* This machine is made of special resin so that do not move the carriage by force, take off it by using the release button.

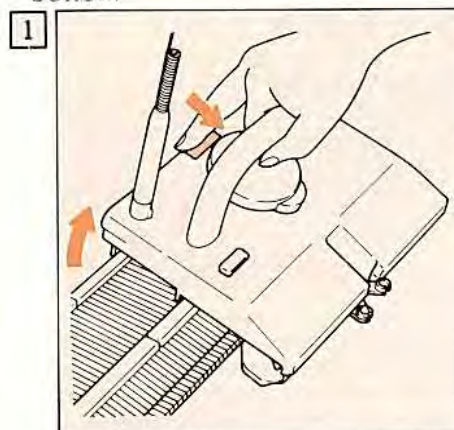

Take off the yarn, push the release button to take off the carriage.

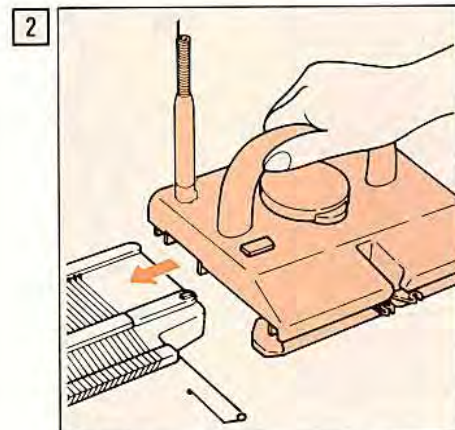

Set the carriage from the edge of the needle bed.

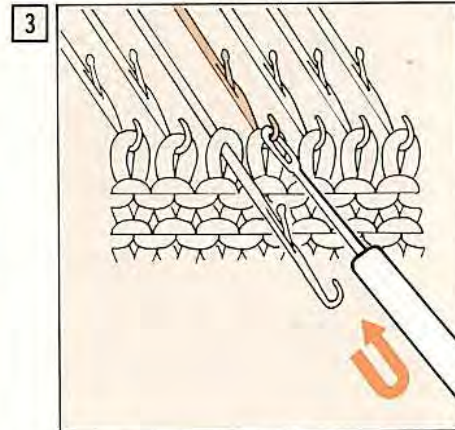

Replace the stitch on the stem by TRANSFER TOOL onto the hook of the needle.

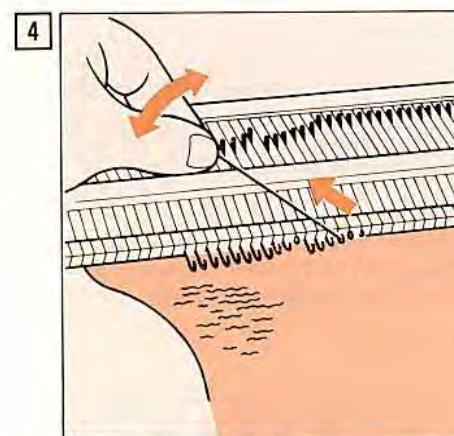

Unravelling a row of knitting. Pull the yarn slightly side ways and up to unravel the knitting.

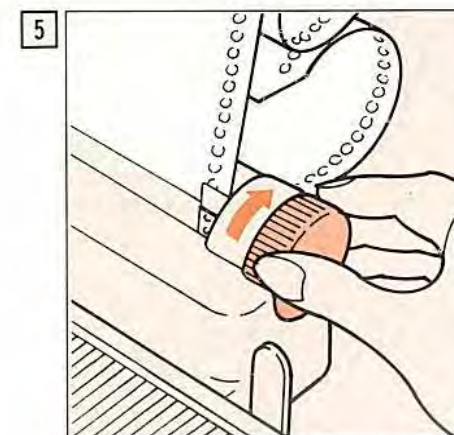

Put back the feeding dial for unravelling rows.

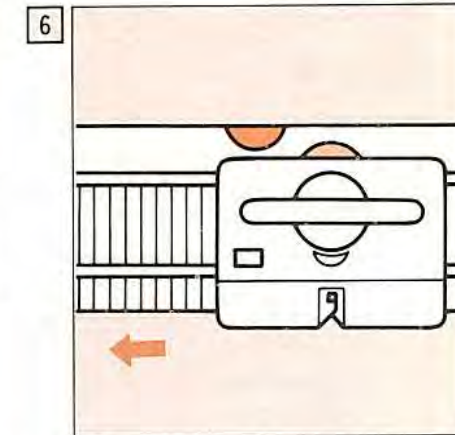
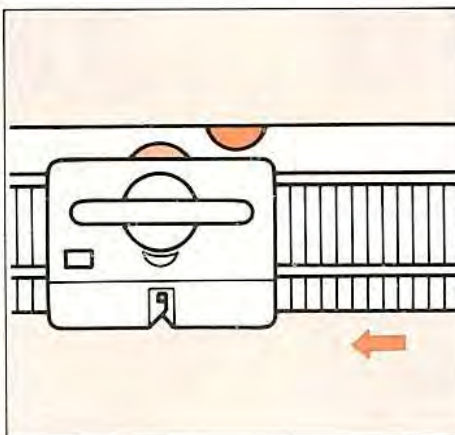

If the CARRIAGE is before the feeding lever, do not need to put back the feeding dial and row counter.

## 2 In case of moving the carriage without yarn

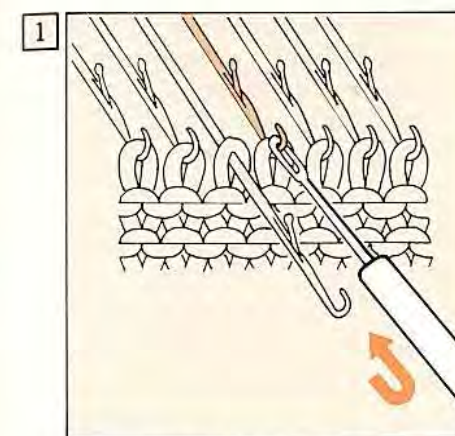

Replace the stitch on the stem by TRANSFER TOOL to the latch of the needle.

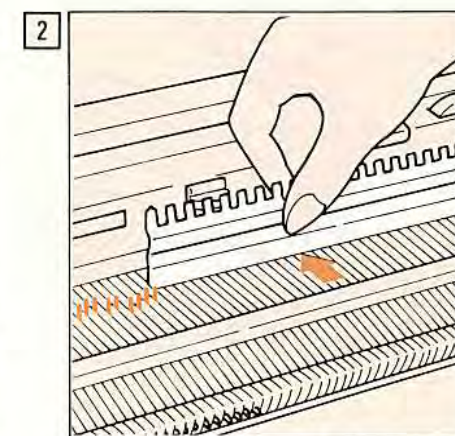

Return the needles to position B.

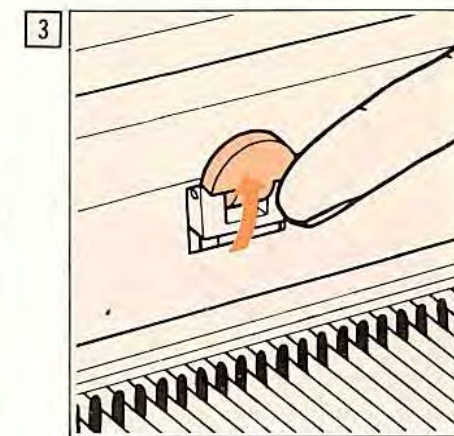

Fold up the feeding lever.

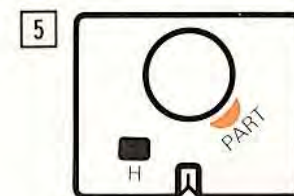
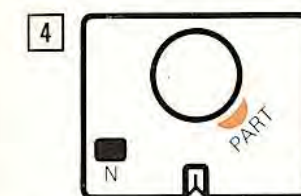

Set the change lever to "PART" and move the CARRIAGE. When the needles are position E, set the CAM LEVER to H. Set the feeding lever.

## 3 Replacing the needles

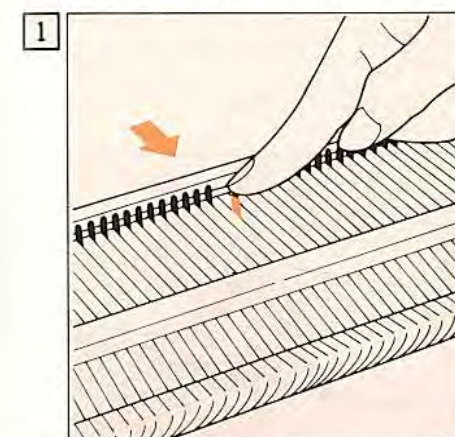

Push the needle to position B.

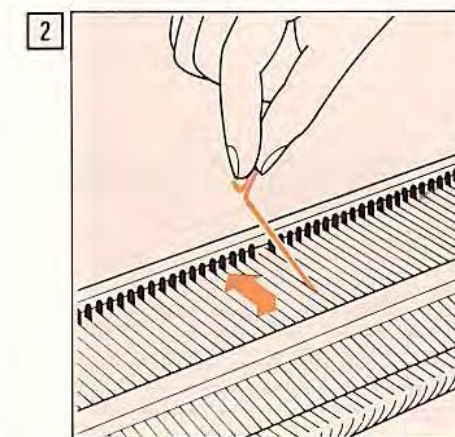

Lift the shank end backward, and pull it out.

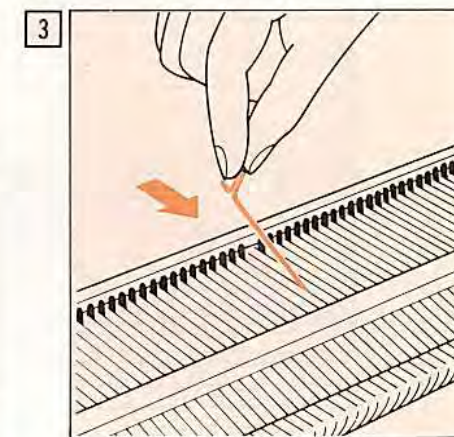

Insert a new needle and push it to position E.

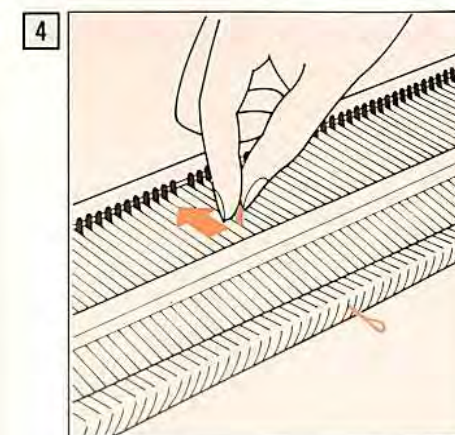



## 4 Cleaning and maintenance

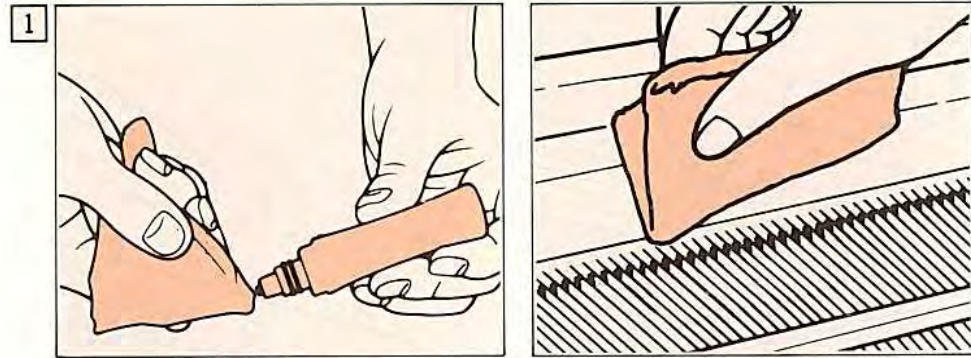

How to trim the machine. Before folding up your machine, get rid of dust by using hand brush and dry cloth. Metal parts should be wiped by oiled cloth and plastic parts should be wiped by cloth which contains nuter cleaner.

\*Wipe the following parts with oiled cloth. (Put the needles in order at position B.)  
Front and rear rails.  
Butts of the needles.

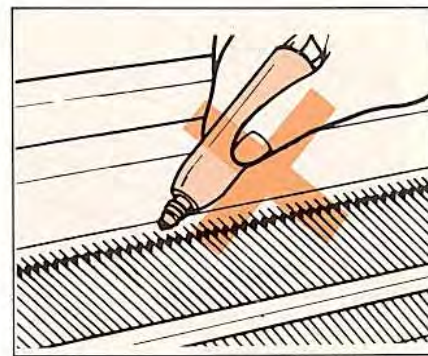
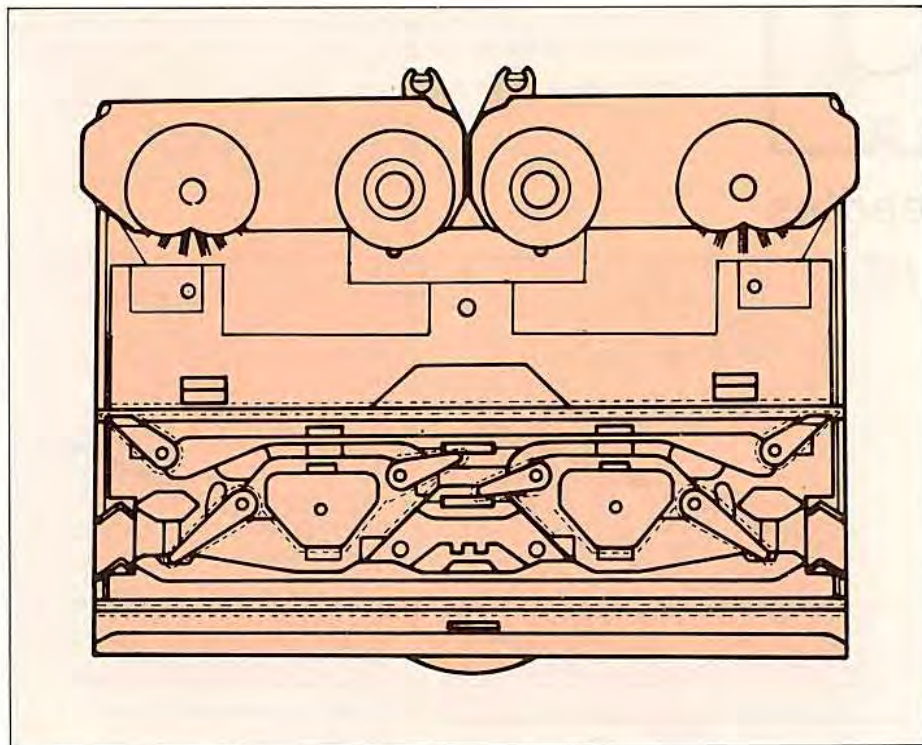

- \*Wipe the back side of the CARRIAGE along the dotted line which is shown in the figure with oiled cloth. Also when you feel the CARRIAGE does not move smoothly, wipe it.
- \*Do not oil the machine directly.
- \*Do not use thinner, benzine and gasoline
- \*Do not keep the machine in a damp place.
- \*Do not use the machine near a heater and in the sunshine.