

# LR140

## INSTRUCTION BOOK

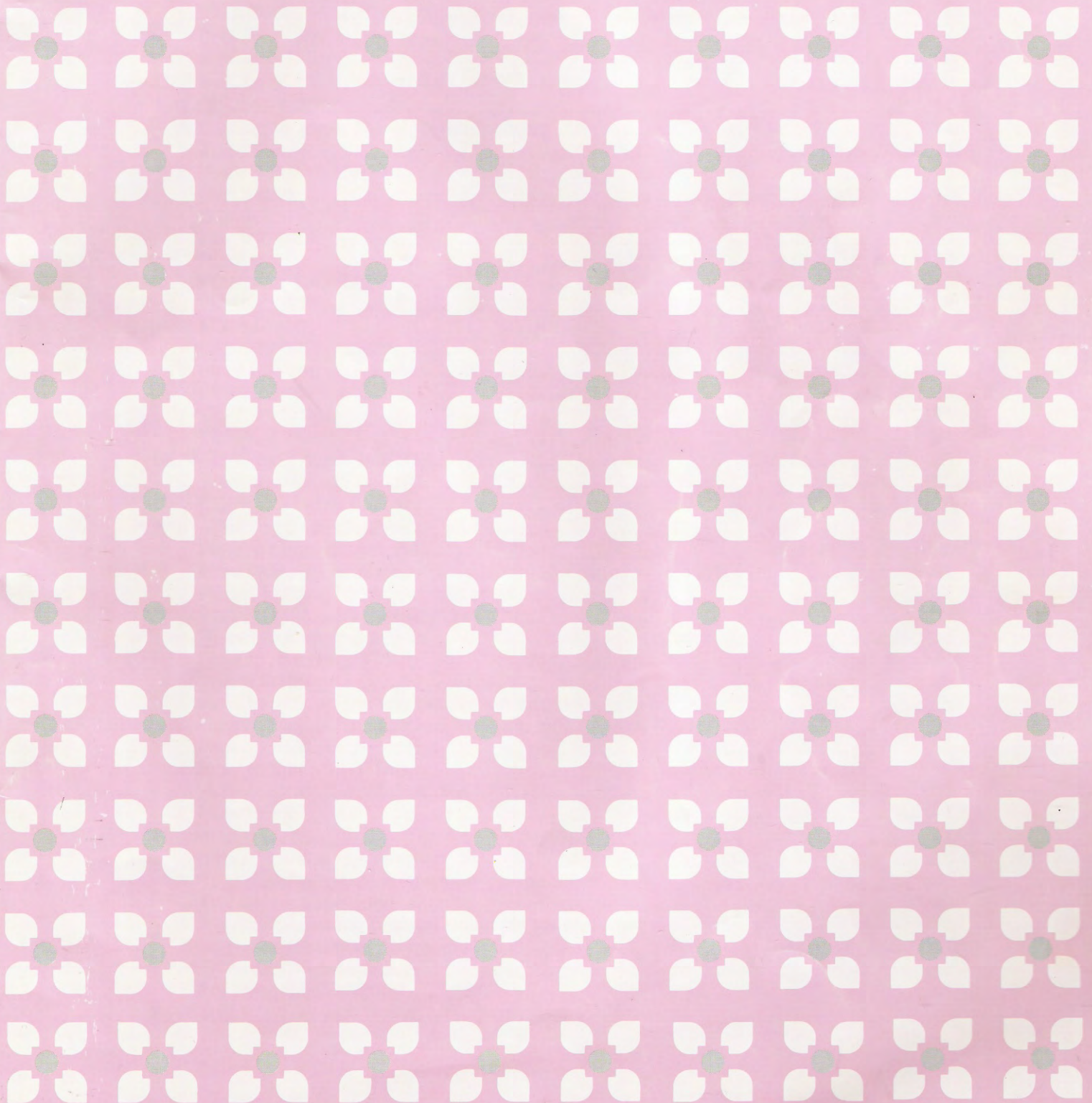

# CONTENTS

	page
HOW TO SET UP THE MACHINE .....	2
NAMES AND FUNCTIONS OF EACH PART .....	3
How to remove Carriage from Needle Bed .....	4
How to replace Carriage on Needle Bed .....	4
Needle positions .....	5
Yarn and Stitch Dial .....	5
Side Levers .....	6
Russel Levers .....	6
Yarn Feeders .....	7
Row Counter .....	7
ACCESSORIES .....	8
CAST-ON AND KNITTING STOCKINET .....	9
PATTERN KNITTING .....	14
Getting to know about pattern knitting .....	14
Tuck Stitch .....	15
Tuck Stitch in colours .....	16
Slip Stitch .....	17
Slip Stitch in colours .....	17
Fair Isle (Knit-In) .....	18
Plating .....	19
Plating in Tuck Stitch .....	19
Garter Stitch .....	20
Moss Stitch .....	20
Cable Stitch .....	21
Lace Knitting .....	22
Open Work .....	23
Cord Knitting .....	23
Mock English Rib. ....	24
HOW TO KNIT A GARMENT .....	25
Taking a tension gauge .....	25
Knitting a lady's pullover .....	26
KNITTING TECHNIQUES .....	30
How to decrease stitches .....	30
How to increase stitches .....	31
Partial knitting by decreasing stitches .....	32
Partial knitting by increasing stitches .....	33
Back stitch method .....	34
How to use Ravel Cord .....	34
Waste knitting .....	35
How to pick up the stitches left on waste knitting .....	35
How to pick up the stitches from the side edge of the knitting .....	36
How to hold stitches .....	36
How to knit K1.P1. Rib. ....	37
How to close the stitches of K1.P1. Rib. ....	39
How to join .....	40
HELPFUL HINTS .....	43
If the Carriage has jammed .....	43
To unravel a row of knitting on the machine .....	43
To pick up a dropped stitch .....	44
If a dropped stitch has run down for several rows .....	45
To replace a damaged needle .....	45
To clean the machine .....	46
For successful knitting .....	46
REPLACING THE MACHINE .....	46

# HOW TO SET UP THE MACHINE

Remove two Clamps, Tension Spring, Row Counter, yarn Rod Socket, yarn Rod and Tension Guide from the box.



Clamps

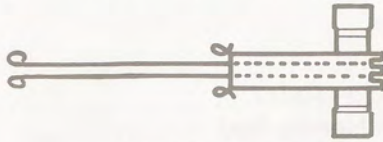

Auto-Tension

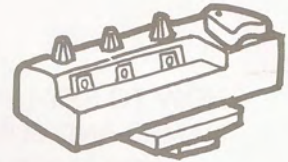

Row Counter



Yarn Rod Socket



Yarn Rod

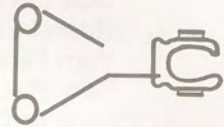

Tension Guide

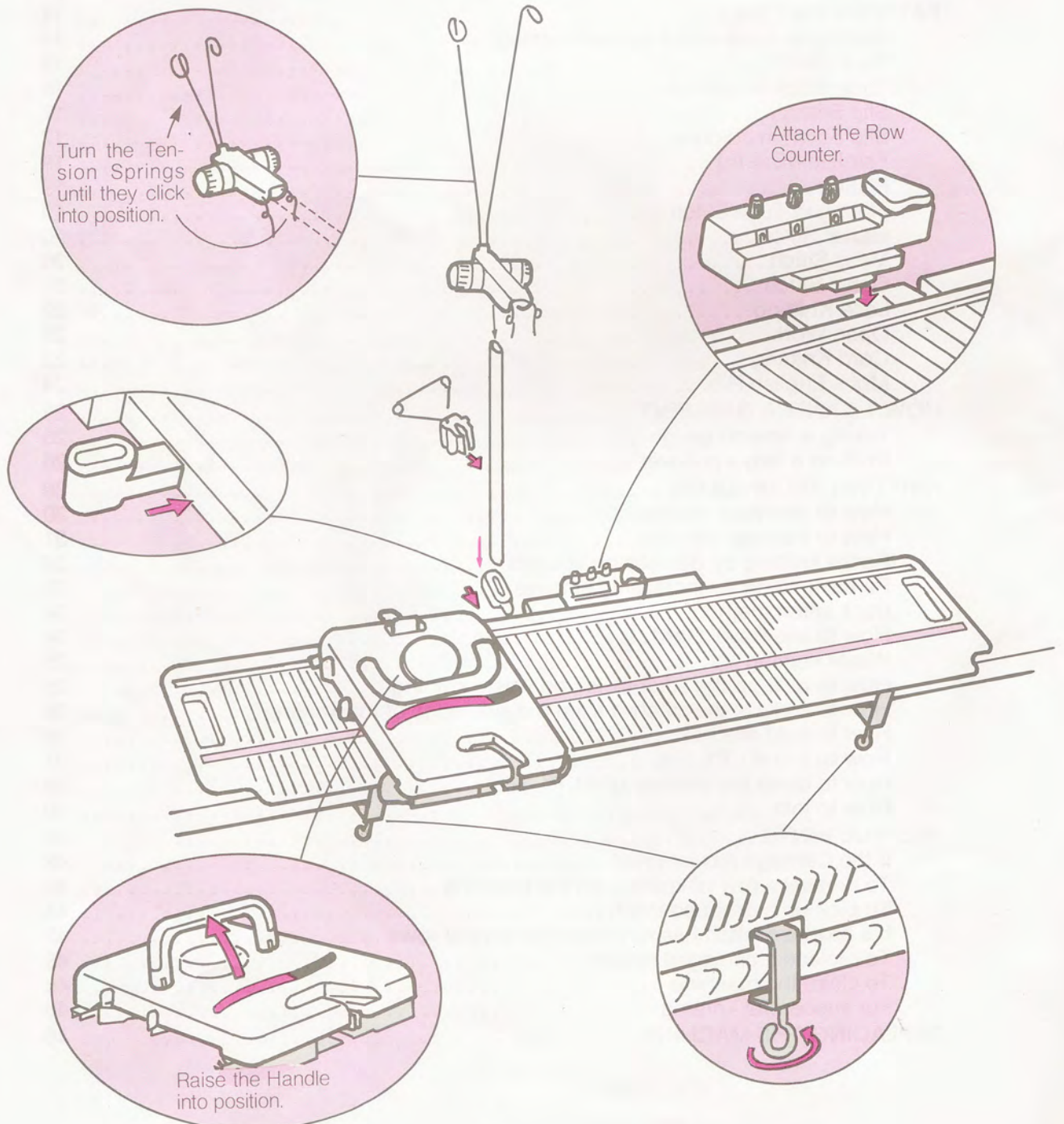

# NAMES AND FUNCTIONS OF EACH PART

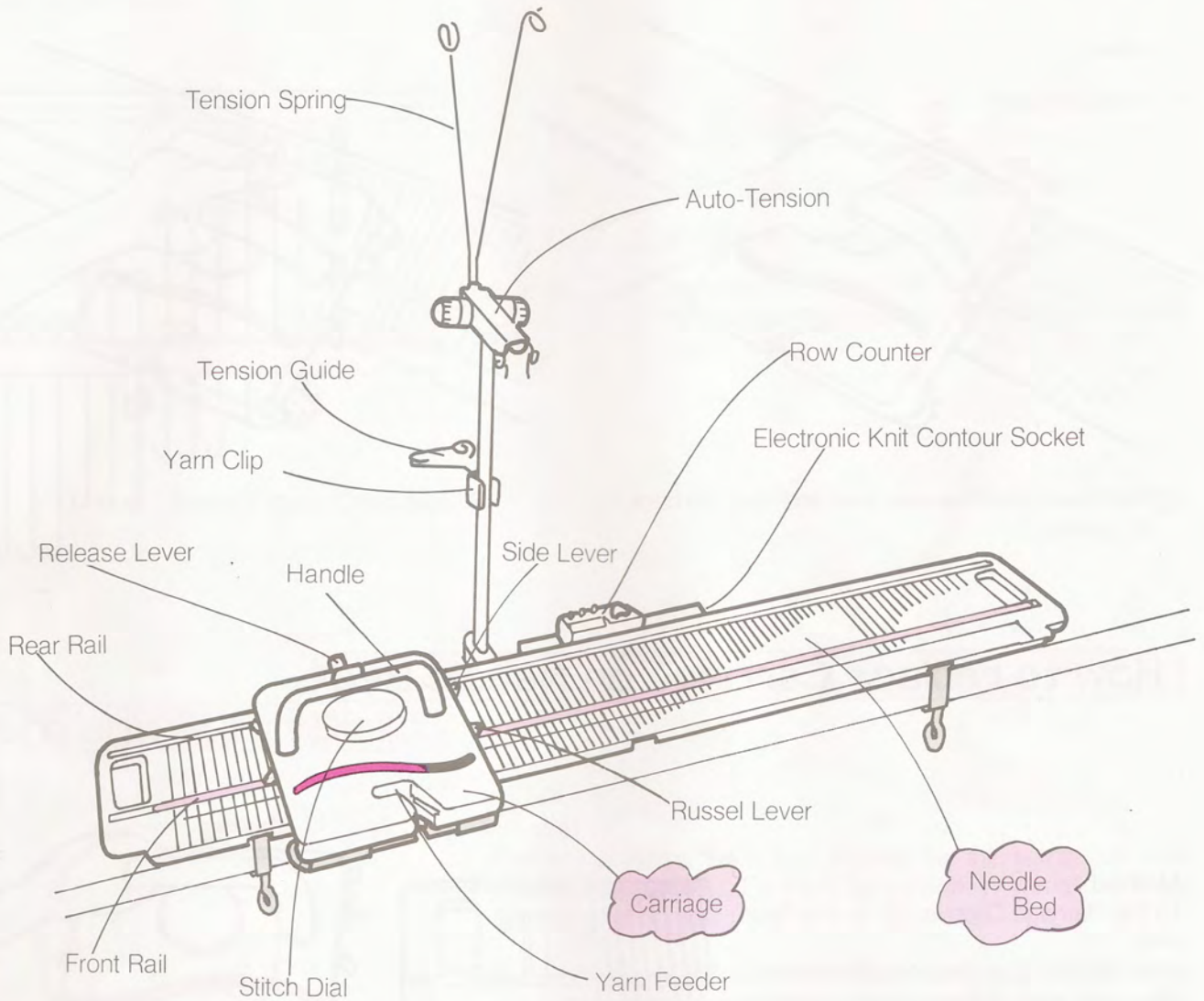

## Latch Needle



The optional Electronic Knit (Radar)Contour KR10 is available to this machine. It allows you to knit garments without any difficult computations involved in shaping.

When using two different yarns, attach the Yarn Rest at both sides of Needle Bed to rest either of two yarns.



## How to remove Carriage from Needle Bed

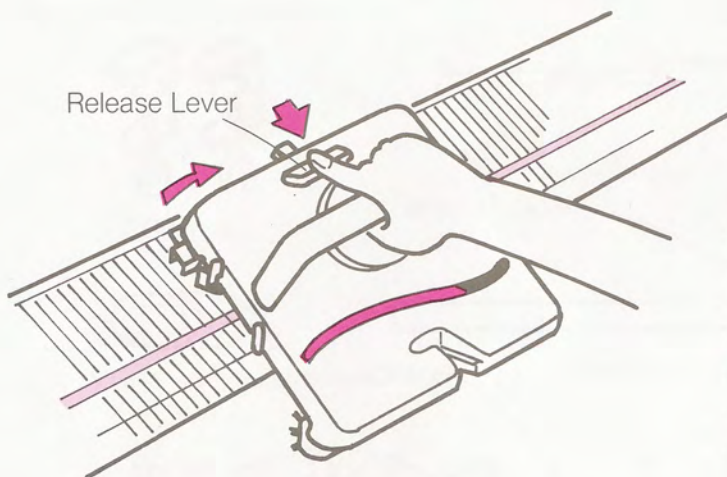

① Pull forward the Release Lever and lift up the back of Carriage.

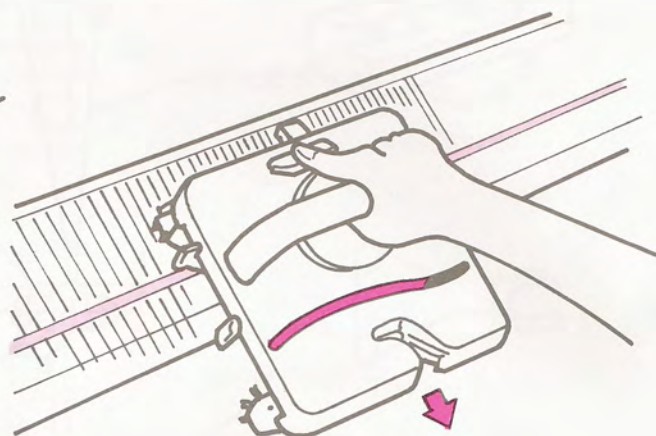

② Move the Carriage forward.

## How to replace Carriage on Needle Bed

### Method 1

Fit the Carriage Groove (A) to the Rear Rail.

Slide the Carriage along the Needle Bed, lifting the front of Carriage to clear the Carriage Stopper.

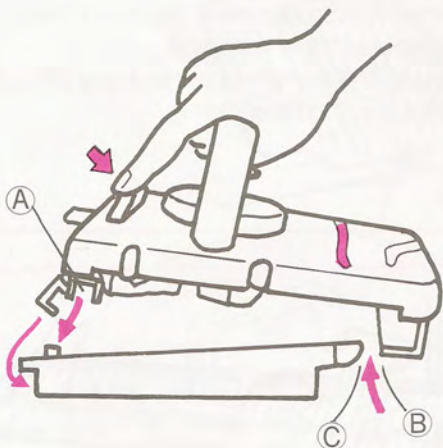
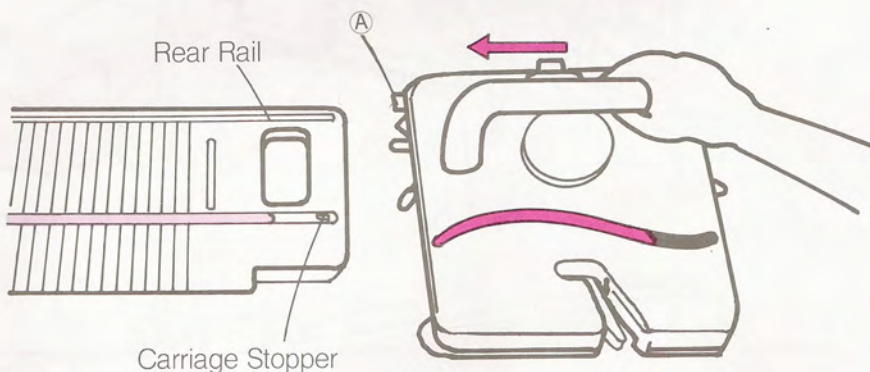

### Method 2

Align needles in A position. Pulling forward Release Lever, fit the Fabric Presser (B) to Sinker Posts (C) and fit the Carriage Groove (A) to Rear Rail.

## Needle positions

The letters A, B, C and D at both ends of the Needle Bed show different needle positions. Each letter denotes a different function for the needle.

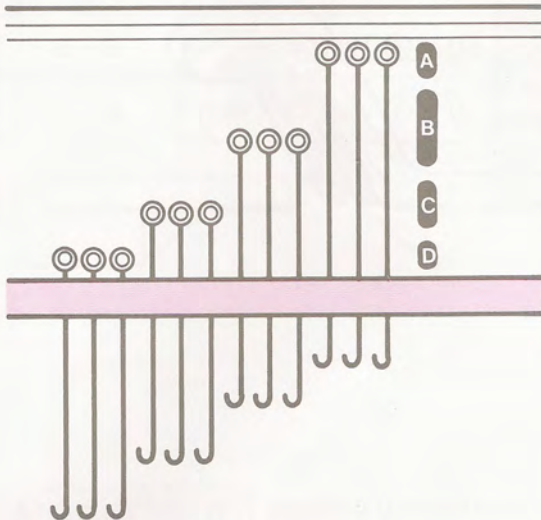

- A..... Needles do not knit.
- B..... Needles knit Stockinet and stitch patterns.
- C..... Needles knit Stockinet only.
- D..... Needles do not knit with Russel Levers at I.  
Needles are knitted back to B position with Russel Levers at II.

## Yarn and Stitch Dial

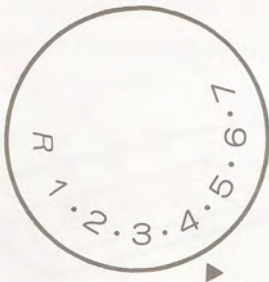

Set the number to ▲ mark.

Use this to control the size of stitches. For thin yarns, use small stitches, low numbers. For thick, lumpy or hairy yarns, use larger stitches, high numbers.

R is tighter than 1. When knitting the front and back with Stitch Dial at 1 or 2, set Stitch Dial at R to knit welt or neckband in K1.P1. Rib.

Stitch Dial at ①



Stitch Dial at ④



Stitch Dial at ⑦

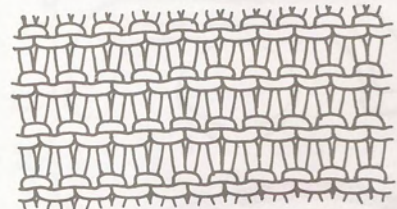



To obtain correct stitch size or suitable tension gauge for a garment set the Stitch Dial number according to the thickness of yarn.

Type of Yarn	Stitch Dial
① ~ ② Medium yarn	1 ~ 2
③ ~ ⑦ Thick yarn	3 ~ 5
⑧ ~ ⑨ Very thick yarn	6 ~ 7

## Side Levers

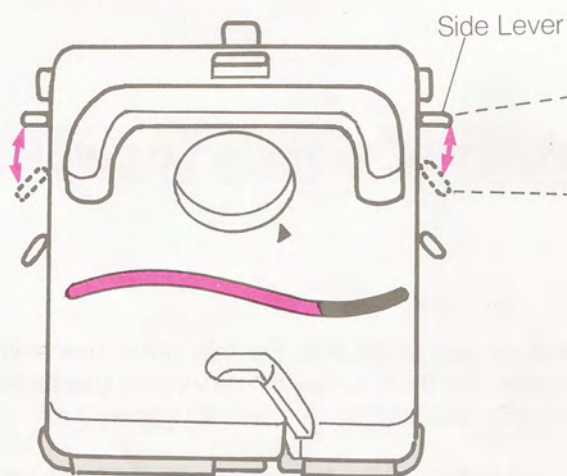

These control needles in B position.

▲..... Knit the needles in B position.  
Set to this position for Stockinet, Plating or Tuck Stitch.

●..... Do not knit the needles in B position.  
Set to this position for Slip Stitch or Fair Isle.

Right Side Lever works when Carriage moves from left to right.

Left Side Lever works when Carriage moves from right to left.

## Russel Levers

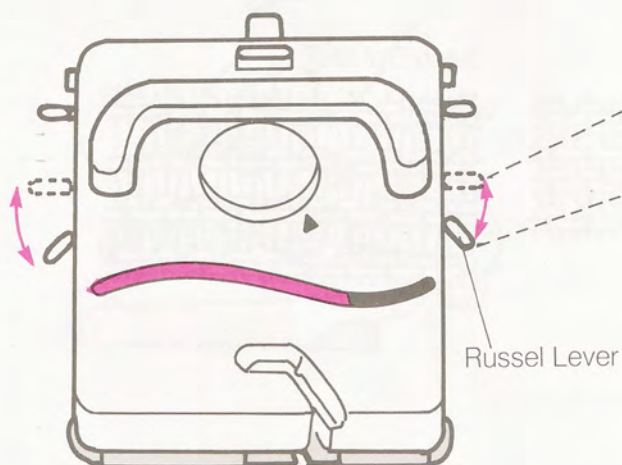

These control needles in D position.

I..... Do not knit the needles in D position.  
Set to this position for Tuck Stitch or partial knitting.

II..... Knit the needles in D position and the needles will be back to B position.

Right Russel Lever works when Carriage moves from left to right.

Left Russel Lever works when Carriage moves from right to left.

## Yarn Feeders

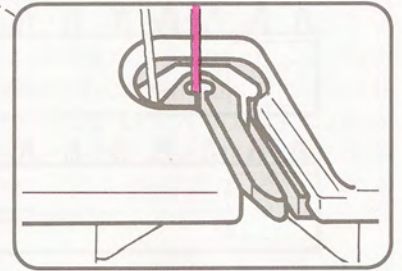
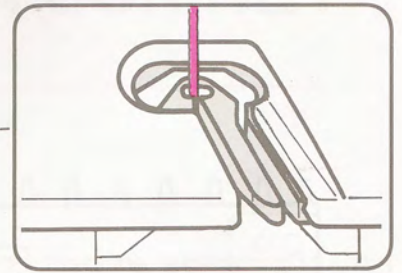
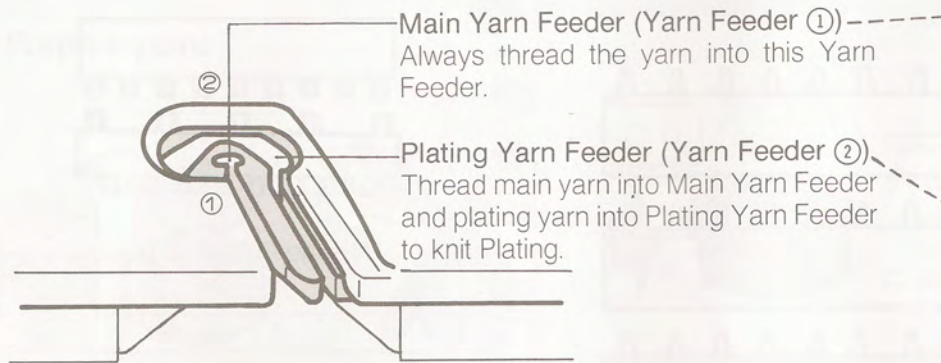

## Row Counter

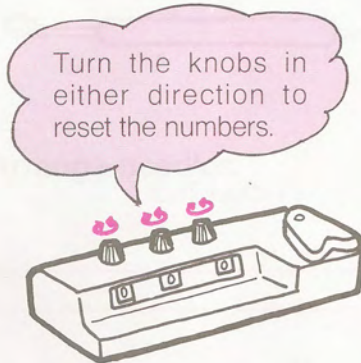



# ACCESSORIES

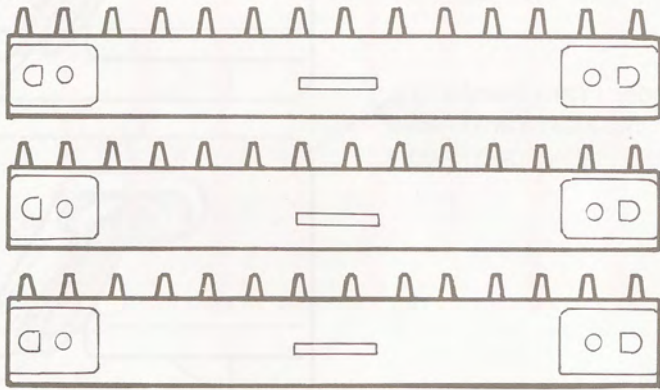

Cast-on Comb (3 pcs.)

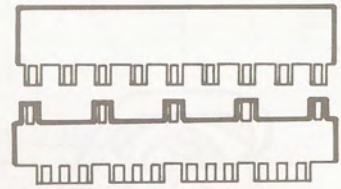

Needle Pusher (2 pcs.)



Transfer Tool (3 pcs.)

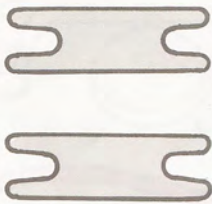

Comb Connector (2 pcs.)

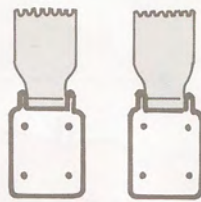

Claw Weight (2 pcs.)

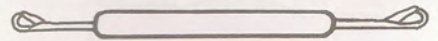

Tappet Tool

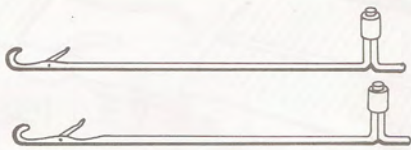

Spare Needle (2 pcs.)

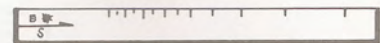

Gauge Scale

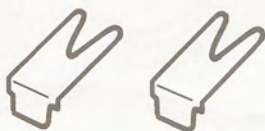

Yarn Rest (2 pcs.)



Tapestry Needle

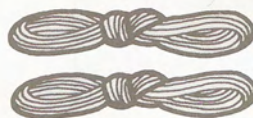

Ravel Cord (2 pcs.)



Oil

# CAST-ON AND KNITTING STOCKINET

## 1. Prepare yarn.



Your machine is designed to knit a wide variety of yarns from medium yarn to very thick yarn, but it is recommended to use a nice smooth thick yarn to start with. It is impossible to knit from a hank of yarn or hand wound ball, so unwind them into a basket or rewind on a woolwinder.

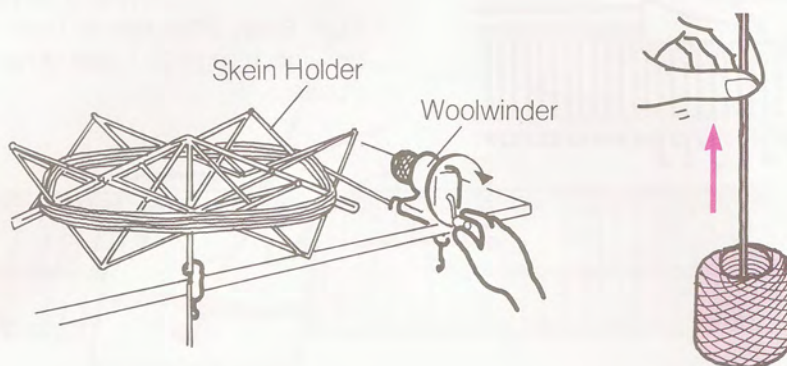

Use the yarn from the centre of a ball made on a woolwinder.

## 2. Arrange needles.

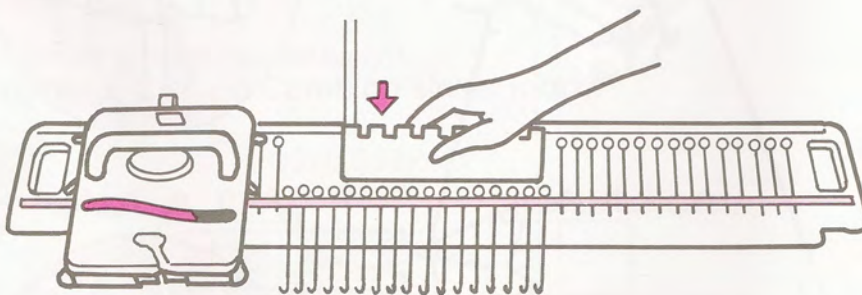

Push 30 needles on both sides of the centre "0" to D position (60 needles altogether), using straight side of Needle Pusher.

Set both Side Levers to ▲ and Russel Levers to II.

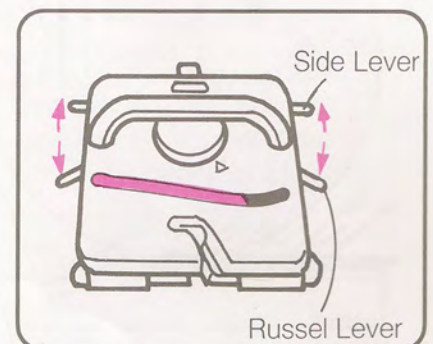

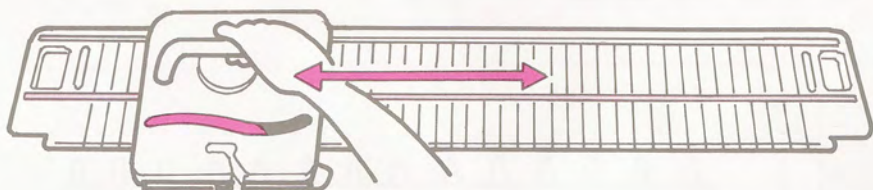

Slowly move the Carriage to the right until it passes all the needles in B position then return it to the left.

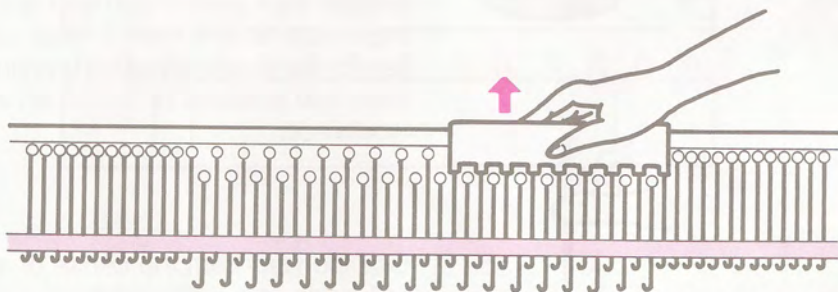

Push every other needle back to A position, using 1 × 1 side of Needle Pusher.

### 3. Thread yarn.

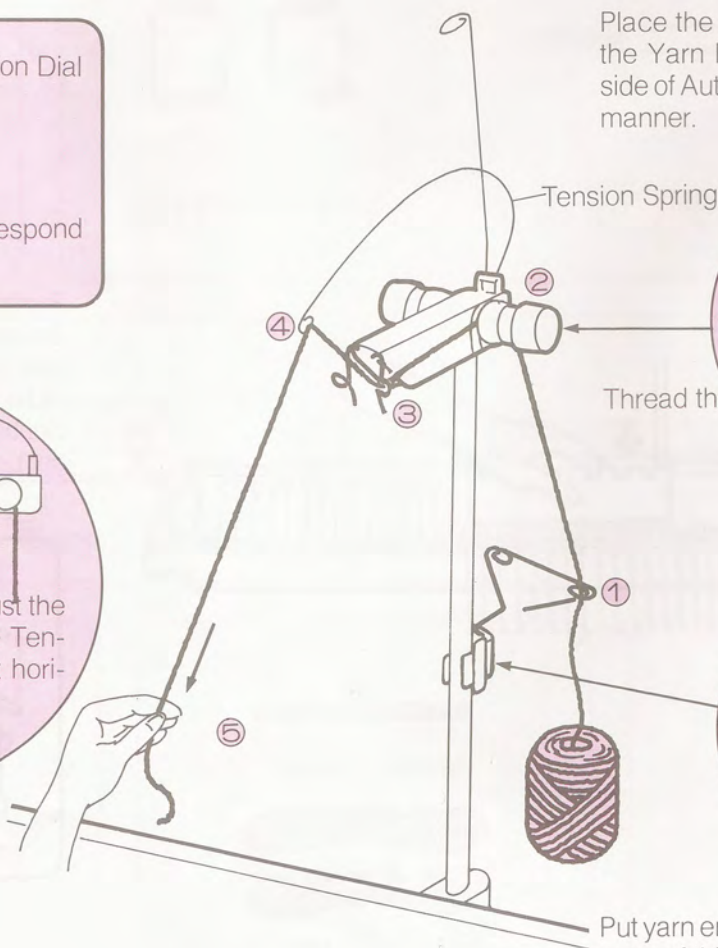
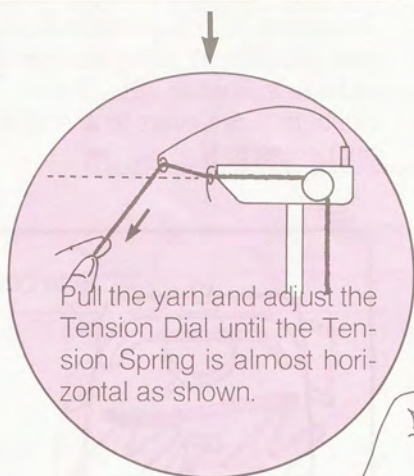
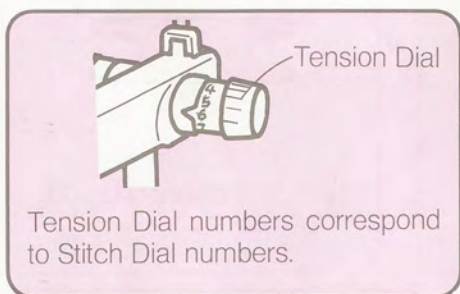

Place the yarn on the table behind the Yarn Rod and thread the right side of Auto-Tension in the following manner.

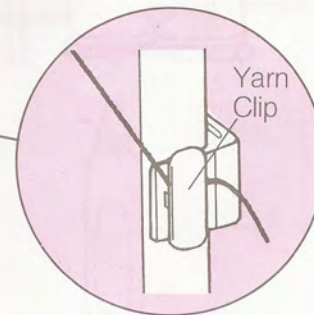
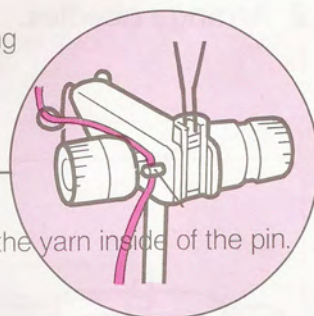

Put yarn end under the Yarn Clip. (In case of thin yarn, wind it around the Clip 2 ~ 3 times.)

**4. Place the yarn into Main Yarn Feeder.**

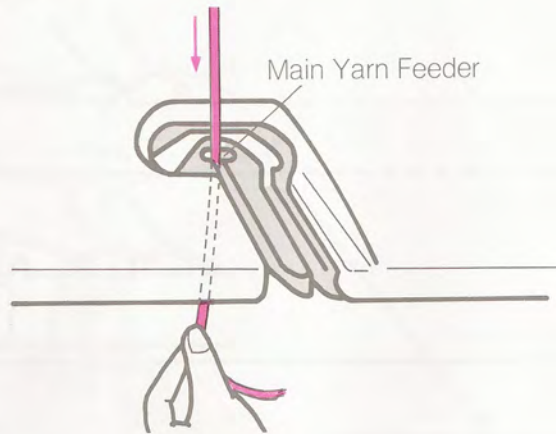

**5. Knit 1 row.**

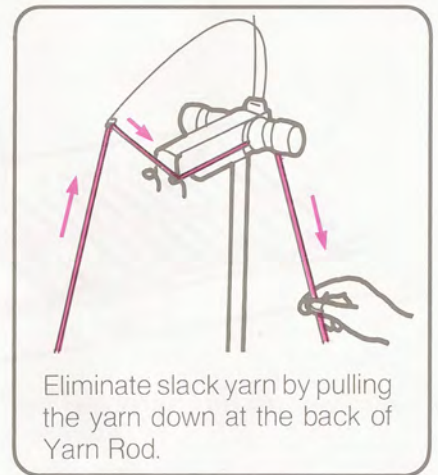
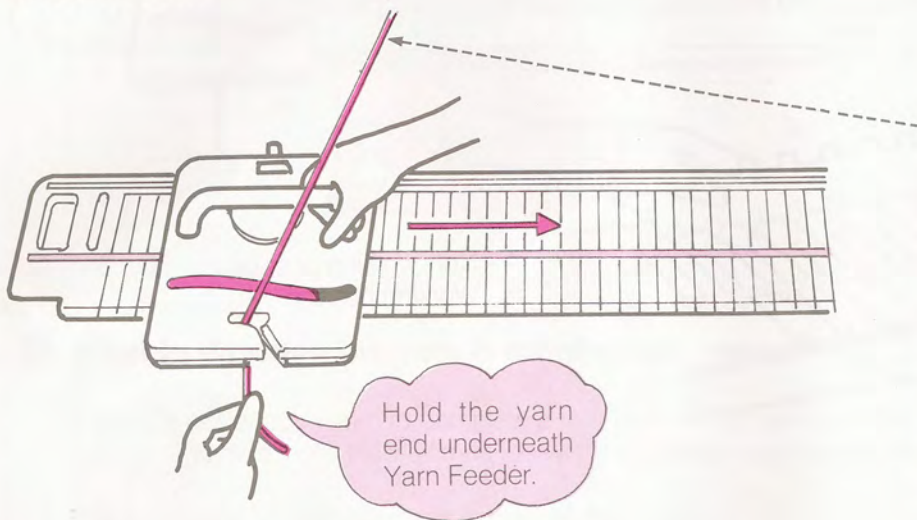

Move the Carriage slowly from left to right and open loops have been formed between the needle hooks and the sinker posts.



**6. Hook Cast-on Comb on sinker loops.**

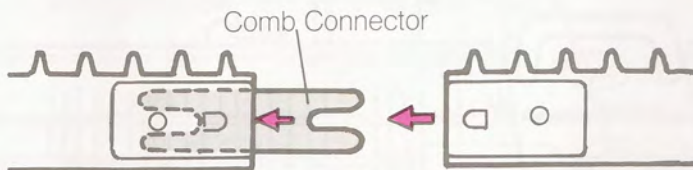

Join Cast-on Combs with Comb Connector according to the width of knitting.

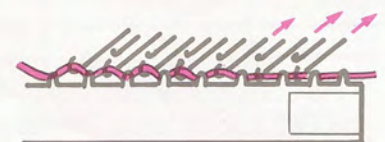
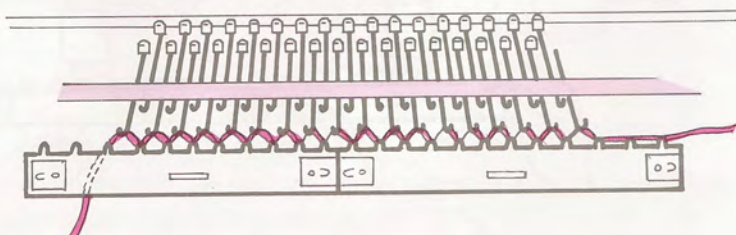

When the loops get smaller at the edge, push the needles with small loops one by one back to B position by hand.

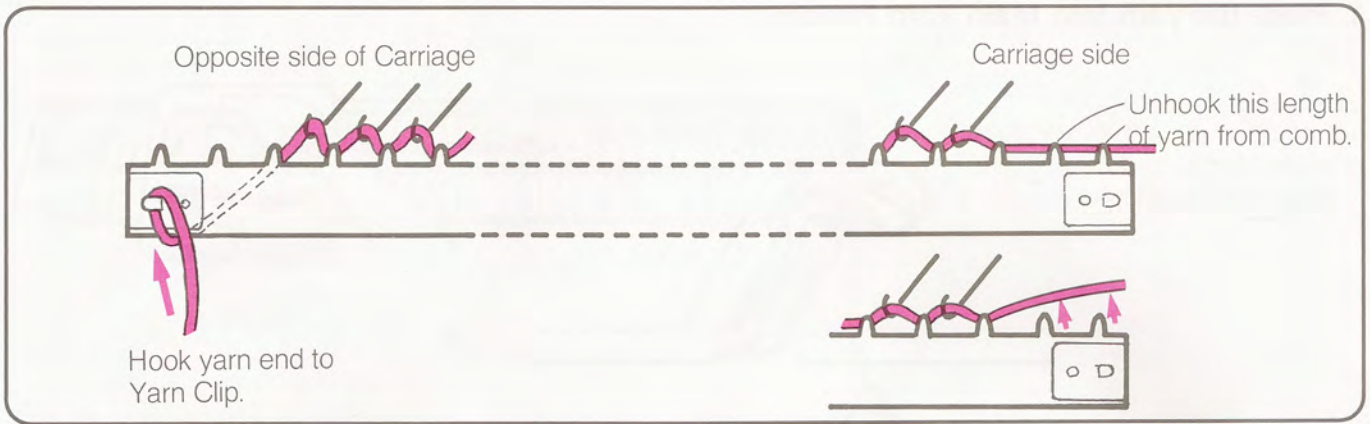

## 7. Return the needles in A position to B position.

Bring the alternate needles which were pushed back to A position at step 2 to B position.

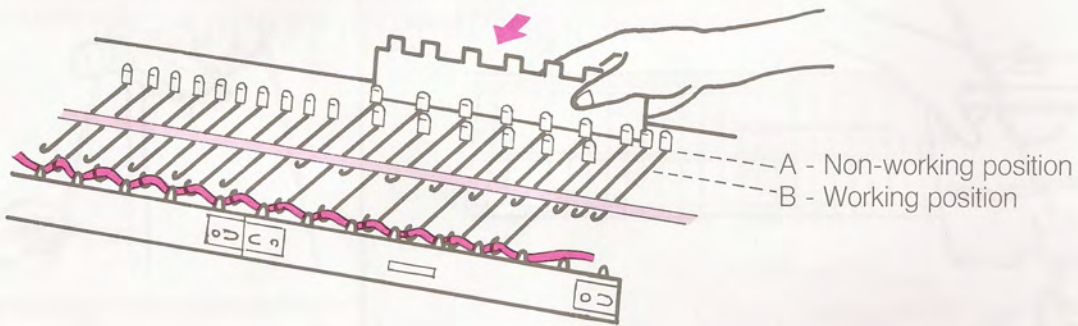

## 8. Knit in Stockinet.

Set the Row Counter to 000 by turning knob.

Move the Carriage at an even speed, ensuring the Carriage has passed the last knitted needle by approximately 3 ~ 4cms. before knitting the next row. Knit 3 rows and hang Claw Weights on both edges of the knitting. Continue to knit until Row Counter shows 020.

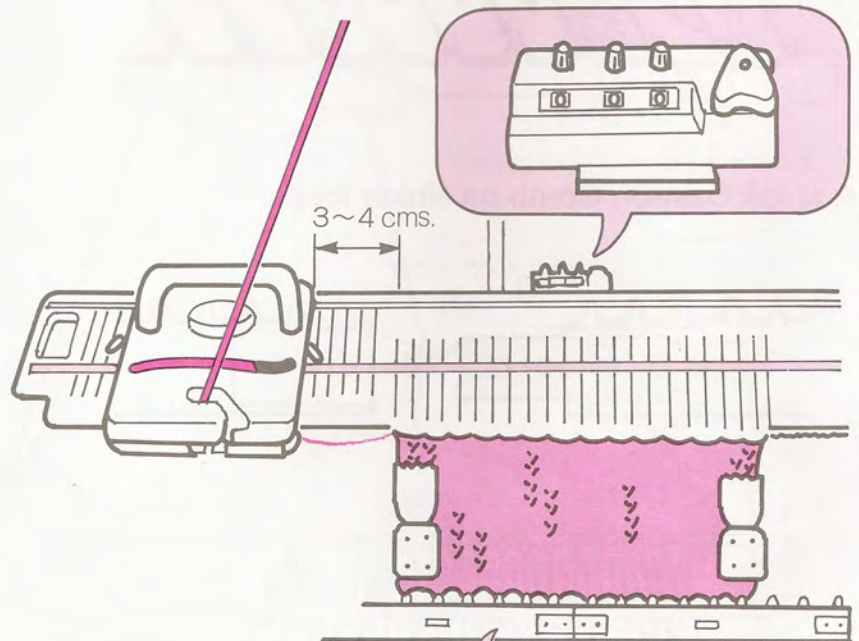

If the Carriage jams, do not push the Carriage by force. (see page 43)

Do not return the Carriage half-way or you will have drop stitches.

When you knit a garment move the combs and weights up every 20 ~ 30 rows.

## 9. Exchange yarn.

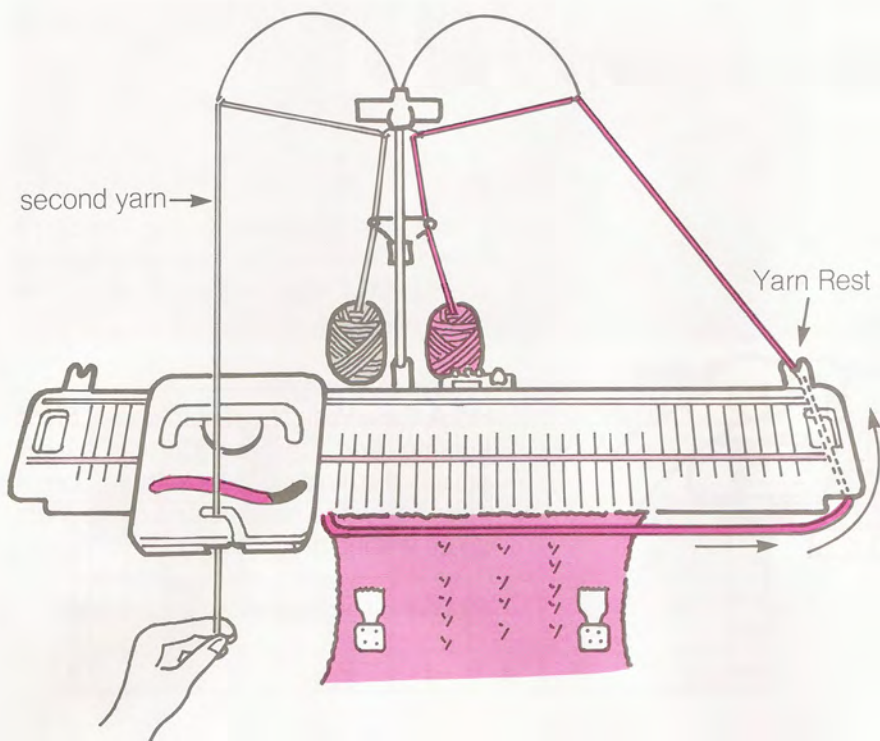

- ① Remove the first yarn from the Yarn Feeder ① and place it in the Yarn Rest. Make sure that the yarn through the right side of Auto-Tension is placed in the right Yarn Rest and the yarn through the left one is placed in the left Yarn Rest as shown.
- ② Thread the second yarn into the Yarn Feeder ① and knit the required number of rows.

## 10. What to do when the yarn is running out.

If there is not enough yarn to complete a row, remove the yarn from the Yarn Feeder and thread new yarn.  
 Note: If yarn is more than 3 times the width of knitting you can knit another row.

Knit 1 row and tie two yarn ends loosely at the edge.

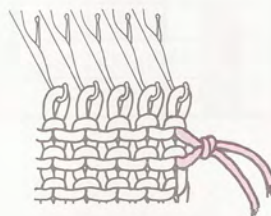

## 11. Remove the knitting from the machine.

- ① Remove Cast-on Comb and weights from the knitting. Remove yarn from the Yarn Feeder.

- ② Set the Carriage for Stockinet and move the Carriage once so the knitting will be removed from the needles.

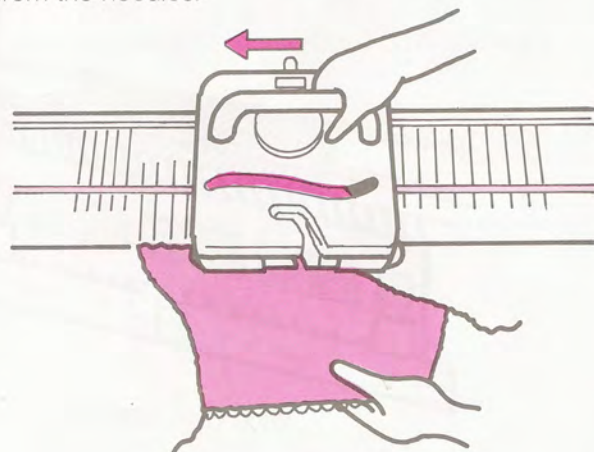
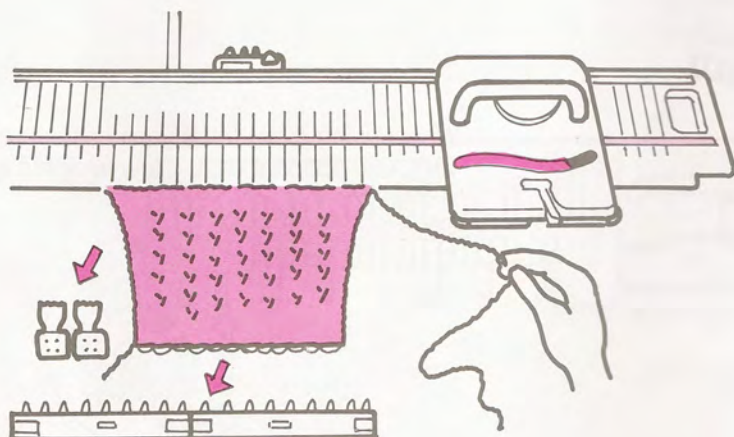

# PATTERN KNITTING

## Getting to know about pattern knitting

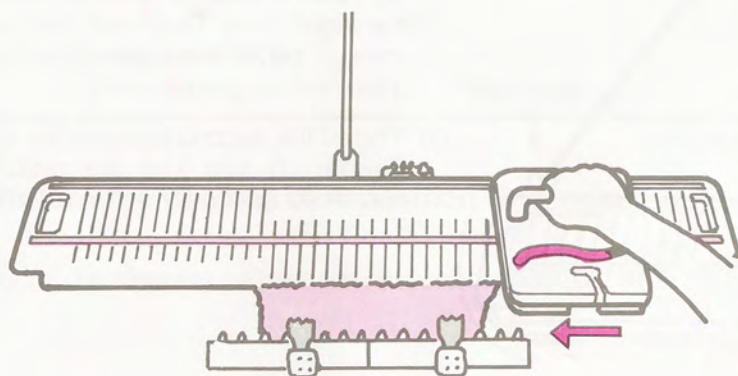

Before starting pattern knitting, knit 5 ~ 6 rows of Stockinet or waste knitting and place the Carriage on the right side of the Needle Bed.

Always use weights.  
Hook Claw Weights at both edges of the knitting and Cast-on Combs evenly across the knitting. (Hook them 3 ~ 4 rows below the needles and move them up as knitting progresses.)

Move the Carriage at an even speed.

### Pattern Chart

	①	②	③	④	⑤	⑥	⑦	⑧
8						II		→
7	■							←
6	■							→
5	■					I		←
4						II		→
3		■		■				←
2								→
1		■		■		I	▲	A ←

Follow the pattern chart from the bottom line (Order 1).

- ① Knitting Order
- ② Needle Position
  - .....Needles in B position or aligned back in B position.
  - .....Needles in D position.
  - .....Needles in C position.
- ③ Russel Lever (left)
- ④ Side Lever (left)
- ⑤ Side Lever (right)
- ⑥ Russel Lever (right)
- ⑦ Main Yarn Feeder (A and B stand for different yarns or different colours of yarn.)
- ⑧ Knitting Direction

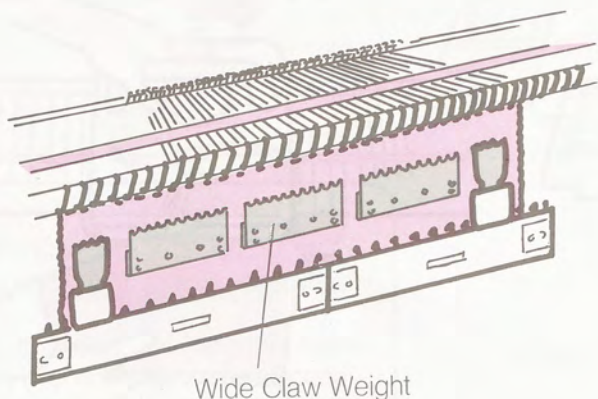

When using extra thick yarn or textured yarn, use optional Wide Claw Weights as shown.

# Tuck Stitch

(Knit side)

(Purl side)



8										II	→
7	■			■							←
6	■										→
5	■			■					I	←	
4									II	→	
3		■		■						←	
2										→	
1		■		■		I	▲	▲	I	A	←

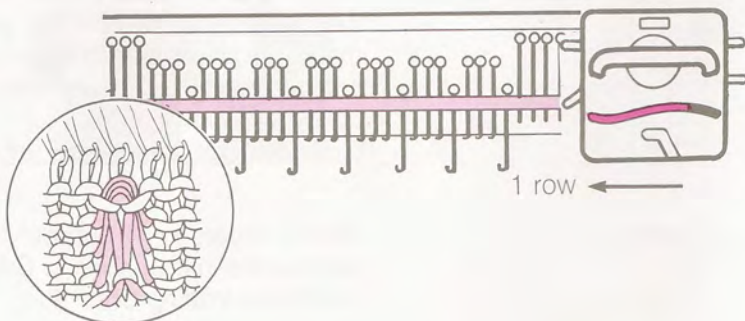
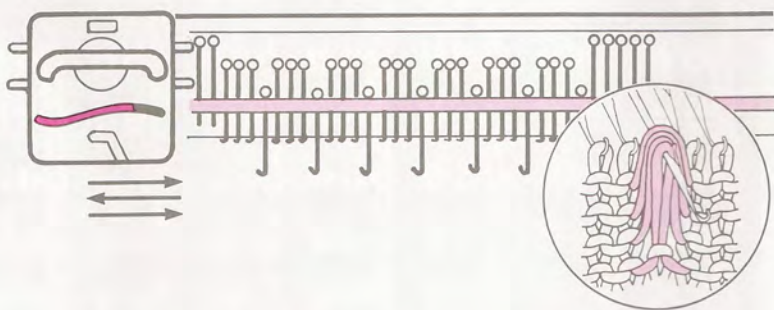
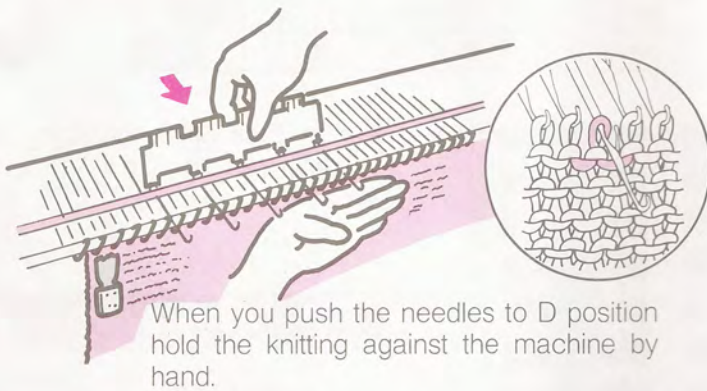

Tuck Stitch is formed by loops being held on the needles in D position for several rows, and a new stitch which knits those held loops together.

Knit the pattern following the pattern chart.

Note: Before starting a Tuck Stitch pattern, knit 1 ~ 2 rows in Stockinet with the main yarn.

Order 1 ~ 3.

As indicated in the bottom line of the pattern chart, Order 1, set the Carriage as follows.

Side Levers.....▲

Russel Levers.....I

Push the needles corresponding to the ■ mark to D position, using the 1 × 3 side of the Needle Pusher.

Place the yarn into the Main Yarn Feeder. Knit 1 row, the needles in B position knit, and the needles in D position will hold a loop.

Continue to knit 2 rows up to Order 3 on this setting.

Order 4.

Set the right Russel Lever to II and knit 1 row. The needles in B and D position knit and align in B position.

Order 5 ~ 7.

Referring to the pattern chart, push the needles corresponding to ■ mark to D position and set the right Russel Lever to I. Knit 3 rows.

Order 8.

Set the right Russel Lever to II and knit 1 row.

Repeat Orders 1 ~ 8 on the pattern chart.









## Plating

(Knit side)

(Purl side)



Two different colour yarns are knitted together. One yarn appears on the knit side while the second yarn appears on the purl side of the knitting.

Since two yarns are knitted together, use thinner yarns than for other patterns, and Stitch Dial must be set at the number which totals the Stitch Dial number for each type of yarn used. (e.g. if two tension 3 type yarns are used, knit at Stitch Dial 6.)

Cast-on with waste yarn.

Set the Carriage for Stockinet.

Side Levers.....▲

Russel Levers.....II

Thread the main yarn A through the left side of Auto-Tension and the plating yarn B through the right one.

Place the main yarn into the Main Yarn Feeder ①, and plating yarn into the Plating Yarn Feeder ②.

Knit in the same manner as done for Stockinet.

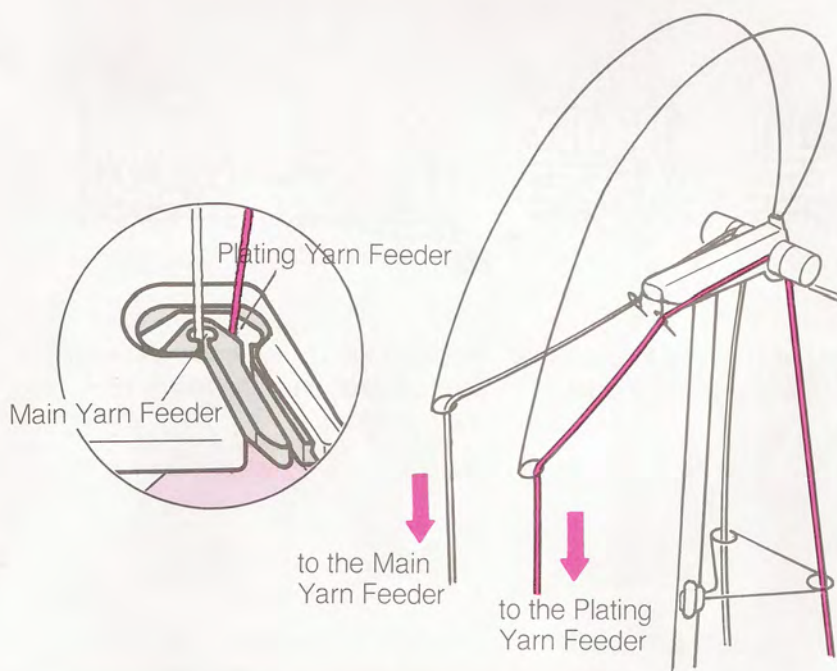
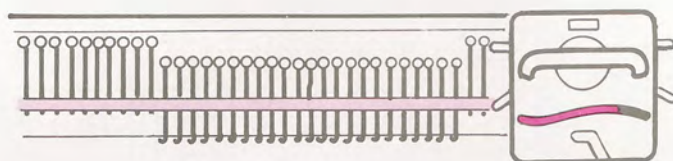

## Plating in Tuck Stitch



Work Tuck Stitch while knitting in Plating.

Knit 6 rows in Stockinet with thick yarn. Place thinner yarn into the Plating Yarn Feeder and knit 1 row in Plating. Push every 6th needle to D position and set both Russel Levers to I. Knit 3 rows. Set Russel Levers to II and knit 1 row. Remove the plating yarn from Plating Yarn Feeder and knit in Stockinet.



# Cable Stitch

Two stitch cable

Four stitch cable

Six stitch cable



Cable Stitches are formed by crossing a group of stitches over another group of stitches using two Transfer Tools.

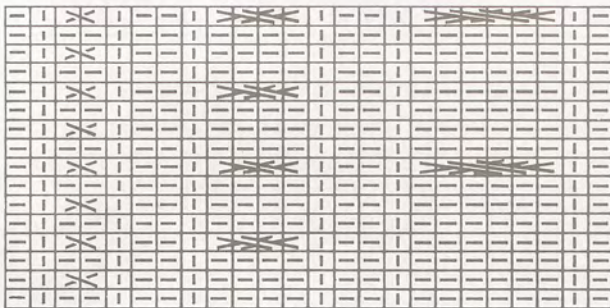

- I .....Knit Stitch
- .....Purl Stitch
- ⋈ .....Left over right
- ⋈ .....Right over left

Try a six stitch cable.  
Knit 8 rows in Stockinet and drop two stitches on each side of the stitches to be cabled.  
Cross the stitches as shown below.

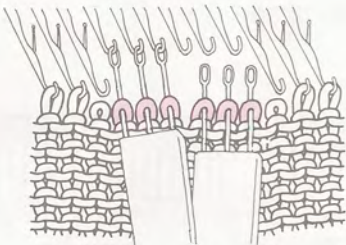

Using two 3-prong Transfer Tools, remove 3 stitches onto each Transfer Tool.

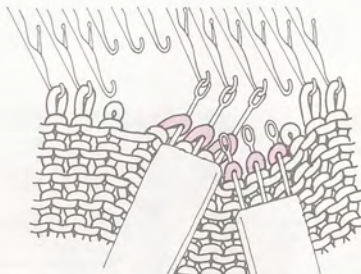

Cross the Transfer Tools over once.

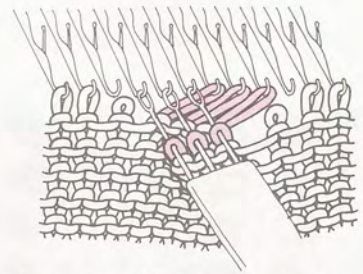

Place the left hand 3 stitches to the right hand needles.

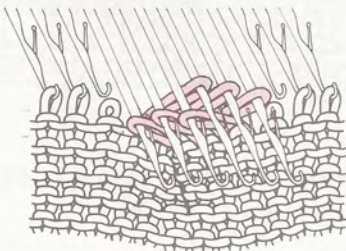

Place the remaining stitches onto the left hand needles.

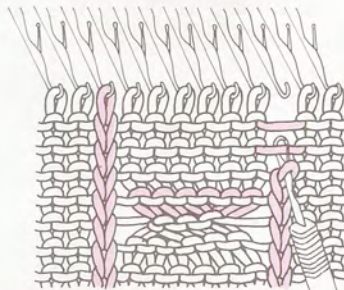

Unravel the dropped stitches right down to the first row, reform the stitches and replace on their needles.

Before continuing to knit, push the 6 cabled needles to D position and set Russel Levers to II.

# Lace Knitting



-	-	-	-	○	↗	○	-	-	-	-	-	-	-	-	-	-	-	-	-	
-	-	-	○	↘	-	↘	○	-	-	-	-	-	○	↘	-	↘	○	-	-	
-	-	○	↘	-	-	↘	○	-	-	-	-	○	↘	-	-	↘	○	-	-	
-	-	○	↘	-	-	↘	○	-	-	-	-	-	-	-	-	-	-	-	↘	○
-	-	-	-	-	-	-	-	-	-	-	-	-	-	-	-	-	-	-	-	-

- .....Purl Stitch
- ↗ .....Transfer stitch to right
- ↘ .....Transfer stitch to left
- .....Empty needle left in B
- ⤴ .....Transfer stitches to centre

Knit Stockinet, transferring a stitch to its adjacent needle.

Knit 2 rows in Stockinet and transfer stitches, following the 2nd row on the pattern chart as shown below.

10	9	8	7	6	5	4	3	2	1	
-	○	↗	-	-	-	-	-	↘	○	-

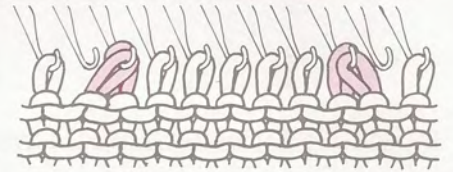

Knit 2 rows in stockinet and transfer stitches, following the 4th row on the pattern chart as shown below.

10	9	8	7	6	5	4	3	2	1
-	-	○	↗	-	-	-	↘	○	-

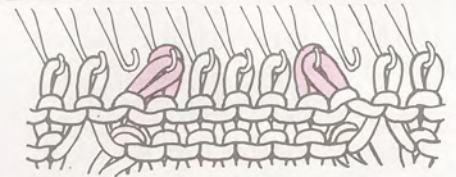

Repeat the above procedure, following the pattern chart.



○	/	/	↘	↘	\	\	○	-	○	/	/	↘	↘	\	\	○	-	-	-
-	-	-	-	-	-	-	-	-	-	-	-	-	-	-	-	-	-	-	-
○	/	/	↘	↘	\	\	○	-	○	/	/	↘	↘	\	\	○	-	-	-
-	-	-	-	-	-	-	-	-	-	-	-	-	-	-	-	-	-	-	-
-	-	-	-	-	-	-	-	-	-	-	-	-	-	-	-	-	-	-	-
○	/	/	↘	↘	\	\	○	-	○	/	/	↘	↘	\	\	○	-	-	-
-	-	-	-	-	-	-	-	-	-	-	-	-	-	-	-	-	-	-	-
○	/	/	↘	↘	\	\	○	-	○	/	/	↘	↘	\	\	○	-	-	-
-	-	-	-	-	-	-	-	-	-	-	-	-	-	-	-	-	-	-	-

Knit Stockinet, transferring several stitches to each direction.

Knit 2 rows in Stockinet and transfer stitches, following the pattern chart as shown below.

↘	↘	○	-	○	/	/	↘	↘	↘	↘	○	-
---	---	---	---	---	---	---	---	---	---	---	---	---



Use 3-prong Transfer Tool to transfer 3 stitches to the same direction.



## Open Work

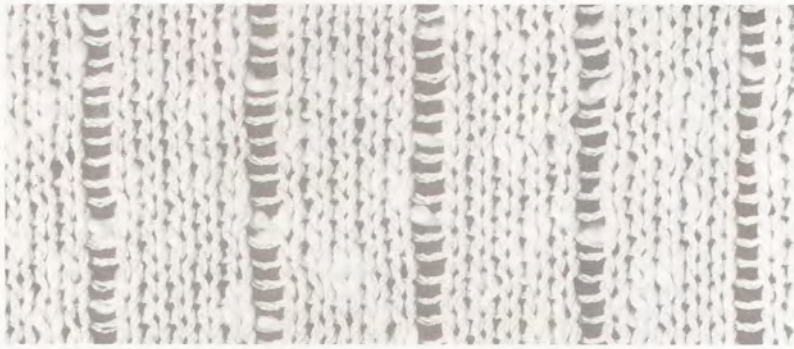

The interesting Rib. effect is created simply by leaving needles in A position at appropriate intervals while knitting Stockinnet.

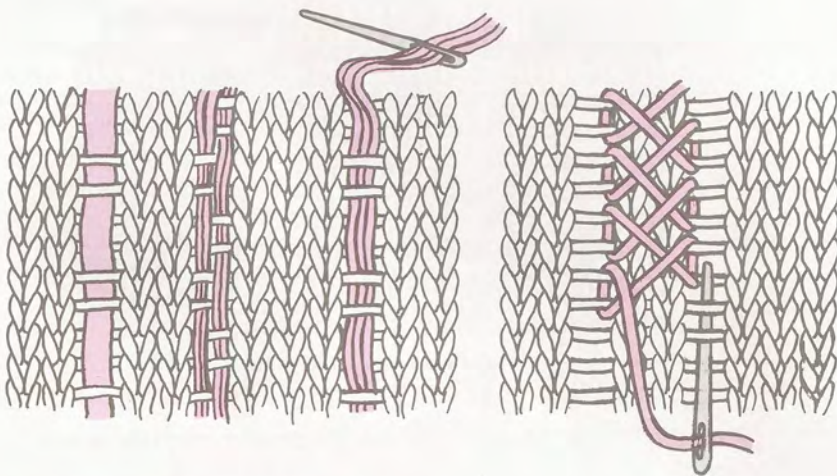

Thread braid, ribbon or yarns through the ladders left in knitting as shown. This is a very easy way of making a rich textured fabric using only the simplest of machine knitting stitches.

## Cord Knitting

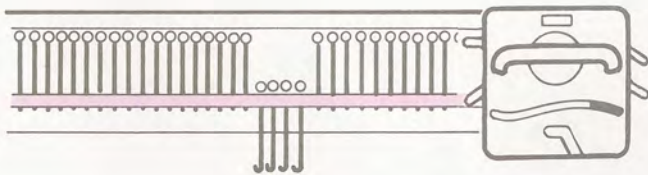

According to the thickness of the cord you desire, push 3 ~ 5 needles to D position and cast on the stitches by winding method as illustrated.

Set the Carriage as follows:

- Side Lever (left).....▲
- Side Lever (right).....●
- Russel Lever (both).....||

Note: Set Stitch Dial to lower number than for Stockinnet.

Knit 2 rows and push the needles to D position.

After knitting several rows, hang a Claw Weight on the cord and continue knitting until the desired length has been knitted.

Cut the yarn leaving 10cms. and cast off the stitches with a Tapestry Needle.

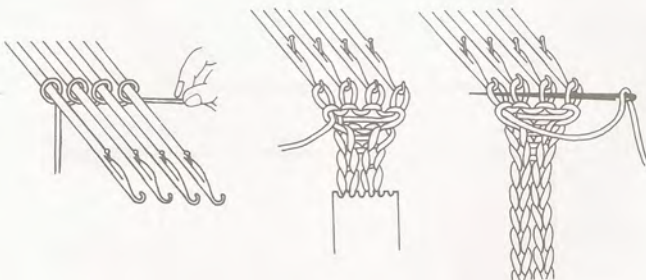



# Mock English Rib.



Knit Stockinet and purl the stitches at appropriate intervals, working Tuck Stitch.

Knit 10 rows and remove every 4th stitch from the needle, referring to the pattern chart.

Insert the Tappet Tool into the stitch on the first row and unravel the stitches.

□	-	-	-	□	-	-	-	□	-	-	-	-	-
□	-	-	-	□	-	-	-	□	-	-	-	-	-
□	-	-	-	□	-	-	-	□	-	-	-	-	-
□	-	-	-	□	-	-	-	□	-	-	-	-	-

- ..... Purl Stitch  
 □ ..... Reform the stitch every 2 rows

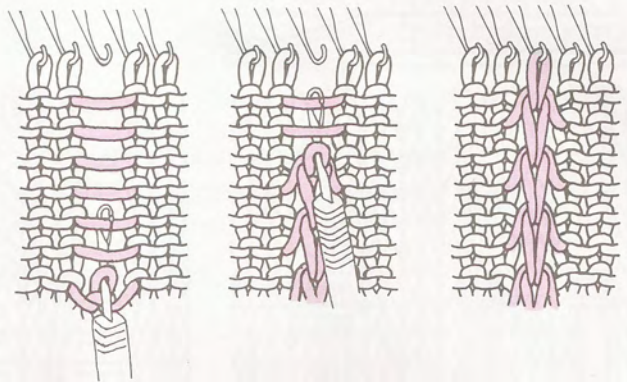

Pass the Tappet Tool behind the first loop and catch the second loop.  
 Pull it toward you.  
 Reform the stitches every 2 rows and replace on the needle as illustrated.

## To measure the tension swatch (How to use a Gauge Scale)

Allow the swatch to rest for several hours, to return to its natural condition after being stretched on the machine.

Press according to yarn manufacturer's instruction.



### Prepare a Gauge Scale (yellow scale)

This scale is so designed to get how many stitches and rows per 10cms., measuring between yarn marks on the swatch.

The scale has two sides. The side "S" is used for measuring stitches and side "R" is for rows.

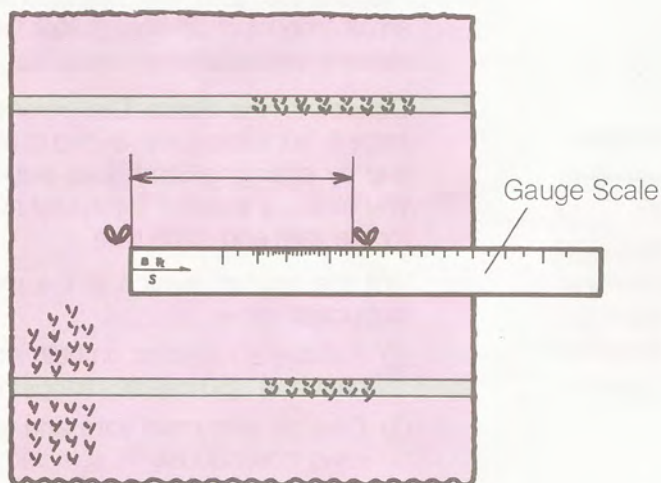

### Stitches (Horizontal)

Use the Gauge Scale with the "S" side up. Place the arrow end of the Gauge Scale inside the left stitch in contrast yarn. Measure to the inside of the right contrast stitch. The number at this point indicates how many stitches are required to knit 10cms.

The scale should be used from the edge indicated by the arrow, i.e. from the left edge.

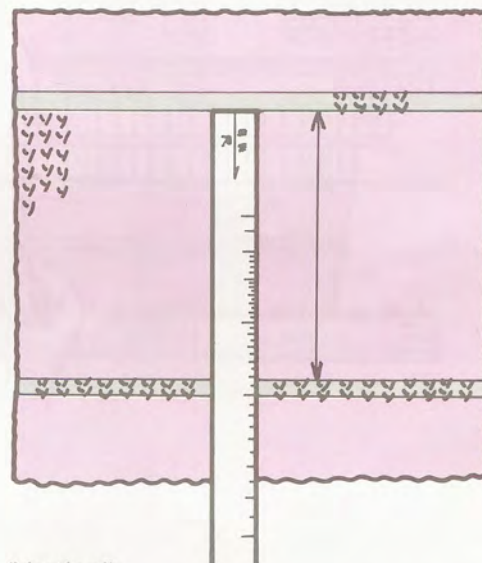

### Rows (Vertical)

Use the Gauge Scale with the "R" side up. Place the arrow end of the Gauge Scale at the top of the tension swatch, just below the rows knitted in contrast yarn. Measure to the inside of the two stockinet rows at the bottom of the tension swatch. The number at this point indicates how many rows are required to knit 10cms.

Take note of the Stitch Dial number and the Tension Gauge.

## Knitting a lady's pullover

The instructions below explain the procedure to knit a lady's pullover.

1. Take a tension gauge. (see page 25 ~ 26)
2. Calculate the number of stitches and rows for the selected pattern style, according to the tension gauge.

Note: If you own the optional Electronic Knit (Radar) Contour KR10, you have only to select a pattern from the Knit Pattern set which comes with KR10, or draw your original pattern in 1/2 or 1/4 scale on the Blank Pattern Paper.

3. Knit each piece in the following manner.

Sleeves (both alike)

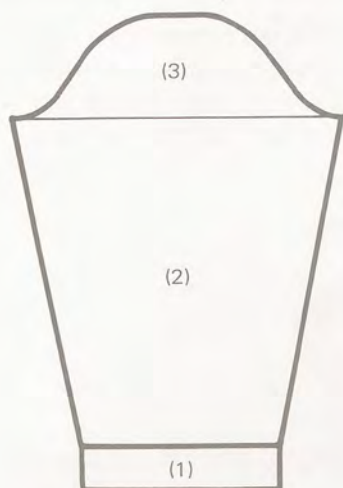

- (1) — Arrange the required number of needles for cuff and knit cuff in K1.P1. Rib. (see page 37 ~ 38)
- (2) — Knit underarm, increasing stitches at both edges according to the calculation. (see page 31)  
— Hang Claw Weights on both edges of the knitting.
- (3) — Knit sleeve cap, decreasing stitches at both edges as required. (see page 30 ~ 31)  
— Cast off the stitches on the last row. (see page 31 or 34)

Back

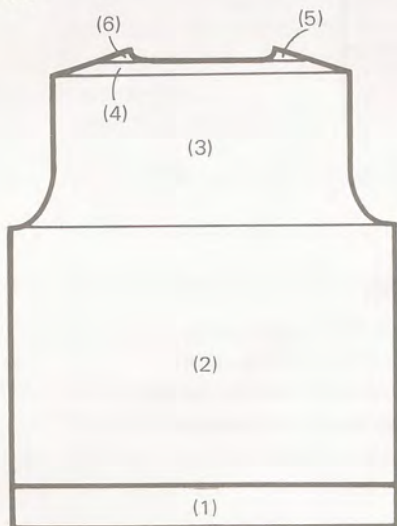

- (1) — Arrange the required number of needles for welt and knit welt in K1.P1. Rib. in the same manner as done for cuff.
- (2) — Knit up to armhole without shaping.
- (3) — Shape armhole by decreasing stitches according to the calculation.  
— Knit up to shoulder.
- (4) — Shape shoulder by partial knitting on each side with both Russel Levers at I, according to the calculation. (see page 32 ~ 33)

- (5) — At the centre back of the neckline, divide the work into three sections, i.e. right shoulder (c), centre straight (b) and left shoulder (a)

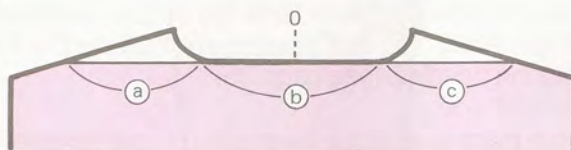

- Push the needles for the sections on the opposite side of Carriage to D position.
  - \* If the Carriage is on the right, push the needles for section (a) and (b) to D position and hang Claw Weights on both edges of section (c).
  - Shape neckline by decreasing stitches while shaping shoulder by partial knitting according to the calculation.
  - When the section has been completed, cut the yarn, leaving a length of yarn about three times the width of the section.
  - Knit 7~8 rows with waste yarn and remove the section from the machine.
  - Push back the empty needles to A position.
  - Push the needles for section (b) back to C position.
  - With waste yarn, knit 7~8 rows and remove the section from the machine.
  - Push back the empty needles to A position.
  - Thread the main yarn through Yarn Feeder.
- (6) — Knit the section (a) in the same manner as for section (c) but reverse shapings.

## Front

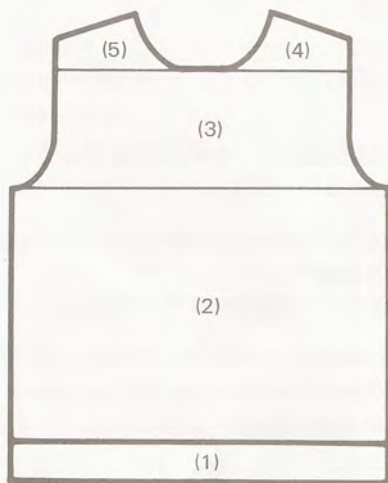

(1) ~ (3) Knit up to the centre front of the neckline in the same manner as done for back.

(4) — Divide the work into three sections, i.e. right shoulder (c), centre straight (b) and left shoulder (a)

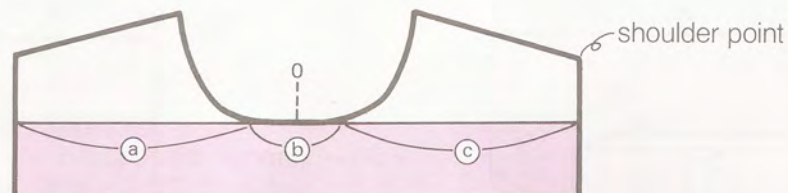

- Remove the yarn from Yarn Feeder.
- Remove the Carriage from Needle Bed by using Release Lever.
- Replace the Carriage on the opposite side.
- \* If the Carriage is on the right, replace it on the left and knit as follows.
- Push the needles for section (b) and (c) to D position. (see page 36)
- Knit 7~8 rows using waste yarn with both Russel Levers at I, and cut the waste yarn.
- Remove the section from the machine and push back the empty needles to A position.
- Push back the needles for section (b) to C position and knit 7~8 rows with waste yarn.
- Remove the section from the machine and push back the empty needles to A position.
- Remove the Carriage from the Needle Bed and replace it on the opposite side.
- Set both Russel Levers to II and thread main yarn through Yarn Feeder.
- Shape neckline by decreasing stitches as required.
- Shape shoulder by partial knitting according to the calculation with both Russel Levers at I.
- Note: If the Carriage is on the side of shoulder point, knit 1 more row to start partial knitting.
- When the section has been completed, cut the yarn, leaving a length of yarn about three times the width of knitting.
- Remove the piece from the machine and push back the empty needles to A position.
- (5) — Push the original needles for section (a) to B position and replace the stitches on the last row of the main knitting for this section onto the needles. (see page 35)
- Place the Carriage on the right side.
- Knit this section in the same manner as done for section (4) but reverse shapings.

## Neckband



- (1) — Arrange the required number of needles for neckband and knit in K1.P1. Rib.
- (2) — Knit 7~8 rows with waste yarn and remove the piece from the machine.

4. Make up in the following manner.

- (1) — Pin out each piece to correct shape and size with the wrong side up and press with a steam iron.
- (2) — Join right shoulder on the machine. (see page 40)
- (3) — Join neckband to neck edge on the machine as follows.
  - Push the same number of needles as the number of stitches for neckband to B position.
  - With the right side of back and front facing you, pick up the stitches from the neck edge evenly and place them onto the needles. (see page 35 ~ 36)

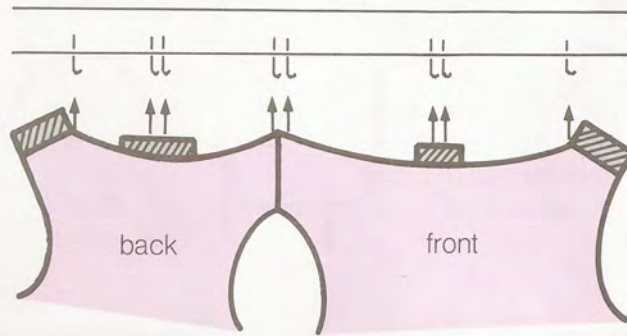

- Push the needles in B position to D position, holding the knitting against the machine by hand.
  - With the wrong side of neckband facing you, pick up the stitches on the last row of main knitting and place them onto the needle hooks in D position.
  - Push back the needles in D position to B position. The stitches of back and front neck edge will slip off the needles.
  - Close the stitches with back stitch method. (see page 34)
- (4) — Join the left shoulder in the same manner as done for right shoulder.
  - (5) — Join both ends of neckband by blind stitch. (see page 41)
  - (6) — Join side seams by blind stitch. (see page 41)
  - (7) — Join underarm seams by blind stitch.
  - (8) — Set in sleeves in the following manner.
    - Turn the garment to the wrong side and slip the sleeve into armhole, with the right side facing each other.
    - Pin them as illustrated.

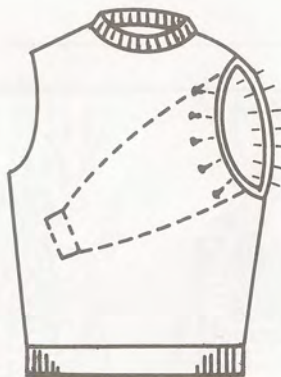

- Work slip stitch along the edges, using a crochet hook. (see page 42)

- (9) — Sew in yarn ends.

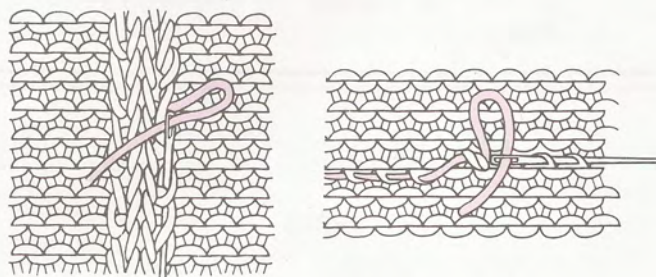

# KNITTING TECHNIQUES

## How to decrease stitches

Decrease stitches by using a Transfer Tool.

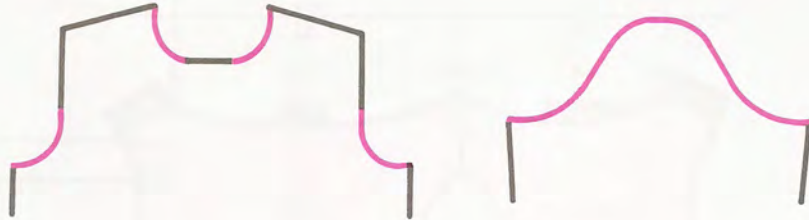

**Decreasing 1 stitch at the edge.** Use this method to shape neckline, armhole or sleeve cap.

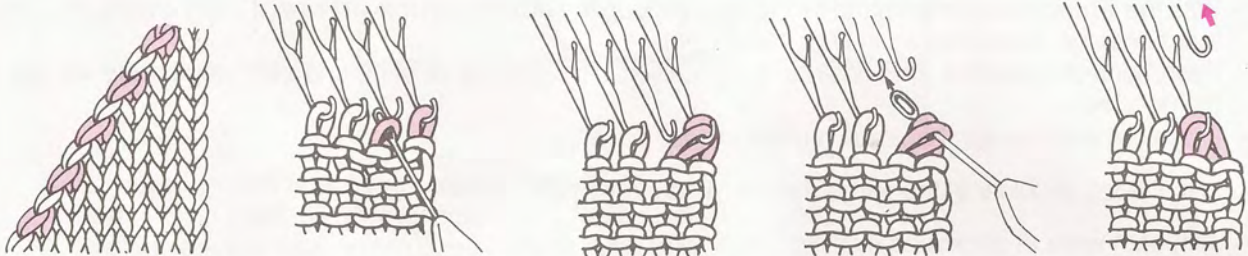

- ① Take the second stitch onto the Transfer Tool.
- ② Transfer the stitch onto the end needle.
- ③ Transfer both stitches onto the inside empty needle.
- ④ Push the end empty needle back to A position.

## Fully fashioned decreasing

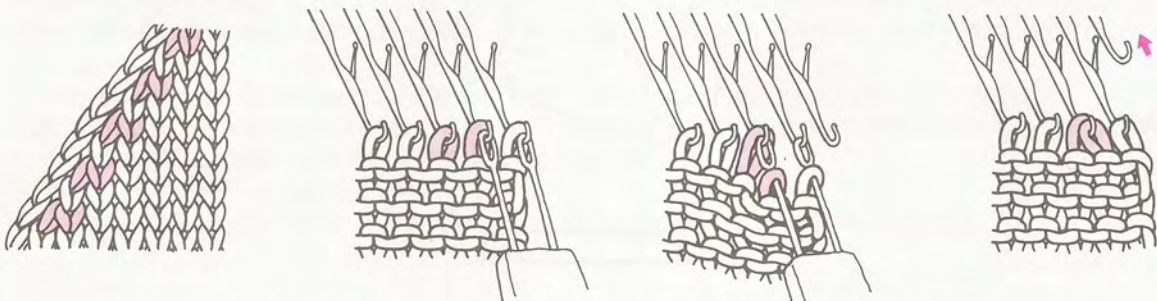

Use the 2-prong Transfer Tool.

- ① Take the two end stitches onto the Transfer Tool.
- ② Transfer the stitches one needle in.
- ③ Push back the empty needle to A position.

## Decreasing multiple stitches — Carriage side only

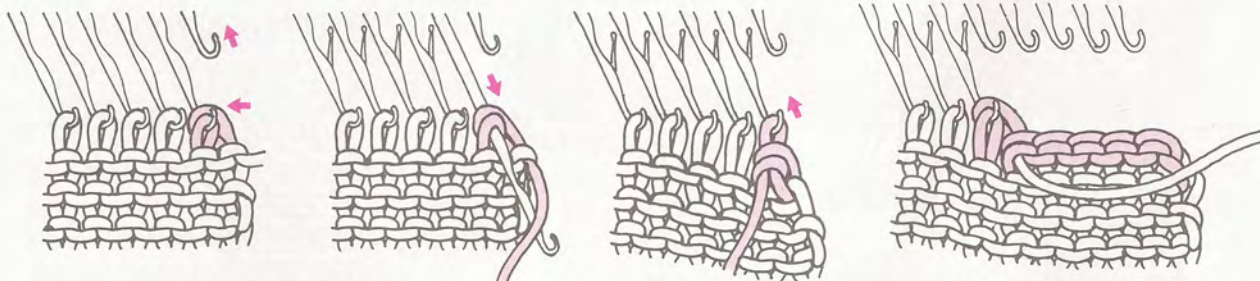

- ① Transfer the second stitch onto the end needle and both stitches onto the inside empty needle.
- ② Push the empty needle to A position. Lay the yarn across the open hook of the end needle from outside toward inside.
- ③ Hold yarn slightly down and push the needle back to B position. The two stitches slip off the needle.
- ④ Continue this procedure until the required number of stitches have been decreased. Place the last stitch to be decreased onto its adjacent needle. (Two stitches remain on this needle.)

## How to increase stitches

Use this method to shape underarm or side.



### Increasing 1 stitch at the edge

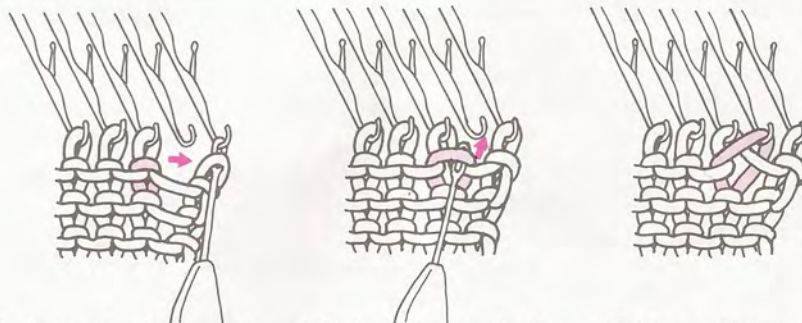
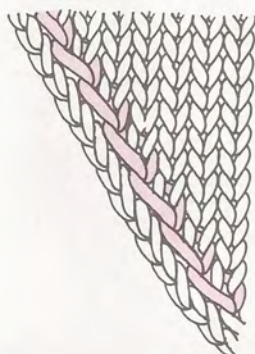

- ① Transfer the end stitch onto the adjacent empty needle with a Transfer Tool.
- ② Pick up the loop below the second stitch.
- ③ Place the loop onto the empty needle.

## Increasing multiple stitches — Carriage side only.

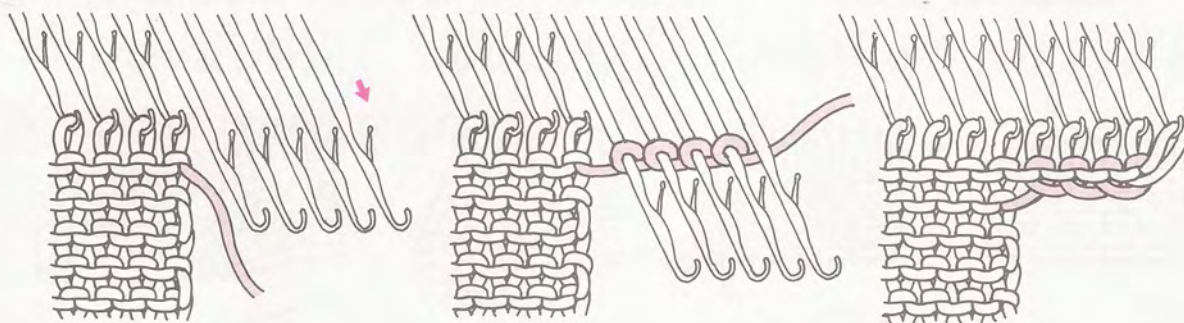

- ① Push the required number of needles for increase from A to D position.
- ② If the Carriage is on the right side, wind the yarn loosely around the empty needles in the anticlockwise direction. If the Carriage is on the left side, wind the yarn in the clockwise direction.
- ③ Set Russel Levers to II and continue to knit. In case of Russel Levers at I, push back the needles in D position to C position, then continue to knit.

After winding the yarn around the needles, make sure of eliminating the slack of yarn before knitting the next row.

## Partial knitting by decreasing stitches

This technique is used for shaping gently slanting lines such as shoulders, side darts, etc.

Set both Russel Levers to I.

When Slip Stitch and Fair Isle, push the needles to be knitted to C position instead of D position.

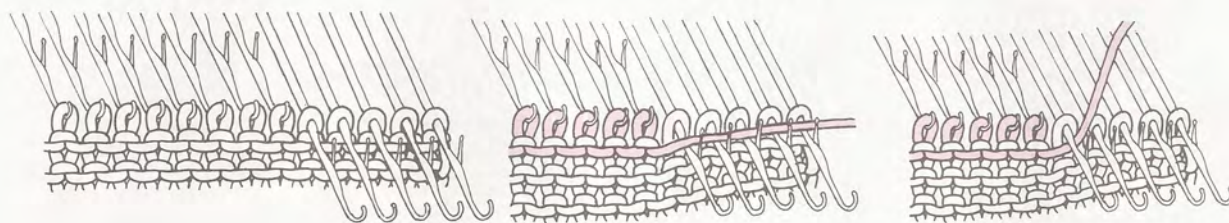

- ① Push the needles to be decreased to D position on the opposite side to the Carriage.
- ② Knit 1 row.
- ③ To prevent a hole from being formed in the fabric, pass the yarn under the first inside needle in D position and over the other needles.



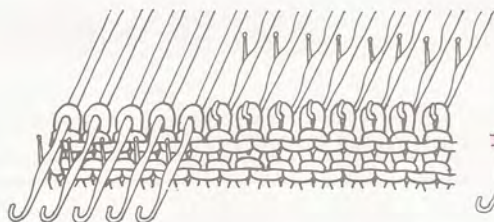

④ If partial knitting is required at both sides, push the needles to be decreased to D position on the opposite side to the Carriage before knitting the next row.

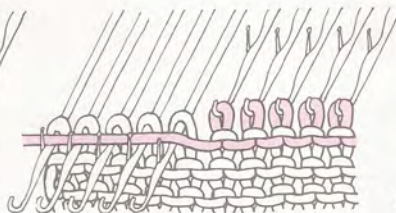

⑤ Knit 1 row.



⑥ Pass the yarn under the first inside needle in D position and over the other needles.

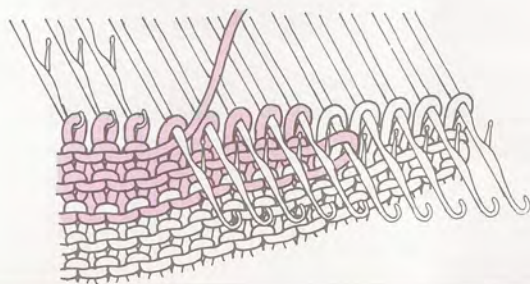

⑦ Repeat steps ① ~ ⑥.

If, when knitting in Tuck Stitch, you want to knit the needles in D position after completing partial knitting, push back the needles in D to C position while setting Russel Levers to II for the other types of stitch.

## Partial knitting by increasing stitches

This is used for shaping a gentle slope, such as bottom of skirt.

Set both Russel Levers to I.

When Slip Stitch and Fair Isle, push the needles to be knitted to C position instead of D position.

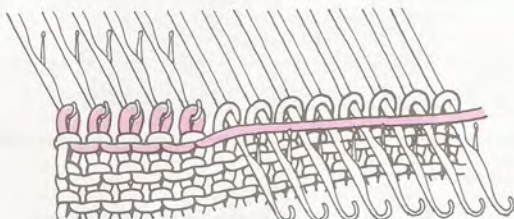

① Push all working needles to D position. On the Carriage side, push the needles to be increased back to C position and knit 1 row.

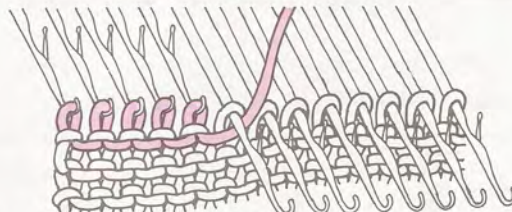

② To prevent a hole from being formed in the fabric, pass the yarn under the first inside needle in D position and over the needles. (If partial knitting is required at both sides, push back the needles to be increased to C position on the opposite side to Carriage.)

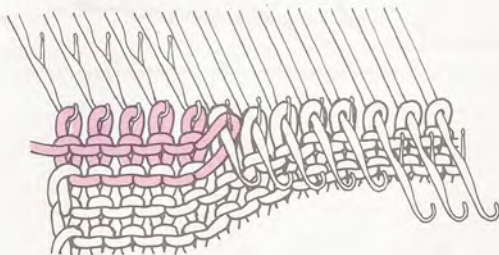

③ Knit 1 row and first operation of partial knitting has been completed. Push the needles to be increased back to C position.

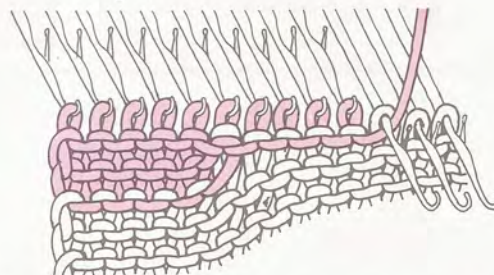

④ Knit 1 row and pass the yarn under the first inside needle in D position and over the other needles. Repeat the same procedure until the partial knitting has been completed.

## Back stitch method

This is used to close the open stitches.

Prepare a length of yarn about three times the width of the knitting and thread the tapestry needle with it.

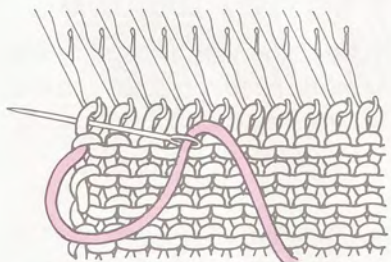

① Insert the tapestry needle into the first stitch and pull the yarn.

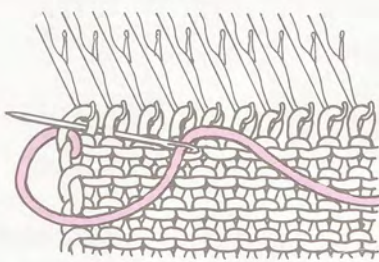

② Insert the tapestry needle in through the second stitch and out through the first stitch.

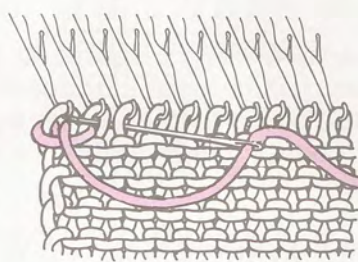

③ Insert the tapestry needle in through the third stitch and out through the second stitch.

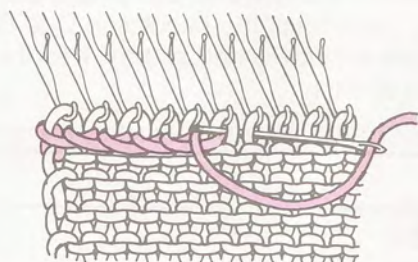

④ Repeat steps ② ~ ③. Close the last stitch by oversewing once.

(Knit side)

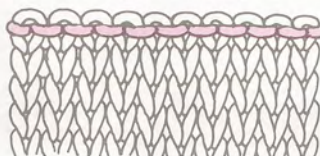

## How to use Ravel Cord

Ravel Cord is used for casting on, holding stitches, separating waste knitting from main knitting, etc. The instructions below explain how to knit with Ravel Cord and remove waste knitting.

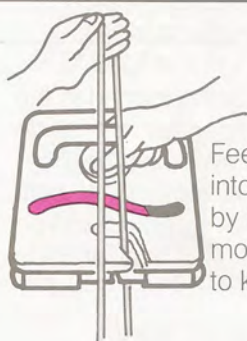

Feed the Ravel Cord into the Yarn Feeder by hand and slowly move the Carriage to knit.

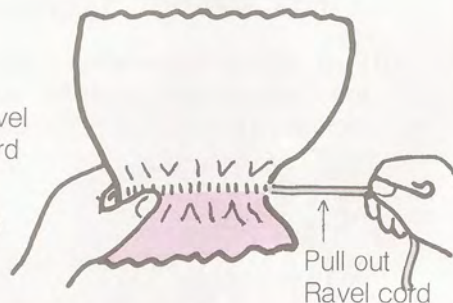
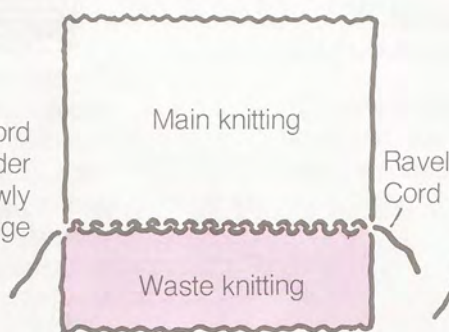

Pull out Ravel cord

## Waste knitting

Since the open stitches are unstable, waste knitting is required before and after the main knitting.

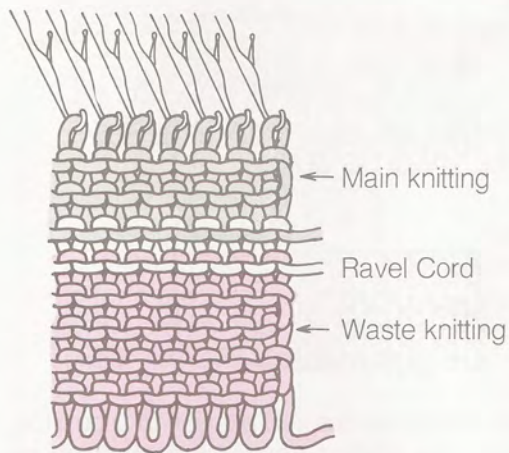

- ① Cast on and knit 7 ~ 8 rows in Stockinet with waste yarn.
- ② Knit 1 row with Ravel Cord.  
The reason of knitting with Ravel Cord is for removing the waste knitting from main knitting simply by pulling out the Ravel Cord, as the stitches can not be unraveled smoothly from the first row of the knitting.
- ③ Knit with main yarn.  
Leave the waste knitting and Cord attached until you have completed the piece.

When removing the knitting from the machine, knit several rows of waste knitting right after the main knitting, as the stitches can be unraveled easily from the last row of the knitting.

## How to pick up the stitches left on waste knitting

With the purl side of the knitting facing you.

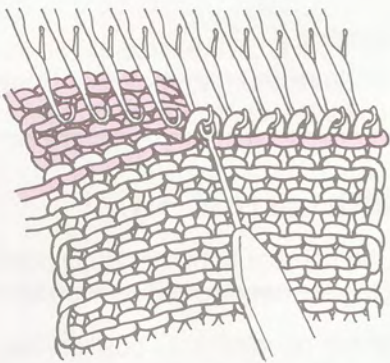

Pick up the stitches of the last or first row knitted in main yarn, with the waste knitting folded down away from you.

With the knit side of the knitting facing you.

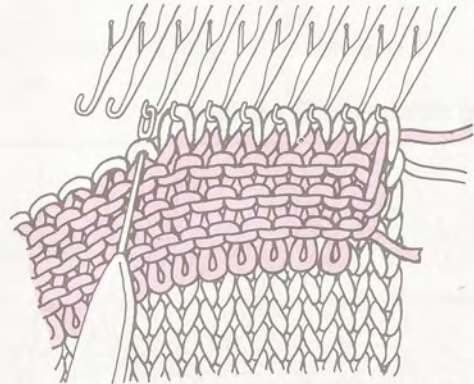

Pick up the stitches of the last or first row knitted in main yarn, with the waste knitting folded down toward you.

## How to pick up the stitches from the side edge of the knitting

This is used for knitting front band or sleeve from the edge continuously.

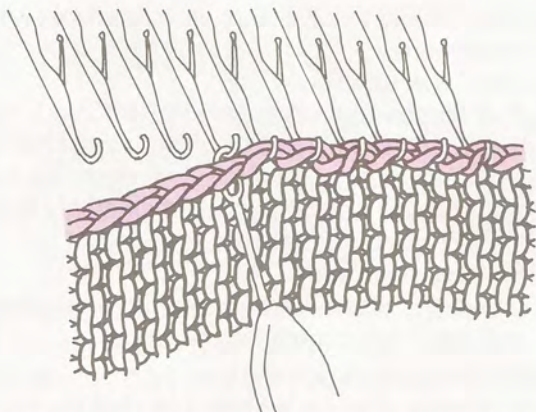

① Pick up the loops between the last two stitches from the side edge with the wrong side of the knitting facing you, omitting a stitch at appropriate intervals, and place them onto the needles. (Adjust the number of stitches to be picked up according to the tension gauge.)

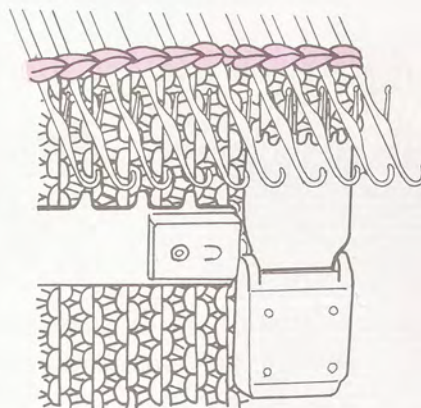

② Push all the needles in B position to D position, holding the knitting against the machine by hand. (The stitches move behind the latches.)

③ Hang Cast-on Comb and Claw Weights and knit with Russel Levers at II.

## How to hold stitches

This is used for dividing the work into sections like a case of shaping neckline.

### Holding stitches in D position.

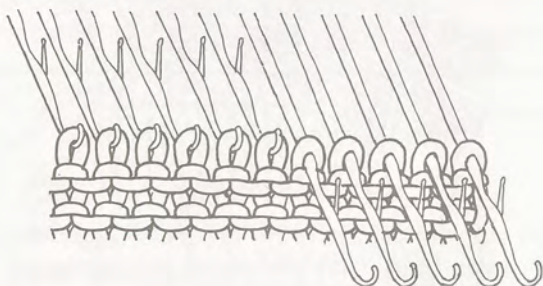

① Set both Russel Levers to I.

② Push the needles to be held to D position and knit. (Only the needles in B position are knitted.)

③ To knit the needles in D position, set Russel Levers to II, or push the needles back to C position.

## Holding stitches with Ravel Cord.

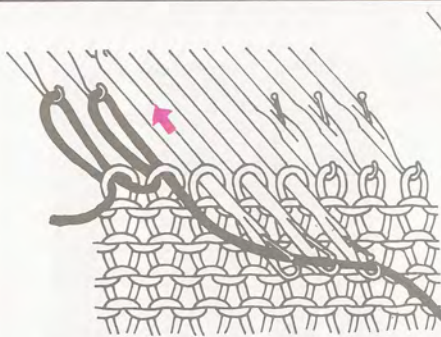

① Push the needles to be held to D position and lay the Ravel Cord across the hooks. Starting from the end needle, knit Ravel Cord needles back to A position manually one by one.

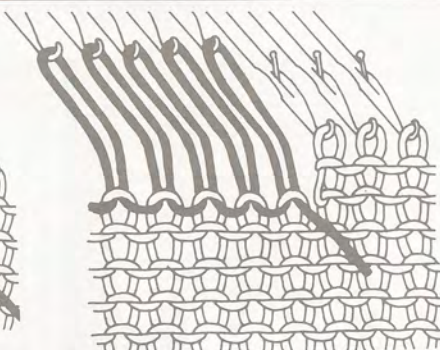

② Knit with main yarn, making sure that the needles are correctly placed in A position before knitting each row.

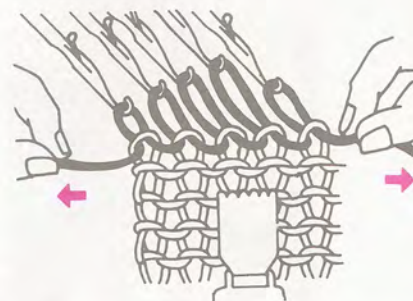

③ To bring the needles in A position back to B position, hang Claw Weights on the knitting and pull both ends of Ravel Cord by hands. When the needles are brought to B position, hold the left end of Ravel Cord and pull the other end in an upward motion so the stitches are replaced in the hooks.

## How to knit K1.P1.Rib.

This is used to have closed edge cast-on of K1.P1. Rib.

It is recommended to set the Stitch Dial 1~2 numbers lower than the original number of the tension swatch i.e. If the tension swatch was knitted at 7, set the Stitch Dial to 5.

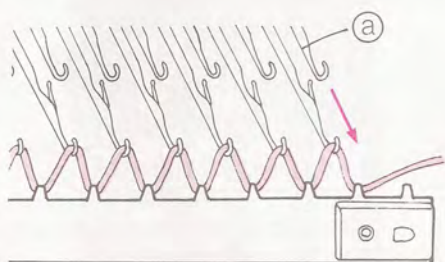

① Push the required number of needles to B position. Push back every other needle in B position to A position, starting from the second needle from left edge. Knit 1 row with waste yarn and hang Cast-on Comb on sinker loops. Push right end needle ① which was pushed back from B to A position previously to B position.

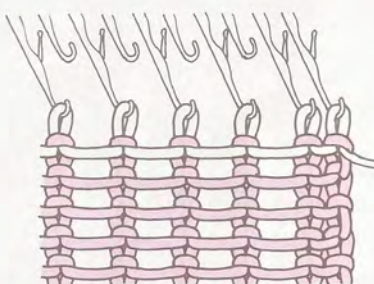

② Knit 7 ~ 8 rows, finishing with the Carriage on the left. Knit 1 row with Ravel Cord.

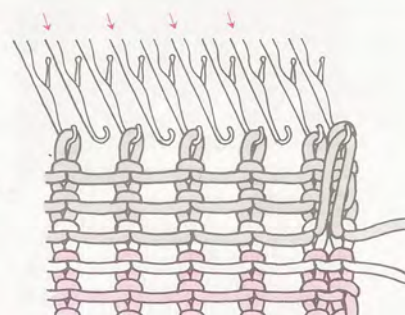

③ Set the Stitch Dial to R and knit 3 rows with main yarn. Pick up the right end loop of the first row of main knitting and place it onto the end needle. Bring the alternate needles which were pushed back to A position previously to B position.

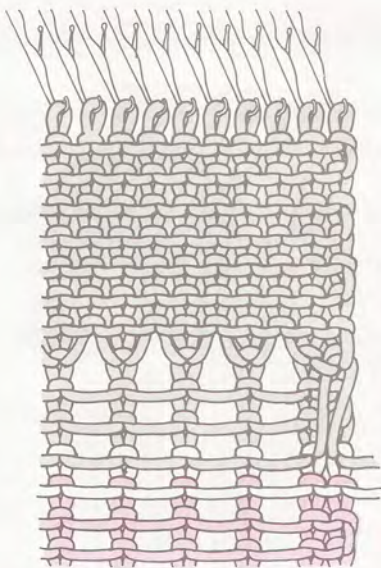

- ④ Set the Stitch Dial 2 numbers lower than the main tension. Knit the number of rows required for the finished rib.

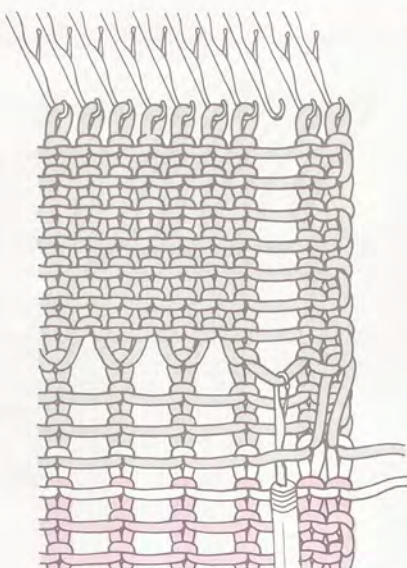

- ⑤ Remove the Comb and Weights. Push the third needle from right edge to D position and then back to B position. The stitch will have dropped off. Undo the stitches right down to the Ravel Cord with your finger. Insert a Tappet Tool under the loop of the first row of main knitting. Skip the next two bars, then catch the yarn of the fourth row in the hook of the Tappet Tool.

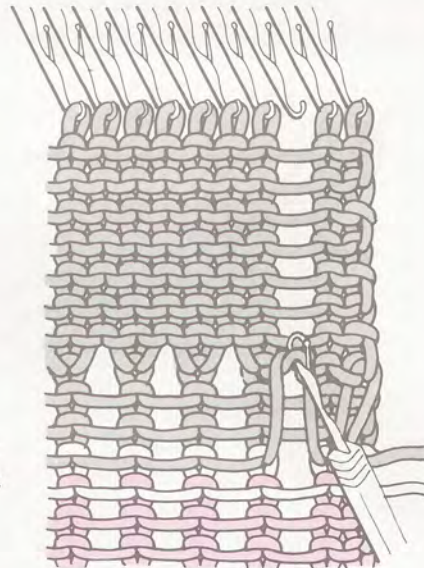

- ⑥ Pull the tool toward you, holding the knitting downward by hand, and the first loop will slip over the hook of the tool forming a new stitch.

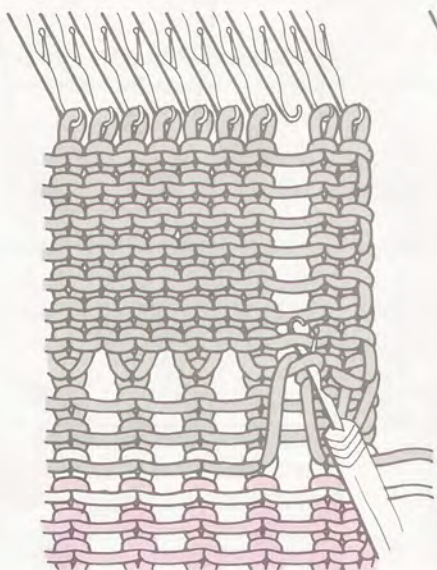

- ⑦ Slide the stitch on the tool behind the latch, catch the next bar of yarn in the hook and pull that through.

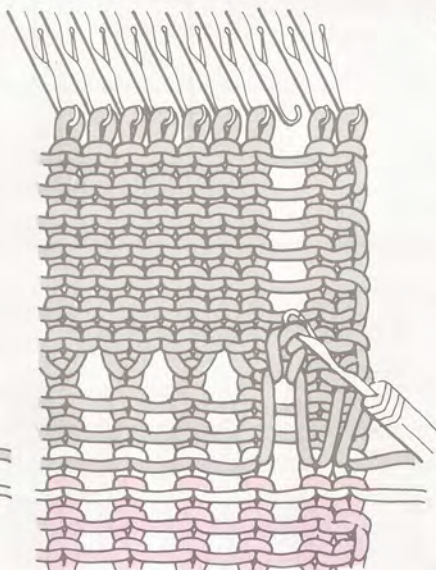

- ⑧ Repeat in the same manner until the stitch of the last row knitted has been formed, and replace this on the needle.

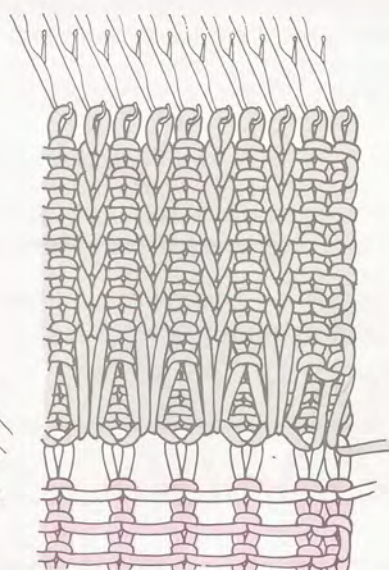

- ⑨ Undo and reform each alternate stitch in the same way. Leave the waste knitting and Ravel Cord attached until you have completed the piece, and taken it off the machine. Then pull out the Cord to remove the waste knitting.

## How to close the stitches of K1.P1.Rib.

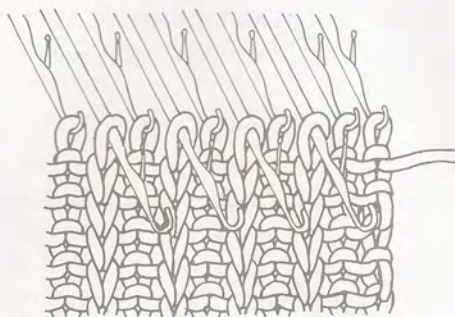
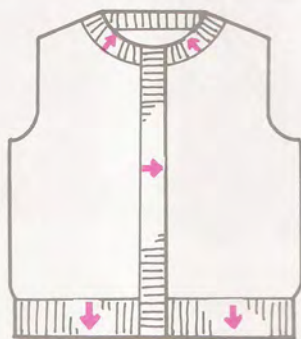

① After reforming alternate stitches, push the needles with reformed stitch to D position.

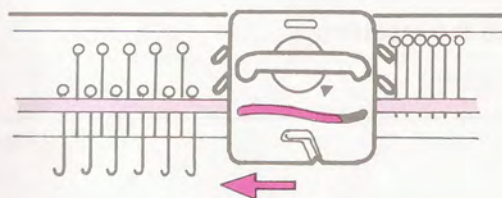

② Set the Side Levers to ● and Russel Levers to II.

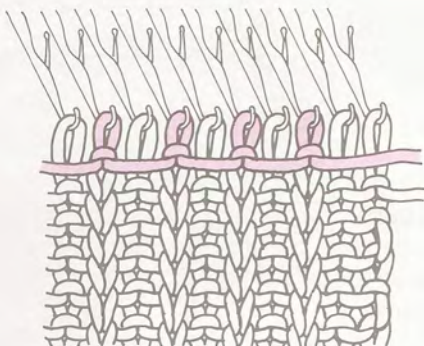

③ Knit 1 row with waste yarn. Only the needles which were pushed to D position are knitted.

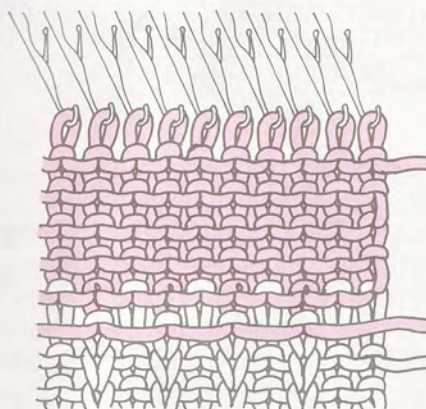

④ Set the Side Levers to ▲ and knit 7 ~ 8 rows with waste yarn. Remove the knitting from the machine.

⑤ Close the stitches of K1.P1. Rib. in the following manner.

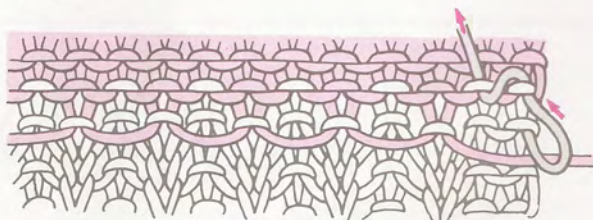

① Fold down the waste knitting away from you and insert the yarn threaded through the tapestry needle into the first stitch from the front. Guide the yarn into the second stitch from the front.

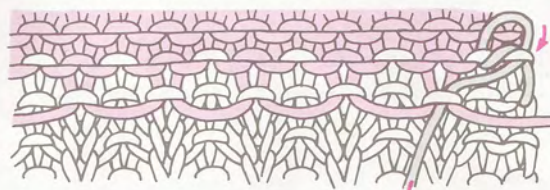

② Guide the yarn into the first stitch again from the back and also into the third stitch.

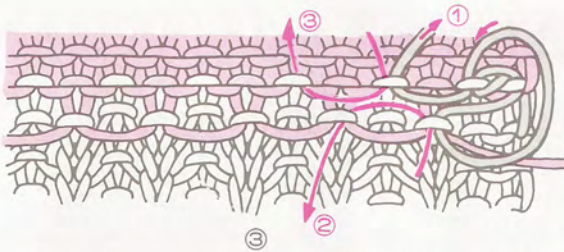

Guide the yarn into the second stitch again and pull it out from the fourth stitch. Guide the yarn into the third stitch and pull it out from the fifth stitch. Guide the yarn into the fourth stitch and pull it out from the sixth stitch.

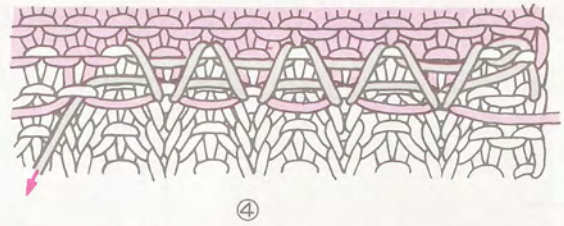

Repeat the above procedure for the remaining stitches. Every stitch must be worked twice.

## How to join

### Joining on the machine.

(Stitch to stitch)

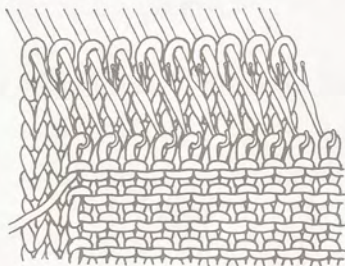

① With the right side of the first piece facing you, pick up the main yarn stitches on the last or first row and place them onto the needles. Push the needles to D position, holding the knitting against the machine by hand so the stitches move behind the latches. With the wrong side of the second piece facing you, pick up the main yarn stitches on the last or first row and place them onto the needle hooks in D position.

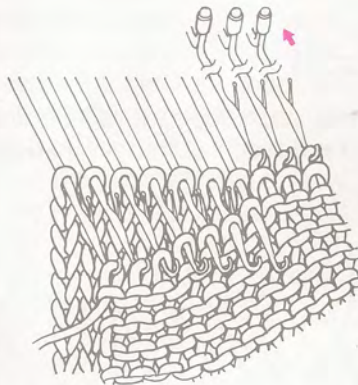

② Push the needles back to B position so the stitches behind latches slip off the needles and over the stitches in the hooks. Unravel waste knitting on each piece.

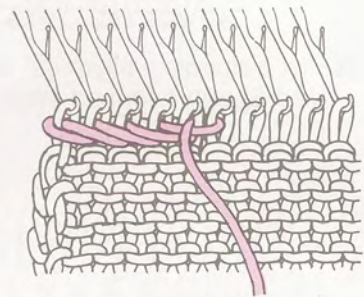

③ Close the stitches with the back stitch method, using a tapestry needle.



(Open stitch to side edge)

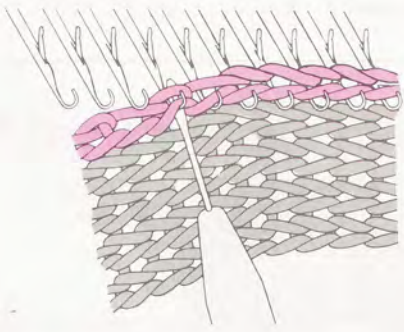

① With the right side of the first piece facing you, pick up the stitches on the side edge, omitting a stitch at appropriate intervals, and place them onto the needles.

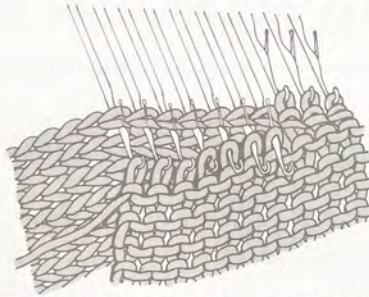

② Push the needles to D position, holding the knitting against the machine so the stitches move behind the latches. With the wrong side of the second piece facing you, pick up the main yarn stitches of the last or first row and place them onto the needle hooks in D position. Push back the needles to B position so the stitches behind the latches slip off the needles and over the stitches in the hooks.

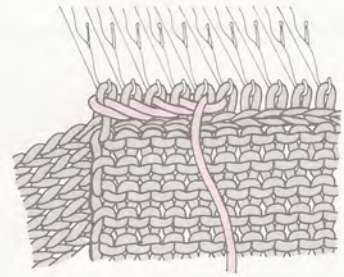

③ Remove the waste knitting. Close the stitches with back stitch method, using a tapestry needle.

**Blind stitch** This is used for joining side or underarm seams.

(Knit side to be worn)

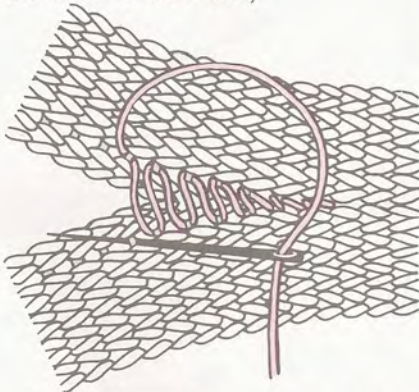

Pick up each sinker loop between the last two stitches from the side edge.

(Purl side to be worn)

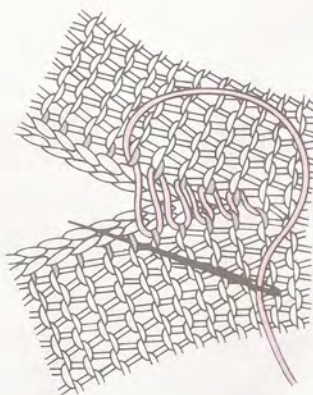

(K1.P1. Rib.)

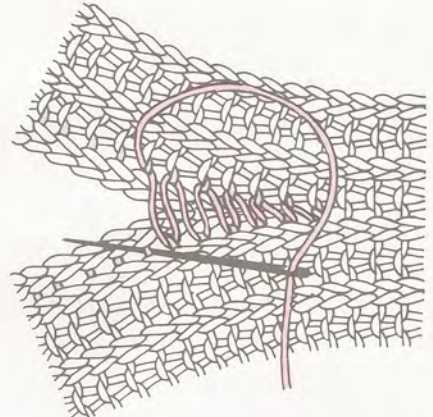

**Grafting**

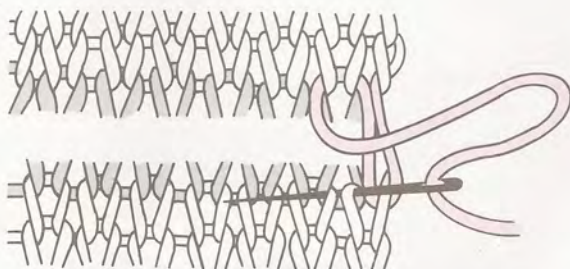

This is used for joining two open rows where ridges formed by seaming should be soft to the touch.

Align both fabrics as shown and thread knitting yarn through the stitches with the tapestry needle.

## Slip stitch

This is used for setting in sleeve or joining side seam.

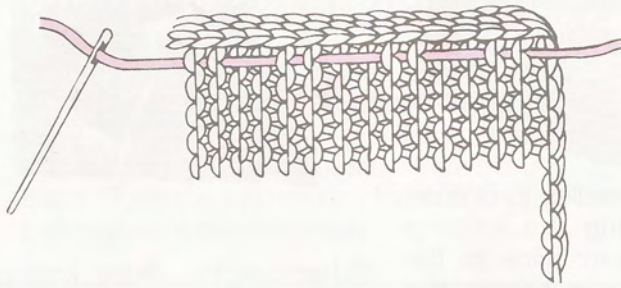

① Place the pieces to be joined with the right side facing each other, then do a short-stitch basting using a tapestry needle.

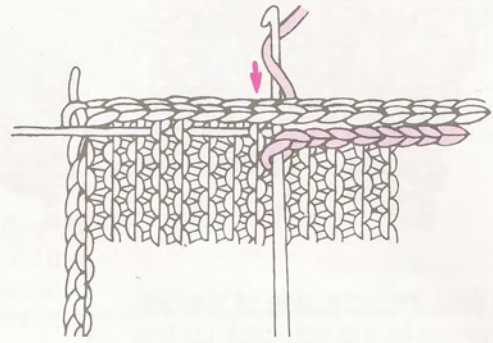

② Insert the crochet hook into each sinker loop between the last two stitches from the edge and catch the yarn, pull back the crochet hook and then insert it into the next loop.

# HELPFUL HINTS

## If the Carriage has jammed...

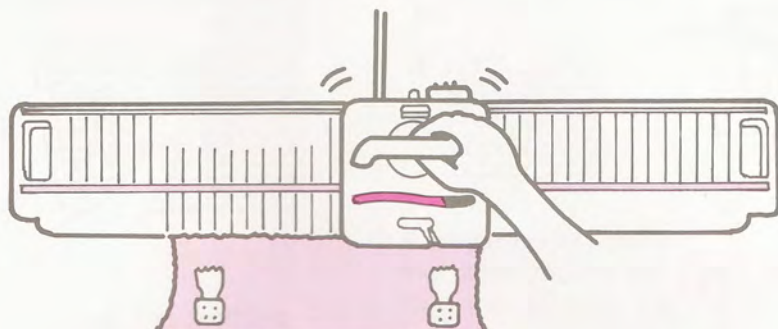

Remove the yarn from the Carriage.

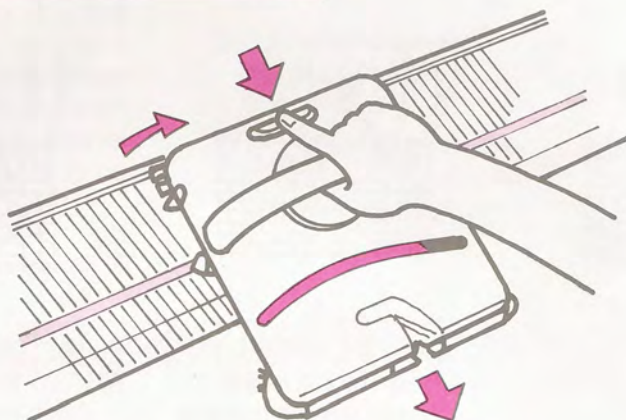

Remove the Carriage and place it on the Needle Bed at the beginning of the row on which it jammed. (Refer to page 4.) Return the Row Counter if it was fed for the row.

## To unravel a row of knitting on the machine

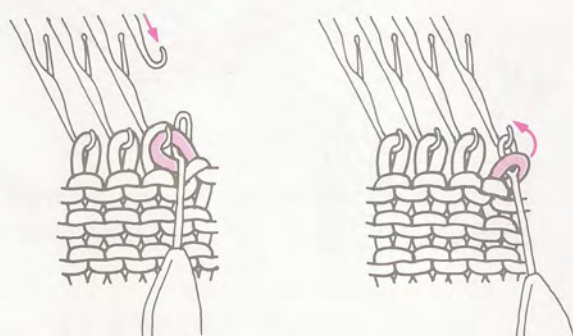

Hang Claw Weights at both edges of the knitting.

If the knitting has been shaped by decreasing at the edge place the stitch back on its original needle.

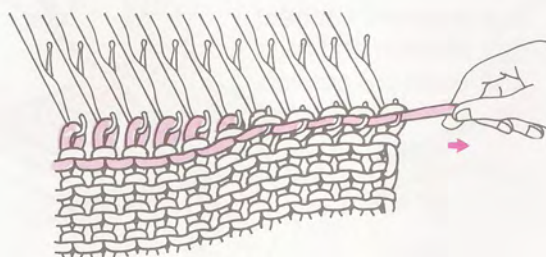

① Holding the knitting down by hand, pull the yarn sideways to tighten the stitches.

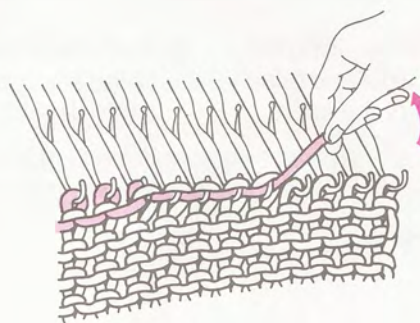

② Lift the yarn upward and very slightly backward. The stitches of the previous row will slip back into the needle hooks.

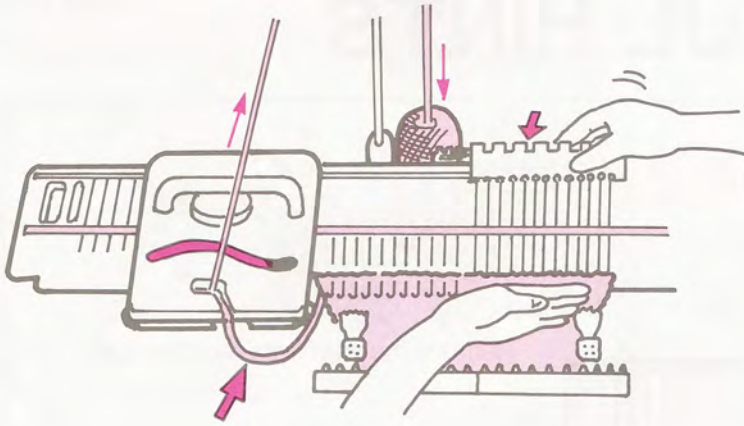

- ③ When you have unraveled as many rows as you need, hold the knitting against the machine by hand and bring the needles to D position.
- ④ Turn the Row Counter back the same number of rows as you have unraveled.
- ⑤ Pull the yarn down toward the ball or cone to eliminate slack yarn and continue to knit.

## To pick up a dropped stitch



- ① Insert a prong of Transfer Tool into the stitch one row below the dropped one.

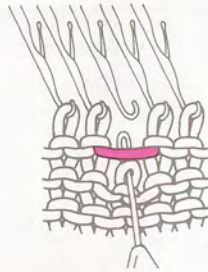

- ② Unravel the dropped stitch, holding the stitch below on the Transfer Tool.

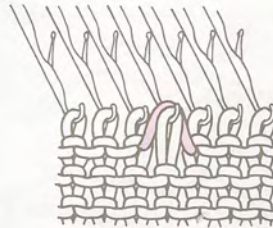

- ③ Replace stitch onto the empty needle together with the bar above the stitch.

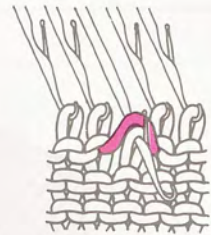

- ④ Push forward the needle till the stitch and the bar are behind the latch.

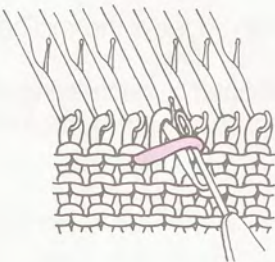

- ⑤ Lift up the bar using the Transfer Tool and bring it in front of the latch.

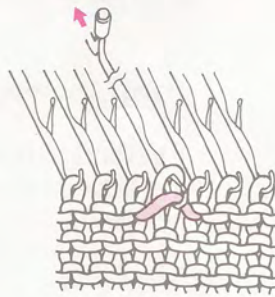

- ⑥ Push back the needle till the stitch behind the latch slips off the needle.

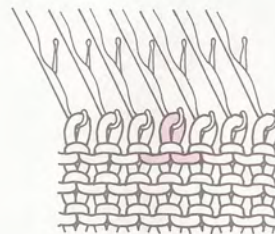

- ⑦ Push the needle back to A position to correct size of stitch and align the needle in B position.

## If a dropped stitch has run down for several rows...

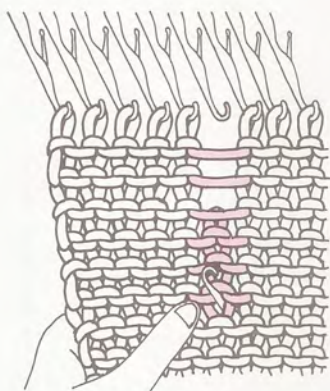

① Holding the knitting with your hand, insert the Tappet Tool into a stitch a few rows below the dropped stitch from the rear side. Unravel the stitches down to the Tappet Tool.

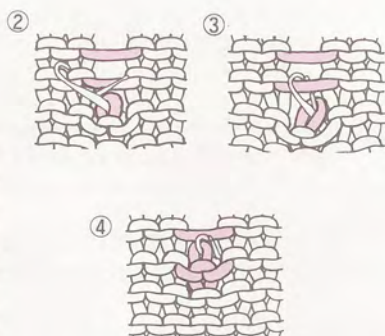

- ② Push the tool forward till the stitch moves behind the latch of the tool.
- ③ Pull the tool back catching the bar above inside to hook.
- ④ The stitch behind the latch slips off the tool and knits through the bar in the hook.

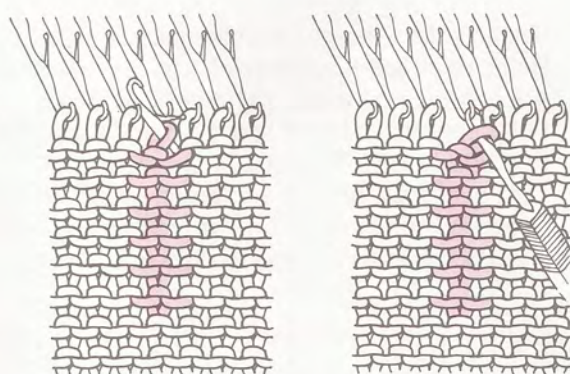

- ⑤ Repeat up to the top
- ⑥ Take the top stitch onto the Tappet Tool at the front and replace it in the empty needle hook.

## To replace a damaged needle

A needle with a damaged latch or bent hook will cause incorrect knitting or dropped stitch.

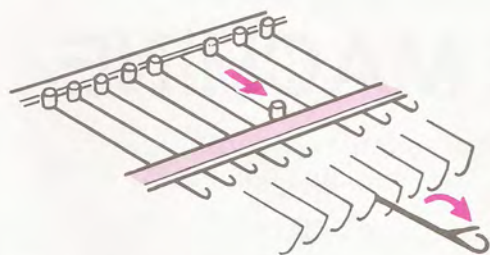

① Push the damaged needle to D position and close its latch.

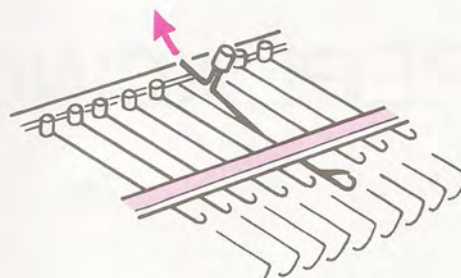

② Lift up the needle with the needle roller and pull back to remove it from the Needle Bed.

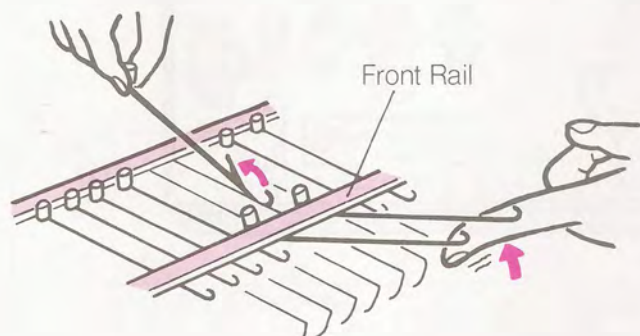

③ Push the Needles on both sides of removed needle to D position and lift them up. Open the latch of a new needle and insert it into empty slot.

## To clean the machine

Remove the carriage from the Needle Bed.  
Remove all fluff from needles and Needle Bed.  
Apply oil along the rail and needle grooves.  
Put a very little oil on a soft cloth and wipe the Needle Bed and Needle Rollers with the cloth.  
Turn over the Carriage and brush off all fluff and oil.  
Replace the Carriage on the Needle Bed and move once or twice across the Needle Bed.

**DO NOT USE THINNERS, PETROL OR ALCOHOL.**

## For successful knitting







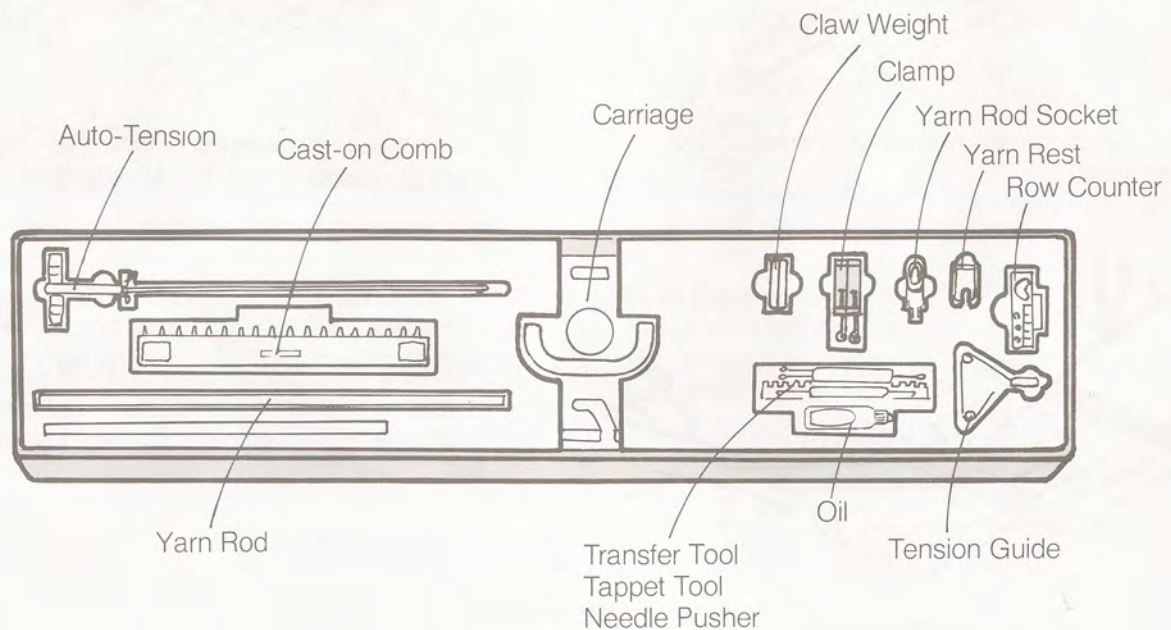

Ensure that...

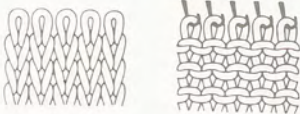
Yarn feeds smoothly into Yarn Feeder.  
Yarn is threaded correctly.  
The Stitch Dial is correctly adjusted.  
The Carriage has completely cleared the last working needle.  
The needles are aligned correctly in position.  
The Tension Dial is correctly adjusted.  
Claw Weights are hanging on both edges of the knitting.  
Claw Weights and Cast-on Combs are moved up every 20 ~ 30 rows.  
The machine is clean and oiled.

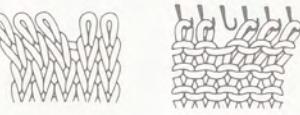
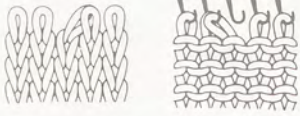
# REPLACING THE MACHINE



# KNITTING SYMBOLS

Symbols	How to make the stitches	Fabrics
—	This stitch is the side always towards you when knitting Stockinet on a machine.	
	Reform the stitch with a Tappet Tool.	
○	Transfer the stitch to the adjacent needle.	
λ	Transfer the stitch to the left and place together with the existing stitch.	
λ	Transfer the stitch to the right and place together with the existing stitch.	
↑	Transfer the two adjacent stitches onto the needle.	
×	Cross the stitches with the right stitch over the left stitch.	
×	Cross the stitches with the left stitch over the right stitch.	
∩	Unravel the stitch and place it with the crossing bar above.	
∨	Unravel the stitch and place it omitting the crossing bar above.	