

Studio

AUTOMATIC HOME KNITTER

INSTRUCTION MANUAL

MODEL SK - 303 SILVER INSTANTAUMATIC

THE MACHINE ACCESSORIES

- ① **Cast-on wire (long)**..... For casting on stitches up to two hundred.
- ② **Cast-on wire (short)**..... For casting on stitches up to one hundred.
- ③ **Auto-tension for two colors** Keeps automatic-tension on yarn.
- ④ **Yarn rod**..... Holds the auto-tension.
- ⑤ **Tension guide**..... Guides the yarn smoothly to the auto-tension.
- ⑥ **Pattern cards** 93 carded patterns with step by step instructions, so easy even beginners can use with only a little practice.
- ⑦ **Row counter**..... Indicates number of rows knitted.
- ⑧ **Card stand**..... Holds the pattern card.
- ⑨ **Transfer tool (1~2)**.....
- ⑩ **Transfer tool (1~3)**.....
- ⑪ **Transfer tool (2~3)**..... } For transferring stitches, increasing decreasing or knitting various designs.
- ⑫ **Tappet**..... For picking up dropped stitches or purling stitches.
- ⑬ **Crochet hook**..... For binding off stitches.
- ⑭ **Needle pusher (0~ $\frac{1}{1}$)**..... For selecting needles for pattern stitches.
- ⑮ **Spare needles**..... For replacement.
- ⑯ **Tapestry needle**..... For stitching seams or weaving.
- ⑰ **Raveling cord**..... For separating the waste knitting from main knitting.
- ⑱ **Clamps**..... Clamps the machine to a table.
- ⑲ **Oil**..... For machine use.
- ⑳ **Cleaning brush**..... For cleaning the machine or opening latches.
- ㉑ **Carriage fastener**..... Keeps the carriage secure when not in use.
- ㉒ **Accessory box**..... For accessories: 7~20. Use the accessory box lid as a tool tray.

THE MACHINE

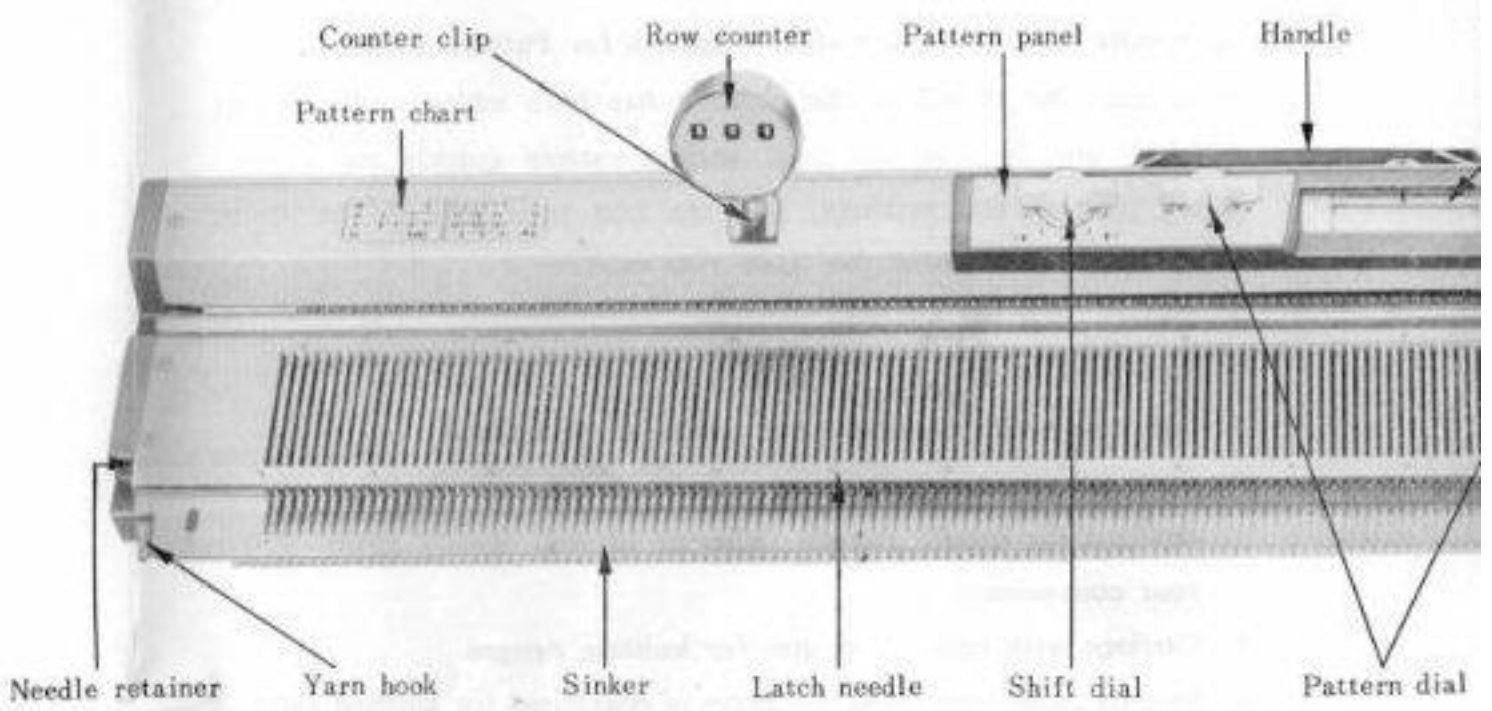

ACCESSORIES

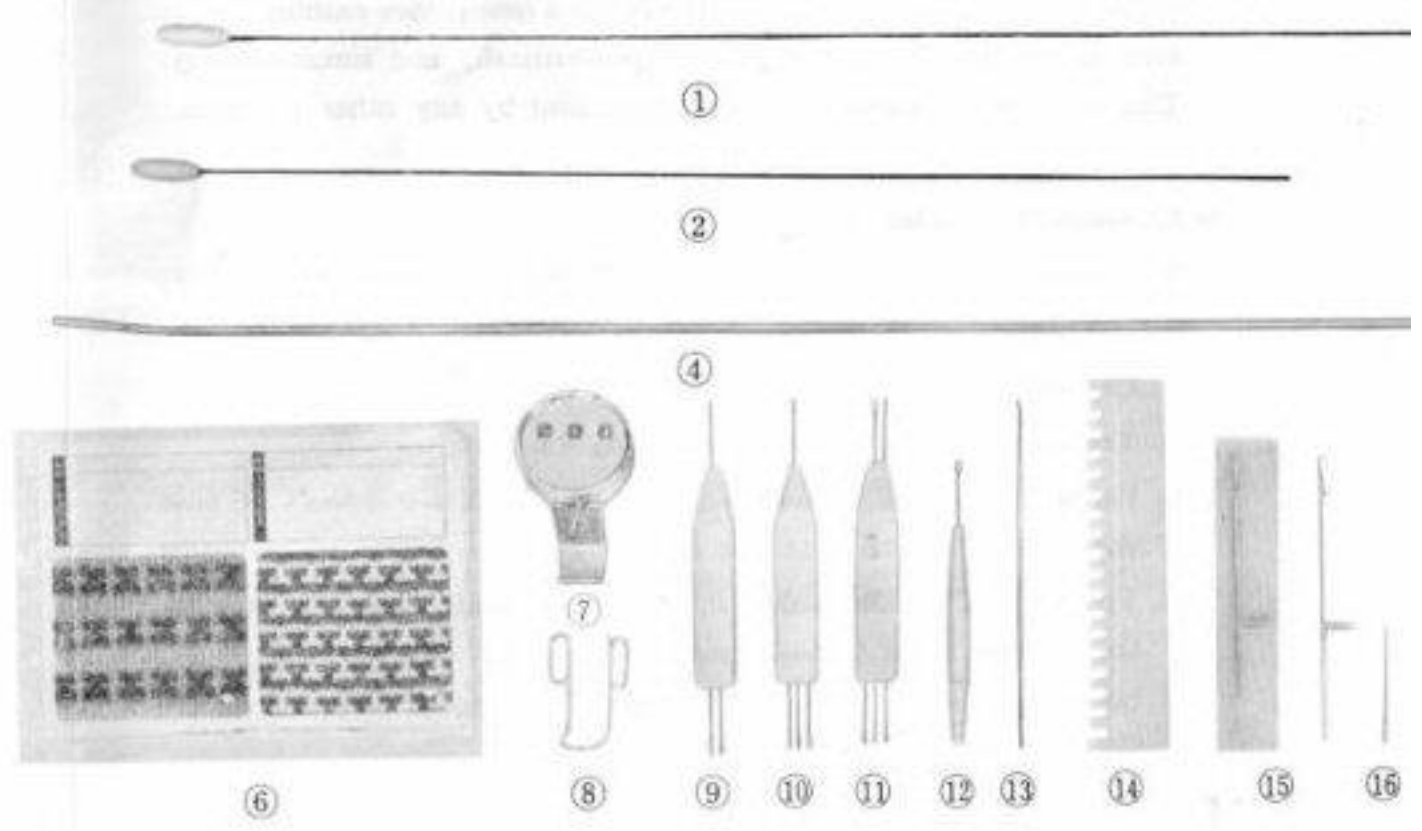

NE

Needle pattern indicator

Card stand

Accessory tray pin

Rail

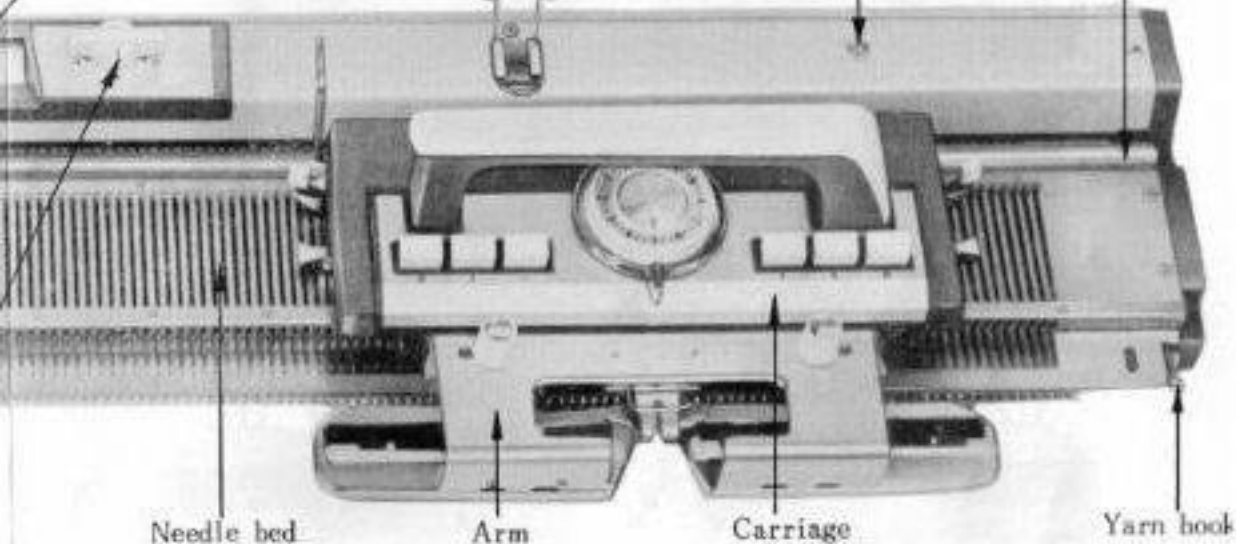

Needle bed

Arm

Carriage

Yarn hook

ES

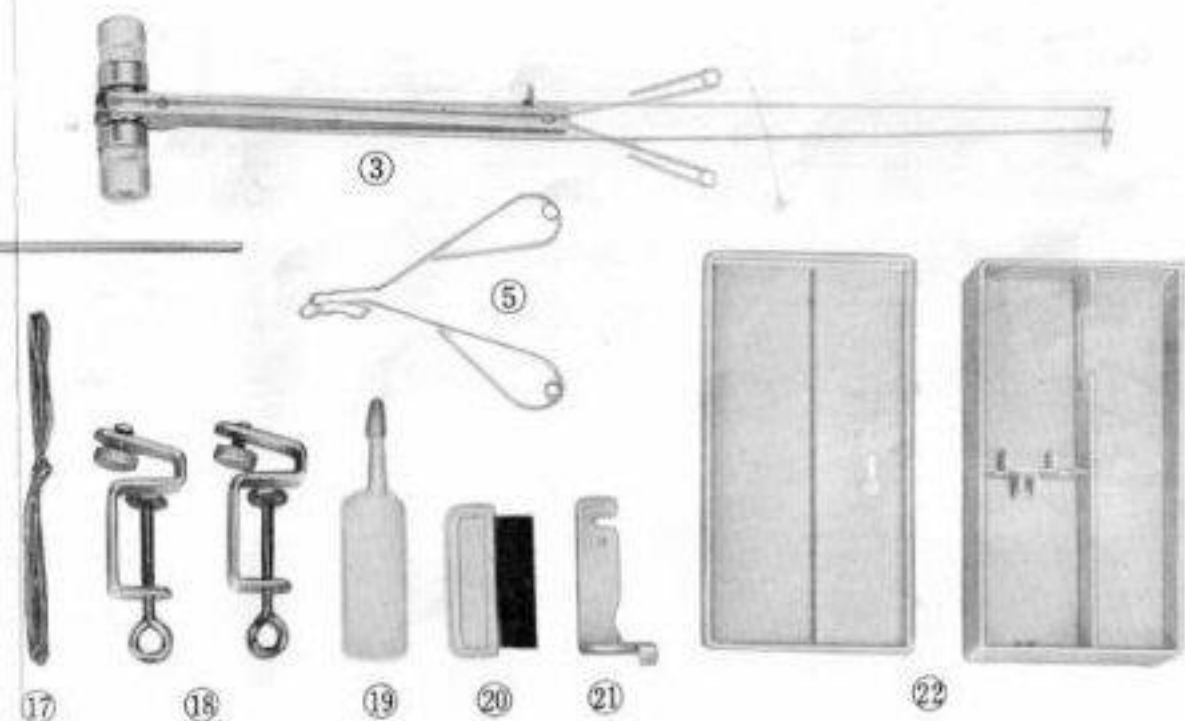

3

5

17

18

19

20

21

22

CARRIAGE

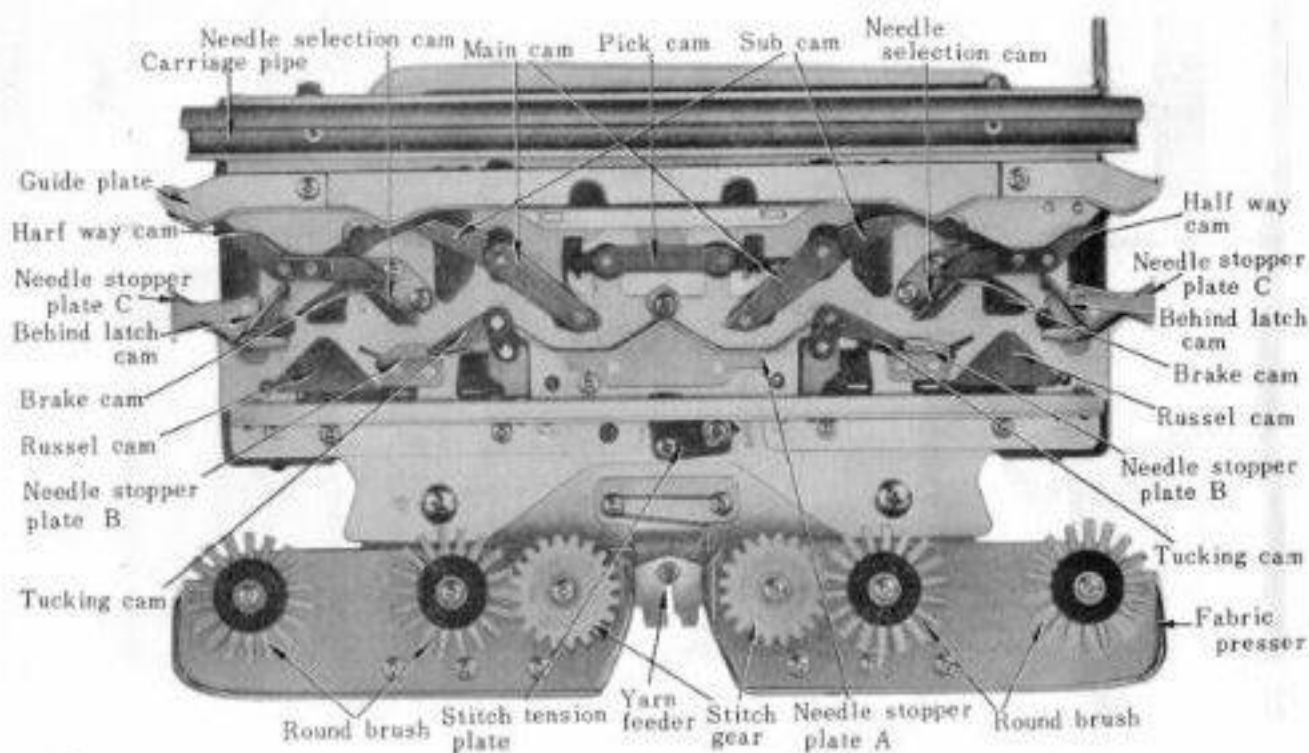
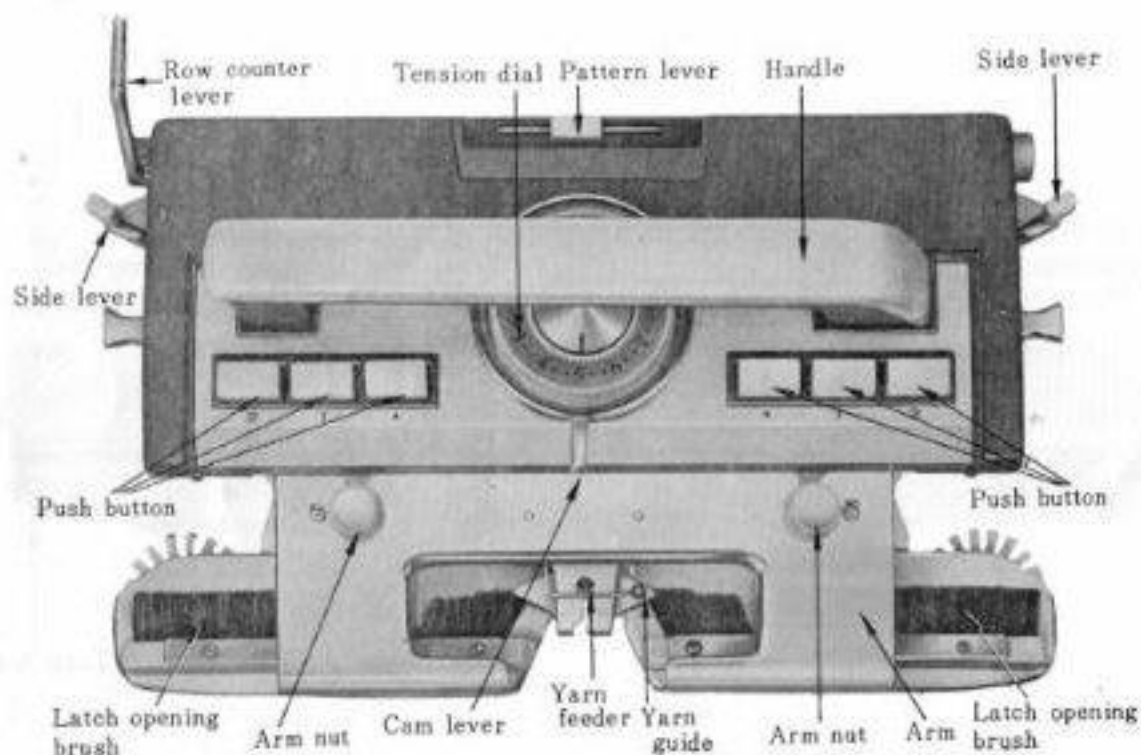

THE FEATURES OF THE MACHINE

♣ 1. Needle Selector with Unique Capacity for Pattern Knitting.

Now that the unique needle selector has been added to the model SK-303 any beginner can knit various pattern quickly and easily. When you use this machine, you can knit your garment ten times faster than any machine you have ever used.

1. Pattern dials for selecting patterns.
2. Shift dial for shifting the pattern to both right and left positions.
3. Indicator which illustrates the pattern to be knitted.
4. Centered pattern panel board includes the pattern dials, the shift dial and the needle pattern indicator in well spaced positions for your convenience.
5. Carriage with built-in features for knitting designs.
6. Pattern cards illustrating the order of operations for knitting various patterns. . . . simplified, especially for the beginner.

By these means you can knit more than ten thousand patterns. An added attraction of the model SK-303 is a new device enabling you to knit-in two colour different colours automatically and simultaneously. This is an art of pattern knitting unequalled by any other machine.

♣ 2. Simple Operation

The model SK-303 has the following facilities which further simplify the operation:

1. Cast-on wires for easy casting-on.
2. Tension regulating knob for adjusting the yarn tension.
3. Folding auto-tension enables you to knit with two colours at once without the use of your free hand.
4. Tension dial which makes it possible to knit with any material from cotton tread to bulky yarn.
5. Single rail, which allows you to make corrections easily by merely raising the carriage.
6. Folding handle snap-locks up for easy use.

♣ 3. Excellent Durability

The model SK - 303 is constructed of the finest materials to insure lasting strength and appearance.

1. Needle bed, manufactured of specially treated steel for greater durability.
2. Carriage pipe, permits the carriage to slide smoothly and protects it from wearing out.
3. Latch needles strengthened with a special heat treatment.

♣ 4. Elegant Design

The model SK - 303 gives you the pleasure of wearing hand fashioned garments and is designed in modern elegant lines.

1. Needle bed, finished with a special treatment, which cuts glare making it easier on your eyes.
2. Carrying case, made of "vinytop" (sheet steel finished with chloridized vinyl).
3. Carriage, modern streamline design.

CONTENTS

1. SETTING UP AND RESTORING THE MACHINE	2
1. Setting up	2
2. Restoring	7
2. BASIC OPERATION	9
1. Latch needles	9
2. Pattern panel	10
3. Carriage	13
4. The gauge	16
3. STOCKINET KNITTING	18
1. Preparing yarn	18
2. Setting for knitting	19
3. Threading the yarn	20
4. A stitch is formed in the following way	21
5. Casting on	22
6. Binding off	26
7. Removing the garment from the machine	28
4. VARIED KNITTING PROCEDURES	30
1. Partial knitting on stockinet stitches	30
2. Tucked patterns	33
3. Slip stitches	34
4. Pick patterns	35
5. Successive tucked patterns	36
6. Knit-in patterns	38
7. Lacy patterns	39
8. Cable stitches	41
9. Rib stitches	42
10. Garter stitches	45
11. Stranding or adding yarn	46
12. Cord knitting	47
5. FOR KNITTING GARMENTS	48
1. Increasing and decreasing stitches	48
2. Seaming	51
3. Heming a garment	53
6. LET'S KNIT !!	55
1. Room shoes for lady	55
2. French sleeve sweater for child 5 or 6 years old	58
7. HELPFUL HINTS	62
1. Replacing damaged needles	62
2. How to rip out incorrect knitting	62
3. If the carriage jams while knitting	63
4. If stitches are dropped	64
5. If loose stitches are forming at the edges of your garment	66
6. Keeping the case clean	66
7. How to put the row counter out of operation	66
8. CARE OF YOUR MACHINE	67
1. After using the machine	67
2. Oiling	67
3. Disassembling the main machine	68
4. Preseving the machine	68
KNITTING SYMBOLS	69

SETTING UP AND RESTORING THE MACHINE

1. Setting up

Place the machine on a table with the handle of the casing away from you.

1. Remove the cover

- (1) Unfasten the latch locks on the machine. (Fig. 1)
- (2) Place hands on either side of the cover.

Lift up, raising back.....pull toward you at slanted angle, freeing the cover. (Fig. 2)

- (3) Inside the cover, you will find two cast-on wires (long and short), a yarn rod, auto-tension for two yarns and an arm.

(Fig. 3)

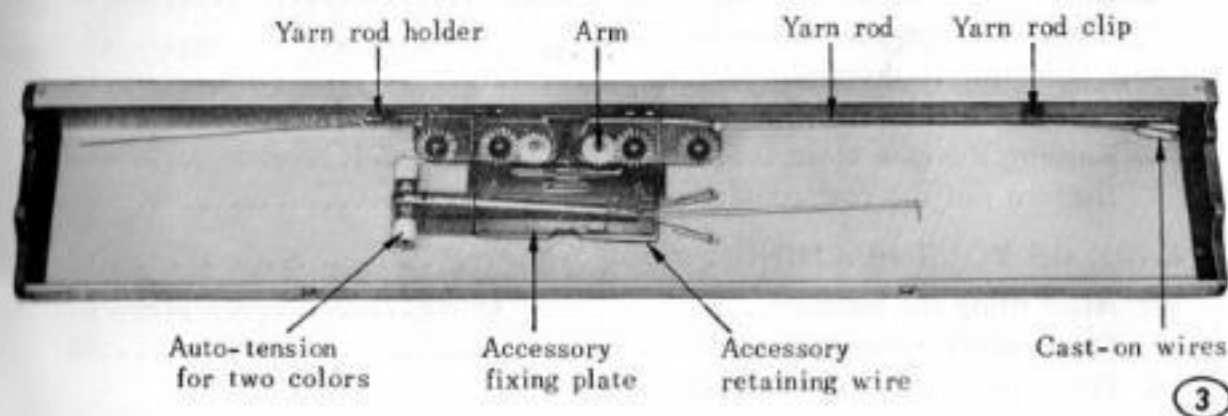
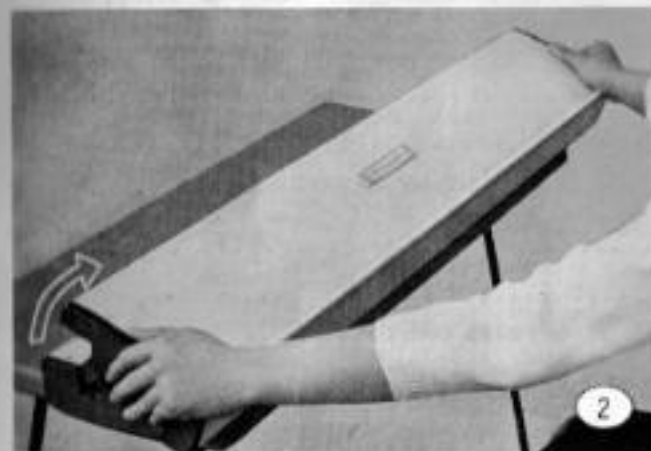

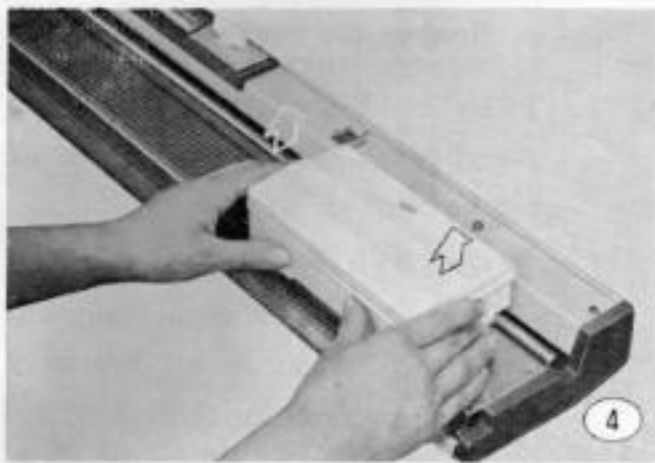

NOTE: See the fold-out page for parts inventory.

2. Remove the accessory box.

- (1) Take out the accessory box by lifting it up. (Fig. 4)
- (2) In the accessory box you will find a tension guide, a row counter, two clamps, oil, a card stand, a cleaning brush, a needle pusher, three transfer tools, a tappet, a crochet hook, three spare latch needles, a tapestry needle and raveling cord.

(Fig. 5)

NOTE: See the fold-out page for parts inventory.

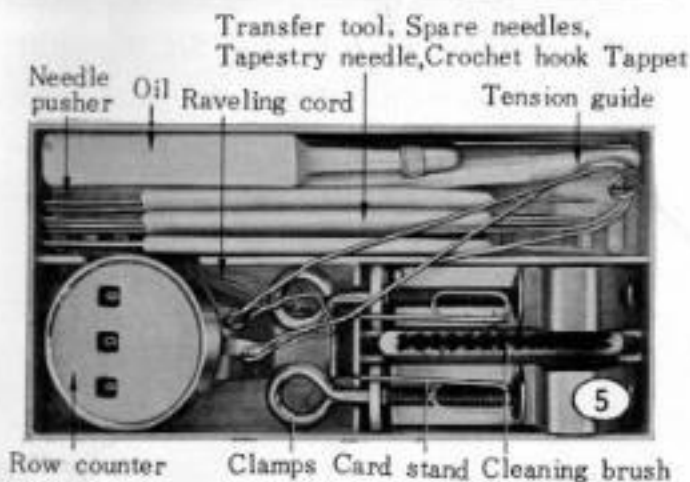

3. Set the machine on the table.

- (1) Tip the machine away from you and put the head of the clamp into the clamp receiver. Then, slide the clamp head forward as far as possible and screw it firmly to the right. (Fig. 6)
(The rubber feet on the bottom of the machine will hold the machine firmly enough, but it is advisable to clamp it when you intend to knit with heavy yarn or if your table is not sturdy.)

- (2) After both clamps are fastened to the machine, attach to the table. (Fig. 7)

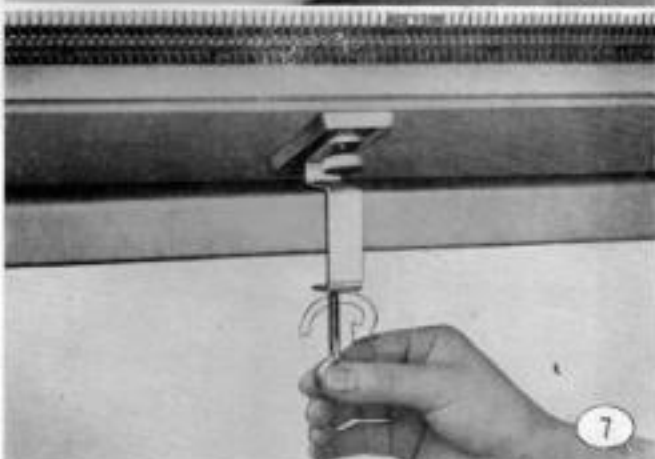
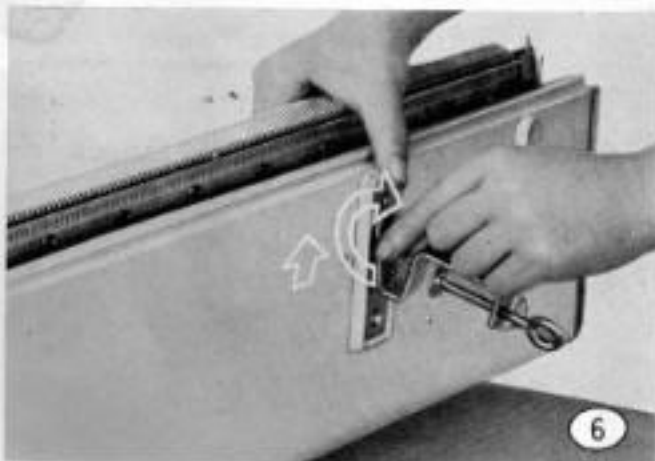

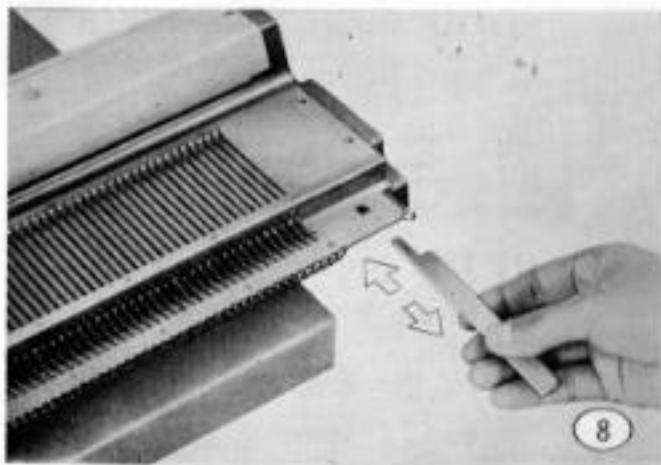

4. Remove the fastener.

Pull out the copper plate which is found below the right-hand end of the needle bed. (Fig. 8)

NOTE: This copper plate is a safety feature to be used during shipment of machine. It is not necessary during normal storing or carrying. If it is necessary to use the plate, install as follows:- Set the shift dial to 0. Insert the plate with the narrow tip forward and to the left. Lift slightly while maintaining a steady pushing pressure. The plate will protrude approximately 3/8 inch when fully installed. (Fig. 9)

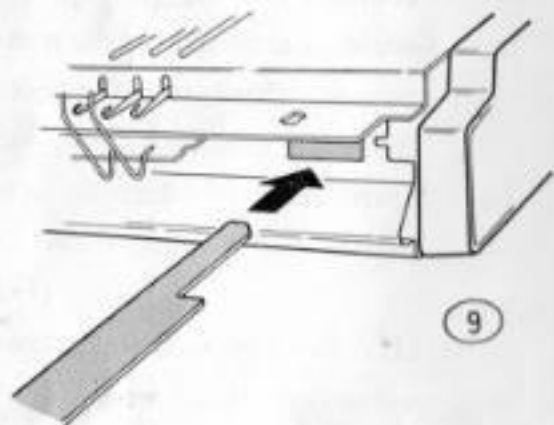

5. Setting up the carriage

(1) Loosen the left arm nut and remove the carriage fastener on the left side. (Fig. 10)

NOTE: It is most important that this fastener is replaced each time your machine is stored away.

(2) Raise the hand towards you until it locks in place. (Fig. 11)

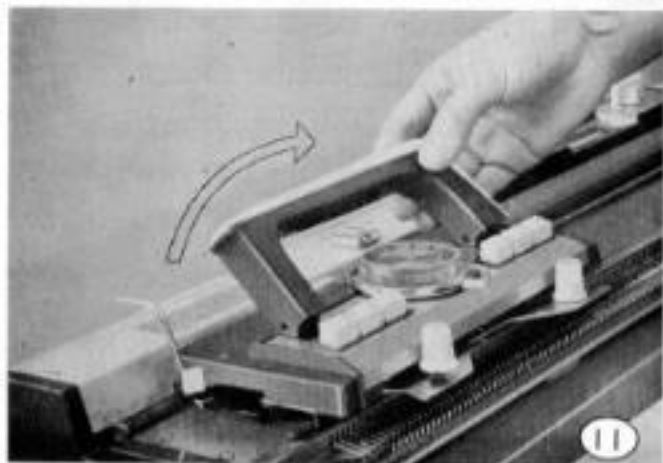

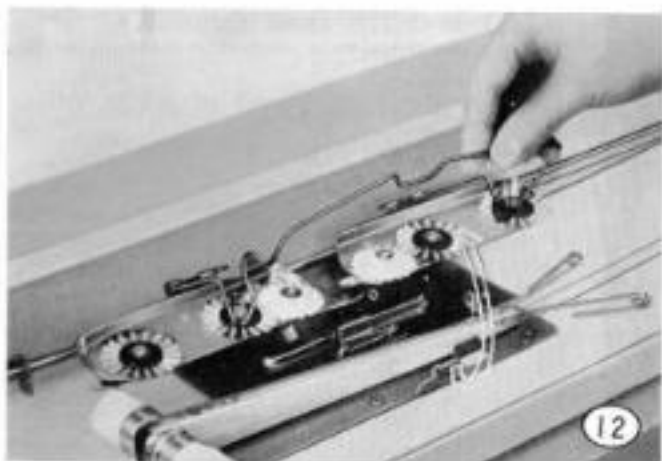

- (3) Release the retaining wires and remove the auto-tension and the carriage arm from the cover.

(Fig. 12)

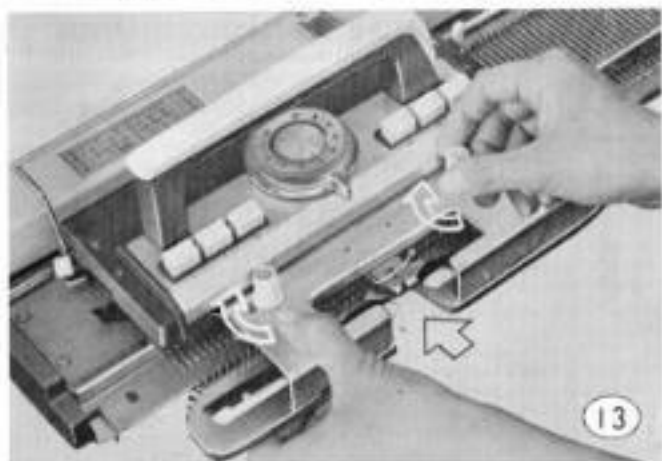

- (4) Loosen the arm nuts of the carriage, push the arm in as far as it will go and tighten the arm nuts firmly. (Fig. 13)

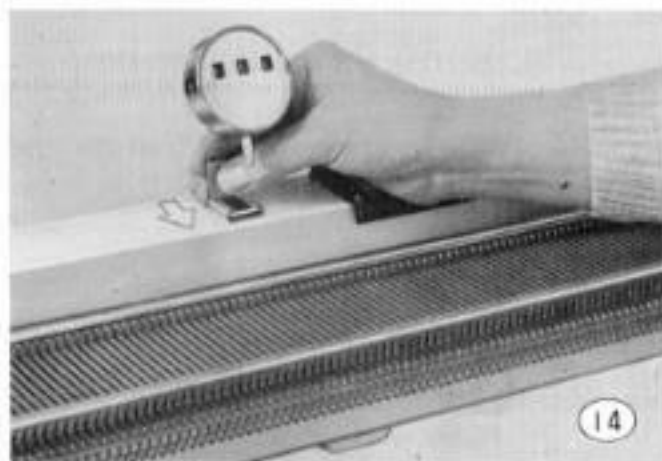

6. Insert the row counter

Insert the row counter into one of the counter clips. (Fig. 14)

It is usually used in the left clip.



The row counter reads up to 999. For returning it to zero, turn the knobs in the directions of the arrows from the one-figure number to the three figures number. When you turn it back to correct over-knitting, turn the knob for the number of the sub-figure in the opposite direction of the arrow mark. (Fig. 15)

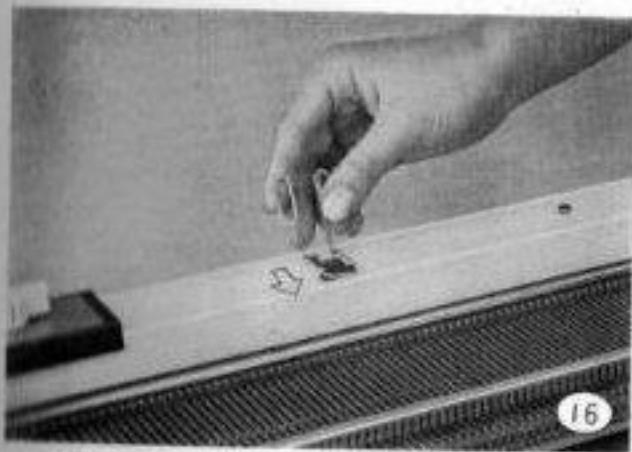

7. Insert the card stand

Insert the card stand into the other counter clip. (Fig. 16)

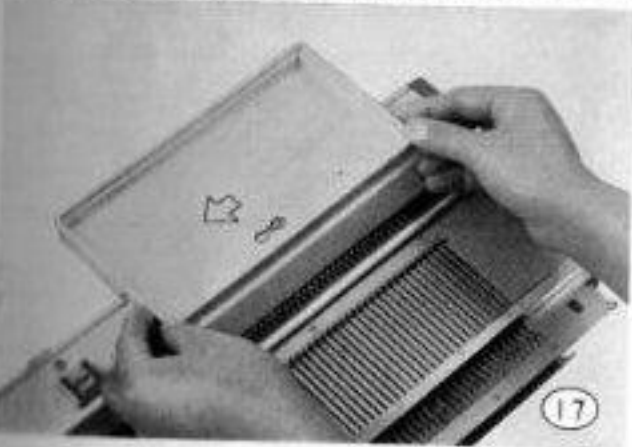

8. Installing the accessory tray.

The lid of your accessory box can be used as a tool tray. Simply remove the lid from the box, place the keyhole over the pin at the right end of the machine and slide to the left. (Fig. 17)

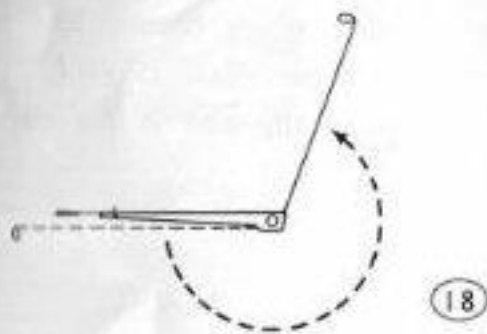

9. Setting up the auto-tension.

- (1) Insert the yarn rod into the rod receiver.
- (2) Turn the folded tension springs of the auto-tension upwards and unfold them until they fit into the slots respectively. (Fig. 18)

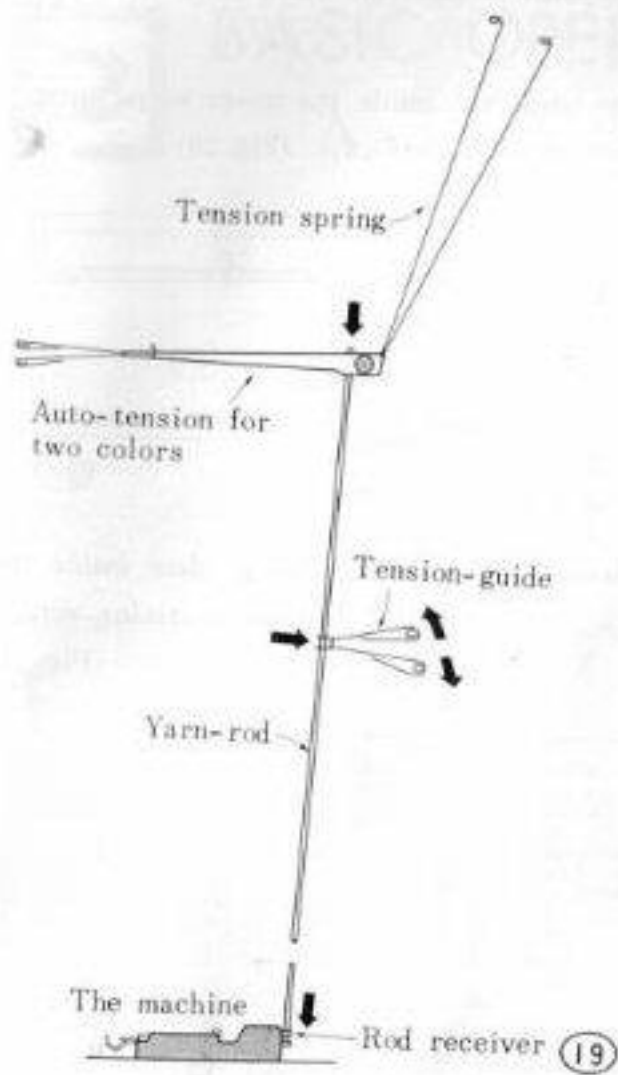

- (3) Install the auto-tension at the top of the rod, engaging the keys into the slots on the auto-tension.
- (4) Separate the tension guides and engage the clip end of the tension guides onto approximately one-third distance from the top of the rod. (Fig. 19)

2. Restoring

1. Securing the carriage on the needle bed :

Remove the arm from the carriage. Bring down the handle and slide the carriage to the extreme left side of the needle bed. Install the carriage fastener by engaging the hook end in the slot provided. Lock the fastener to the carriage using the left hand arm nut. (See Fig. 10)

2. Returning the auto-tension and others to their places inside the cover :

- (1) Remove the auto-tension from the yarn rod, and turn the tension springs downwards until they are folded to their places.

- (2) Remove the tension guides from the yarn rod and the yarn rod from the rod receiver.
- (3) Install the cast-on wires and then the yarn rod inside the cover as pictured in Fig. 20, using the yarn rod holder and the yarn rod clip. (Fig. 20)

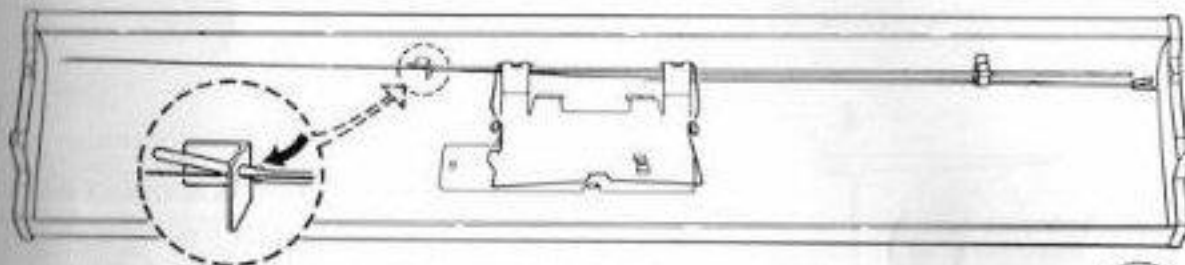

Affix the cast-on wires and the yarn rod as shown above.

- (4) Place the arm and the auto-tension on the accessory fixing plate inside the cover as pictured in Fig. 19, and lock them using the accessory retaining wire. (Fig. 21)

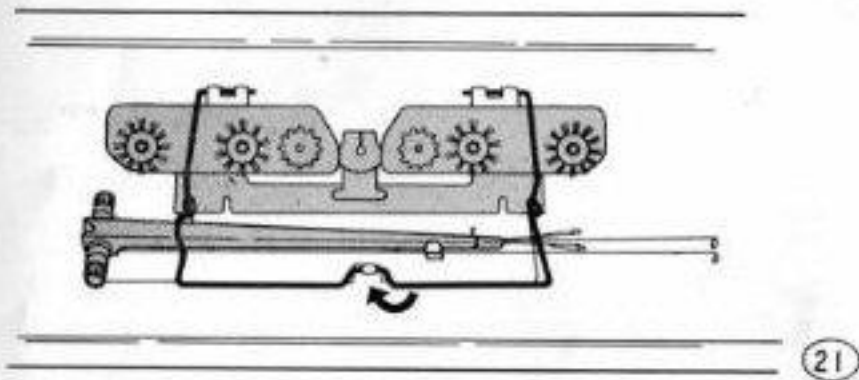

Then affix the arm and the auto-tension in this sequence.

3. Installing the accessories in the box :

The row counter, clamps, oil, card stand, cleaning brush, revelling cord, needle pusher, three transfer tools, tappet, crochet hook, tapestry needle, three spare latch needles and tension guides which have been folded one over the other.

Place the lid on the box and place the box on the needle bed about 1 inch from the right edge.

4. Put the case-cover on the machine :

Reset the shift dial to zero, and the pattern dials to the black dot symbols. Cover the machine with the case-cover, and fasten the latch locks.

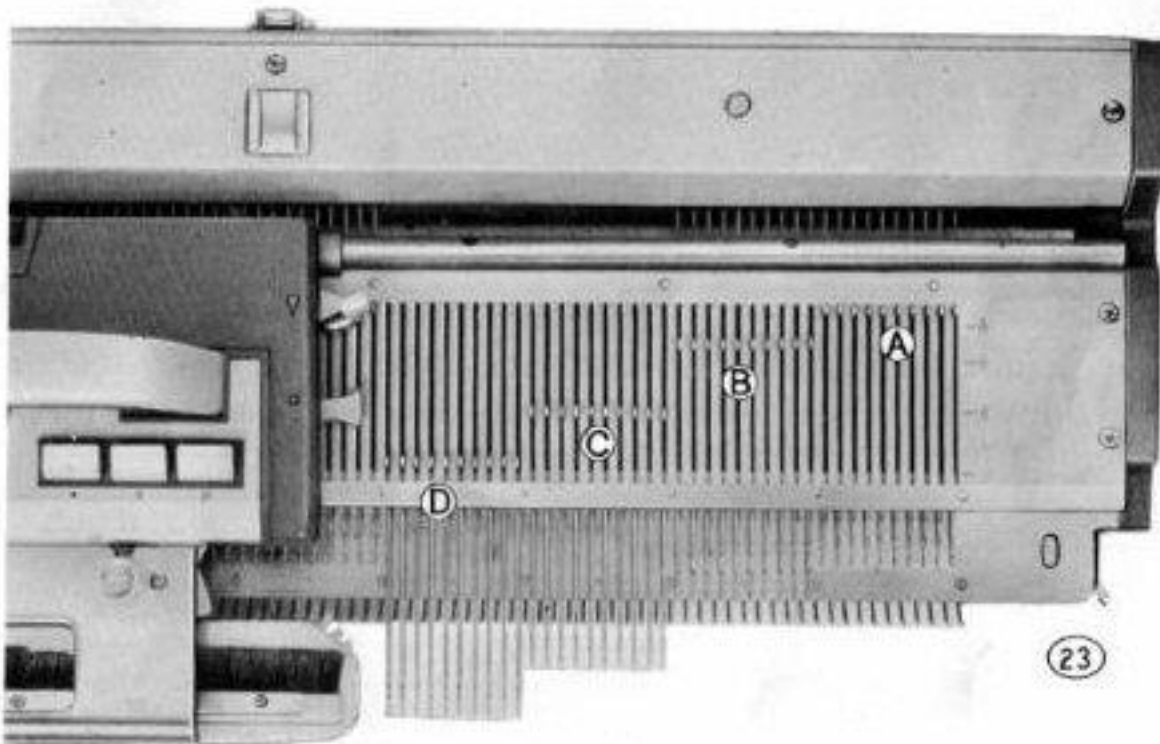
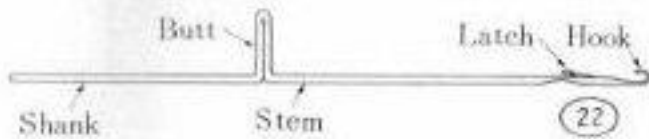

1. Latch needles

1. Latch needles

The latch needles are used in four basic positions A, B, C, and D.

These positions are indicated by the marks A, B, C and D on both edges of the needle bed. (Fig. 23)

- A position Inactive or stored position.
- B position The needles are normally set at this position when knitting.
- C position The needles are set at this position for pattern knitting and some partial knitting.
- D position The needles are set at this position when they are manually selected or when partial knitting is done.

NOTE: The needles at **B** and **C** positions will vary their movement as the settings of the levers and/or dials are changed.





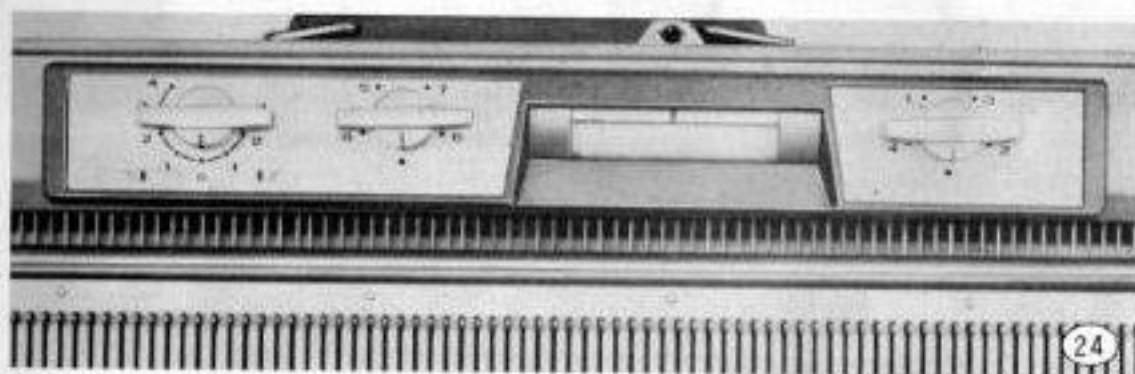





2. Pattern panel

The pattern panel consists of the following, reading from left to right. The shift dial, a pattern dial, the pattern indicator, and the other pattern dial. (Fig. 24)



1. Pattern dials

(The relation between the left and right pattern dials and the latch needles)

Pattern dial (left)	Pattern dial (right)	Alignment of needles when carriage is moved	Pattern position indicator
		<i>y y y y y y y y y y</i>	
		<i>y y y y y y y y y y</i>	
		<i>y y y y y y y y y y</i>	
		<i>y y y y y y y y y y</i>	
		<i>y y y y y y y y y y</i>	
		<i>y y y y y y y y y y</i>	
		<i>y y y y y y y y y y</i>	
		<i>y y y y y y y y y y</i>	

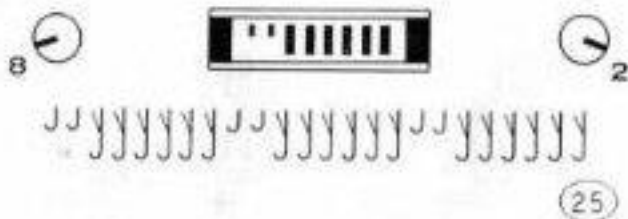

The bold marks ■ on the pattern indicator show the needles that will be pulled out when the carriage is moved across the selected needles.

The narrow marks ■ show the needles that remain in normal knit position. (Fig. 25)

Both pattern dials should be set to ● when doing regular stockinet stitch or when selecting patterns manually.

A variety of patterns may be obtained by utilizing both the left and right pattern dials.

Pattern dial (left)	Pattern dial (right)	Alignment of needles when carriage is moved	Pattern position indicated
5	1	յյյյյյյյյյյյ	
6	1	Same as +	
7	1	Same as +	
8	1	յյյյյյյյ	
5	2	յյյյյյյյյյյյ	
6	2	յյյյյյյյյյյյ	
7	2	յյյյյյյյյյյյ	
8	2	յյյյյյյյ	
5	3	յյյյյյյյյյյյ	
6	3	Same as +	
7	3	Same as +	
8	3	յյյյյյյյ	
5	4	յյյյյյյյյյյյ	
6	4	յյյյյյյյյյյյ	
7	4	յյյյյյյյյյյյ	
8	4	յյյյյյյ	

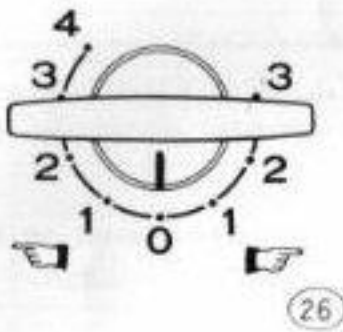

2. Shift dial

The position of the patterns being knit by the pattern dials may be moved to the left or right of the center by the shift dial. When the shift dial is positioned, the mark **■** and **■** on the pattern dial move relative to the red mark which marks the center of the needle bed.

(Fig. 26, 27)

NOTE: You can also select needles manually for special patterns without using the pattern panel.

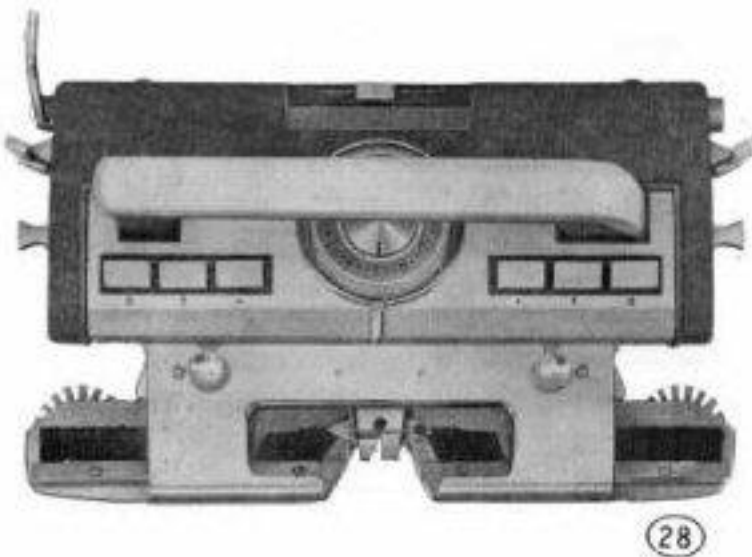
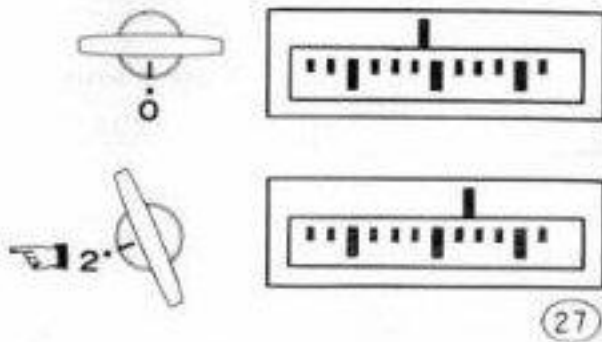

3. Carriage

The cam lever, push buttons, pattern lever, and side levers should be positioned according to the type of knitting being accomplished. (Fig. 28)

1. Cam lever

The cam lever can be set to five positions of PICK, L, STOCKINET, R and KNIT-IN, and operates the needles shown by the marks ■ (the needles on B position) enabling or not them to form the stitches. (Fig. 29~32)

NOTE: Normally, as in the cases shown, the pattern lever is set to ● position and the side levers to ▼ positions.



STOCKINET

■ knit ←

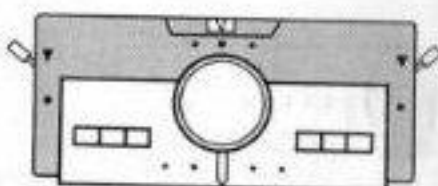

→ ■ knit

(29)



R

■ knit ←

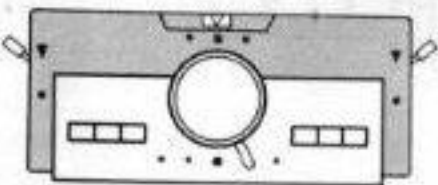

→ ■ not knit

(30)



L

■ not knit ←

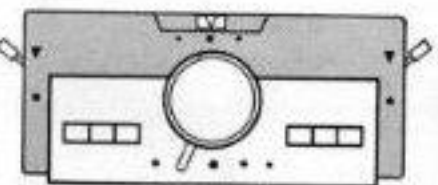

→ ■ knit

(31)



PICK

KNIT-IN

■ not knit ←

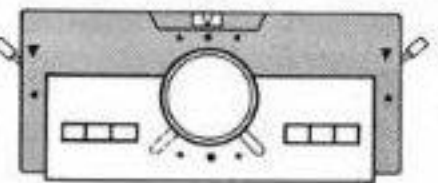

→ ■ not knit

(32)

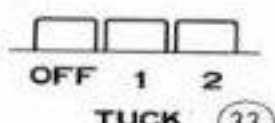
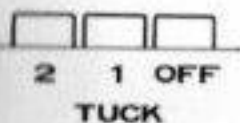









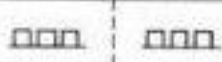

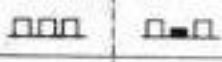
(33)

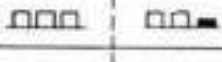
2. Push buttons

The push buttons on each side are provided with ● button, #1 button and #2 button respectively. The

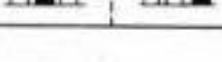
#1 button works on the needles with the marks ■ on the indicator, and the #2 button works on the needles in D position. The button ● raises the depressed #1 or #2 button. (Fig. 33)

Push buttons	Direction carriage is moving	Needles of the mark I on the indicator 18 position	Needles at D position
		Knit	Remain at D position
		Pulled out to D position (not knit)	Remain at D position
		Knit	Knit
		Knit	Return to C position (not knit)
		Return to C position after being once brought to D	Return to C position (not knit)

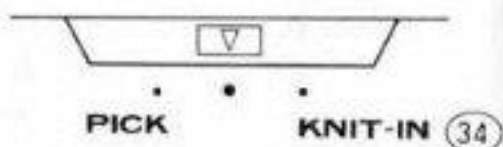

3. Pattern lever

The pattern lever can be set to three positions of PICK, ● and KNIT-IN. (Fig. 34)

PICK... The pattern lever is set to this position for pick knitting.

KNIT-IN... The pattern lever is set to this position for knit-in simultaneous knitting (two yarns of contrasting colours are knitted in at the same time).

●... Otherwise, the pattern lever is set to this position.

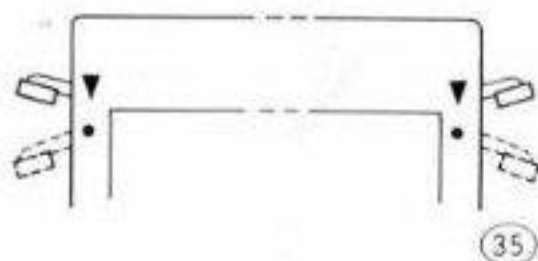

4. Side levers

The side lever can be set at two positions of ▼ and ●. (Fig. 35)

▼... The side lever should be set to this position when patterns are knitted using the pattern panel.

●... The side lever should otherwise be set to this position. If, when using a pattern on the pattern panel, you should desire a portion of your knitting to be knit plain, simply reset the side lever to ● position. When you are ready to resume the pattern, reset to ▼.

NOTE: The side lever should be set to desired positions on the side and direction the carriage is moving.

5. Tension dial

The tension dial is used for altering the size of the stitch. Adjust the numbers of the dial to the red line in the center.

The higher the dial number, the looser the stitch; as the dial number is lowered, the stitches become finer.

Depending on the size of knitting yarn, the dial number is adjusted as follows: (Fig. 36, 37)

Thin (Cotton or crochet thread)	0 - 3
Medium	3 - 8
Thick	8 - 9
Very thick	9 - 10

When bulky yarn is used, every other needle should be used.

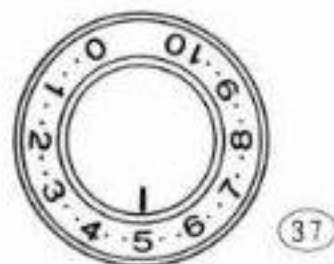

(37)

(36)

4. The gauge

Before your garment can be knit, you must determine how many stitches and rows you have per inch.

Knit several swatches at different tensions, using 60 stitches and 80 rows per swatch. Desired swatch should be left to set for 24 hours period before counting. A light

pressing with a steam iron will give you a more accurate gauge.

Lay the swatch on a flat surface and count number of stitches and rows in a 4 inches area. Fraction stitches and rows should be counted as same and not as a whole stitch or row.

It is very important to get a correct counting of your gauge, as an error of 1 stitch or row can cause your garment to be sized incorrectly.

STOCKINET KNITTING



38

1. Preparing yarn

☆Place a skein of yarn around the convenient skein holder. Find the starting thread and pull out letting the yarn fall into a neat pile in a box or basket. (Fig. 38)



39

☆The yarn may also be wound from the skein holder to the ball winder. The yarn is more compact and easily stored when prepared this way. (Fig. 39)

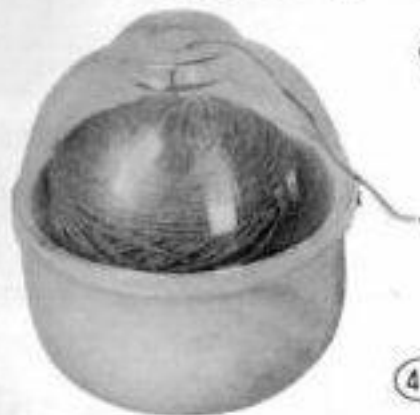

40

☆When the yarn is prepared on the ball winder, you will find the plastic yarn case very convenient when knitting. (Fig. 40)



41

☆The yarn rolled into a ball as pictured will cause your knitting to be uneven. (Fig. 41)

2. Setting for knitting

Set the pattern panel and the carriage as follows:

—Pattern panel—

Pattern dial (left) ●
Pattern dial (right) ●
Shift dial 0

(Fig. 42)

—Carriage—

Cam lever..... STOCKINET
Push buttons... Both #2 buttons
down
Pattern lever.... ●
Side lever ●

(Fig. 43)

—Latch needle—

Latch needles... Bring required
numbers of latch
needles out into
D position.

(Fig. 44)

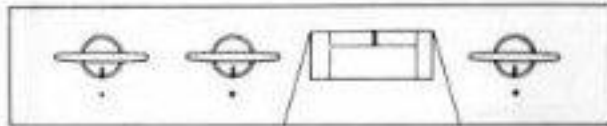

42

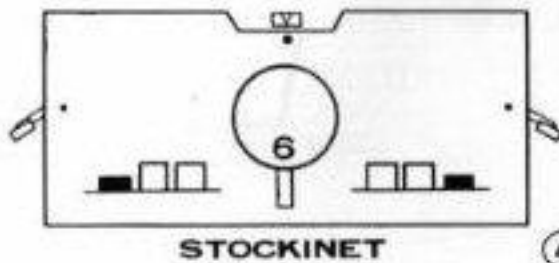

43

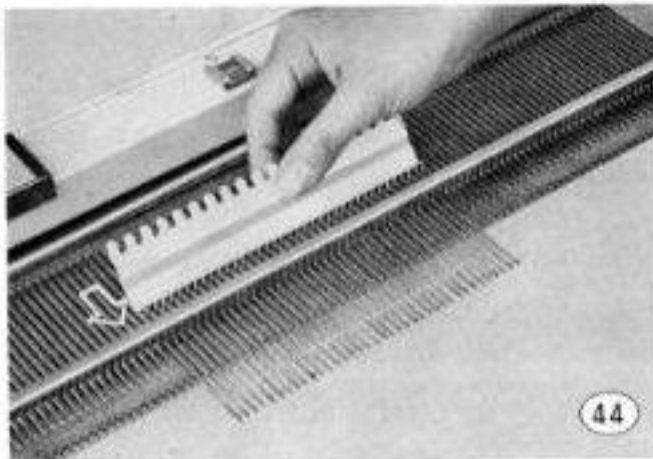

44

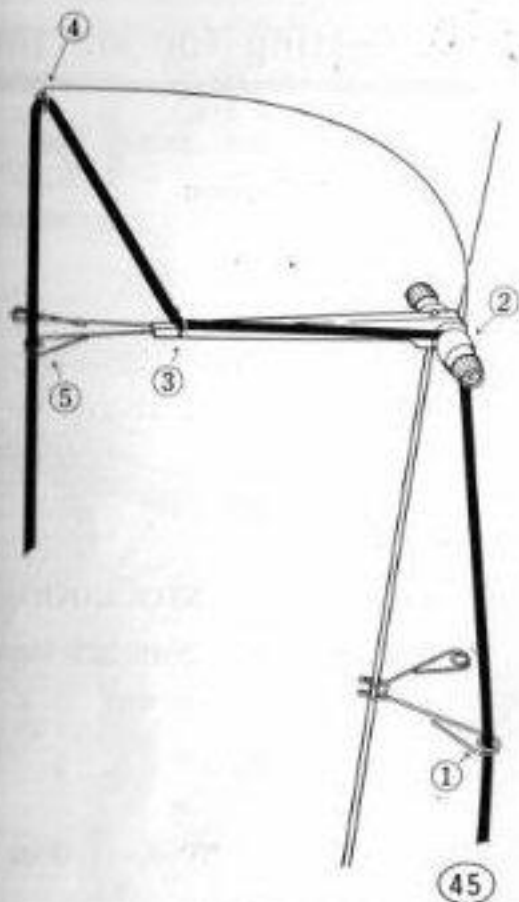

3. Threading the yarn

Pass the yarn through the ①~⑤ as illustrated. (Fig. 45)

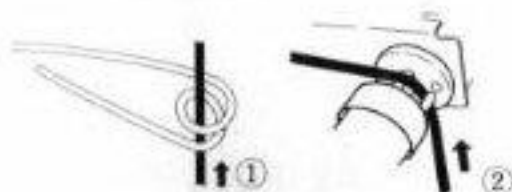

Pass the yarn inside the pin at ②.



Thread the yarn from the auto-tension down into the yarn feeder of the carriage. (Fig. 46)

NOTE: When knitting with two different colours, thread each of the yarns in the same manner. Be careful not to cross the yarns.

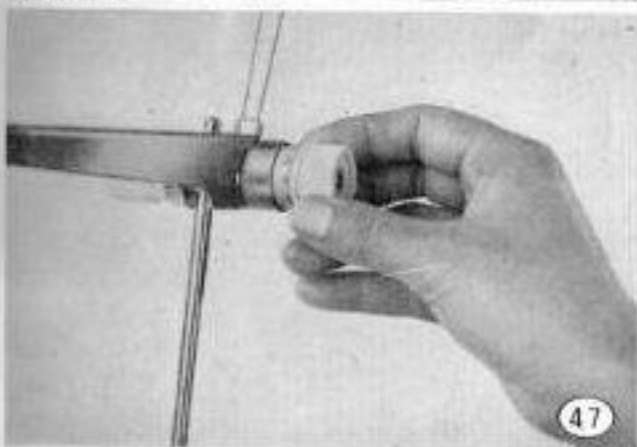

Tension regulating knob

The tension regulating knob is numbered 1, 2, 3, 4 and 5. (Fig. 47)

The larger the number, the tighter the tension is on the yarn. The knob should be adjusted according to the size of the yarn. With any size of yarn, you must adjust the

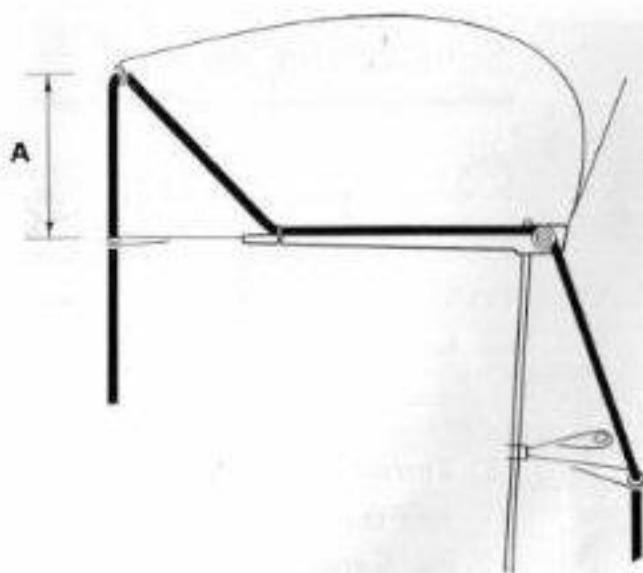

knob so that the return of the tension spring (the length of A in Fig. 48) may be within 4~8 inches. The following is available in normal cases.

- Thin woolen yarn or cotton thread..... 5~4
- Medium woolen yarn..... 3
- Thick or very thick woolen yarn..... 2~1

4. A stitch is formed in the following way.

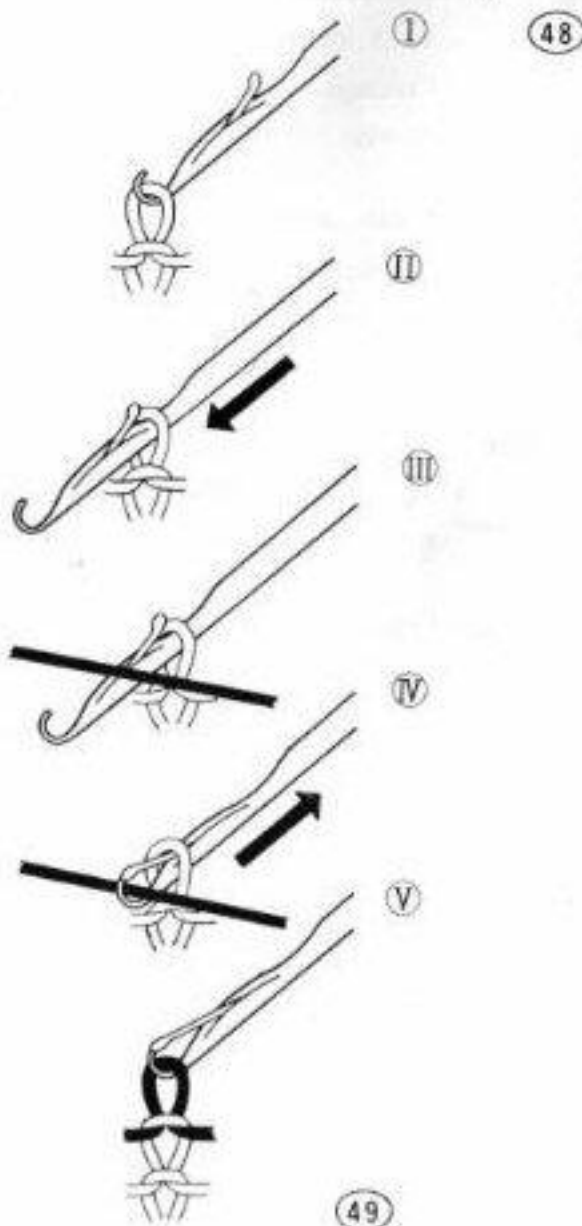

- (I) An old stitch is in the hook of a latch needle.
- (II) The needles moves forward, and the old stitch automatically opens the latch and slides back onto the stem behind the open latch.
- (III) The yarn is automatically fed into the hook from the yarn feeder.
- (IV) As the carriage continues to move, the cams on the underside of the carriage causes the needle to move back. The old stitch automatically closes the latch.
- (V) The needle continues to move back, and the old stitch slides over the closed hook. At the same time the new stitch (inside the hook) is pulled through the old stitch.

5. Casting on

1. Casting on by using the cast-on wire.

- (1) Using a light coloured medium weight yarn, set the tension dial to 6.
- (2) Thread the yarn feeder, making sure the yarn is completely in the bottom slot. Let about 4 or 5 inches extend below the carriage. Move the carriage slowly. (Fig. 50)
- (3) Hold down the yarn at the carriage side with your finger, and push the carriage forward further. (Fig. 51)
- (4) Place the cast-on wire on the yarn between the latch needles and the sinkers. (Fig. 52)
- (5) Depress down on the cast-on wire so that it will be lower than the latch needles and pull out one or two latch needles at both ends and one in the center over the cast-on wire to D position. (Fig. 53)
- (6) Knit about 5~6 rows by moving the carriage across the operating needles. Remove the cast-on wire. (Fig. 54)
- (7) Set the tension dial to 5.

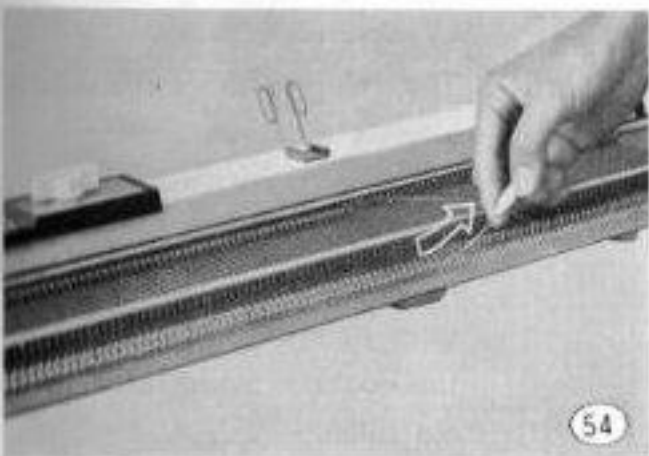
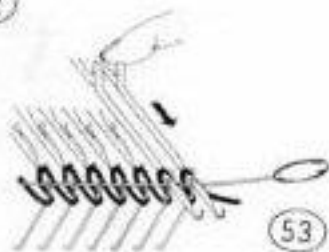
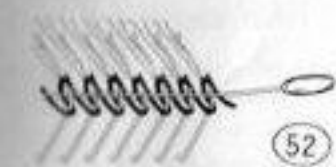
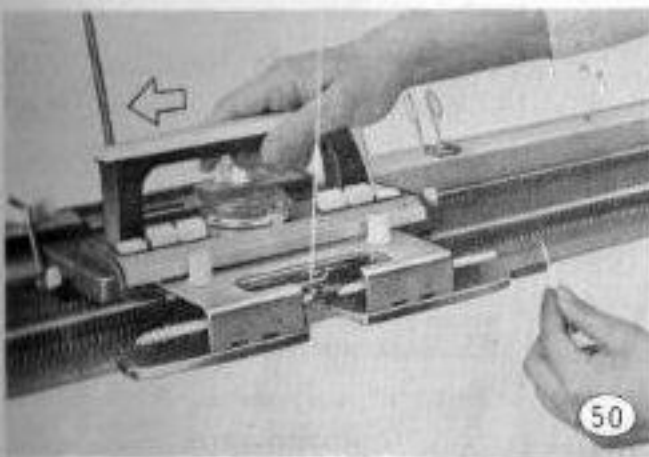

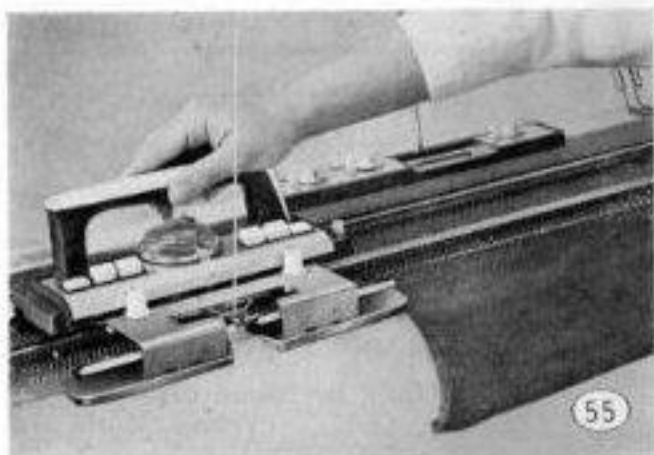

(8) Stockinet stitches are knit automatically by moving the carriage back and forth. (Fig. 55)

NOTE: It is best to knit at the rate of 30 rows per minute. Move the carriage smoothly. Keep moving the carriage until it produces a clicking sound (when the side lever is set to the rear **↑**, it produces a double clicking sound.) Clicking sound is caused when the last needle clears the cam on the under-carriage. You need not push the carriage any further after you hear the "click".

2. Waste knitting

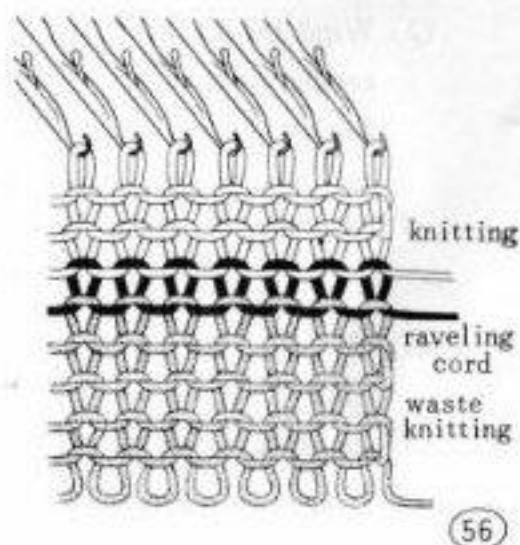

Unless your garment is begun with a bound-off edge, either by hand or automatically with the ribber attachment, you will want to start knitting with waste or scrap yarn. Use a contrasting colour to the main colour of your garment.

Cast on. Knit from 6 to 8 rows. Unthread the carriage. Thread with the raveling cord and knit one row. Unthread the carriage, letting the cord hang free on both ends. Thread the carriage with the main yarn and begin knitting. (Fig. 56)

When you start rib knitting in reverse from the first row of the garment, seam two pieces together, or bind off the first row, you can pick up the loops on the first row of the main yarn that run parallel with the raveling cord with ease. The waste knitting may be separated from the garment easily by undoing each edge stitch of the raveling cord and pulling out the cord.

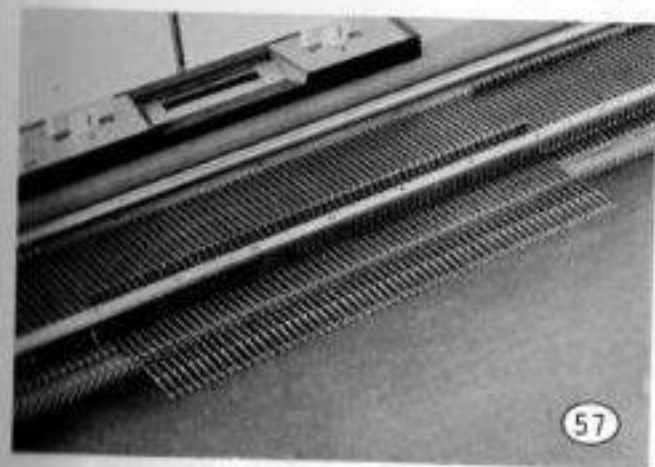

3. Casting on by winding stitch

Another method for casting on is by winding the yarn around the stems of the needles. If you cast on using this method, it is not necessary to use a waste yarn or raveling cord as your starting edge will already be bound off.

(1) Place the carriage on the right end of the needle bed and pull out the required number of the latch needles to the D position on the bed. (Fig. 57)

(2) Wind the knitting yarn loosely around each of the needles behind the open latch, and pass the wound yarn through the yarn feeder of the carriage. (Fig. 58, 59)

NOTE: Do not wind the yarn tightly, or you can not operate the machine smoothly.

(3) Move the carriage with the depressed the left #2 button to form the stitches of the starting row, and continue to knit. The stitches of the starting row are automatically bound off.

(Fig. 60)

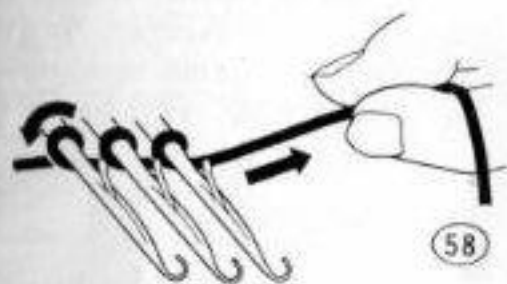

58

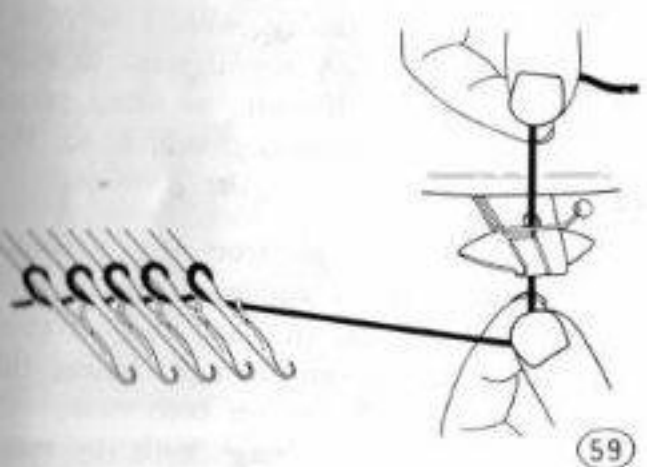

59

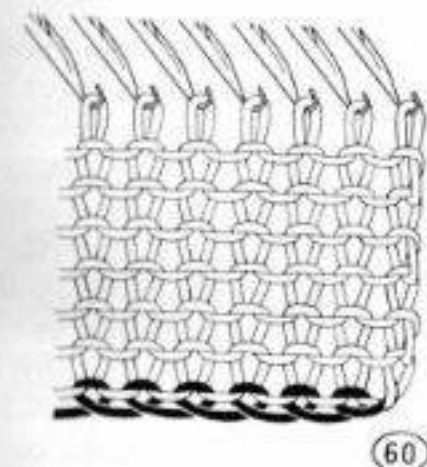

60

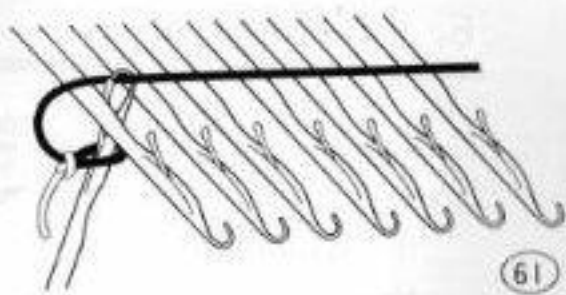

(61)



(62)

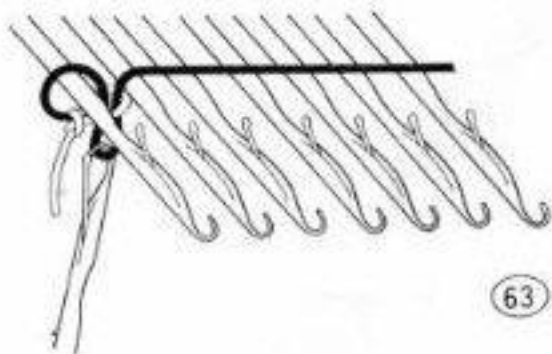

(63)



(64)

4. Chain stitch casting on

- (1) No waste yarn is needed for this cast-on. Move the carriage to the right side of the machine. Select the desired needles for garment. Pull out to D position. Make a loop and slip it on the tappet tool behind the latch. Lay the yarn over all needles. (Fig. 61) (You may bind the yarn around the tappet as shown in Fig. 62) Run the tappet tool up between the needle 1 and needle 2 catching the yarn inside the latch of the tappet. (Fig. 61) Pull down the yarn through the loop already on the tappet.

(Fig. 63)

- (2) Continue catching the yarn with the tappet between each needle. You may loose the stitch at first but you will improve with a little practice.
- (3) After all needles except the last one are cast on, let the yarn hang down between the next-to-last and last needles. Place the loop on the tappet over the last needle. The yarn will be now under the last needle.

(Fig. 64)

- (4) Thread the yarn feeder of the carriage, push down the #2 button on the left side of the carriage and knit across. You will have a finished bound-off edge.

6. Binding off

1. Binding off with tapestry needle

- (1) Thread a tapestry needle with the yarn three times as long the length of the garment to be bound off. Pass the needle through the edge stitch as shown in Fig. 65.

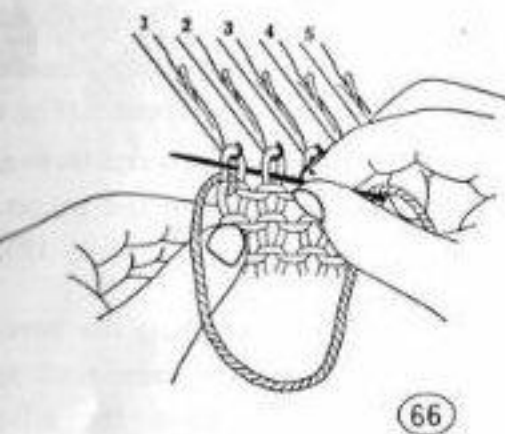
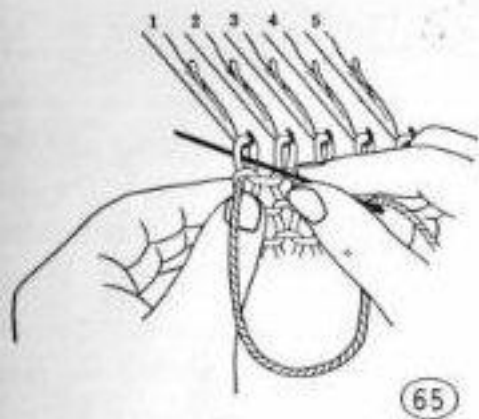

- (2) Insert the needle in through the front of the second needle and around into the back of the first needle. Pull the yarn through both. Avoid pulling too tightly. (Fig. 66)

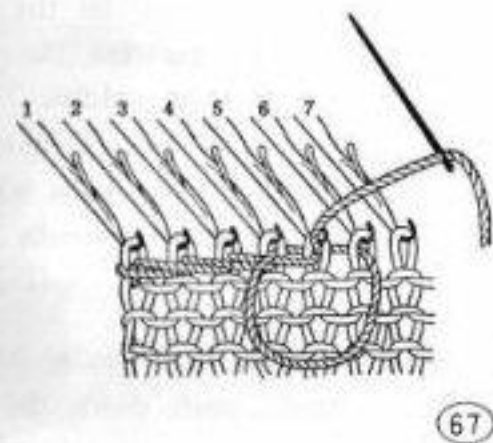

- (3) Repeat the weaving in this circular method until all stitches are bound-off. Do not remove any of the stitches until entire garment is bound off or you will cause stretched stitches.

(Fig. 67)

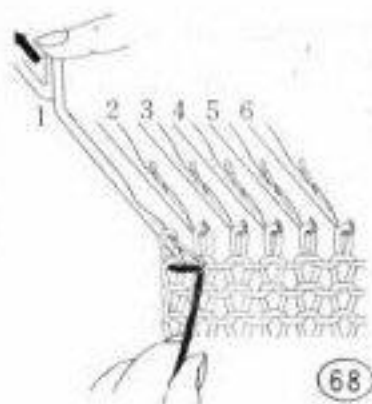

68

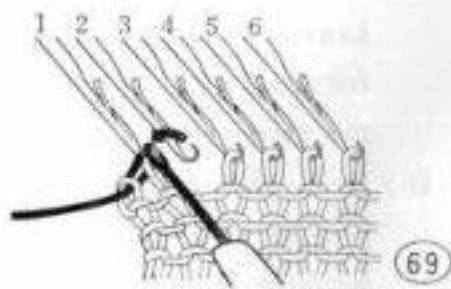

69

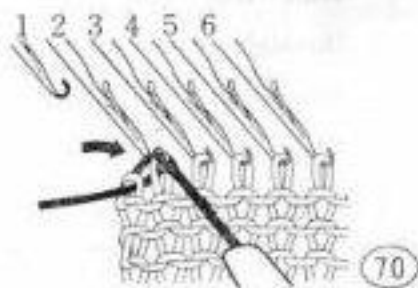

70

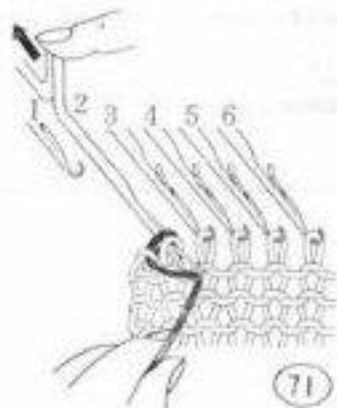

71

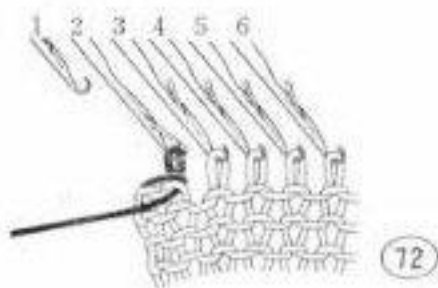

72

2. Double stitch bind off

(start on the carriage side.)

- (1) Pull the end needle forward until the loop is behind the latch. With one hand, grasp the yarn and wrap in a clockwise motion laying the yarn inside the open latch. With the other hand, push the needle back pulling the new stitch through the old. (Fig. 68)

- (2) Transfer the second stitch onto the first stitch. (Fig. 69)

Move this double stitch into full up the empty needle. (Fig. 70)

- (3) Pull the needle forward. Again wrap in clockwise motion laying the yarn inside the latch.

(Fig. 71)

Push back, knitting in stitch.

(Fig. 72)

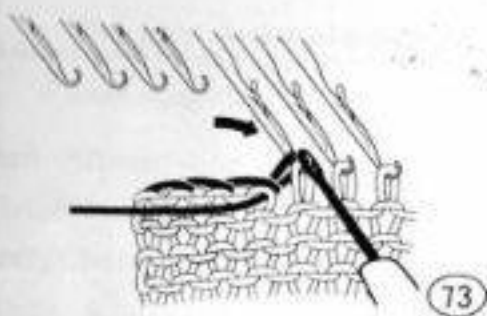

73

(4) Continue in this manner all stitches are bound off except the last. (Fig. 73)

(5) When the last stitch is reached, pull the needle forward until the last loop is behind the latch. Lay the yarn in the hook.

(Fig. 74)

Knit in. One stitch is left. Leaving the yarn as required for back stitch weaving, cut the yarn.

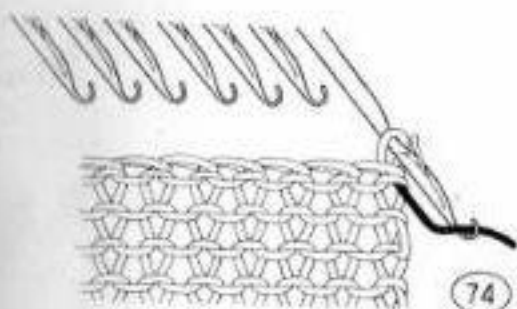

74

(6) Push the needle back to A position stretching the stitch.

Remove from the machine.

Run the end of the yarn through the loop and pull the end stitch in firmly. (Fig. 75)

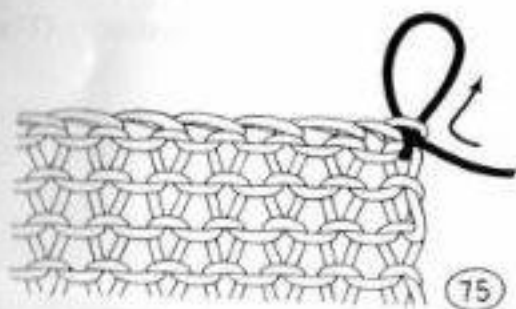

75

7. Removing

the garment from

the machine

1. Using a hand knitting needle

Pull forward to D position all the needles from which the stitches are to be removed. *Hold the garment with your left hand. With a hand knitting needle in your right hand, go in through back of the end stitch. Push the needle up through the stitch about $\frac{1}{2}$ inch. With the thumb of your hand, push the end machine needle back and slip the end stitch off. Hold the stitch now

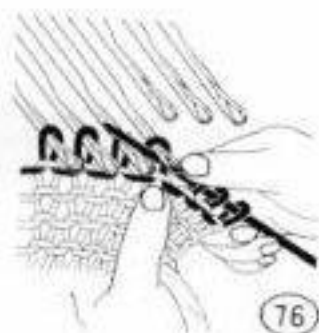

76

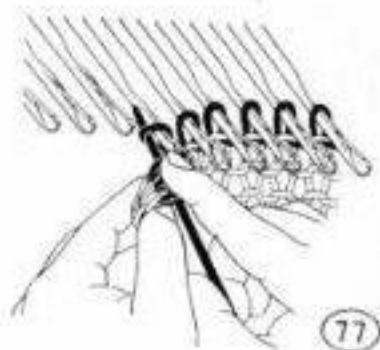

77

on the hand knitting needle down with the thumb. Repeat from * until all stitches are removed from the machine. (Fig. 76)

NOTE: You can also remove the stitches starting from the left side of the garment by inserting the hand knitting needle in through the front of the stitch and catching the side of the stitch. Push the needle back with the fore finger removing the stitch. (Fig. 77)

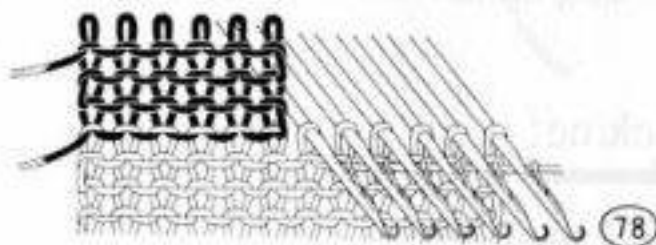

78

2. Using a waste yarn

After the garment is completed, knit 8 to 10 rows with scrap yarn. Remove from the machine. The scrap yarn can be unraveled after weaving or binding off is completed.

If you are going to be partial knitting on only one section of the your garment at a time, it is convenient to knit several rows of waste yarn on the portion to be left inactive. (Fig. 78)

Remove from the machine. This portion can be picked back up when you are ready to knit on it.

(Fig. 79)

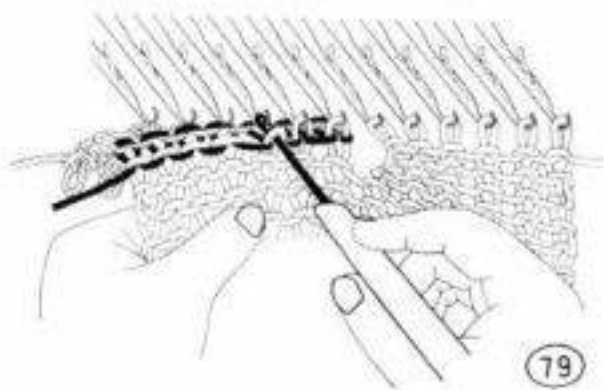

79

VARIED KNITTING PROCEDURES

With the aid of the automatic selecting dial compartment, many pleasing designs can be made quite easily even by beginners.

A few of the basic patterns are illustrated and described in detail on the following pages. A packet of pattern cards is also provided to simplify the making of one and two colour design.

After you have familiarized yourself with the machine and designs, you will be able to vary or even create new patterns using the new dial compartment.

1. Partial knitting on stockinet stitches

Shaping on knitted garments is not done by cutting as with woven fabric. Shape is always formed by increasing or decreasing, or by partial knitting. (Fig. 80)

NOTES:

☆ When you begin partial knitting, make sure that both # 2 buttons are up.

In you knit with the # 2 buttons depressed, the needles at D position resume operation and form stitches.

☆ When partial knitting in an area where you are using patterns calling for

pick-stitches, knit-in patterns, slip stitches or tuck stitches, the # 2 buttons may be released so that the partials will not be disturbed. Some of your pattern needles may have to be pushed back manually to complete a pattern as when doing tuck stitches.

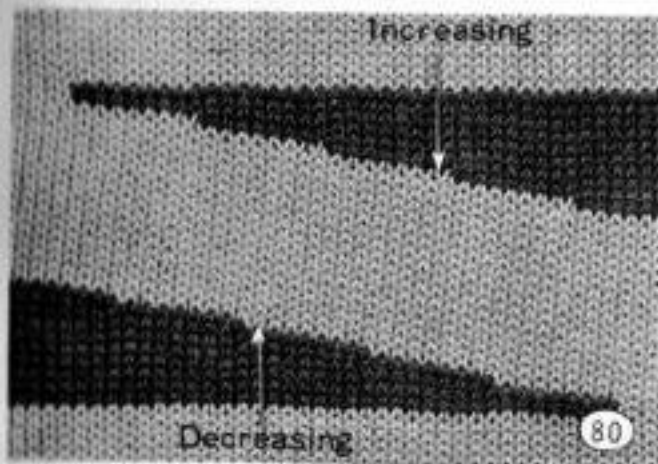

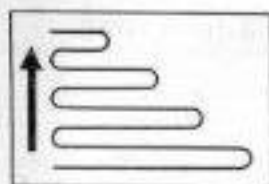

1. Partial Knitting Decreasing

—Pattern panel—

Pattern dial (right) ●

Pattern dial (left) ●

Shift dial 0

—Carriage—

Cam lever STOCKINET

Push button All buttons up

Pattern lever ●

Side lever ●

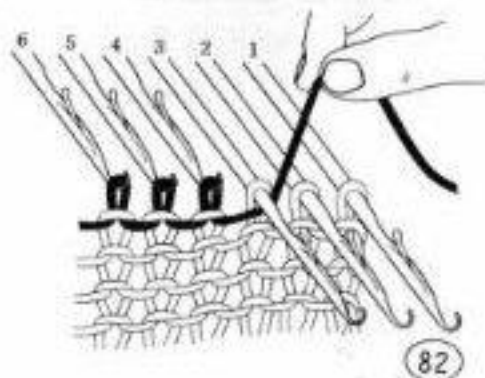
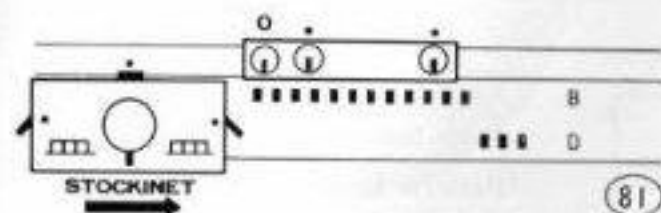

- (1) The number of needles to be decreased on this row should be drawn out into **D** position on the opposite side from where the carriage is. Knit across.

(Fig. 81)

(The yarn is knitted only with the needles at **B** position, and laid over the needles at **D** position.)

- (2) To avoid making a hole, pass the yarn under the first resting needle, lifting it over to lay flat across the other needles.

(Fig. 82)

- (3) Knit back across. This completes the first partial. (Fig. 83)

- (4) Repeat this procedure 1~3 increasing the number of the needles brought out into **D** position.

- (5) After completing the partial knitting, push the #2 button down in the proceeding direction and knit one row. All the needles in **B** and **D** positions are now working. (Fig. 84)

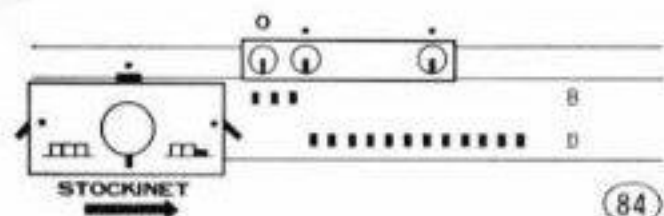
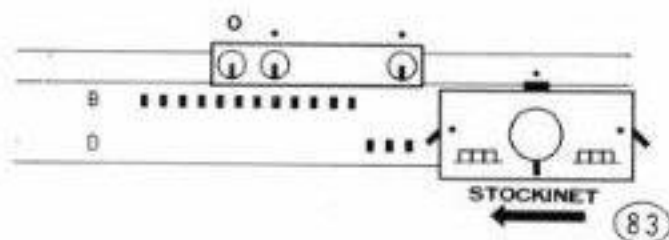

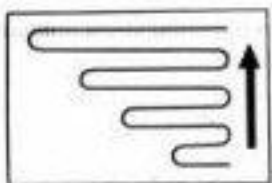

2. Partial Knitting Increasing

—Pattern panel—

Pattern dial (right) ●

Pattern dial (left) ●

Shift dial 0

—Carriage—

Cam lever STOCKINET

Push button All buttons up

Pattern lever ●

Side lever ↓

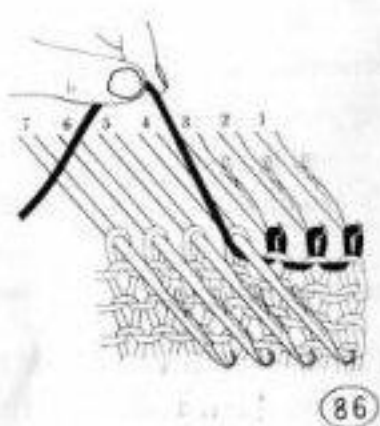
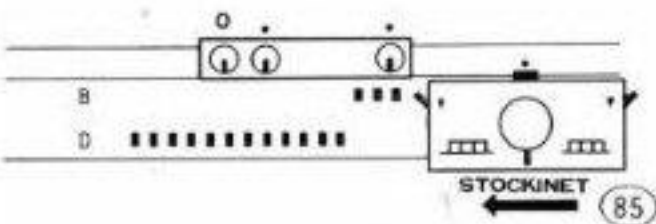

- (1) Place the number of needles to start with in **B** position and the rest in **D** position before you knit one row. (Fig. 85)

- (2) In order to avoid making a hole, pass the yarn under the next resting needle. (Fig. 86)

- (3) Knit another row to complete the first partial knitting.

(Fig. 87)

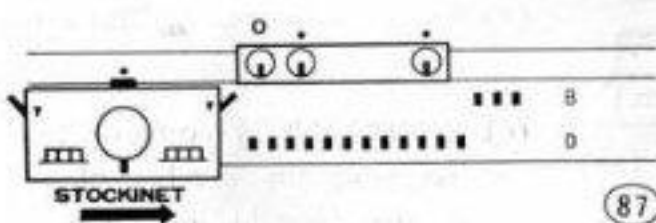

- (4) Push back the next group of needles to be increased to **C** position and knit the 3rd row.

(Fig. 88)

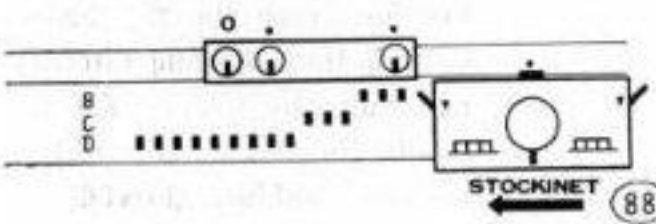

- (5) Repeat this procedure 2~4 and knit as many rows are required.

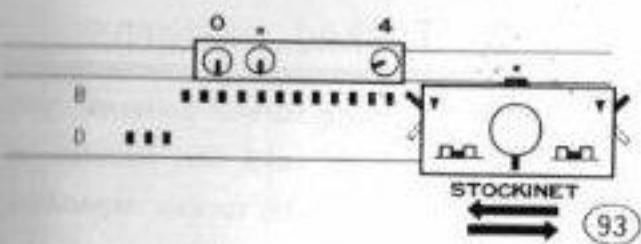

(93)

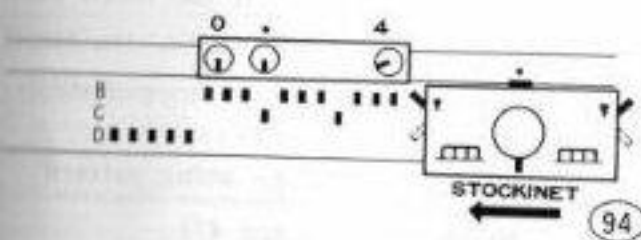

(94)



(95)

22	—	—	—	—	—	—	—	—	—	—	—	—	—	—	—	—	—	—	—	—	—	—
21	—	—	—	—	—	—	—	—	—	—	—	—	—	—	—	—	—	—	—	—	—	—
20	—	—	—	—	—	—	—	—	—	—	—	—	—	—	—	—	—	—	—	—	—	—
19	—	—	—	—	—	—	—	—	—	—	—	—	—	—	—	—	—	—	—	—	—	—
18	—	—	—	—	—	—	—	—	—	—	—	—	—	—	—	—	—	—	—	—	—	—
17	—	—	—	—	—	—	—	—	—	—	—	—	—	—	—	—	—	—	—	—	—	—
16	—	—	—	—	—	—	—	—	—	—	—	—	—	—	—	—	—	—	—	—	—	—
15	—	—	—	—	—	—	—	—	—	—	—	—	—	—	—	—	—	—	—	—	—	—
14	—	—	—	—	—	—	—	—	—	—	—	—	—	—	—	—	—	—	—	—	—	—
13	—	—	—	—	—	—	—	—	—	—	—	—	—	—	—	—	—	—	—	—	—	—
12	—	—	—	—	—	—	—	—	—	—	—	—	—	—	—	—	—	—	—	—	—	—
11	—	—	—	—	—	—	—	—	—	—	—	—	—	—	—	—	—	—	—	—	—	—
10	—	—	—	—	—	—	—	—	—	—	—	—	—	—	—	—	—	—	—	—	—	—
9	—	—	—	—	—	—	—	—	—	—	—	—	—	—	—	—	—	—	—	—	—	—
8	—	—	—	—	—	—	—	—	—	—	—	—	—	—	—	—	—	—	—	—	—	—
7	—	—	—	—	—	—	—	—	—	—	—	—	—	—	—	—	—	—	—	—	—	—
6	—	—	—	—	—	—	—	—	—	—	—	—	—	—	—	—	—	—	—	—	—	—
5	—	—	—	—	—	—	—	—	—	—	—	—	—	—	—	—	—	—	—	—	—	—
4	—	—	—	—	—	—	—	—	—	—	—	—	—	—	—	—	—	—	—	—	—	—
3	—	—	—	—	—	—	—	—	—	—	—	—	—	—	—	—	—	—	—	—	—	—
2	—	—	—	—	—	—	—	—	—	—	—	—	—	—	—	—	—	—	—	—	—	—
1	—	—	—	—	—	—	—	—	—	—	—	—	—	—	—	—	—	—	—	—	—	—
18	15	14	13	12	11	10	9	8	7	6	5	4	3	2	1							

(96)

Partial knitting with tucked

patterns

- (1) When partial knitting on a tucked pattern, follow the directions given for your pattern and then pull out to D position the needles to be partially knitted. Your partials will be done in the same manner as done in a plain or stockinet stitch. (Fig. 93)
- (2) When the tuck pattern calls for the tuck stitches to be knitted back in, DO NOT push down the #2 button as this would also knit in your partials. Instead, release all buttons, and push back manually to C position the needles to be knitted in. Knit across. (Fig. 94)
Continue, carefully watching pattern and forming partials simultaneously.

NOTE: In order to avoid making a hole, pass the yarn under the next resting needle.

3. Slip stitches

Slip stitches by using pattern panel

(Pattern card 92)

—Pattern panel—

Pattern dial (right) 2

Pattern dial (left) 8

Shift dial 4

—Carriage—

Cam lever KNIT-IN

Push button . . . Both #2 buttons
down

Side lever ↓

Pattern lever . . . ●

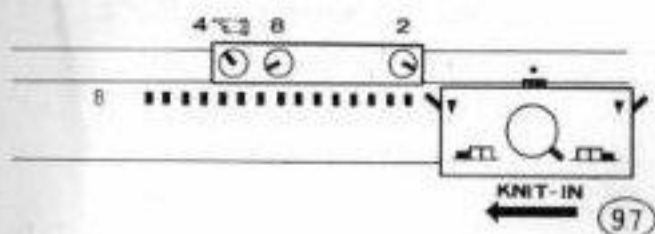

- (1) Knit one row. (with the shift lever set to 4 [↩]) (Fig. 97)
- (2) Set the shift dial to 3 [↩] and knit one row.
- (3) On each new row turn the shift dial to the right one number. When the shift dial reads [↩] 3, reverse pattern moving one number to the left on each new row.

Partial knitting in tucked patterns with slip stitches

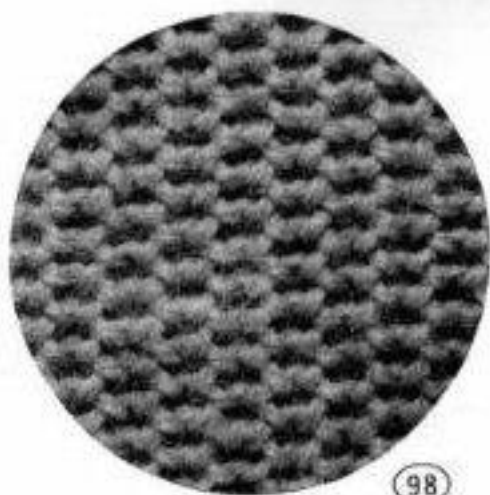

(98)

- (1) Release all buttons, and bring forward the needles to be partially knitted into D position.
- (2) To increase, use your transfer tool to replace the stitches back to the hooks and push back the needles to B position. (If you merely push them in to C position, you will lose the stitches.)

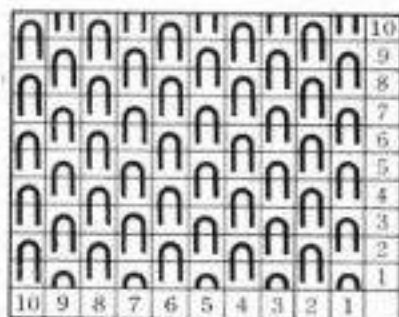

pick knitting.....1 row

(99)

4. Pick patterns

Pick ground pattern by using pattern panel

—Pattern panel—

Pattern dial (right).... 1

Pattern dial (left)..... ●

Shift dial..... 0

—Carriage—

Cam lever.... PICK

Push button... Both # 2 buttons
down

Pattern lever.. PICK

Side lever..... ↓

- (1) Knit one row. (Fig. 100)

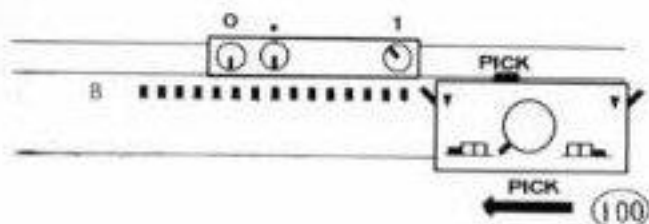

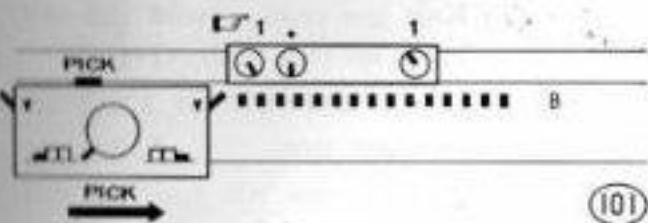

- (2) Set the shift dial to 1, and knit one row (Fig. 101)
- (3) Turn the shift dial to 0, and repeat the operation 1~2.

Partial knitting in pick patterns

Knit as in partial knitting with slip stitch patterns.

NOTE: Set the pattern lever to PICK.

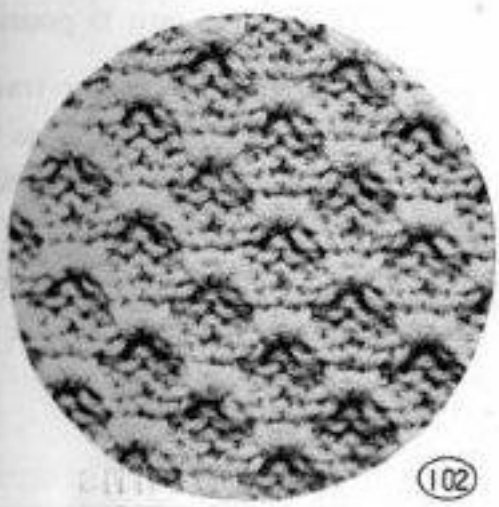

5. Successive tucked patterns

Successive tucked pattern by using pattern panel (Pattern card 3)

- Pattern panel—
- Pattern dial (right) 4
 - Pattern dial (left) ●
 - Shift dial 0

- Carriage—
- Cam lever STOCKINET
 - Push button Left #1 button down
 - Pattern dial ●
 - Side lever ↓

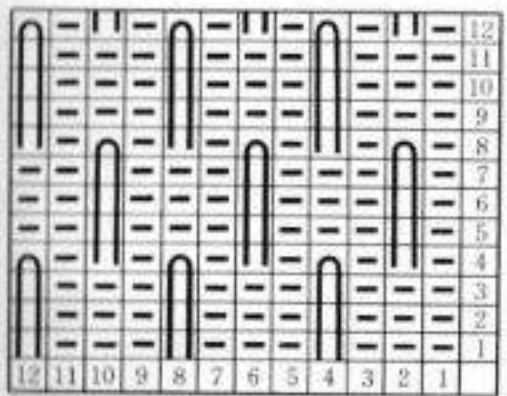

tucked knitting4rows (103)

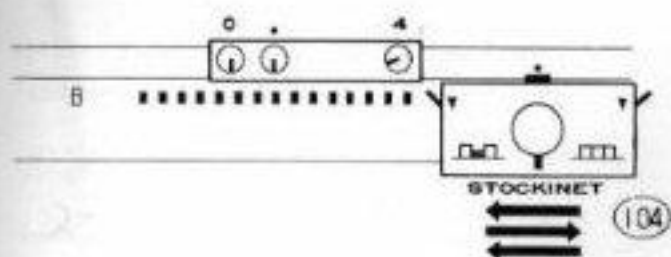

(1) Knit three rows. (Fig. 104)

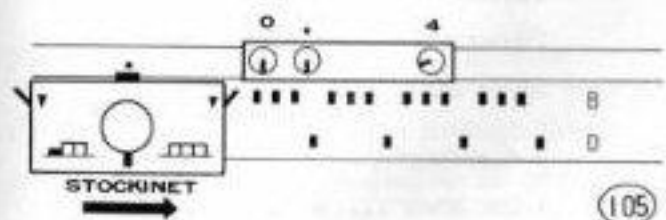

(2) Depress the left #2 button and knit one row. (Fig. 105)

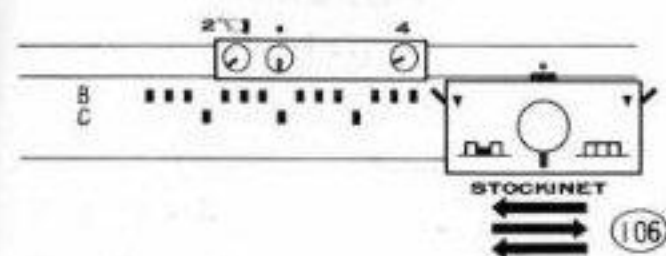

(3) Set the shift dial to 2, depress the left #1 button and knit three rows. (Fig. 106)

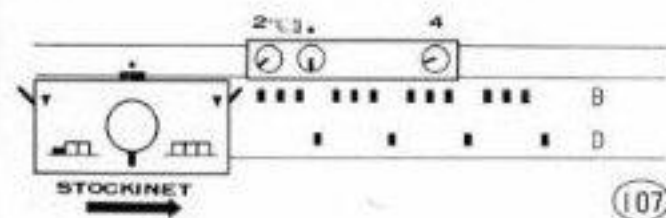

(4) Depress the 2 button on the left side of the carriage, and knit one row. (Fig. 107)

(5) Repeat 1~4.

Partial knitting with successive tucked patterns

Bring out the needles to be rested for partial knitting to D position, depress the ● button instead the #2 button, and knit one row.

Push back the resting needles in D position for successive tucked stitches to C position with your hand.

NOTE: The #2 button is not used in partial knitting with patterns.

6. Knit-in patterns

Knit-in pattern by using pattern panel (Pattern card 76)

—Pattern panel—

Pattern dial (right) ●

Pattern dial (left) 8

Shift dial 0

—Carriage—

Cam lever STOCKINET

Push button . . . Both # 2 buttons
down

Pattern lever . . . KNIT-IN

Side lever ↓

(Preparing needles for knit-in pattern.)

Set the cam lever to STOCKINET and knit one row from left to right with main colour yarn. (The needles will be at C position after knitting this row.)



(108)

				X	X	X	X							12
				X	X	X	X							11
				X	X	X	X							10
				X	X	X	X							9
				X	X	X	X							8
				X	X	X	X							7
X	X	X	X					X	X	X	X	X	X	6
X	X	X	X					X	X	X	X	X	X	5
X	X	X	X					X	X	X	X	X	X	4
X	X	X	X					X	X	X	X	X	X	3
X	X	X	X					X	X	X	X	X	X	2
X	X	X	X					X	X	X	X	X	X	1
12	11	10	9	8	7	6	5	4	3	2	1			

X Contrasting color yarn (109)

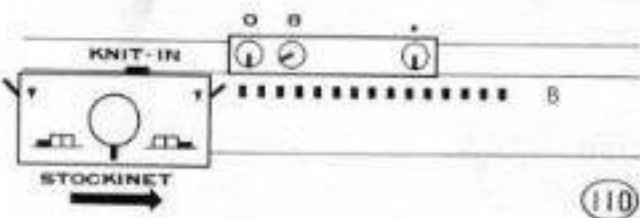

(110)

(1) Reset the cam lever to KNIT-IN.
(Fig. 110)

(2) Lay the contrasting coloured yarn over the needles at C position from right to left.

The yarn should be hooked over the end of the machine on the yarn hook in the direction carriage will be moving.

(Fig. 111)

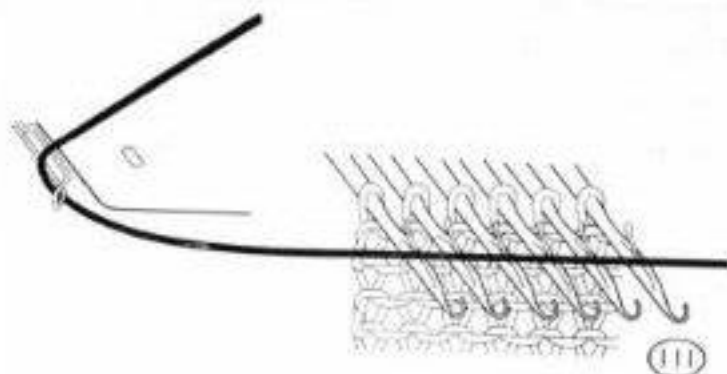

(111)

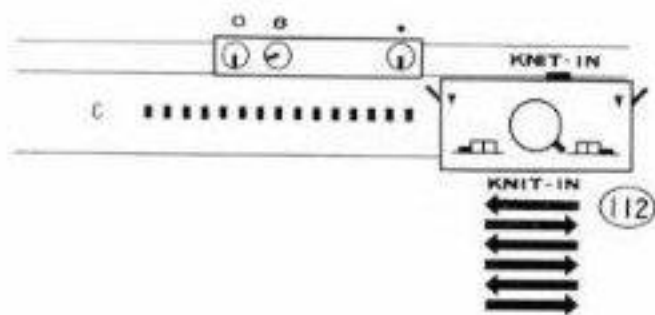

Knit one row with main yarn.
Knit five more rows in the same manner. (Fig. 112)

- (3) Set the shift dial to 4, and knit six rows in a like manner to 2. Reset the shift dial to 0.
- (4) Repeat 2 and 3.

Partial knitting with knit-in patterns

To partial knit in a knit-in pattern using the pattern panel, depress the right and left ● buttons. The needles to be partialled are brought forward to D position.

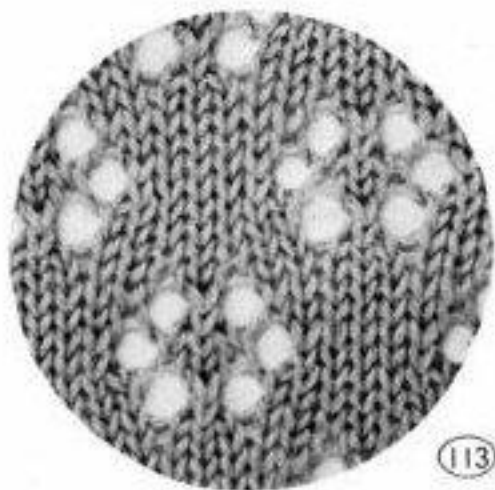

7. Lacy patterns

The transfer tool is used. Both the pattern panel and the carriage are adjusted in the same way as in stockinet knitting.

- (1) Knit two rows stockinet knitting.

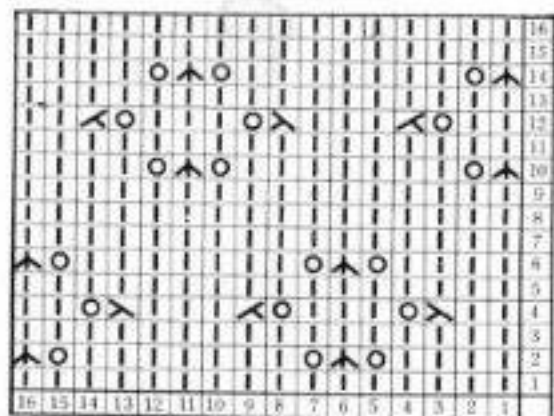

(114)

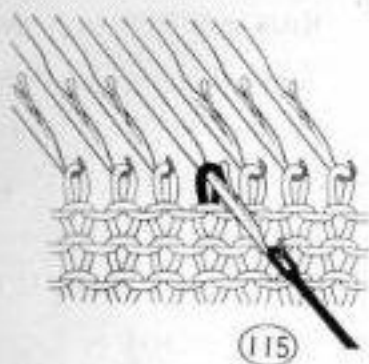

- (2) Place the one eye tool into the hook of the needle in the position marked O in the pattern chart and draw it out to D position. (Fig. 115)

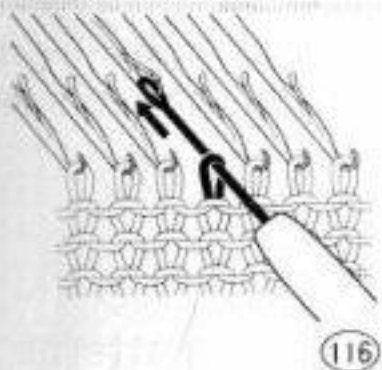

Push back the needle, and the stitch will slide over the needle head onto the tool. (Fig. 116)

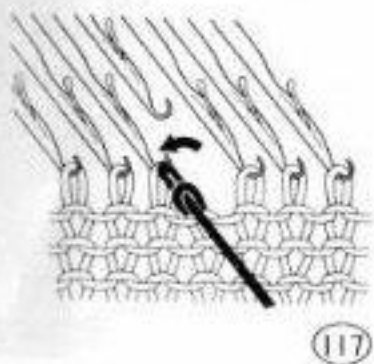

- (3) Following the chart, transfer the stitch on the tool onto the adjacent needle. (Fig. 117)

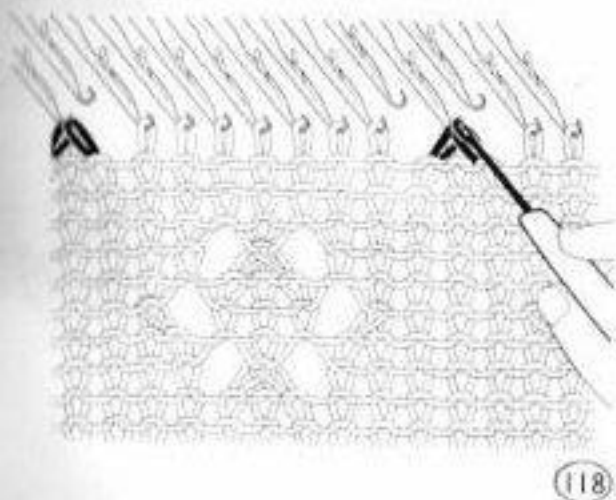

- (4) Knit two rows, and repeat the operation 2~3.

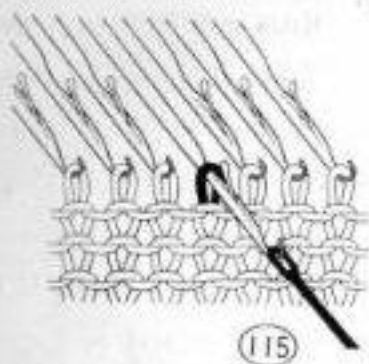

- (2) Place the one eye tool into the hook of the needle in the position marked O in the pattern chart and draw it out to D position. (Fig. 115)

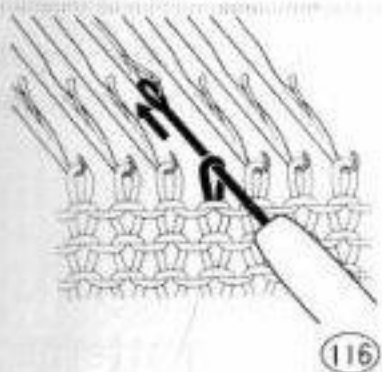

Push back the needle, and the stitch will slide over the needle head onto the tool. (Fig. 116)

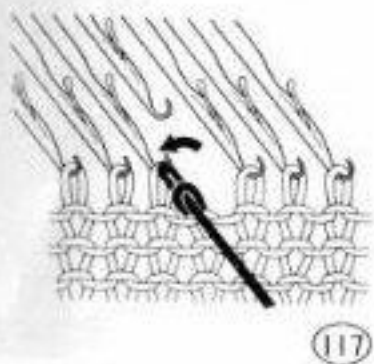

- (3) Following the chart, transfer the stitch on the tool onto the adjacent needle. (Fig. 117)

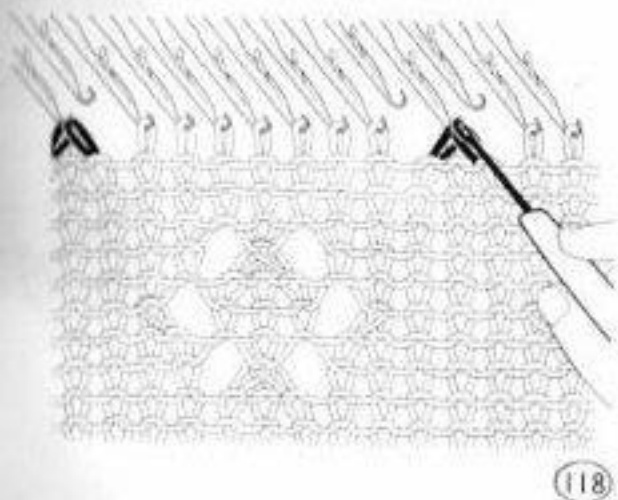

- (4) Knit two rows, and repeat the operation 2~3.

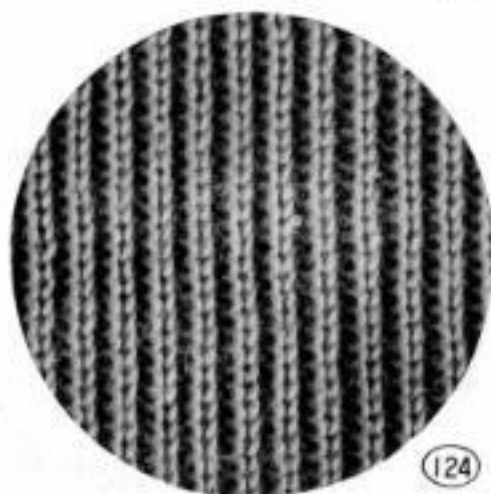
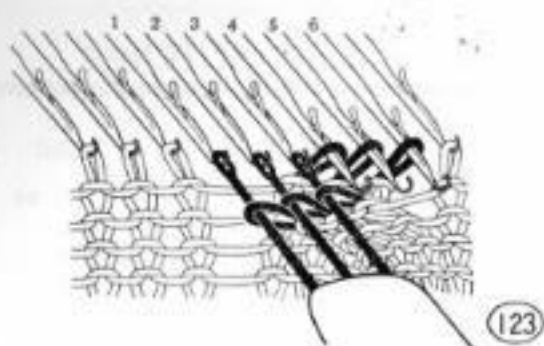

—		—		—		—		—		—		—		12
—		—		—		—		—		—		—		11
—		—		—		—		—		—		—		10
—		—		—		—		—		—		—		9
—		—		—		—		—		—		—		8
—		—		—		—		—		—		—		7
—		—		—		—		—		—		—		6
—		—		—		—		—		—		—		5
—		—		—		—		—		—		—		4
—		—		—		—		—		—		—		3
—		—		—		—		—		—		—		2
—		—		—		—		—		—		—		1
12	11	10	9	8	7	6	5	4	3	2	1			

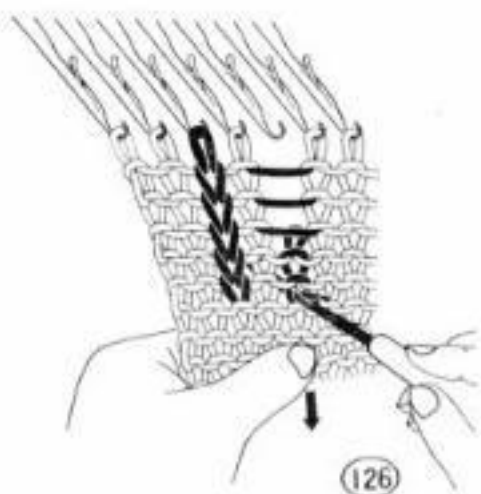

- (4) Repeat these procedures crossing cables in same direction each time. When you have completed three patterns (18 rows), purl one stitch on each side of the cable. (For purling stitches, see the following paragraphs of rib stitches).

9. Rib stitches

Knit one and purl one ribbing

Set the pattern panel and the carriage in the same way as in stockinet knitting.

- (1) For rib knitting, set the tension dial to one number smaller than the stockinet knitting.
- (2) Knit with stockinet stitches as you need for the ribbing. Bring out the third needle from the right to **D** position and then return it to **B** position, letting the stitch drop. Using the rounded end of the tappet, release the stitches down to within two rows from point where ribbing is to begin.
- (3) Insert the hook of the tappet through the last loop of the dropped stitch from where the ribbing is supposed to start. Then undo the stitches above by pushing down the tappet.

(Fig. 126)

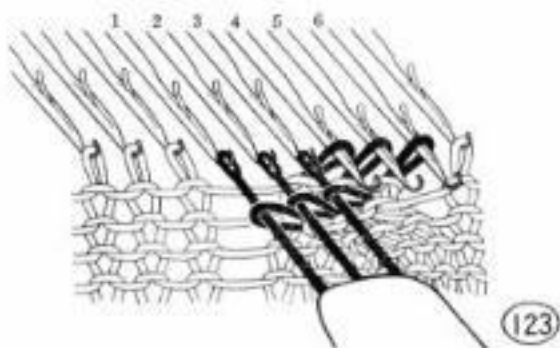

-		-		-		-		-		-		-		12
-		-		-		-		-		-		-		11
-		-		-		-		-		-		-		10
-		-		-		-		-		-		-		9
-		-		-		-		-		-		-		8
-		-		-		-		-		-		-		7
-		-		-		-		-		-		-		6
-		-		-		-		-		-		-		5
-		-		-		-		-		-		-		4
-		-		-		-		-		-		-		3
-		-		-		-		-		-		-		2
-		-		-		-		-		-		-		1
12	11	10	9	8	7	6	5	4	3	2	1			

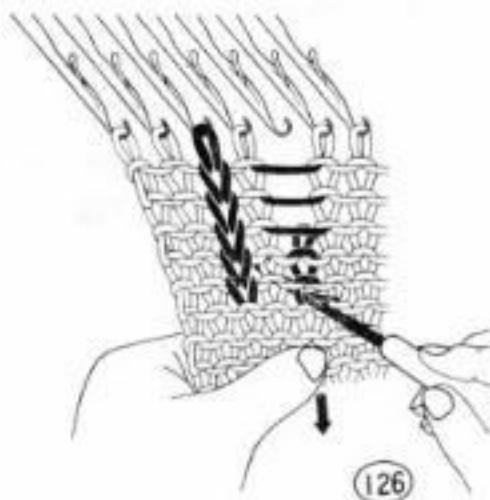

- (4) Repeat these procedures crossing cables in same direction each time. When you have completed three patterns (18 rows), purl one stitch on each side of the cable. (For purling stitches, see the following paragraphs of rib stitches).

9. Rib stitches

Knit one and purl one ribbing

Set the pattern panel and the carriage in the same way as in stockinet knitting.

- (1) For rib knitting, set the tension dial to one number smaller than the stockinet knitting.
- (2) Knit with stockinet stitches as you need for the ribbing. Bring out the third needle from the right to **D** position and then return it to **B** position, letting the stitch drop. Using the rounded end of the tappet, release the stitches down to within two rows from point where ribbing is to begin.
- (3) Insert the hook of the tappet through the last loop of the dropped stitch from where the ribbing is supposed to start. Then undo the stitches above by pushing down the tappet.

(Fig. 126)

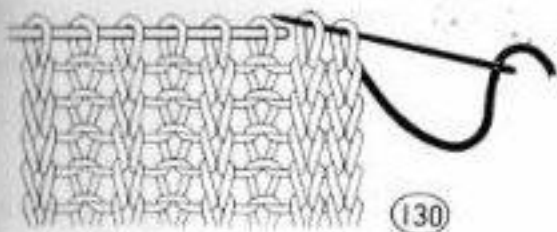

(130)

- (1) Insert your needle from the purl sides of your first two rib stitches and pull your yarn through. (Fig. 130)

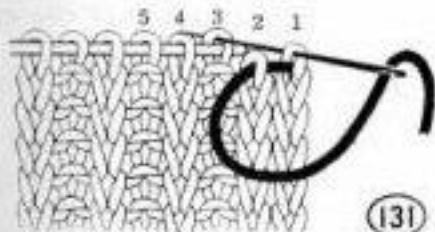

(131)

- (2) Insert your needle from the rib side of the first stitch and back through the purl side of the third stitch. (Fig. 131)

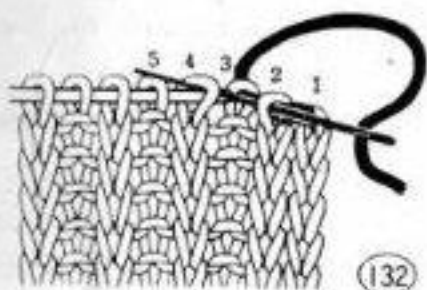

(132)

- (3) Following Fig. 132 insert the needle into the second stitch on the rib side and pass it through the fourth stitch on the purl side.

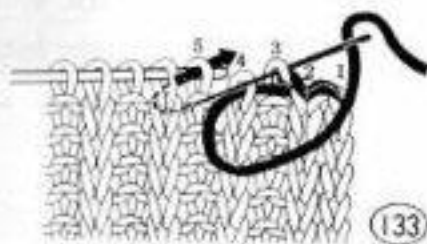

(133)

- (4) Rib side the third stitch and purl side the fifth stitch.

(Fig. 133)

- (5) Repeat the same procedure to the end of the row and insert the needle once more into the last two plain stitches. The yarn goes through each stitch twice all the way. (Fig. 134)

NOTE: Do not slide the second stitch off the hand knitting needle until the yarn has passed through it twice.

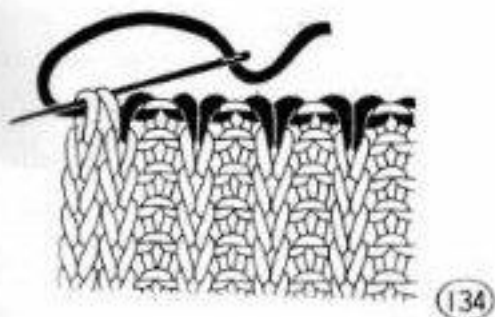

(134)

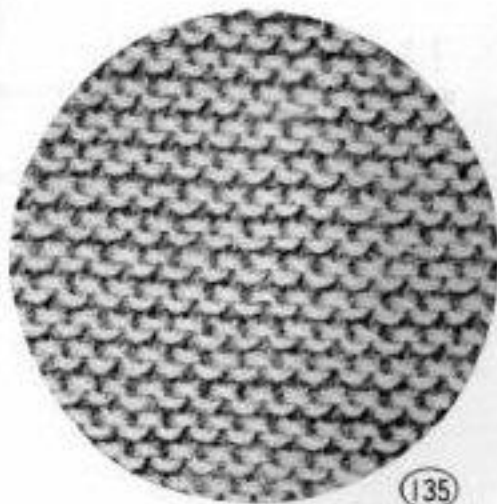

(135)

-	-	-	-	-	-	-	-	-	-	-	-	-	-	-	12
															11
-	-	-	-	-	-	-	-	-	-	-	-	-	-	-	10
															9
-	-	-	-	-	-	-	-	-	-	-	-	-	-	-	8
															7
-	-	-	-	-	-	-	-	-	-	-	-	-	-	-	6
															5
-	-	-	-	-	-	-	-	-	-	-	-	-	-	-	4
															3
-	-	-	-	-	-	-	-	-	-	-	-	-	-	-	2
															1
12	11	10	9	8	7	6	5	4	3	2	1				

(136)

10. Garter stitches

Set the pattern panel and the carriage in the same way as in stockinet knitting.

- (1) Knit two rows.
- (2) Open all of the latches of the needles.
- (3) Purl all of the stitches of the second row with the tappet.
(Fig. 137)
- (4) Repeat operation 1~3.

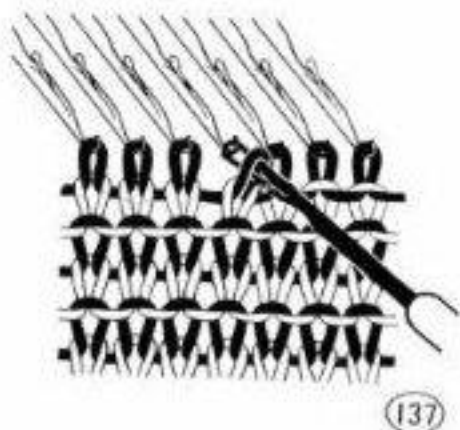

(137)

NOTE: The garter stitch design is often avoided because of the time consumed in the hand purling. A handy tool called the **GARTER BAR** makes this process easy as well as fast. The **GARTER BAR** can also be used for multiple transferring and many designs.

11. Stranding or adding yarn

When using

- a single medium size yarn
(main colour)
- a single two-ply yarn
(contrasting colour)
- Wrong side: main colour
(medium size yarn)
- Right side: contrasting colour
(two-ply yarn)

These two yarns are knitted together. The stockinet stitch is formed with the contrasting colour above the main colour.

In this case, the contrasting colour will appear on the right side and the main colour on the wrong side, thus making each side a different colour.

Any other material than woolen yarn may be used for contrasting colour yarn.

☆Set the tension dial to 7.

☆The pattern panel and the carriage are set in the same way as in stockinet knitting.

- (1) Insert the yarn (contrasting colour) which will appear on the right side into the center hole of the yarn feeder.
- (2) Insert the yarn (main color) which will appear on the wrong side into the back hole of the yarn feeder. (Fig. 139)

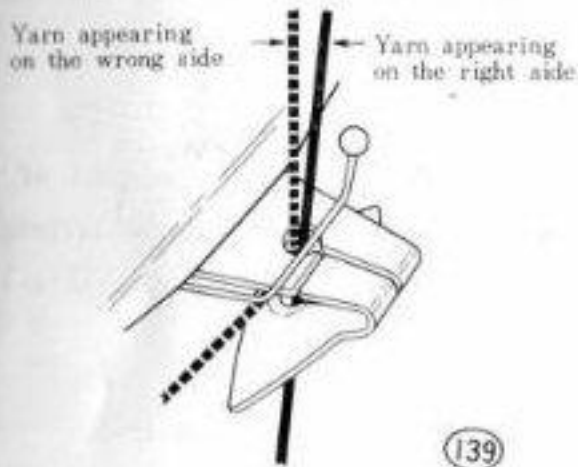

12. Cord knitting

Set the pattern panel as in stockinet knitting.

—Carriage—

Cam lever either L or R

Push button . . . Both # 2 buttons
down

Pattern lever . . . ●

Side lever ●

(Fig. 140)

Bring forward to **D** position from two to five needles depending on the thickness of the cord you desire. Knit back and forth. Apply a gentle downward pressure, with free hand, on the tail of the cord, and the stitches will be pulled together to form a cord. (Fig. 141)

NOTE: Try braiding three of these cords together and use as trim.

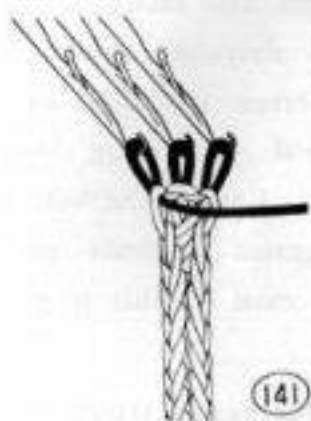
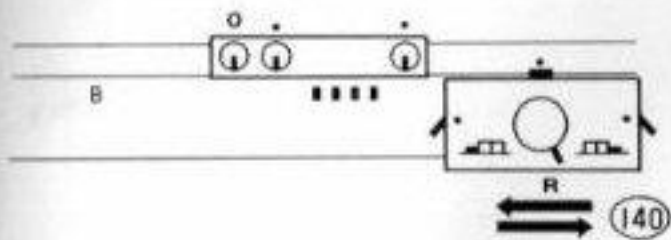

1. Increasing and decreasing stitches

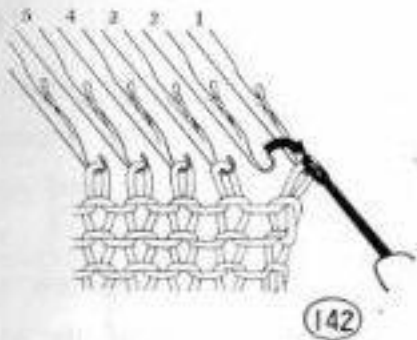

There are many ways to increase and decrease stitches. By using different methods we can create varied decreasing and increasing lines. Experiment with the following suggested methods and choose the one most suitable to your garment.

1. Increasing stitches

☆ Increasing one edge stitch:

The first way

- (1) With the one eye transfer tool, place an edge stitch onto the hook of the next vacant latch needle leaving the second needle empty. (Fig. 142)
- (2) Take the top loop of the purl stitch on the third needle and place it on the empty needle to form a new stitch. (Fig. 143)

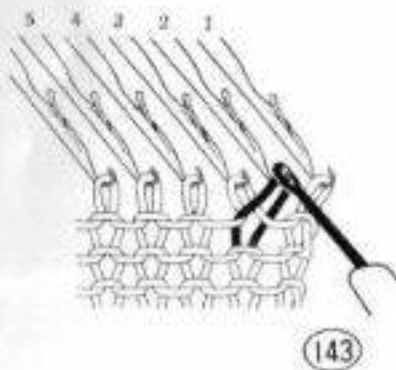

The second way

- (1) With a two eye transfer tool, transfer the last two stitches over one space so that the third needle is vacant. (Fig. 144)

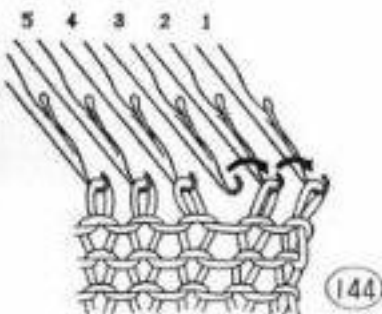

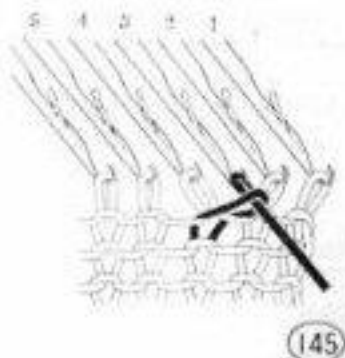

- (2) Take the top loop of the purl stitch under the stitch on the fourth needle and place it on the empty needle to form a new stitch. (Fig. 145)

NOTE: The illustration (Fig. 146) shows another way of forming a new stitch.

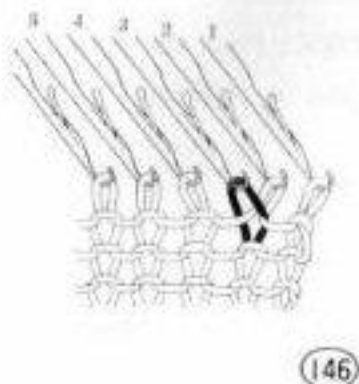

☆ **Increasing two or more edge stitches:**

- (1) Bring out the empty needles required to be increased to D position on the carriage side on the needle bed.

- (2) Wind the knitting yarn loosely around each of the needles behind the open latch. (Wind in counterclockwise direction for increasing on right edge, and in clockwise direction for increasing on left edge).

(Fig. 147)

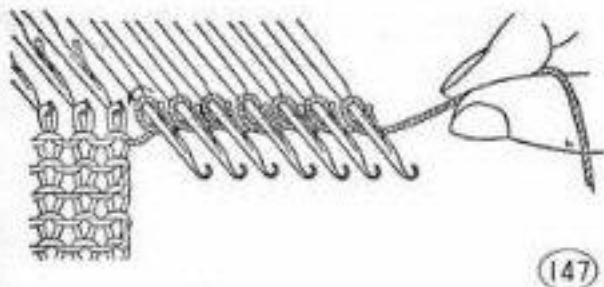

- (3) Depress the #2 button in the proceeding direction of the carriage.

Knit across. (Fig. 148)

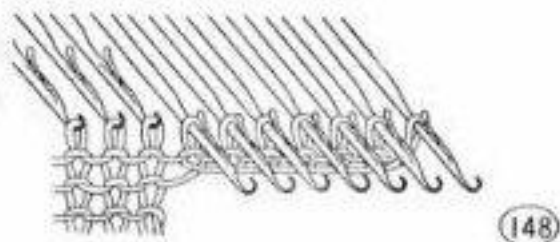

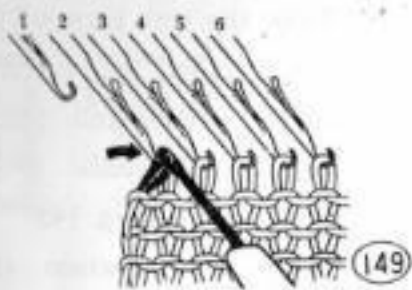

2. Decreasing stitches

☆Decreasing one edge stitch:

The first way

With a one eye transfer tool, place the last stitch over the next to the last stitch. (Fig. 149)

NOTE: Push the empty needle back into A position.

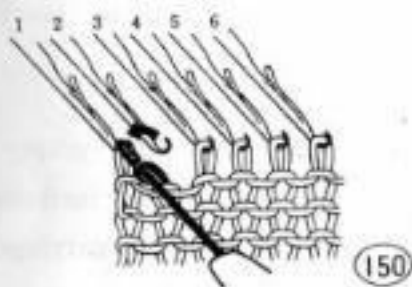

The second way

With a one eye transfer tool, place the second stitch from the edge onto the edge stitch. (Fig. 150)

Place both stitches on to the empty second needle. (Fig. 151)

NOTE: Push the empty needle back into A position.

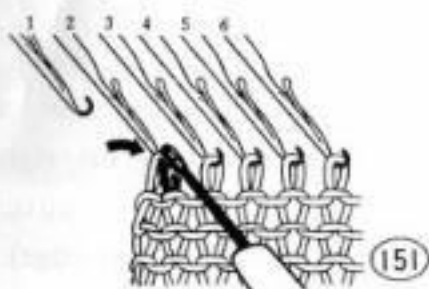

The third way

With a one eye transfer tool, place the third stitch from the edge onto the second stitch. (Fig. 152)

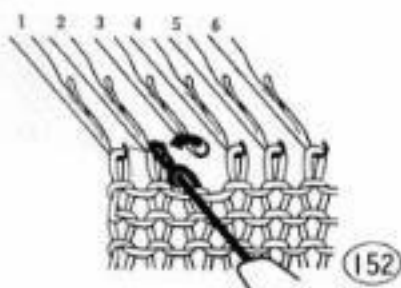

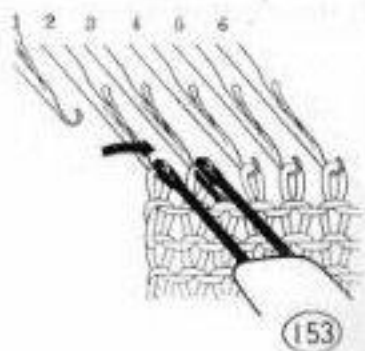

(153)

With a two eye transfer tool take the two stitches on the second needle and the stitch on the first needle to the empty needles.

(Fig. 153)

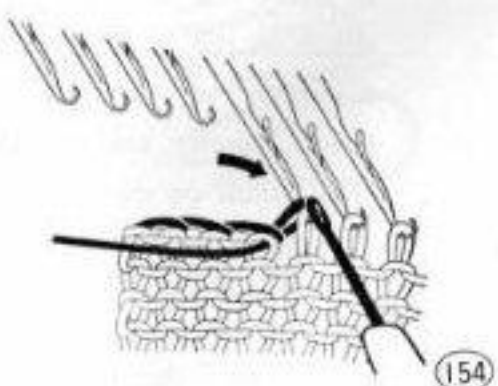

(154)

NOTE: Push the empty edge needle back into A position.

The further in you decrease, the wider your decrease line will be on your garment.

☆ **Decreasing two or more edge stitches on the side where the carriage is placed:**

Making reference to the paragraphs 1, 2, and 3 of Double Stitch Bind Off on the page 27, bind off all except the last stitch to be decreased. Place the last loop you have just knitted onto the next needle (Fig. 154), and knit a row by using the carriage. (Fig. 155)

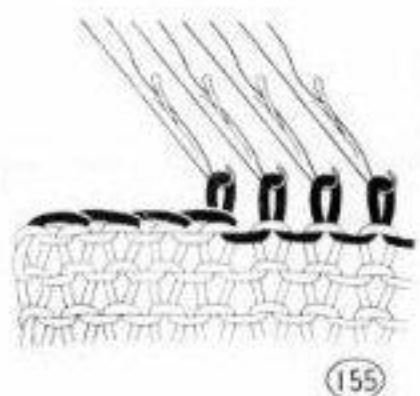

(155)

2. Seaming

1. Seaming stockinet stitches:

- (1) Lay two pieces of stockinet knitting closely together. The stitches are on hand knitting needles or knit-off on scrap yarns. The knitting yarn on the tapestry needle is three times as long as the seam.

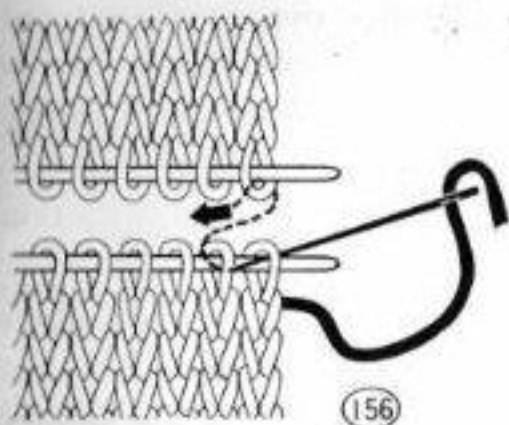

(2) Insert the needle into the first stitch from the wrong side of the lower piece. Next insert the needle into the first stitch of the upper piece of knitting from the wrong side. Pull the yarn through. (Fig. 156)

(3) Once again the tapestry needle is placed in through the first stitch on the lower piece.

Continue to run the needle across, under and up the second stitch on the lower piece. Pull the yarn through.

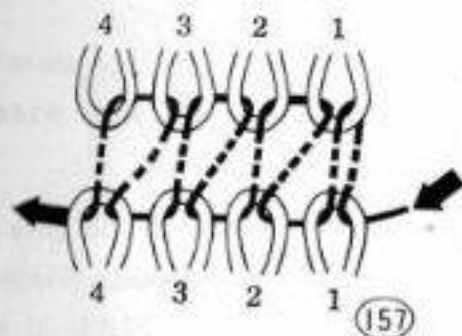

(4) For the second time insert the needle into the first stitch on the top piece. Repeat this procedure until the seam is completed. (Fig. 157)

2. Seaming on machine needles

Seam will be more firm if you use the machine needles. It is an excellent way to seam shoulders. Place the two pieces of knitting to be seamed on the machine needle the right sides in. Knit one row with the carriage. Unthread and break the knitting yarn leaving three times the length of the seam. Thread it into the tapestry needle and bind off, following the page 26. The seam may be bound off either side of the garment.

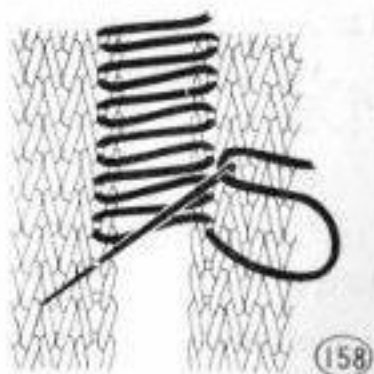

158

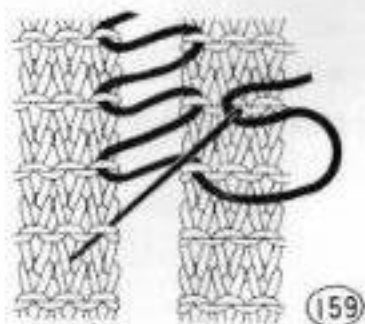

159

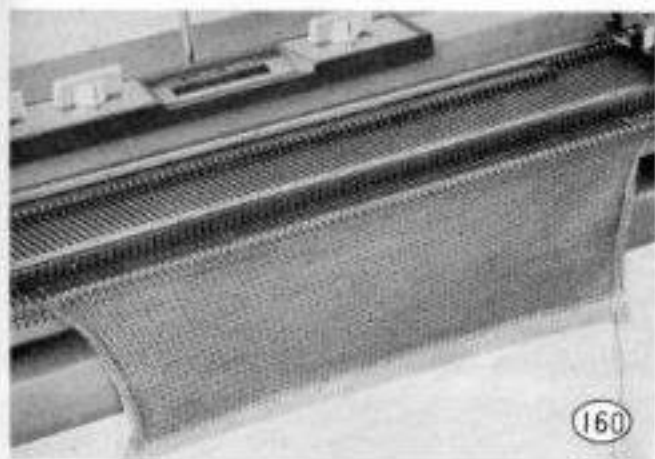

160



161

3. Seaming side stitches:

Thread the tapestry needle with the yarn double the length of the garment. Bring the two pieces to be jointed closely together. Weave each edge stitch on both pieces by passing the needle through the inside loop of every row. Join the edges neatly. (Fig. 158)

Another way of seaming (Fig. 159)

3. Hemming a garment

Select the number of the needles needed for back of the garment.

Cast on with waste yarn and knit six or eight rows. Knit one row with ravelling cord. (Tension for hem is usually one number tighter than garment tension.) Thread the carriage with the main yarn. Reset Row counter to 0. Knit one inch or number of rows otherwise indicated on pattern. $\frac{1}{2}$ of the hem is completed. Set the tension dial two numbers larger than hem tension. Knit one row. Reset tension.

Complete the other half of the hem.

(Fig. 160)

To pick up and "seal" the hem, follow the steps listed below.

- (1) With one-prong transfer tool, pick up the first row of loops (main yarn) that run parallel with the ravelling cord. Place each loop or stitch picked up on the top of the stitches already on the machine needles.

(Fig. 161)



- (2) After all stitches are picked up, reset the row counter to 0. Now, reset the tension dial to garment tension. Continue to knit across.

NOTE: After a few rows have been knitted in the main body of the garment, undo each edge stitch of the ravelling cord, and pull out the cord. The waste yarn will fall free, revealing a neat, smooth finished hem. (Fig. 162)

Now that you have read through the pages of your instruction book, it is possible for you to knit a garment.

The two patterns shown here are suitable for beginners.



1. Room shoes for lady

—Material—

Medium size yarn . . . 50 g.

Elastic 20 in.

—Gauge—

4 in. square = 32 stitches × 44 row

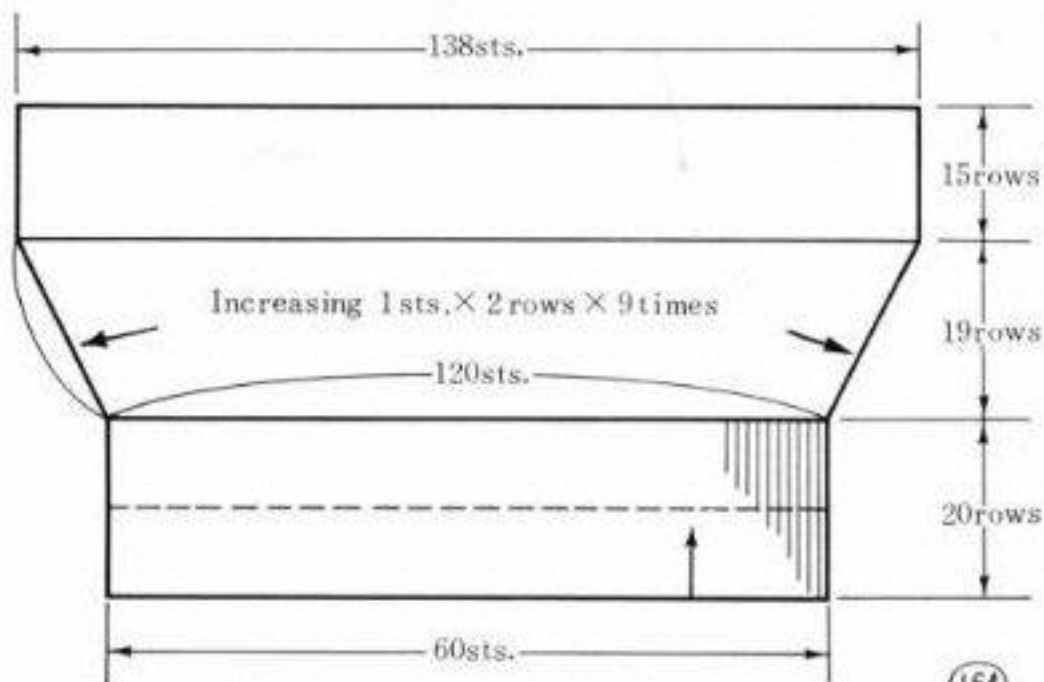

(Cast on with every other needles)

- (1) Pull out 120 needles. (60 needles on each side of 0)

With the needle pusher push back to **A** position every other needle, beginning with the second needle from the end. Pull the other needles still in operation out to **D** position. Cast on following the directions on page 24.

- (2) Set the tension dial to 4. Depress both $\neq 2$ buttons and knit 20 rows.

- (3) Pull out to **B** position the 60 needles that were pushed back to **A** position. Place each stitch of the starting row onto each of the 60 empty needles, to form hem. Now 120 stitches are on the machine. (Fig. 165)

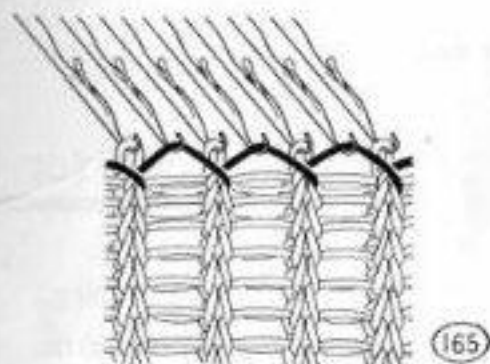

- (4) Reset the tension dial to 5 and knit one row.

- (5) (Formula — Increase 1 st. \times 2 rows \times 9 times)

Knit 2 rows and increase one stitch on both sides. Knit 2 more rows and increase again. Continue knitting, increasing every other row evenly on both sides until you

have increased the 18 stitches called for in the formula. The last set of increases should be made on the 18th row. Now 138 stitches are on the machine.

- (6) Knit 15 rows without increasing or decreasing.

Then knit 5 rows with waste yarn and remove the knitting from the machine.

- (7) Push back half of the needles to **A** position, retaining the other 69 needles in **B** position. [$(120 + 18) \div 2 = 69$] Fold the work with the right side together.

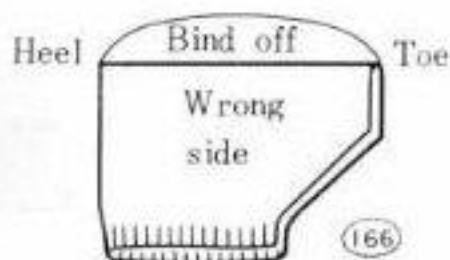

Place the two stitches of the last row of the folded work onto each of the 69 needles.

(Place the toe portion on the right side). Undo the 5 rows of waste knitting. (Fig. 166)

- (8) Knit one row with the carriage right to left.

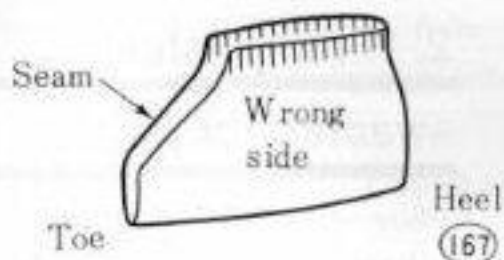

(9) Measure the yarn three times the length of the garment, and cut the yarn. Bind off with the tapestry needle and remove the garment from the machine.

(10) Seam the instep portion to form the toe. (Fig. 167)

(11) Seam approximately 0.8 in. of the heel portion from the wrong side. Fold over and seam down to the bottom. (Fig. 168)

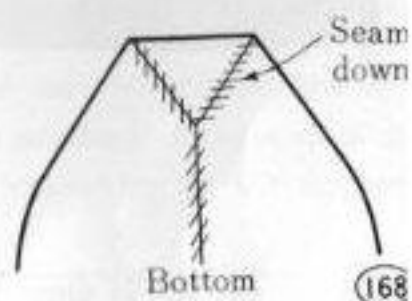
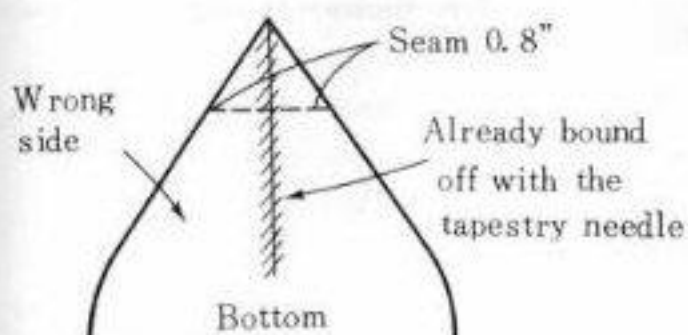

(12) Pass elastic inside the doubled portion of the top. One of a pair is completed.

(13) Complete the other in the same manner.

2. French sleeve sweater for child

—Size—

Width 13.5 in.

Length 15 in.

—Material—

Medium size yarn 150 g.

—Gauge—

4 in. square = 32 stitches × 44 rows

(169)

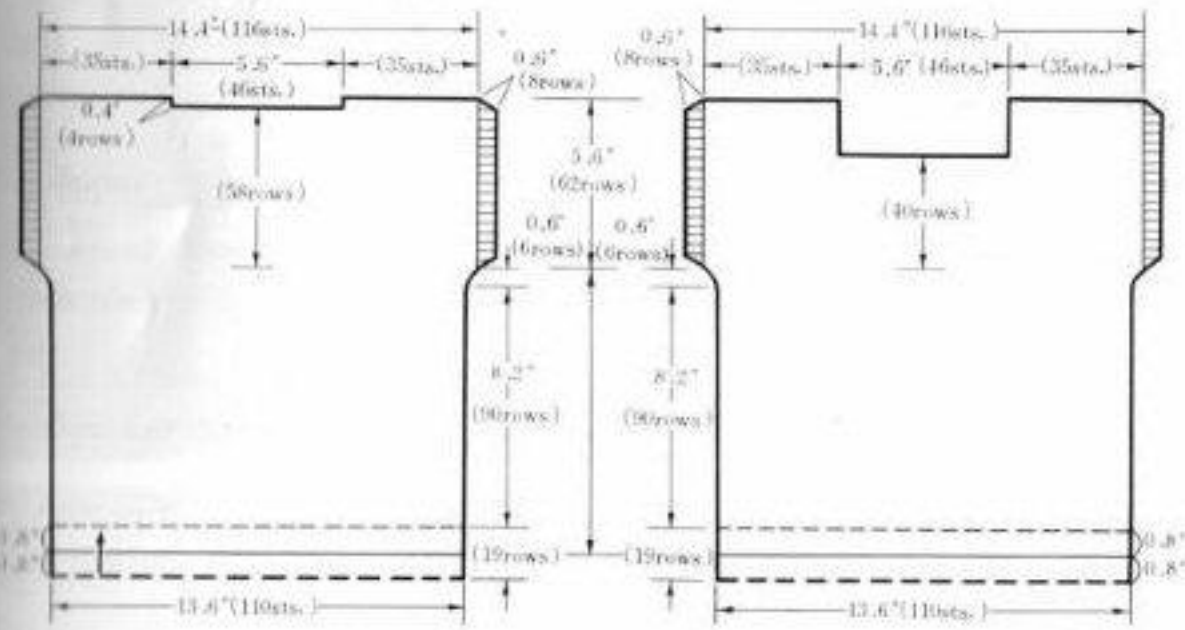

(170)

Back of sweater

- (1) Pull out 110 needles to D position and cast on by winding on all 110 needles from left to right.
- (2) Set the tension dial to 5. Depress both #2 buttons and knit 19 rows.

- (3) Place each stitch picked up from the cast-on row onto the needles. You will now have two stitches on each needle.
- (4) Reset the tension dial to 7 and knit one row.
- (5) Reset the tension dial to 5 and knit 89 rows.
- (6) Increasing one stitch every second row three times evenly on both sides, knit 6 rows. Now 116 stitches are on the machine.
- (7) Knit 58 rows without increasing or decreasing.
- (8) Retain 35 needles from the carriage side (left-hand side) for the shoulder at **B** position and pull out all of the other needles to **D** position. Release all of the buttons and knit 4 rows with the 35 needles at **B** position for the left shoulder.
- (9) Cut the yarn, leaving approximately six times the length of the stitches at the shoulder. Knit several rows with waste yarn. Remove the 35 stitches from the machine.
- (10) Push back the 35 needles at the opposite side (right-hand side) into **C** position. Set the side lever to **↓**. Knit 4 rows and remove from the machine in the same manner as the other shoulder. (See the paragraph 9.)
- (11) Push back the remaining 46 needles from **D** position to **C** position. Knit several rows with waste yarn and remove from the machine.

☆**Front of sweater**

- (12) Repeat operation 1~6.
- (13) Knit 40 rows without increasing or decreasing.
- (14) Retain the 35 needles for the shoulder at the carriage side (left-hand side) at **B** position. Pull out all of the other needles to **D** position. Release all of the buttons and knit 22 rows with the 35 needles at **B** position.

- (15) Cut the yarn, leaving 2~2.5 in. Knit several rows with scrap yarn and remove from the machine.
- (16) Push back the 35 needles at the opposite side (right-hand side) into C position. Set the side lever to **↓**, and knit 22 rows. Knit several rows with waste yarn and remove from the machine. (Same as the paragraph 15)
- (17) Push back all of the other 46 needles at the center of the needle bed into C position. Knit several rows with scrap yarn and remove from the machine.

☆Finishing

- (18) Place the back and front together, right sides in and wrong side out. Place the double stitch loops (one from each piece) of one shoulder on the machine until all of the 35 stitches are on. Undo the waste yarn.
- (19) Thread the carriage with the yarn left from the end of the work, and knit one row. Bind off the shoulder with the tapestry needle. Remove from the machine.
- (20) Finish the other shoulder in the same way as the paragraphs 18 and 19. Remove from the machine.
- (21) For the sleeve band;
Pull out 87 needles into B position. With the wrong side towards you, place the loop picked up from the end of the shoulder seam onto the center needle and the last edge stitch increased onto each end needle. Place 84 loops onto the other needles picked up equally from the edge.
- (22) Reset the tension dial to **4**, and knit across from left to right. Knit 7 more rows. Purl every other stitch for ribbing. Cut the yarn, leaving three times as long as the length of the sleeve band. The yarn is on the left side of the needle bed.
- (23) Transfer the stitches onto a hand knitting needle. Bind off the stitches by rib binding.

(24) Finish the other sleeve band in the same way as the paragraphs 21, 22 and 23.

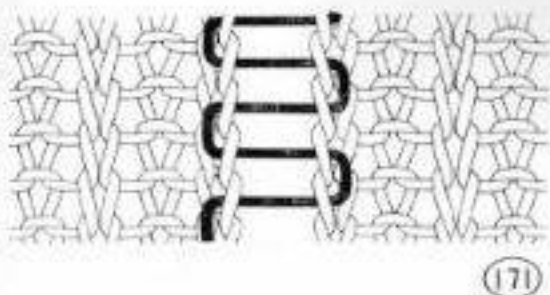

(25) Seam together the edges of the ribbed sleeve band, holding the right sides together and weave as shown in Fig. 171.

(26) Weave side seams together as shown in instruction book page 53.

☆Finish of neck line

(27) A single crochet and a shell stitch crochet edge can be made at the neck line for a nice finish.

(1st row)

(2nd row)

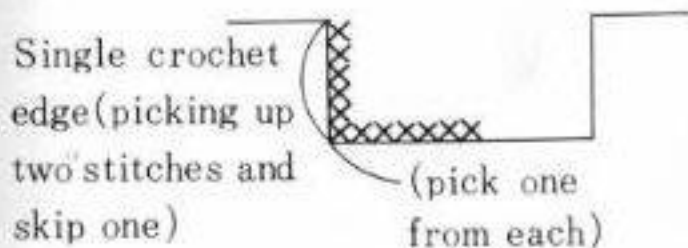

Shell crochet

(172)



Curly and stitch together →

(173)

(28) Knit a 3 needle cord, as shown on page 47, 47 in. long. Curl the end and stitch together. Run the cord through each "shell". Tie in a small bow.

1. Replacing damaged needles

The needles can be easily replaced by following the three steps below. It is not necessary to remove the garment from the machine while replacing needle.

- (1) Push out the needle retainer band under the needle bed in either direction with a screw-driver or a pencil, and pull it out of the inside of the needle bed.

(Fig. 174)

- (2) Pull the damaged needle forward to **D** position. Lift the needle free from the bed, and slide away from you until the needle is completely free from the machine. (Fig. 175.)

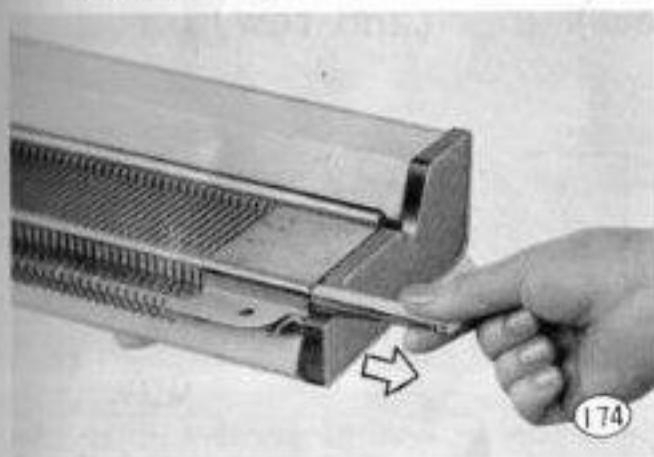

- (3) Replace a new needle by sliding the needle into the slot with the hook first. Slide forward until it rests in **D** position. Push back into place and replace the needle retainer.

2. How to rip out incorrect knitting

Remove the yarn from the yarn feeder. Pull the yarn tightly in a parallel direction to the machine. At the same time, apply a slight pulling pressure on the garment with your free hand. Now pull the yarn in a backward flipping motion so that the latches will open and the stitches of the previous row will slip

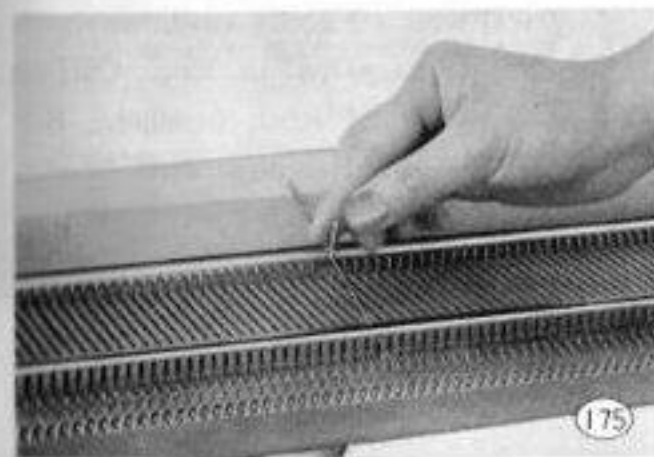

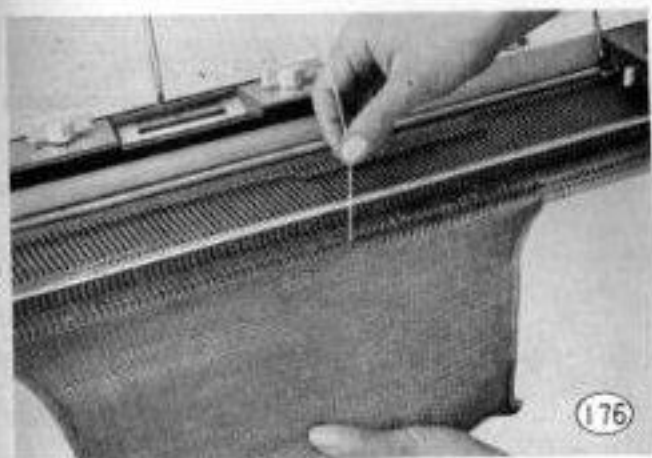

176

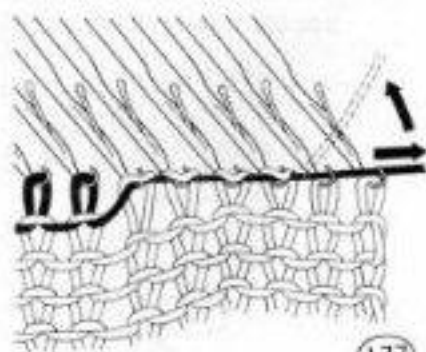

177

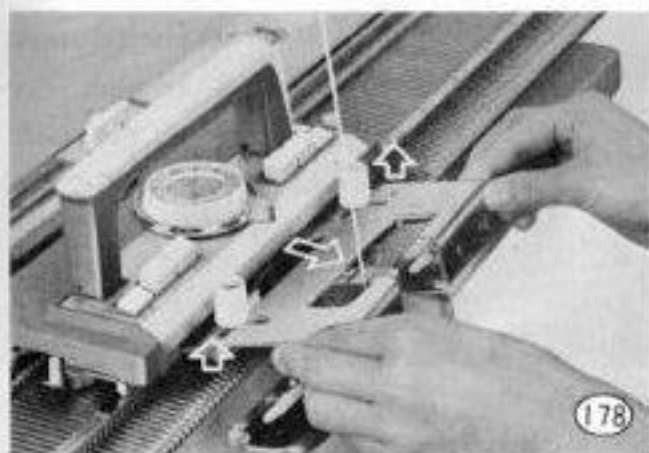

178

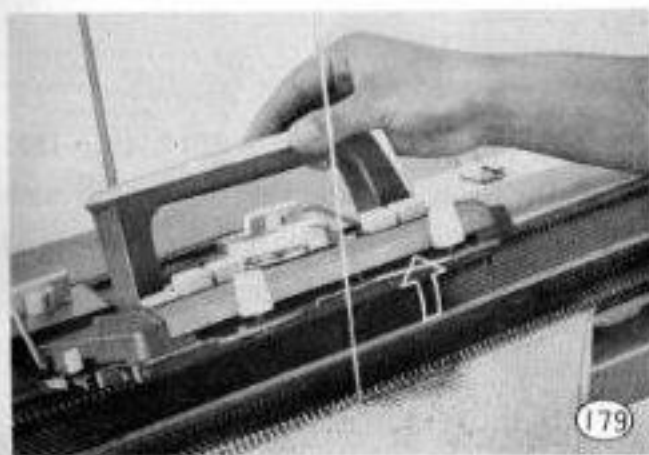

179

into the hooks. Repeat the procedure until the desired number of rows are removed. (Fig. 176, 177)

3. If the carriage jams while knitting

When the carriage jams while knitting, never try to move it by force, or you may damage the needle bed.

- (1) Bring the row counter lever forward into inactive position.
- (2) Loosen the arm nuts. Lift the back edge of the arm, as shown in Fig. 178, until the arm become free from the keys. Pull forward to remove from the carriage.

(Fig. 178)

- (3) Lift up the front edge of the carriage using the handle and bring it back to the starting position. (Fig. 179)

Check the followings that after cause the carriage to jam.

- ☆ If the yarn is entangled or otherwise caught.
- ☆ If the yarn is incorrectly threaded in auto-tension.
- ☆ If there is a knot in the yarn. Correct error, rip out row, rethread the carriage and resume knitting.

4. If stitches are dropped

1. Correcting a dropped stitch

- (1) Insert the one eye tool into the stitch just under the dropped stitch. Place the stitch together with the loose yarn onto the needle. (Fig. 180)

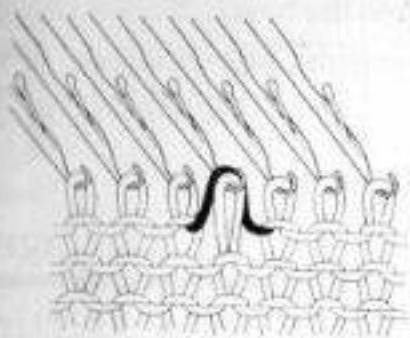

(180)

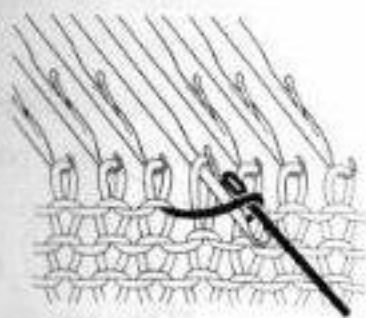

(181)

- (2) As you pull out the needle, place the stitch behind the latch leaving the loose yarn in the hook.

(Fig. 181)

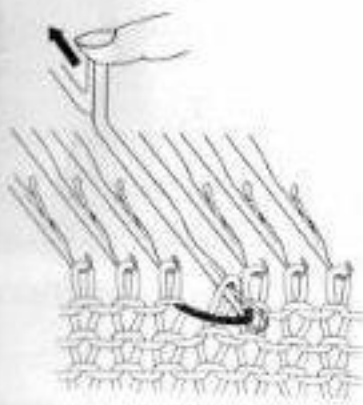

(182)

- (3) Push the needle back (Fig. 182) so that the stitch behind latch slides over the closed latch, and reforms the dropped stitch.

(Fig. 183)

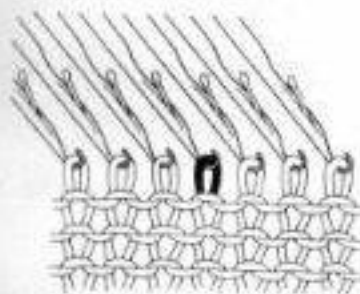

(183)

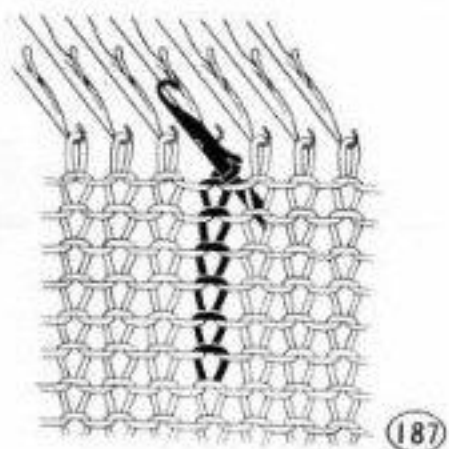
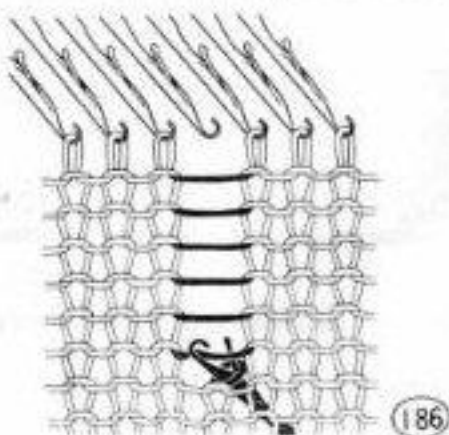
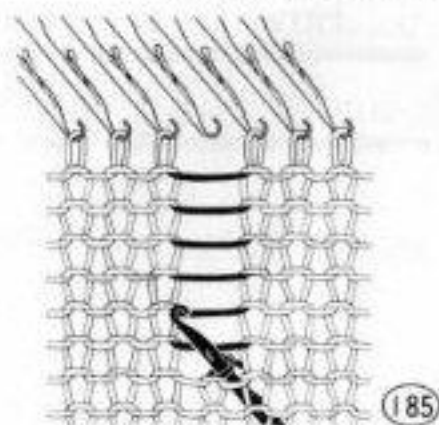
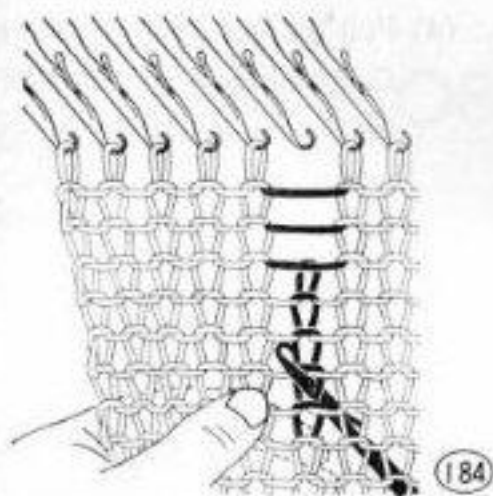

2. Correcting several rows of dropped stitches

- (1) Insert the tappet into the side of the garment away from you, and catch a loop or stitch a few rows below the dropped stitch. Undo the stitches down to the tappet. (Fig. 184)

NOTE: With free hand pull down on the garment directly under the dropped stitch. This separates the cross threads and makes picking up easier.

- (2) Push the tappet toward you so that the stitch comes behind the latch of the tappet and catches the cross thread just above into the hook. (Fig. 185)

- (3) Draw back the tappet, and the cross thread is trapped in the closed latch. (Fig. 186)

The stitch behind the latch slide down over the closed latch to form a stitch.

Repeat this procedure to the top.

(Fig. 187)

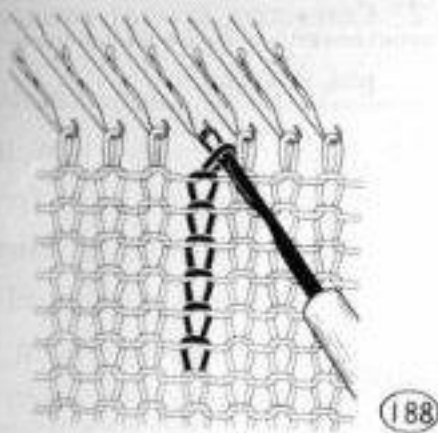

- (4) Pull the last stitch rather tight. Carefully remove the stitch from the tappet and place it on the needle with your tappet from the front. (Fig. 188)

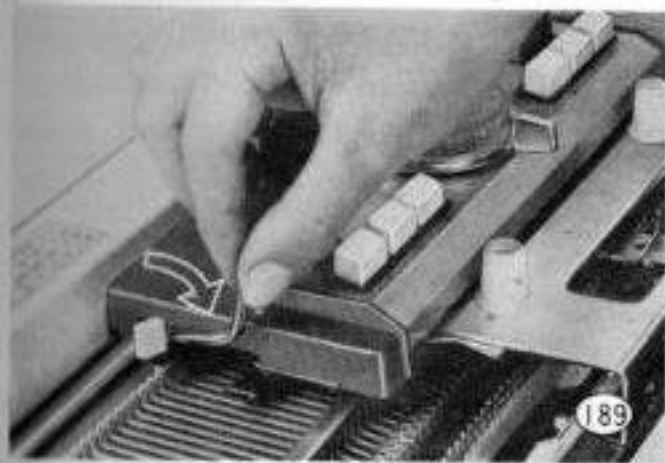

5. How to put the row counter out of operation

If you do not want to have the row counter in operation, bring the counter lever forward into inactive position. (Fig. 189)

6. If loose stitches are forming at the edges of your garment

If the yarn makes loops at the edges of the fabric, you should check to see if the yarn is thread correctly in the auto-tension.

7. Keeping the case clean

If the case is soiled, wipe clean with a cloth dipped in synthetic detergent and water. Dry with a soft cloth.

CARE OF YOUR MACHINE

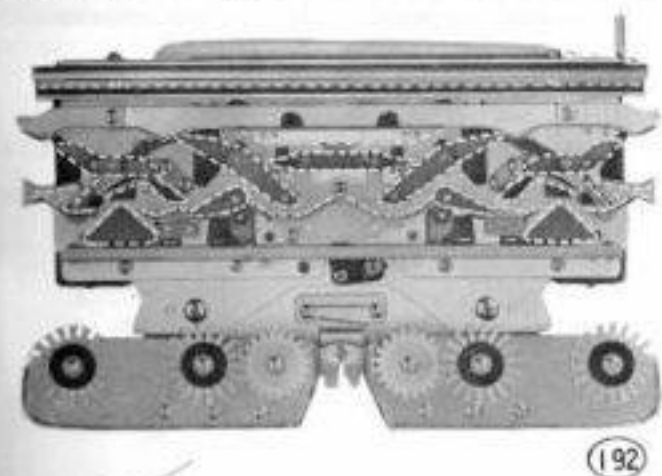
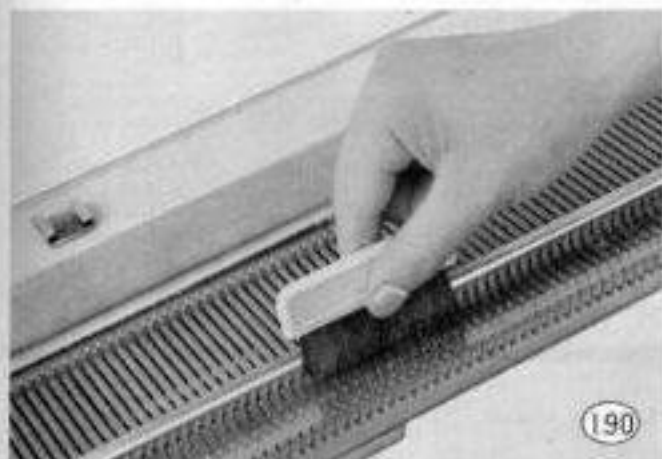

Even the best machine will not continue to work properly without periodically being oiled and cleaned.

With regular use your machine should be oiled once a week.

1. After using the machine

- (1) Brush off all wool dust.

(Fig. 190)

- (2) With an oiled cloth, wipe all the metal parts.

2. Oiling

Smear the machine with an oiled cloth, always using the oil supplied as one of the accessories.

Do not apply too much oil, or it may be harmful to the machine.

Keep the machine well oiled, especially the following parts:

- (1) Both the front and back rails on the needle bed. (Fig. 191)
- (2) The needle butts
- (3) The cams of the carriage

Following the dotted line in the figure, oil the cams at the underside of the carriage which the needles slide through.

(Fig. 192)

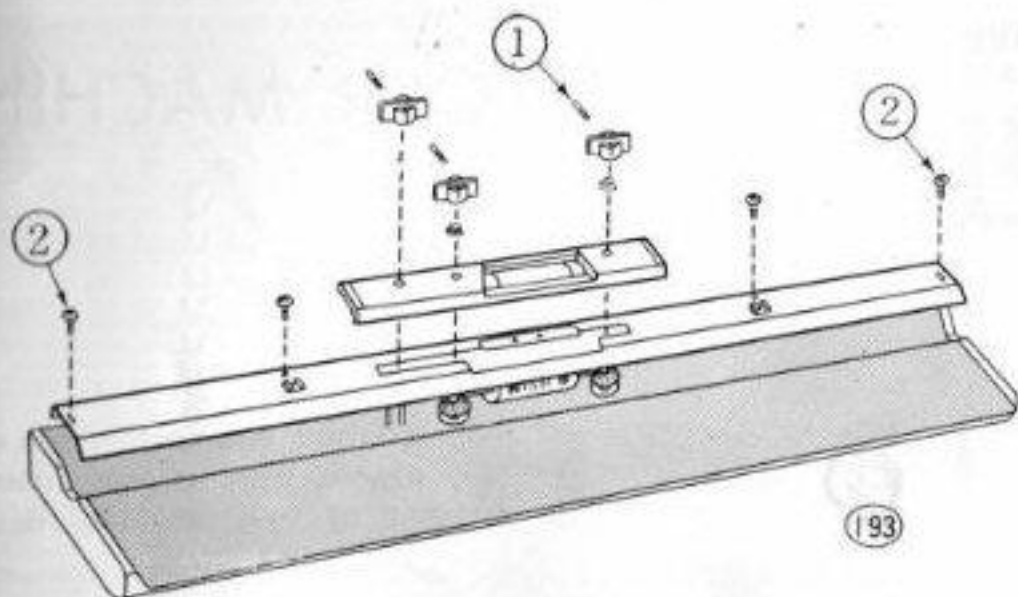

3. Disassembling the main machine

- (1) Unfasten the three screws which fix the three dials onto the pattern panel. (Those three dials and the pattern panel will be separated from the machine case).
- (2) Unfasten the four screws, two of which are near the center of the machine case. The others are at either end. (The upper case will be removed from the machine).
- (3) To reassemble the machine, replace each of the parts in the reverse order.

















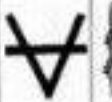



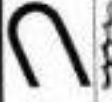

(Fig. 193)

4. Preserving the machine

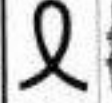
- (1) Keep the machine well oiled and in a dry place all time.
- (2) If you have not used the machine for some time, you should carefully wipe off the excess oil before using. It is also advisable for you to knit a piece of fabric with waste yarn before starting the actual garment.

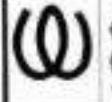
KNITTING SYMBOLS

The following set of symbols has been adopted to help you understand your patterns at a glance and to save countless lines of description for each stitch.

		KNIT STITCH Face loop of stockinet	X		CROSSING, RIGHT OVER LEFT Cross the stitches with the right stitch over the left
-		PURL STITCH Back loop of stockinet	X		CROSSING, LEFT OVER RIGHT Cross the stitches with the left stitch over the right
>		TWO STITCHES TOGETHER Transfer right stitch to adjacent left needle	V		SLIP STITCH A loop marked is pulled up with yarn across behind it
<		TWO STITCHES TOGETHER Transfer left stitch to adjacent right needle	∇		FLOAT STITCH A loop marked is pulled up with yarn across in the front
↑		THREE STITCHES TOGETHER Center stitch on top of the left and right stitches	∩		TUCK STITCH A few loops on marked rows pulled up onto one needle
↗		THREE STITCHES TOGETHER Right stitch on top	∩		TUCK STITCH IN SIDE WAY TO THE RIGHT A few loops on marked rows pulled up in sideway onto a right needle
↖		THREE STITCHES TOGETHER Left stitch on top	∩		TUCK STITCH IN SIDE WAY TO THE LEFT A few loops on marked rows pulled up in sideway onto a left needle
/		LEAN STITCH TO THE RIGHT Transfer the stitch to the right	∩		TWISTED TUCK STITCH A stitch twisted and pulled up onto a needle above
\		LEAN STITCH TO THE LEFT Transfer the stitch to the left	∩		TWISTED STITCH A stitch is twisted
┆		INCREASED STITCH TO THE RIGHT Increase one stitch to the right	∩		WINDING STITCH A loop formed by winding yarn around a needle
┆		INCREASED STITCH TO THE LEFT Increase one stitch to the left	○		EMPTY STITCH Hole made by transfer ring the stitch to the next needle
3		THREE STITCHES INCREASED Increased three stitches out of one stitch			

