



OPERATION MANUAL

SK 840

# CONTENTS

	page
<b>TO USE THE KNITTER</b> .....	
SETTING UP THE KNITTER .....	1
ACCESSORIES .....	3
<b>NAMES AND FUNCTIONS OF EACH PART</b> .....	4
Needle Positions .....	4
Cam Lever .....	5
Stitch Dial .....	5
Russel Levers .....	6
Release Lever .....	6
Weaving Knobs .....	6
Yarn Cutter .....	6
Row Counter .....	6
<b>YARN PREPARATION</b> .....	7
Threading the Yarns .....	8
Adjusting Tension Dial .....	8
<b>CAST-ON AND STOCKINET KNITTING</b> .....	9
Knitting Stripe Pattern .....	12
Moving the Carriage without knitting .....	14
Remove the knitting .....	14
<b>TO KNIT PATTERNS USING THE PATTERN CONTROLLER, EC1</b> .....	15
(See the contents on page 15 for details.)	
<b>TO USE THE LACE CARRIAGE</b> .....	42
(See the contents on page 42 for details.)	
<b>TO USE THE RIBBER, SRP60N</b> .....	57
(See the contents on page 57 for details.)	
<b>HELPFUL HINTS</b> .....	102
(See the contents on page 102 for details.)	
<b>MAINTAINING THE MACHINE</b> .....	117
<b>REPACKING THE KNITTER</b> .....	118

## SETTING UP THE KNITTER

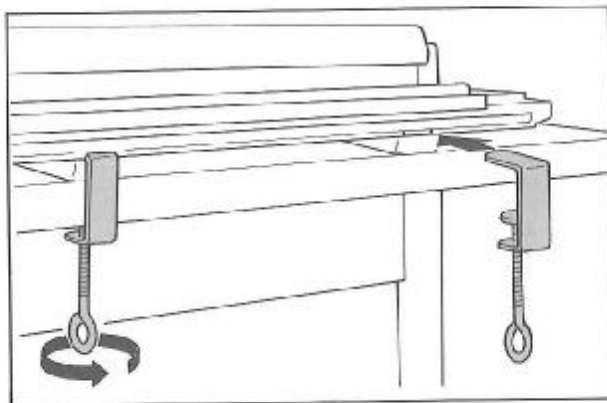
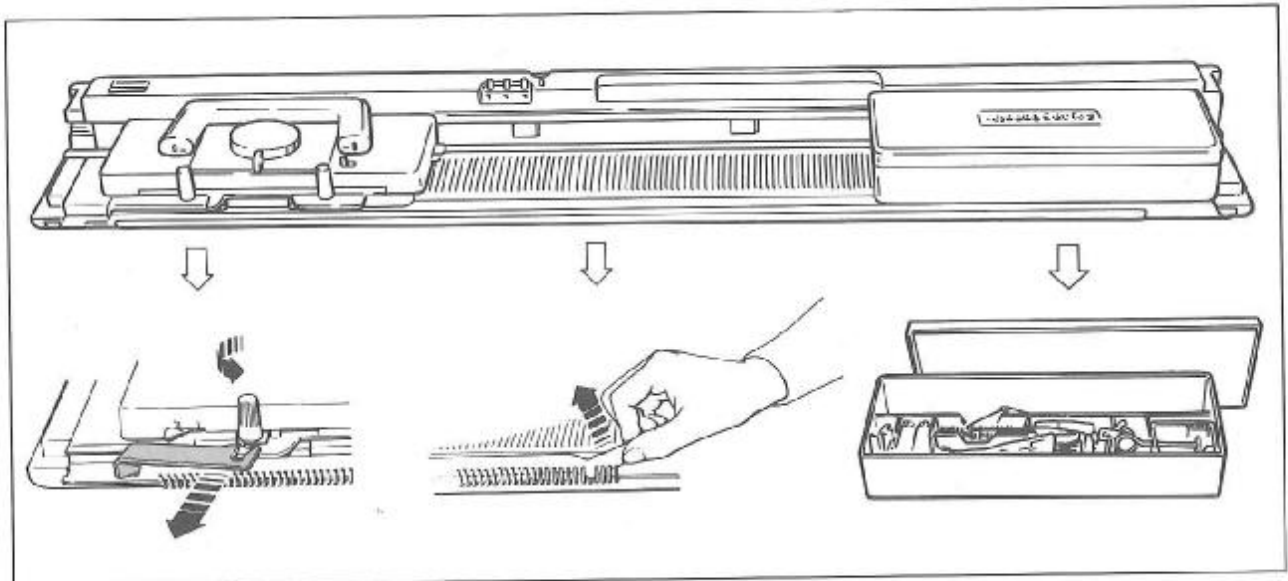
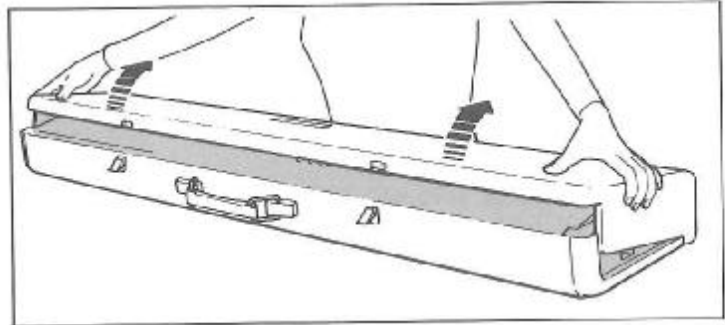
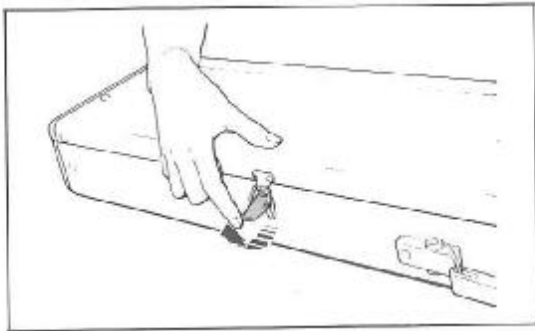

Place the machine on the table with its Carrying Handle away from you, and open the machine as illustrated above.

Open the Accessory Box, and take out two Clamps, and secure the Knitter to the table.

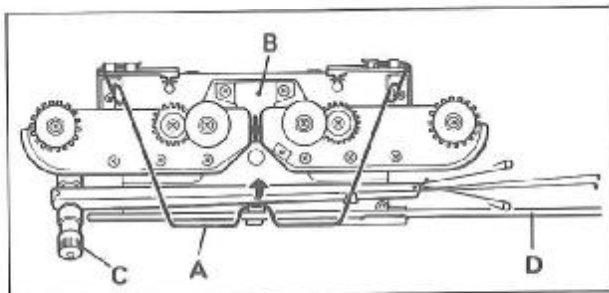

Release the Wire Spring "A", and take out the Arm "B", Auto-Tension "C" and Yarn Rod "D".

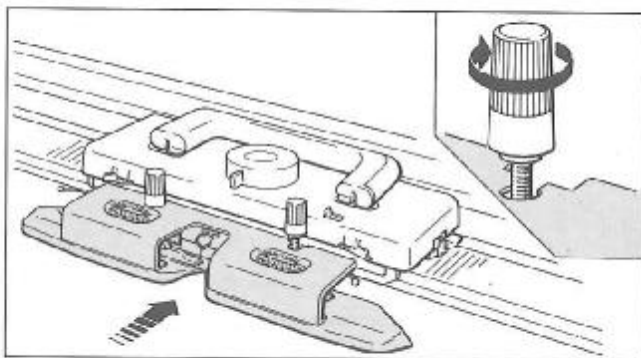

Loosen the two Arm Nuts, and insert the Arm under them.

Push the Arm as far as it goes and tighten them in the arrowed direction.

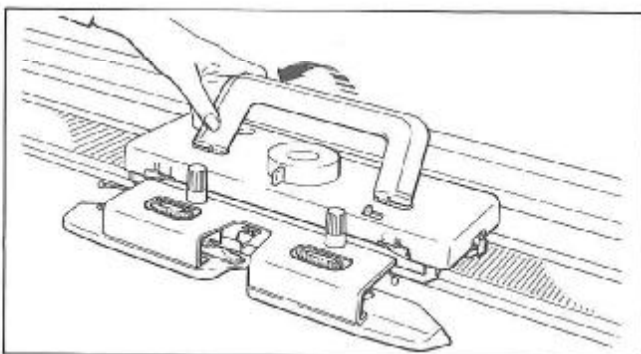

Raise the Carriage Handle.

Set the Auto-Tension and Yarn Rod on the machine as follows:—

- ① Turn the two Tension Springs "E" until they snap into position.
- ② Insert the short bent end of the Yarn Rod "F" into the either side handle bracket socket "G".
- ③ Place the Auto-Tension onto the Yarn Rod.
- ④ Align the notch of the Yarn Rod with the groove of the Tension Guide "H" and insert the Guide from above.

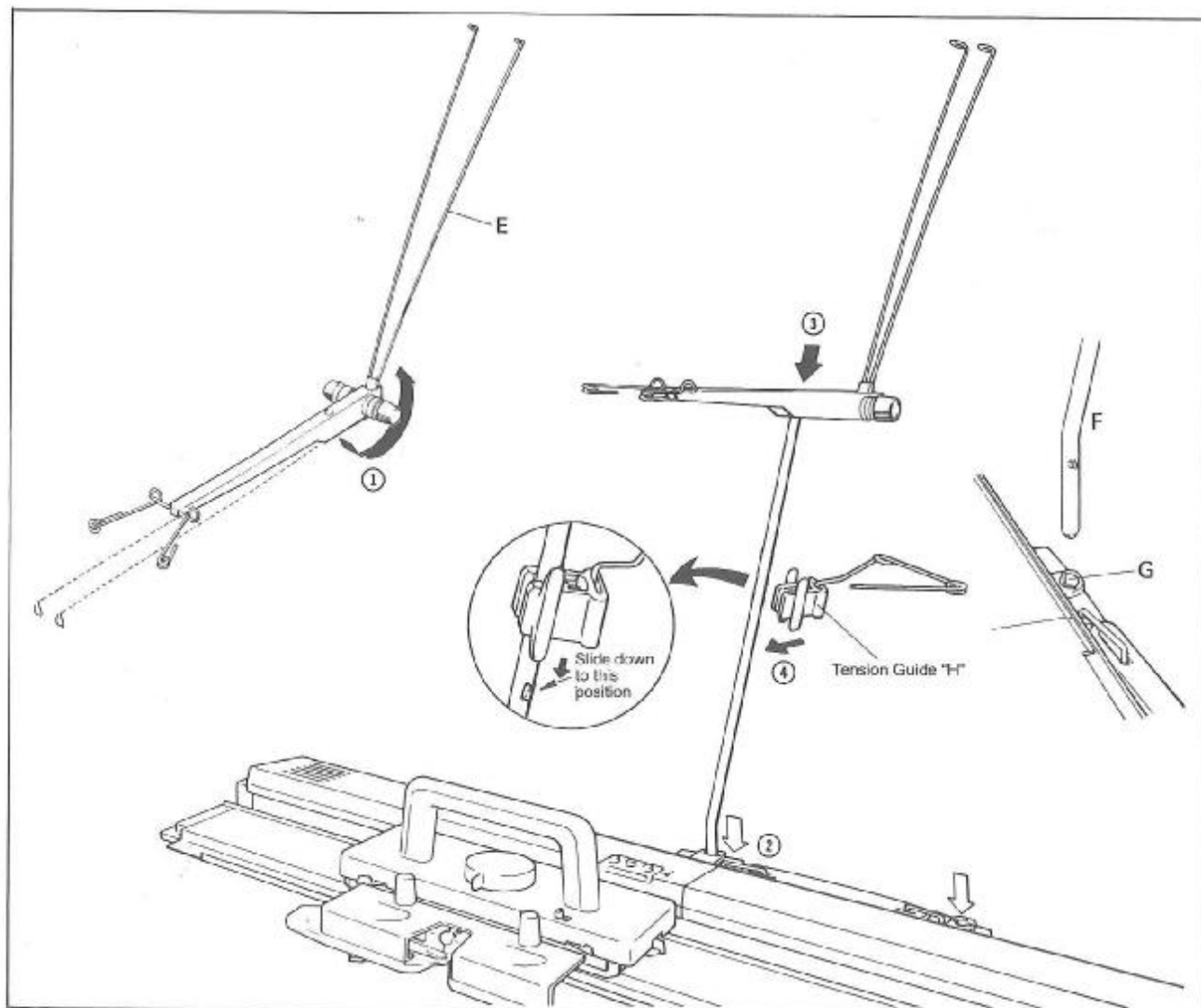



# ACCESSORIES

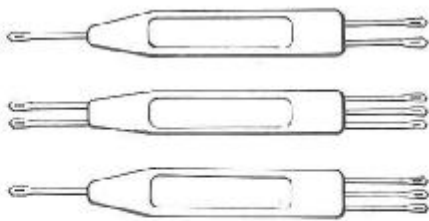

Transfer Tool (3)

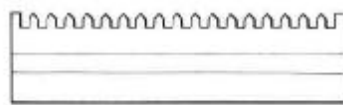

Needle Pusher

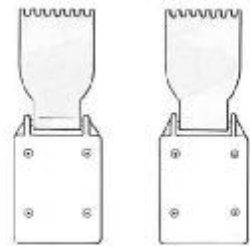

Claw Weight (2)

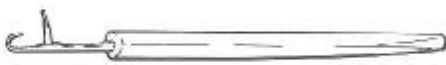

Tappet Tool



Clamp (2)

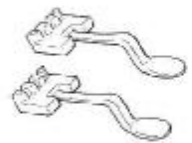

Yarn Separator (4)



Design Pencil (2)

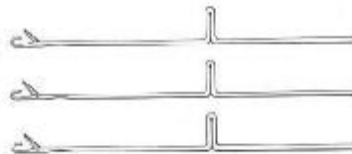

Spare Needle (3)

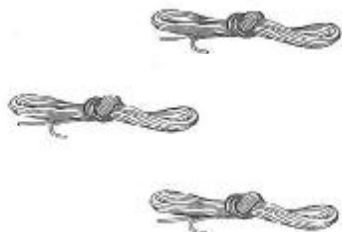
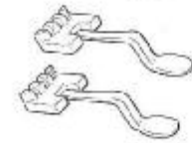

Ravel Cord (3)

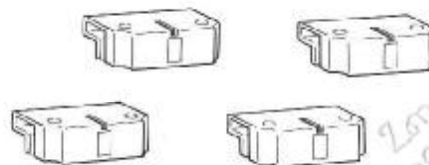

Point Cam (4)\*



Needle-1 Cam (2)



Crochet Hook



Tapestry Needle



Cleaning Brush



Sensor Cleaner

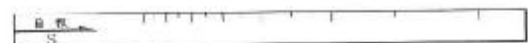

Gauge Scale



Oil



Tension Guide

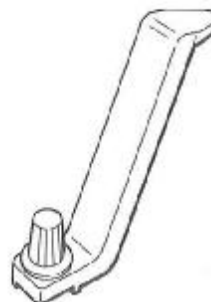

Knit Contour (Radar) Feeding Cam



Carriage Fastener

\*Two on the Needle Bed and two in the Accessory Box.

# NAMES AND FUNCTIONS OF EACH PART

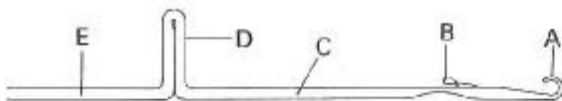
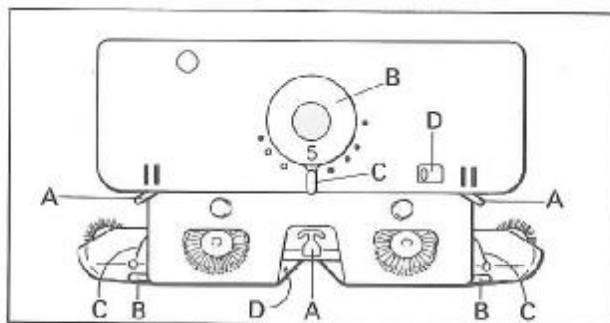
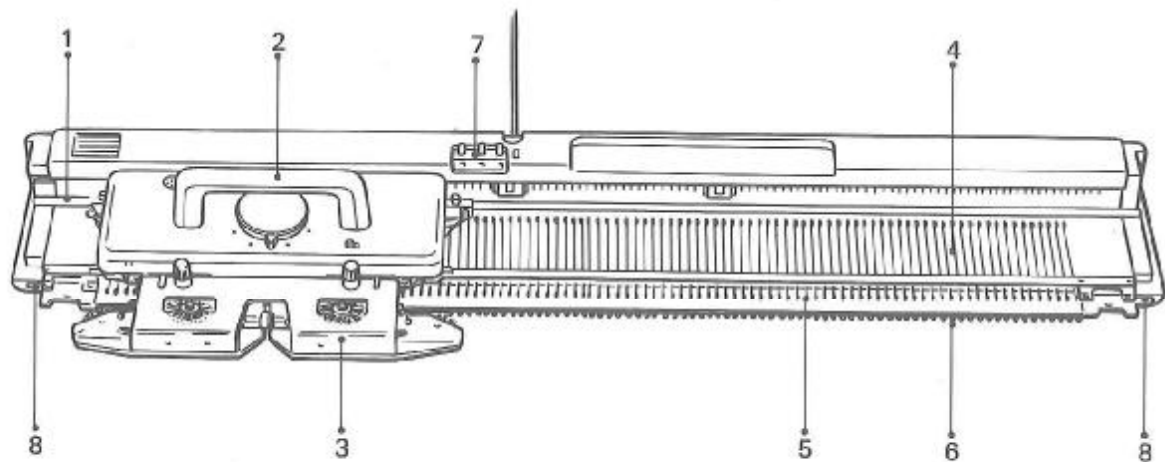

1. Rail
2. Carriage
  - A — Russel Levers
  - B — Stitch Dial
  - C — Cam Lever
  - D — Release Lever
3. Arm
  - A — Yarn Feeder
  - B — Weaving Knobs
  - C — Weaving Yarn Holders
  - D — Yarn Cutter
4. Needle Bed
5. Latch Needle
  - A — hook
  - B — latch
  - C — stem
  - D — butt
  - E — shank
6. Sinker Post
7. Row Counter
8. Yarn Clips

## Needle Positions

On both ends of Needle Bed are bracketed letters A, B, C and D. Align the needle butts inside the brackets.

- A — Needles do not knit.
- B — Needles knit Stockinet and stitch patterns.
- C — Needles knit Stockinet only.
- D — Needles do not knit with Russel Levers at I.  
Needles are knitted back to B position with Russel Levers at II.

The numbers 0 ~ 10 on the left and right side of centre(D) indicate number of needles.

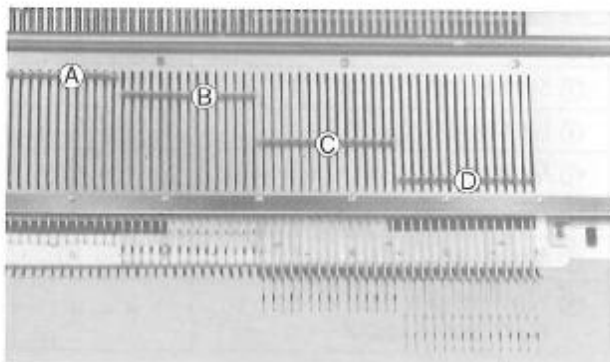

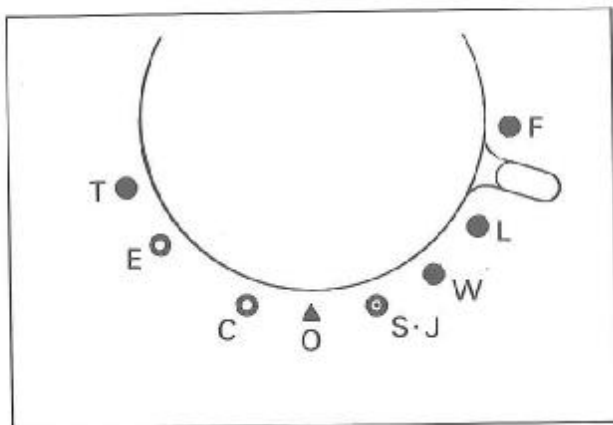

### Cam Lever

The Cam Lever has 8 positions. By setting the Cam Lever different types of stitch pattern can be knitted when using a Pattern Card.

Each position is marked as shown below.

- F..... FAIR ISLE (KNIT-IN)
- L..... PUNCH LACE
- W..... WEAVING
- S.J..... S for SLIP  
J for DOUBLE JACQUARD when the Yam Changer is in use.
- O..... STOCKINET (No Pattern Card is needed.)
- C..... CIRCULAR KNITTING (only with the Ribber)
- E..... ENGLISH RIB (only with the Ribber)
- T..... TUCK

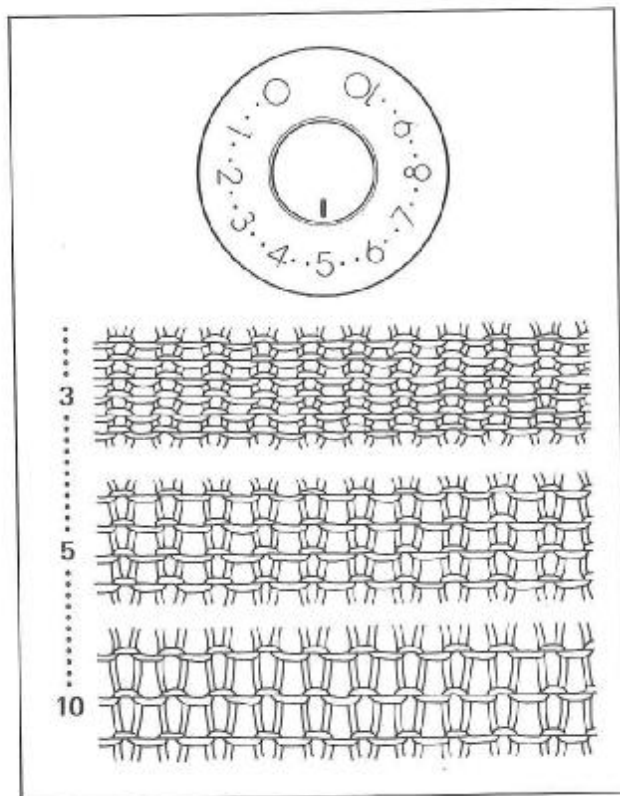

### Stitch Dial

The Stitch Dial is on the same section as the Cam Lever. The dial is numbered 0 ~ 10. Each dot represents a different tension, giving 31 settings in all.

The Stitch Dial is used to adjust the tension of knitted fabric as it regulates the size of stitch for a given type of yarn.

The smaller the number, the tighter the tension of the knitted fabric because the stitch size becomes smaller. The larger the number the looser the tension of the fabric because the stitch size becomes larger.

The photograph below shows various types of yarn in their actual size, and in the table below, recommended Stitch Dial settings are given.

The selected number of the Stitch Dial must be set at **I** mark.

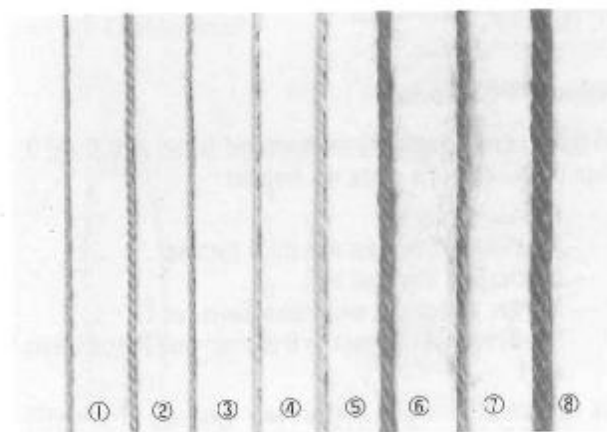

Type of yarn	Stitch Dial
① Cotton thread	2 ~ 3
② Thin yarn (2-ply)	2 ~ 3
③ Summer yarn	3 ~ 4
④ Light yarn (3-ply)	3 ~ 5
⑤ Medium yarn (4-ply)	4 ~ 6
⑥ Thick yarn	6 ~ 9
⑦ Mohair (every second needle)	8 ~ 10
⑧ Very thick yarn (every second needle)	6 ~ 9

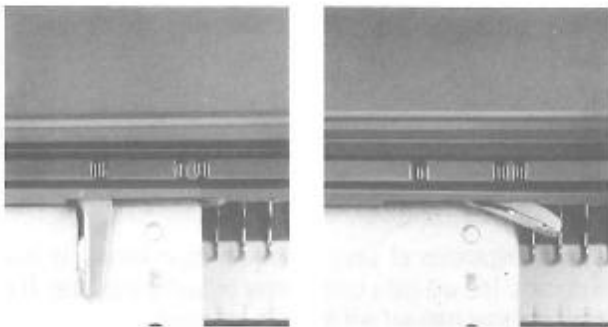

### Russel Levers

These control needles in D position.

- I..... Do not knit the needles in D position.
- II..... Knit the needles in D position in Stockinet.

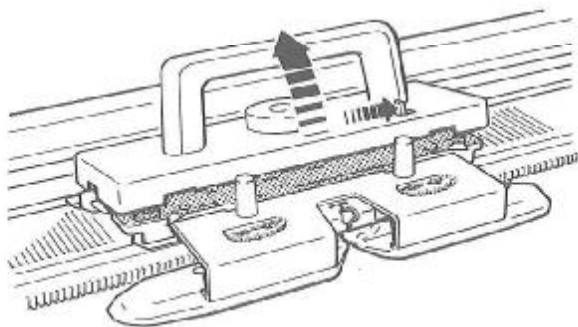

### Release Lever

By using this lever, you can release Carriage from a jam as well as move it across the bed without knitting.

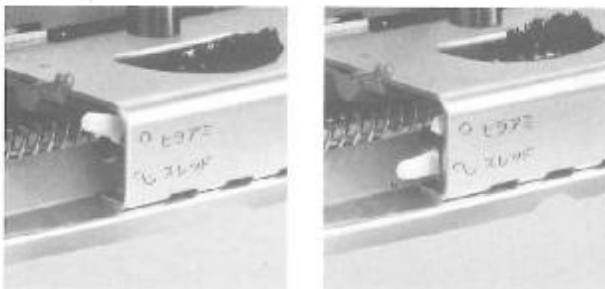

### Weaving Knobs

Move this knob to position the Weaving Brush.

- ..... Set to this position except for Weaving.
- ∞..... Set to this position for cast-on and Weaving.

To set the Weaving Knob to ∞, push it slightly forwards and it will drop into position.

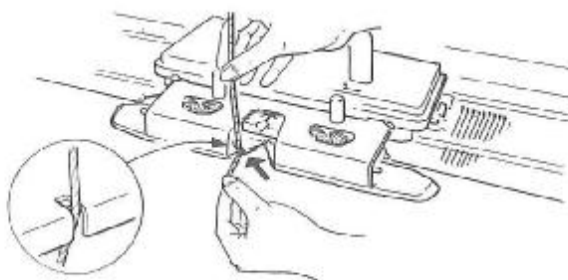

### Yarn Cutter

Use this to cut the knitting yarn.

Hold the yarn with both of hands and press the yarn against the cutter.

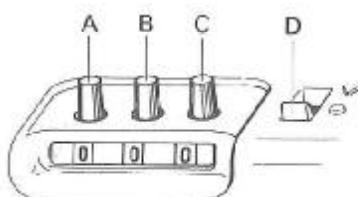

### Row Counter

To reset number, turn the knurled knobs "A", "B" and "C" in either direction.

- "D" — Row Counter Lever
- ▼ — Operating position
- — Locked position

## YARN PREPARATION

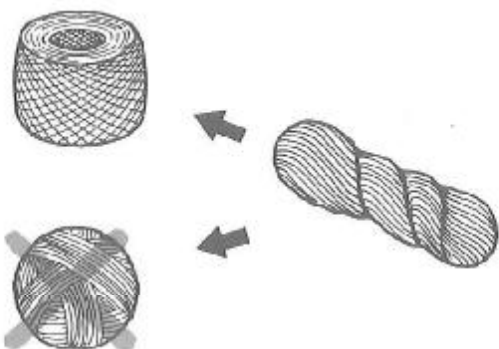

Your machine is designed to knit a wide variety of yarns, but it is recommended to use medium 4 ply yarn for practice.

Correct preparation of yarns before you start knitting is very important. This will make knitting more enjoyable and easier. The quality of your garment will be much improved.

It is impossible to knit from a hank of yarn or hand wound ball.

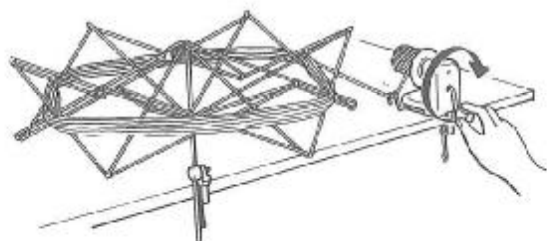
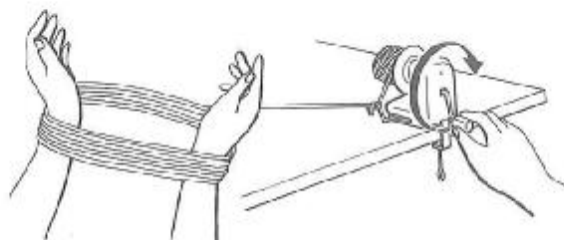

Open the hank of yarn and replace it on your arms (or on an optional Skein Holder) to wind it into a ball, suitable for machine knitting.

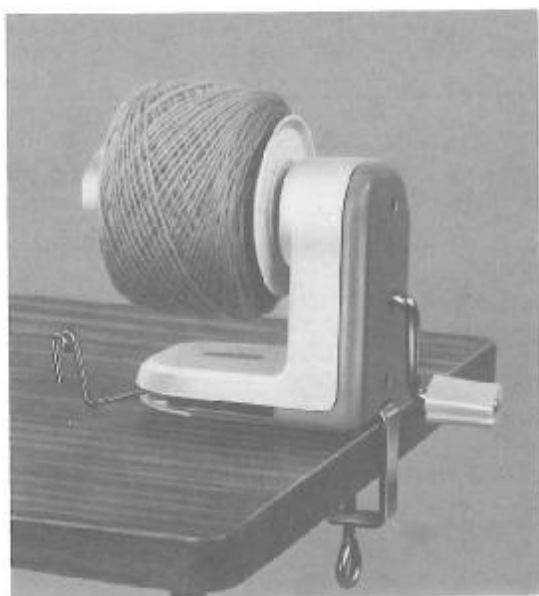

An optional Yarn Ball Winder is recommended for winding yarn.

*When yarn is rewound, ensure that the yarn end comes out freely without lifting the ball.*

*If the ball has been wound too tight for the yarn to come out freely, rewind more loosely.*

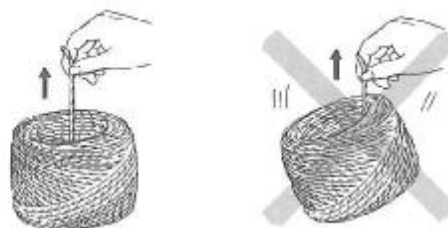



## Threading the Yarns

For practice, prepare two balls or cones of different colour 4-ply yarns.  
Thread the right side of Auto Tension as illustrated below.

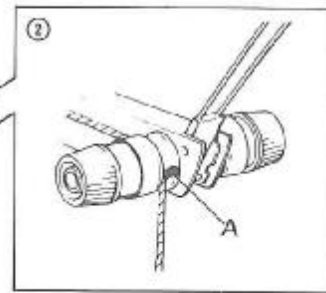
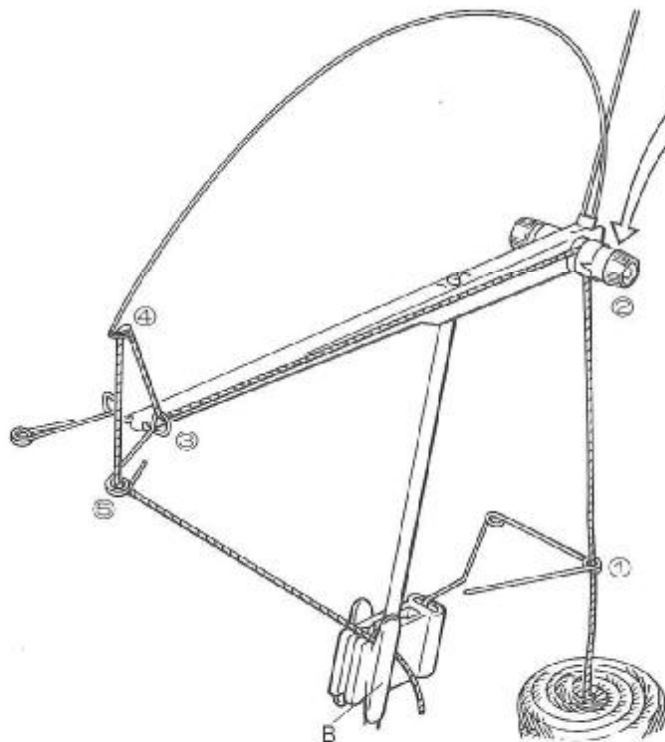

- ① through right Tension Guide eyelet
- ② between two Tension Discs and under the red Guide Pin "A"
- ③ through right Yarn Guide eyelet
- ④ through right Tension Spring eyelet
- ⑤ through right Yarn Guide eyelet

Put yarn end under Yarn Clip "B".

Thread the second yarn into the left side of Auto Tension in the same manner as you threaded the first yarn into the right side of the Auto Tension.  
Put yarn end under the Yarn Clip.

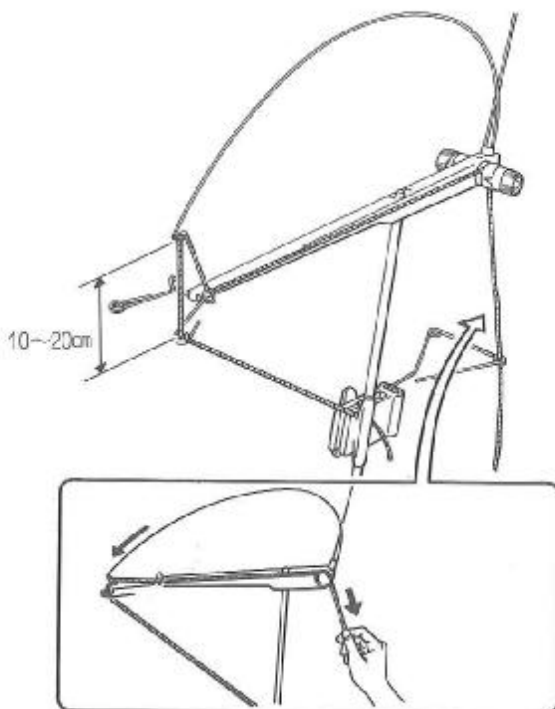

## Adjusting Tension Dial

Adjust the Tension Dial according to type of yarn by turning the Tension Dial "C" until required number corresponds to the < shape "D" using the following as a guide:—

- \* Yarn comes out freely from the yarn ball.
- \* Distance between the Tension Spring and the yarn guide..... 10 ~ 20cm. must be maintained.

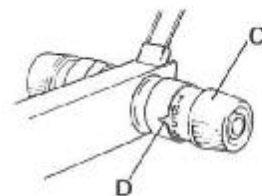

*The higher the number, the tighter the tension. The lower the number, the looser the tension.*

It is advisable to free a length of the yarn from the ball before casting on.

## CAST-ON AND STOCKINET KNITTING

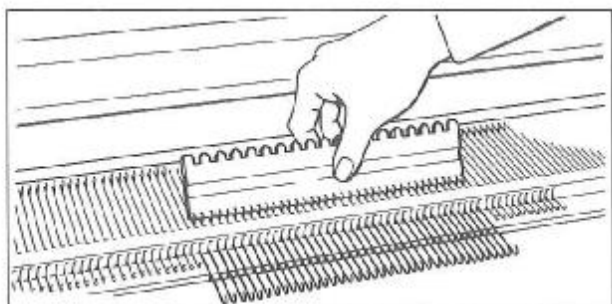

Using the Needle Pusher, align the needles in D position as shown.

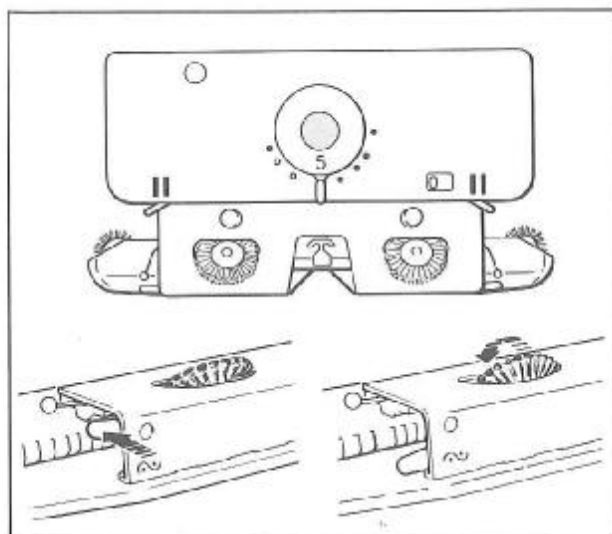

Set the Carriage as follows:

Cam Lever..... **O** (STOCKINET)  
 Stitch Dial..... **5**  
 Russel Levers..... **II** (both)  
 Weaving Knobs\*..... **~** (both)

\*To set the Weaving Knob to ~ mark, push it slightly forwards, then it drops down.

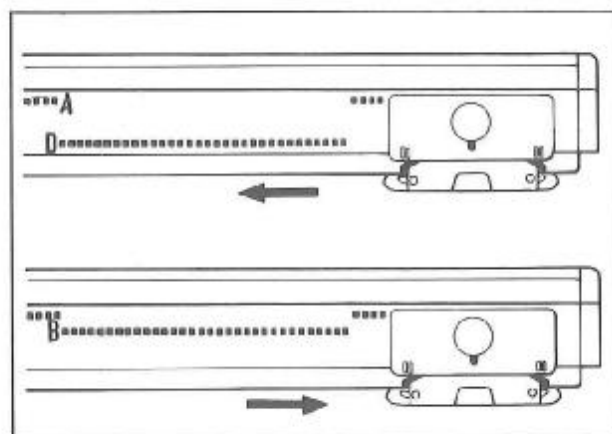

Slowly move the Carriage across the needles, and the needles will align in B position.

Leave the Carriage at the right side.

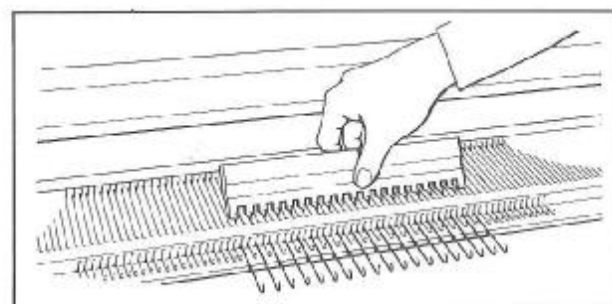

Using the Needle Pusher, push every 2nd needle from B to D position.

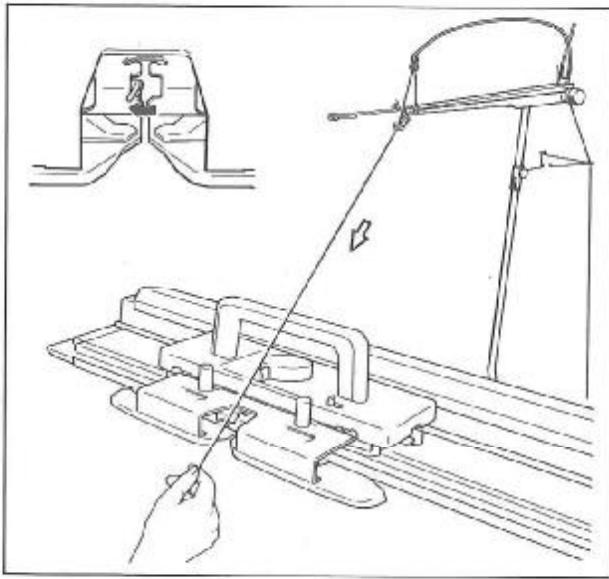

Open the Yarn Feeder Gate, and take the yarn from the Yarn Clip, and pull it down to the Yarn Feeder.

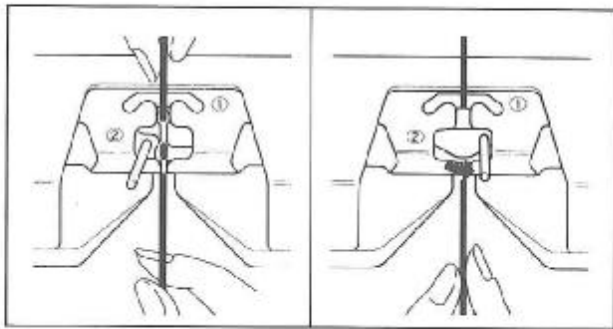

Guide the yarn into Yarn Feeder ①, and holding the yarn end with your hand, close the Gate.

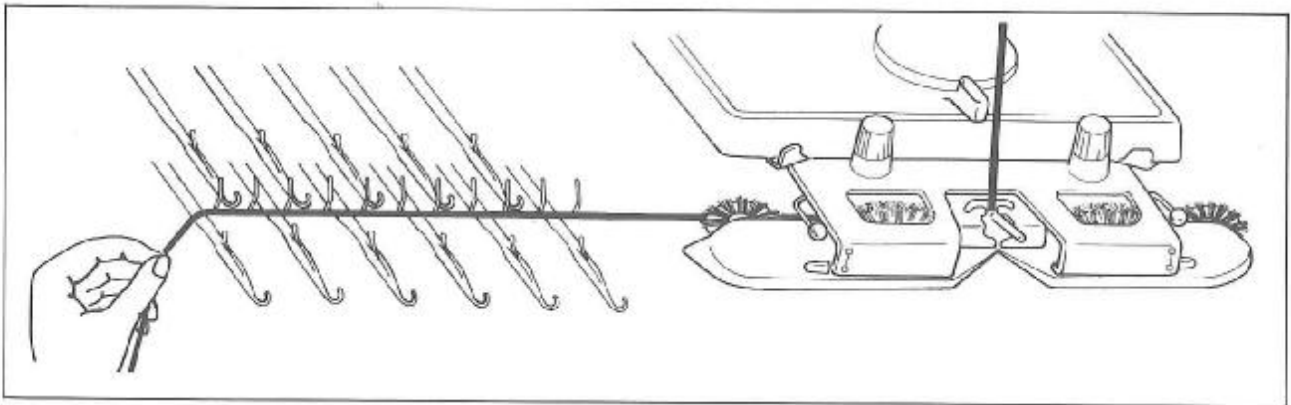

Pull the yarn down through the Yarn Feeder, and guide it under the Arm and over the needles in D position.

Check the tension on the yarn, and adjust it if necessary by pulling the yarn back towards the yarn ball at the back of the Yarn Rod.

*If the yarn is threaded through the Auto-Tension incorrectly, it will not have tension on it, and the cast-on will be a failure.*

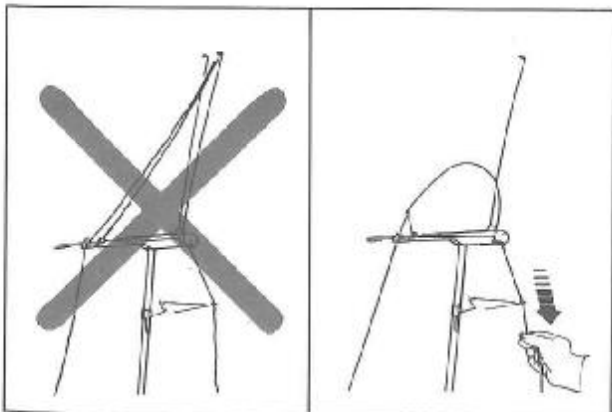

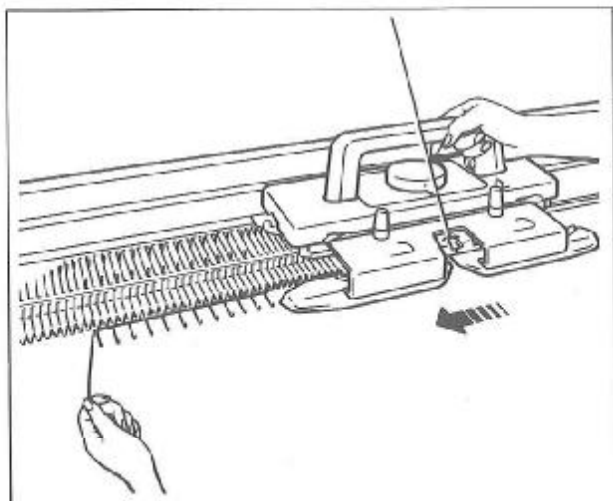

Hold the yarn loosely at the left about 30cm. from the yarn end.  
Slowly move the Carriage from right to left until it has passed all the needles, knitting 1 row.

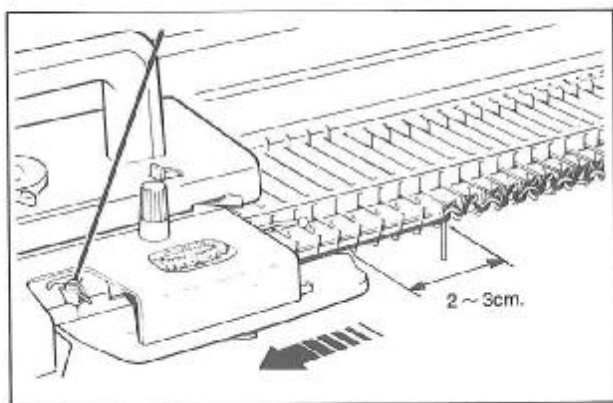

Ensure that the Arm has passed the last knitting needle by approximately 2 ~ 3cm.

Knit 4 ~ 5 rows more in the same manner.

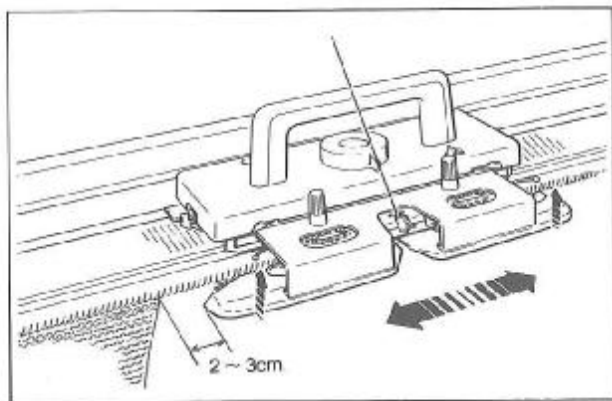

Set the Weaving Knobs back to  $\bigcirc$ .  
Move the Carriage back and forth to knit Stockinet.

*Move the Carriage at an even speed.*  
*On each row, ensure that the Arm has passed the last knitting needle by approximately 2 ~ 3cm.*

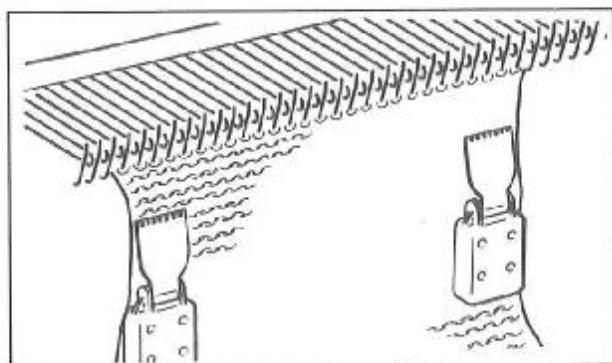

Take out the Claw Weights from the Accessory Box, and hang them on the knitting as shown, and continue to knit moving the Weights up every 30 ~ 40 rows.

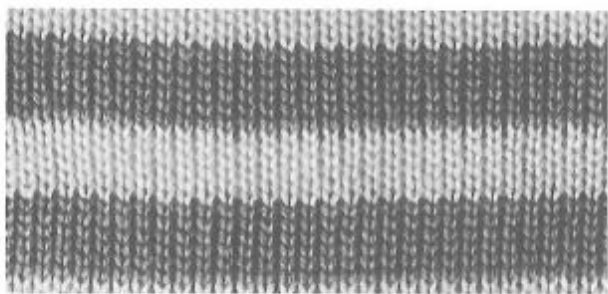

### Knitting Stripe Pattern

Continue to knit stripes by changing the yarn in Feeder ① every few rows.

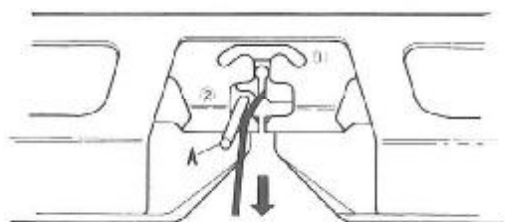

Open the Yarn Feeder by moving Yarn Feeder Gate "A" to the left.

Remove main yarn from the Yarn Feeder.

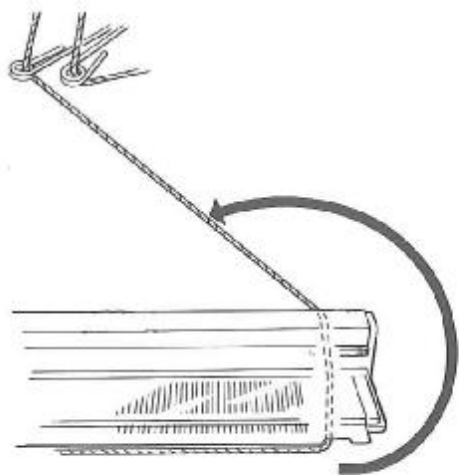

Guide the yarn under the Needle Bed from the right or left side to the rear of the machine.

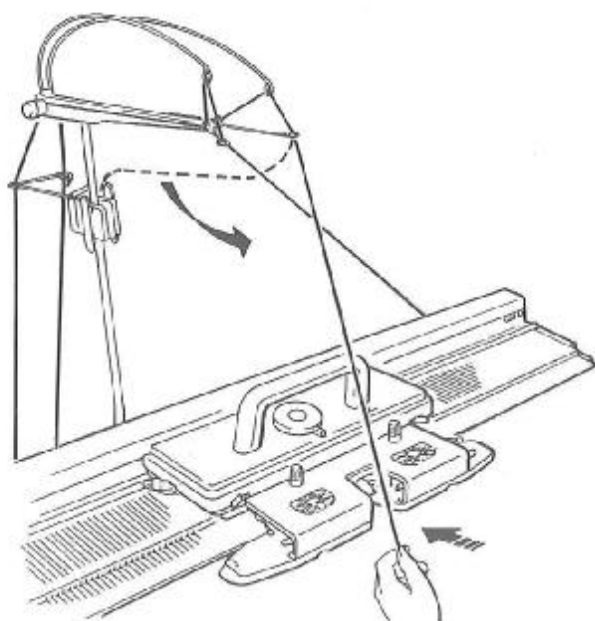

Remove the second colour yarn from the Yarn Clip and pull it down towards the Yarn Feeder.

Open Yarn Feeder by moving the Yarn Feeder Gate to the left and place the yarn in the Yarn Feeder.

Close the Yarn Feeder by moving the Yarn Feeder Gate to the right.

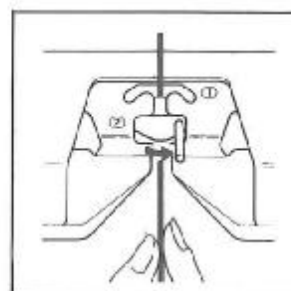
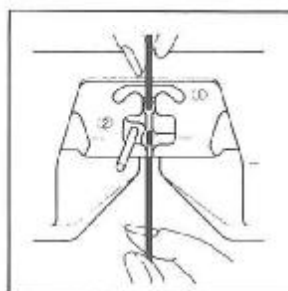



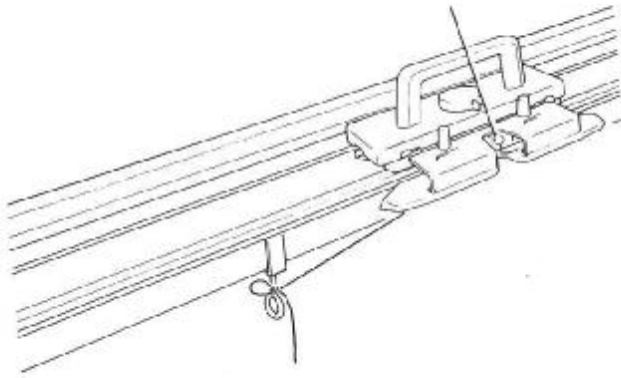

Fasten the yarn end to either Clamp.

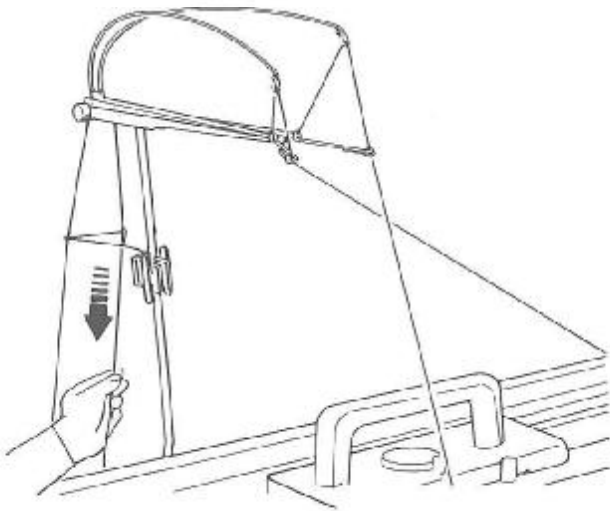

Eliminate slack yarn by pulling the yarn down at the back of Yarn Rod until the Tension Spring is almost horizontal.

Knit an even number of rows.

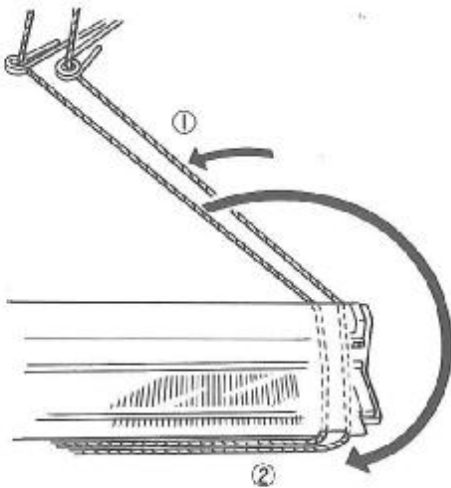

Remove the second colour from Yarn Feeder ①.

Place the yarn at the rear of the machine.

Remove the main yarn from the rear of the machine and place it into the Yarn Feeder ②.

*To avoid crossing yarns, first place the yarn to be rested and then remove the yarn to be knitted.*

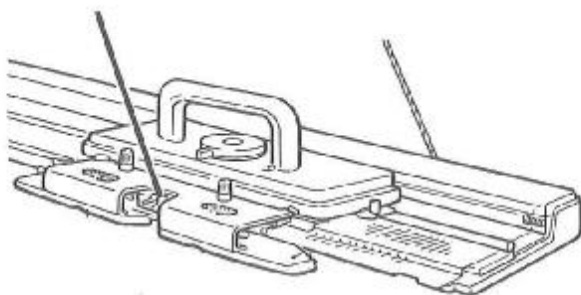

Eliminate slack yarn.

Knit an even number of rows, using yarns alternately.

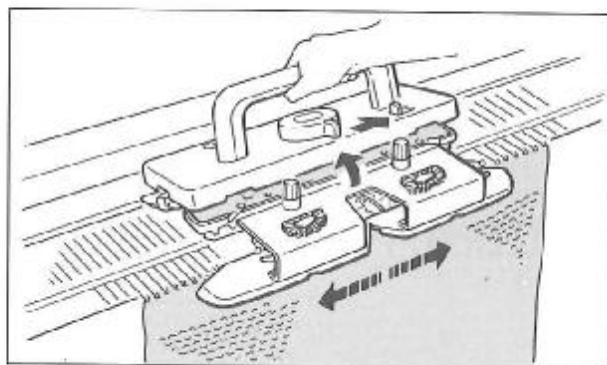

### Moving the Carriage without knitting

Stop Pattern Card, Knit Contour (optional) if they are in use.

Push the Release Lever to raise the top of the Carriage and move the Carriage across the knitting.

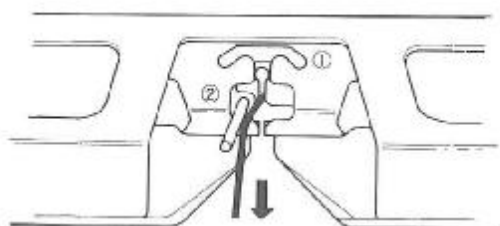

### Remove the knitting

— without casting off —

Open the Yarn Feeder and remove yarn.

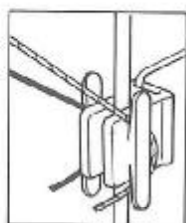

Cut the main yarn using Yarn Cutter and place its end into the Yarn Clip.

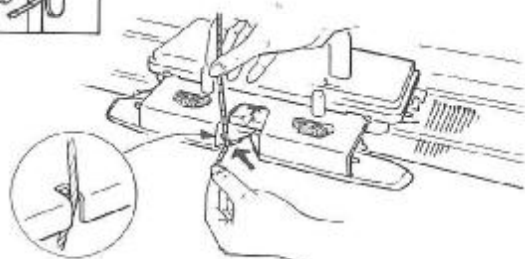

Cut the second yarn and place its end into another Yarn Clip.

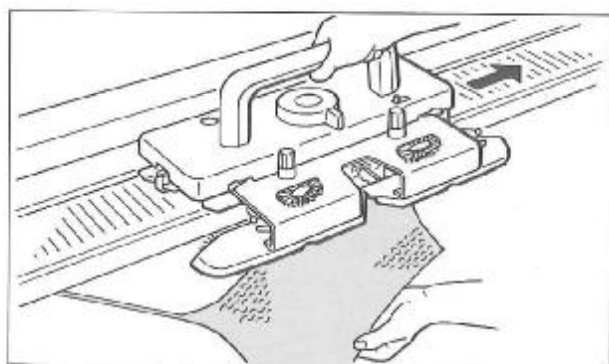

Remove weights from the knitting.

Set Cam Lever to "O" and move Carriage across the knitting.

The knitting comes off the needles.

# TO KNIT PATTERNS USING THE PATTERN CONTROLLER, EC 1

## CONTENTS

	page
PATTERN CONTROLLER, EC1 .....	16
CONNECTING THE PATTERN CONTROLLER TO THE MACHINE .....	17
PATTERN CARD .....	18
POINT CAM AND NEEDLE-1 CAM .....	19
PATTERN PANEL .....	20
PATTERN WIDTH INDICATOR .....	23
SETTING THE PATTERN CARD .....	25
PRECAUTION IN PATTERN KNITTING .....	26
FAIR ISLE (KNIT-IN) .....	27
TUCK STITCH .....	30
Tuck Lace .....	31
Tuck Stitch in Colours .....	31
SLIP STITCH .....	32
Slip Stitch in Colours .....	33
SINGLE MOTIF .....	34
WEAVING .....	36
PUNCH LACE .....	38
PLATTING .....	40
DRAWING A PATTERN ON THE DESIGN CARD .....	41

*The Pattern Controller is available as an optional accessory.*

# PATTERN CONTROLLER, EC 1

The Pattern Controller is an unit necessary for pattern knitting with a Pattern Card.

## Names of Each Part and Accessories

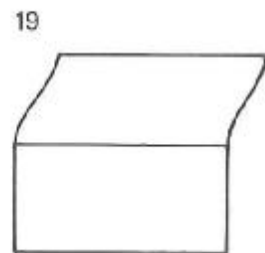
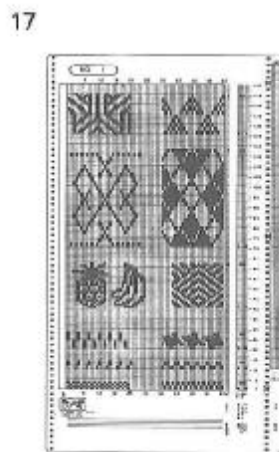
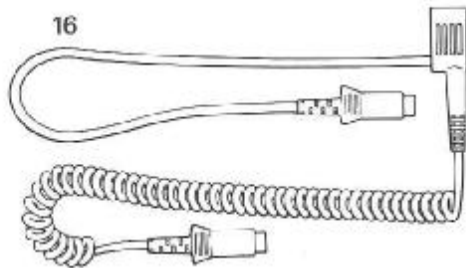
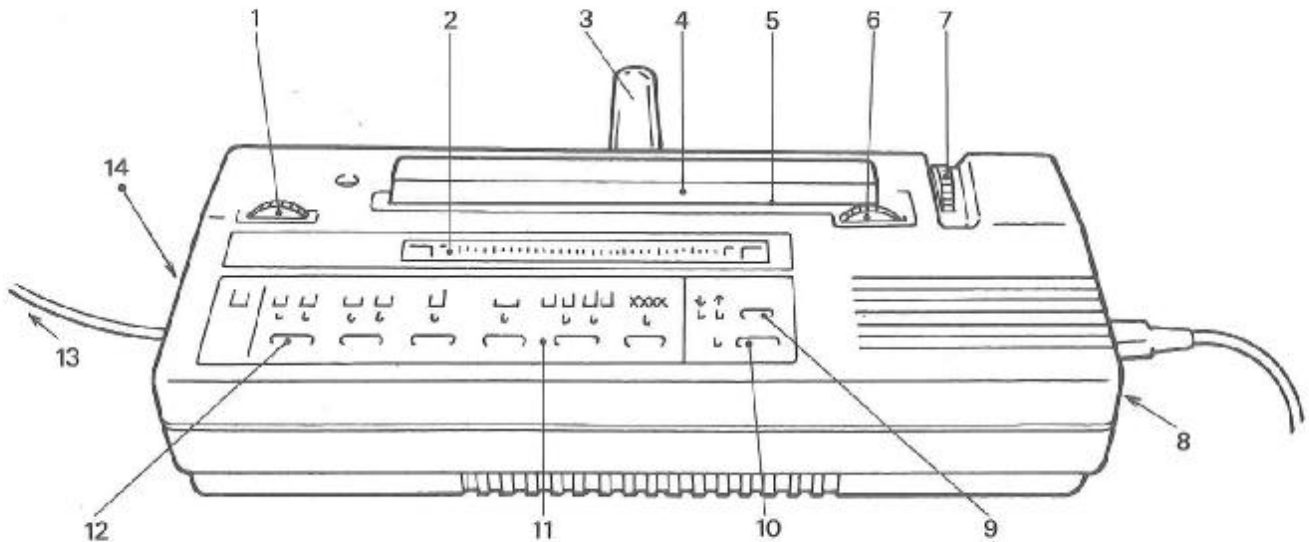

1. Left Pattern Dial
2. Pattern Width Indicator
3. Card Guide
4. Card Cover
5. Card Slot
6. Right Pattern Dial
7. Card Dial
8. On/Off Switch
9. Direction Switch

10. Inspection Switch
11. Pattern Panel
12. Pattern Switch
13. Connection Cord to the Curl Cord
14. Socket  
(This is used for plugging the Connection Cord of the Design Controller)
15. Power Cord
16. Curl Cord
17. Pattern Card (10), Design Card (5)
18. Pattern Collection
19. Card Cleaner

## CONNECTING THE PATTERN CONTROLLER TO THE MACHINE

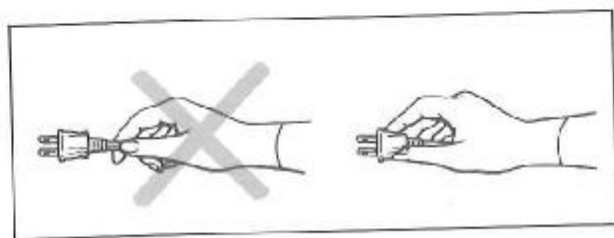
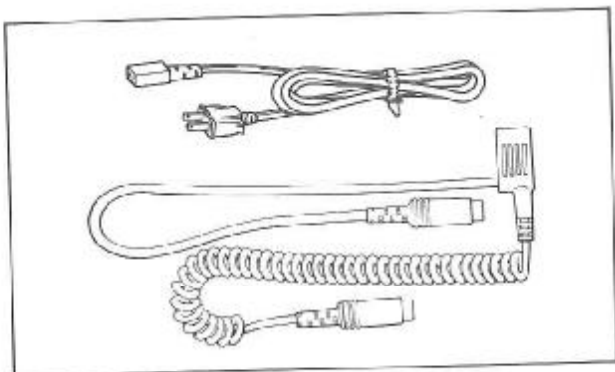

- ① Lift the Auto-Tension off the top of the Yarn Rod. Slide the block of the Curl Cord onto the Yarn Rod and replace the Auto-Tension. Slide the block down until it stops.
- ② Plug the Curl Cord into the socket of the Carriage with the mark ▼ to the front, corresponding to the ▼ on the Carriage.
- ③ Plug the straight cord into the Connection Cord of the Pattern Controller, matching the mark ▼ with the mark —.
- ④ Plug the Power Cord into the socket of the Pattern Controller.
- ⑤ Plug the Power Cord into the wall socket.

**Don't switch on the Controller, before plugging.**

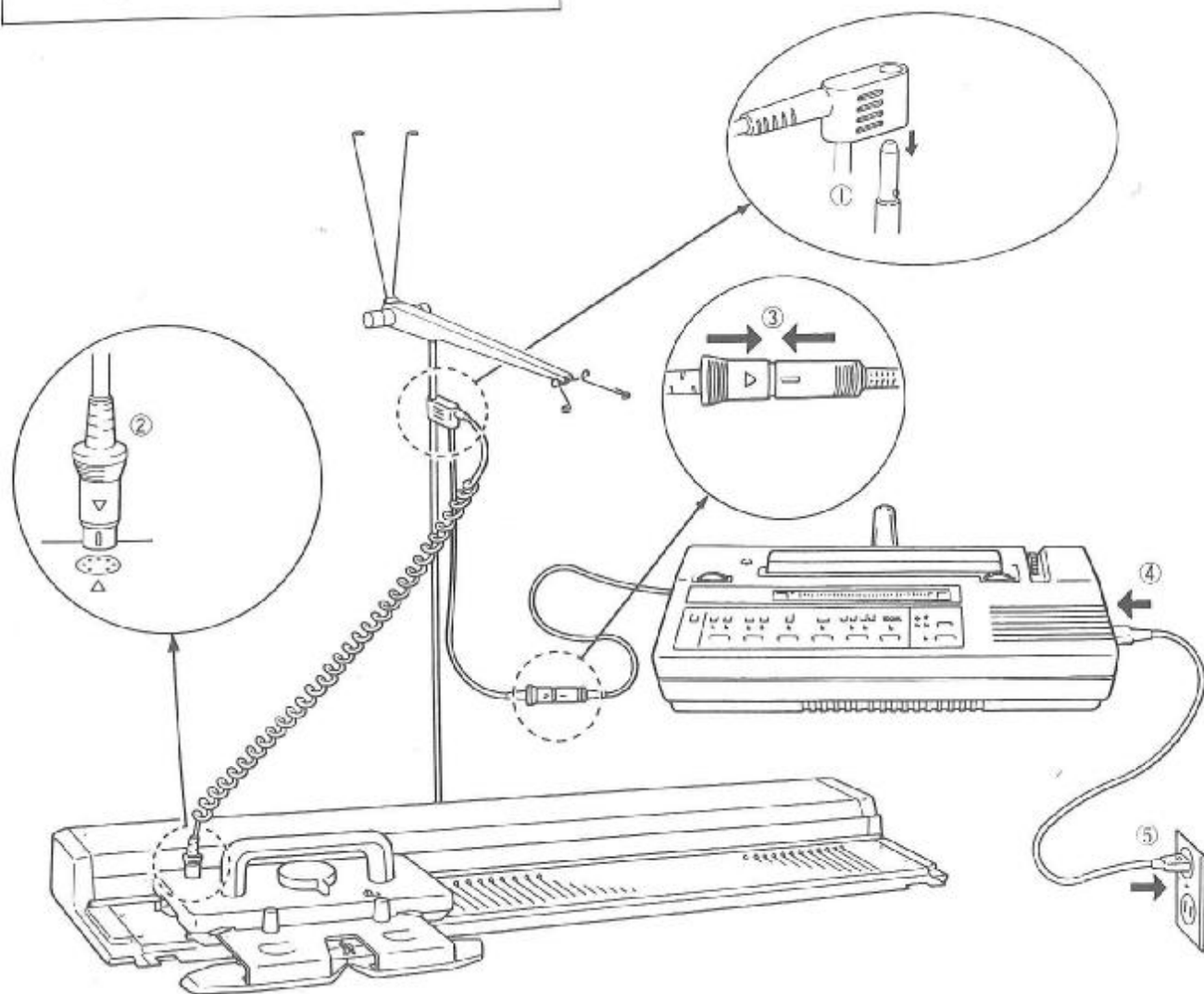



# PATTERN CARD

PATTERN CARD is printed with rectangles. Each rectangle is proportional to the size of a stitch. The black area represents a pattern to be produced on a knitting.

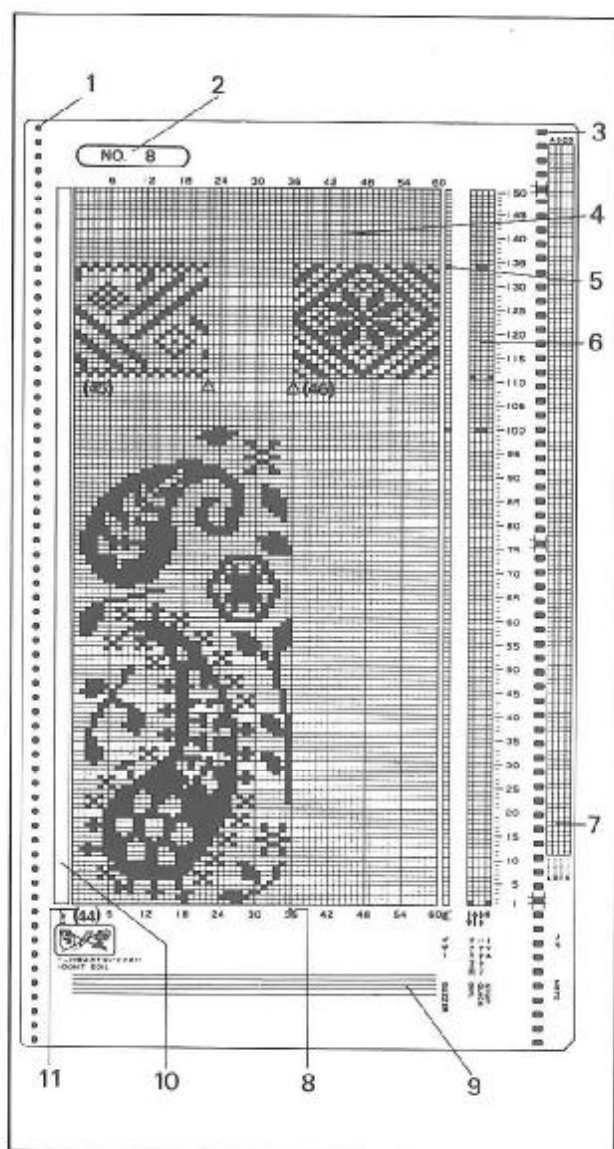

- 1 Feeding hole (left)
- 2 Card Number
- 3 Feeding hole (right)
- 4 Pattern area  
A pattern of 150 rows and 60 stitches can be drawn in this area.
- 5 Buzzer column  
The mark in this column operates the buzzer when the marked row is read.
- 6 Instruction columns (used to control the movement of Pattern Card).

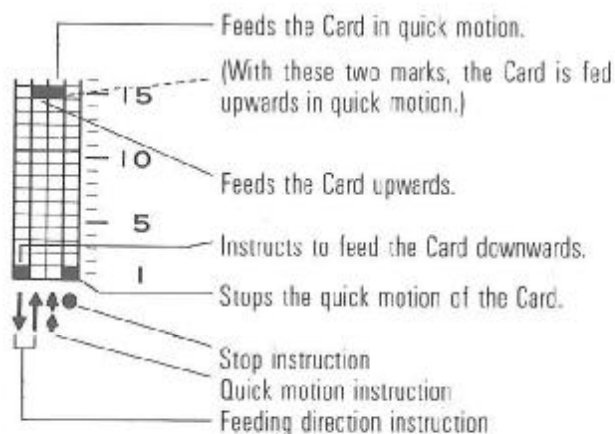

- 7 Notation column  
Use this column to note the row to change yarn or other indication. (As there is a 10-row difference between the row to knit and the row visible above the Card Slot, be sure to mark the tenth row above the actual row to be knitted.)
- 8 Pattern width setting mark  
The triangle shows where the Pattern Width Indicator can be set to vary the pattern. Set the Pattern Width Indicator corresponding with the triangle mark.
- 9 The horizontal lines are provided as a guide to ensure that the card is correctly inserted.
- 10 Do not soil this column.
- 11 Pattern number

## DESIGN CARD (5 sheets)

The Card is made of semi-transparent paper and has same rectangles as the Pattern Card. A pattern of your choice can be drawn on the Card using the Design Pencil. Refer to page 41.

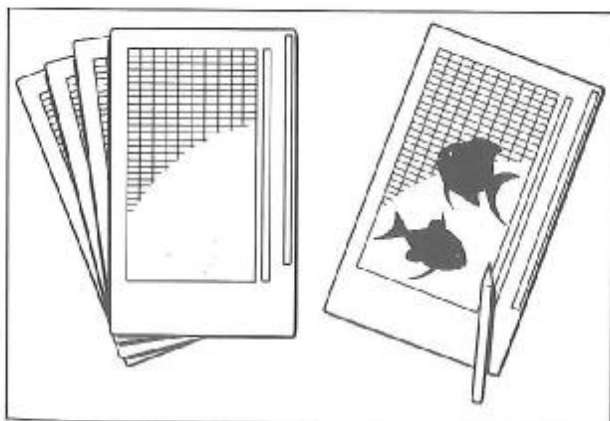

## POINT CAM AND NEEDLE-1 CAM

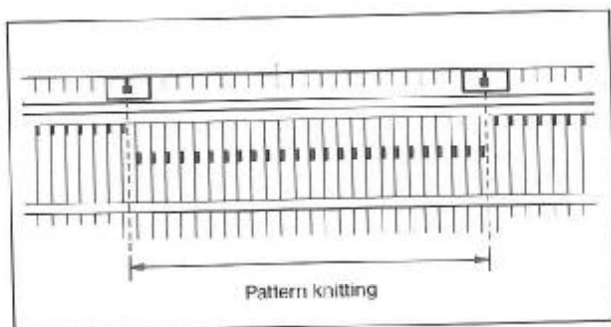

### Point Cam

The Point Cams are the ones which slide along the rail at the back of the Needle Bed.

Pattern knitting only operates between the two Point Cams. (The Point Cams determine the range of pattern knitting.)

When setting the Point Cams at both edges of the knitting needles, the pattern will be knitted overall the knitting.

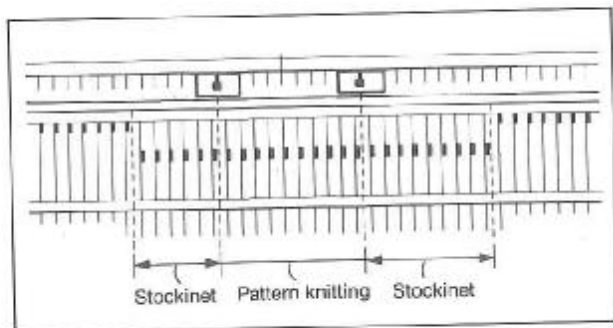

You can use the Point Cams to isolate Single Motif or to eliminate portions of the pattern.

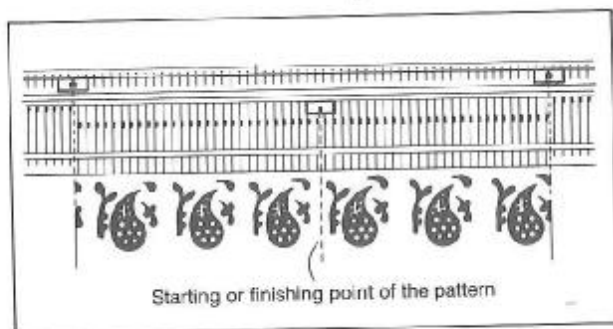

### Needle-1 Cam

The Needle-1 Cam is one of the small rectangular blocks with N1 on it. This has pegs to hold it in place. The pegs fit the small holes behind the Needle Bed.

The red line of the Needle-1 Cam tells the machine where to start and finish the pattern repeat.

Usually, Needle-1 Cam is put at the center of the Needle Bed.

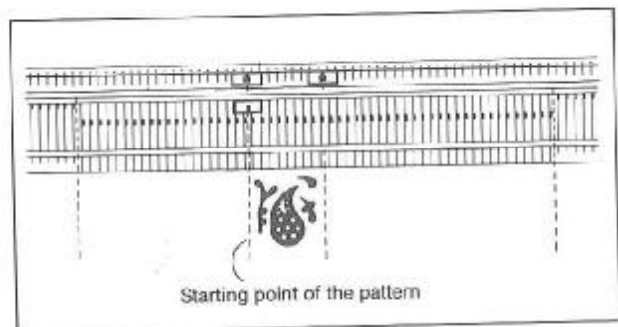

When knitting the pattern partially like Single Motif, put the Needle-1 Cam at either the left or right Point Cam as shown on the left.

You must put the Needle-1 Cam within the two Point Cams or at either Point Cam. Don't put it outside the Point Cams.

## PATTERN PANEL

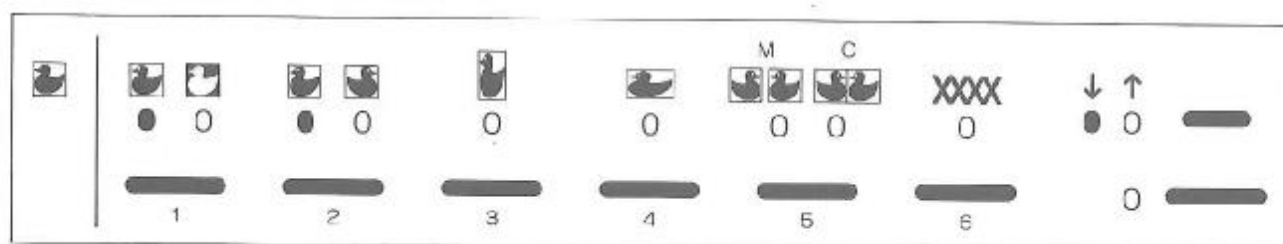

A single picture of a duck at the left end shows the pattern on the Pattern Card, the normal way it is knitted, so you can compare that picture with the pictures by the Pattern Switches (the function switches) and see what the effect of that switch is.

The lights below the pictures show whether that particular function is on or not. By pressing the switch, the light changes, comes on or goes off. When you switch on the Pattern Controller, the left lights of the Pattern Switches 1, 2 and the Direction Switch come on. So press on each switch, according to your need. You can use 2 or more switches together.

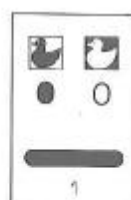

### Pattern Switch 1 (Colour Normal/Reverse)

Switch 1 shows the duck either like the sample duck to the left, or with the colours changed round.

Either the left or right light is always on. They determine whether the machine reads the black area or white area of the Pattern Card.

If the left light is on;

Fair Isle will knit a pattern as you see it on the Pattern Card. The machine knits the white area of the Pattern Card (background) with the yarn in Yarn Feeder ① and the black area (pattern) with the yarn in Yarn Feeder ②.

If the right light is on;

Fair Isle will knit a pattern with the colours reversed. The machine knits the white area with the yarn in Yarn Feeder ② and the black area with the yarn in Yarn Feeder ①.

The right light is used mainly for Tuck and Slip Stitch patterns. When the right light is on, the machine knits white area and tucks or slips the black area. You must use the left light for knitting Single Motif.



(Left light ON)



(Right light ON)



### Pattern Switch 2 (Direction Normal/Reverse)

Either the left or right light is always on and indicates which direction a pattern will face.

If the left light is on;

The pattern knits as you see it on the Pattern Card, on the purl side of the knitting.

If the right light is on;

The pattern faces the other way.

If you want the knit side to be the same as the Pattern Card, have the right light on. (In order to knit letters correctly, have the right light on.)

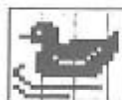

(Left light ON)



(Right light ON)



### Pattern Switch 3 (Vertical Expansion)

Switch 3 has only one picture and the duck is drawn the same width but twice as tall.

If the light is on, Any pattern will be knitted twice as tall. There will be two rows of knitting for each row on the Pattern Card. (Press this switch when the Carriage is on the side, ready to start knitting.)

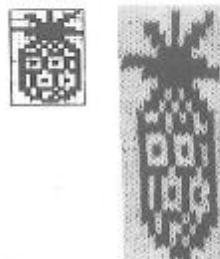

### Pattern Switch 4 (Horizontal Expansion)

Switch 4 also has only one picture, and the duck is shown normal height but twice as wide.

If the light is on, Any pattern will be knitted twice as wide. There will be two stitches for each one on the Pattern Card.

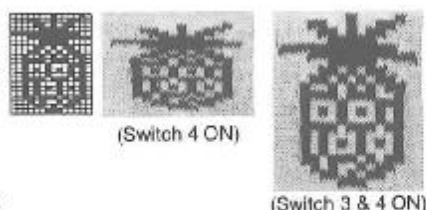

You can use switches 3 and 4 together to get a pattern twice as tall and twice as wide as the pattern drawn on the Pattern Card.

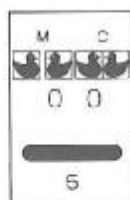

### Pattern Switch 5 (Mirror Image)

Switch 5 has two pictures, both with two ducks facing each other. Both these functions give a "mirror image" effect, but slightly differently. If either of these lights is on, the pattern will knit facing one way, then the other way, then the first way again, all across the knitting. These functions are distinguished by letter "M" and "C". M means "Mirror" and C means "Chevron".

The difference is easiest to understand if we use a very simple seven stitch pattern. We'll call the stitches 1-2-3-4-5-6-7.

If the left light is on (Mirror); The pattern will knit 1-2-3-4-5-6-7-7-6-5-4-3-2-1 and so on. The pivotal stitches (both edges of the pattern) repeat.

If the right light is on (Chevron); The pattern will knit 1-2-3-4-5-6-7-6-5-4-3-2 and so on. The pivotal stitches (both edges of the pattern) do not repeat.

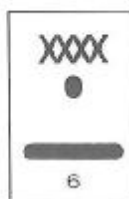
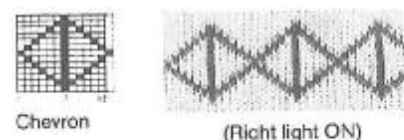
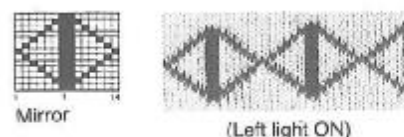
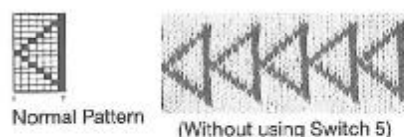

### Pattern Switch 6 (Jacquard)

Switch 6 is used only when knitting Double Jacquard and Double Face Knitting using Pattern Card for Fair Isle with the use of the Ribber. (Refer to pages 95 ~ 98.)

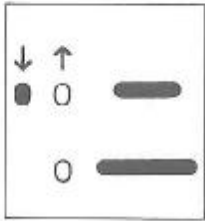

### Direction Switch

The Direction Switch is used to change the feeding direction of the Pattern Card. It has two lights.

If the left light is on;  
The Pattern Card will be fed downwards.

If the right light is on;  
The Pattern Card will be fed upwards.

Normally this direction will be handled completely automatically by the instruction columns of the Pattern Card.

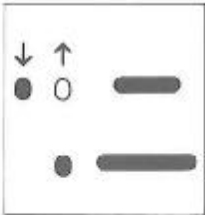

### Inspection Switch

The Inspection Switch is used to feed the Pattern Card, or to stop feeding. It is very important and you'll use it a lot. It has only one light. Press the switch to have the light on.

If the light is on;  
The Pattern Card will come up by 10 rows and stop. It won't be fed even if the Carriage is moved.

If the light is off;  
The Pattern Card will be fed down into the Card Reader by 10 rows and the pattern on the first row will be read by the scanner. (When the pattern is read, you'll hear the scanning sound.)  
The Pattern Card will be succeedingly fed responding to the movement of the Carriage.



## PATTERN WIDTH INDICATOR

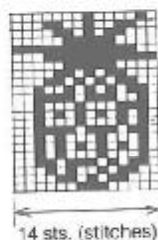
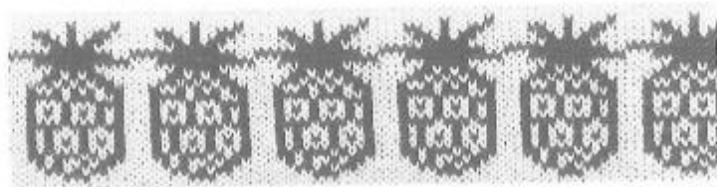
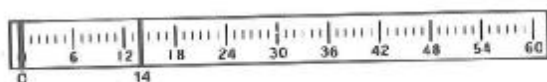
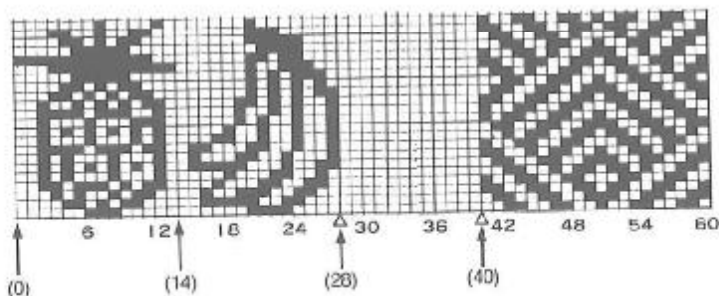
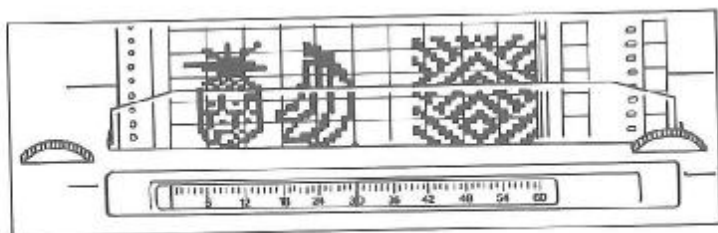

Set the left red pointer to (0) on the scale and the right to (14).

14 stitches from the 1st to the 14th on the Pattern Card will be knitted.

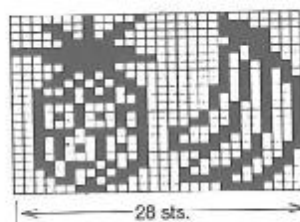
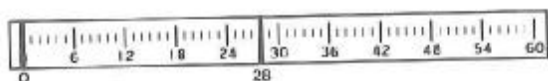

Set the left pointer to (0) and the right to (28).

28 stitches from the 1st to the 28th will be knitted.

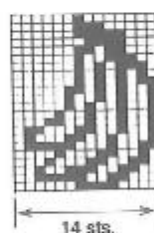
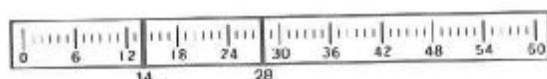

Set the left pointer to (14) and the right to (28).

14 stitches from the 15th to the 28th will be knitted.

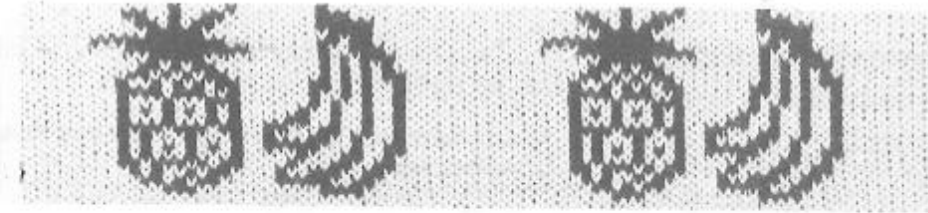

Set the left pointer to (0) and the right to (40).

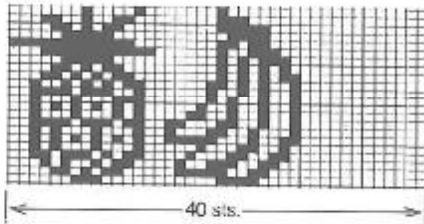

40 stitches from the 1st to the 40th will be knitted.

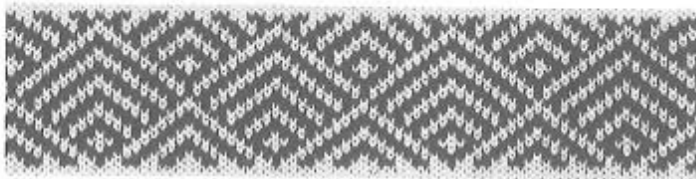
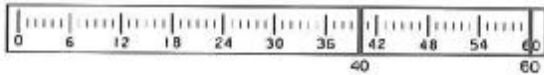

Set the left pointer to (40) and the right to (60).

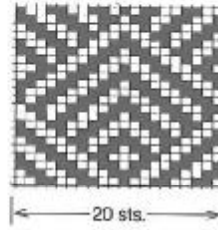

20 stitches from the 41st to the 60th will be knitted.

The samples above and the ones on the previous page are knitted with the right light of the Pattern Switch-2 ON.

## SETTING THE PATTERN CARD

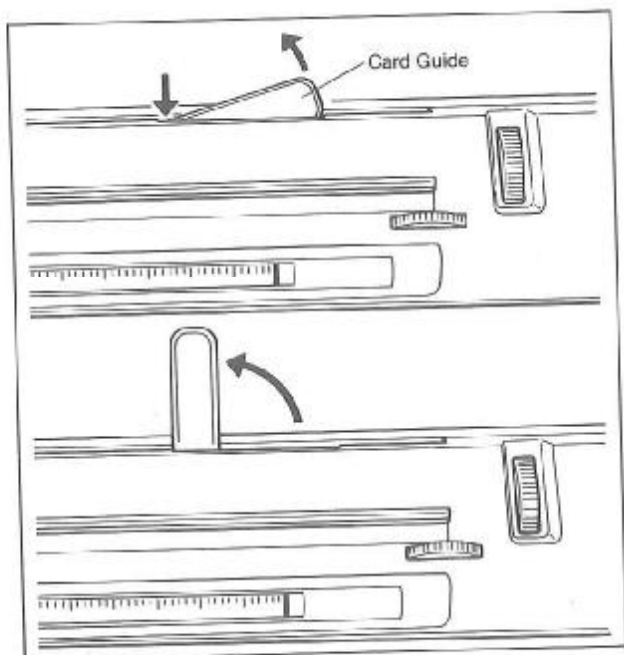

1. Press the left end of the Card Guide to have the other end come out and pull it out in the arrowed direction.

*The Card Guide stops the Pattern Card from rolling round and getting caught.*

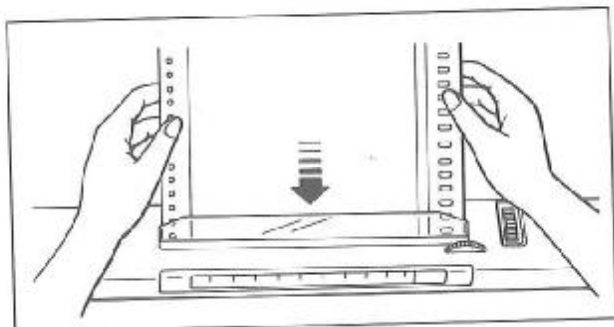

2. Press "ON" the Inspection Switch. (Light comes on.)
3. Hold the Pattern Card in both hands and push it down into the Card Slot behind the plastic Card Cover.

Check that the horizontal lines on the Pattern Card parallel the Card Slot.

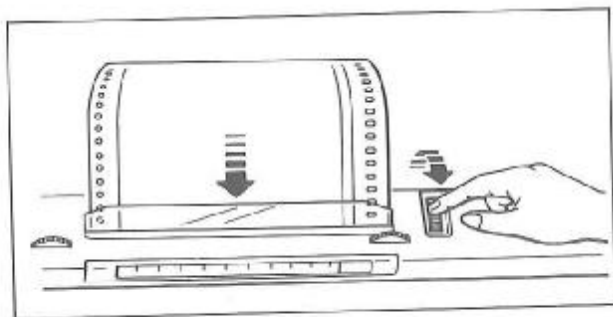

4. Turning the Card Dial towards you, insert the Card into the Slot.
5. Set the Pattern Width by turning the Pattern Dials.
6. Turn the Card Dial towards you until the first row of the pattern is just visible above the Slot.

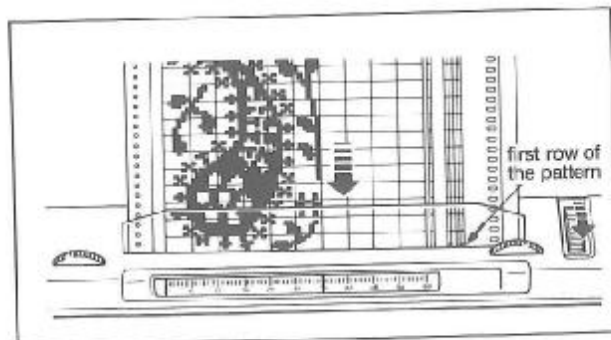
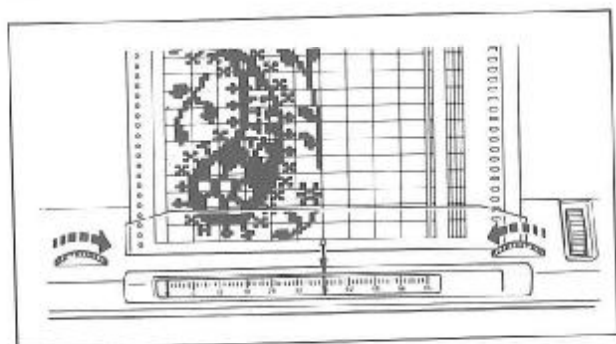

## PRECAUTION IN PATTERN KNITTING

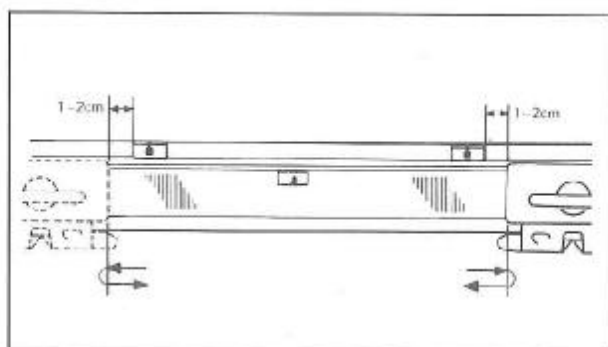

### Carriage operation

Move the Carriage until it clears both Point Cams before returning it. If you return the Carriage before clearing the Point Cam, the pattern will be knitted incorrectly.

To correct the memory, turn off the Controller and then follow the instructions given under "To turn off the Controller during knitting" on page 103.

Knitting speed must not exceed the reading speed of patterns. Listen for the scanning sound as you knit.

If the Carriage is moved back and forth too quickly, it may cause the reader to skip a pattern row.

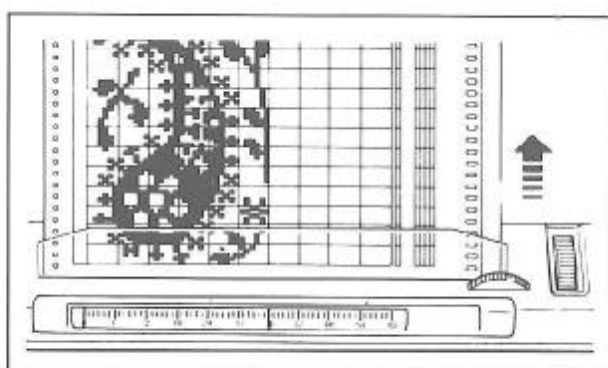

### Card returning

When the last row of the pattern has been read, the buzzer sounds once. When the last row of the pattern has been knitted, the Pattern Card returns to the first row of the pattern in a quick motion.

While the Card is in quick motion, hold the Carriage outside the Point Cams till the Card stops, and reading the pattern is completed.

If you move the Carriage before the Card returns, the machine will beep out a warning and the pattern will be knitted incorrectly.

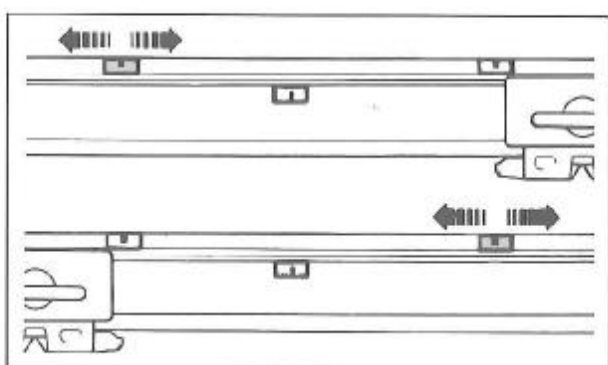

### Point Cams and Needle-1 Cam

You may move the Point Cam on the opposite side to the Carriage before knitting the next row. You may never move the Point Cam on the Carriage side during pattern knitting. (If the Point Cams are away from the edge of the knitting as a result of decreasing, make sure the Carriage passed the Point Cams.)

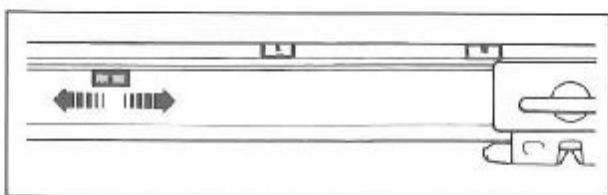

Do not move the Needle-1 Cam.

If the Needle-1 Cam is left outside of the Point Cams as a result of garment shaping, leave it in its original position, but ensure that the Carriage passes it on each row.

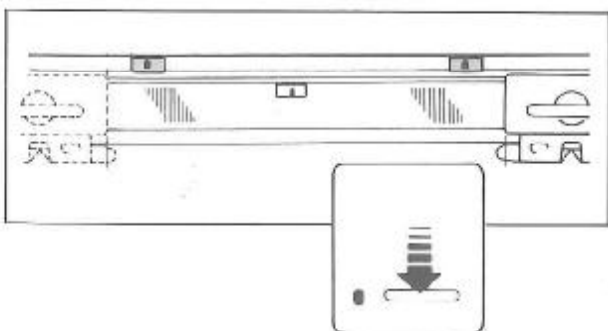

### Inspection Switch and Pattern Switches

Don't press the Inspection Switch and the Pattern Switches when the Carriage is between the Point Cams.

If you press them in this situation, some of them won't work. To press the Inspection Switch and the Pattern Switches, place the Carriage outside of the Point Cams (on the left or right side).

## FAIR ISLE(KNIT-IN)

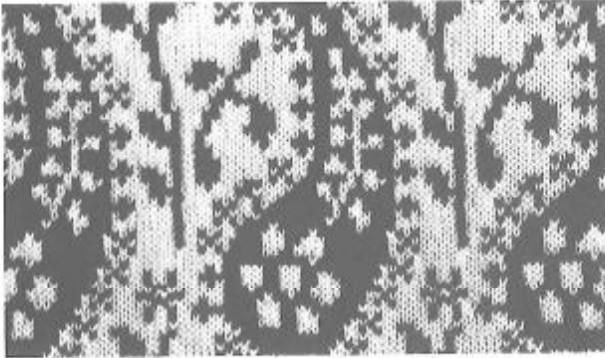

Two yarns of different colours are knitted simultaneously and form patterns on the knitting.  
The sample is knitted with the Pattern No.8—(44).

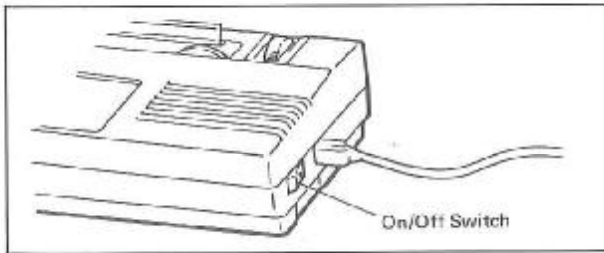
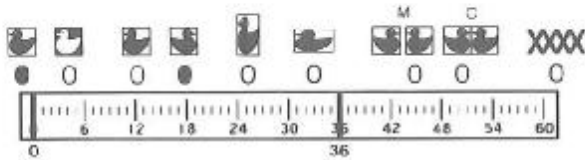

### PROCEDURE FOR PATTERN KNITTING

- 1 After connecting the Pattern Controller to the machine, switch on the Pattern Controller.  
The Controller will beep. This tells you that all is well.

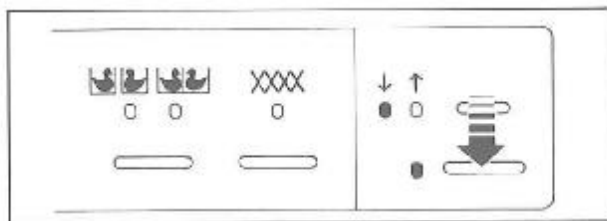

- 2 Press "ON" the Inspection Switch. (The light comes on.)

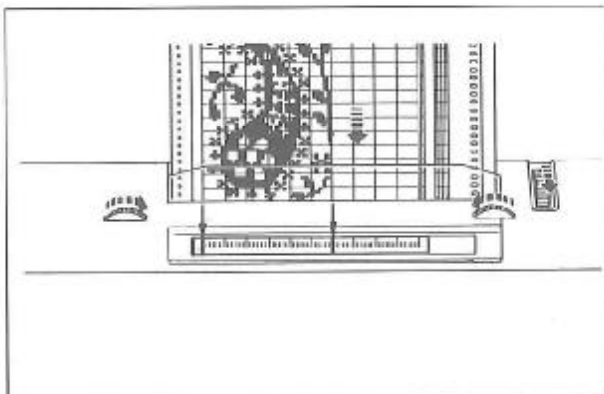

- 3 Insert the Pattern Card into the Card Slot.  
(Refer to page 25.)

Set the pattern width by turning the Pattern Dials as shown below the picture.

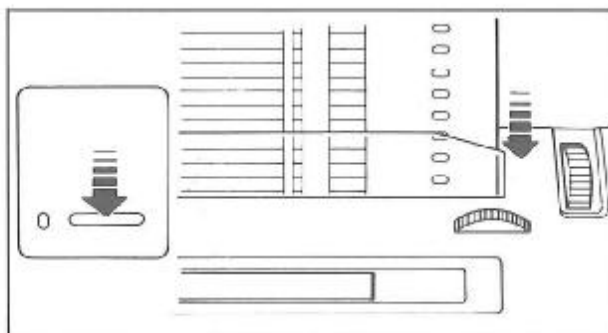
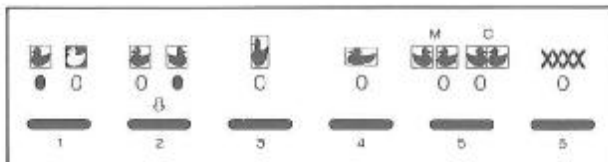
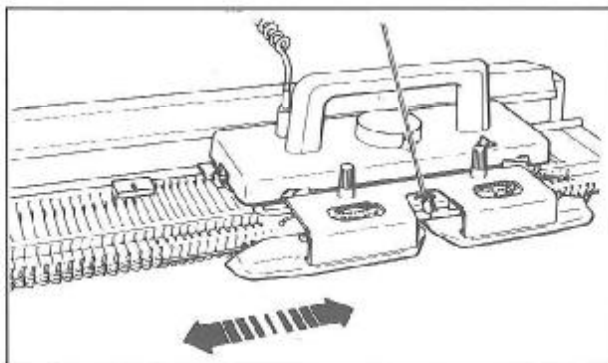
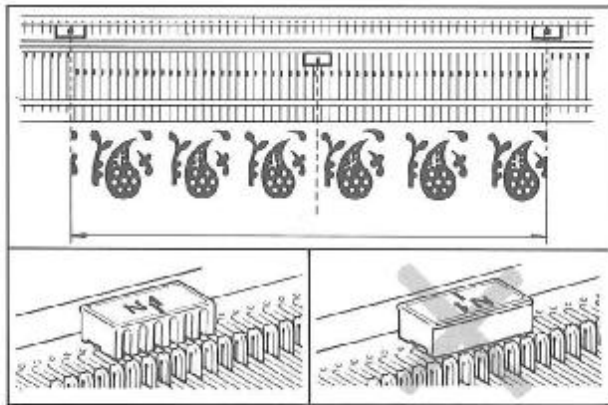
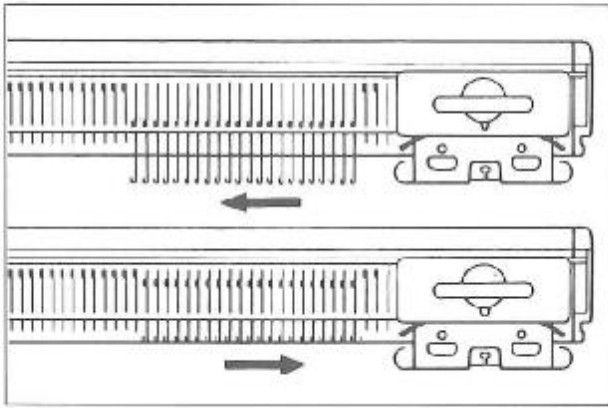

- 4 Push the required number of needles to D position.

Set the Carriage as shown below.

Cam Lever..... ○ (Stockinet)  
 Russel Levers..... || (both)  
 Weaving Knobs..... ○ (both)

Move the Carriage across the needles to align them in B position. (In case knitting has already been started, this step can be skipped.)

- 5 Set the Point Cams at both ends of the needles in B position so that their red marks come to the outside of the end needles.

Set the Needle-1 Cam at the center of Needle Bed.

Set the Needle-1 Cam into the holes at the back of the Needle Bed.

The Needle-1 Cam must be placed behind the needles, with the red line facing you.

- 6 Thread the main yarn through the Auto-Tension and into Yarn Feeder ①.

Cast-on and knit several rows in Stockinet, finishing with the Carriage on the right. (Refer to pages 9 ~ 11.)

If there is already knitting on the needles, move the Carriage across twice without knitting, by using the Release Lever. This is to enable the machine to memorize the positions of the Point Cams and the Needle-1 Cam.

- 7 Press the Pattern Switch as shown below the picture on page 27.

- 8 Press "OFF" the Inspection Switch. (The light goes off. The Pattern Card is fed by 10 rows downwards and the pattern on the first row is read.)



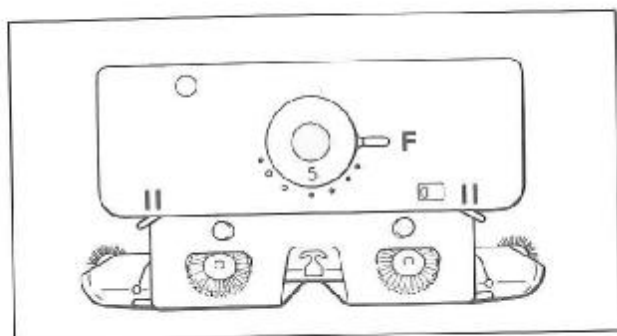

⑨ Set the Carriage as shown below.

Cam Lever..... F (Fair Isle)  
 Russel Levers..... II (both)  
 Weaving Knobs..... O (both)

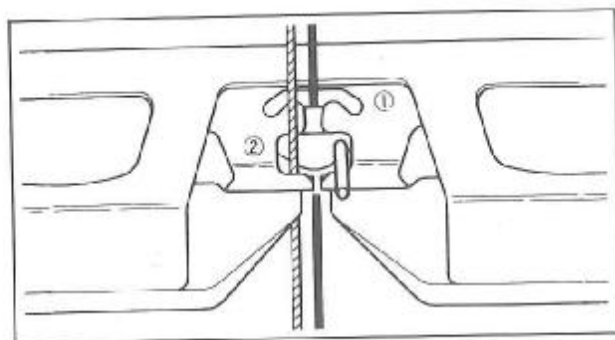

Thread the contrast yarn through the Auto-Tension and into Yarn Feeder ②.

PREPARATORY STEPS FOR PATTERN KNITTING HAVE BEEN COMPLETED. START KNITTING THE PATTERNS.

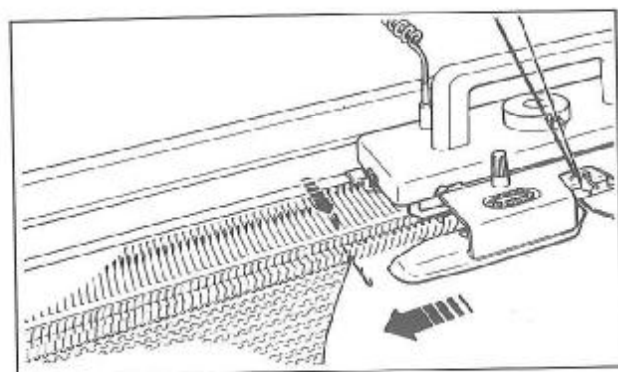

#### WHILE KNITTING THE PATTERN

To make both edges of the knitting neat, push the end needle next to the Carriage to D (or C in partial knitting) position before knitting the next row.

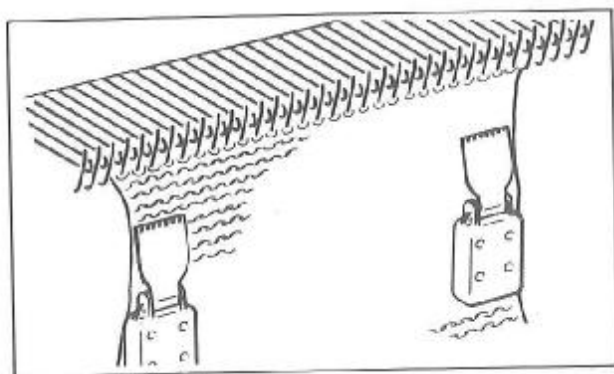

Hang the Claw Weights on both sides of the knitting. (Move them up as knitting progresses.)



# TUCK STITCH

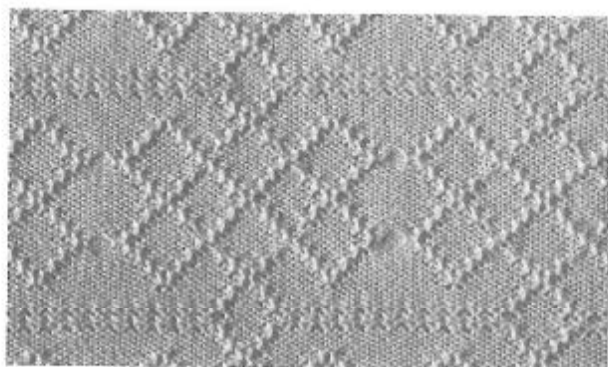

A selected needle holds yarn in the hook for one or more rows. On completing the Tuck Stitch section, the needle knits all the loops of yarn together.

The sample is knitted with the Pattern No.1-(9).

Before knitting this stitch pattern, follow the Preparatory Steps ① ~ ⑧ given on pages 27 ~ 28.

As the Stop ⑨ is a little different, follow the instructions below.

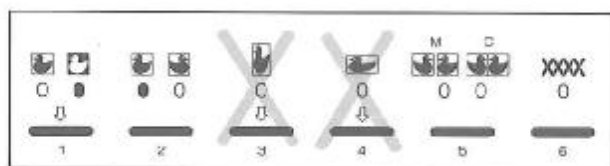
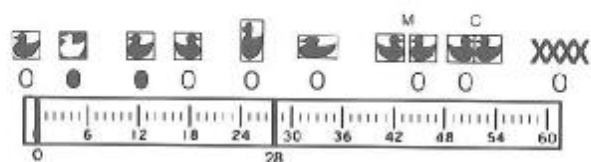

## PRECAUTION

The Pattern Switch-1 must be pressed to have the RIGHT light on for Tuck Stitch.

Don't use the Pattern Switches 3 and 4.

Switch 5 with the left light on (M) is not recommended, because the machine has difficulty in tucking needles next to each other, and may drop stitches.

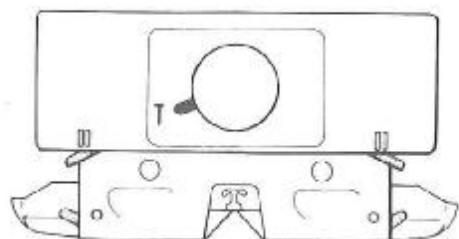

⑨ Set the Carriage as shown below.

Cam Lever..... T (Tuck)  
 Russel Levers..... II (both)  
 Weaving Knobs..... O (both)

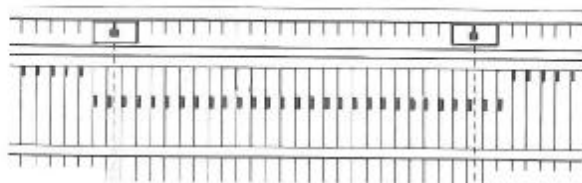

If the edge stitches knit incorrectly, set the Point Cams one or two stitches in from the edge of the knitting.

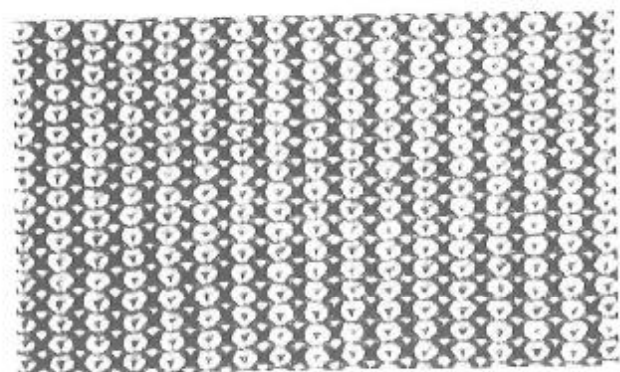
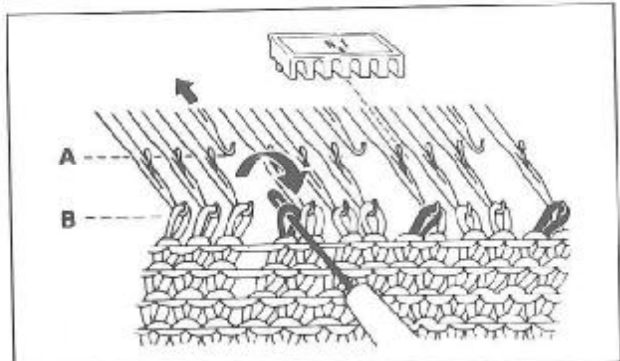
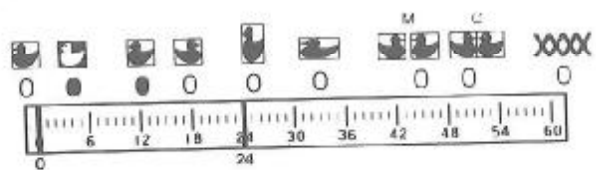
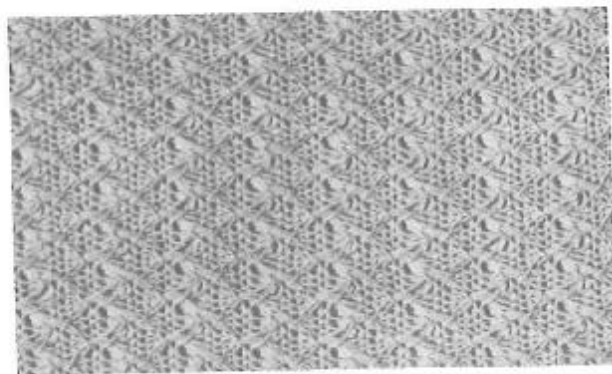

### Tuck Lace

Arrange the needles as instructed below and knit as for Tuck Stitch.

The sample is knitted with the Pattern No.1-(15).

Before knitting this stitch pattern, follow the Preparatory Steps ① ~ ③ given on pages 27 ~ 28. As the step ⑨ is a little different, follow the instructions below.

⑨ Set the Carriage, following the step ⑨ on page 30.

### BEFORE KNITTING THE PATTERN

Rearrange the needles as illustrated, by transferring the stitches using a Transfer Tool.

*Push the empty needles back to A position.*

Hang Claw Weights at both edges of the knitting and move them up as knitting progresses.

### Tuck Stitch in Colours

Tuck Stitch can be knitted using yarns of different colours.

The sample is knitted in Tuck Stitch with the Pattern No.1-(2), using two colours.

The Preparatory Steps are the same as for single colour work.

### WHILE KNITTING THE PATTERN

Place colour 1 into Yarn Feeder ① and knit first 2 rows.

Exchange colour 1 for colour 2 and knit 2 rows.

Continue to knit exchanging colours every 2 rows. (Exchange the yarns in the same way as for "Knitting Stripe Pattern" on pages 12 ~ 13.)

# SLIP STITCH

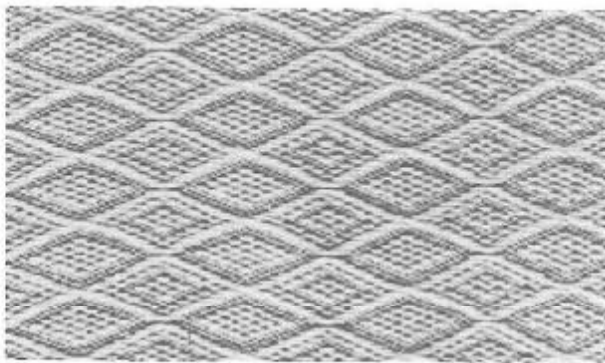

A selected needle remains inactive and the yarn passes in front of the needle. Non-selected needles knit Stockinet.

The sample is knitted with the Pattern No.2-(19).

Before knitting this stitch pattern, follow the Preparatory Steps 1, 2, 3, 4, 6, 7, 8 given on pages 27 ~ 28.

As the Steps 5 and 9 are a little different, follow the instructions below.

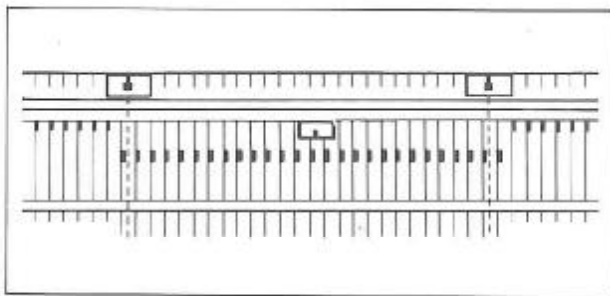
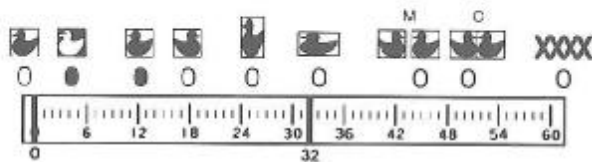

- 5 Set the Point Cams one stitch in from the edge of the knitting to prevent the edge stitches from knitting incorrectly.

Set the Needle-1 Cam at the center of the Needle Bed.

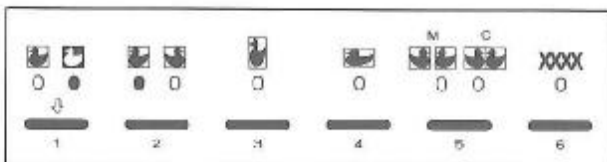

## PRECAUTION

The Pattern Switch 1 must be pressed to have the RIGHT light on.

Switches 3, 4 or 5 may be used with Slip Stitch, but the pattern would be even less pronounced, so experiment with samples before knitting your garment.

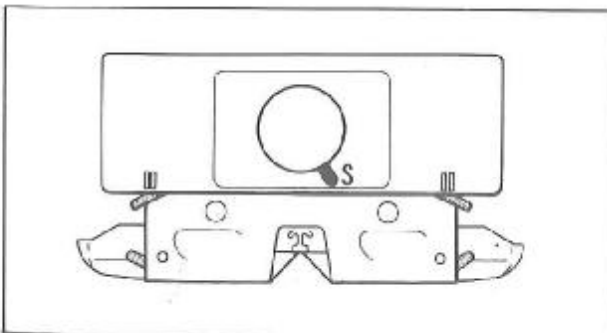

- 9 Set the Carriage as shown below.

Cam Lever..... S (Slip)  
 Russel Levers..... II (both)  
 Weaving Knobs..... O (both)

It is recommended to set the Stitch Dial 1 number higher than the other stitch types.

*Hang the Claw Weights.*

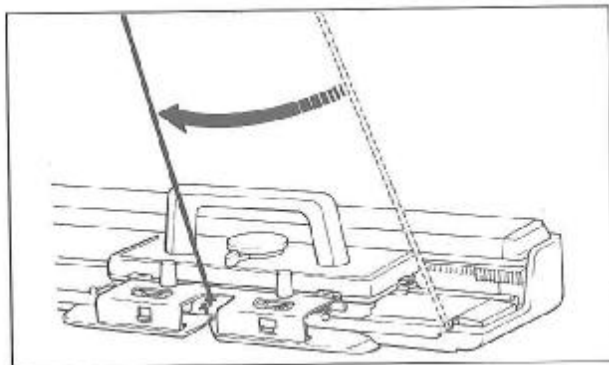
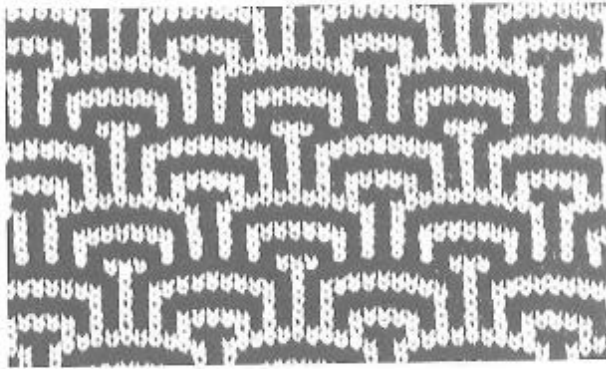

## Slip Stitch in Colours

Slip Stitch can be knitted using yarns of different colours.

The sample is knitted in Slip Stitch with the Pattern No.1-(12) using two colours.

The Preparatory Steps are the same as for single colour work.

## WHILE KNITTING THE PATTERN

Place colour 1 into Yarn Feeder ① and knit first 2 rows.

Exchange colour 1 for colour 2 and knit 2 rows.

Continue to knit exchanging colours every 2 rows. [Exchange the yarns in the same way as for "Knitting Stripe Pattern" on pages 12 ~ 13.]

*The Automatic Yarn Changer is available as an optional accessory and is very useful for Tuck Stitch and Slip Stitch in Colours.*

# SINGLE MOTIF



A single pattern in Fair Isle (Knit-in) can be knitted at any position on the knitting.

The sample is knitted with the Pattern No.10-(49).

Before knitting this stitch pattern, follow the Preparatory Steps ①, ②, ③, ④, ⑥, ⑦, ⑧, ⑨ given on pages 27 ~ 28. As the Steps ⑤ is a little different, follow the instructions below.

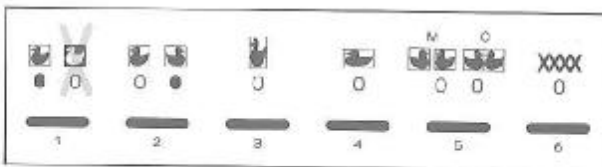

When knitting in Single Motif pattern, the left light of the Pattern Switch-1 must be lit.

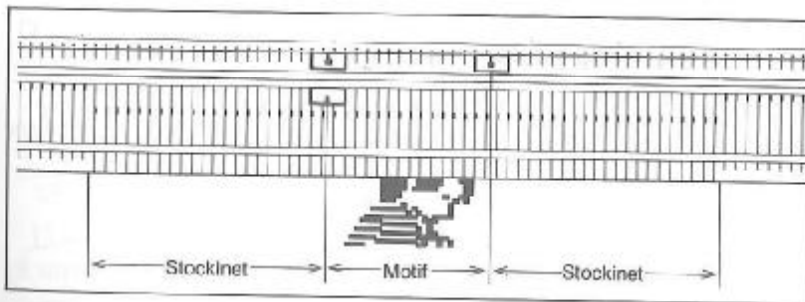

⑤ The sample shown here has the pattern width of 36 stitches. Set the Point Cams 36 needles apart, and align the red line of the Needle-1 Cam with the red line of the left Point Cam, as shown in the diagram.

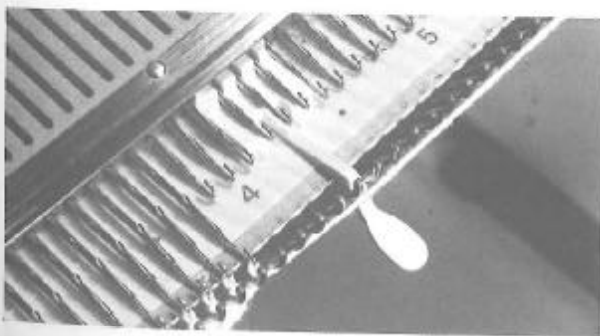

Open the latches of the 4th, 5th and 6th needles beyond the needles in B position.

Insert the Yarn Separator under those needles on both sides as far as they go.

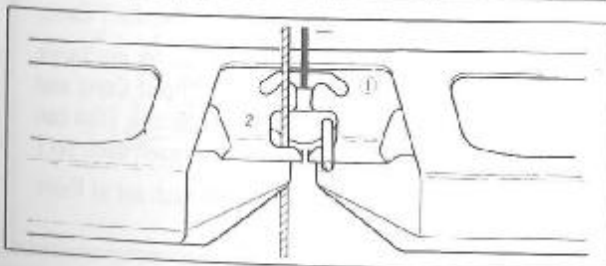

Put the contrast yarn into the Yarn Feeder ①, and start knitting.

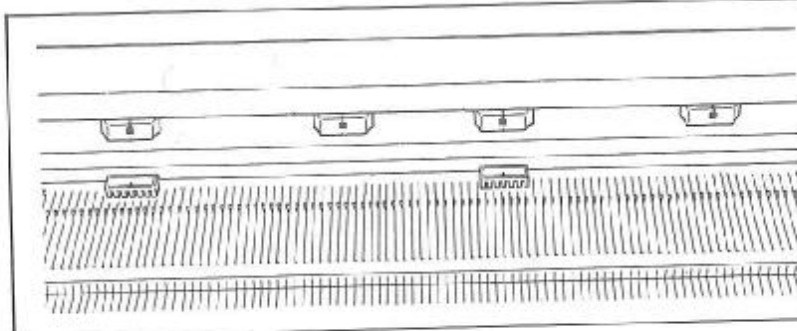
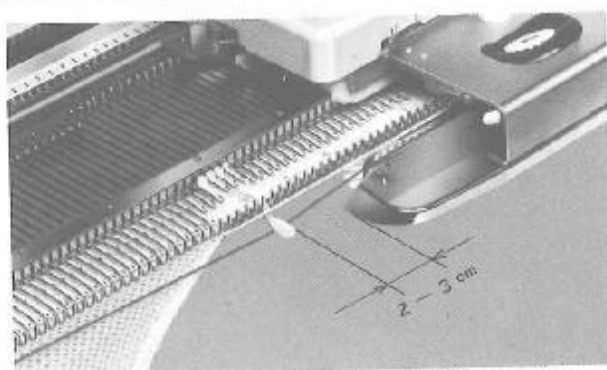
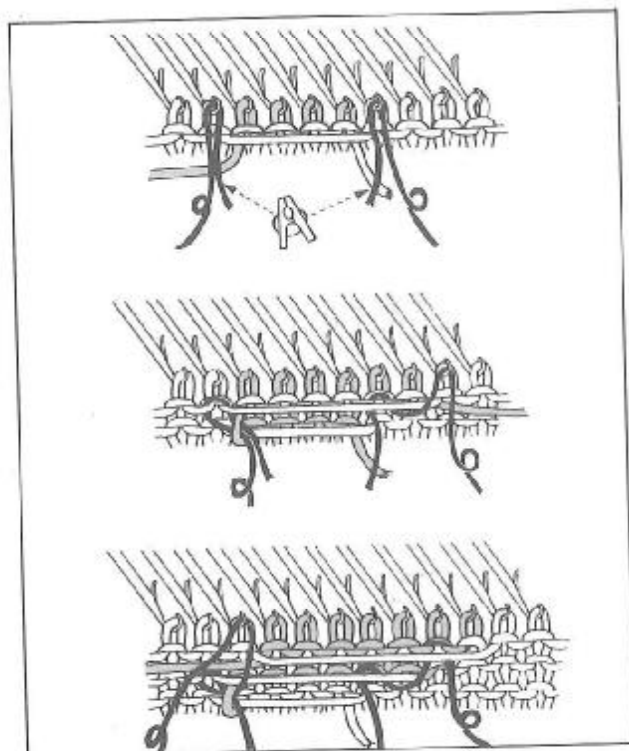
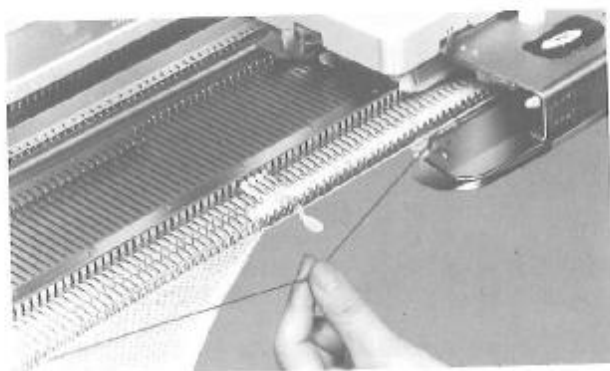

## WHILE KNITTING THE PATTERN

Make sure that the main yarn comes above the Separator and the contrast yarn below the Separator before knitting the next row. If they are not, correct them manually.

To prevent separation of the contrast yarn from the ground yarn at the edge of the Single Motif pattern, follow the procedure below.

- ① Prepare two pieces of yarn, 60 ~ 70cm. long, cut from the ground yarn.
- ② Place the yarns in the hooks of the needles immediately adjacent to the last needles knitted in the contrast yarn at both edges of the Single Motif. It is advisable to clip the short ends of the yarns together.
- ③ Knit the next row, and place the yarn in the hook of the needle immediately adjacent to the Single Motif on the Carriage side.
- ④ Knit the next row, and place the yarn in the hook of the needle adjacent to the Single Motif on the Carriage side.
- ⑤ Repeat the above steps on each row on the Carriage side.

To knit Stockinet after the Single Motif, set the Cam Lever to **O**. Press "ON" the Inspection Switch and knit.

*Hang the Claw Weights on the knitting at the positions corresponding to the edges of the Single Motif pattern.*

During knitting, make sure the Carriage clears the Separator by 2 ~ 3cms.

You can knit two isolated Motifs by using two sets of Point Cams and two Needle-1 Cams. Knit them in the same way as for the Single Motif. But set two sets of Point Cams and Needle 1 Cams as shown opposite. (You can leave space as you want between each set.) Use one Needle-1 Cam for each set of Point Cams.



# WEAVING

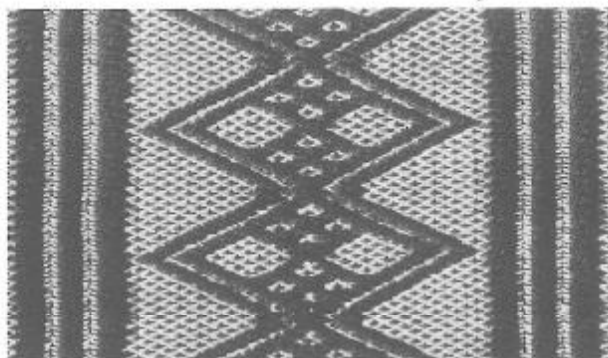

On the purl side of Stockinet Stitch knitted with medium yarn, a thick yarn or a fancy yarn (hereafter called weaving yarn) is threaded in and out of the stitches, giving a woven effect.

The sample is knitted with Pattern No.10-(50).

Before knitting this stitch pattern, follow the Preparatory Steps ① ~ ⑧ given on pages 27 ~ 28.

As the Step ⑨ is a little different, follow the instructions below.

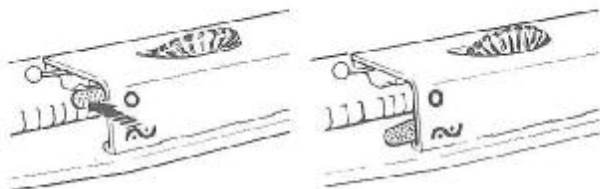
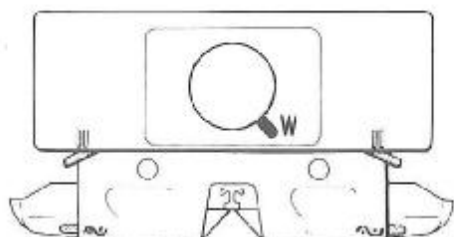
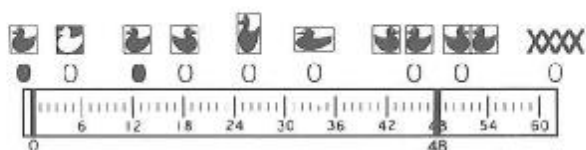

⑨ Set the Carriage as shown below.

Cam Lever..... O (Stockinet) W  
 Russel Levers..... II (both)  
 Weaving Knobs..... ~ (both)

Set the Stitch Dial 1 number higher than for Stockinet knitting.

To set the Weaving Knob to ~, push it slightly forwards and will drop into position.



Thread the weaving yarn into the Auto-Tension and hook it into the Yarn Clip.

*Hang the Claw Weights on both sides of the knitting.*



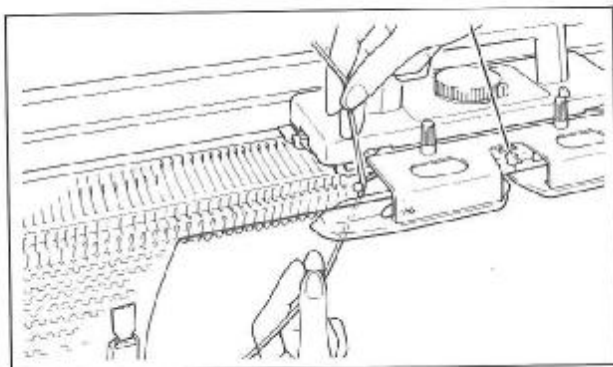

To start pattern knitting, follow the procedure below.

Take the weaver's yarn from the Clip on the Yarn Rod, and place it in the Weaver's Yarn Holder on the leading side of the Carriage.

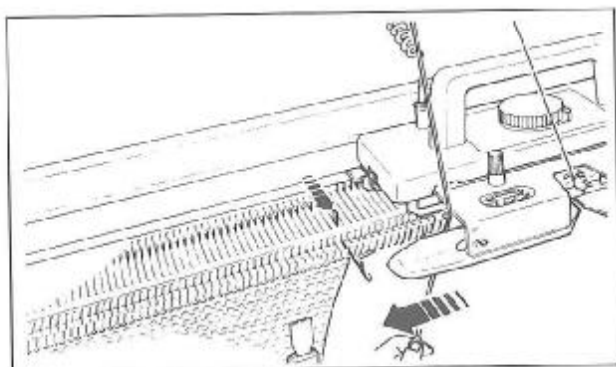

Holding the weaver's yarn under the Arm, push the end needle on the Carriage side to D position (or C position in partial knitting), and then move the Carriage to the other side.

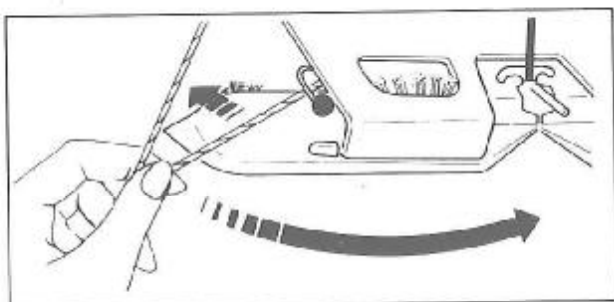

Before knitting the next row, remove the weaver's yarn from the Weaver's Yarn Holder.

Guide the weaver's yarn under the Arm to the other side of the Carriage.

At this step, push the Carriage in the original direction to free the weaver's yarn from the brushes under the Arm.

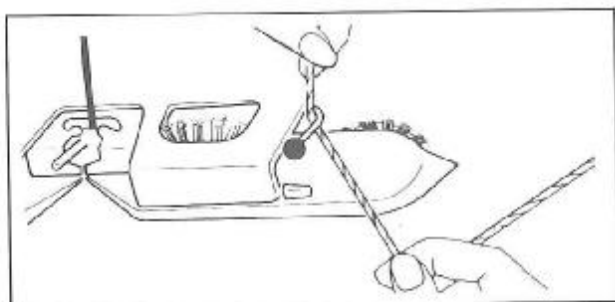

Place the weaver's yarn inside the Holder on the leading side of the Carriage.

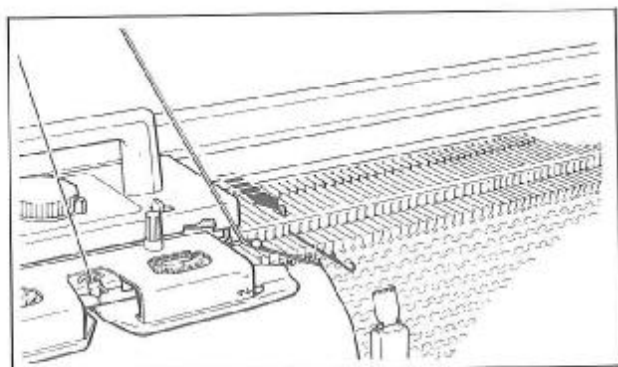

Push the end needle on the Carriage side to D position (or C position in partial knitting) and move the Carriage to the other side of the Needle Bed.

Repeat in the same manner, placing the weaver's yarn into the Holder on the leading side before knitting the next row.

# PUNCH LACE

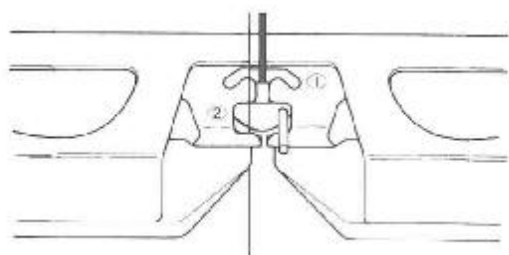
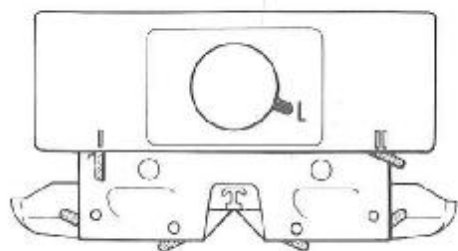
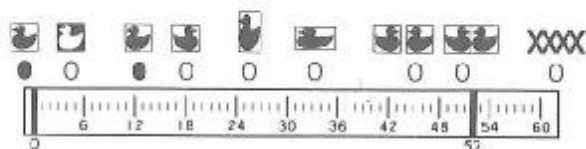
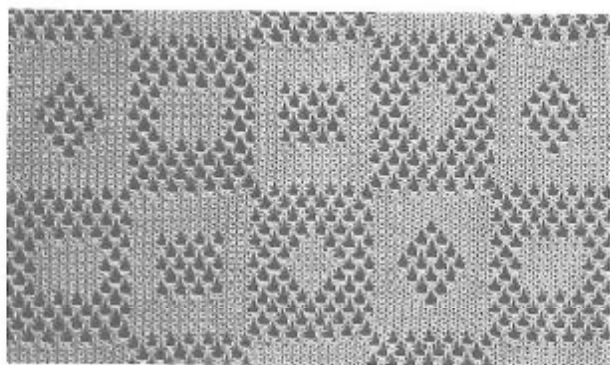

Combinations of thick yarn and self coloured very fine yarn or one of the special transparent nylon threads produce a lace effect pattern.

The sample is knitted with the Pattern No.6-(38).

Before knitting this stitch pattern, follow the Preparatory Steps ① ~ ⑧ given on pages 27 ~ 28.

As the Step ⑨ is a little different, follow the instructions below.

⑨ Set the Carriage as shown below.

Cam Lever.....	L	(Punch Lace)
Russal Levers.....	I	(left)
	II	(right)
Weaving Knobs.....	O	(both)

Thread the thicker yarn into the Yarn Feeder ① and finer yarn into the Yarn Feeder ②, left of Guide Pin.  
(You will probably have to put the Tension Dial to 7 at the top of the Yarn Rod, to hold the finer yarn.)

Cover spool of nylon thread with Stop Net (an optional accessory) or with a cut-piece of stocking.

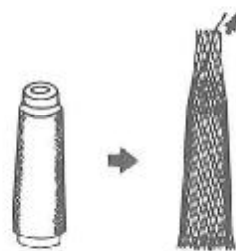

*Hang the Claw Weights on both sides of the knitting.*

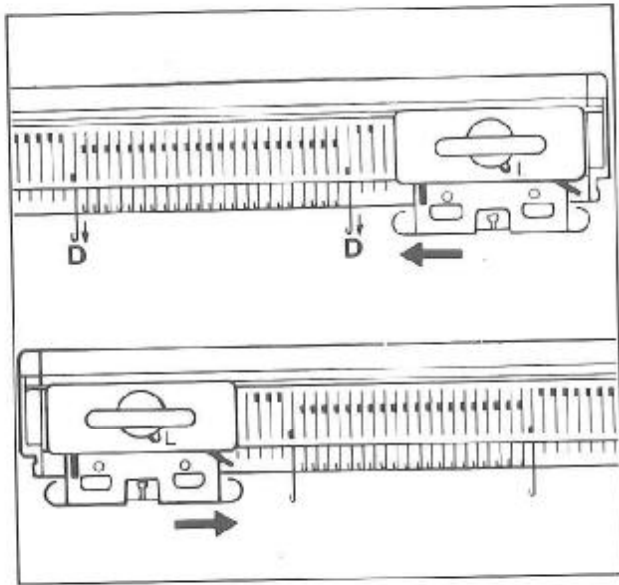

### WHILE KNITTING THE PATTERN

Push one needle at both edges of the knitting to D position.

Knit from right to left. (The end needles will not be knitted.)

Knit from left to right. (The end needles will be knitted back to B position.)

Knit the required number of rows pushing the end needles to D position when the Carriage is on the right.

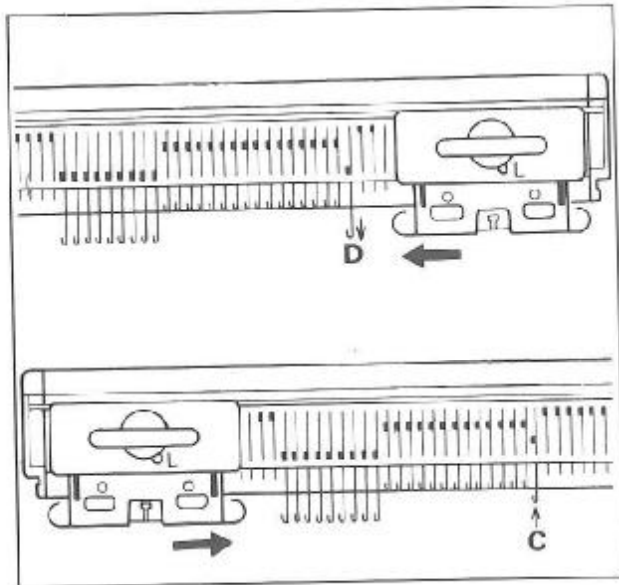

When partial knitting, set both Russel Levers to **I**, push one needle on opposite side of resting needles to D position to knit from right to left, and push back the needle to C position to knit from left to right.

# PLATTING

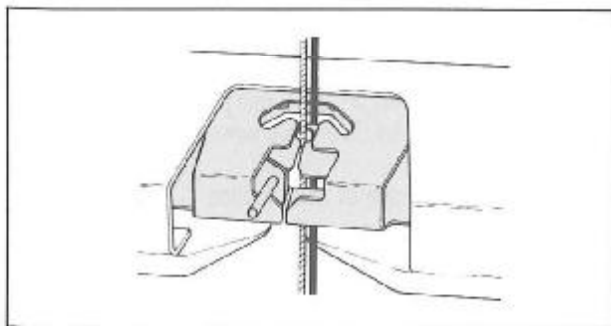
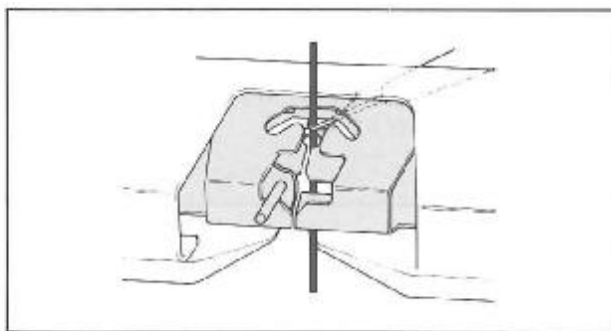
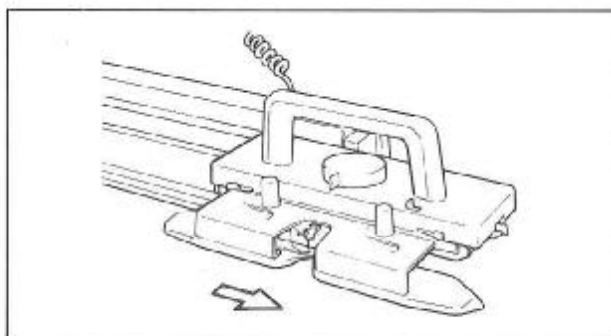
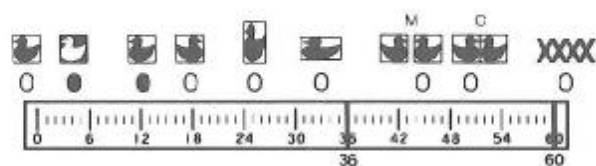

Two different colour yarns are knitted together. One yarn appears on one side whilst the second yarn appears on the other side of the knitting.

Plating can be knitted in Stockinet or Tuck Stitch.

The sample is knitted with the Pattern No.1-(12).

Before knitting this stitch pattern, follow the Preparatory Steps for Tuck Stitch, and the instructions given below.

## BEFORE KNITTING THE PATTERN

Use two thin yarns together for Plating.

The Stitch Dial must be set for the total of two thin yarns, as both yarns are knitted together. e.g. Refer to page 5.

If two type ③ Summer yarns are knitted together, the Stitch Dial should be set at 6 ~ 8.

Thread the Plating Yarn Feeder as follows.

1. Move the Carriage to the either end of the Needle Bed till the rear of the Yarn Feeder is visible.  
Open the Yarn Feeder gate.
2. Put the plating yarn into the Yarn Feeder ①, insert the Tappet Tool from the rear of the Yarn Feeder and catch the plating yarn, and pull it down behind Yarn Feeder ①. Tie the yarn end to the nearest clamp.
3. Set the main yarn in Yarn feeder ①.  
When the main yarn and the plating yarn are set in the Yarn Feeder properly, close the Yarn Feeder Gate.

*To knit Plating in Stockinet, set the controls as required in Stockinet knitting.*

## DRAWING A PATTERN ON THE DESIGN CARD

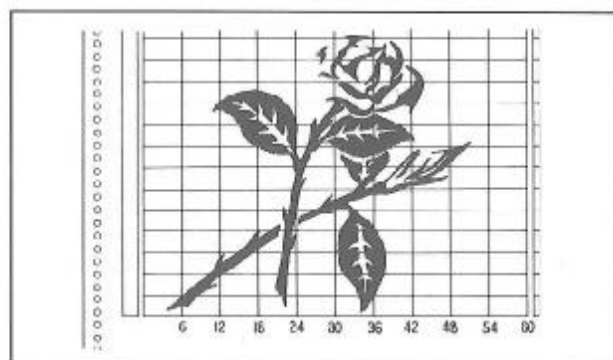
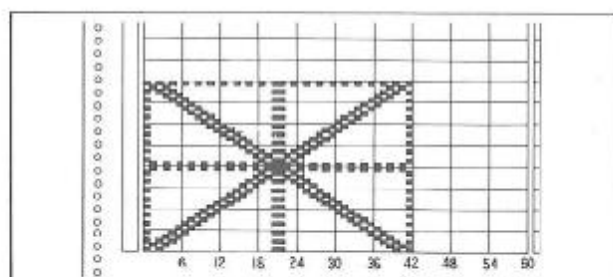
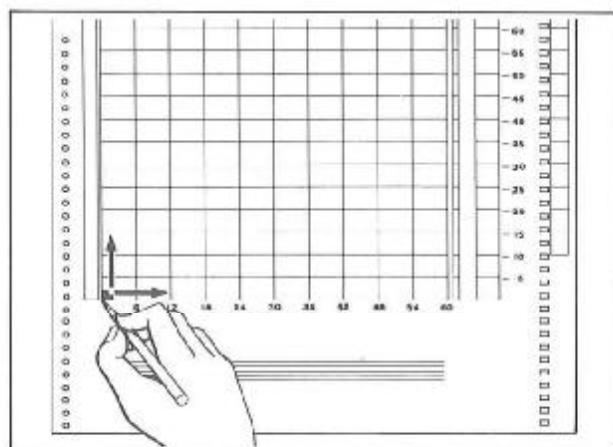

Draw your own pattern or trace a pattern from the pattern book onto the Design Card supplied with the Pattern Card set using a Design Pencil.

Fill up the sections neatly for the pattern taking the following precautions.

Start filling the sections from the bottom left corner.

Work on a solid hard surface.

Darkness of each section must be even.

To avoid failure in drawing, make a rough sketch and trace it onto the Design Card.

Incorrect drawing can be erased using a plastic eraser.

\* In a picture or a letter image, draw the entire area rather than section by section. (Three-star pencil is recommended.)

\* For geometric pattern, fill up sections one by one with care. (One-star pencil is recommended.)

*Take care when drawing a pattern design for the following type of knitting.*

**In Single Motif:**

*As the Pattern Switch-1 is used with its left light on, draw the area to be knitted in Single Motif.*

**In Tuck or Slip Stitch:**

*As the Pattern Switch-1 is used with its right light on, draw the area to be tucked or slipped.*

\* Don't soil the blank column on the left side of the Card.

**Buzzer Column and Instruction Columns**

Put marks to correspond with the first and end row of the pattern as shown below.

**Notation Columns**

Mark with an ordinary pencil at the rows to change the yarns or to change the settings for knitting.

In case of knitting in the same direction continuously

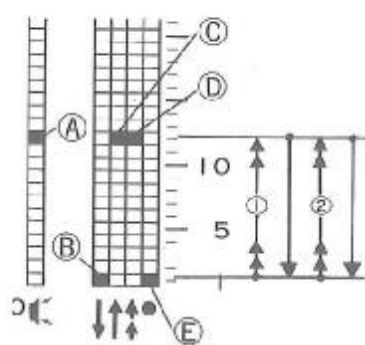

In case of knitting in both directions row by row

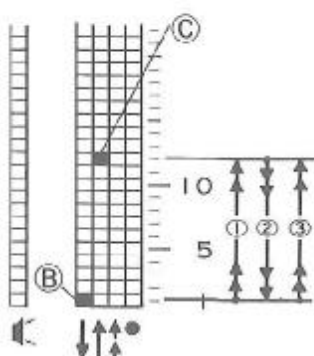

**Markings on each column**

- (A) Mark for colour change, or to alter machine settings.
- (B) Moves the Card downwards.
- (C) Changes the feeding direction. (The Card is fed upwards.)
- (D) Actuates quick motion.
- (E) Stops quick motion.

## TO USE THE LACE CARRIAGE

### CONTENTS

	page
LACE CARRIAGE .....	43
SETTING THE LACE CARRIAGE ON THE NEEDLE BED .....	44
CAM LEVER AND STITCH DIAL .....	45
CAST-ON AND STOCKINET KNITTING —on the Lace Carriage— .....	46
PATTERN KNITTING WITH LACE CARRIAGE .....	50
PLAIN LACE .....	52
FASHION LACE .....	53
SECTIONAL PATTERNING .....	55

*The Lace Carriage is available as an optional accessory.*

# LACE CARRIAGE

## LACE CARRIAGE

- 1 Curl Cord Socket
- 2 Handle
- 3 Stitch Dial
- 4 Release Lever
- 5 Lace Arm
- 6 Arm Nut
- 7 Cam Lever
- 8 Yam Feeder

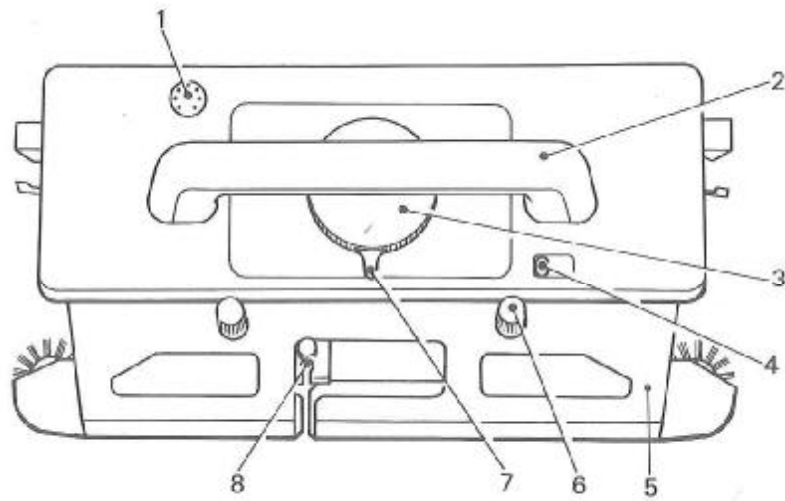

## ACCESSORIES

- 1 Wide Claw Weight (3)
- 2 Lace Pattern Card (5)

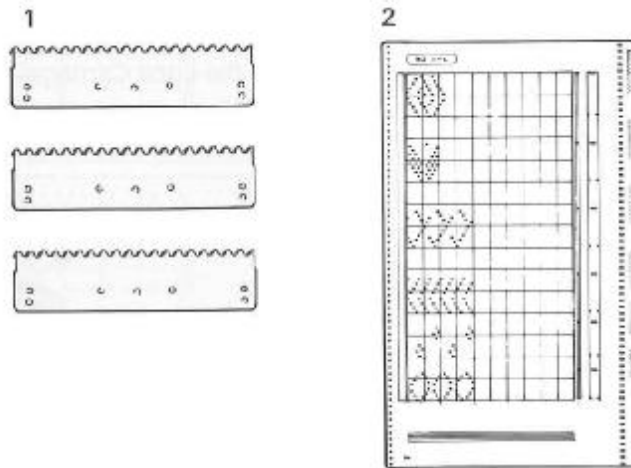

### IMPORTANT:

*Do not use the Lace Arm on the standard Carriage, or the standard Arm on the Lace Carriage. This will result in damage to the Arm or the needles.*

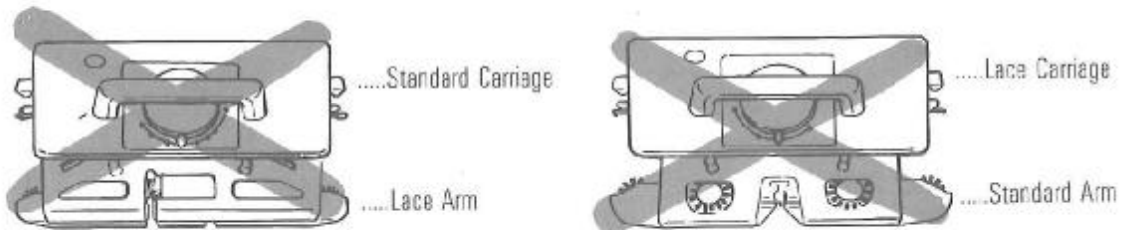



## SETTING THE LACE CARRIAGE ON THE NEEDLE BED

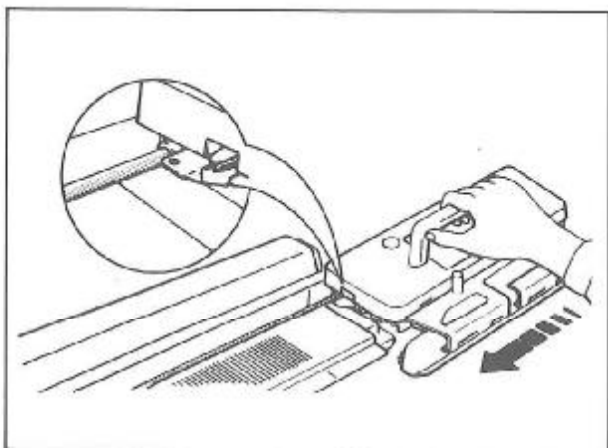

Switch "OFF" the Pattern Controller, disconnect the Curl Cord from the standard Carriage, Remove the standard Carriage from the Needle Bed. Take out the Lace Carriage with Lace Arm attached from the box, raise the Handle and set it on the Needle Bed as shown.

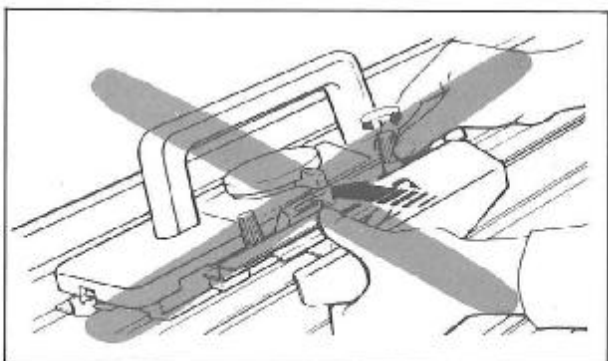

IF THE RIBBER HAS ALREADY BEEN CONNECTED WITH THE KNITTER, follow the instructions given below to use the Lace Carriage on the Knitter.

- DO NOT attach the Ribber Arm to the Lace Carriage.

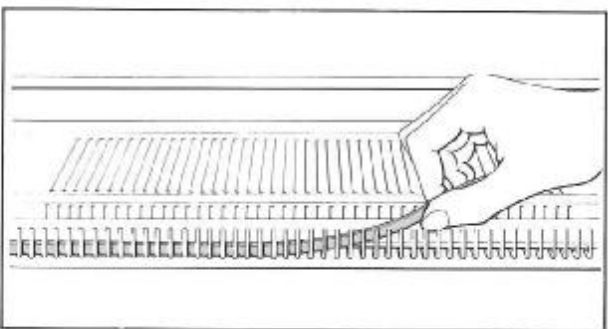

- Set the Ribber at the lowest position and remove the Close Knit Bar from the Knitter Needle Bed if it is in use.

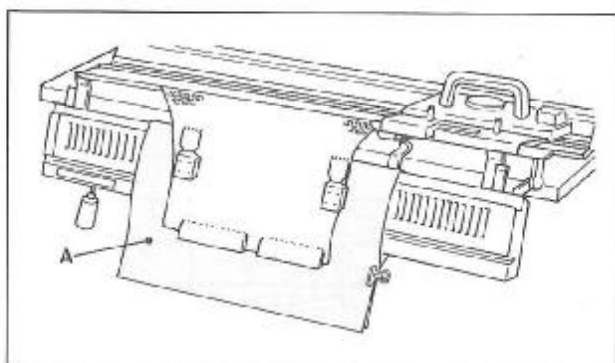

- With paper or cloth "A", cover the Ribber needles and sinker posts and bring the knitting in front of the Ribber. (Plastic Ribber Needle Bed Covers are available as an optional accessory.)

## CAM LEVER AND STITCH DIAL

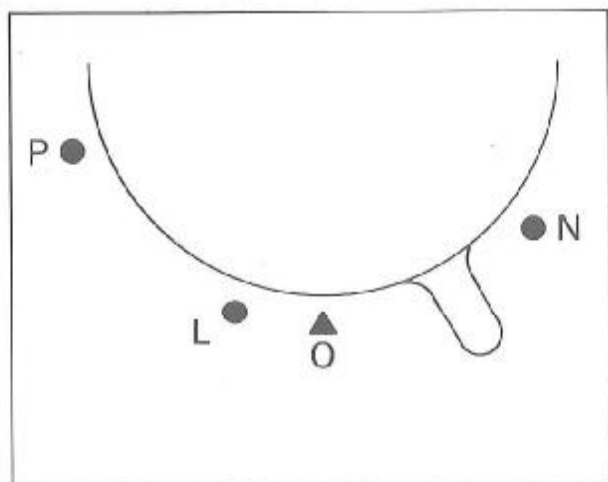

### The Cam Lever has four positions

- N** — (NON-KNITTING)  
used to pass the Carriage without knitting over the needles in B position.
- O** — (STOCKINET)  
used to knit in Stockinet only.  
(No Pattern Card is used.)
- L** — (PLAIN LACE)  
used to knit Plain Lace patterns.  
(Pattern Card must be used.)
- P** — (FASHION LACE)  
used to knit Fashion Lace patterns.  
(Pattern Card must be used.)

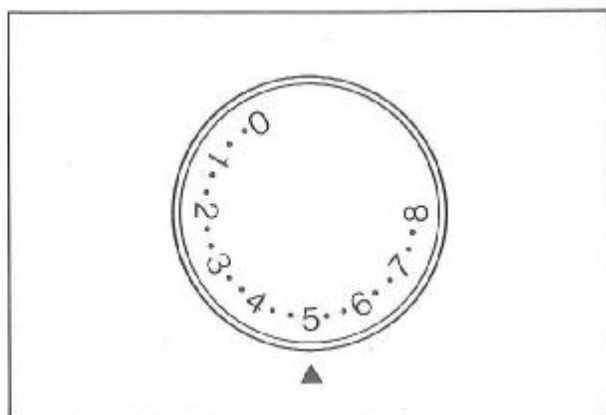

### Stitch Dial

Stitch Dial for the Lace Carriage is numbered 0 ~ 8. Each dot represents a different tension, giving 25 settings in all.

The selected number of the Stitch Dial must be set at ▲ mark.

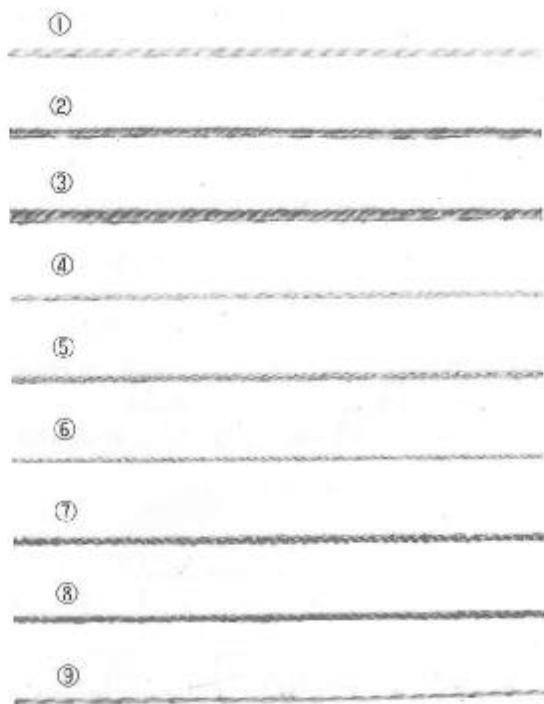

### TYPE OF YARN AND RECOMMENDED STITCH DIAL SETTING

Recommended types of yarns are shown opposite in actual size, and recommended Stitch Dial settings are shown in the table below.

*Do not use very heavily textured or thick mohair yarn for the lace patterns.*

Type of yarn	Stitch Dial (Stockinet)	Stitch Dial (lace knitting)
① Thin yarn (2-ply)	2 ~ 3	3 ~ 4
② Light yarn (3 ply)	3 ~ 5	4 ~ 5
③ Medium yarn (4-ply)	4 ~ 6	5 ~ 6
④ Cotton thread (thin)	3 ~ 4	4 ~ 5
⑤ Cotton thread (regular)	4 ~ 5	5 ~ 6
⑥ Synthetic (thin)	2 ~ 3	3 ~ 4
⑦ Synthetic (regular)	3 ~ 4	4 ~ 5
⑧ Synthetic (regular)	3 ~ 4	4 ~ 5
⑨ Mohair (thin)	3 ~ 5	4 ~ 5

## CAST-ON AND STOCKINET KNITTING—on the Lace Carriage—

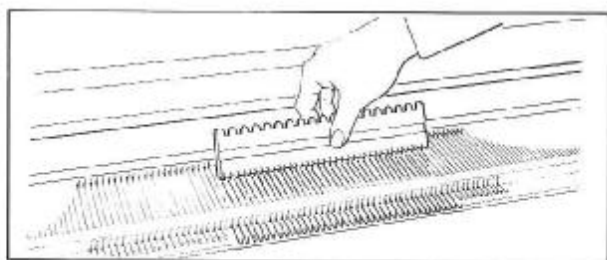

*Needles must never be pushed to D or C position while the Lace Carriage is in use.*

Using the Needle Pusher, push 70 needles (35 needles on both sides of the centre(0) ) to B position.

To knit in Stockinet using the Lace Carriage, the Pattern Controller does not need to be switched on.

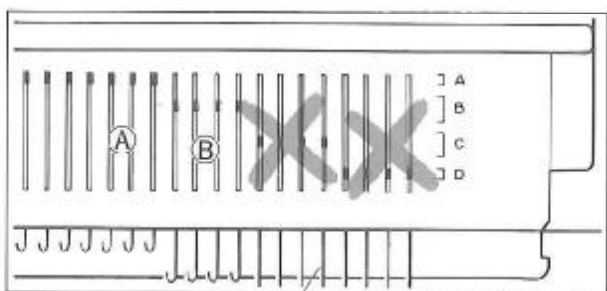

### IMPORTANT

When you knit with the Lace Carriage, the needles must be aligned in B position only. A position is used for holding stitches.

*Do not push the needles to C or D position. This will damage the needles.*

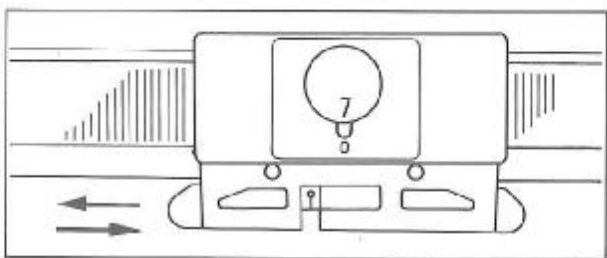

Set the Carriage as follows and move it twice across the needles to align them correctly in B position. Finish with the Carriage at the right.

Stitch Dial..... 7  
Cam Lever..... **O** (STOCKINET)

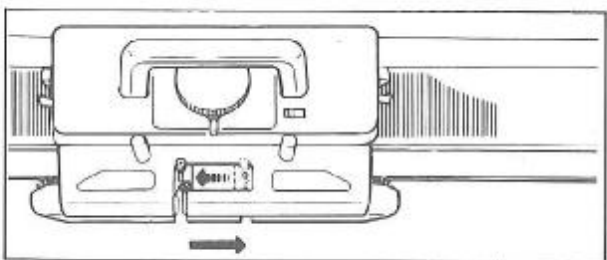

The Yarn Feeder moves during knitting. After aligning needles, check that the Yarn Feeder is at the left side. If it is not, move the Carriage a little more to the right.

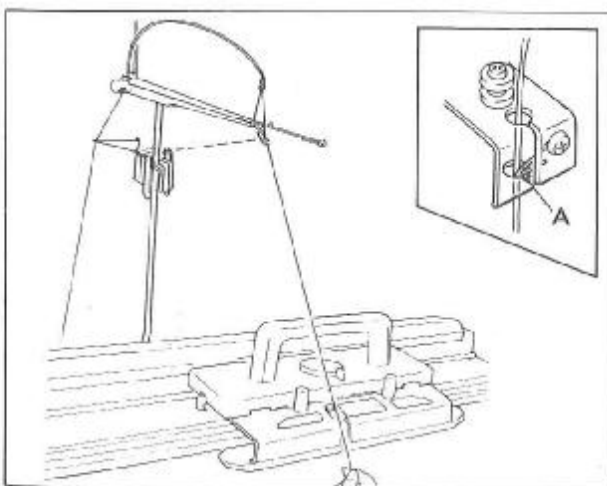

Thread the yarn through the Auto-Tension and into the Yarn Feeder.

The yarn must be correctly set behind the Guide Pin "A" in the Yarn Feeder.

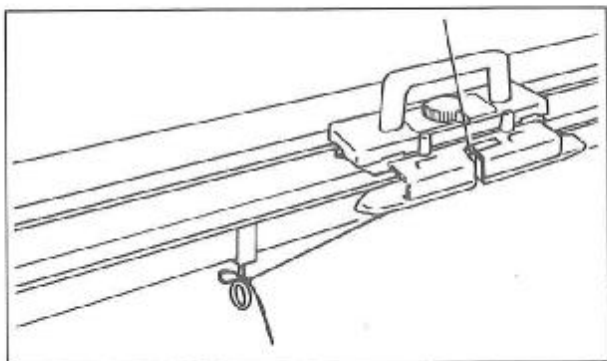

Fasten the yarn end to the nearest Clamp.

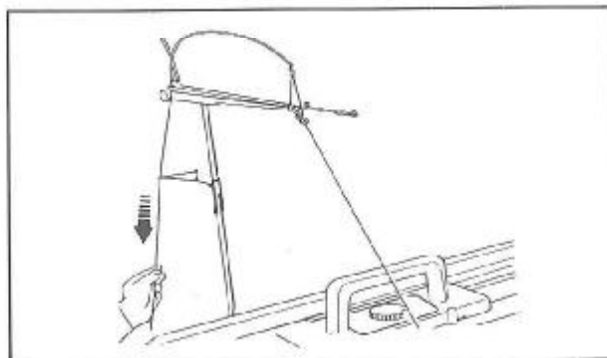

Take up the slack by pulling the yarn back from behind the Yarn Rod till the Tension Spring is almost horizontal.

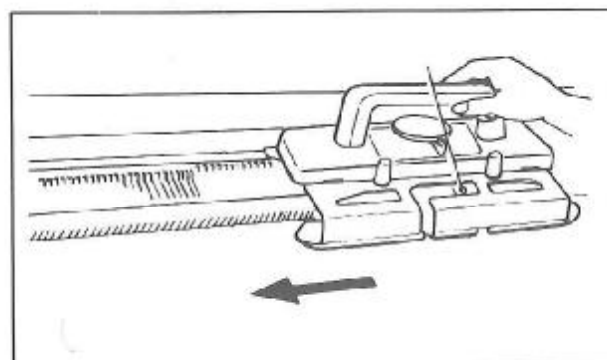

Move the Carriage across the needles in B position.

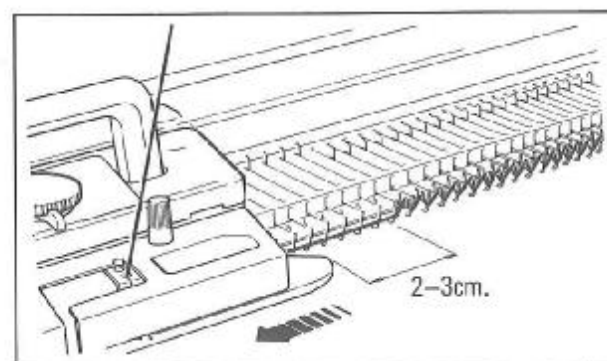

Take the Carriage past the end needle by 2 ~ 3cm.

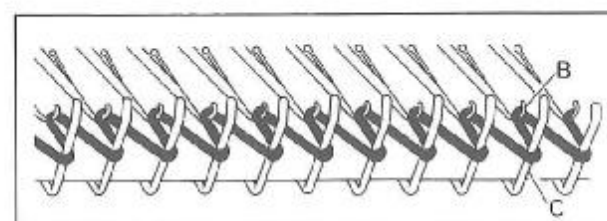

Open loops have been formed between the needle hooks "B" and the sinker posts "C".

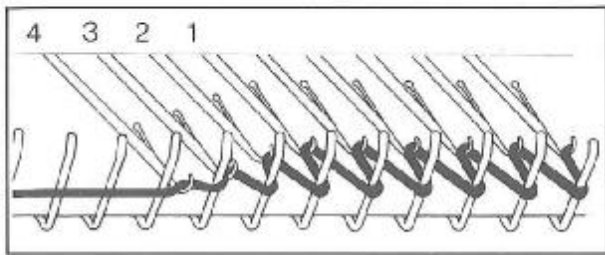

Sometimes the last 2 or 3 needles of this first row are pulled forwards a bit by the yarn. To achieve a successful cast on, these smaller loops must be increased in size.

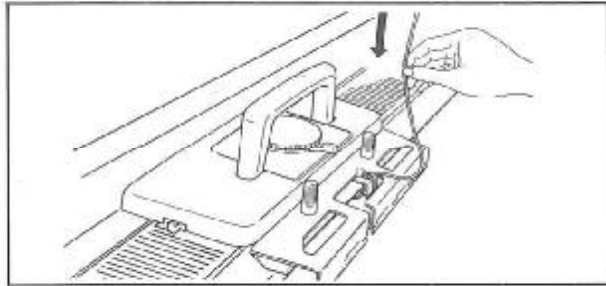

To correct, hold the yarn above the Yarn Feeder and pull it down to allow some slack.

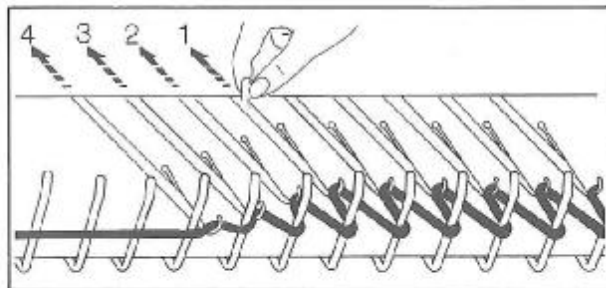

Starting with needle "1", push the needles with small loops one by one back to B position.

**Hint:** To eliminate the irregular hooking of the yarn at the end of the cast-on row, pull down the yarn slightly from the Tension-Spring with your hand before the Carriage completes the cast-on row.

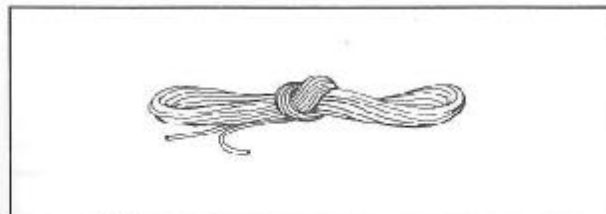

Take out the Ravel Cord from the Accessory Box, and untie it. Place one end of the Ravel Cord in the yarn clip at the end of the Needle Bed, and lay the Ravel Cord across the yarn loops between needle hooks and sinker posts.

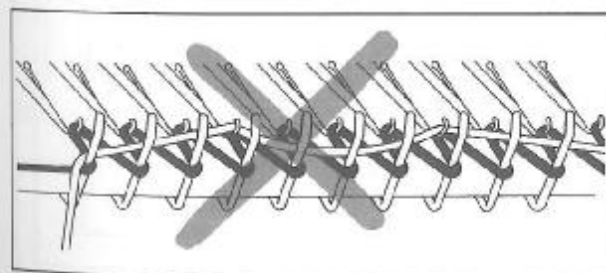
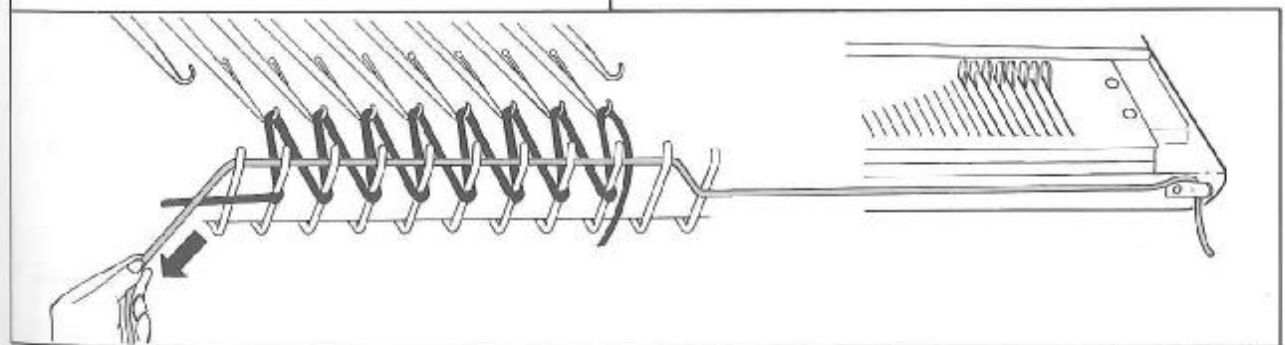

*If the Ravel Cord is caught on the needle hook, the cast-on will not work correctly.*

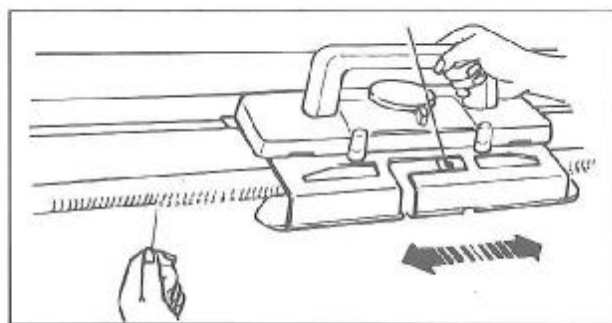

Pulling down the Ravel Cord tightly, move the Carriage slowly to the other side, passed the end needle by 2 ~ 3cm. Then continue to move the Carriage to and fro several times.

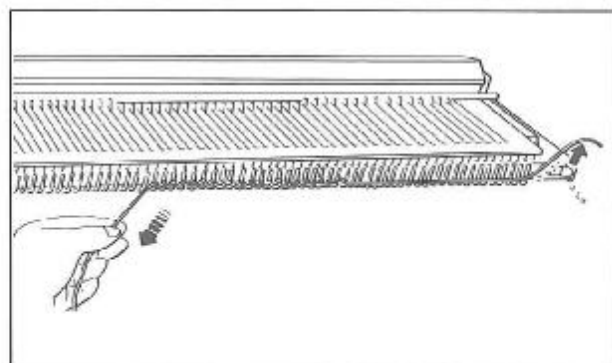

Release the end of the Ravel Cord from the Yarn Clip, and pull it out from the other end.

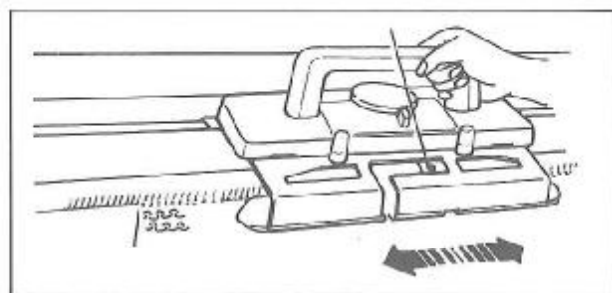

Cast-on (open edge) is completed. Continue to knit about 30 rows by moving the Carriage back and forth.

Hang the Claw Weights on both sides of the knitting.

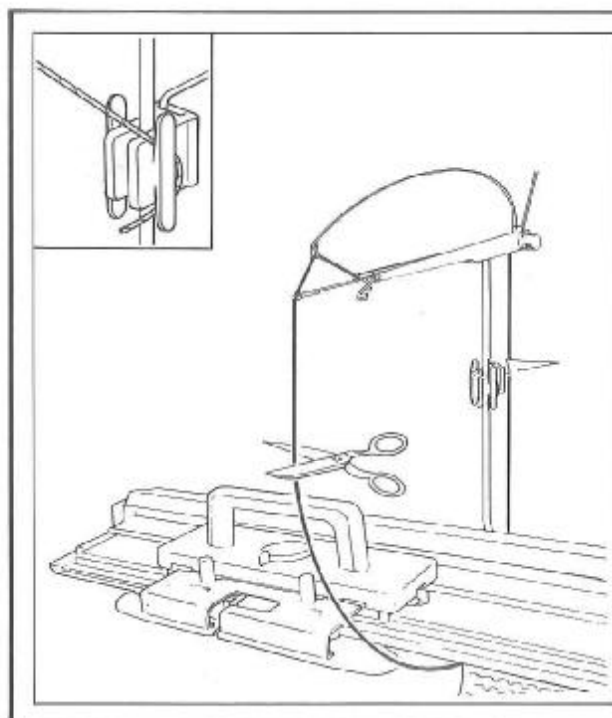

#### REMOVING THE KNITTING FROM THE MACHINE

Take out the yarn from the Yarn Feeder, and cut it above the Carriage.

Set the Cam Lever to **○** mark, and move it across the needle. The knitting will be released from the needles.

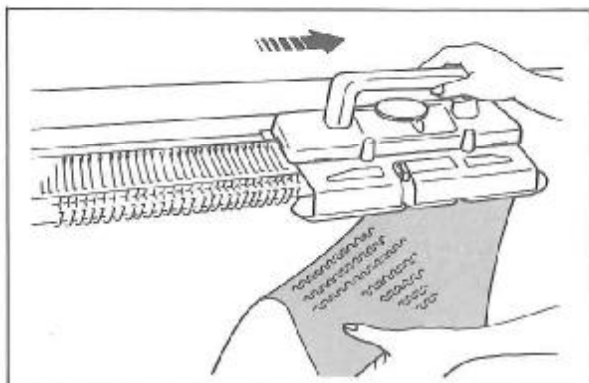

# PATTERN KNITTING WITH LACE CARRIAGE

Five sheets of Pattern Cards, containing 70 patterns in total, for lace patterns are packed with the Lace Carriage.

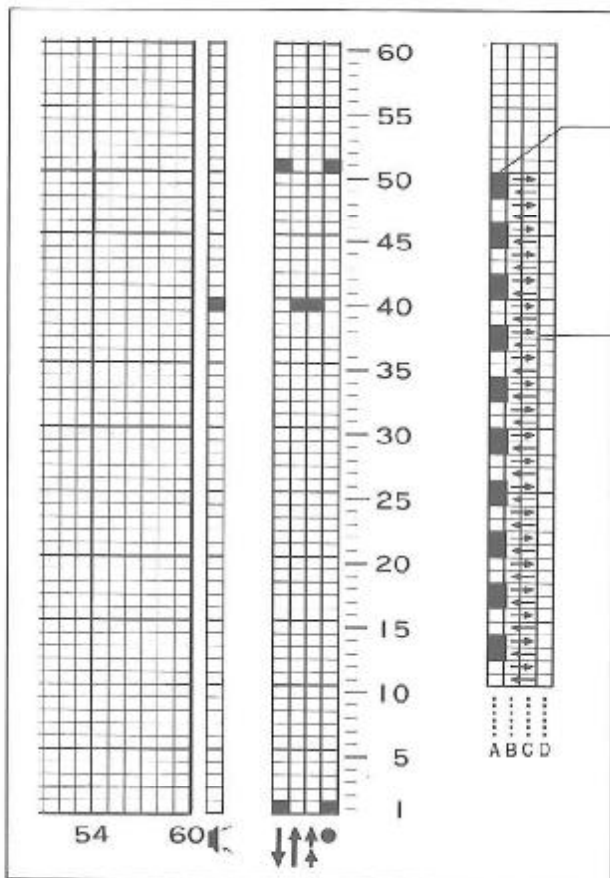

The Pattern Cards for the lace patterns have the following additional marks on them.

## FASHION LACE ROWS

On these rows, the Carriage transfers stitches only, and does not knit.

## KNITTING DIRECTION MARK

The arrows on the right of the Pattern Card show the direction in which you should next move the Carriage.

*In lace patterns, the needles corresponding with the black area of the Pattern Card are selected and their stitches are transferred onto adjacent needles.*

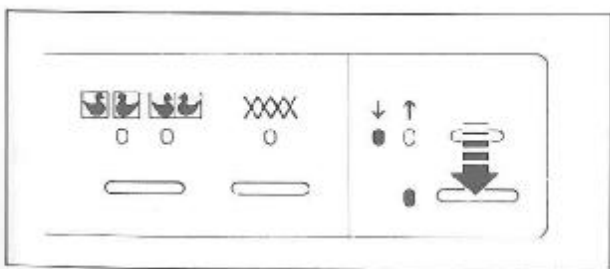

## PREPARATORY STEPS FOR LACE KNITTING

Connect the Curl Cord to the Lace Carriage.

Switch "ON" the Pattern Controller, and press "ON" the Inspection Switch. (light on)

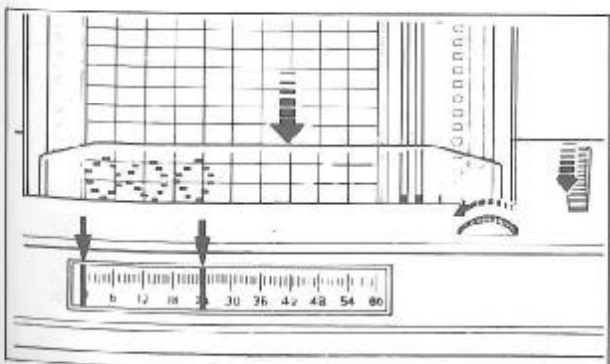

Set the Pattern Card, and set the Pattern Width Indicator.

*The right red pointer of the Pattern Width Indicator must correspond with the  $\Delta$  mark given for the selected pattern.*



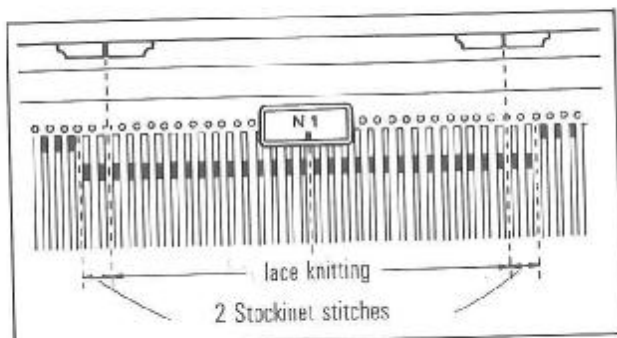

Align the needles in B position.  
 Set the Needle-1 Cam.  
 Set the Point Cams 2 needles in from the edge of the knitting, so that edge stitches will not be transferred.

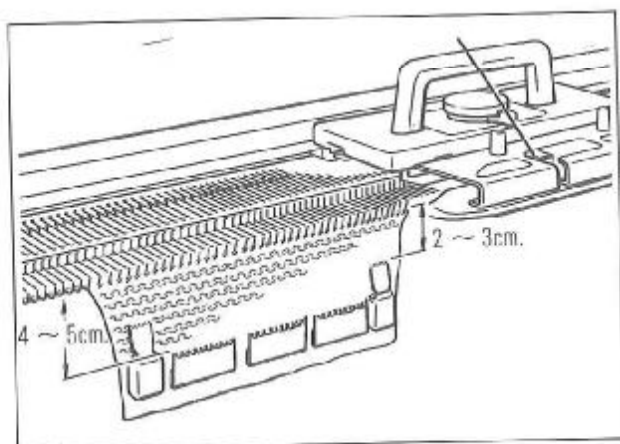

Set the Carriage controls.  
 Cam lever.....  (STOCKINET)  
 Stitch Dial..... (refer to page 45)  
 Cast on using the Ravel Cord and continue to knit in Stockinet for about 30 rows ending at the right side of the knitting.

Hang the Claw Weights, and the Wide Claw Weights on them as shown.  
 If knitting is already in progress, set the Cam lever to **N**, and pass the Carriage over the working needles twice to memorize the positions of Point Cams and Needle-1 Cam.  
 Make sure that the left lights of Pattern Switches 1 and 2 are ON.

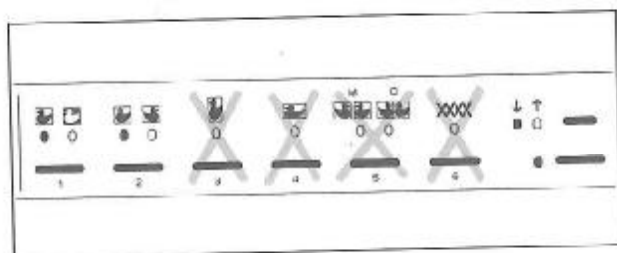

*All the lights of Switches 3, 4, 5 and 6 must be OFF.*

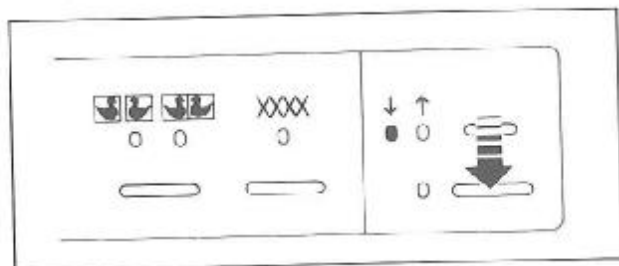

Press "OFF" the Inspection Switch. (light off)

PREPARATORY STEPS FOR KNITTING LACE PATTERN HAVE BEEN COMPLETED.  
 YOU ARE READY TO KNIT THE LACE PATTERNS.

**IMPORTANT TO NOTE:**

- When knitting in lace patterns, the left lights of Pattern Switches 1 and 2 are ON and the other lights must be OFF.
- Set the Point Cams to exclude two working needles at both edges.
- Be sure to have the Carriage at the right side of the working needles before starting to knit lace patterns, to correspond with the knitting direction arrow marks on the Pattern Card.

# PLAIN LACE

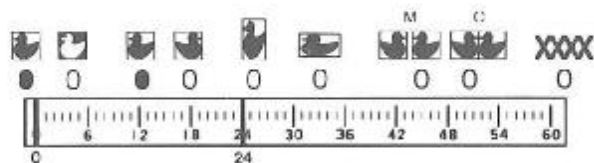
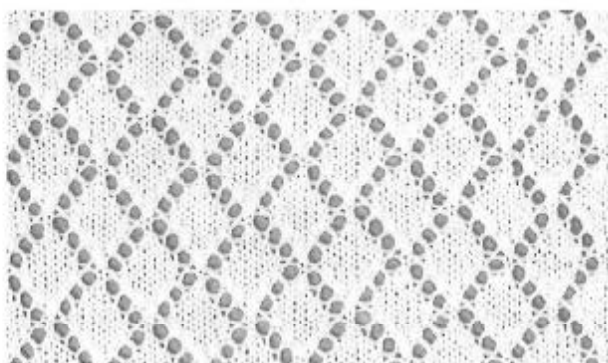

Plain Lace is transfer lace knitted with the Lace Carriage fully automatically. The Carriage transfers stitches and knits in a single movement.

The sample is knitted with the Pattern No. 1-L-(1).

Patterns L-(1) to L-(14) are the Plain Lace patterns, on Cards 1-L, 2-L, 3-L and (for pattern 14 only) 4-L.

Following the Preparatory Steps given on pages 50 ~ 51, prepare for knitting the lace pattern, finish with the Carriage at the right side of the working needles.

## BEFORE KNITTING THE PATTERN

### Set the Carriage controls.

Cam Lever..... L  
Stitch Dial..... refer to page 45.

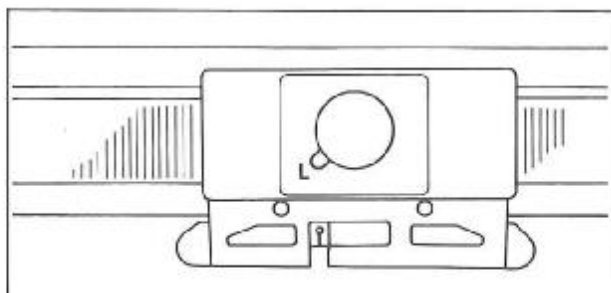

## WHILE KNITTING THE PATTERN

Knit slowly and at an even speed following the arrow direction mark given on the Pattern Card.

*If the direction of the Carriage does not correspond with the arrow marks, the lace pattern will be knitted incorrectly.*

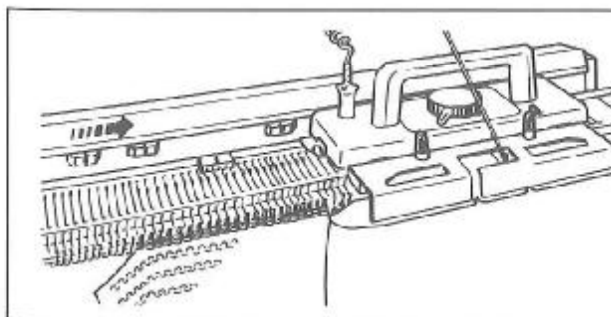
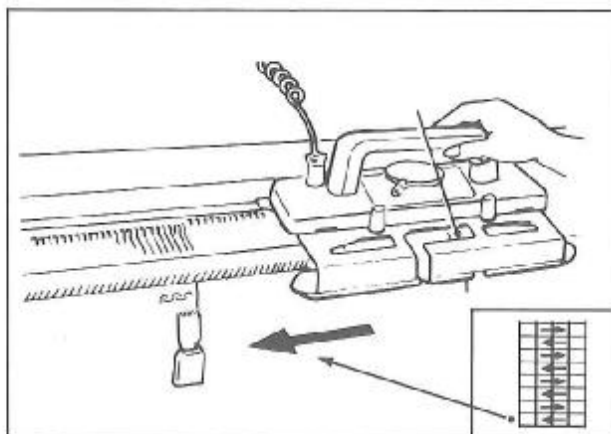

In lace knitting, all shaping must be done on the side opposite to the Carriage. The Point Cam must be moved to its new position (2 stitches in from the edge of the knitting) before knitting the next row.

# FASHION LACE

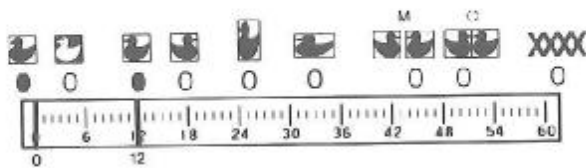
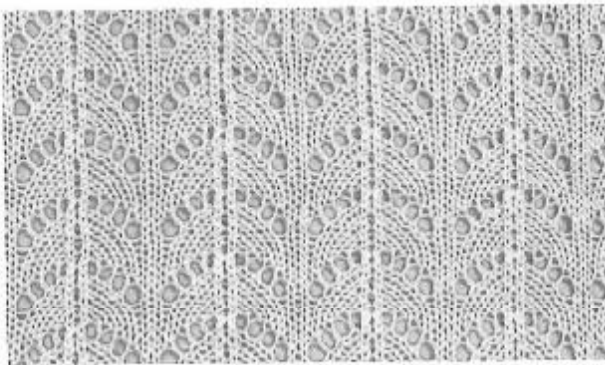

Fashion Lace is transfer lace knitted with the Lace Carriage but in two stages. Stage 1 is multiple stitch transfers without yarn and Stage 2 is two or more knitted rows with yarn.

The sample is knitted with the Pattern No.4-L-(15).

Following the Preparatory Steps given on pages 50 ~ 51, prepare for knitting lace patterns.

Before starting pattern, have the Carriage at the right side of the working needles.

## BEFORE KNITTING THE PATTERN

Set the Stitch Dial to a suitable number for knitting the yarn you have chosen, referring to page 45.

## WHILE KNITTING THE PATTERN

For the pattern rows corresponding with the white rows in the Notation Column, knit with the Cam Lever set at "L" and with yarn in the Yarn Feeder.

When the yarn is replaced in the Yarn Feeder, set it behind the Guide Pin correctly, and pull up the slack on the yarn at the back of the Yarn Rod.

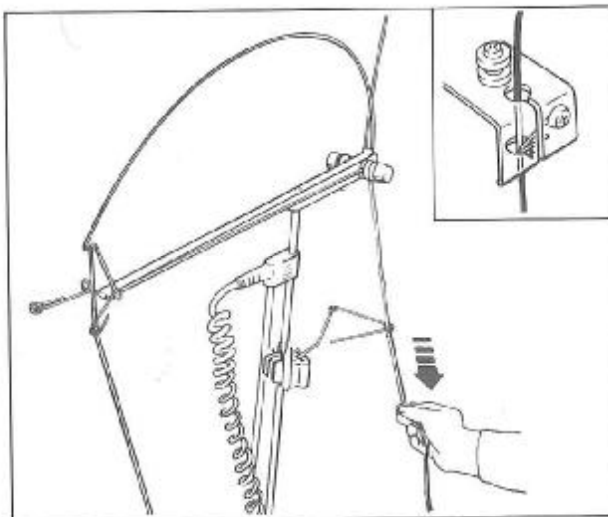
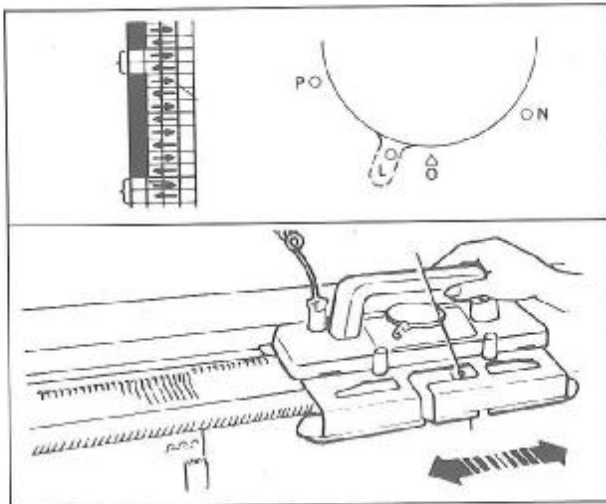

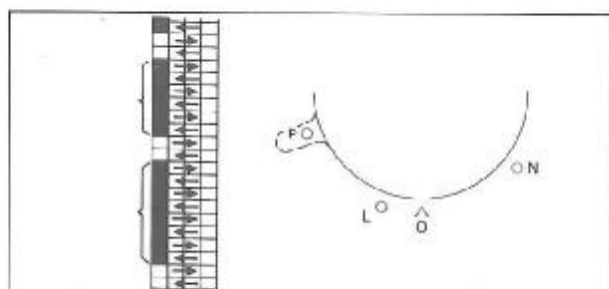

For the pattern rows corresponding with the black marks in the Notation Column, move the Carriage back and forth with the Cam Lever set at "P", and without yarn in the Yarn Feeder.

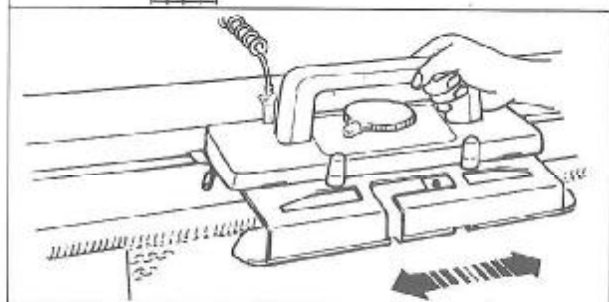

Selected stitches are transferred onto their adjacent needles, and Row Counter will not move while transferring stitches is in progress. No stitches are knitted during this procedure.

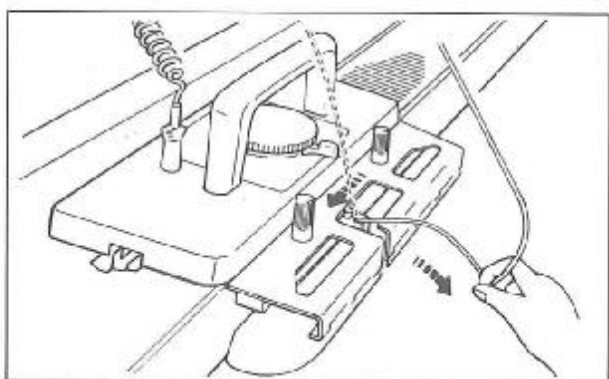

When the black mark in the Notation Column shows above the Card Slot, remove the yarn from the Yarn Feeder. The Carriage should be at the right side.

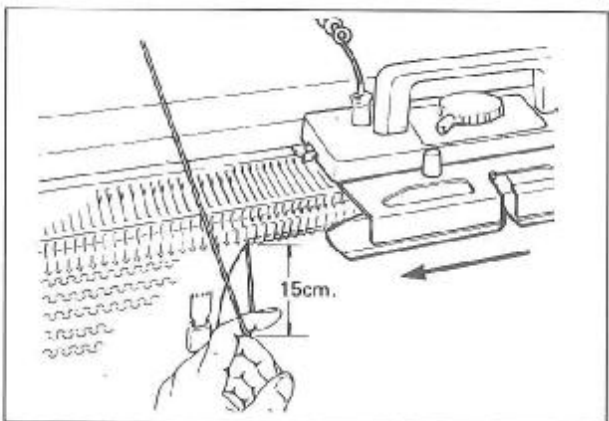

The yarn removed from the Yarn Feeder must be held away from the Arm to prevent it becoming tangled.

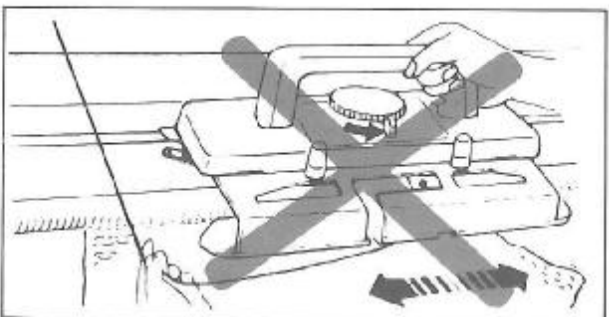

When the yarn is removed from the Yarn Feeder, DO NOT move the Carriage with the Cam Lever set at "L" or "O", as the knitting will be released from the needles.

## SECTIONAL PATTERNING

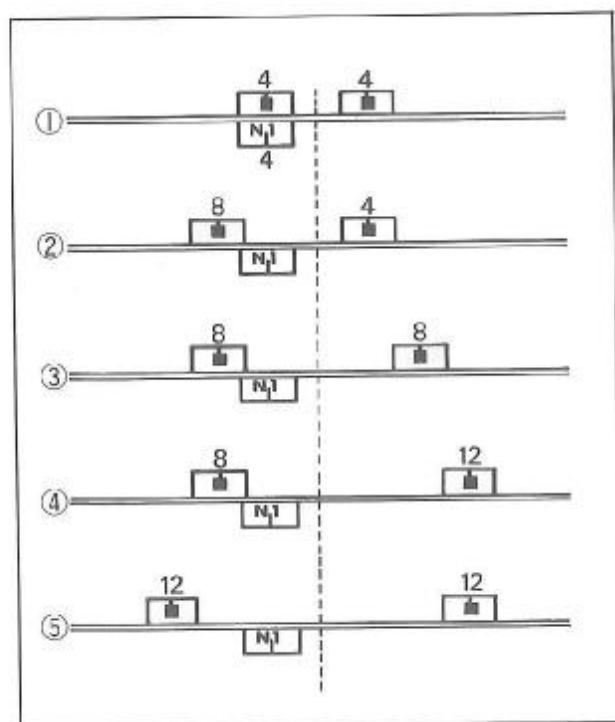
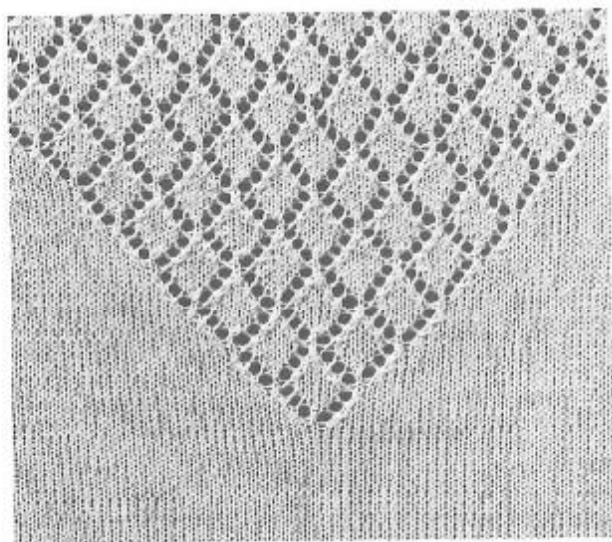

By changing the positions of the Point Cams, Single Motif or sectional patterning can be worked in Plain Lace.

The sample is knitted with the Pattern No.1-L-11).

### Pattern row number 1 ~ 6

Set the Point Cams and Needle-1 Cam as shown opposite in diagram ①. With the Cam Lever at "L", and starting from the right side, knit 6 rows.

Move the left Point Cam four needles to the left. (diagram ②)

### Pattern row number 7

Knit 1 row from right to left.

Move the right Point Cam four needles to the right. (diagram ③)

### Pattern row number 8 ~ 13

Knit 6 rows.

Move the right Point Cam (again) four needles to the right. (diagram ④)

### Pattern row number 14

Knit 1 row.

(Pattern Card moves back to the row 1.)

Move the left Point Cam four needles to the left. (diagram ⑤)

### Pattern row number 1 ~ 6

Knit 6 rows.

Change the position of the Point Cam.

Repeat the above steps, using the same principle.

By changing the position of the Point Cams, the pattern section can be increased in size. Only move the Point Cam at the side opposite the Carriage.

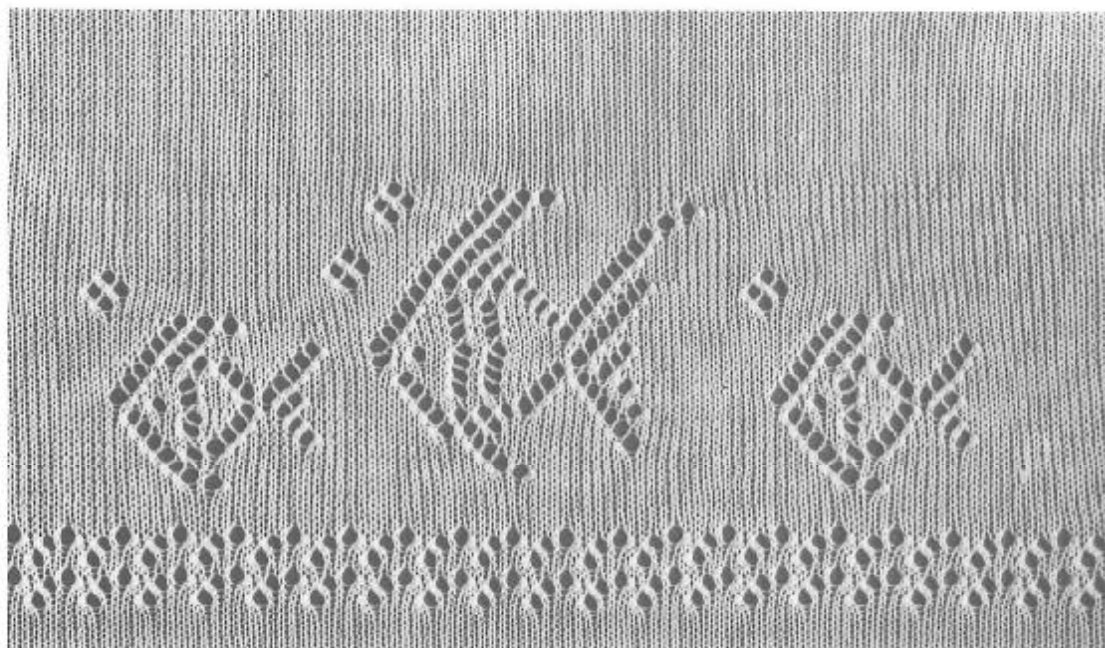

The sample is knitted with the Pattern No.3-L-(11).

**Pattern row number 1 ~ 11**

Set the Point Cams and the Needle-1 Cam as shown opposite. Set Point Cams two needles in from the edge of the knitting. Knit with the Cam Lever at "L".

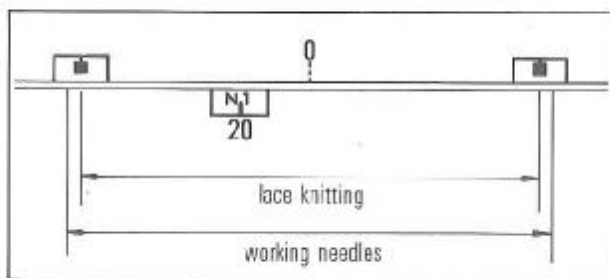

**Pattern row number 12 ~ 68**

Change the position for the Point Cams and the Needle-1 Cam as shown opposite and continue to knit in the same Cam Lever setting.

(It is not necessary to move the Carriage without knitting to memorize the new position, because there are 7 rows Stockinet before the lace pattern begins again.)

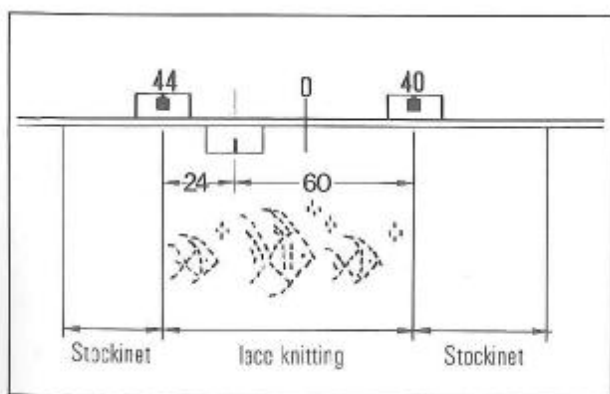

*When the Pattern Card has returned to the first row, set the Cam Lever to "O", and continue in Stockinet.*



# TO USE THE RIBBER, SRP 60N

## CONTENTS

	page
OPERATION TABLE .....	58
CAST-ON AND KNITTING .....	61
CAST-ON FOR TIGHTER EDGE .....	67
REMOVE THE KNITTING FROM THE MACHINE .....	68
VARIOUS RIB STITCHES .....	69
Rib stitches without using Pattern Card .....	69
K1.P1. RIB .....	69
DOUBLE RIB .....	69
K2.P2. RIB .....	70
WIDE RIB .....	71
ENGLISH RIB .....	72
SWUNG ENGLISH RIB .....	72
VARIATION OF ENGLISH RIB .....	73
DOUBLE ENGLISH RIB .....	74
TUBULAR KNITTING .....	74
HERRINGBONE SWING .....	75
VARIATION SWING .....	76
PIN TUCK .....	78
PICK RIB .....	79
SWUNG PICK RIB .....	80
PLATTING RIB .....	81
Rib stitches using Pattern Card .....	83
PIN TUCK .....	83
TUCK RIB .....	85
DRIVE LACE .....	86
PILE KNITTING .....	89
SHADOW LACE .....	94
DOUBLE JACQUARD .....	95
DOUBLE FACE KNITTING .....	97
MULTI COLOURED JACQUARD .....	100

**NOTE:**

*For the explanations of MACHINE AND ACCESSORIES, SETTING THE RIBBER ON THE KNITTER, RIBBER NEEDLE BED, RIBBER CARRIAGE, RIBBER ARM, P CARRIAGE, YARN AND STITCH DIALS, KNITTING TECHNIQUES, WHAT TO DO IF... and REPACKING THE RIBBER, please refer to pages 1 ~ 12, 15, 55 ~ 72 and 74 of SRP60N Instruction Book.*

# OPERATION TABLE

For cast-on and main knitting, Operation Table shown below gives settings and operation of machine.

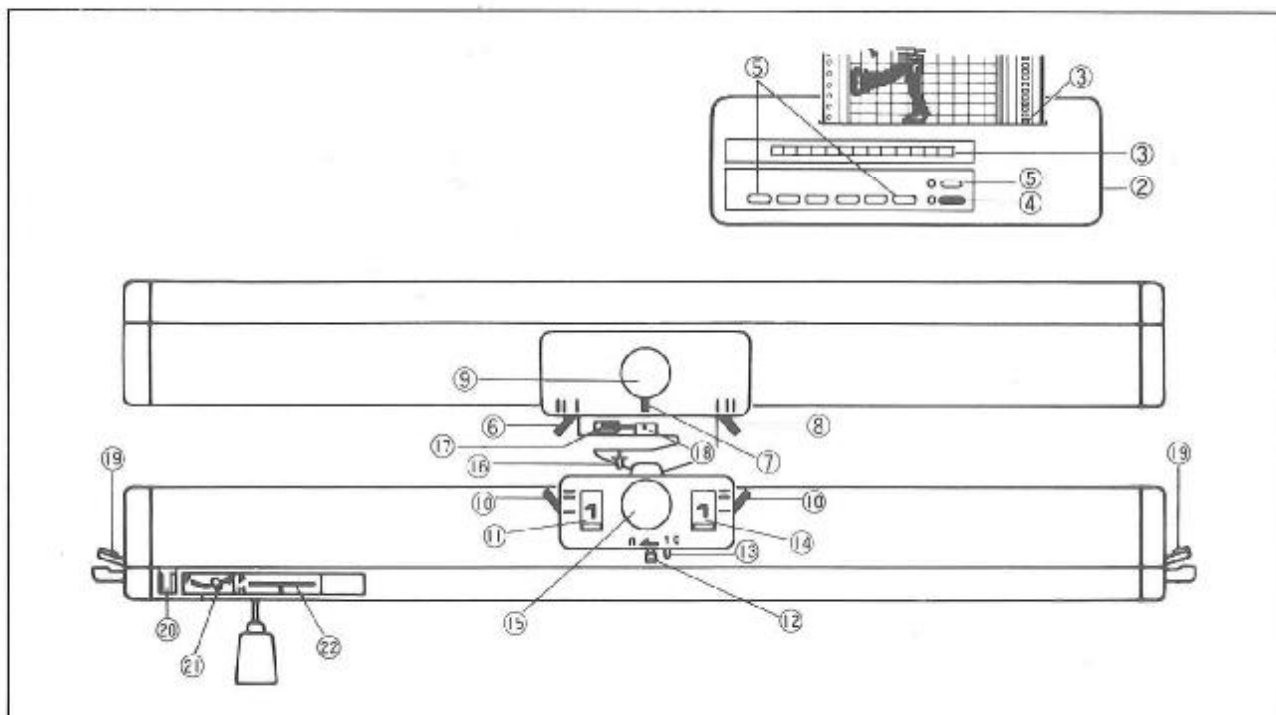

	①	Procedural Order of Operation Table	
	②	DN-OFF Switch	■ — Turn ON the machine
PATTERN CONTROLLER	③	Pattern Card & Pattern Width Indicator	↓ — Set the Pattern Card and Pattern Width
	④	Inspection Switch	● — Light is ON ○ — Light is OFF
	⑤	Pattern Switches & Direction Switch	Set the Pattern Switches and Direction Switch.
KNITTER CARRIAGE	⑥	Russel Lever (left)	
	⑦	Cam Lever	<b>O</b> — Stockinet <b>T</b> — Tuck <b>E</b> — English Rib <b>C</b> — Circular Knitting <b>S</b> — Slip Never set to <b>F</b> (Fair Isle), <b>L</b> (Punch Lace) and <b>W</b> (Weaving) while the Ribber Arm is used.
	⑧	Russel Lever (right)	
	⑨	Stitch Dial	Refer to table on page 15 in SRPGON Instruction Book.

RIBBER CARRIAGE	⑩	Russel Levers (left & right)	Except when partial knitting set Russel Levers at =.
	⑪	Set Lever (left)	
	⑫	Pick Knob	
	⑬	Auto-set Lever	
	⑭	Set Lever (right)	
	⑮	Stitch Dial	Refer to table on page 15 in SRP60N Instruction Book.
RIBBER ARM	⑯	Auxiliary Yarn Feeder Lever	
	⑰	Driving Lever	→ — resting position ↑ — working position
	⑱	Yarn Feeder	Except when Platting Rib use Main Yarn Feeder.
RIBBER NEEDLE BED	⑲	Pile Levers (left & right)	↑ — upper position ↓ — lower position
	⑳	Driving Cam	Install Driving Cam only for Pick Rib and Double Face Knitting. —
	㉑	Half-Pitch Lever	
	㉒	Swing Indicator	
	㉓	Arrow mark indicates knitting direction of Carriage and number shows the number of rows required to be knit.	

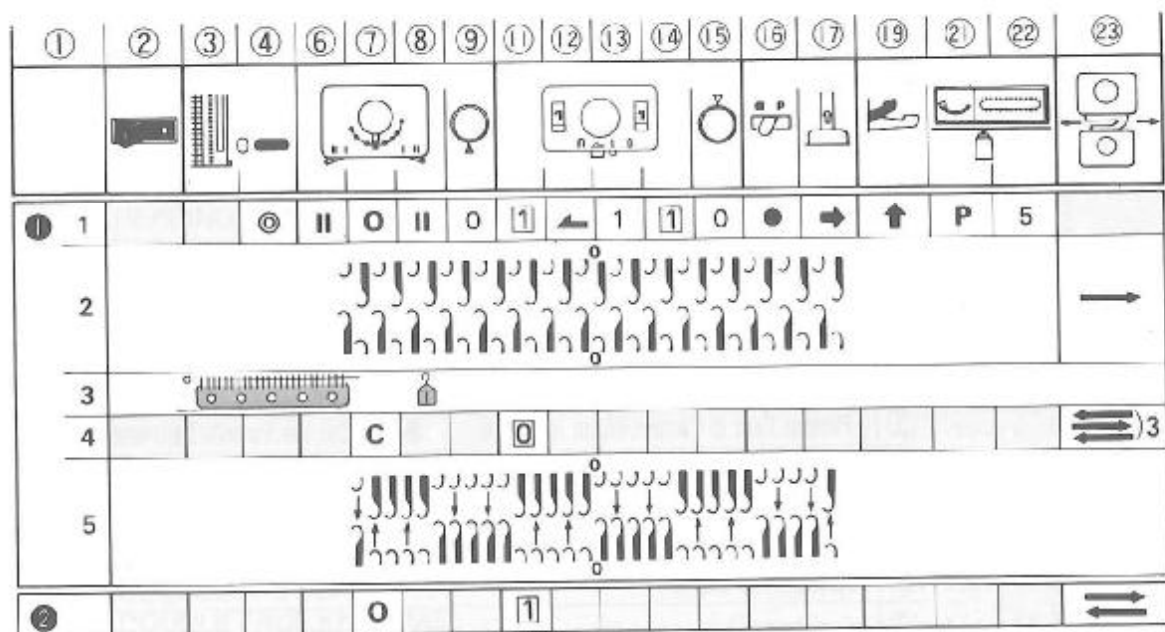

CAST-ON	①	1	Set machine controls for the initial row.
		2	Arrange needles for knitting the initial row. (Set the Point Cams and Needle-1 Cam when the Pattern Card is in use.)
		3	Suspend Cast on Comb with weights.
		4	Change machine controls for knitting subsequent 3 rows.
		5	Rearrange needles for main knitting by transferring stitches. (Not necessary if needle arrangement for main knitting is the same as for cast-on.)
MAIN KNITTING	②		Re-set machine controls for working main knitting. Follow the sequence 1, 2... and repeat the same.

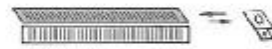
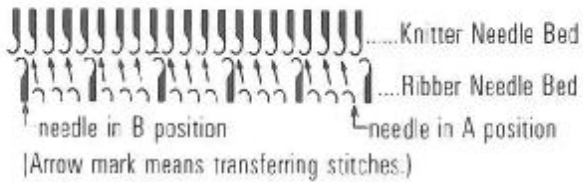

Move P Carriage without P Presser on Knitter to the left and back.



Move P Carriage without P Presser on Ribber to the right.



Move P Carriage with P Presser on Knitter to the left and back.



Move P Carriage with P Presser on Ribber to the right.

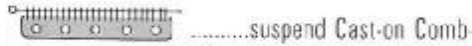

hook weights onto Cast-on Comb

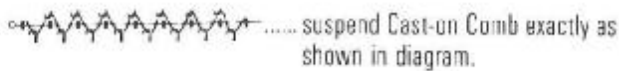

.....If the diagram shown is given beside the needle arrangement diagram in the Operation Table, set the Point Cams and Needle-1 in the same step.

# CAST-ON AND KNITTING

Following the Operation Table, cast-on and knit Double Rib without using the Pattern Card.  
For the rib stitches without the Pattern Card except PIN TUCK, it is not necessary to switch the Pattern Controller on.

① 1		⊙		○		○	1	←	1	1	○	●	→	↑	P	5	
2												→					
3												→					
4			C		○								→	→	→	→	3
②			○		2	1				2			→	→			

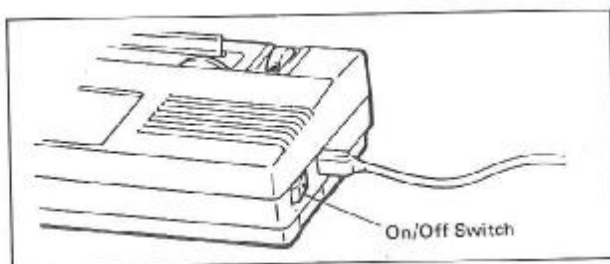

## CAST-ON

① — 1 Set machine controls for the initial row  
ON-OFF SWITCH.....OFF

## PATTERN CONTROLS

No Pattern Switches are operated.

## KNITTER CARRIAGE

Russel Levers (left & right).....||  
Cam Lever.....○ (STOCKINET)

## RIBBER ARM

Auxiliary Yarn Feeder Lever.....●  
Driving Lever.....resting position

## STITCH DIALS

Knitter & Ribber.....0

## RIBBER CARRIAGE

Set Levers (left & right).....1  
Pick Knob.....←  
Auto-set Lever.....1

## RIBBER NEEDLE BED

Pile Levers (left & right).....upper position  
Half Pitch Lever.....P  
Swing Indicator.....5

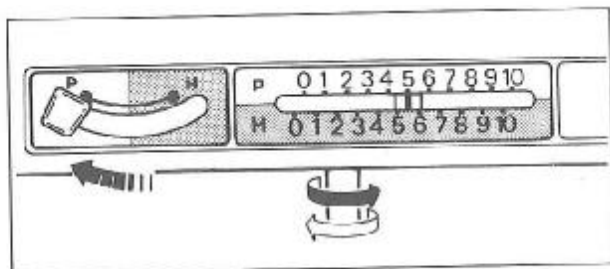
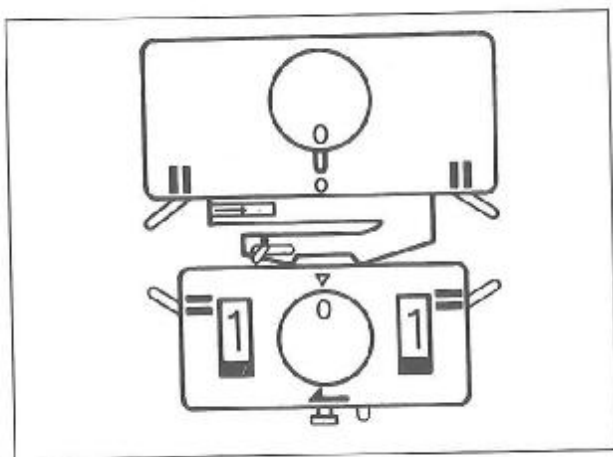

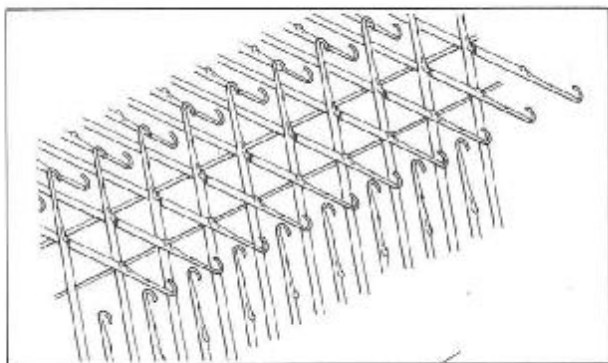

## ①— 2 Arrange needles for knitting the initial row.

1. Arrange needles of both beds for cast-on.
  - (1) Using 1/1 Needle Pusher, push 25 needles to D position on both sides of center(D) of Knitter Needle Bed. (Alternate needles)
  - (2) Push ribber needles to D position, alternating them with needles of Knitter.
- (3) Move Carriage 2 ~ 3 times carefully across needles in D position and leave it at right side. (Needles in D position will be aligned in B position on both beds.)

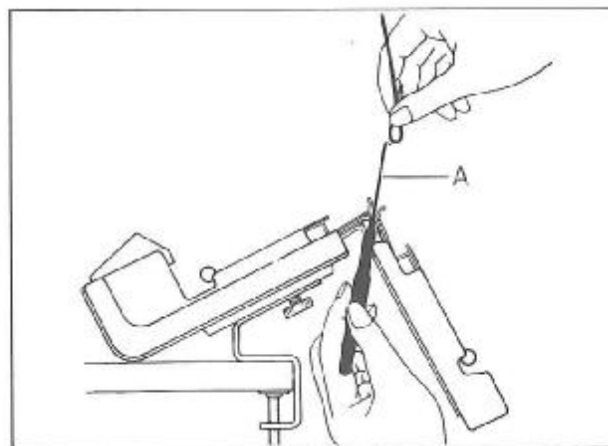
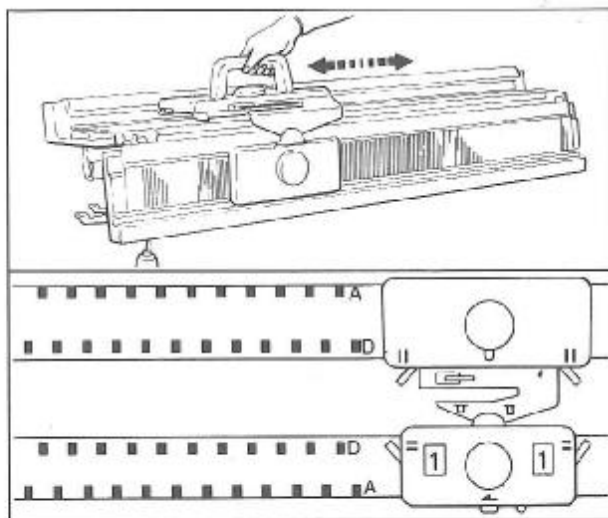

2. Thread yarn into Yarn Feeder.
  - (1) After threading yarn through Auto-Tension, make a loop at the end of yarn and hold it at the left side of both beds.
  - (2) Insert Hook Tool "A" from underneath, catch yarn end, and pull it down.

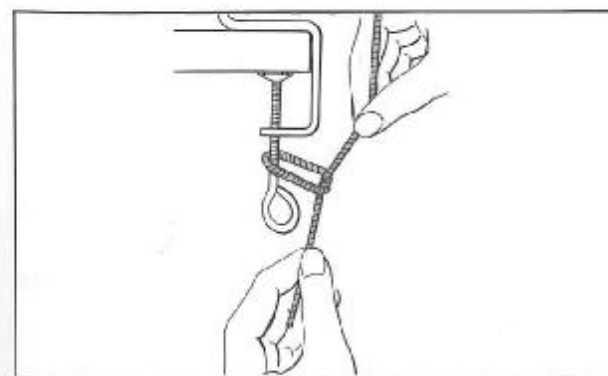

- (3) Tie yarn end to Clamp.



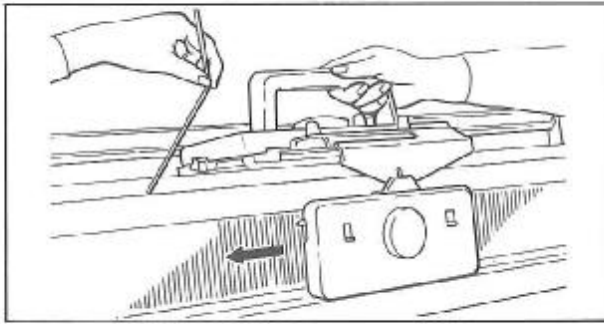

(4) Move Carriage from right to left till yarn goes into Yarn Feeder.

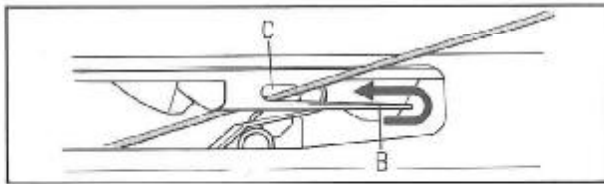

(5) Guide yarn along Yarn Guide "B" to thread it into Main Yarn Feeder "C".

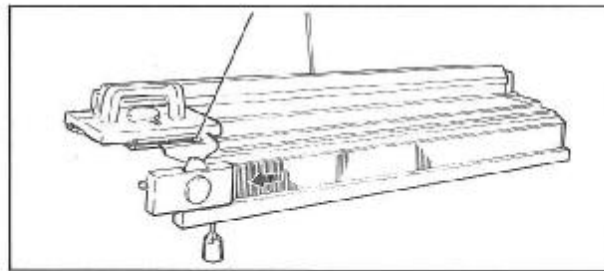

(6) Move Carriage to left end of Needle Bed.

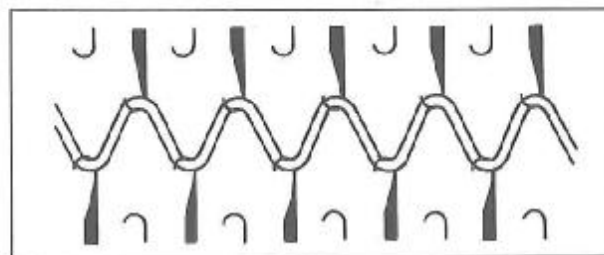

3. Knit the initial row.

Take up slack of yarn and move Carriage from the left to the right.

Yarn will be hooked alternately on Knitter and Ribber needles.

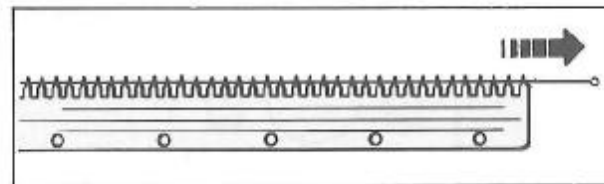

### ① — 3 Suspend Cast-on Comb with Weights.

1. Suspend Cast-on Comb.

(1) Take out short Cast-on Comb (100-needle) and remove wire from its teeth.

(2) From underneath, insert Comb between Knitter and Ribber Bed, then push it carefully upwards until teeth clear zig-zagged yarn.

Hang Comb so that it is balanced horizontally between working needles.

*Make sure the yarn is centralized on the Comb, or the knitting will be incorrectly weighted.*

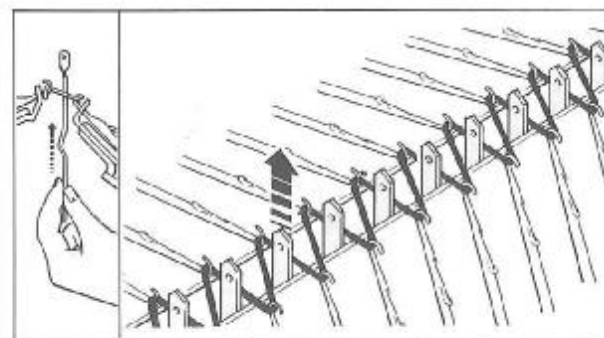

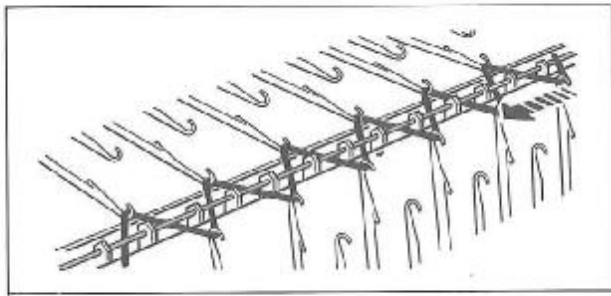

(3) Insert Wire through holes of Cast-on Comb teeth.

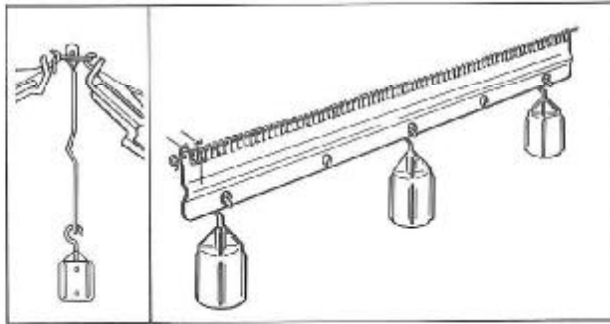

2. Hook Weights.

Use two Ribber Weights (large) and hook them onto left and right sides of Cast-on Comb.

For your reference use up to 80 needles 2 Weights  
 120 needles 3 Weights  
 160 needles 4 Weights  
 200 needles 5 Weights

*Hook Weights at even intervals.*

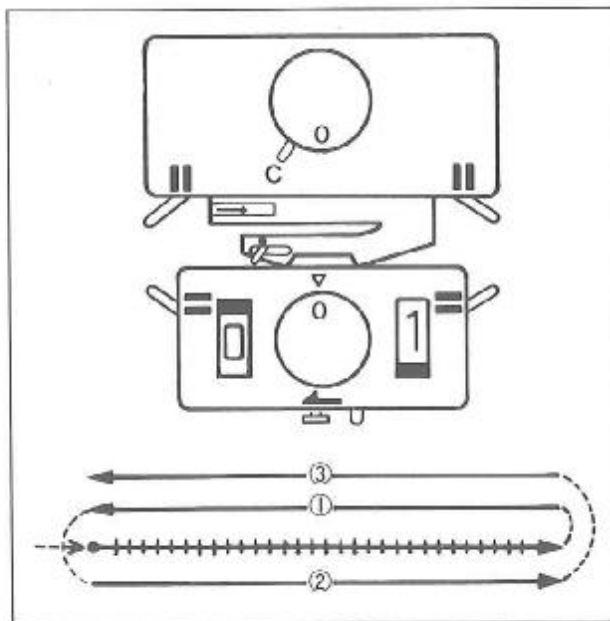

①— 4 Change machine controls for knitting subsequent 3 rows.

Change Carriage settings.

Cam Lever..... **C** (CIRCULAR)  
 Set Lever (left)..... **0**  
 Stitch Dials (Knitter & Ribber)..... **0**

Knit 3 rows.

CAST-ON IS COMPLETED.

*Release the yarn end from the Clamp.*

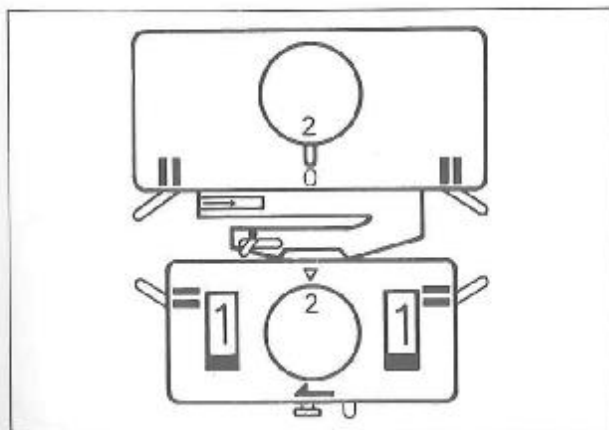

② Re-set machine controls for working main knitting.

(Needle arrangement for main knitting is the same as for cast-on.)

1. Change Carriage setting.

Cam Lever..... **0** (STOCKINET)  
 Set Lever (left)..... **1**  
 Stitch Dials (Knitter & Ribber)..... **2**  
 Other setting unchanged.

2. Knit 20 rows by moving Carriage smoothly across Needle Bed.

K1.P1. RIB IS KNITTED.

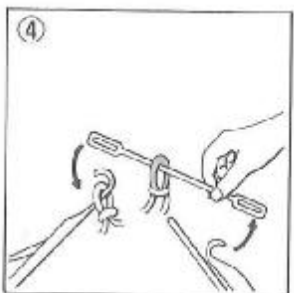
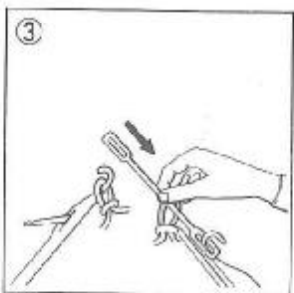
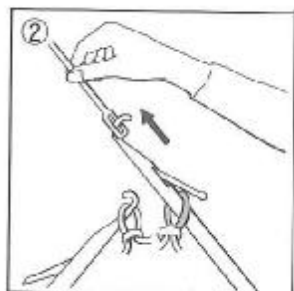
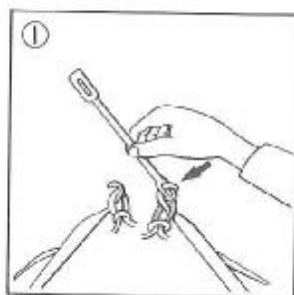
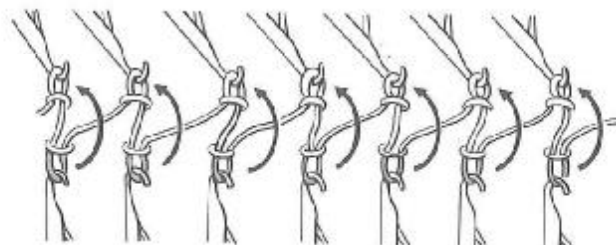
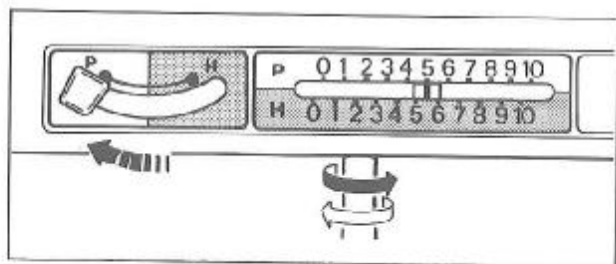
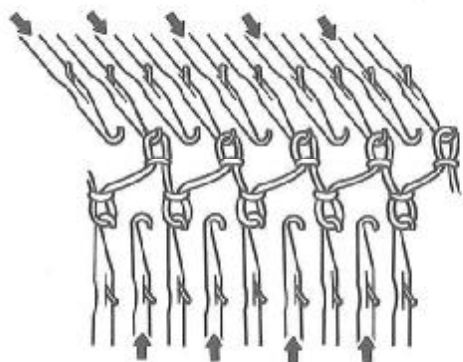
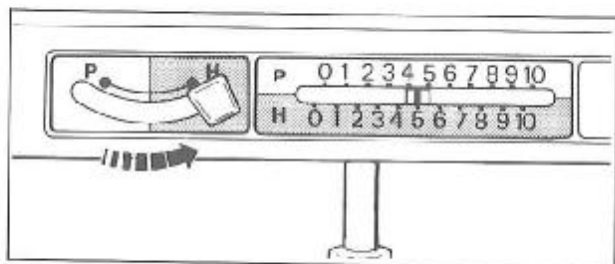

For practice, continue to knit DOUBLE RIB following instructions below.

1. Set Half-Pitch Lever to H.

2. Push empty Knitter and Ribber needles to B position.

3. Knit 15 rows.

For practice, continue to knit only on the Knitter following instructions below.

1. Set Half-Pitch Lever to P.

2. Transfer every Ribber stitch to the corresponding Knitter needle using Double-eye Transfer Tool.

① Place eye of Double-eye Transfer Tool into Ribber needle hook.

② Pull Ribber needle to D position.

③ Push Ribber needle to A position.

④ Remove eye of Transfer Tool from Ribber needle hook.

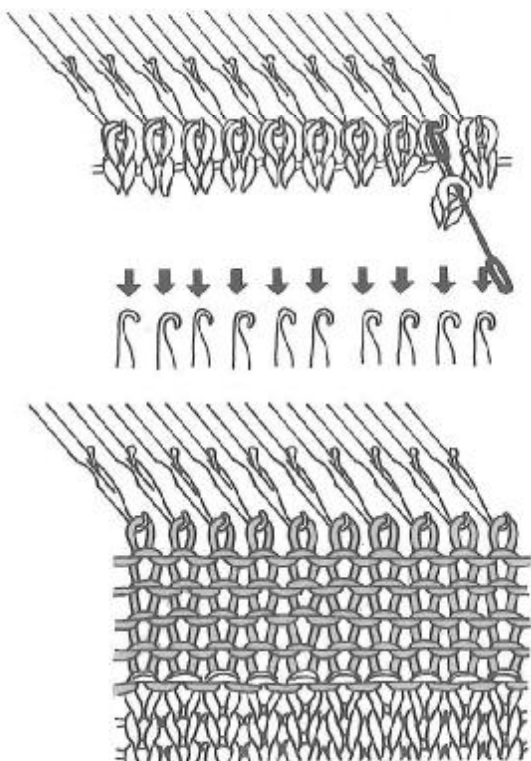
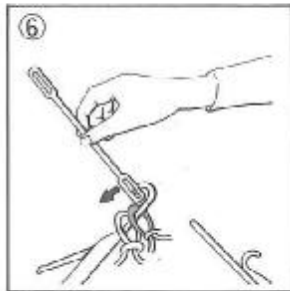
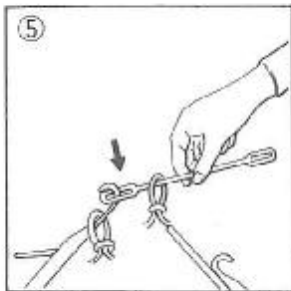

- ⑤ Place opposite eye into Knitter needle hook.
- ⑥ Tilt Transfer Tool until stitch slides into Knitter needle hook. Remove Transfer Tool. Push needle in B position slightly towards A position to ensure that transferred stitch lies correctly in needle hook.

3. Push every Ribber needle in B position to A position.

4. Disconnect Ribber Carriage from the Arm and rest Ribber Bed in the lowest position.

5. Exchange Ribber Arm for Knitter Arm and thread yarn into Feeder ①. Continue to knit.

## Useful Optional Accessories

### Cast-on Hanger Comb

This 140-needle wide Cast-on Comb with cross bar is for use in place of the Ribber Cast-on Comb. When the Hanger Comb reaches the floor, remove the Cast-on Comb from the fabric by pulling out the wire. Insert the fabric between Comb and Bar as shown below. Also comes with a 50-needle wide Cast-on Comb for narrower fabrics.

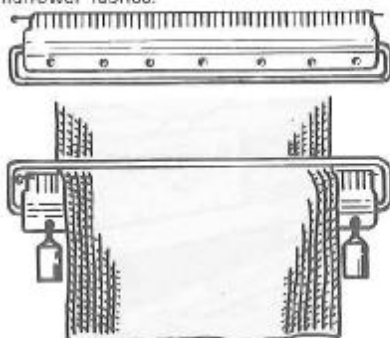

### Hanger Comb Set

Consists of three separate Hanger Combs for use with the ribber edge weights. Each Comb covers 38 needle wide fabric and they can be used singly or all together. Weight Set (Hanger Comb with three small weights) is also available.

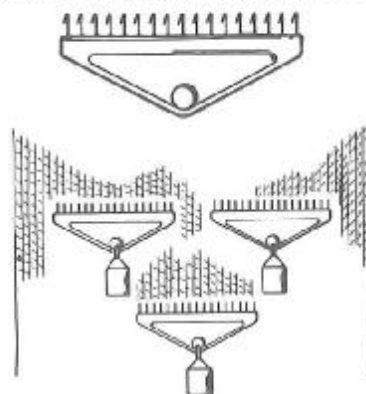

## CAST-ON FOR TIGHTER EDGE

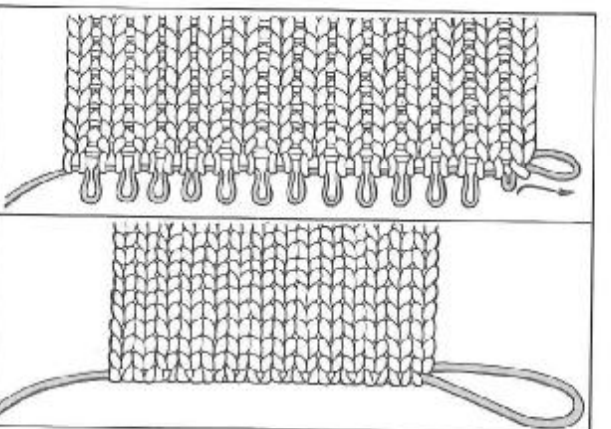
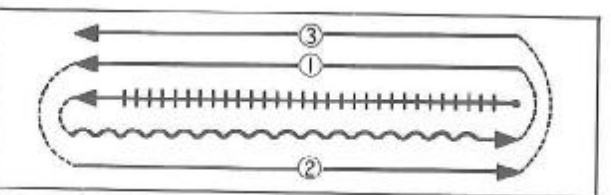
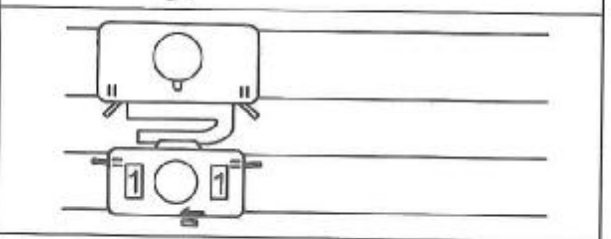
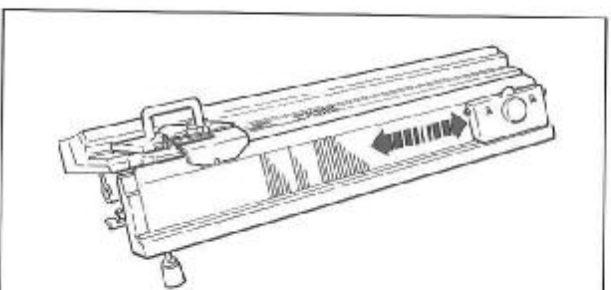
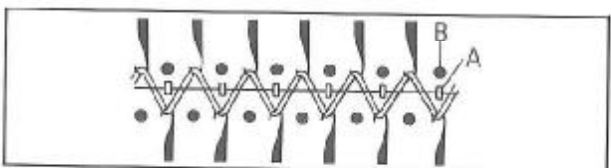
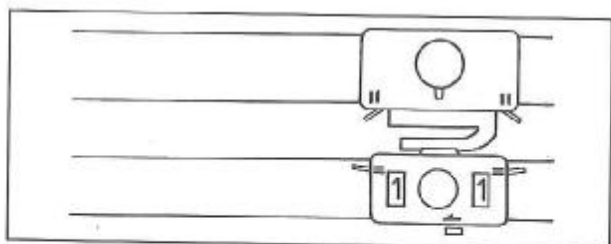

To make the cast-on edge of the fabric tighter, when knitting with thin yarn, set the Carriages as instructed in the operation table, but operate them following the procedure given below.—

- ①— 1 Set machine controls for the initial row and have Carriage on the right side.
- ①— 2 Arrange needles, and knit the initial row from the right to the left.
- ①— 3 Suspend Cast-on Comb with Weights.

*Insert Cast-on Comb so that its teeth "A" face Knitter Sinker Posts "B" as illustrated.*

- Disconnect Ribber Carriage and move it twice across the needles to drop stitches on Ribber needles.

*If Cast-on Comb is suspended incorrectly, it will drop onto the floor.*

- Connect Ribber Carriage and knit one row with same Carriage settings.

- ①— 4 As required in operation table, knit subsequent 3 rows.  
CAST-ON FOR TIGHTER EDGE IS COMPLETED.

When the garment has been completed, pull the yarn of the initial row from the opposite side to the yarn end. This will tighten the cast-on edge.

After pressing, pull out the yarn completely in the same direction as above.

## REMOVE THE KNITTING FROM THE MACHINE

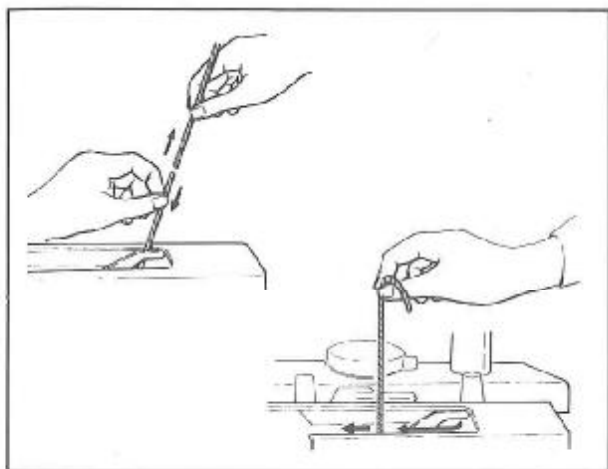

### 1. Cut yarn above Yarn Feeder.

Remove the yarn from Feeder and drop yarn end between Knitter and Ribber sinker posts.

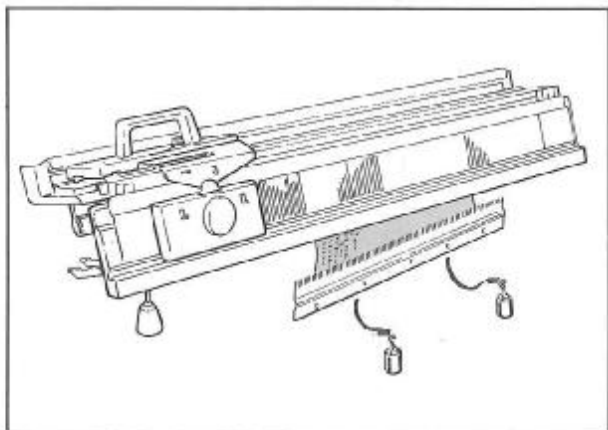

### 2. Remove Weights from Cast-on Comb.

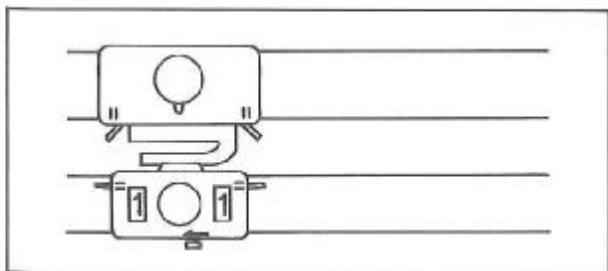

### 3. Change Carriage settings as follows.

Cam Lever..... O (STOCKINET)  
 Set Levers..... 1  
 Russel Levers..... ||

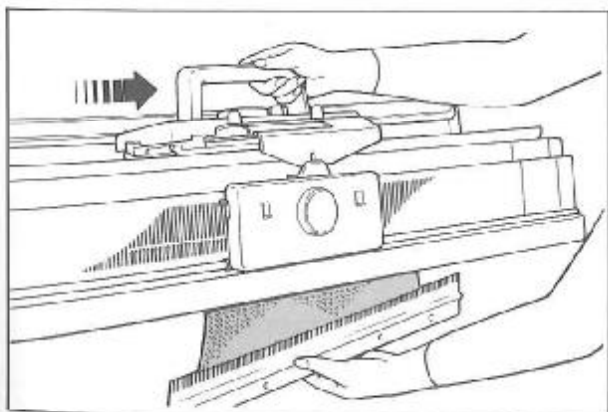

### 4. Holding Cast-on Comb, move Carriage once across needles. The stitches are released from needles.





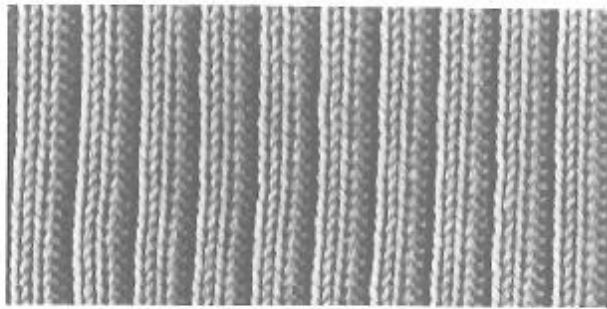

## K2.P2. RIB

The following ribs both look the same when knitted. Method A uses a 2 × 1 needle arrangement on both beds, and is used for medium thick yarn.

Method B uses a 2 × 2 needle arrangement on both beds, and is used for thick yarn.

<b>A</b>																		
① 1		⊙		○		○	1	←	1	1	○	●	→	↑	H	5		
2																→		
3																		
4				C			○										→→→ 3	
②				○		4	1					4					6	→→→

<b>B</b>																		
① 1		⊙		○		○	1	←	1	1	○	●	→	↑	H	5		
2																→		
3																		
4				C			○										→→→ 3	
②				○		7	1					7				P	6	→→→

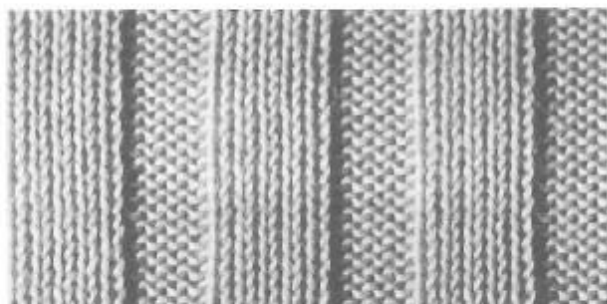

## WIDE RIB

This is the rib with more than K3, P3, stitches aligned alternately. (K5, P5. Rib is shown as an example.)

Two methods for Wide Rib are shown below: —

One is for using medium yarn (Operation Table "A") and the other is for thick yarn. (Operation Table "B")

A																		
① 1			⊙		O		O	1	←	1	1	0	●	→	↑	H	5	
2																	→	
3																		
4					C		3	0										≡)3
5																		
② 1					O		5	1										≡

B																		
① 1			⊙		O		O	1	←	1	1	0	●	→	↑	P	5	
2																	→	
3																		
4					C		3	0										≡)3
5																		
②					O		6	1										≡

\* One end needle on the Knitter and on the Ribber must be in B position. This may change the needle arrangement, but it is essential.

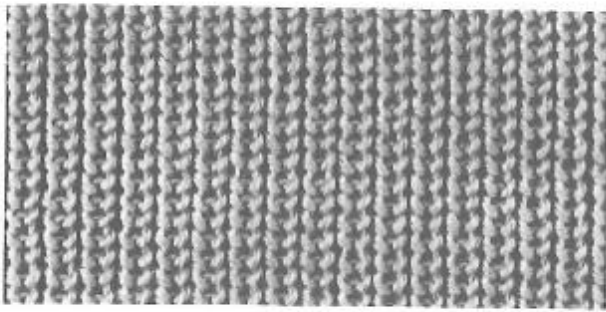

## ENGLISH RIB

This rib has a tuck pattern on Knitter side. It can be knitted in K1.P1. Rib, or in Double Rib.

The sample is knitted in K1.P1. Rib using medium yarn.

1			⊙		0		0	1	←	1	1	0	●	→	↑	P	5				
2																					←
3																					
4					C			0				2									→→→)3
2					E		4	1				4									→→→)2

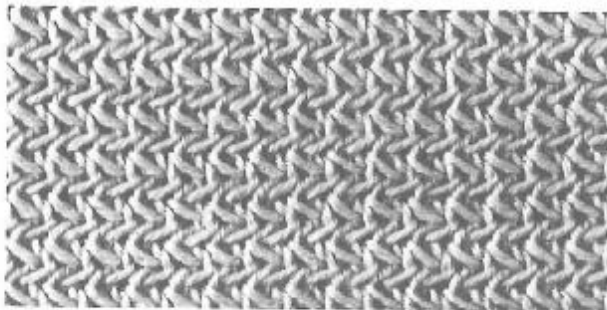

## SWUNG ENGLISH RIB

This rib has a tuck pattern on Knitter side with a 2-pitch swing in K1.P1. Rib or 1-pitch swing in Double Rib.

The sample is knitted in K1.P1. Rib using medium yarn.

1			⊙		0		0	1	←	1	1	0	●	→	↑	P	5						
2																							←
3																							
4					C			0				2											→→→)3
2					E		4	1				4											→→→)2
2																							→→→)2



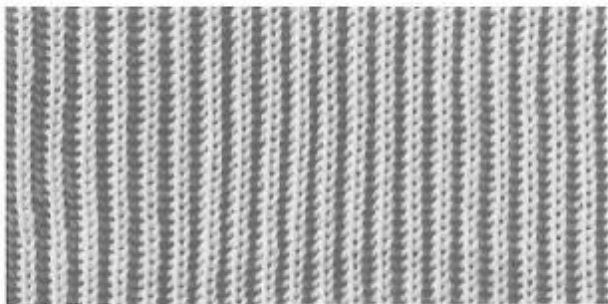

## DOUBLE ENGLISH RIB

Tuck stitch is knitted on every row, on each side of the fabric alternately, in K1.P1. or Double Rib.

The sample is knitted in K1.P1. Rib using medium yarn.

① 1			⊙		0		0	1	←	1	1	0	●	→	↑	P	5	
2															→			
3																		
4				C		□					2							≡≡≡ 3
②				E	3	□					3							≡≡

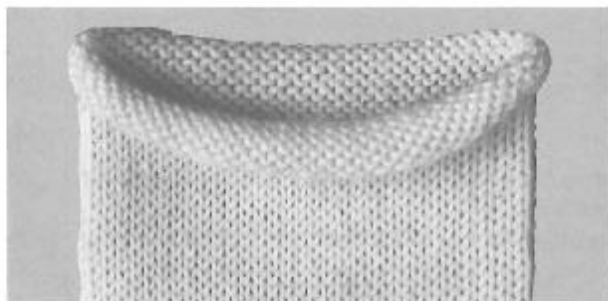

## TUBULAR KNITTING

As you move Carriage back and forth, Knitter Carriage and Ribber Carriage knit alternately.

This is mainly used for waste knitting.

The sample is knitted using medium yarn.

Set the Ribber Stitch Dial 2 numbers looser than that of the Knitter.

① 1			⊙		0		0	1	←	1	1	0	●	→	↑	H	5	
2															→*			
3																		
②				C	6	□					8					P		≡≡**

\* Knit with Ravel Cord, or waste yarn when using a lot of needles.

\*\* When moving Carriage from left to right, knit bringing four or five needles at both ends of Ribber to D position, or push all needles of Ribber to C position using P Carriage (without P Prasser).



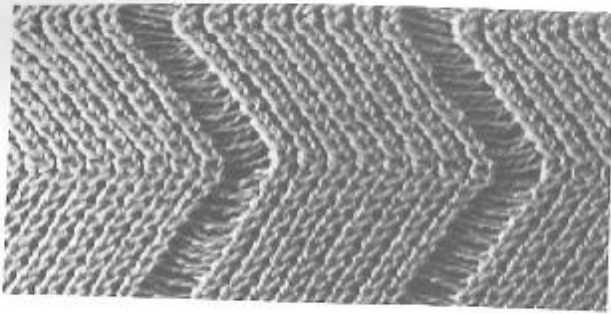

## HERRINGBONE SWING

This fabric combines tuck stitch with swing operation of Ribber.  
The sample is a variation of Double Rib using thin yarn.

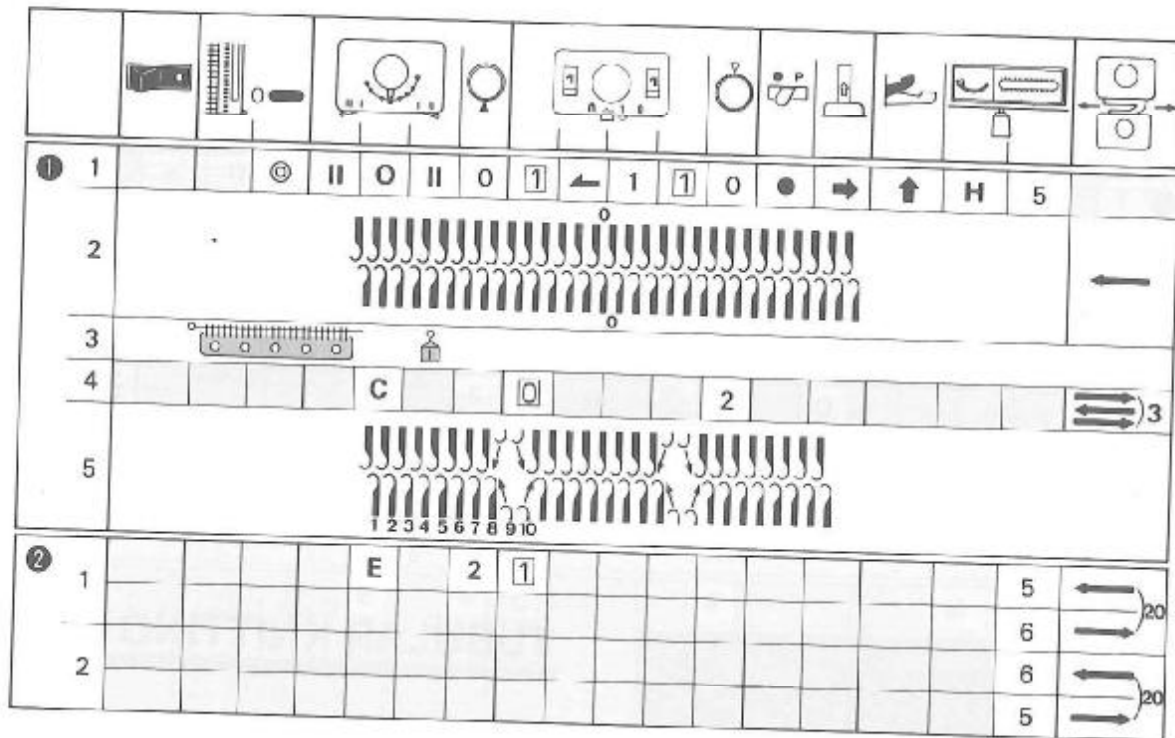

*Note: Swing Ribber by 2 pitches for K1. P1. Rib and 1 pitch for Double Rib.  
Repeat swinging back and forth for the desired number of rows, then change the direction of swinging.*

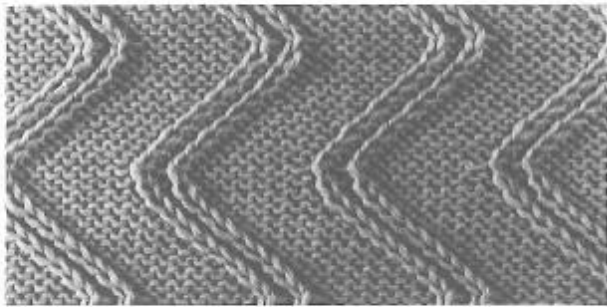

## VARIATION SWING

While Knitter Carriage knits in Stockinet, Ribber Carriage knits with selected needles making ridges. By swinging Ribber, these ridges make various swung patterns.

The sample is knitted using medium yarn.

1			⊙		○		○	1	⤴	1	1	○	●	➡	↑	H	5	
2																	←	
3																		
4				C		2	□				4						➡➡➡ 3	
5																		
2				O		6	1										5	←
																	4	→
																	3	←
																	2	→
																	1	←
																	0	→
																	1	←
																	2	* 5 10 6
																	5	
																	10	
																6		

\* Knit swinging the Ribber by 1 pitch every row to the extreme right, and then to the extreme left, to make zigzag pattern. Push 1 ~ 5 end needles to D position before knitting the next row.

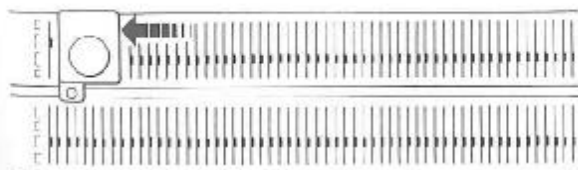

**If stitches tend to float...**

Knit pushing needles on Knitter to C position using P Carriage.

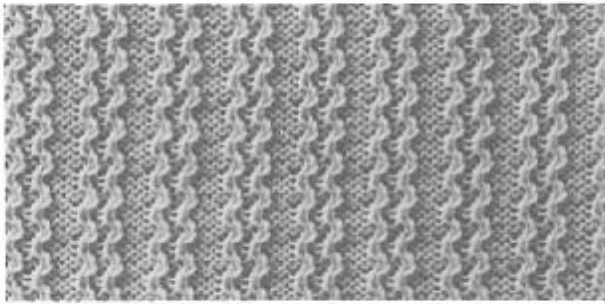

By changing the needle arrangement on the Ribber, a different effect is created.

Two samples shown below are knitted using medium yarn.

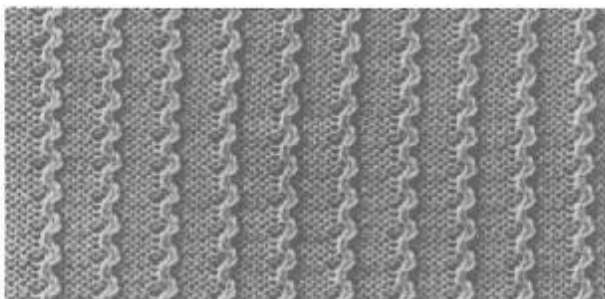
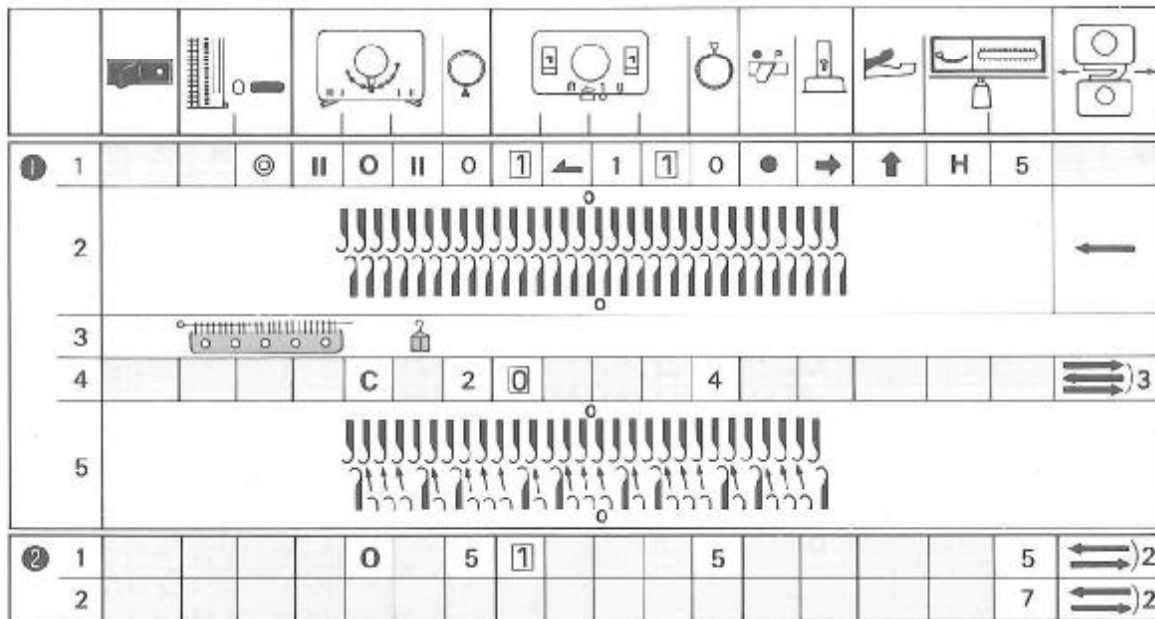

Knit in the same manner as for above ① — 1 ~ 4.  
At step 5, follow diagram below.

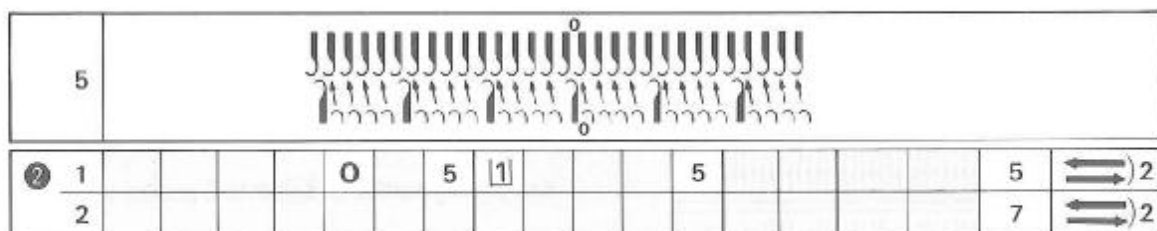

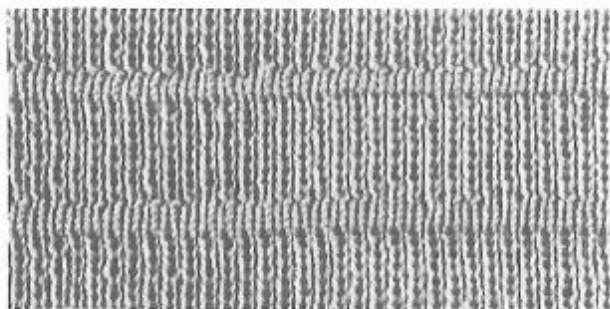

## PIN TUCK

Using all needles on both beds (Double Rib needle arrangement) knit an extra 4 ~ 5 rows on the Ribber side.

The sample is knitted using thin yarn.

Connect the Pattern Controller to the machine.

Use Close Knit Bar.



①	1	■	●		0		0	1	←	1	1	0	●	→	↑	H	5		
	2																←		
	3																		
	4				C			0			2								→)3
②	1				0		2	1			3								→)10
	2				S														→)4
Move Hanger Comb up.																			

**If stitches tend to float...**

Knit pushing needles on Ribber to C position using P Carriage.

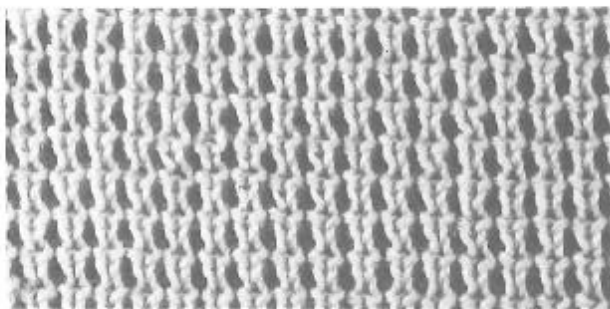

## PICK RIB

This rib tucks on the ribber, with the pattern showing on the knitter side of the fabric.

The sample is knitted in K1, P1. Rib using medium yarn.

1			⊙		0		0	1	←	1	1	0	●	→	↑	P	5	
2																		→
3																		
4					C			0										↔)3
5					0		4	1				4						→
6	Install Driving Cam.																	
1								n										←
2									0									↔)2
3									1									←

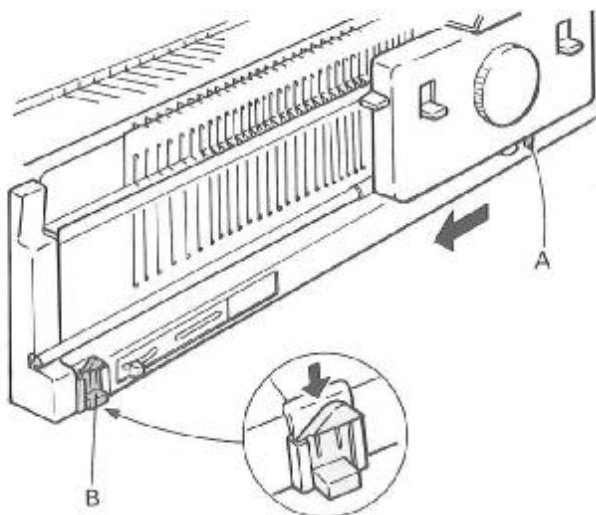

During main knitting, make sure the Carriage is moved to the extreme left, so the Auto-set Lever "A" is operated by the Driving Cam "B".

*Note: Be sure that Auto-set Lever is set to 1 before starting main knitting.*

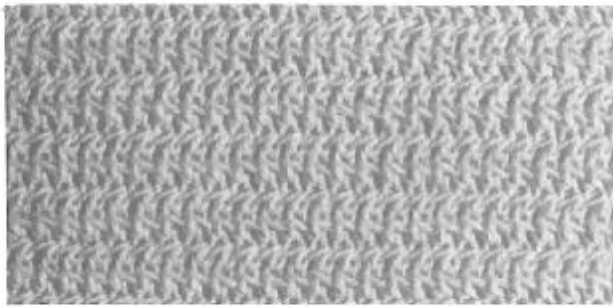

## SWUNG PICK RIB

This rib tucks on the ribber, with the pattern showing on the knitter side of the fabric with a 1-pitch swing in Double Rib or a 2-pitch swing in K1.P1. Rib.

The sample is knitted in Double Rib using thin yarn.

① 1			⊙		0		0	1	▲	1	1	0	●	→	↑	H	5	
2																	→	
3																		
4			C					0										→→→3
5			0		4			1				4						→
6	Install Driving Cam.																	
② 1								n										←
2								0										←←←)2
3								1							6			←←←)2
4								0										←←←)2
5								1							5			←

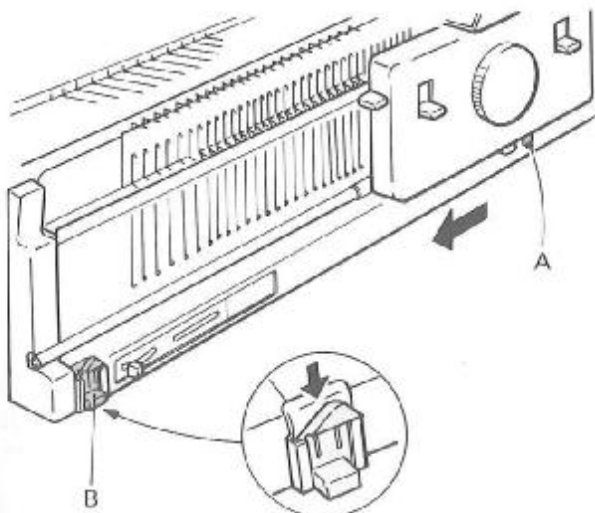

During main knitting, make sure the Carriage is moved to the extreme left, so the Auto-set Lever "A" is operated by the Driving Cam "B".

*Note: Be sure that Auto-set Lever is set to 1 before starting main knitting.*



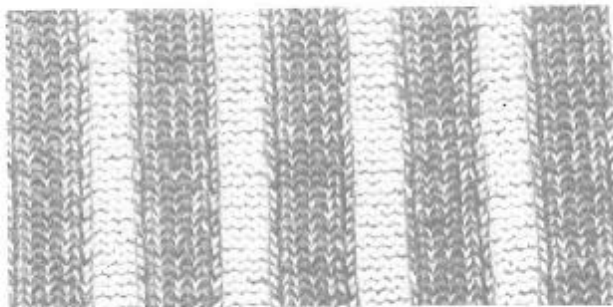

## PLATTING RIB

Platting Rib can be knitted by changing the Main Yarn Feeder for the Platting Yarn Feeder.

Suitable needle arrangements for Platting Rib include K2.T\*2. and Wide Ribs. Using these needle arrangements allows both colours of yarn to show on both sides of the fabric. Both yarns are knitted on every working needle, so use two thin yarns.

*Use thinner yarns.*

① 1			⊙	∥	0	∥	0	1	←	1	1	0	●	→	↑	P	5	
2																	→	
3																		
4			C		3	0						3						≡
5																	*	
②			0		6	1						6						≡

\* Rearrange needles as shown and thread both Yarn Feeders respectively.



Exchange Main Yarn Feeder for Platting Yarn Feeder.

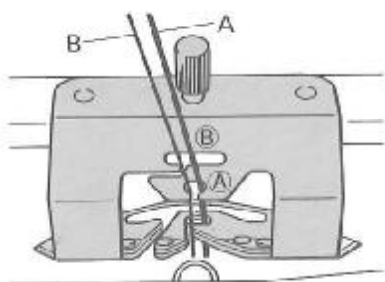

- ① — 1 Set machine controls as shown.  
Thread main yarn "A" and platting yarn "B" into Yarn Feeder **A** for the cast-on in K1.P1. Rib. Do not thread any yarn into Yarn Feeder **B** when working the cast-on.
- 2 ~ 4 Cast-on following the Operation Table.

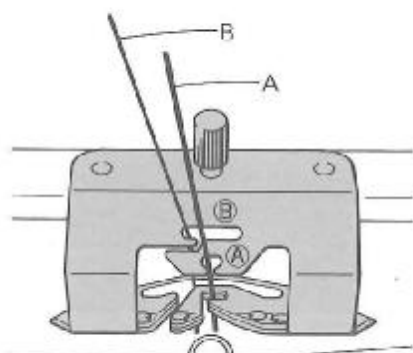

— 5 Rearrange needles for main knitting by transferring stitches.

Thread plating yarn into Yarn Feeder (B)

\* Main yarn "A" in Yarn Feeder (A) will appear on the plain side of the knitting.

\* Plating yarn "B" in Yarn Feeder (B) will appear on the purl side of the knitting.

② Knit following the Operation Table.

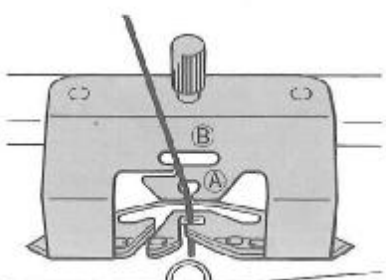

\* To cast-on with every needle selection, thread one yarn into Yarn Feeder (A). Thread second yarn into Yarn Feeder (B) when cast-on is complete, but before beginning main knitting.

*Do not cross the yarns between Auto-Tension and Yarn Feeders.*

*If threading yarn is difficult, depress Drop Levers once and restore the Ribber after threading.*

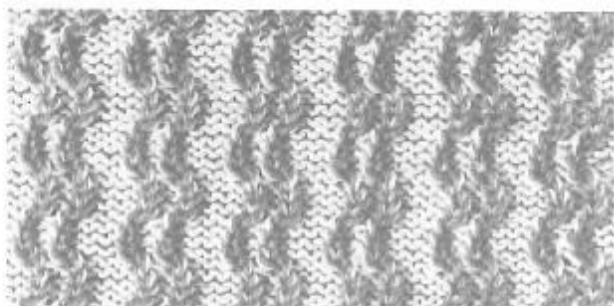

With a different needle arrangement and swinging on the Ribber, different effect is created.

\* Swing Ribber back and forth by 2 pitches every 4 rows.

①	1		⊙		0		0	1	←	1	1	0	●	→	↑	H	5					
	2																	→				
	3																					
	4				C		3	0					3									≡→ 3
	5																					
②					0		6	1														≡→

# ● Rib stitches using Pattern Card

Connect the Pattern Controller to the machine for pattern knitting.  
 Prepare the Pattern Card or draw the pattern on the Design Card as instructed below the picture.  
 Set Pattern Switches and Pattern Width Indicator as instructed.



## PIN TUCK

The sample is knitted with the Pattern Card shown below using light yarn.  
 Do not use the Pattern Switch 1 with its left light on and Pattern Switch 3 and 6.  
 Use Close Knit Bar.

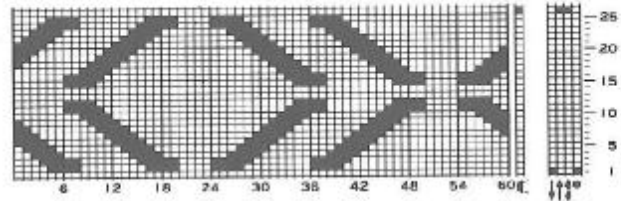
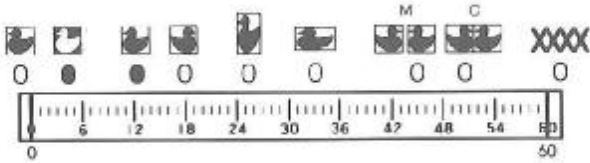

①	1	■	↓	⊙	∥	○	∥	○	1	←	1	1	0	●	→	↑	H	5
2												←						
3																		
4				C		1	0			3								3
5				O		3	1			4								↑
②		1~	⊙	S														↑

(A)

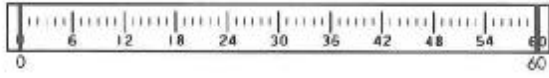
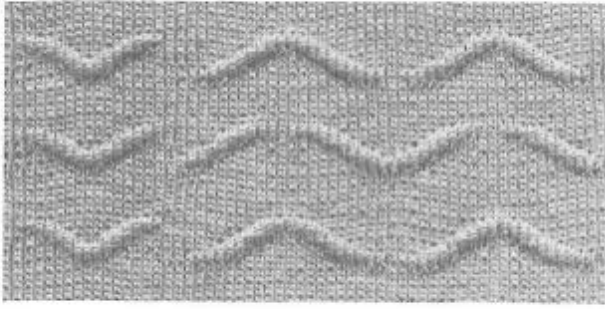

(A) Pattern Card

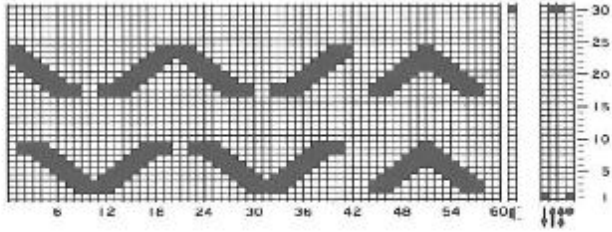

(B)

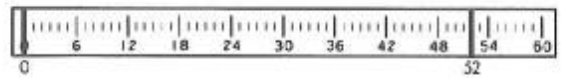

(B) Pattern Card

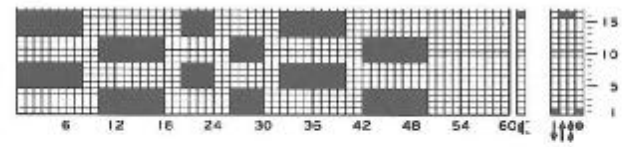







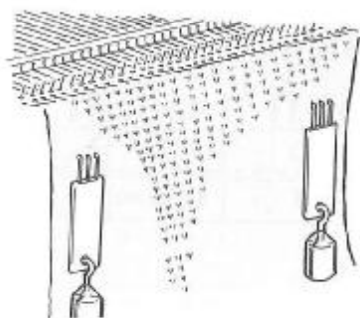
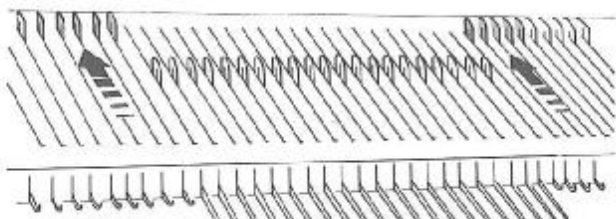
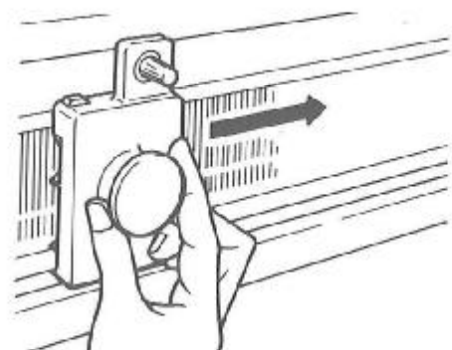
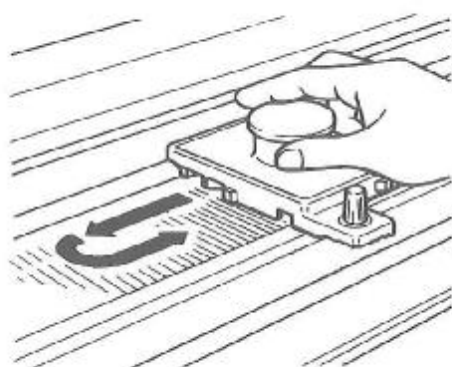
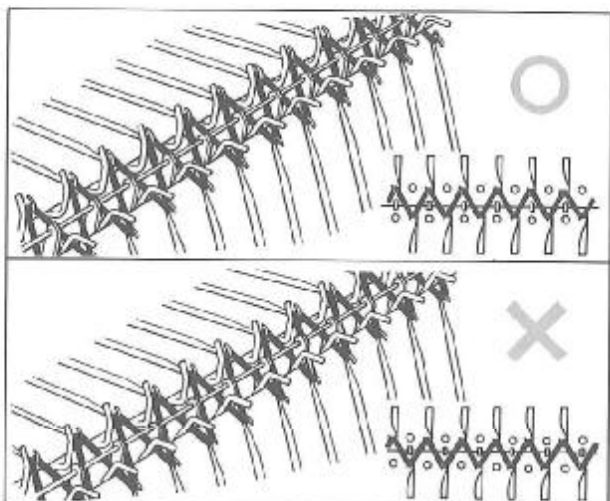

- ① — 1 Set machine controls as shown.  
*Set Stitch Dials to the same as for main knitting.*
- 2 Arrange needles as shown and knit from the left to the right with waste yarn.
- 3 When suspending Cast-on Comb insert it so that its teeth face Ribber Sinker Posts as illustrated.
- 4 Place P Carriage (without P Presser) on the right side of Knitter Needle Bed. Move P Carriage to the left and back again so that stitches are removed and the needles align in B position again.
- 5 Set Cam Lever to SLIP[S] and knit 3 rows with waste yarn. (only the ribber needles will knit.)
- 6 Place P Carriage on the left side of Ribber Needle Bed, and slide it to the right to push up needles to C position.
- 7 Exchange waste for main yarn in Yarn Feeder and knit from the left to the right.
- 8 Using P Carriage on Ribber, bring needles to C position.
- 9 Knit from the right to the left.
- 10 Push both end needles on Knitter back to A position.

- ② — 1 Using P Carriage on Ribber, bring needles to C position.
- 2 Press the Inspection Switch to turn off the light.  
Knit 1 row from left to right. (On Ribber, all the needles in C position knit, and on Knitter, selected needles hold a loop of yarn.)
- 3 Push up Ribber needles to C position using P Carriage.
- 4 Knit one row from the right to the left.
- 5 Remove stitches on Knitter using P Carriage.

Repeat ② — 1 ~ 5 for main knitting.

Suspend Hanger Combs with Weights after 10 rows and move them up every 10 rows.  
The samples on the next page can be knitted in the same way as above.

Ⓐ

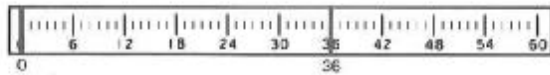
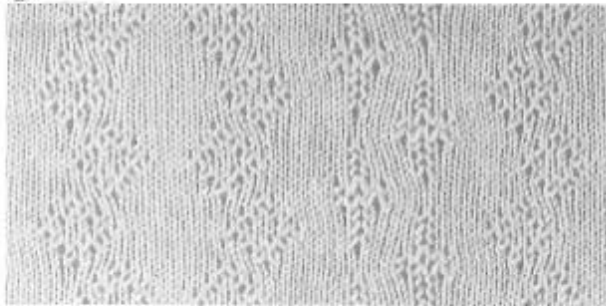

Ⓑ

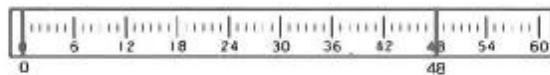
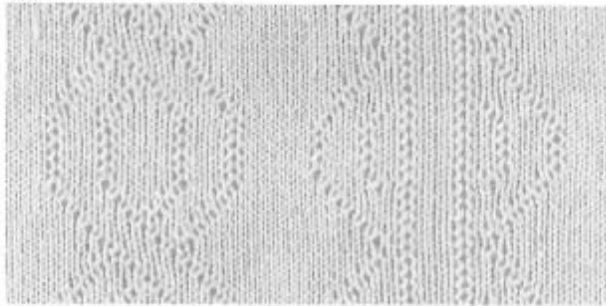

**MESH KNITTING**

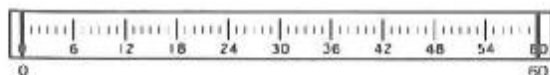
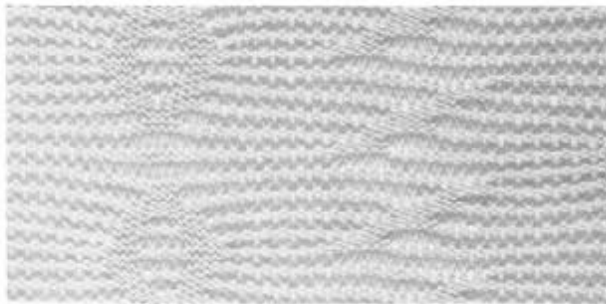
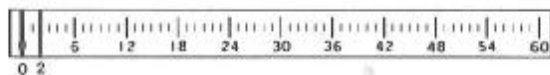
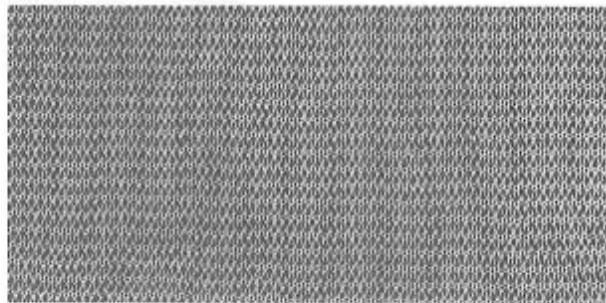

Ⓐ Pattern Card

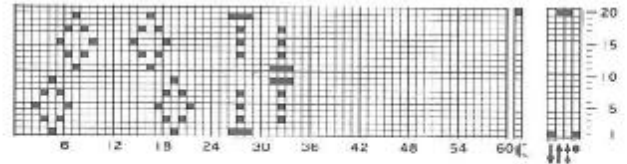

Ⓑ Pattern Card

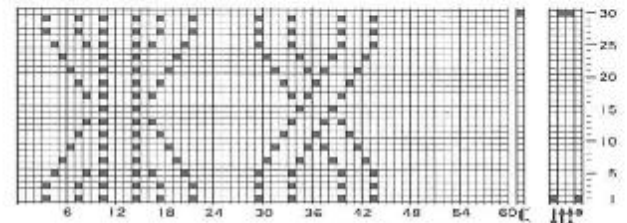

Mesh Knitting is worked in the same manner as for Drive Lace using thin yarn.

The sample on left is knitted with the same Pattern Card as shown below but set Pattern Width Indicator as instructed.

When pressing, slide the iron from top to bottom of the fabric, not from side to side.

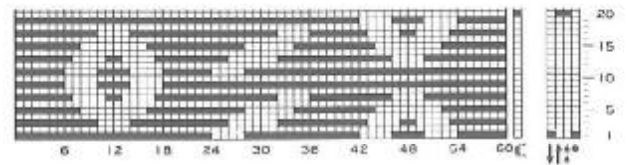

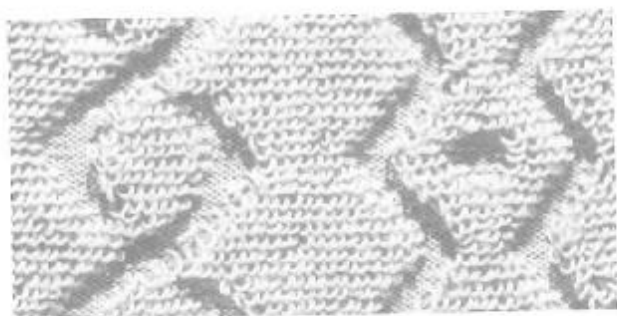

## PILE KNITTING

The stitches in this knitting are formed using both ground yarn and pile yarn. Knit using pile yarn only on Knitter and both yarns on Ribber, removing loops on Knitter every two rows. The sample is knitted with the Pattern Card shown below using woolly nylon for ground yarn, and light yarn for pile yarn. Do not use the Pattern Switch 1 with its right light on and Pattern Switch 3 and 6.

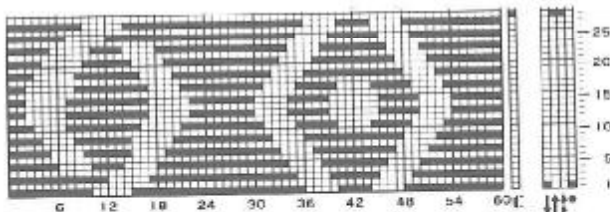
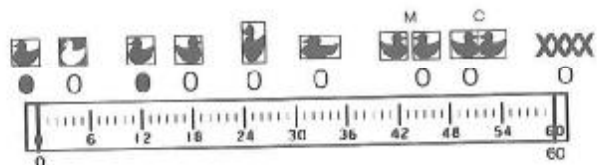

①	1	■	↓	●		○		5	⌈	←	1	⌈	3	●	→	↑	H	5	
2													→						
3																			
4																			
5	S												←←← 3						
6											P		↓	→					
7											P		↓	→					
8											P		↓	→					
9													←						
10																			
②	1													→					
2	1													→					
3	OR													←					
4	2													←					
5																			

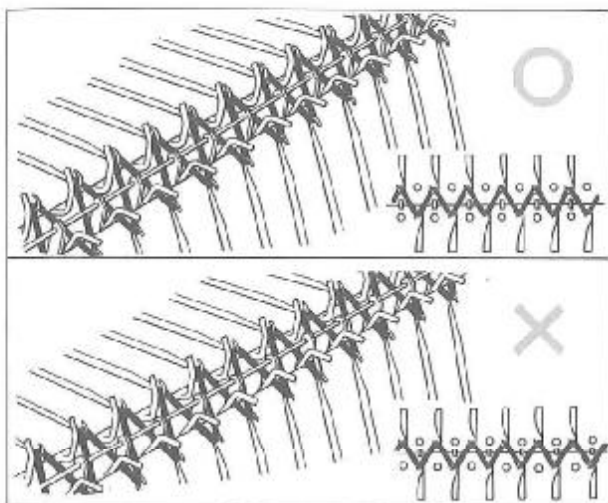

- ① — 1 Set machine controls as instructed.  
*Set Stitch Dial to the same number as for main knitting.*
- 2 Arrange needles as shown and knit from the left to the right with waste yarn.
- 3 When suspending Cast-on Comb, insert it so that its teeth face Ribber Sinker Posts as illustrated.

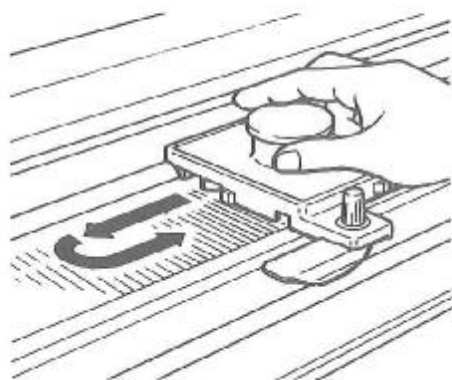

- ① — 4 Place P Carriage with P Presser attached on the right side of Knitter Needle Bed. Move P Carriage to the left and back again so that stitches on Knitter are removed and the needles are aligned in B position again.

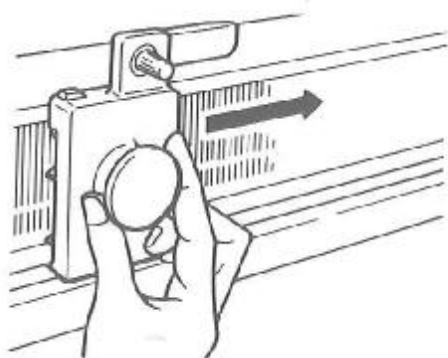

- 5 Set Cam Lever to SLIP(S) and knit 3 rows with waste yarn.
- 6 Place P Carriage on the left side of Ribber Needle Bed, and slide it to the right to push up needles to C position.

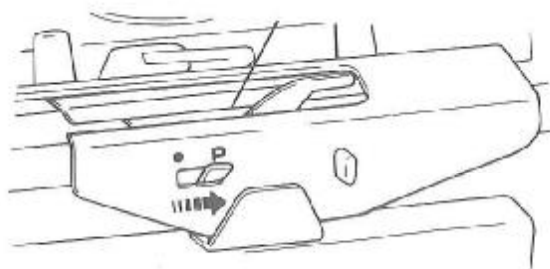

- 7 Exchange waste yarn for pile yarn in main Yarn Feeder. Set Auxiliary Yarn Feeder Lever to **P** (right) position, and thread ground yarn into Auxiliary Yarn Feeder following instructions on the next page.

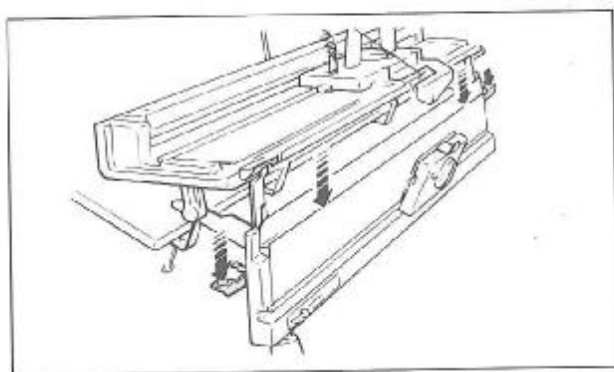

- (1) Lower Ribber Needle Bed to the middle position by depressing Drop Levers (marked red) once.

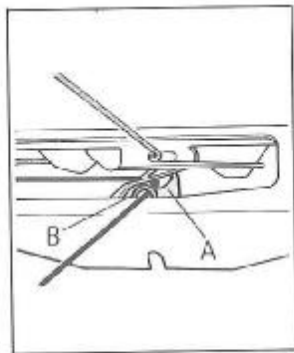
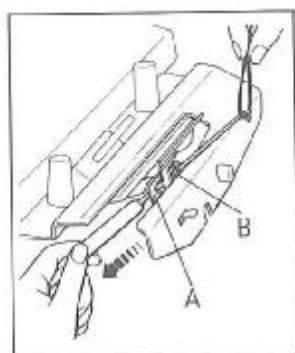

- (2) Thread ground yarn through Auto-Tension.
- (3) Make a loop on yarn end and hold it above Auxiliary Yarn Feeder.
- (4) Insert Hook Tool from underneath through Auxiliary Yarn Feeder "A" and Yarn Guide "B", then catch yarn loop.
- (5) Pull Hook Tool downwards threading yarn through Yarn Guide and Auxiliary Yarn Feeder.

*pile*  
Thread main yarn

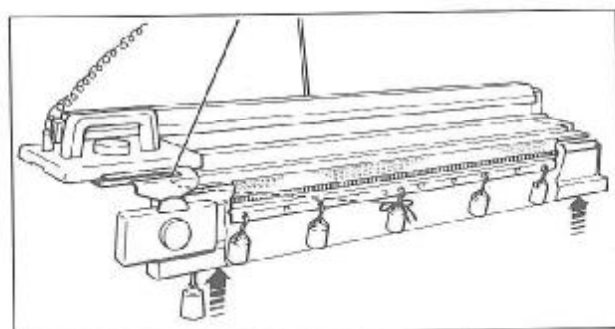

- (6) Tie yarn end to hook of Weight on Cast-on Comb.
- (7) Push up Ribber Needle Bed to its top position. Ensure Ribber needles are correctly lined up in B position.

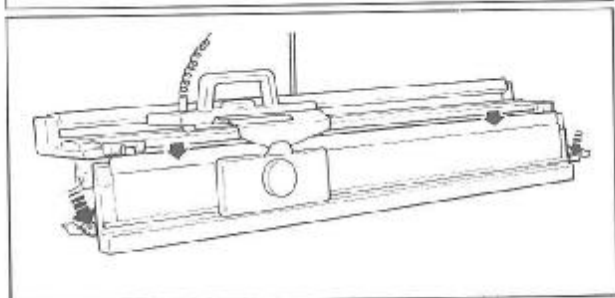

### IMPORTANT:

*Ensure Link Pin on Ribber Carriage is joined properly to Ribber Arm.*

- (8) Depress both Pile Levers (marked blue) to widen space between Knitter and Ribber Needle Bed.
- (9) Knit from the left to the right.

*If the yarn are loose, pull them back from below the Auto-Tension before moving Carriage.*

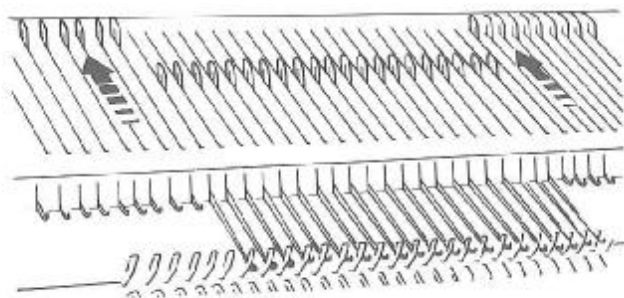

- 8 Bring Ribber needles to C position using P Carriage.
- 9 Knit from the right to the left.
- 10 On Knitter, push 5 needles back to A position at both sides of fabric to leave plain edges for seaming.



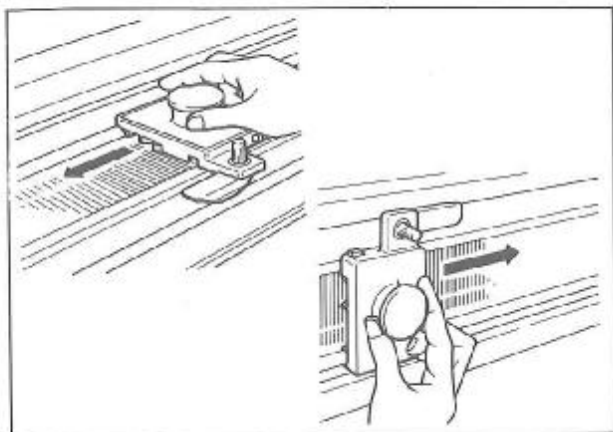

- ② — 1 Bring Ribber needles to C position using P Carriage.
- 2 Press the Inspection Switch to turn off the light.  
Knit 1 row from left to right.
- 3 Slide P Carriage on Ribber from the left to the right.
- 4 Knit 1 row from the right to the left.
- 5 Remove stitches on Knitter using P Carriage.

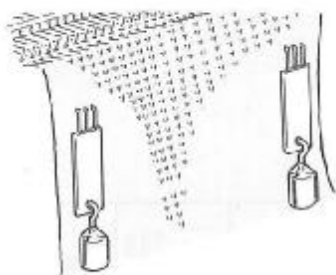

Repeat ② — 1 ~ 5 for main knitting.

Suspend Hanger Combs with Weights after 10 rows and move them up every 10 rows.

The following samples can be knitted in the same way as above.

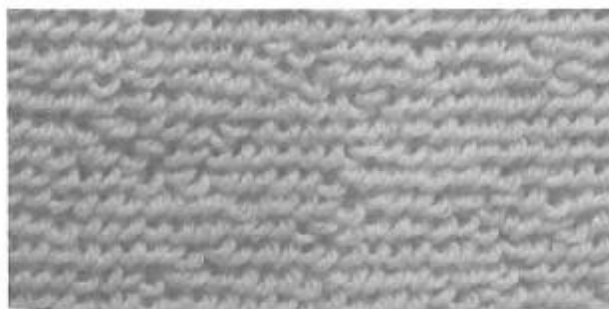
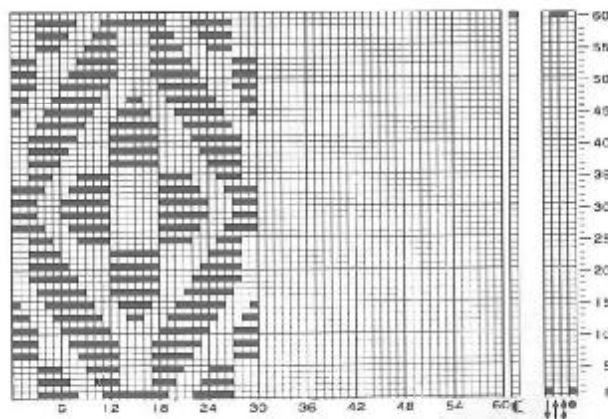
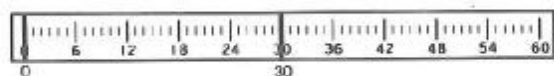
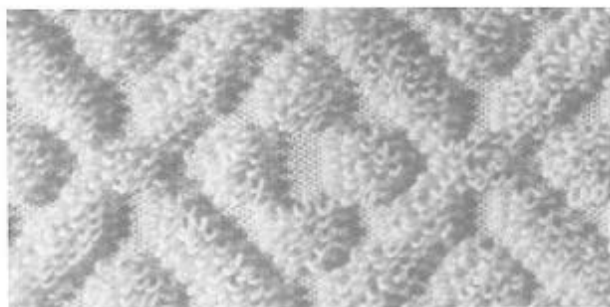

The sample on the left is knitted using the same Pattern Card as for Mesh Knitting on page 88, but set Pattern Width Indicator as instructed below.





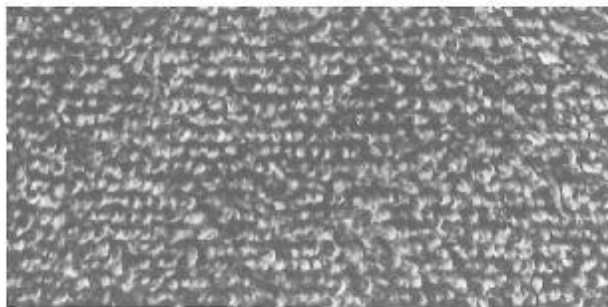

You can cut the loops of Pile Knitting if you wish.

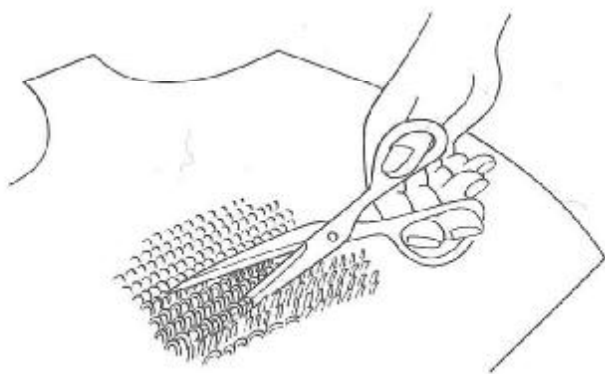

To cut loops, spread fabric on a flat surface.

Insert one scissor blade into centre of loops and cut open.

Steam the surface of the fabric.

**DO NOT PRESS.**

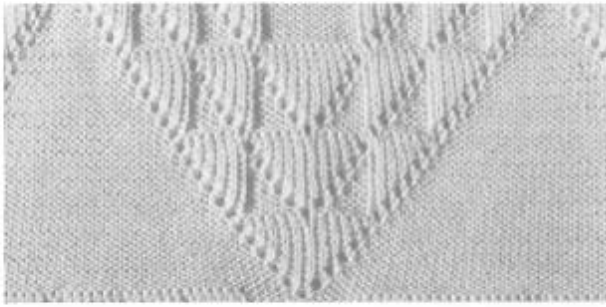

## SHADOW LACE

This pattern is made in Double Rib. While the Ribber needles knit every stitch, the Knitter needles selected by the Pattern Card form loops. Stitches are transferred from the Knitter to the Ribber at an interval of several rows, as required.

The sample is knitted with the Pattern Card shown below using light yarn.

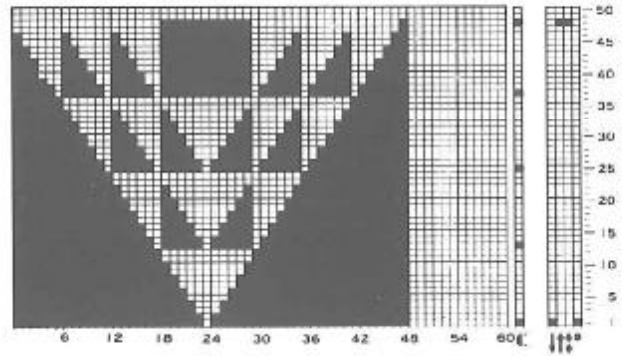
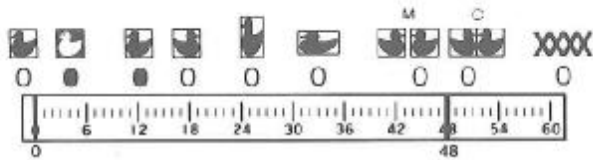

1	1	0	0	0	0	0	0	0	0	0	0	0	0	0	0	0	0	0	0
2																			
3																			
4				C				2											
5				O		3		5											
6																			
7	1	1-12		S															
8																			
9		13-24																	
10																			

: Transfer stitches from the Knitter to the Ribber, using the Shadow Lace Transfer Tool.



### SHADOW LACE TRANSFER TOOL

The Shadow Lace Transfer Tool is available as an optional accessory. It enables you to transfer 20 stitches at a time from the ribber to the main machine or vice versa.

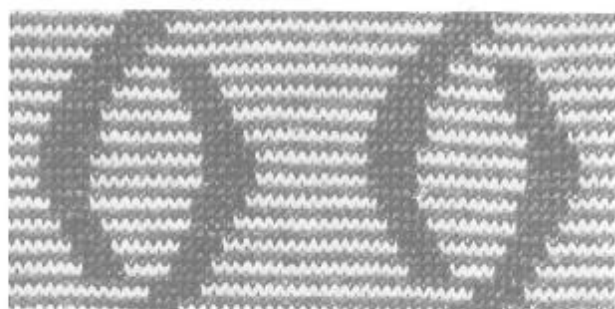

## DOUBLE JACQUARD

Double Jacquard — a fabric knitted with the use of Pattern Card, and having no floats of yarn on its back.

Using Yarn Changer (option) and Pattern Card, pattern is formed on the Knitter side, with the Cam Lever set at **J** (JACQUARD) and Ribber knits on every row.

Any Fair Isle Card can be used for knitting Double Jacquard. The sample is knitted with thin yarns, using the Pattern Card as shown.

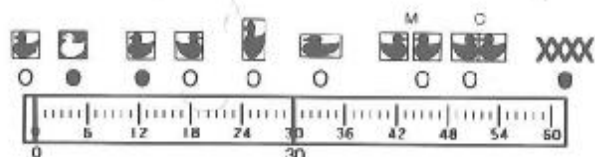

\*Use Close Knit Bar.

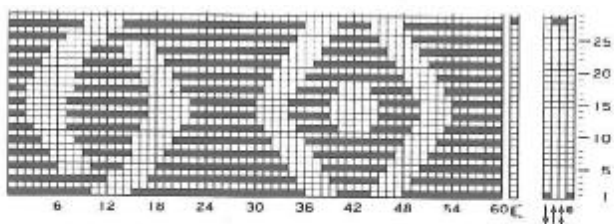

--	--	--	--	--	--	--	--	--	--	--	--	--	--	--	--	--	--	--	--	--	--	--	--	--	--	--	--	--	--	--	--	--	--	--	--	--	--	--	--	--	--	--	--	--	--	--	--	--	--	--	--	--	--	--	--	--	--	--	--	--	--	--	--	--	--	--	--	--	--	--	--	--	--	--	--	--	--	--	--	--	--	--	--	--	--	--	--	--	--	--	--	--	--	--	--	--	--	--	--	--	--	--	--	--	--	--	--	--	--	--	--	--	--	--	--	--	--	--	--	--	--	--	--	--	--	--	--	--	--	--	--	--	--	--	--	--	--	--	--	--	--	--	--	--	--	--	--	--	--	--	--	--	--	--	--	--	--	--	--	--	--	--

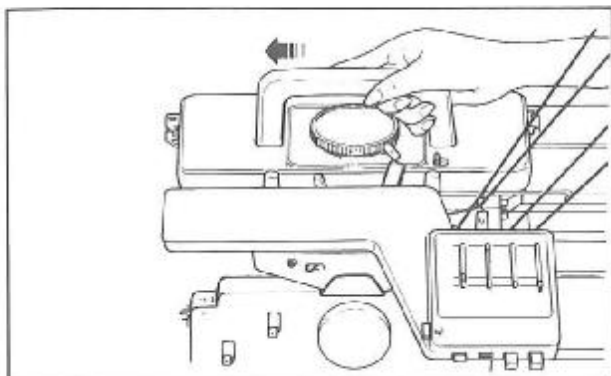

## Main Knitting

- ② — 1 ~ 3 Change machine controls to knit Double Jacquard. Start knitting from the right to the left till Driving Lever hits Feeding Lever to change the yarn every two rows. (Either left or right light of the Switch 1 lights on alternately every two rows.) While knitting, change the yarns following the mark on the Notation Column by pushing the respective Holder Button when a buzzer sounds.

*The Holder Button holding the yarn to be selected next must be pushed when the Carriage is at the right side.*

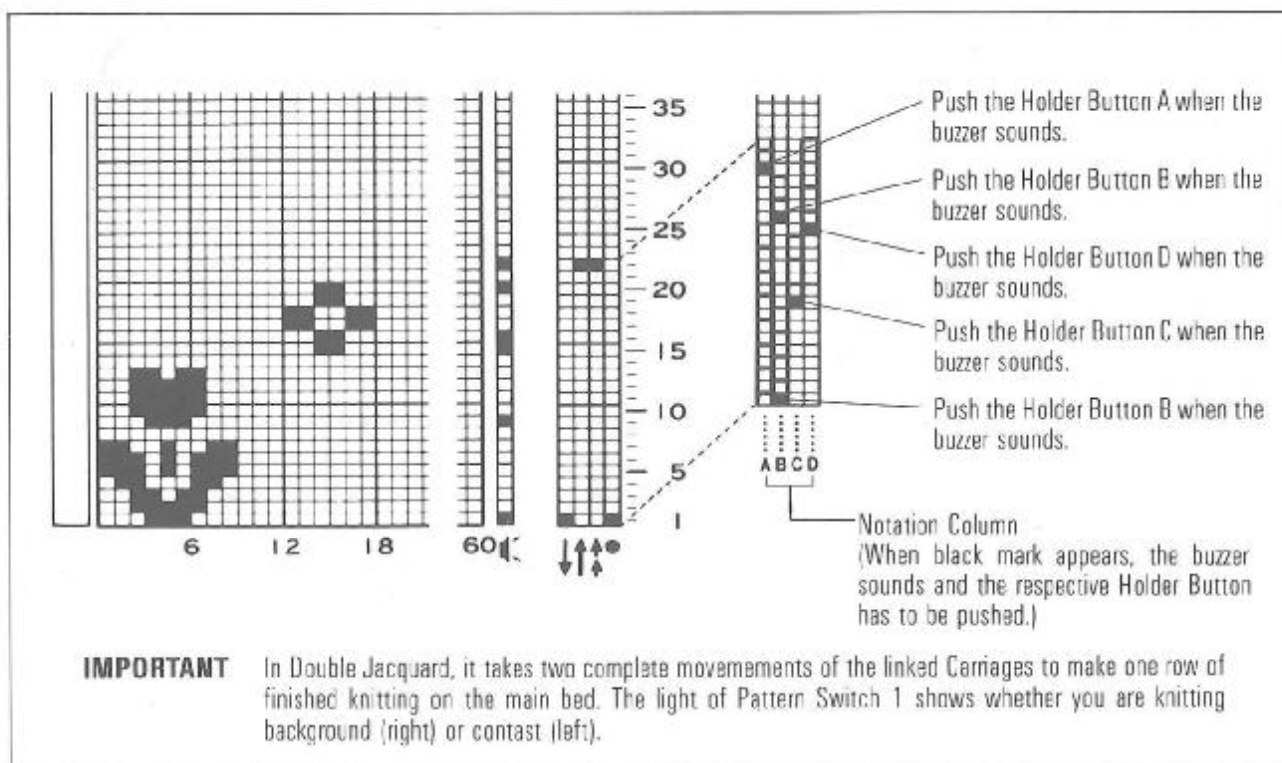

### To knit Single Motif in Double Jacquard

- Set Point Cams and N1 Cam at the required positions and knit in the same manner as for ordinary Double Jacquard. N.B. To change the positions of Point Cams and/or N1 Cam while knitting, refer the instructions on page 26. When resetting the left Point Cam there will be no need to move the Knitter Carriage twice without knitting.

### To knit Double Jacquard using Switch 3

- Press Switch 3 simultaneously with Switch 6 and knit in the same manner as for ordinary Double Jacquard.
- To use Pattern Switch 3 with its light on while knitting Double Jacquard, press Switch 3 so the light comes on with the Carriage on the right.

### If incorrectly knitted in the course of Double Jacquard using Switch 3

- 1- In Double Jacquard using Pattern Switch 3, it takes 4 complete movements of the linked Carriages to knit one row of the Pattern Card, therefore unravel a multiple of four rows.
- 2- Press Inspection Switch so the light comes on and return the Pattern Card only quarter the number of rows unravelled.
- 3- Return the Row Counter and Pattern Paper the same number of rows unravelled.
- 4- Re-arrange the Holder Buttons of the Yarn Changer to correspond with the mark in the Notation Column.

\* There will be no need to reset the Pattern Switch 1.



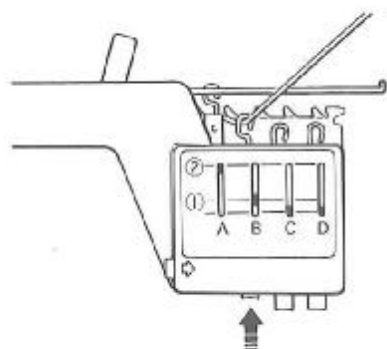

- ②— 1 Press Inspection Switch to turn off the light.  
Bring Holder A to ② position and Holder B to ① position.  
Set Cam Lever to DOUBLE JACQUARD (J).

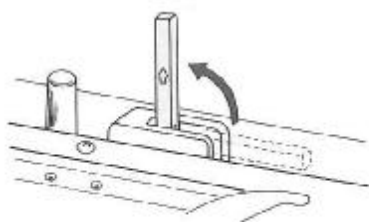

Set Driving Lever to the upright position.

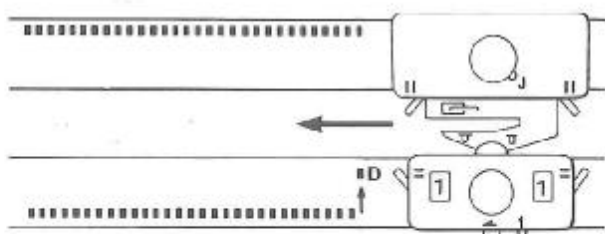

Bring one end needle of Ribber on Carriage side to D position.  
Knit 1 row from the right to the left.

*Be sure to move the Carriage to the extreme left until Auto-set Lever is operated by Driving Cam. Make sure that the Driving Lever operates Feeding Lever, and the yarn in the Main Yarn Feeder is exchanged for the yarn in Holder B.*

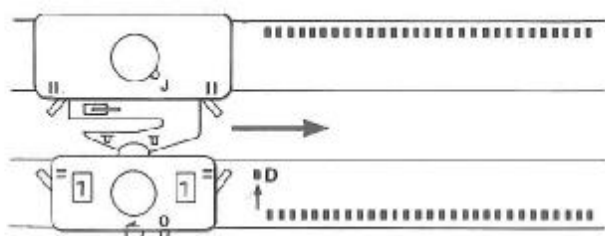

- 2 ~ 3 Pushing the end Carriage side Ribber needle to D position, continue to knit.

The operation of Auto-set Lever in Double Face Knitting is as follows:—

Set Lever "1".....Main yarn is knitted.  
Set Lever "0".....Contrast yarn is knitted.

※ If you set the Lever at "0" on Operation Table ②-1, contrast colour shows on the back of the fabric.



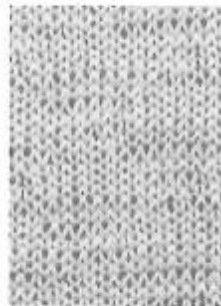
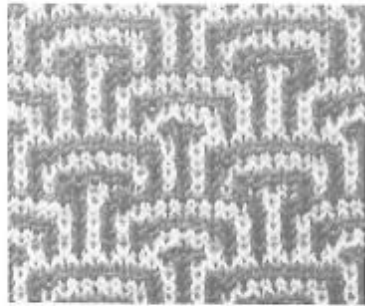

## (2) Using Pattern Card for Slip Stitch

Fabric with multi-coloured Slip Stitch on the Knitter side, and a plain colour on the Ribber side can be knitted by using a Pattern Card in conjunction with the Auto-set Lever

The sample is knitted with the Pattern No.1 (12), using thin yarns.

Use Close Knit Bar.

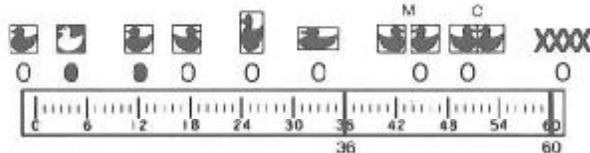

			A	B	C	D																	
①	1				①	①	①	①		0		0	1		1	1	0				H	5	
	2																						
	3																						
	4								C	1	0					1							
	5								O	3	1					3							
	6		Hook contrast yarn on Holder B. Install Driving Cam.																				
	7				②	①									*								
②	1				①	②			S							0							
	2				②	①										1							

\*Set up Automatic Yarn Changer.

{	A..... Holder A	} positions of Holders
	B..... Holder B	
	C..... Holder C	
	D..... Holder D	

① — 1 ~ 6 Set machine controls as instructed, and knit in the same manner as for "(1) Using Pattern Card for Fair Isle". (refer to page 97.)

— 7 Bring Holder A to ② position and Holder B to ① position.

Set Driving Lever to the upright position.

Knit 1 row from the right to the left.

**Be sure to move the Carriage to the extreme left until Auto-set Lever is operated by Driving Cam and Driving Lever hits Feeding Lever.**

\* If you set the Set Lever to "0", contrast colour will show on the back of the fabric.

Knit the first row of main knitting (left to right) with the Auto-set Lever at "1".

② — 1 ~ 2 Press Inspection Switch to turn off the light and Cam Lever to SLIP(S). Continue to knit.

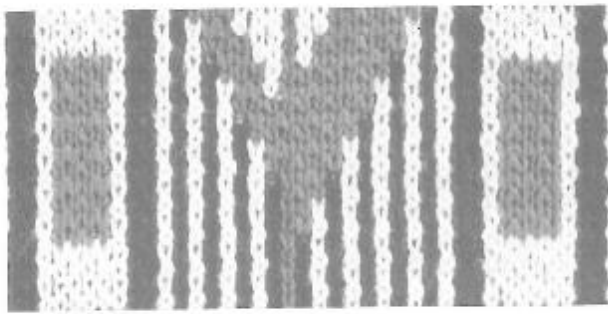

## MULTI COLOURED JACQUARD

Multi Coloured Jacquard is a fabric knitted with more than two colours in one row and having no floats of yarn on its back. Using Yarn Changer (option) and Design Controller (option) pattern is formed on the Knitter side with the Cam Lever set at **S** (SLIP) and Ribber knits on every row.

The sample is knitted with light yarns using the Pattern Cards shown below.

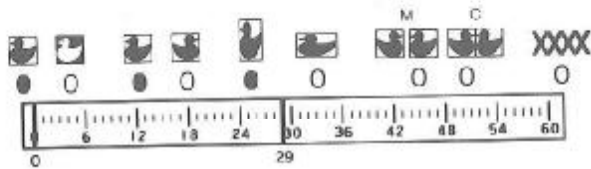

- \* Leave the light of Pattern Switch 6 off.  
Press Pattern Switch 3 at step ① — 6.
- \* Use Close Knit Bar.

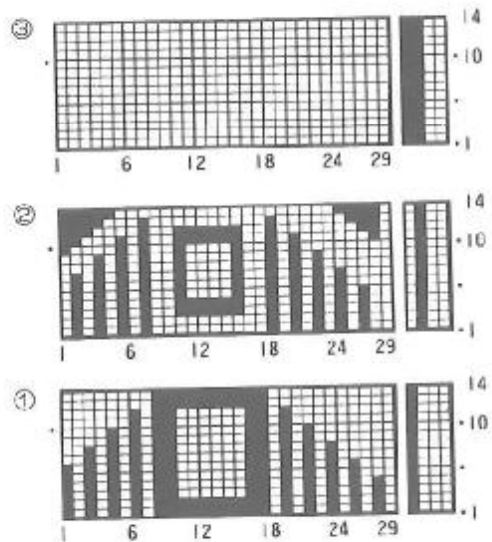

①	1												
2													
3													
4						C	1	0		1			
5						O	4	1		4			
6	Hook contrast yarn on Holder B and C respectively. Press Switch 3 to leave the light on.												
②	1	1		②		①			S				
2				②	①								
3				①	②								
4					②	①							
5					①	②							
6				①		②							

- \*Set up Automatic Yarn Changer.
- |        |          |   |                        |
|--------|----------|---|------------------------|
| A..... | Holder A | ① | } positions of Holders |
| B..... | Holder B | ② |                        |
| C..... | Holder C |   |                        |
| D..... | Holder D |   |                        |

## Cast-On

- ① — 1 ~ 4 Set machine controls, arrange needles as instructed, and work cast-on.
- 5 Change machine controls and knit 2 rows.
- 6 Hook contrast yarn on Holder B and C respectively.  
Press Switch 3 so the light comes on.  
*N.B. Make sure of pressing No. 3 Switch ON just before starting main knitting.*

## Main Knitting

- ② — 1 Press Inspection Switch so the light comes off.  
Set Cam Lever to **S** (SLIP).  
Set Driving Lever to upright position.  
Knit 1 row from the left to the right.  
Bring Holder A to ② position and Holder B to ① position.
- 2 Knit 1 row from the right to the left.  
Make sure that the Driving Lever operates Feeding Lever and the yarn in the Main Yarn Feeder is exchanged for the yarn in Holder B.
- 3 Knit 1 row from the left to the right and bring Holder B to ② position and Holder C to ① position.
- 4 Knit 1 row from the right to the left.
- 5 Knit 1 row from the left to the right and bring Holder A to ① position and Holder C to ② position.
- 6 Knit 1 row from the right to the left and repeat steps ② — 1 ~ 6.

## HELPFUL HINTS

### CONTENTS

	page
IF YOU WANT TO .....	103
To unravel the knitting on the machine .....	103
To change the pattern controls or the other settings of the machine during pattern knitting .....	104
In case of knitting Double Jacquard .....	105
To knit Double Rib which looks like the same as Double Jacquard .....	105
To turn off the Controller during knitting .....	106
To knit Stockinet during pattern knitting .....	106
To knit a selected pattern row repeatedly .....	106
To check the knitted row with the pattern on the Pattern Card .....	106
WHAT TO DO IF .....	107
If the Standard Carriage has jammed .....	107
If the Lace Carriage has jammed .....	108
If the Carriage has jammed during Rib knitting .....	109
If P Carriage has jammed .....	109
If a stitch has dropped during knitting .....	110
If a stitch has dropped when the Ribber is in use .....	111
If stitches float when the Ribber is in use .....	111
If incorrectly knitted .....	112
If the warning buzzer sounds during knitting or if you notice that you are knitting incorrectly .....	114
If the Carriage has been removed from the Needle Bed .....	114
If the end stitches are not stable or if the Carriage is heavy to operate .....	115
If the Ribber Arm does not fit on the Standard Carriage properly .....	115
If you knit only on the Knitter with the Ribber connected .....	115
If a needle has been damaged .....	116

## IF YOU WANT TO.....

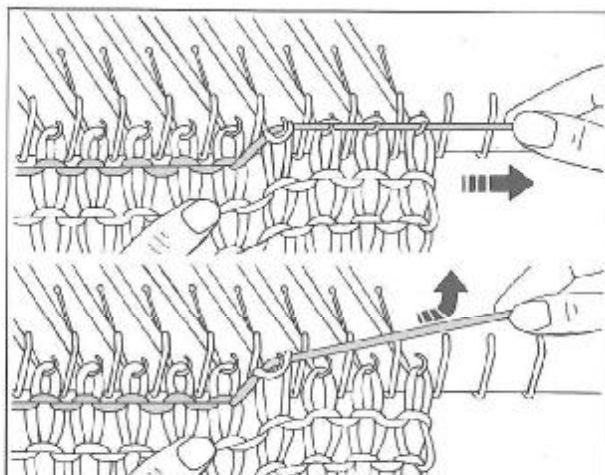

### To unravel the knitting on the machine

IN CASE OF UNRAVELLING THE KNITTING ONLY ON THE KNITTER:

1. Hang the Claw Weights on both edges of the knitting.
2. Holding the knitting downwards with your left hand, pull yarn sideways.
3. Lift the yarn upwards and very slightly backwards. The stitches of previous row slide back into needle hooks.

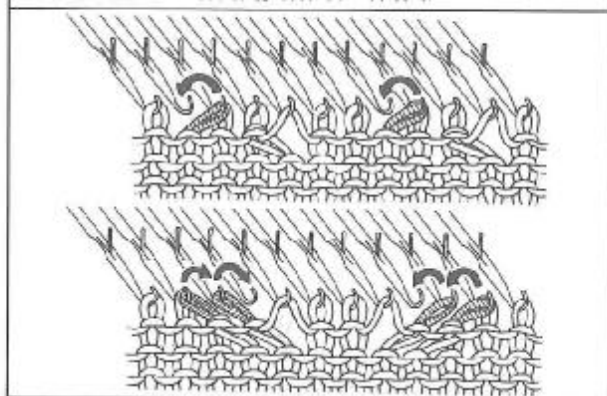

### IN CASE OF UNRAVELLING THE LACE KNITTING:

*Place the transferred stitches back on their original needles before unravelling.*

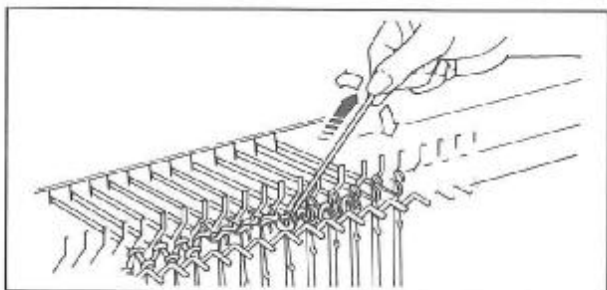

### IN CASE OF UNRAVELLING RIB STITCHES:

Hold yarn and unhook it from Knitter and Ribber needle hooks by pulling it in the arrowed directions in a zigzagging manner until yarn comes to Carriage side.

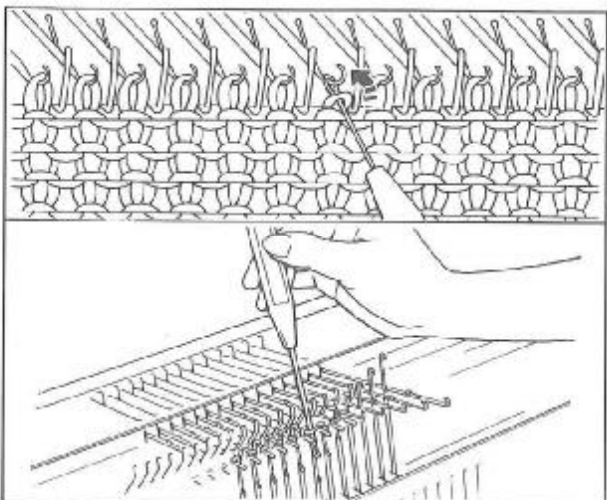

Ensure all stitches are in the needle hooks and the needles are in B position.

If some of stitches are not in needle hooks, place them into the hooks using the Transfer Tool.

Repeat the above procedure until the required number of rows have been unravelled.

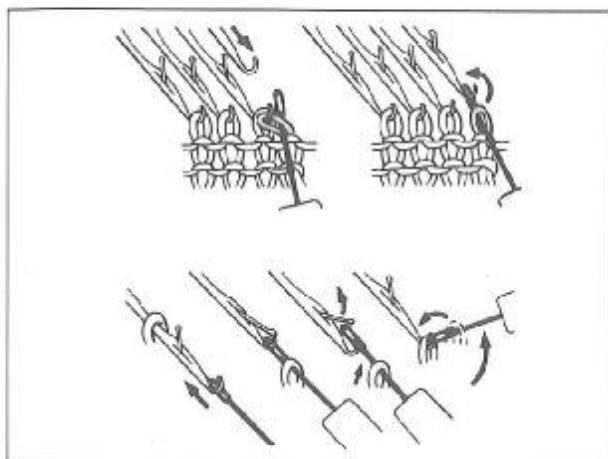

**IF THE KNITTING HAS BEEN SHAPED BY DECREASING OR PARTIAL KNITTING:**

(The knitting with decreased edge)

On the decreased edge, the end needle has two stitches. Place one stitch back to its original needle.

(In the course of partial knitting)

Replacing the stitches in the needle hooks, push back the needles in D position to B position using Transfer Tool.

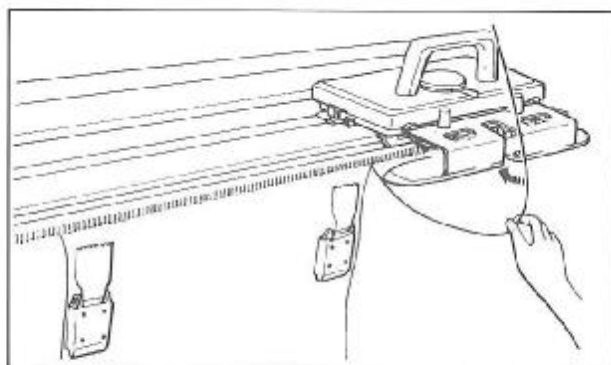

To continue knitting, pull the unraveled yarn back towards the yarn ball at the back of the Tension Rod, move the Carriage to the side of the yarn using Release Lever, adjust the Row Counter, and replace the yarn in the Yarn Feeder.

If the Pattern Card is in use, return it by the same number of rows as you have unraveled. (Refer to pages 112 ~ 113.)

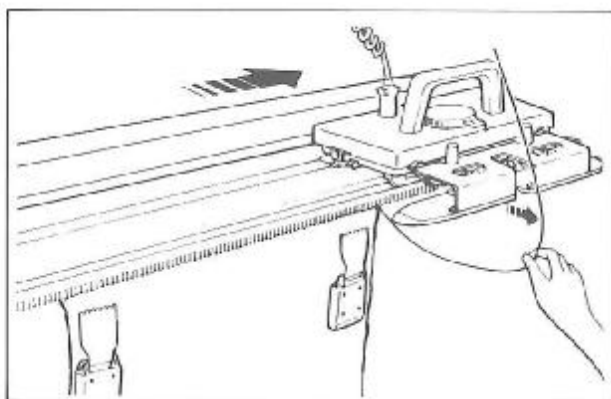

**To change the pattern controls or the other settings of the machine during pattern knitting**

Before changing the Pattern Controls or the other settings of the machine, make sure the Carriage is outside of the Point Cams. Remove the yarn from the Yarn Feeder.

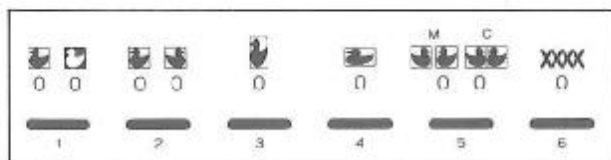

**TO RE-SET THE PATTERN SWITCHES**

Press "ON" or "OFF" the selected Pattern Switch, and continue knitting.



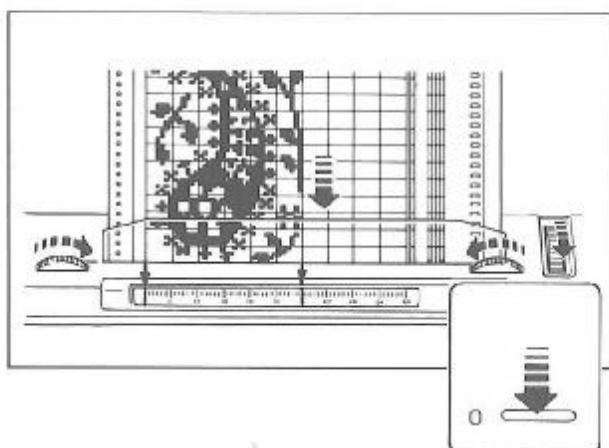

#### TO CHANGE THE PATTERN WIDTH INDICATOR OR THE PATTERN CARD

Press "ON" the Inspection Switch. (Light is on.)

Re-set the Pattern Width Indicator, or exchange the Pattern Cards.

Press "OFF" the Inspection Switch and start knitting.

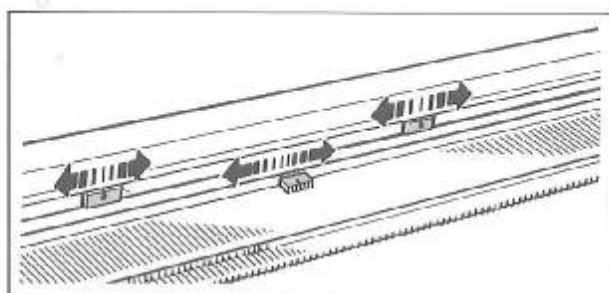

#### TO CHANGE THE POSITIONS OF BOTH POINT CAMS AND/OR NEEDLE-1 CAM

Press "ON" the Inspection Switch (light is on). Move the Point Cams and/or Needle 1 Cam to the new positions.

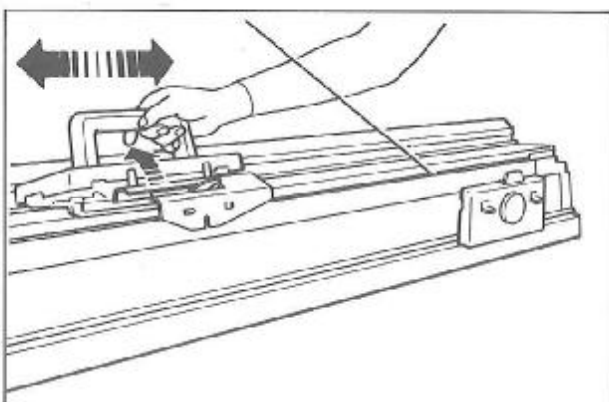

To memorize the new positions of the Point Cams and/or the Needle-1 Cam, move the Carriage twice without knitting (by using the Release Lever).

(If the Ribber is in use, disconnect the Ribber Carriage from the Arm and move the Knitter Carriage twice without knitting — by using the Release Lever.)

Re-set the Carriage to the original setting. (Connect the Ribber Carriage.)

Press "OFF" the Inspection Switch and continue knitting.

You can change the position of the Point Cam on the side opposite the Carriage, without moving the Carriage to memorize the new position. (Refer to page 26.)

#### In case of knitting Double Jacquard

Place the Carriage on the right side and follow the procedures above.

Press the Pattern Switch-6 just before knitting Double Jacquard and make sure that the right light of the Pattern Switch-1 is lit.

#### To knit Double Rib which looks like the same as Double Jacquard

- 1 — After the pattern in Double Jacquard has been completed, press the Inspection Switch so the light comes on.
- 2 — Set the Pattern Card at the blank position of the Card.
- 3 — Press the Inspection Switch to read the blank position.
- 4 — Press the Inspection Switch so the light comes on and continue to knit in the same manner as for the ordinary Double Jacquard.

If you knit Double Jacquard in combination with Double Rib, the knitting effect is different.

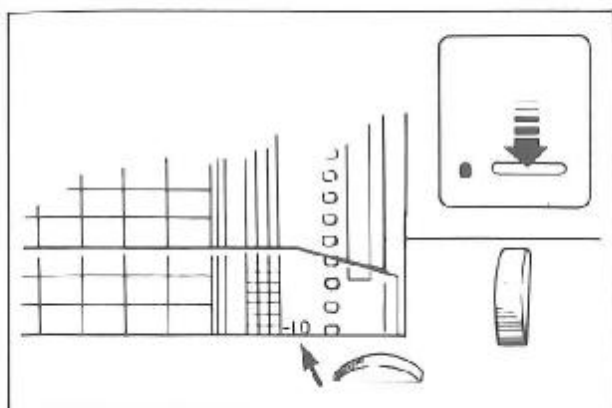

### To turn off the Controller during knitting

With the Inspection Switch on, note the row number shown at the Card Slot before turning off the Controller.

To start knitting again,

1. Turn on the Controller, and press "ON" the Inspection Switch.
2. Move the Carriage twice to memorize the positions of the Point Cams and Needle-1 Cam.
3. Set the Pattern Card so that the noted row number is above the Card Slot. (Inspection light is on.)
4. Repress the same Pattern Switch as the original setting.
5. Press "OFF" the Inspection Switch to read the row to be knitted next. (Light is off.)

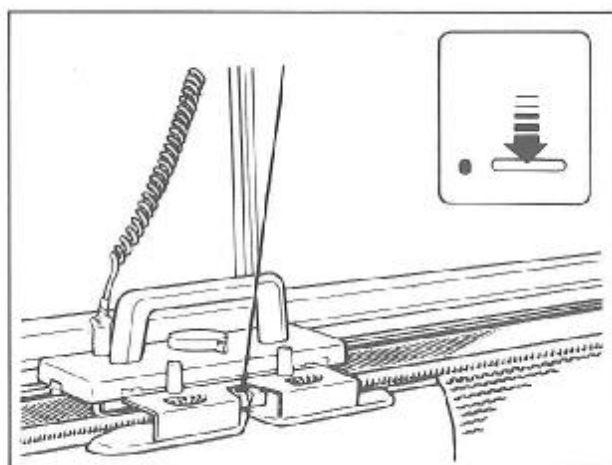

### To knit Stockinet during pattern knitting

Press "ON" the Inspection Switch (light is on), and knit with the Cam Lever at "O" (STOCKINET).

*If you fail to press "ON" the Inspection Switch, the Pattern Card continues to advance.*

To knit in pattern knitting again, re-set the Cam Lever to the original position and press the Inspection Switch "OFF".

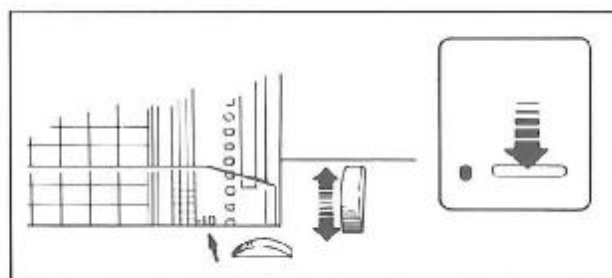

### To knit a selected pattern row repeatedly

1. Press "ON" the Inspection Switch.
2. Set the selected pattern row of the Pattern Card at the Card Slot.
3. Press "OFF" the Inspection Switch, the Card goes in and the selected pattern row is read.
4. Press "ON" the Inspection Switch, the Card comes out and stops. (Inspection light is on.)
5. Start knitting, the same pattern row is repeated.

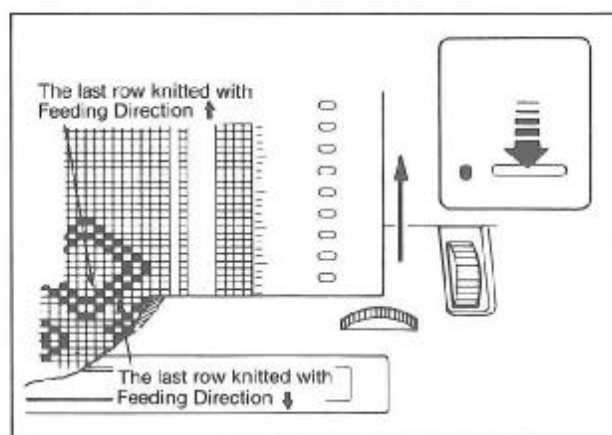

### To check the knitted row with the pattern on the Pattern Card

1. Press "ON" the Inspection Switch, and the Card comes up by 10 rows to show the row to be knitted next, at the Card Slot.
2. Feed the Card an additional row to the direction opposite the Feeding Direction Pointer. This row of the pattern corresponds to the last row knitted.

To start knitting again, return the Card by one row to its original position. Press "OFF" the Inspection Switch.

## WHAT TO DO IF.....

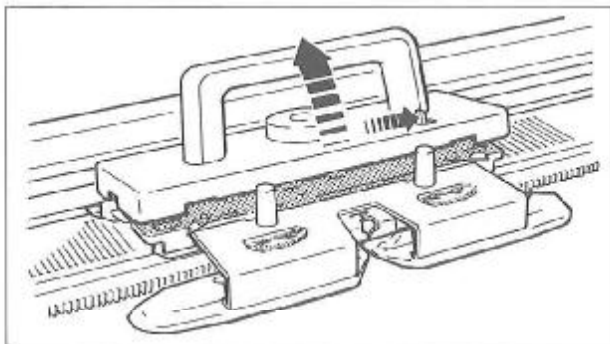

### If the Standard Carriage has jammed...

1. Remove the yarn from the Yarn Feeder.
2. Push the Release Lever in the arrowed direction, and the top of the Carriage lifts up.

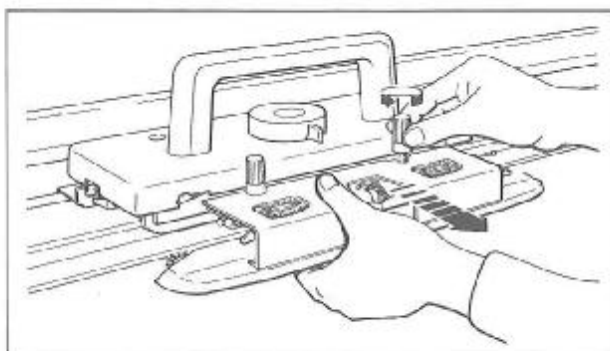

*If the yarn has entangled with the Brushes on the Arm or Yarn Feeder, remove the Arm from the Carriage and disentangle the yarn.*

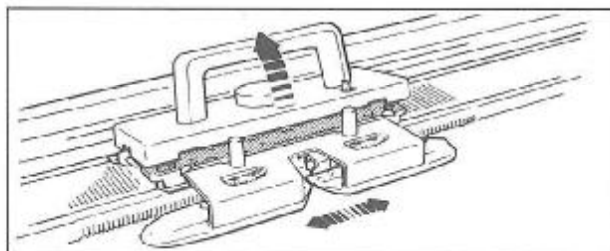

3. With the top of the Carriage up, move the Carriage in the direction it was going till it gets clear of the knitting.

*If the Point Cams are in use, move the Carriage until it passes the Cam.*

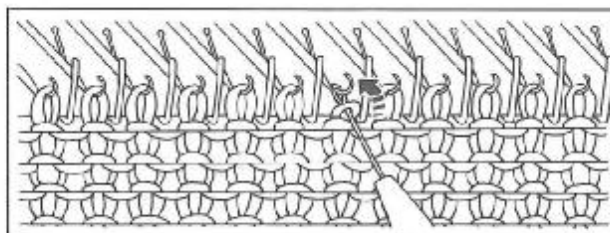

4. Check the stitches, and if stitches have moved behind the latches, replace them into the hooks using a Transfer Tool.
5. Align the working needles in B position and unravel the incomplete row referring to page 103.

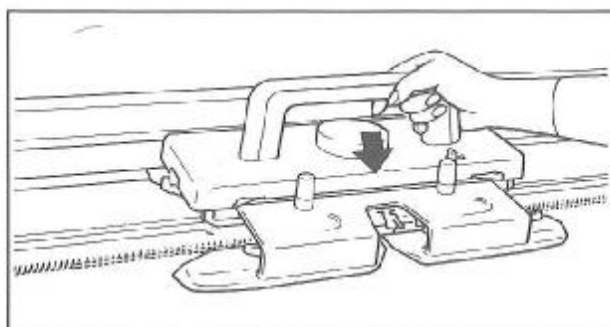

6. With the top of the Carriage up, pass the Carriage to the side with the yarn. Press down the top of the Carriage and continue to knit.

*If the Row Counter, the Knit Contour (Radar) and/or the Pattern Card is/are in use, refer to "If incorrectly knitted..." on pages 112 ~ 113 before continuing to knit.*

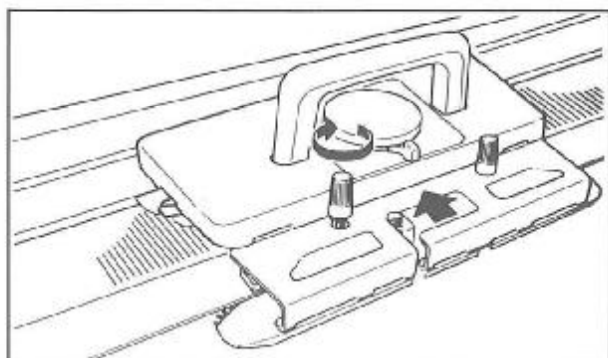
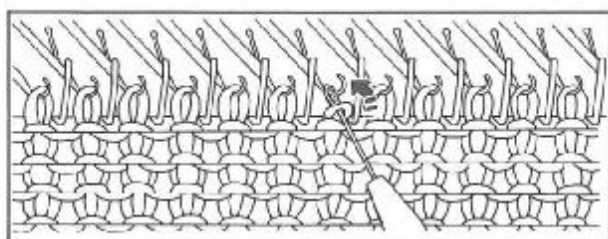
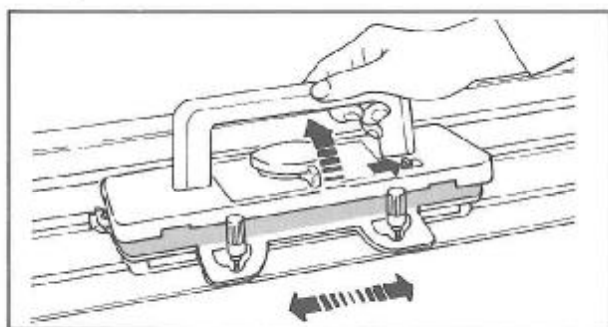
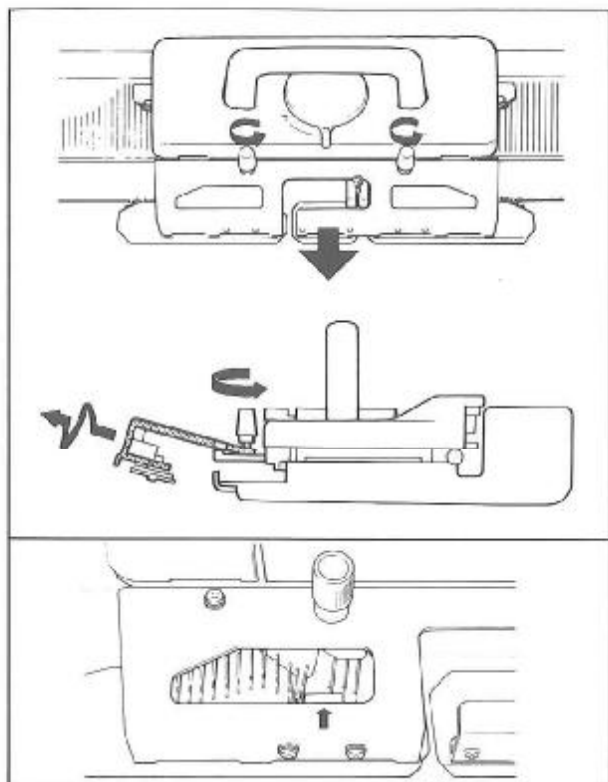

### **If the Lace Carriage has jammed...**

DO NOT FORCE THE CARRIAGE.

1. Remove the yarn from the Yarn Feeder, and loosen the Arm Nuts.
2. Lift up the front of the Arm, and carefully remove it from the needles by moving it up and down.

*If the hooks of the needles are caught in the Arm, carefully remove them using a Transfer Tool.*

3. Push the Release Lever to lift up the top of the Carriage. Move the Carriage in the direction it was going, until it clears the working needles.

4. Check the stitches, and if stitches have moved behind the latches, replace them into the hooks using a Transfer Tool.

5. Align the working needles in B position and unravel the incomplete row referring to page 103.

6. With the top of the Carriage up, move it to the side with the yarn end. Press down the Carriage, replace the Arm, and continue to knit.

*If the Row Counter, the Knit Contour (Radar) and/or the Pattern Card is/are in use, refer to "If incorrectly knitted..." on pages 112 ~ 113 before continuing to knit.*

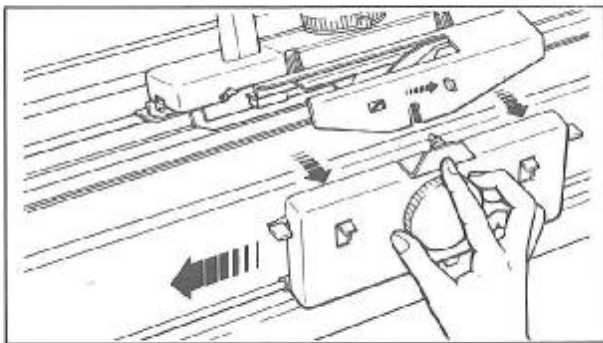

### If the Carriage has jammed during Rib knitting...

1. By pushing the Link Knob, disconnect the Ribber Carriage from the Arm and tilt it towards you, then move it to either end of the Needle Bed.  
DO NOT PUSH OR PULL THE CARRIAGE BY FORCE.

2. Remove the Ribber Arm from the Standard Carriage.

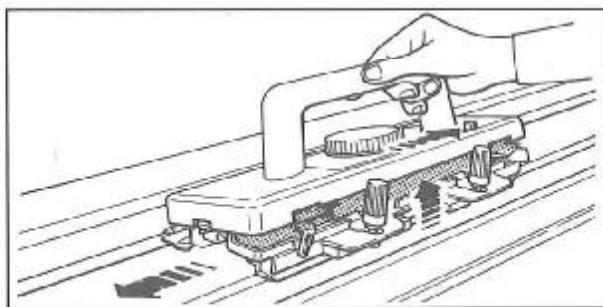

3. Lift up the top of the Carriage by using the Release Lever. Move it in the direction it was going, until it clears the working needles.

*If the Point Cams are in use, move the Carriage until it passes the Cam.*

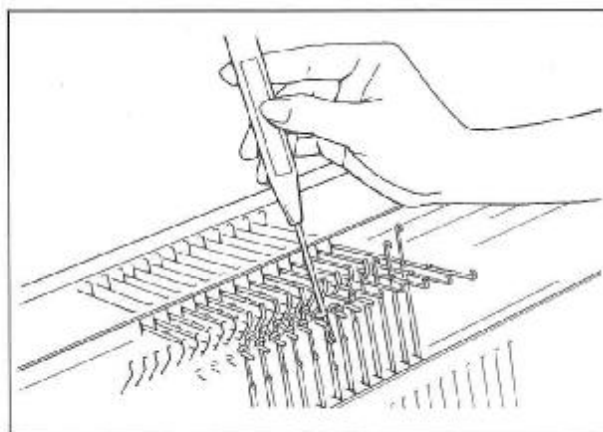

4. Check the stitches, and if stitches have moved behind the latches, replace them into the hooks using a Transfer Tool.
5. Align the working needles in B position and unravel the incomplete row referring to page 103.
6. Move the Carriage to the side with the yarn and press down the top of the Carriage.
7. Connect the Ribber Arm and Carriage to the Standard Carriage. Continue knitting.

*If the Row Counter, the Knit Contour (Radar) and/or the Pattern Card is/are in use, refer to "If incorrectly knitted..." on pages 112 ~ 113 before knitting again.*

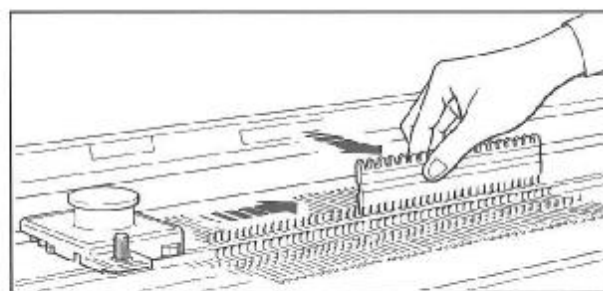

### If P Carriage has Jammed...

If it jammed on the Knitter...

Regardless of direction in which you are moving P Carriage, remove it and push all the needles to D position, then move P Carriage from the left to the right.

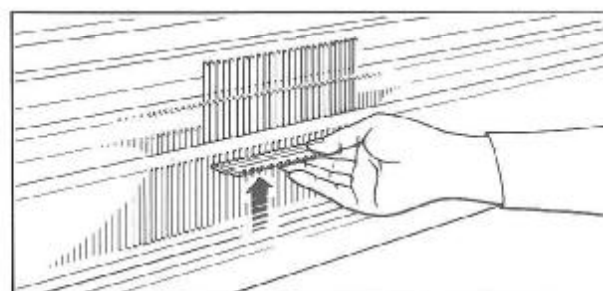

If it jammed on the Ribber...

Remove P Carriage and push all the needles to D position using Needle Pusher, then knit the next row.

*If you have failed to align needles in C position for cast-on using P Carriage, push all the needles to D position and move P Carriage twice across the needles starting from right side. (Needles will align in C position.)*



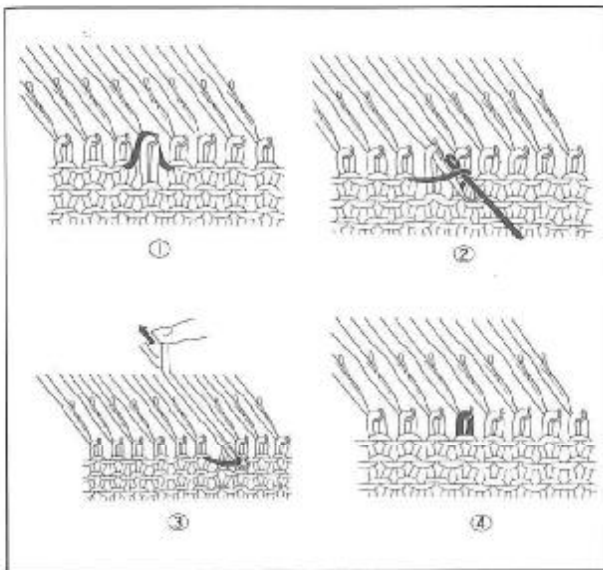

### If a stitch has dropped during knitting...

1. Insert a One-Eye Transfer Tool into a stitch below the dropped stitch and replace it into needle hook together with loose yarn.
2. Slowly pull the needle cut until the stitch is behind the open latch leaving the loose yarn in the hook.
3. Push the needle back so the latch will close and the stitch behind will slide over the hook reforming a stitch as illustrated.

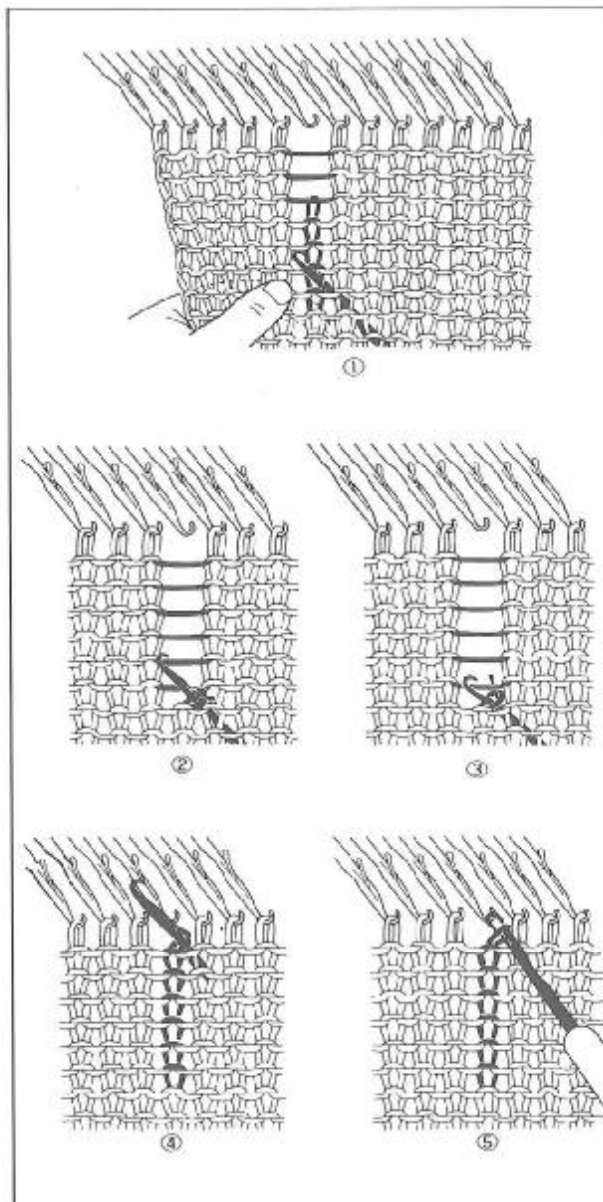

### IN CASE A STITCH HAS DROPPED AND RUN DOWN FOR SEVERAL ROWS:

1. Insert a Tappet Tool into the stitch a few rows below the dropped stitch, from the side away from you. Unravel the stitches down to the Tappet Tool.

**Hint:** With the other hand, pull the knitting downwards. This makes unravelling easier.

2. Push the Tappet Tool towards you so the stitch moves behind the open latch. Catch the yarn crossing above into the hook.
3. By pulling the Tappet Tool backwards, the latch will close and the loose yarn will be trapped in the hook.

4. Continue pulling and the old stitch will slide over the closed latch forming a new stitch in the hook.
5. Repeat this operation up to the top.
6. Place the top stitch onto the needle hook.



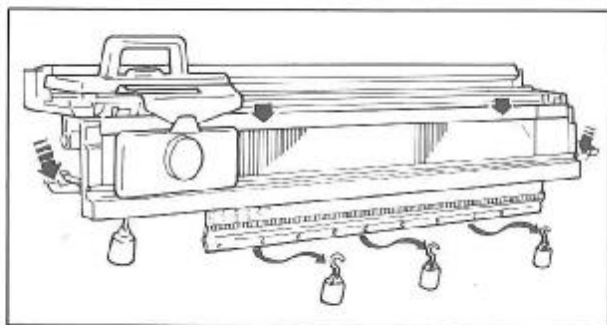

### If a stitch has dropped when the Ribber is in use...

1. Remove Weights from Cast-on Comb as they may cause dropped stitches to run.
2. Depress Drop Levers and bring down Ribber to middle position.
3. With Hook Tool, pick up dropped stitch and place it back on needle hook. Then reform stitches by moving needle back and forth or by using Tappet Tool.
4. Raise Ribber to original position, hook Weights on Cast-on Comb and align needles.

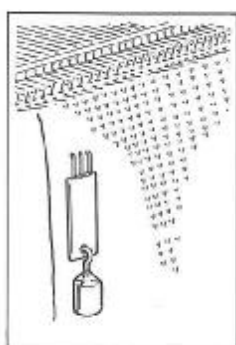
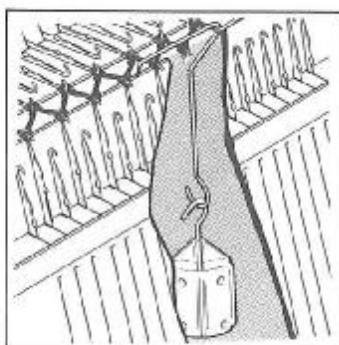
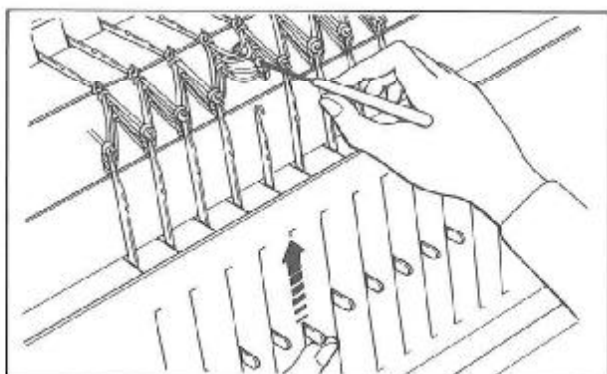

### If stitches float when the Ribber is in use...

If edge stitches tend to float, suspend Edge Weights and advance them every 10 ~ 15 rows.

If stitches of half length of knitting float, check to see if Cast-on Comb with Weights is suspended horizontally.

*Use of Hanger Comb with Weight is also effective.*

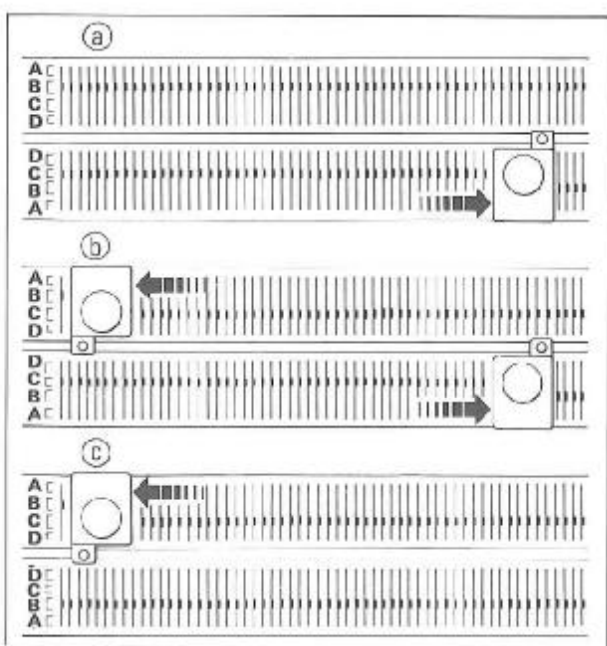

When stitches of full length of knitting float, push needles to C position using P Carriage (without P Presser) and knit.

In case of Circular Knitting, push up needles to D position either on Knitter or Ribber, to whichever is to be knitted next.

In case of Pin Tuck knitting, push up Ribber needles for rows of Pin Tuck knitting. ( a )

In case of Wide Rib, push up Knitter and Ribber needles on every row. ( b )

First, slide P Carriage from the left to the right on Ribber, and secondly slide P Carriage from the right to the left on Knitter.

In case of Variation Swing, push up needles on the bed with more needles. ( c ) or ( c )

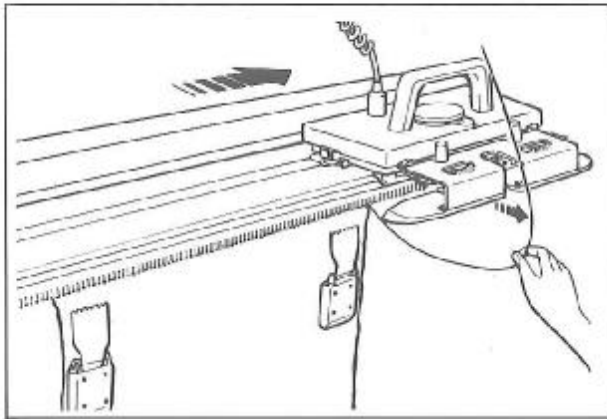

### If incorrectly knitted...

Have the Carriage clear of the working needles and remove the yarn from the Yarn Feeder.

Refer to page 103, and unravel the incorrectly knitted rows.

#### IN CASE OF USING PATTERN SWITCH 3:

If an odd number of rows are unravelled, unravel an extra row making the total unravelled rows an even number.

#### IN CASE OF DOUBLE JACQUARD:

If the yarn end is at the left side, unravel an additional row so that it comes to the right side.

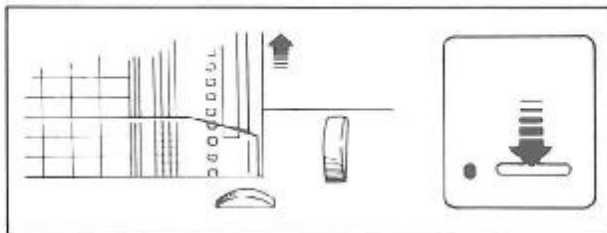

Press "ON" the Inspection Switch. (Light is on.)

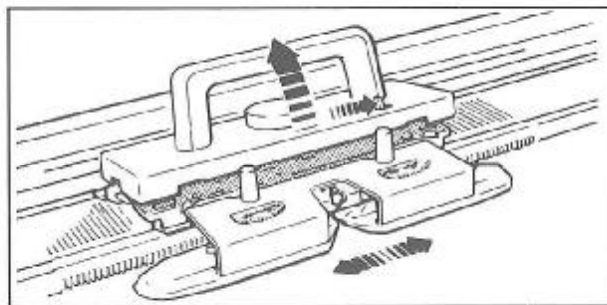

Replace the yarn into the Yarn Feeder, or if the Carriage is on the side opposite the yarn, move it to the side with the yarn following the instructions below.

#### IN CASE OF USING THE STANDARD CARRIAGE:

Using the Release Lever, move the Carriage to the same side as the yarn.

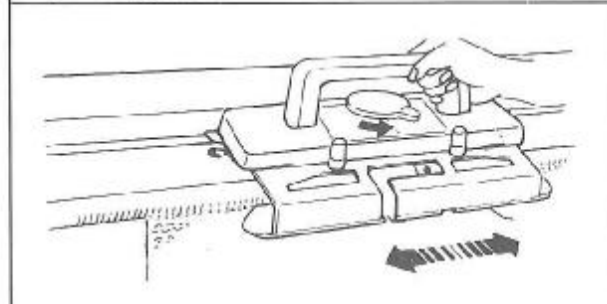

#### IN CASE OF USING THE LACE CARRIAGE:

Remove the Arm from the Carriage.

Push the Release Lever to lift up the top of the Carriage and move the Carriage to the same side as the yarn.

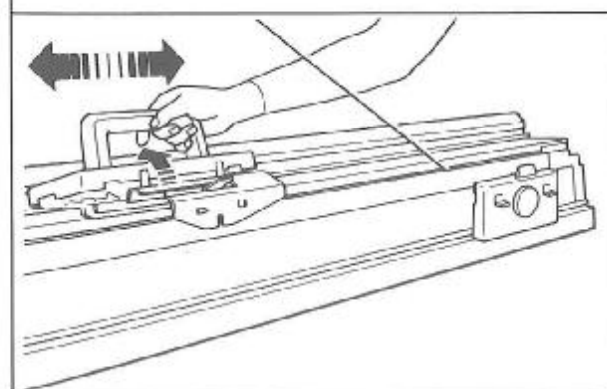

#### IN CASE OF USING THE RIBBER:

- (1) Disconnect Ribber Carriage from Arm and move it to yarn side while tilting Carriage.
- (2) Move the Standard Carriage to the side of the yarn using Release Lever.
- (3) Connect the Ribber Carriage to the Arm.

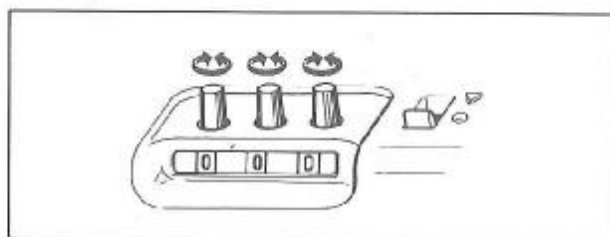

Return the Row Counter by the same number as you have unravelled. (If the Knit Contour (Radar) is in use, return the Pattern Paper, too.)

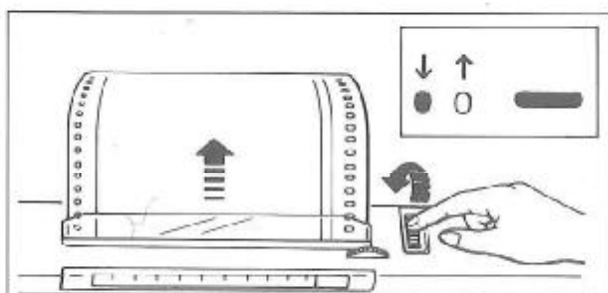

Return the Pattern Card by the same number of rows as unravelled in the direction opposite to that shown by the Feeding Direction Pointer.

A) When returning the Pattern Card, if you reach the first row of the pattern before returning the total rows required, turn the Card to the top row, and count the remaining rows from the top of the Pattern Card.

B) If the pattern is knitted in reverse from the top to the first row, count the rows in the direction reverse to that the Card advances.

*Do not count the top or bottom end row twice.*

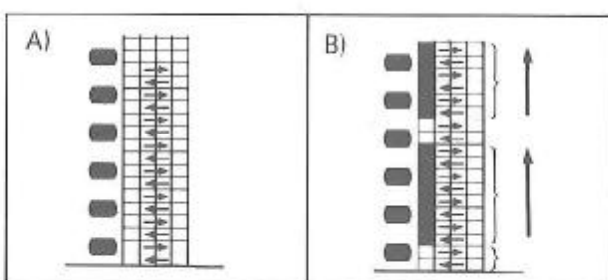
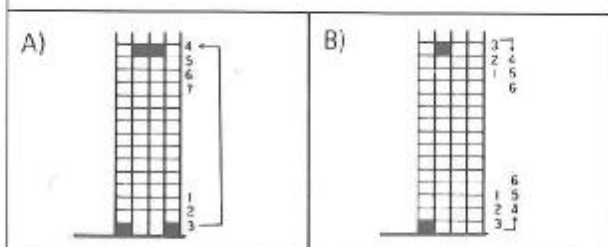

#### IN CASE OF USING PATTERN SWITCH 3:

Return the Pattern Card by half the number of rows unravelled.

#### IN CASE OF LACE STITCH:

Return the Pattern Card by the same number of rows as unravelled, but skipping the rows for transferring stitches which are marked black in the Notation Column.

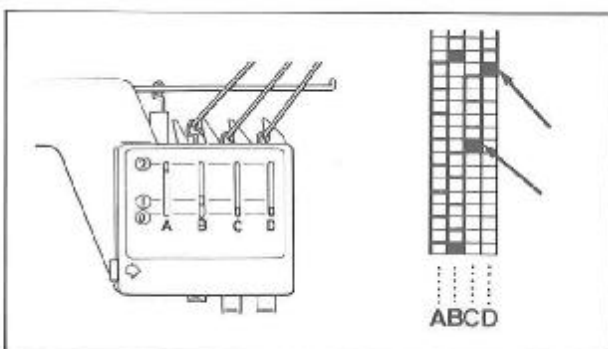

#### IN CASE OF DOUBLE JACQUARD:

With the Inspection Light on:

If an even number of rows are unravelled, return the Card half the number of rows as unravelled.

If an odd number of rows are unravelled, return the Card half the number of rows as unravelled minus one.

Since the two lights of Switch 1 light up alternately on every two rows of knitting, reset the Switch 1 according to the number of rows unravelled.

Re-arrange the Holder Buttons of the Yarn Changer to correspond with the mark in the Notation Column.

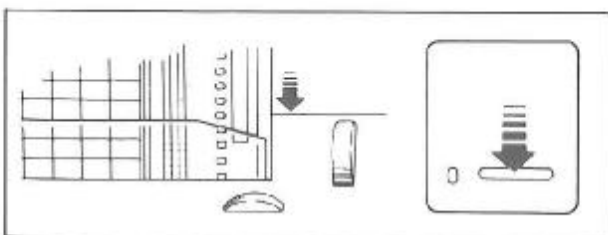

Press "OFF" the Inspection Switch. (The Pattern Card is fed downwards by 10 rows and the row to be knitted is read.)

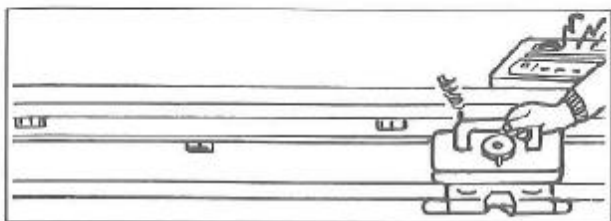

**If the warning buzzer sounds during knitting or if you notice that you are knitting incorrectly...**

If you move the Carriage when the Pattern Card is in quick motion, or if you are moving the Carriage too fast, the warning buzzer will sound.

When the buzzer sounds or you notice a mistake, follow the instructions below.

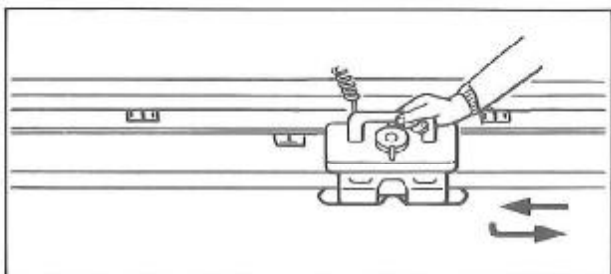

**IN CASE YOU STOP THE CARRIAGE BEFORE THE CARRIAGE ENCOUNTERS OR CLEARS THE SECOND (THE LAST) POINT CAM:**

1. Return the Carriage to the beginning of the row using the Release Lever. (Refer to page 14.)
2. Repair the stitches and unravel the incomplete row.
3. Press down the top of the Carriage and continue to knit.

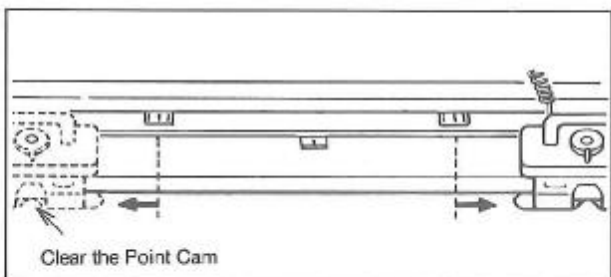

**IN CASE YOU STOP THE CARRIAGE WHEN THE CARRIAGE HAS ENCOUNTERED OR CLEARED THE SECOND (THE LAST) POINT CAM:**

1. Using the Release Lever, move the Carriage in the direction it was going till it clears the working needles.
2. Press "ON" the Inspection Switch.
3. Return the Carriage to the opposite side using the Release Lever.

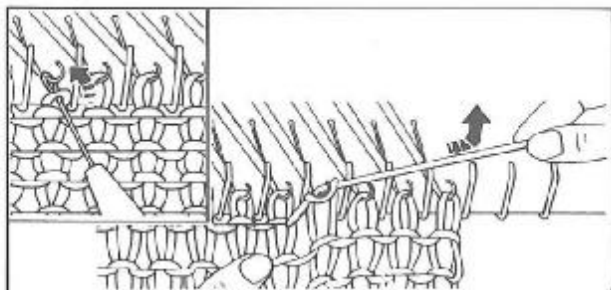

4. Repair the stitches and unravel the incomplete row.
5. Turn back the Pattern Card 1 row.
6. Press "OFF" the Inspection Switch.
7. Press down the top of the Carriage and continue to knit.

*The procedures above is the same as "If incorrectly knitted..." on pages 112 ~ 113. So refer to that procedures.*

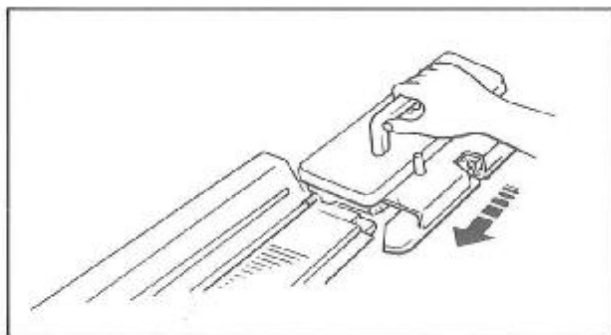

**If the Carriage has been removed from the Needle Bed..**

Replace the Carriage on the Needle Bed by sliding the Carriage Pipe onto the rail.

Ensure that the Carriage moves smoothly across the Needle Bed.

If the Pattern Card is in use, press "ON" the Inspection Switch and memorize the positions of the Point Cams and Needle-1 Cam with the Carriage. Refer to page 105.

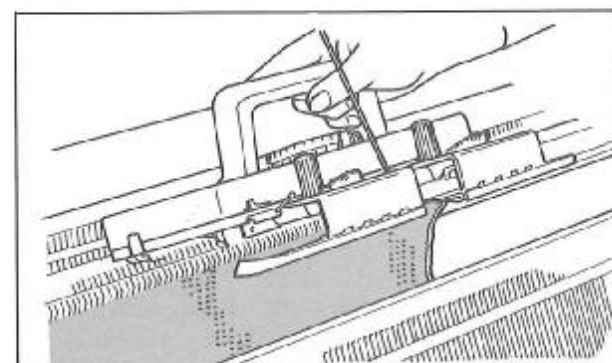
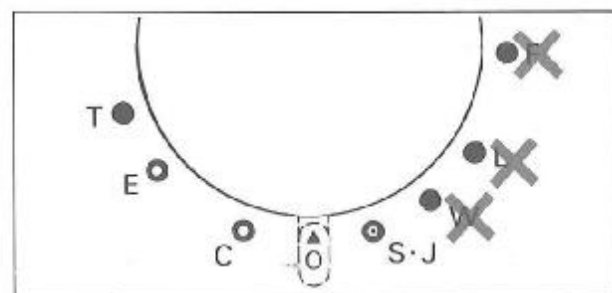
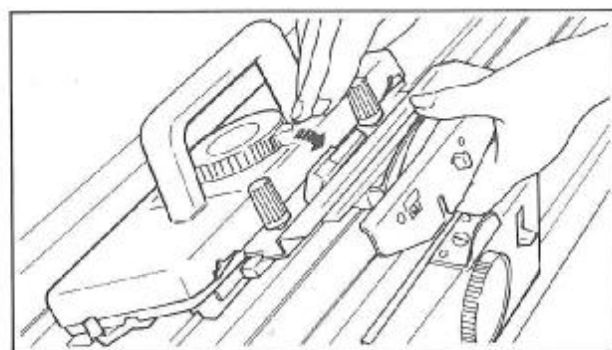
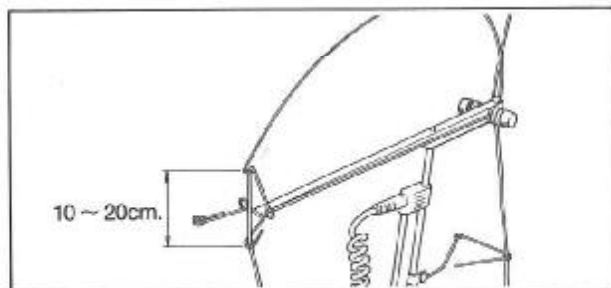
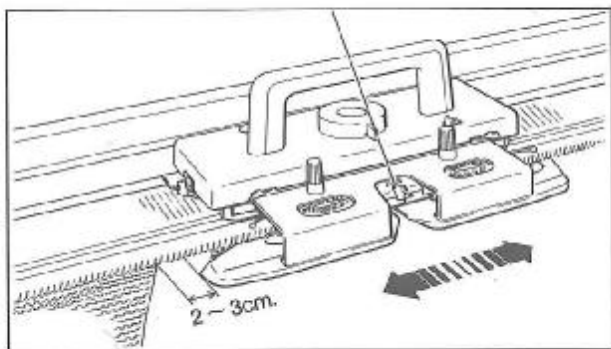

### If the end stitches are not stable or if the Carriage is heavy to operate...

Check the following points.

1. Has the Arm passed the last knitting needle by 2 ~ 3cm. before knitting the next row? (Refer to page 11.)
2. Is the yarn coming out freely from the inside of yarn ball? (Refer to page 7.)
3. Is the yarn threaded into the Auto-Tension correctly? (Refer to page 8.)
4. Is the machine lubricated properly? (Refer to page 117.)

### If the Ribber Arm does not fit on the Standard Carriage properly...

1. Check to see if the top of the Standard Carriage closed properly.  
The top of the Carriage must be down.
2. Check the setting of the Cam Lever. It should be set at **O** before mounting the Ribber Arm, never at **F** (FAIR ISLE), **L** (PUNCH LACE) or **W** (WEAVING).

### If you knit only on the Knitter with the Ribber connected...

1. Disconnect Ribber Arm and Carriage from Knitter Carriage.
  2. Depress Drop Levers twice, and Ribber Bed is lowered to its lowest position.
  3. Fit Knitter Arm and start knitting.
- To use the Lace Carriage when the Ribber is connected, refer to page 44, for special precautions.

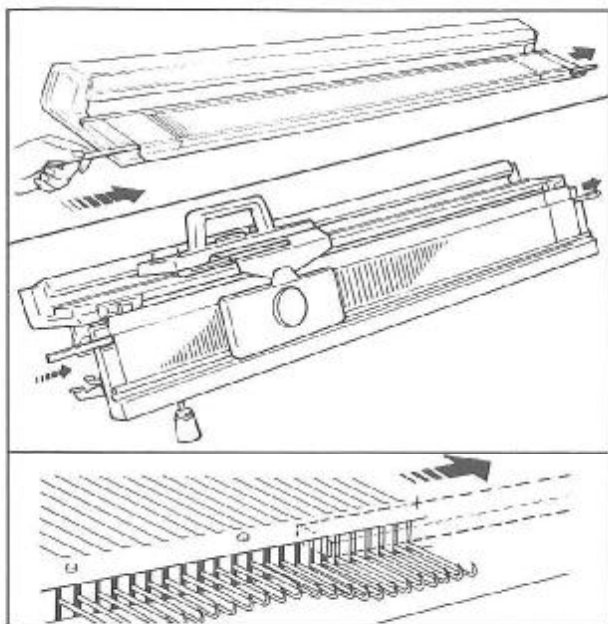

### If a needle has been damaged...

Using a pencil or a screw driver, push the Needle Retainer in either direction.

*If the Yarn Separators are in use, remove them before removing the Needle Retainer.*

Pull the Needle Retainer towards one end until it clears the needle to be replaced.

*If a stitch is hooked on the needle, use the Tappet Tool to pick up the stitch.*

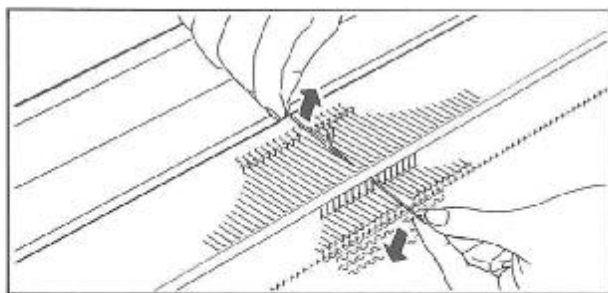

Push the damaged needles to D position. Close the latch and press the needle down. The shank will come out of the Needle Groove.

Lift up the needle by holding the shank and pull it to remove from the Needle Bed.

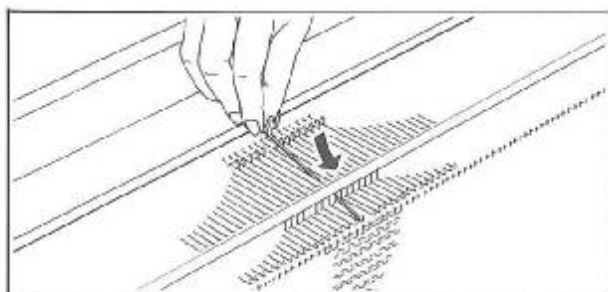

To replace a new needle (see NOTE), open its latch and slide it into the Needle Groove until the hook comes out of the front of the Needle Bed.

Push the needle back to A position by holding the butt.

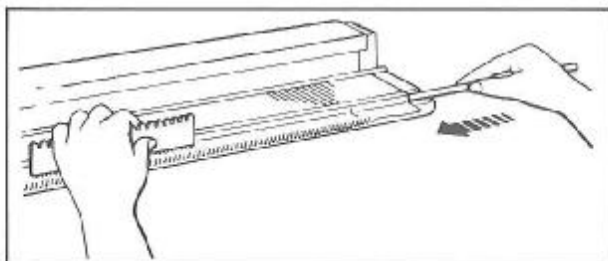

Insert the Needle Retainer back into the Needle Bed by pushing the protruding end. To insert the Needle Retainer, press the floated needles at the front edge of the Needle Bed using the Needle Pusher.

If a stitch is held on a Transfer Tool, replace it on the new needle.

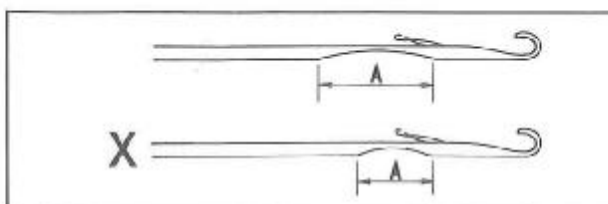

**NOTE:**  
When replacing needles, use only needles specifically for this machine.



## MAINTAINING THE MACHINE

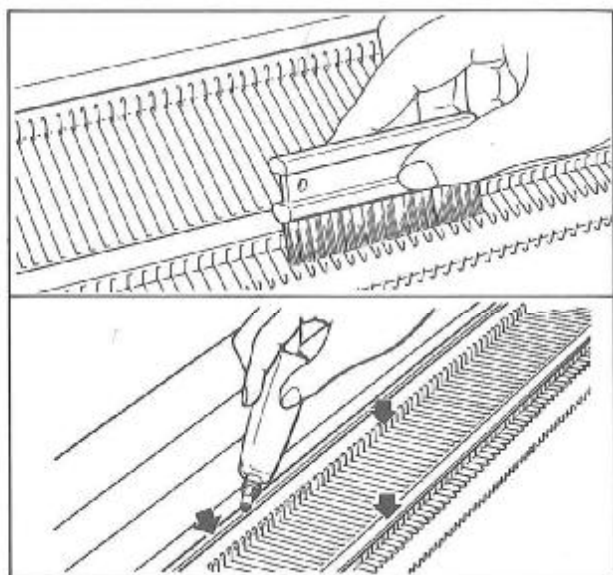

### Needle Bed

Remove all lints from Needle Bed with Cleaning Brush.

Apply oil along the rail and front guide of the Needle Bed.

Wipe needle butts with a piece of oil cloth.

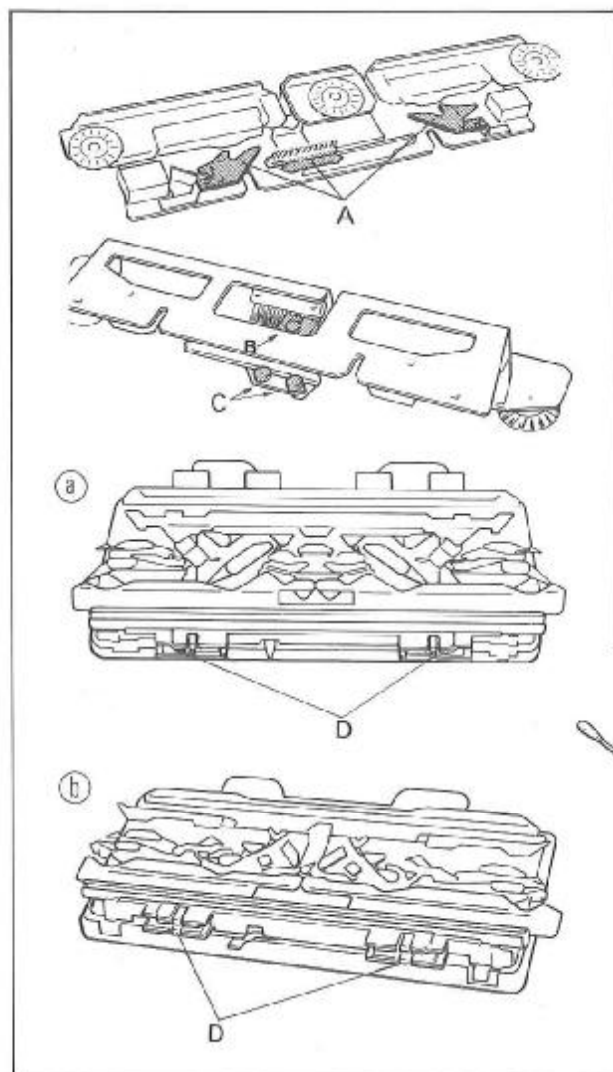

### Carriage and Arm

*The metal parts "A", on the back of the Lace Arm must be handled very carefully, do not bend or scratch them.*

Remove any lints from the Rollers "B" and Yarn Feeder "C" of the Lace Arm using the Cleaning Brush.

Turn over the Standard Carriage ( a ), Lace Carriage ( b ), Ribber Carriage ( c ) and brush off all fluff.

Wipe the Needle Selection Cams, Carriage pipe, slider and other metal parts with the oil cloth.

Clean the Sensors "D" with the Sensor Cleaner "E". Don't wipe the Sensors with the oil cloth.

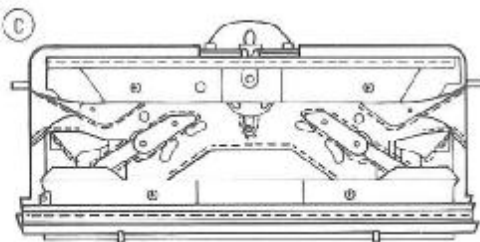

## REPACKING THE KNITTER

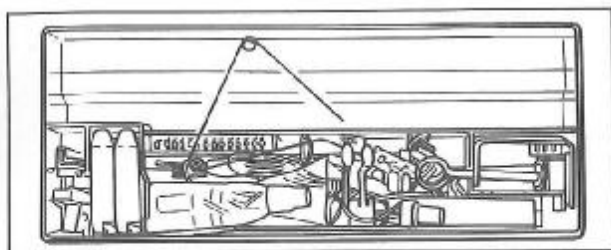

Replace the Accessories in the Accessory Box.

Remove the Pattern Card from the Card Slot.  
Do not fold or bend it.

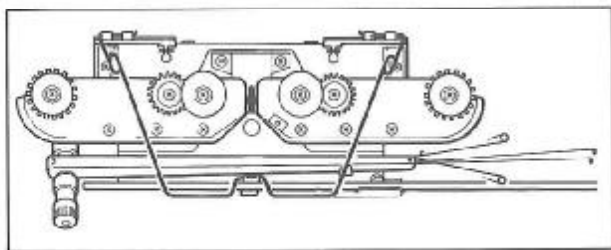

Remove the Auto-Tension and the Knitter Arm from the Knitter Carriage and pack them inside the Top Cover.

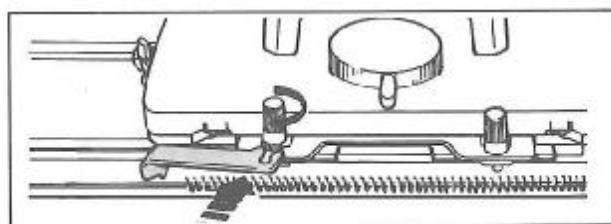

Secure the Carriage to the Needle Bed with the Carriage Fastener.  
Lay the Carriage Handle down.

Replace the Accessory Box on the right end of the Needle Bed.

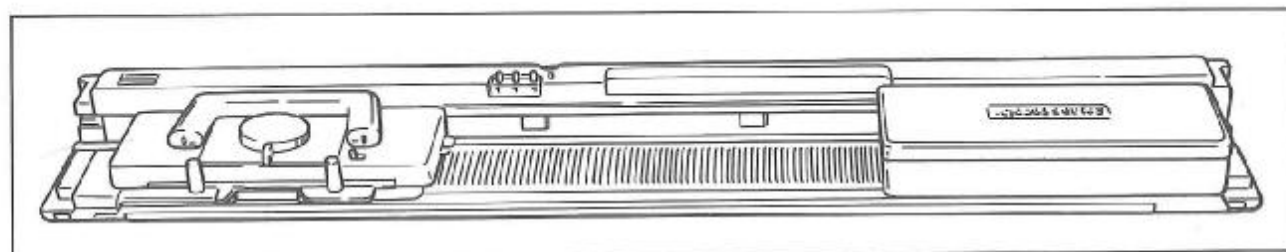

Place the Top Cover onto the Needle Bed.

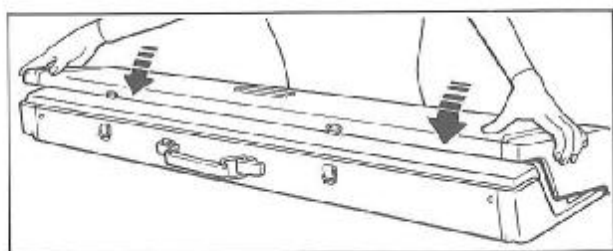

Fasten the latches.

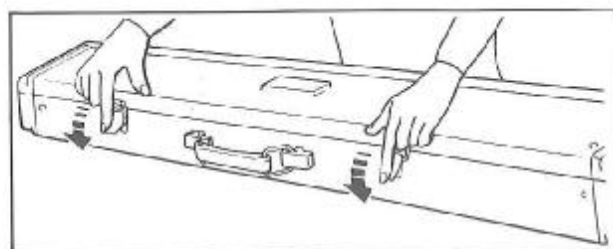

### TO STORE THE MACHINE

Keep the machine away from.

1. Too much moisture.
2. Abnormal change of temperature.
3. Salt or chemicals.