



knitking
magazine

Spring Into Summer

Bright, Bold,
Lightweight Designs

**Classic Styles
For Every Body**

Dresses and Ensembles

**Single Bed
Sensations**

Pullovers, Dresses
and Jackets

**Sensational Stitch
Selections**

Fairisle, Lace, G-Carriage
and More

VOLUME 27 • ISSUE 1

164

165



166



Ben Swartz



Table of Contents

KNITTING MAGAZINE - VOLUME 27 NO. 1

0000	GENERAL INSTRUCTIONS	13
163	MENS BULKY INTARSIAPULLOVER	15
164	WOMENS TWO-PIECE DRESS	18
165	SHORT ROW INTARSIA SHEATH DRESS	19
166	DRESS and JACKET ENSEMBLE	20
167	THREE-PIECE ENSEMBLE	22
168	MENS TUCK POLO PULLOVER	26
169	TWO-PIECE TEA LENGTH DRESS	27
170	RAGLAN PULLOVER with 3-COLOR-IN-ROW FAIRISLE	30
171	TUCK STITCH PULLOVER WITH DOILLIE TRIM	32
172	WOMENS DRESS and LACE PULLOVER	34
173	GARTER CARRIAGE CARDIGAN SET	35
174	WOMENS SHEATH DRESS	37
175	WOMENS CASUAL PULLOVER	38
176	MENS FAIRISLE PULLOVER	39
177	WOMENS BULKY TUNIC	41
178	SLIP and TUCK PULLOVER	42
179	WOMENS FLOWER TOP	42
180	BOYS FAIRISLE JACKET	43
181	COMPUKNIT/BULKY FAIRISLE PULLOVER	44
182	JUNIOR TOP WITH MINI SKIRT	45



Editorial

Dear Readers,

Spring seems to be in the air . . . at least here in California at Knitking headquarters. We're finally drying out from a very wet Southern California winter (much needed I might add) and there is a sense of newness in the air combined with the lovely sweet smell of spring blossoms.

We're celebrating the newness of Spring with a new look for Knitking Magazine. We've taken the suggestions and recommendations of our readers to heart and have made changes that will better meet the needs of our knitters.

One of the reoccurring comments we hear at shows and seminars when knitters see the Knitking Magazine garments is that they seem even more beautiful "in person" than the pretty pictures show. Well, we have a new style of photos in this issue that show every detail of the vibrant and exciting fashions. You can almost count stitches and rows without even looking at the instructions! But we didn't stop there . . . our new layout and instruction section with larger type and a more concise format enables you to knit your favorites more easily.

We've covered the gamut of designs from warm weather elegance (page 3) to evening sophistication (page 7) and everything in between. Whether you like to dress casually (pages 51 and 53) or you just want to "wow" them at the office (page 2 and 5), we've given you all the choices you need to make a sensational garments for yourself, your family and friends. Use your machine accessories like the color changer (Pattern 167 and 168), or the Garter Carriage for a truly gorgeous texture (Pattern 173) and have a ball!

Happy Knitting,

Suzanne Str



Publisher: KNITKING CORPORATION, 1128 Crenshaw Blvd.
Los Angeles, CA 90019. Telephone: (213) 938-2077. Published quarterly.
Subscriptions: USA-\$24.00 annually; single copies \$7.95. \$29.00-all other countries. The entire contents of KNITKING MAGAZINE are copyrighted and must not be reproduced in any shape or form without the express permission, in writing, of the publisher.
© COPYRIGHT 1993 KNITKING CORPORATION

Photography by : LARRY BARTHOLOMEW
Photography Pages 52 & 58 by Nils Vidstrand Studios

167



168



169



170.



171



179

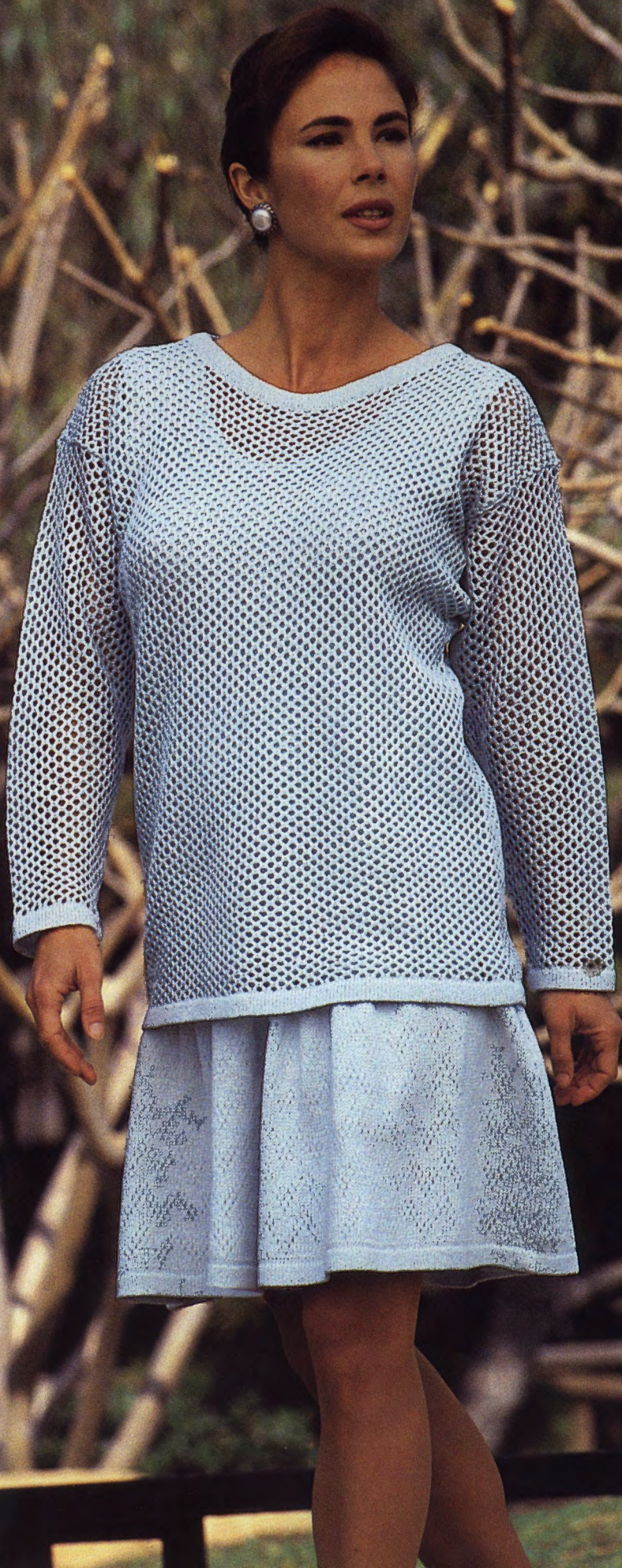

173



Now You Can Knit Your Garments in the Wink of an Eye and the Tap of a Foot!

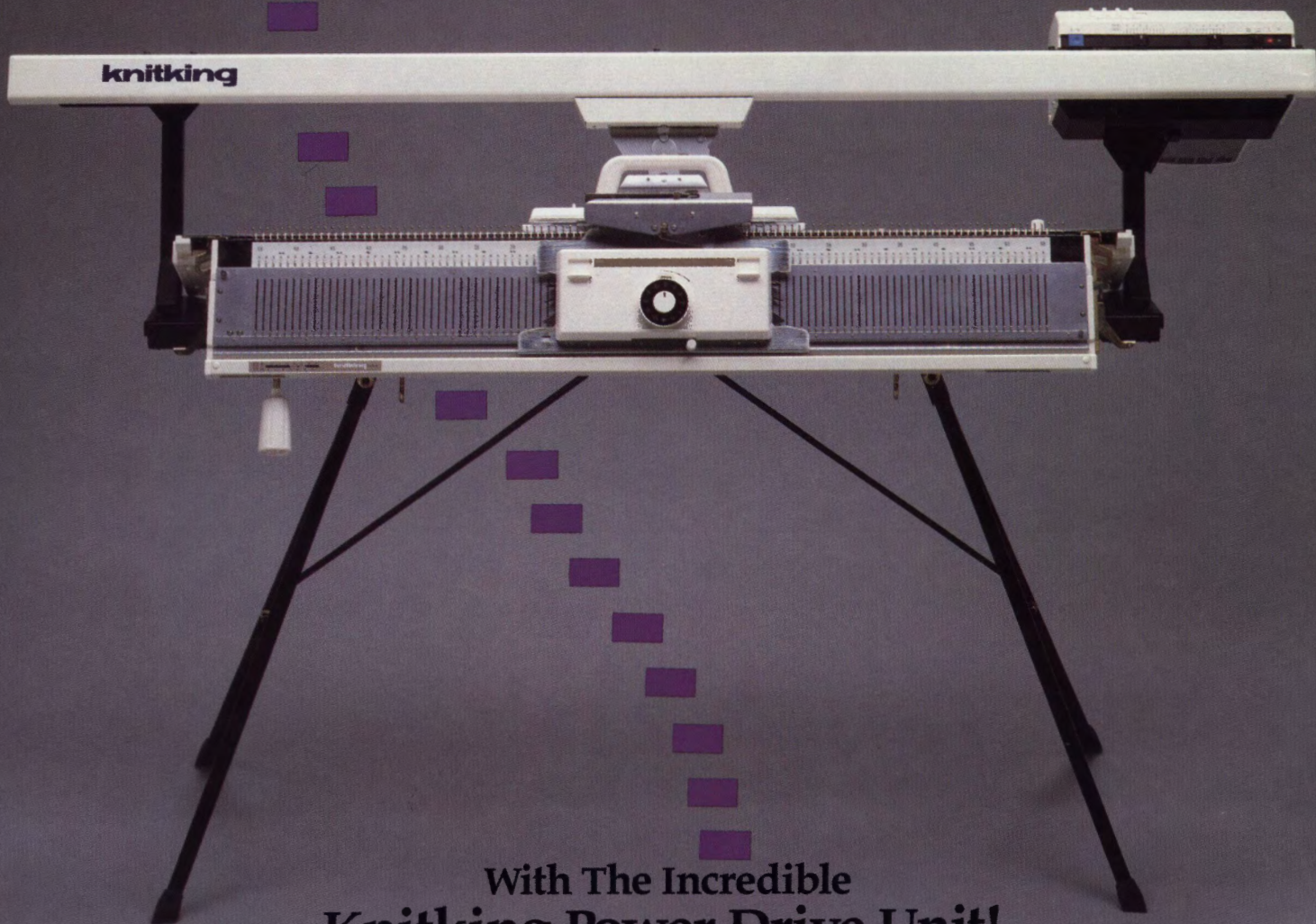

With The Incredible Knitking Power Drive Unit!

It attaches to the carriage of your Knitking knitting machine and, with the push of a button or tap of the foot pedal, automatically moves the carriage back and forth across the knitting bed!

knitking

Where Savings And Value
Are Always In Fashion

1128 Crenshaw Blvd., Los Angeles, CA 90019 213-938-2077

GENERAL INSTRUCTIONS

THE SAMPLE SWATCH

It is imperative that you knit a sample swatch for every garment. Although you may be using the identical yarn and machine model as the pattern suggests, many variables such as dye lot difference, speed of knitting and just machine to machine differences can all cause a variance in the gauge achieved. Knitmagazine publishes the tension and gauge for each garment shown. We strongly urge you to knit a swatch representing three tensions - the recommended tension, and .1 or .2 higher and lower. These different tensions can be knitted in one piece with waste yarn separating the sections. This will eliminate unnecessary rethreading while allowing you to obtain the gauge published in the magazine.

To make a sample swatch on standard gauge machines cast on 60 stitches with waste yarn. Knit approximately 6 rows. *Mark the tension number for your swatch by making holes. For example 4 eyelet holes for Tension 4, 6 eyelet holes for Tension 6. Knit 6 more rows.

Change to garment yarn and reset row counter to 0. Knit 30 rows (in Pattern stitch). With contrast yarn, mark the 10th stitch FROM EACH SIDE by hand. Knit 30 Rows. Change to waste yarn and knit 6 rows. Change tension up or down for second section and repeat from *. Make third section with another tension. Remove on 12 Rows of waste yarn. Remove the sts. from the machine

by pushing the Carriage across without yarn.

Pull and stretch the swatch both lengthwise and diagonally from corner to corner. Gently block the swatch. Treat the swatch as you would the finished garment before measuring the gauge. For example, if you plan to wash this garment and dry it in the dryer, you should do so, measuring before and after to see the difference.

Measure between the stitches marked and the beginning and ending rows for the inches/cms. knitted. Divide the total number of stitches/rows by the inches measured to calculate sts. and rows per inch.

For Bulky knitters, make swatch with 30 Sts. and 30 Rows. If so desired, or for large pattern repeats, we suggest a wider and longer swatch to provide more accurate gauges.

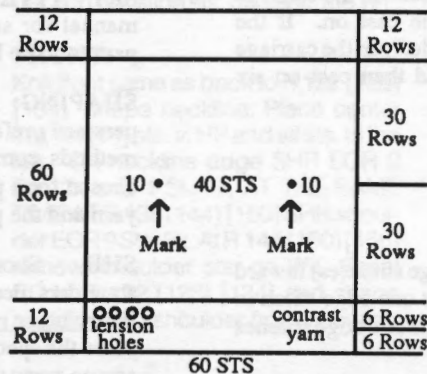

HEMS

Two methods of knitting hems are described below. Variations on these instructions will allow you to knit plain hems, picot edge hems and more.

Method One

With waste yarn cast on the required number of stitches and knit about 10-12 rows ending with the carriage on the left. Knit 1 Row to the right with Ravel Cord. Change to garment yarn and knit 1 Row to the left at garment body tension. (i.e. Skirt at Tension 4, 1st row at T4). Turn tension down approximately 2 full tension numbers lower (tighter) and knit to mid point. (i.e. Row 14 of a 28-row hem). Change tension to 1 full point lower than garment body and knit remainder of hem rows. Pick up the stitches from the first row of garment yarn - shown between the stitches of Ravel Cord. Hem is now completed. Proceed with pattern as per chart and instructions.

Remove waste yarn and Ravel Cord when you have completed section.

Method Two

Bring required number of needles to "B" (working) position. Attach cast-on comb. Beginning with the 2nd needle on the LEFT, bring every other needle to "D" or "E" position. Push in both Part buttons. Knit 1 Row to the left. Release the part buttons and drop the cast-on comb. (DO NOT REMOVE cast on comb from work). Knit required number of rows for hem. Attach weights to the back of work close to the cast-on comb (about 1/4" above the comb). Beginning with the 1st needle on the LEFT, bring every other needle to "D" position. Carefully LIFT the cast-on comb and hang loops onto the needles in "D" position. Turn the comb back away from you and make sure the needles are through the loops. Pull the needles out to "E" position and remove the cast-on comb.

BUTTONHOLES

The following methods of buttonholes are the general manner in which small and large buttonholes are created.

Small Buttonholes in Ribbing
Make small eyelet style buttonholes by following chart below.

Buttonhole Transfer
Center St. of Each Bed to Next St. of Other Bed

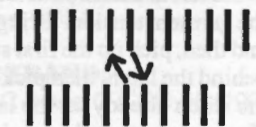

Large Buttonholes in FNR

Vertical buttonholes are made by knitting each side separately (partial or short-row knitting). Knit the right side first, end with yarn on left. Without breaking yarn, knit left side. The strand of yarn inside the buttonhole can be picked up every other row when knitting the left side, but this is not necessary for a small buttonhole.

SHORT ROWS

Method One

With carriage on opposite side start placing appropriate number of ndls in HP. Knit across and wrap the inside needle. Again, place appropriate number of ndls in HP on opposite side from carriage, knit across and repeat wrapping. The wrapping will eliminate any holes in the knitting.

Method Two - Automatic Wrap

Example follows for shoulder short rows. This method can be used for other Short Rowing as well. For example if pattern says to Short Row at shoulder every other row 7 sts, 1 x and 6 sts. 1 x . . . With carriage on opposite side put 6 sts in HP, knit 1 row across and put one additional needle in HP. Opposite carriage place 6 ndls in HP. Knit 1 row across and bring one extra needle to HP. Repeat until shortrowing is completed.

GENERAL INSTRUCTIONS

AT THE SAME TIME - Two functions are to be performed at the same time, such as shaping the neck and shoulder. Be sure to read both instructions before proceeding.

BO - Bind Off. To take off more than 1 St. at a time. When two or more stitches are to be bound off (or cast on) the carriage and yarn must be on the same side as the bind off. If the instruction is, "At R 100 BO 6 Sts on each side.", on the carriage side BO six stitches, knit one row and then bind off six stitches on the other side. See DECR and FF DECR.

BOLT - Slip Stitch Bind Off with a Latch Tool. Knit one row to the left at a tension at least five numbers higher (looser) than the garment tension. Bring all needles to holding position ("E") and then, pick up the first stitch on a latch tool allowing it to slip behind the latch, then pick up the next stitch and pull it through the stitch already on the latch hook, thus creating a slip stitch. If you cannot set the tension at least five full tension numbers higher, knit a row loosely manually.

CO - Cast on stitches for knitting. (CHECK INSTRUCTION MANUALS TO MAKE SURE DIFFERENT METHODS ARE SHOWN) In our instructions, CO is used either for a finished edge at the beginning of the garment, or to add edge stitch(es). If two or more stitches are to be cast on the carriage and yarn must be on the same side as the cast on. If the instruction is, "At R 100 CO 6 Sts on each side.", on the carriage side cast on six stitches, knit one row and then cast on six stitches on the other side.

COR - Carriage on Right

COL - Carriage on Left

DECR - Use the transfer tool to move the edge stitch(es) inward to the next needle. Usually used to transfer one edge stitch to the next needle, but may be used to transfer the two edge stitches to the next two needles.

EON - Every other needle

EOR - Every other row

EOS - Every other stitch

FF DECR - Used to make an even edge for seaming and decorative seams for raglans. If one stitch is to be decreased, use a two-prong transfer tool to move the two edge stitches inward one needle. If two stitches are to be decreased, use a three-prong transfer tool to move the three edge stitches in two needles. If three stitches are to be decreased, use two two-prong transfer tools and move the edge stitches in four needles. See DECR, BO and SHAPING.

FF INCR - To increase one stitch move the two edge stitches outward one needle, then fill the empty needle by picking up a bar from the row below and hanging it on the empty needle.

FNR - Full Needle Rib

G.C. - Garter Carriage

HP - Holding position or "E" position.

INCR - Increase. Usually used for "full-fashion" shaping, see FF Incr., or in conjunction with short row shaping. A simple incr can be made by pulling additional needle on side of carriage out to "E" position and knit across.

MB - Main Bed

MC - Main Color

Ndls - Needles

NWP - Non-working position or position "A"

R(s) - Row(s)

RB - Ribber Bed

RC - Row Counter.

RC 0 - Set RC to zero.

SET PATTERN - Follow the step-by-step instructions in your manual for setting the pattern and carriage controls for the pattern to be knit, e.g., Fairisle, tuck, single motif, etc.

SHAPING: The method used for shaping is a matter of personal preference. In our definitions we have described the methods commonly in use at Knitking. Which method is chosen for a particular pattern depends upon the garment, the yarn and the personal preference of the designer.

SHR - Short Row or Partial Knitting. Used for shaping shoulders, necklines, darts, gores, etc. Set carriage on H(old). **Every other row SHRs:** On the opposite side of the carriage, place the specified number of stitches in holding position, knit across, wrap the inner needle or use an "automatic wrap". After all specified stitches have been placed in HP change the carriage setting to N (knit) to return the needles to WP. **Every row SHRs:** On the side being shaped, place one stitch in HP every row. It is recommended you refer to your manual or an instruction book for detailed instructions about how to short row.

St(s) - Stitch(es)

St. St. - Stockinette stitch.

T - Tension.

WP - Working Position or "B" position.

WY - Waste yarn.

YM - Yarn marker. To place a yarn marker, use a short piece of contrasting yarn and loop it over the needle specified or the end needle of the row specified.

SEAMING GARMENTS

Any number of popular methods are suggested. We encourage you to experiment with any and all. If a garment in Knitking Magazine requires special seaming information it will be provided in the individual pattern instruction. Otherwise, methods include: linking on the knitting machine, Knitking's Lectrolink, the electric linker, crochet slip stitch, tapestry needles with back stitch sewing by hand. Bar to bar weaving for seamless appearance and seaming on a sewing machine.



MENS BULKY INTARSIA PULLOVER

YARN:

Softon
2 strands throughout

SIZES:

Small (Medium) [Large]

AMOUNT:

- C 1: Grey - 2 lbs. all sizes
- C 2: Black - 4 oz. all sizes
- C 3: Red - 2 oz. all sizes
- C 4: Sunset - 4 oz. all sizes
- C 5: Grey Knit-in Elastic
1 spool all sizes

KIT PRICE: \$55.00

TENSION:

Body: T 4
Rib: T 0/0 I

GAUGE:

Body: 4.4 Sts., 5.8 Rs. = 1"

Make on any Bulky Machine with Ribber and Intarsia Carriage.

Note: Reverse intarsia design for Back/Front and Sleeves.

BACK:

With C 1 and C 5 CO 102 (106) [110] sts. for K2/P2 Rib. After selvedge RC 0. T 0/0 I. Knit to R 26. Cut C 5. Transfer RB sts. to MB. RC 0. T 4. Knit in Intarsia Pattern following chart. At R 78 (84) [92] place a YM on each side for armhole. At R 138 (144) [150] shape neckline. Place center 24 (26)

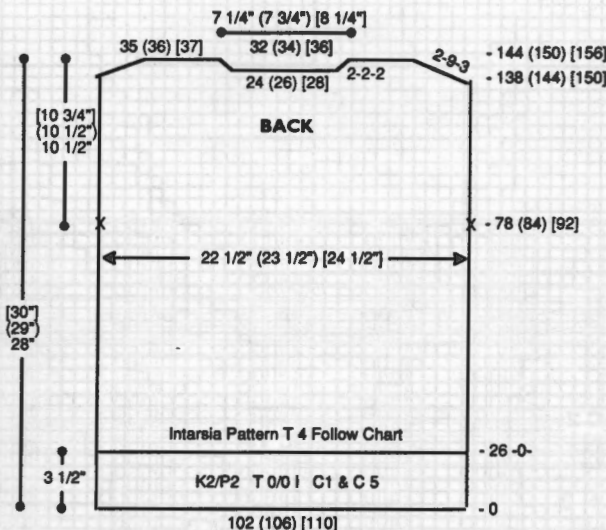

[28] sts. in HP and all sts. to the left. *On neckline edge SHR EOR 2 Sts. 2x. AT THE SAME TIME SHR shoulder EOR 9 Sts. 3x. At R 144 (150) [156] remove shoulder sts. on WY. Reset RC to R 138 (144) [150] and shape neckline and shoulder from *, reversing shapings. Remove shoulder and neckline sts. on separate WY.

FRONT:

Knit front same as back to R 122 (128) [134]. Shape neckline. Place center 10 (12) [14] sts. in HP and all sts. to the left. *On neckline edge SHR EOR 2 Sts. 2x and 1 St. 7x. AT THE SAME TIME AT R 138 (144) [150] SHR shoulder EOR 9 Sts. 3x. At R 144 (150) [156] remove shoulder sts. on WY. Reset RC to R 122 (128) [134] and shape neckline and shoulder from *, revers-

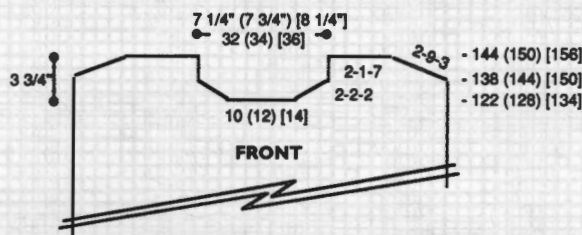

ing shapings. Remove shoulder and neckline sts. on separate WY.

SLEEVE:

Make 1, Reverse 1. With WY CO 68 (68) [70] sts. After several rows, end with 1 row Ravel Cord to the right. RC 0. T 4. Knit in Intarsia Pattern following chart while incr. on each side every 7 Rs. 1 St. 12x [(every 8 Rs. 1 St. 12)] x. At R 92 (98) [104] mark center with YM and remove sts. on WY.

SLEEVE CUFF:

With C 1 and C 5 CO 38 [(42)] sts. for K2/P2 Rib. After selvedge RC 0. T -0/-0 I. Knit to R 26. Transfer RB sts. to MB. With purl side facing, rehang lower edge of sleeve on these ndls. decr. evenly across. Knit 1 row at T 10 and BOLT.

NECKBAND:

With C 1 and C 5 CO 98 (100) [102]

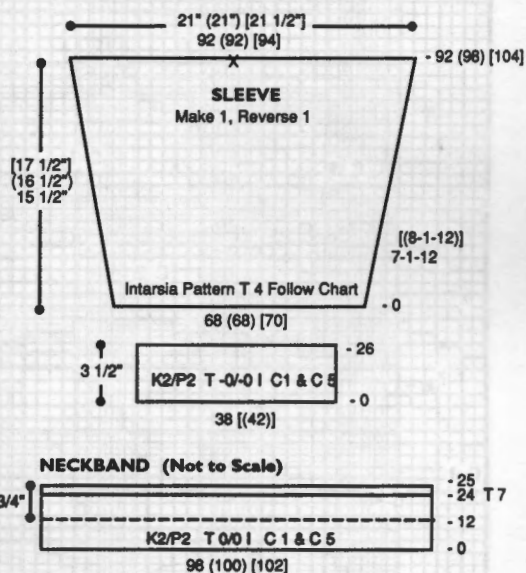

sts. for K2/P2 Rib. After selvedge RC 0. T 0/0 I. Knit to R 24. Transfer RB sts. to MB. Pick up sts. from first row to form doubled band. Knit 1 row at T 7 and remove sts. on WY.

FINISHING:

Close shoulder seams. Attach neckband and sleeves. Close all remaining seams.



Mark your calendar! This year, KNITKING's famous Seminar and Open House will be held from Tuesday, September 28th through Saturday, October 2nd, and will be located, as always, at KNITKING 1128 Crenshaw Blvd., Los Angeles, CA 90019.

Come meet our experts plus many acknowledged guest authorities. Every year offers new guests and new products, and this year is no exception! You'll also enjoy our daily Fashion Shows, and if you're one of the lucky entrants, daily prizes will be awarded as well as a GRAND PRIZE at the close of the Seminar. As always, KNITKING Dealers and employees are not eligible, but if you're not in these categories, start knitting!

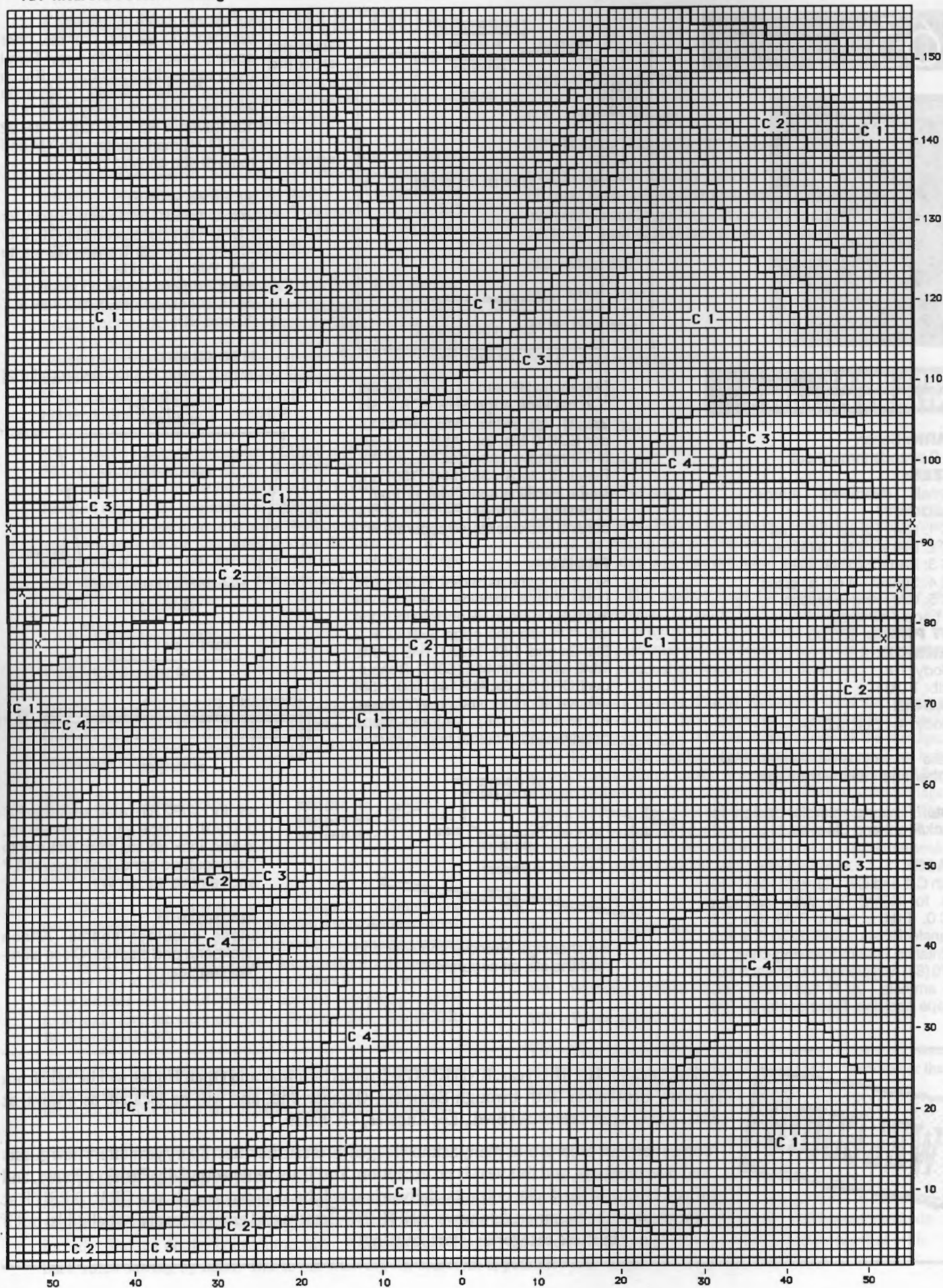

#163 Intarsia Pattern - Sleeve

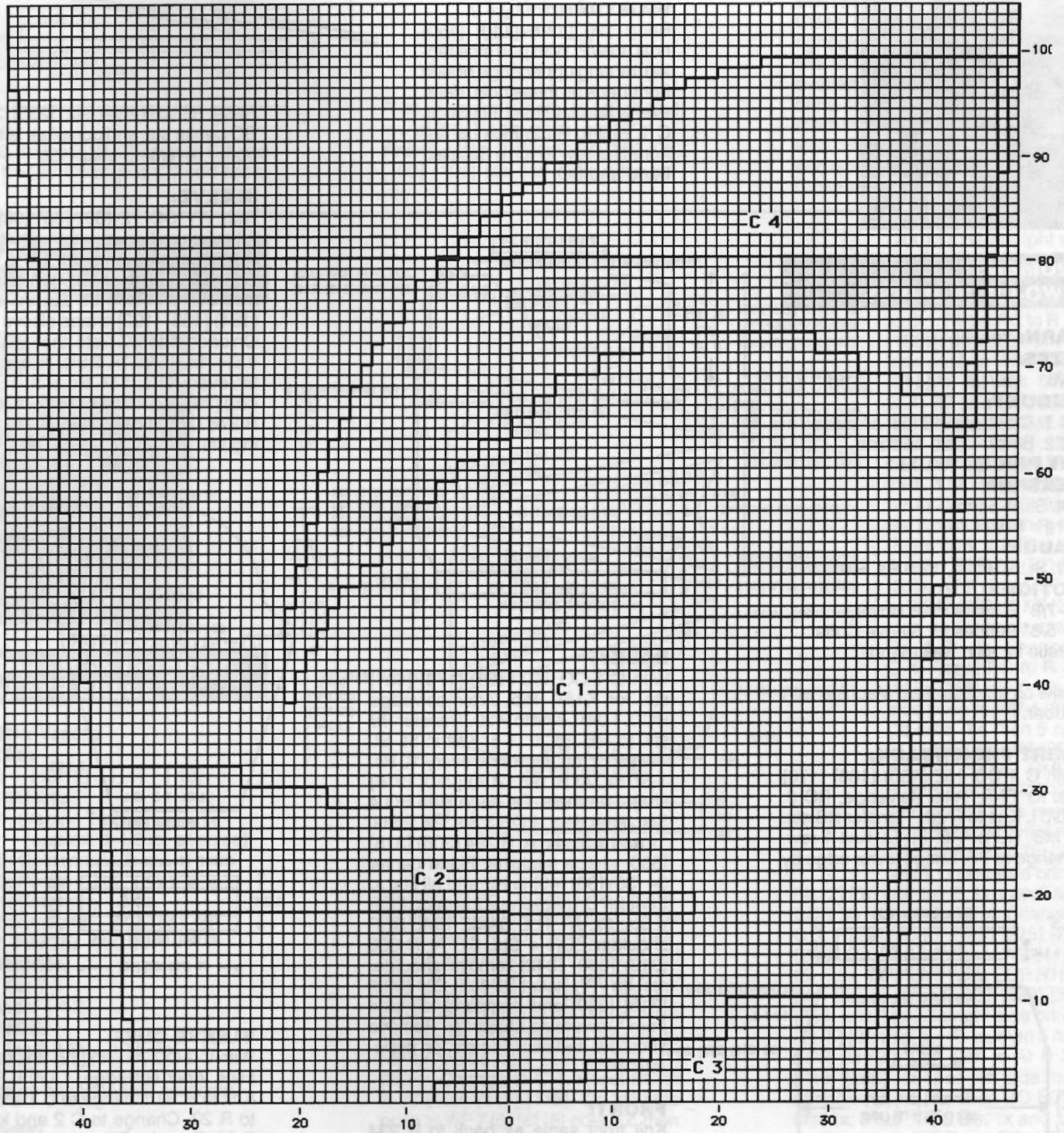



WOMENS TWO-PIECE DRESS

YARN: Venetia

SIZES:

6/8 (10/12) [14] [16]

AMOUNT:

C 1: Cranberry - 2 lbs. all sizes

C 2: Black - 2 oz. all sizes

KIT PRICE: \$60.00

TENSION:

St. St.: T 5

FNR: T 0/0 I

GAUGE:

St. St.: 8.3 Sts., 12.5 Rs. = 1"

NOTIONS:

2 - 7/8" Buttons for Pullover

2 - 5/8" Buttons for Sleeve Cuffs

Elastic for skirt waistband.

Make on any Standard Machine with Ribber.

SKIRT FRONT/BACK:

With C 1 CO 152 (160) [168] [176] sts. for FNR. After selvedge, RC 0. T 0/0 I. Knit to R 20. Transfer RB sts. to MB. RC 0. T 8. St. St. Knit 1 row. Change to T 5. Shape lower edge by

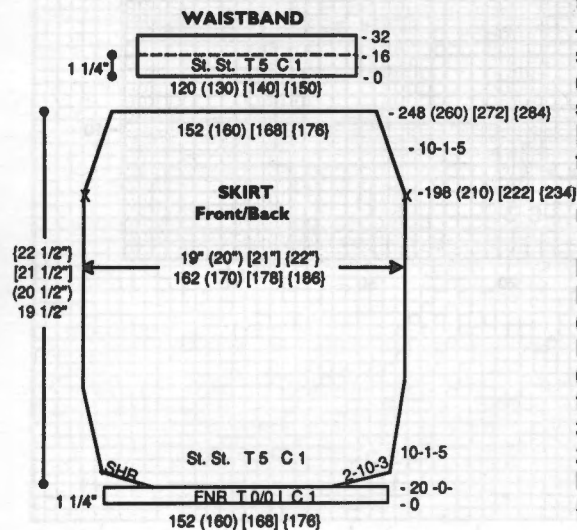

SHR shaping on each side EOR 10 Sts. 3x. Incr. on each side every 10 Rs. 1 St. 5x. At R 198 (210) [222] [234] begin shaping. On each side decr. every 10 Rs. 1 St. 5x. At R 248 (260) [272] [284] remove sts. on WY.

WAISTBAND: Make 2.

Bring 120 (130) [140] [150] ndls. to WP. With purl side facing, rehang upper edge of skirt front/back on these ndls. decr. evenly across. RC 0. T 5. St. St. C 1. Knit to R 32. Pick up sts. from first row to form doubled band and BO.

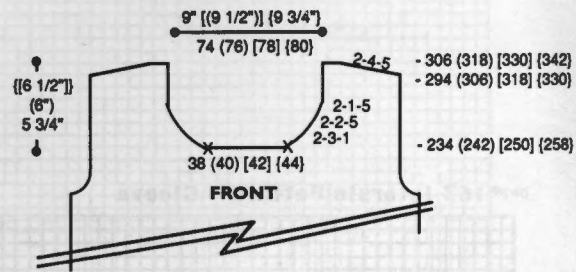

Reset RC to R 234 (242) [250] [258]. BO center sts. and complete left side from * reversing shapings.

SLEEVE:

With WY CO 72 (80) [88] [96] sts. After several rows, end with 1 row Ravel Cord to the right. RC 0. T 5. C 1. Knit in St. St. while incr. on each side every 7 Rs. 1 St. 25x. At R 180 (184) [188] [192] shape sleeve cap. On each side BO 5 sts. then BO EOR 4 Sts. 1x, 3 Sts. 1x, 2 Sts. 1x and 1 St. 5x, every 4 Rs. 1 St. 6x, EOR 1 St. 23 (26) [29] [32] x and EOR 2 Sts. 4x. At R 276 (286) [296] [306] BO remaining sts.

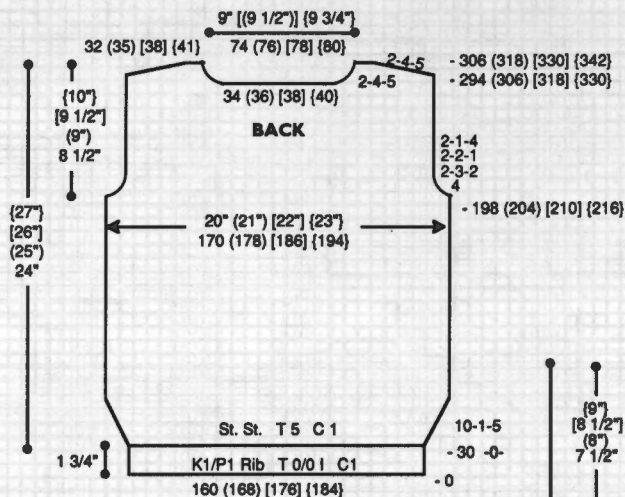

BACK:

With C 1 CO 160 (168) [176] [184] sts. for K1/P1 Rib. After selvedge RC 0. T 0/0 I. Knit to R 30. Transfer RB sts. to MB. RC 0. T 5. Knit in St. St. while incr. on each side every 10 Rs. 1 St. 5x. At R 198 (204) [210] [216] shape armhole. On each side BO 4 Sts., then decr. EOR 3 Sts. 2x, 2 Sts. 1x and 1 St. 4x. At R 294 (306) [318] [330] shape neckline. Place center 34 (36) [38] [40] in HP and all sts. to the left. *On neckline edge decr. EOR 4 Sts. 5x. AT THE SAME TIME SHR shoulder EOR 4 Sts. 5x. At R 306 (318) [330] [342] remove shoulder sts. on WY. Reset RC to R 294 (306) [318] [330] and complete left side from *, reversing shapings. Remove shoulder and neckline sts. on separate WY.

FRONT:

Knit front same as back to R 234 (242) [250] [258]. Shape neckline. Mark with YM and place center 38 (40) [42] [44] sts. in HP and all sts. to the left. *On neckline edge decr. EOR 3 Sts. 1x, 2 Sts. 5x and 1 St. 5x. At R 294 (306) [318] [330] SHR shoulder EOR 4 Sts. 5x. At R 306 (318) [330] [342] remove shoulder sts. on WY.

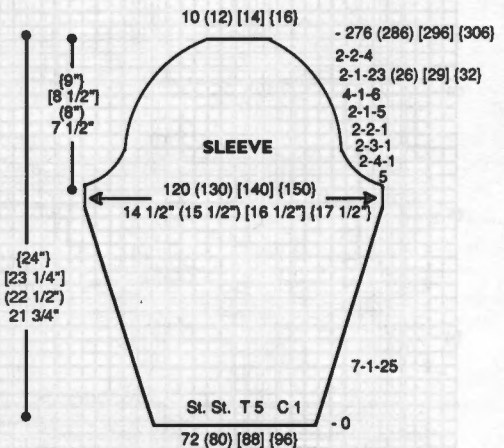

CUFF (Not to Scale)

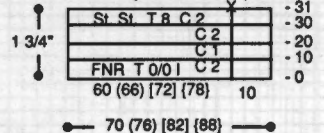

SLEEVE CUFF:

With C 2 CO 70 (76) [82] [88] sts. for FNR. After selvedge, T 0/0 I. RC 0. Knit to R 10. Change to C 1 and knit to R 20. Change to C 2 and knit to R 30. Transfer RB sts. to MB. Knit 1 row at T 8. Place a YM for overlap following chart. Remove sts. on WY.

NECKBAND: Make in 3 Sections.

Back: With C 2 CO 62 (64) [66] [68] sts. for FNR. After selvedge, T 0/0 I.

BACK NECKBAND (Not to Scale-Make 1)

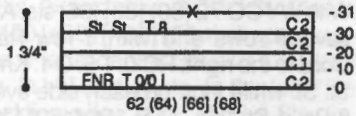

FRONT NECKBAND (Make 2)

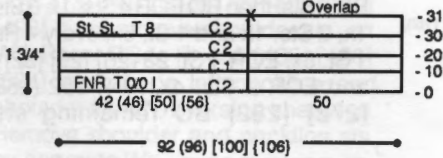

RC 0. Knit to R 10. Change to C 1 and knit to R 20. Change to C 2 and knit to

FINISHING NECKBAND

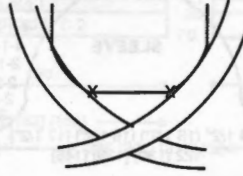

R 30. Transfer RB sts. to MB. Knit 1 row at T 8. Remove sts. on WY.
Front: Make 2. With C 2 CO 92 (96) [100] [106] sts. for FNR. After sel-

vedge, T 0/0 I. RC 0. Knit to R 10. Change to C 1 and knit to R 20. Change to C 2 and knit to R 30. Transfer RB sts. to MB. Knit 1 row at T 8. BO 50 overlap sts. and remove remaining sts. on WY.

FINISHING:

Close shoulder seams. Starting at right side attach neckband to neckline to the YM. Slip stitch right side overlap in place (see drawing) then bring left side overlap on top and stitch in place. Attach cuffs to sleeves with crochet hook starting at center and working around. Attach sleeves. Close all remaining seams.



SHORT ROW INTARSIA SHEATH DRESS

YARN: Venetia
SIZES: 6/8 (10/12) [14] [16]
AMOUNT:
C 1: Black - 1 cone (approx. 1-1/2 lb. all sizes)
C 2: Goldenrod - 2 oz.
C 3: Purple - 2 oz.
C 4: Cranberry - 2 oz.
C 5: Emerald - 2 oz.
KIT PRICE: \$60.00
TENSION:
St. St.: T 5
Bands: T 4.2
GAUGE:
St. St.: 8.3 Sts., 12.5 Rs. = 1"

Make on any Standard Machine.

FRONT:
With WY CO 152 (160) [168] [176] sts. After several rows, end with 1 row Ravel Cord to the right. RC 0. T 5. C 1. St. St. Knit shaping lower edge by SHR shaping on each side EOR 10 Sts. 3x. Incr. on each side every 10 Rs. 1 St. 5x. At R 78 (84) [92] [96] start SHR. On left side bring 2 (5) [8]

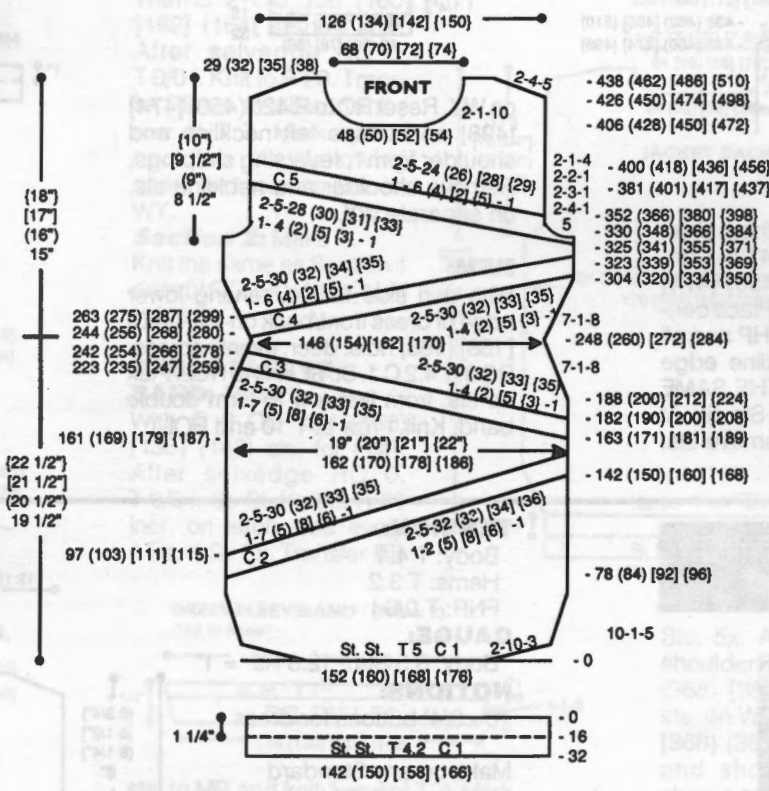

[6] ndls. to HP 1x, then bring 5 ndls. to HPEOR 32(33)[34][36] x. Change to C 2. Reset RC to R 78 (84) [92] [96]. On left side push to WP 2 (5) [8] [6] ndls. 1x. Knit 2 Rs. and push to WP 5 ndls. EOR 32(33)[34][36] x. AT THE SAME TIME at R 97 (103) [111] [115] on left side bring 7 (5) [8] [6] ndls. to HP 1x, then 5 ndls. EOR 30 (32) [33] [35] x. Change to C 1. Reset RC to R 97 (103) [111] [115]. On left side push to WP 7 (5) [8] [6] ndls. 1x, then 5 ndls. EOR 30 (32) [33] [35] x. At R 161 (169) [179] [187] knit 2 Rs. then on right side bring 7 (5) [8] [6] ndls. to HP 1x, then 5 ndls. EOR 30 (32) [33] [35] x. Change to C 3. Reset RC to R 163 (171) [181] [189]. On right side push to WP 7 (5) [8] [6] ndls. 1x, then 5 ndls. EOR 30 (32) [33] [35] x. AT THE SAME TIME after R 182 (190)

[200] [208], on right side bring 4 (2) [5] [3] ndls. to HP 1x, then 5 ndls. EOR 30(32)[33][35] x. Change to C 1. Reset RC to R 182 (190) [200] [208]. On right side push to WP 4 (2) [5] [3] ndls. 1x, then 5 ndls. EOR 30 (32) [33] [35] x. AT THE SAME TIME at R 188 (200) [212] [224] decr. on each side every 7 Rs. 1 St. 8x. After R 242 (254) [266] [278] knit 2 Rs. On left side bring 4 (2) [5] [3] ndls. to HP 1x, then 5 ndls. EOR 30 (32) [33] [35] x. AT THE SAME TIME at R 248 (260) [272] [284] incr. on right side every 7 Rs. 1 St. 8x. Change to C 4. Reset RC to R 244 (256) [268] [280]. On left side push to WP 4 (2) [5] [3] ndls. 1x, then 5 ndls. EOR 30 (32) [33] [35] x. AT THE SAME TIME at R 248 (260) [272] [284] incr. on left side every 7 Rs. 1 St. 8x. AT THE SAME TIME at R 263 (275) [287] [299], on left side bring 6 (4) [2] [5] ndls. to HP 1x, then 5 ndls. EOR 30 (32) [34] [35] x. Change to C 1. Reset RC to R 263 (275) [287] [299]. On left side push to WP 6 (4) [2] [5] ndls. 1x, then 5 ndls. EOR 30 (32) [34] [35] x. After R 323 (339) [353] [369] knit 2 Rs. On right side bring 4 (2) [5] [3] ndls. to HP 1x, then 5 ndls. EOR 28 (30) [31] [33] x. At R 330 (348) [366] [384] on left side make armhole. BO 5 Sts. then BO EOR 4 Sts. 1x, 3 Sts. 1x, 2 Sts. 1x and 1 St. 4x. Change to C 5. Reset RC to R 325 (341) [355] [371]. On right side push to WP 4 (2) [5] [3] ndls. 1x, then 5 ndls. EOR 28 (30) [31] [33] x. AT THE SAME TIME at R 330 (348) [366] [384] on right side make armhole same as left side. After R 352 (366) [380] [398] on right side bring 6 (4)

[2] [5] ndls. to HP 1x, then 5 ndls. EOR 24 (26) [28] [29] x. Change to C 1. Reset RC to R 352 (366) [380] [398]. On right side push to WP 6 (4) [2] [5] ndls. 1x, then 5 ndls. EOR 24 (26) [28] [29] x. At R 406 (428) [450] [472] shape neckline. Place center 48 (50) [52] [54] sts. in HP and all sts. to the left. *On neckline edge decr. EOR 1 St. 10x. At R 426 (450) [474] [498] SHR shoulder EOR 4 Sts. 5x. At R 438 (462) [486] [510] remove sts. on WY. Reset RC to R 406 (428) [450] [472] and shape left neckline and shoulder from *, reversing shapings. Remove shoulder and neckline sts. on separate WY.

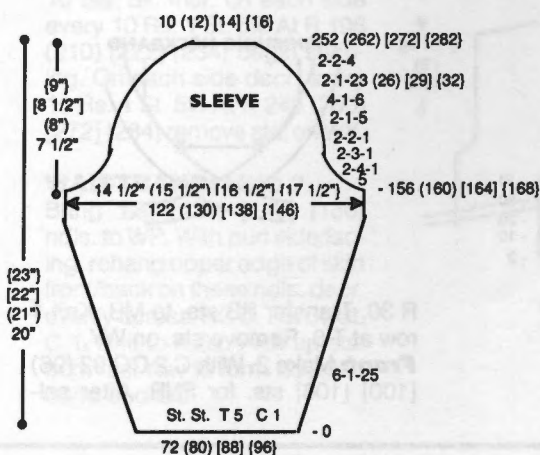

SLEEVE:

With WY CO 72 (80) [88] [96] sts. After several rows end with 1 row Ravel Cord to the right. RC 0. T 5. C 1. Knit in St. St. while incr. on each side every 6 Rs. 1 St. 25x. At R 156 (160) [164] [168] shape sleeve cap. On each side BO 5 Sts. then BO EOR 4 Sts. 1x, 3 Sts. 1x, 2 Sts. 1x and 1 St. 5x, every 4 Rs. 1 St. 6x, EOR 1 St. 23 (26) [29] [32] x and EOR 2 Sts. 4x. At R 252 (262) [272] [282] BO remaining sts.

SLEEVE BAND:

With purl side facing rehang lower edge of sleeve on 62 (70) [78] [86] ndls. decr. evenly across. RC 0. T 4.2. C 1. St. St. Knit to R 32. Pick up sts. from first row to form double band. Knit 1 row at T 10 and BOLT.

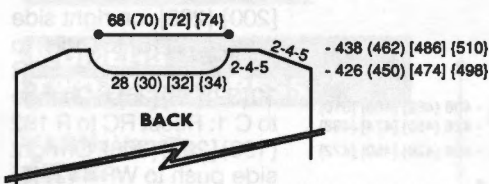

BACK:

Knit back same as front without short rows to R 406 (428) [450] [472]. Continue in St. St. to R 426 (450) [474] [498] and shape neckline. Place center 28 (30) [32] [34] sts. in HP and all sts. to the left. *On neckline edge decr. EOR 4 Sts. 5x. AT THE SAME TIME SHR shoulder EOR 4 Sts. 5x. At R 438 (462) [486] [510] remove sts.

on WY. Reset RC to R 426 (450) [474] [498] and shape left neckline and shoulder from *, reversing shapings. Remove shoulder and neckline sts. on separate WY.

HEM:

With purl side facing, rehang lower edge of dress front/back on 142 (150) [158] [166] ndls. decr. evenly across. RC 0. T 4.2 C 1. St. St. Knit to R 32. Pick up sts. from first row to form double band. Knit 1 row at T 10 and BOLT.

NECKBAND

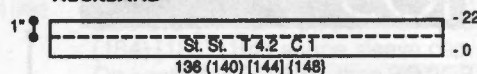

NECKBAND:

With WY CO 136 (140) [144] [148] sts. After several rows end with 1 row Ravel Cord to the right. RC 0. T 4.2. C 1. St. St. Knit to R 22. Pick up sts. from first row to form double band. Knit 1 row at T 7 and remove sts. on WY.

FINISHING:

Close shoulder seams and attach neckband. Attach sleeves. Close all remaining seams.

166



DRESS and JACKET ENSEMBLE

YARN: Venetia

SIZES:

6/8 (10/12) [14] [16]

AMOUNT:

C 1: White - 2 cones all sizes (cones average 1-1/2 lb. each)

C 2: Cranberry - 8 oz. all sizes

KIT PRICE: \$105.00

TENSION:

Body: T 4.1

Hems: T 3.2

FNR: T 0/0 I

GAUGE:

Body: 8.5 Sts., 12.5 Rs. = 1"

NOTIONS:

8 - 3/4" buttons for dress

Make on any Standard Machine with Ribber.

DRESS BACK:

With WY CO 158 (166) [174] [182] sts. After several rows end with 1 row Ravel Cord to the right. RC 0. T 3.2. C 2. St. St. Knit to R 40. Pick up sts. from first row to form hem. RC 0. T 4.1. C 1. Knit 1 row to the left then shape lower edge by SHR EOR 10 Sts. 3x. Shape skirt by incr. on each side every 10 Rs. 1 St. 5x. At R 188 (200) [212] [224] decr. on each side every 6 Rs. 1 St. 10x. At R 248 (260) [272] [284] incr. on each side every 10 Rs. 1 St. 10x. At R 360 (374) [388] [402] shape armhole. On each side BO 5 sts.,

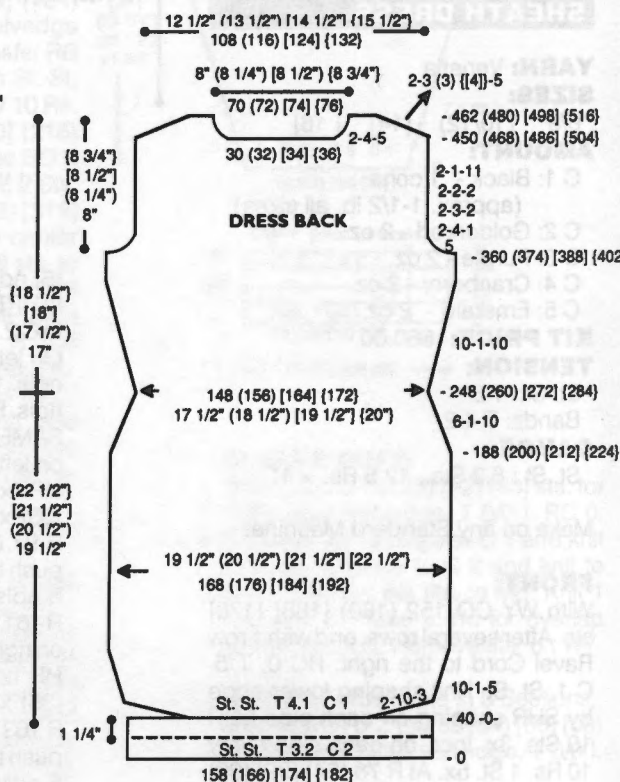

then BO EOR 4 Sts. 1x, 3 Sts. 2x, 2 Sts. 2x and decr. EOR 1 St. 11x. At R 450 (468) [486] [504] shape neckline. Place center 30 (32) [34] [36] sts. in HP and all sts. to the left. *On neckline edge decr. EOR 4 Sts. 5x. AT THE SAME TIME SHR shoulder EOR 3 (3) [(4)] sts. 5x. At R 462 (480) [498] [516] remove shoulder sts. on WY. Reset RC to R 450 (468) [486] [504] and shape left neckline and shoulder from *, reversing shapings. Remove shoulder and neckline sts. on separate WY.

DRESS FRONT:

Make 1, Reverse 1. With WY CO 72 (76) [80] [84] sts. After several rows end with 1 row Ravel Cord to the right. RC 0. T 3.2. C 2. St. St. Knit to R 40. Pick up sts. from first row to form hem. RC 0. T 4.1. C 1. Knit 1 row to the left then shape lower edge by SHR at the right EOR 10 Sts. 3x. Shape skirt by incr. on right side every 10 Rs. 1 St. 5x. At R 172 (184)

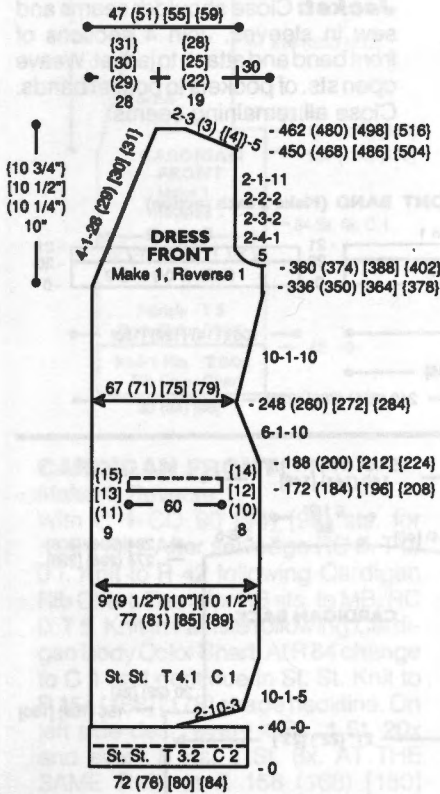

[196] [208] bring 60 ndls. in the center (see chart) to HP. Knit 1 row by hand with C2 to mark for pocket band placement. At R 188 (200) [212] [224] decr. on right side every 6 Rs. 1 St. 10x. At R 248 (260) [272] [284] incr. on right side every 10 Rs. 1 St. 10x. At R 336 (350) [364] [378] shape neckline. On left side decr. every 4 Rs. 1 St. 28 (29) [30] [31] x. AT THE SAME TIME at R 360 (374) [388] [402] shape armhole. On right side BO 5 sts., then

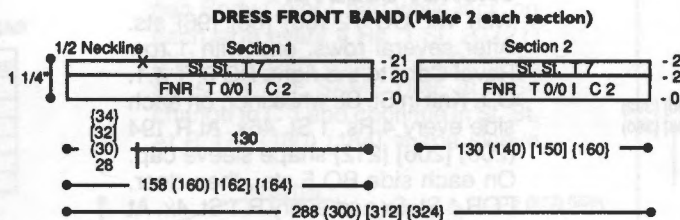

BO EOR 4 Sts. 1x, 3 Sts. 2x, 2 Sts. 2x and decr. EOR 1 St. 11x. At R 450 (468) [486] [504] SHR shoulder EOR 3 (3) [(4)] sts. 5x. At R 462 (480) [498] [516] remove shoulder sts. on WY.

DRESS FRONT BAND:

Make in 2 sections. **Section 1:** Make 2. With C 2 CO 158 (160) [162] [164] sts. for FNR. After selvedge RC 0. T 0/0 I. Knit to R 20. Transfer RB sts. to MB and knit 1 row at T 7. Mark half of neckline sts. following chart and remove sts. on WY.

Section 2: Make 2. Knit the same as Section 1 except CO 130 (140) [150] [160] sts.

DRESS SLEEVE BAND:

Make 2. With C 2 CO 124 (130) [136] [142] sts. for FNR. After selvedge RC 0. T 0/0 I. St. St. Knit to R 20 incr. on each side every 4 Rs. 1 St. 5x. Transfer RB

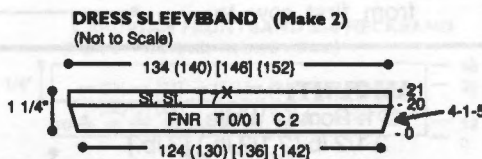

sts. to MB and knit 1 row at T 7. Mark center with YM and remove sts. on WY.

POCKET BAND: Make 2 for Dress and 2 for Jacket.

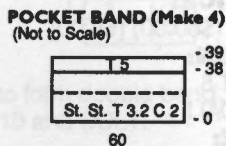

With WY CO 60 sts. After several rows end with 1 row Ravel Cord to the right. RC 0. T 3.2. C 2. St. St. Knit to R 38. Pick up sts. from first row to form double band. Knit 1 row at T 5 and remove on WY.

JACKET BACK:

With WY CO 170 (178) [186] [194] sts. After several rows end with 1 row Ravel Cord to the right. RC 0. T 3.2. C 2. St. St. Knit to R 40. Pick up sts. from first row to form hem. RC 0. T 4.1. C 1. Shape jacket by incr. on each side every 10 Rs. 1 St. 3x. At R 142 (148) [154] [160] place a YM on each side for aid in seaming. At R 224 (232) [240] [248] shape armhole. On each side BO 5 sts. then decr. EOR 1 St. 5x. At R 344 (356) [368] [380] shape neckline. Place center 24 (26) [28] [30] sts. in HP and all sts. to the left. *On neckline edge decr. EOR 4

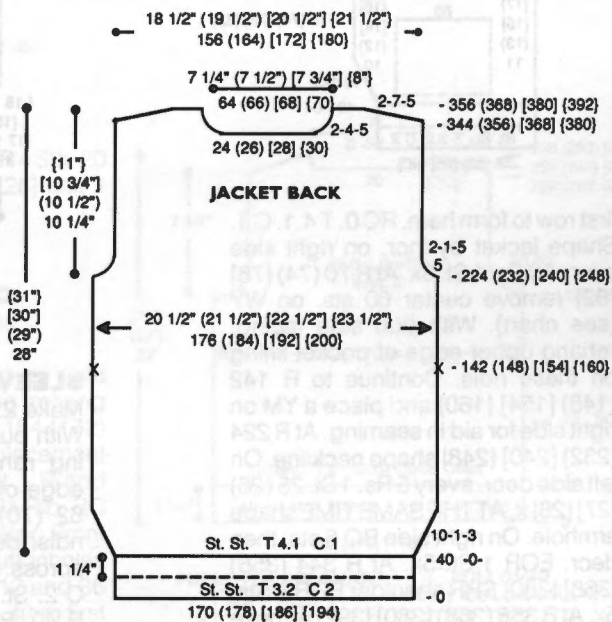

Sts. 5x. AT THE SAME TIME SHR shoulder EOR 7 Sts. 5x. At R 356 (368) [380] [392] remove shoulder sts. on WY. Reset RC to R 344 (356) [368] [380] and shape left neckline and shoulder from *, reversing shapings. Remove shoulder and neckline sts. on separate WY.

POCKET LINING

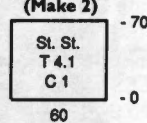

JACKET POCKET LINING:

With C 1 'e' wrap CO 60 sts. RC 0. T 4.1. St. St. Knit to R 70 and remove sts. on WY.

JACKET FRONT:

Make 1, Reverse 1. With WY CO 78 (82) [86] [90] sts. After several rows end with 1 row Ravel Cord to the right. RC 0. T 3.2. C 2. St. St. Knit to R 40. Pick up sts. from

167



THREE-PIECE ENSEMBLE

YARN: Roma and Primo

SIZES:

6/8 (10/12) [14]

JACKET SLEEVE:

With WY CO 72 (80) [88] [96] sts. After several rows, end with 1 row Ravel Cord to the right. RC 0. T 4.1. C 1. Knit in St. St. while incr. on each side every 4 Rs. 1 St. 46x. At R 194 (200) [206] [212] shape sleeve cap. On each side BO 5 sts., then decr. EOR 1 St. 5x and every R 1 St. 4x. At R 210 (216) [222] [228] mark center with YM and remove sts. on WY.

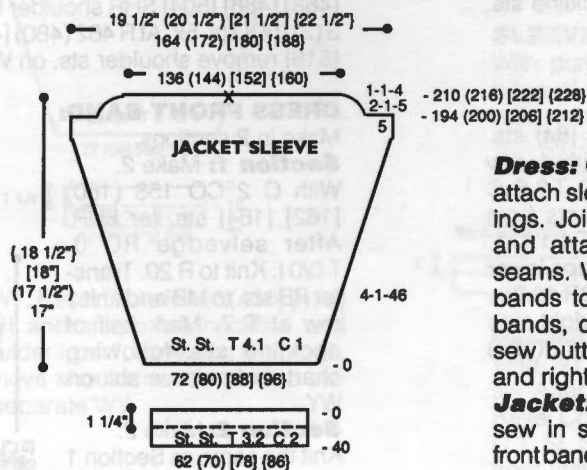

SLEEVE CUFF:

Make 2. With purl side facing rehang lower edge of sleeve on 62 (70) [78] [86] ndls. decr. evenly across. RC 0. T 3.2. C 2. St. St. Knit to R 40. Pick up sts. from first row to

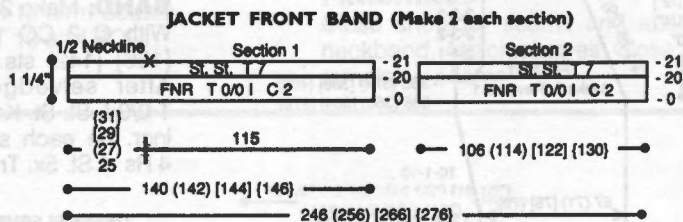

form double band. Knit 1 row at T 10 and BOLT.

JACKET FRONT BAND:

Make in 2 sections.

Section 1: Make 2.

With C 2 CO 140 (142) [144] [146] sts. for FNR. After selvedge RC 0. T 0/0 I. Knit to R 20. Transfer RB sts. to MB and knit 1 row at T 7. Mark half of neckline sts. following chart and remove sts. on WY.

Section 2: Make 2.

Knit the same as section 1 except CO 106 (114) [122] [130] sts.

FINISHING:

Dress: Close shoulder seams and attach sleeve bands to sleeve openings. Join 4 sections of front band and attach to dress. Close side seams. Weave open sts. of pocket bands to dress. Attach front dress bands, overlapping "plackets" and sew buttons in place attaching left and right panels of dress.

Jacket: Close shoulder seams and sew in sleeves. Join 4 sections of front band and attach to jacket. Weave open sts. of pockets to pocket bands. Close all remaining seams.

first row to form hem. RC 0. T 4.1. C 1. Shape jacket by incr. on right side every 10 Rs. 1 St. 3x. At R 70 (74) [78] [82] remove center 60 sts. on WY (see chart). With purl side facing, rehang upper edge of pocket lining on these ndls. Continue to R 142 (148) [154] [160] and place a YM on right side for aid in seaming. At R 224 (232) [240] [248] shape neckline. On left side decr. every 5 Rs. 1 St. 25 (26) [27] [28] x. AT THE SAME TIME shape armhole. On right side BO 5 sts. then decr. EOR 1 St. 5x. At R 344 (356) [368] [380] SHR shoulder EOR 7 Sts. 5x. At R 356 (368) [380] [392] remove shoulder sts. on WY.

AMOUNT:

- C 1: Roma - White
- 2 1/2 lb (2 1/2 lb.) [3 lb.]
- C 2: Primo - Grass Green
- 2 oz. all sizes
- C 3: Primo - Inca
- 2 oz. all sizes
- C 4: Primo - Jungle
- 2 oz. all sizes
- C 5: Primo - Burgundy
- 2 oz. all sizes

KIT PRICE:

\$60.00 (\$60.00) [68.00]

TENSION:

Body: T 5
Rib: T 0/0 I

GAUGE:

Body: 8.5 Sts., 11.62 Rs. = 1"

NOTIONS:

5 - 1" buttons for jacket and elastic for skirt waistband.

Make on Standard 24-Stitch Punch Card or Standard Electronic Machine with Ribber and Ribber Color Changer.

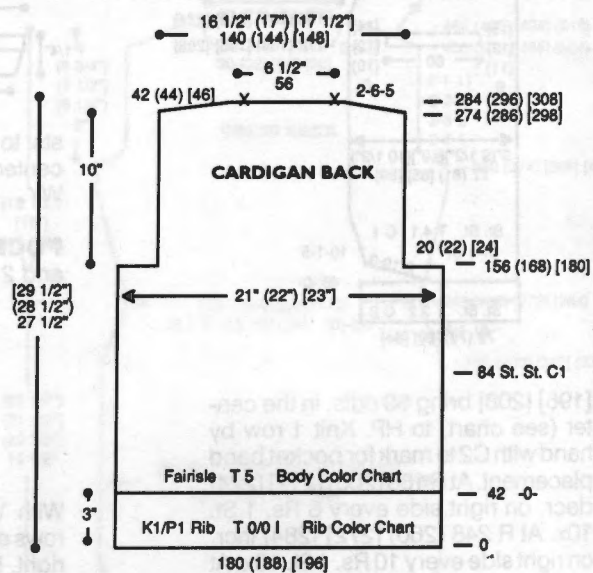

CARDIGAN BACK:

With C 1 CO 180 (188) [196] sts. for K1/P1 Rib. After selvedge RC 0. T 0/0 I. Knit to R 42 following Cardi-

CARDIGAN RIB COLOR CHART

CARDIGAN BODY COLOR CHART

# Rs	Color
2	C5
4	C1
2	C4
4	C1
2	C3
4	C1
2	C2
4	C1

#Rs	Main	Contrast
20	▲	C5
10		C4
20		C2
10		C3
20		C5
4	C1	—

Repeat ↑

gan Rib Chart. Transfer RB sts. to MB. RC 0. T 5. Knit in Fairisle following Cardigan Body Color Chart. At R 84 change to C 1 and continue in St. St. Knit to R 156 (168) [180] and shape armhole. On each side BO 20 (22) [24] sts. At R 274 (286) [298] SHR shoulders EOR 6 Sts. 5x. At R 284 (296) [308] mark center 56 sts. for neckline and center and remove sts. on WY.

side. Knit in Fairisle following Cardigan Body Color Chart while incr. on each side every 4 Rs. 1 St. 20 (21) [22]x and every 3 Rs. 1 St. 22x for all sizes. AT THE SAME TIME at R 84 change to C 1 and continue in St. St. At R 176 (180) [184] shape sleeve

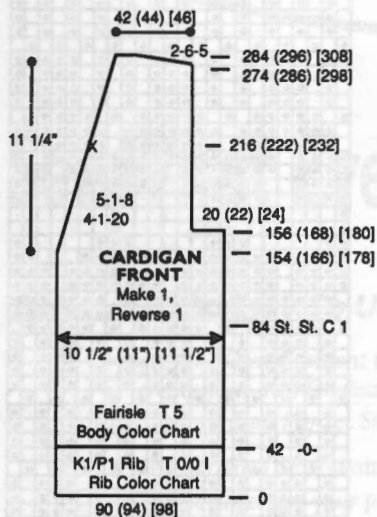
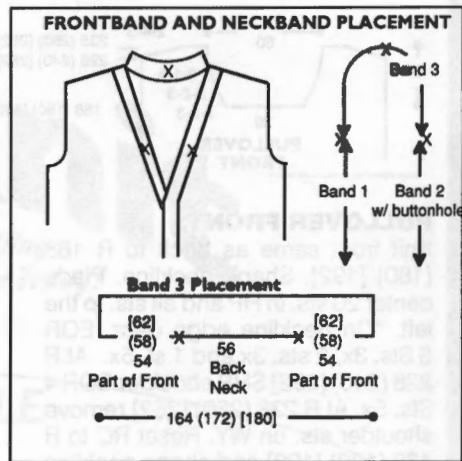
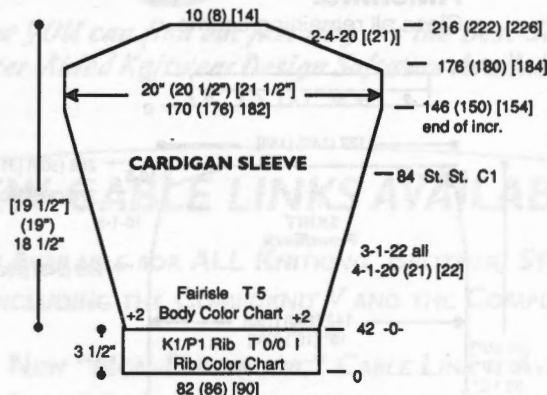

cap. On each side SHR EOR 4 Sts. 20 [(21)] x. At R 216 (222) [226] knit 1 row at T 10 and BOLT.

CARDIGAN FRONT BAND and NECKBAND:

Make 3 - 1 with buttonholes, 2 without. Join shoulder seams. Start on right side. With purl side facing rehang from lower edge to YM on 164 (172) [180] ndls. (See Chart for placement of the three sections.) Knit 1 R and transfer EOS to RB for K1/P1 Rib. RC 0. T 0/0 I. Knit to R 48 following Front Band Color Chart making buttonholes over 4 sts. with WY at Rs. 12 and 36 following chart. Pick up sts. from first

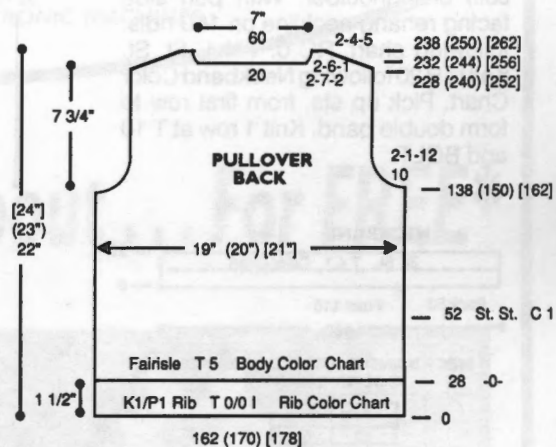

CARDIGAN FRONT:

Make 1, Reverse 1. With C 1 CO 90 (94) [98] sts. for K1/P1 Rib. After selvedge RC 0. T 0/0 I. Knit to R 42 following Cardigan Rib Chart. Transfer RB sts. to MB. RC 0. T 5. Knit in Fairisle following Cardigan Body Color Chart. At R 84 change to C 1 and continue in St. St. Knit to R 154 (166) [178] shape neckline. On left side decr. every 4 Rs. 1 St. 20x and every 5 Rs. 1 St. 8x. AT THE SAME TIME at R 156 (168) [180] shape armhole. On right side BO 20 (22) [24] sts. At R 216 (222) [232] place YM on neckline edge to aid in placing front band. At R 274 (286) [298] SHR shoulder EOR 6 Sts. 5x. At R 284 (296) [308] remove shoulder sts. on WY.

CARDIGAN SLEEVE:

With C 1 CO 82 (86) [90] sts. for K1/P1 Rib. After selvedge RC 0. T 0/0 I. Knit to R 42 following Cardigan Rib Chart. Transfer RB sts. to MB. RC 0. T 5. Incr. 2 sts. on each

CARDIGAN FRONTBAND and NECKBAND

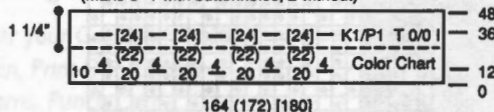

FRONTBAND COLOR CHART

# Rs	Color
remain-	C1
ing Rs	C1
2	C2
4	C1
2	C3
4	C1
2	C4
4	C1
2	C5
4	C1

row to form double band. Knit 1 row at T 10 and BOLT.

PULLOVER BACK:

With C 1 CO 162 (170) [178] sts. for K1/P1 Rib. After selvedge RC 0. T 0/0 I. Knit to R 28 following Pullover Rib Chart. Transfer RB sts. to MB. RC 0. T 5. Knit in Fairisle following Pullover Body Color Chart. At R 52

PULLOVER RIB CHART

#Rs	Color
4	C1
2	C5
4	C1
2	C4
4	C1
2	C3
4	C1
2	C2
4	C1

PULLOVER BODY COLOR CHART

#Rs	Main	Contrast
20	▲	C5
10		C4
20		C2
2	C1	—

change to C 1 and continue in St. St. At R 138 (150) [162] shape armhole. On each side BO 10 sts. then decr. EOR 1 St. 12x. At R 228 (240) [252] SHR shoulders EOR 4 Sts. 5x. AT THE SAME TIME at R 232 (244) [256] shape neckline. Place center 20 sts. in HP and all sts. to the left. *On neckline edge BO EOR 7 Sts. 2x and 6 Sts. 1x while continuing SHR shoulder shaping. At R 238 (250) [262] remove shoulder sts. on WY. Reset RC to R 232 (244) [256] shape left neckline and continue SHR shoulder shaping from *, reversing shapings.

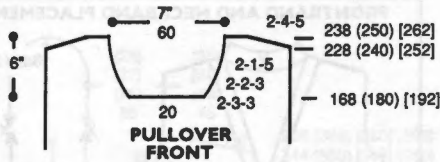

PULLOVER FRONT:

Knit front same as back to R 168 (180) [192]. Shape neckline. Place center 20 sts. in HP and all sts. to the left. *On neckline edge decr. EOR 3 Sts. 3x, 2 sts. 3x and 1 st. 5x. At R 228 (240) [252] SHR shoulder EOR 4 Sts. 5x. At R 238 (250) [262] remove shoulder sts. on WY. Reset RC to R 168 (180) [192] and shape neckline and shoulder from *, reversing shapings.

PULLOVER NECKBAND:

Join one shoulder. With purl side facing rehang neckline on 160 ndls. following chart. RC 0. T 4.1. St. St. Knit to R 20 following Neckband Color Chart. Pick up sts. from first row to form double band. Knit 1 row at T 10 and BOLT.

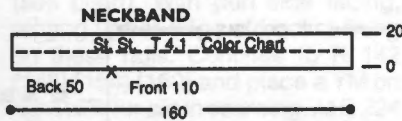

NECKBAND & ARMHOLE BAND COLOR CHART

# Rs	Color
10	C1
2	C5
2	C4
2	C3
2	C2
2	C1

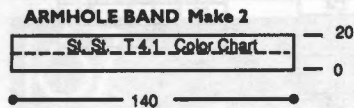

ARMHOLE BAND: Make 2.

Join remaining shoulder. With purl side facing rehang armhole on 140 ndls. RC 0. T 4.1. St. St. Knit to R 20 following Armhole Band Color Chart. Pick up sts. from first row to form double band. Knit 1 row at T 10 and BOLT.

SKIRT FRONT/BACK:

With C 1 CO 132 (140) [148] sts. for circular knitting. After selvedge, T 0/0 I. Knit 13 Rs. and arrange ndls. for FNR. RC 0. T 3.1/3 I. Knit in stripe pattern following chart while incr. on each side every 20 Rs. 1 St. 5x. At R 150 place a YM on each side for aid in seaming. At R 228 (240) [252] place a YM on each side and start shaping. On each side decr. every 10 Rs. 1 St. 5x. At R 278 (290) [302] SHR on each side EOR 10 Sts. 5x. At

R 288 (300) [312] transfer RB sts. to MB and decr. 2 sts. on each side. RC 0. T 4.1. C 1. St. St. Knit to R 34. Pick up sts. from first row to form double band. Knit 1 row at T 10 and BOLT.

FINISHING:

Close all remaining seams.

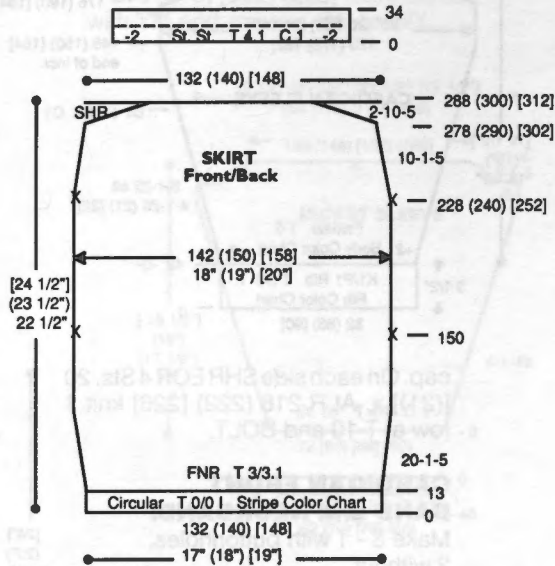

SKIRT STRIPE COLOR CHART

# Rs	Color
to end	C1
2	C5
2	C1
2	C4
2	C1
2	C3
2	C1
2	C2
13	C1

#167 Fairisle - Pullover
24 Sts. x 50 Rows

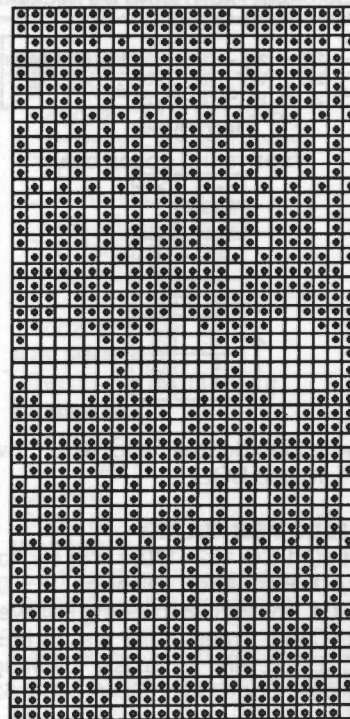

KK Mag Disk: Track 1; Pattern 902

#167 Fairisle - Cardigan
24 Sts. x 80 Rows

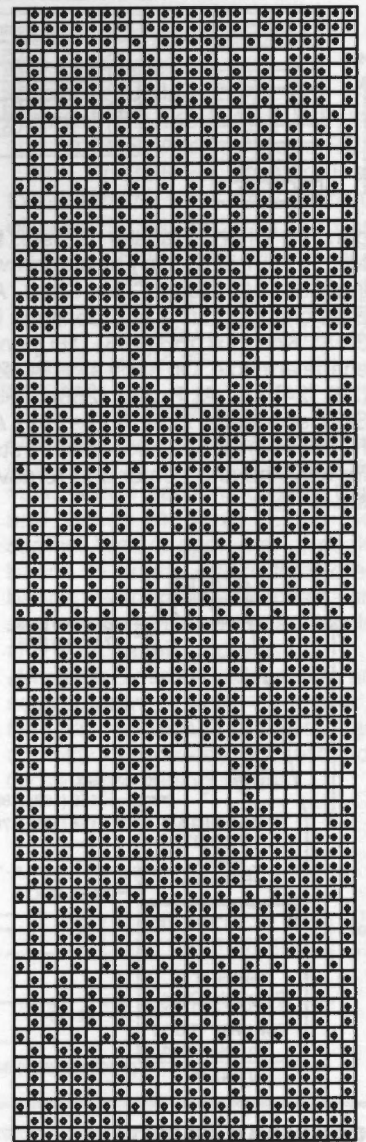

KK Mag Disk: Track 1; Pattern 901

The following Color Chart was omitted from Knitting Magazine: Volume 26 — Issue 4

Body Color Chart
Pattern 150 - Page 29

# Rows	MC	CC	Repeat ↑
4	1	6	
10	1	5	
4	1	2	
10	1	4	
10	1	3	
4	1	2	

DesignaKnit

Now YOU can find out just why it's the Best-Selling
Computer-Aided Knitwear Design Software Available Today!

NEW CABLE LINKS AVAILABLE

DIRECT CABLE LINKS ARE NOW AVAILABLE FOR ALL KNITTING, BROTHER, STUDIO AND SINGER ELECTRONIC MACHINES — INCLUDING THE COMPUKNIT V AND THE COMPUKNIT/BULKY —

PUNCH CARD USERS NOTE: NEW "NON-ELECTRONIC" CABLE LINK IS AVAILABLE FOR "KNIT-FROM-SCREEN" CAPABILITY FOR ALL NON-ELECTRONIC MACHINES.

See What Everybody's Talking About... For FREE*

DESIGNAKNIT is Easy To Use — 1-2-3-4-KNIT!

- 1) Design Your Own Garment from extensive built-in choices, or create your own Original Shapes (Professional version only). Work from Pre-Set Sizes or modify as desired
- 2) Create Your Own Stitch Patterns for any of the most popular stitches. See your patterns in any of a 1000 colors. You can even Import Graphics-Original or Scanned!
- 3) Superimpose your Stitch Patterns over your Garment Shapes to see the finished appearance. Then, Print-Out Knitting Instructions and Charts, Stitch Patterns, Punch Card Templates, Finished products and much more.
- 4) Transfer Your Creations into Your Knitter with Optional Cable Links and experience the ease of "Knitting-From-The-Screen."

What Do You Get With DESIGNAKNIT?

- PC-computer compatibility (with EGA or VGA screen) • 3.5 or 5.25 disk.
- Nationwide support through Knitking's DesignaKnit Technical Assistance Hotline to compliment the built-in Tutorial program and Instruction Manual.

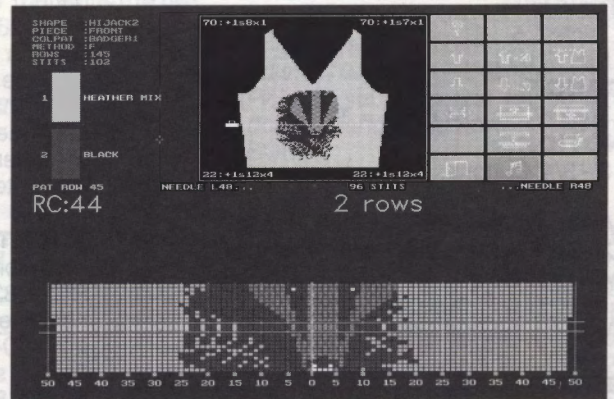

Prices Start
As Low As
\$259.95



* For a Limited Time, you can find out just how EASY and FUN DESIGNAKNIT can be —
CALL TODAY, TOLL-FREE 1-800-962-6446 to request a FREE DESIGNAKNIT Demo Disk!



1128 Crenshaw Boulevard • Los Angeles, CA 90019

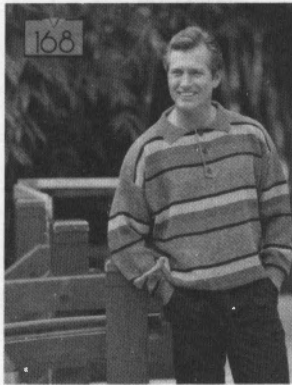

MENS TUCK POLO PULLOVER

YARN: Venetia

SIZES:

Sm. (Med.) [Lge.] [X-Lge.]

AMOUNT:

C 1: Black Tweed - 1 lb.

C 2: Royal - 2 oz.

C 3: Wine - 2 oz.

C 4: Lilac - 2 oz.

C 5: Black - 4 oz.

KIT PRICE: \$50.00

TENSION:

Tuck: T 5

Rib: T 1/1 I

GAUGE:

Tuck: 7 Sts., 21.6 Rs. = 1"

NOTIONS:

3 - 3/4" Buttons.

Make on Standard 24-Stitch Punch Card or Standard Electronic Machine with Ribber.

Worn on the purl side.

BACK:

With C 1 CO 148 (154) [168] [182] sts. for 2x1 Rib as shown on ndl.

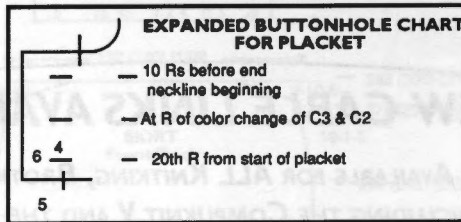
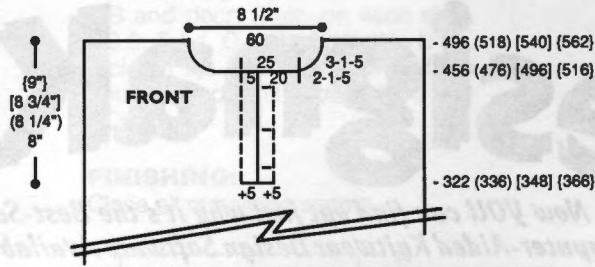
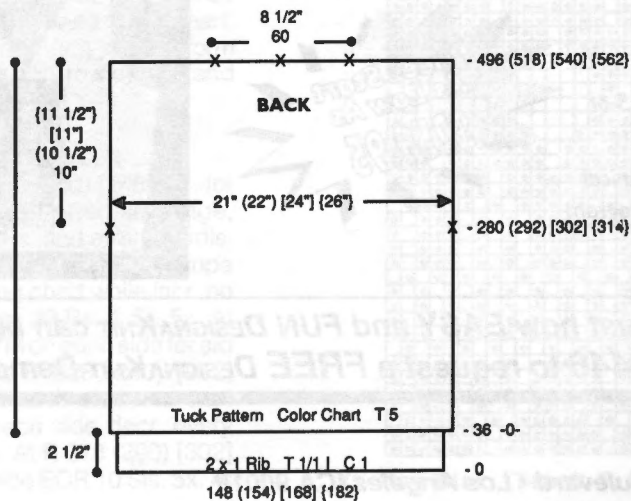

FRONT PLACKET FACINGS

Make 1 with buttonholes, 1 without

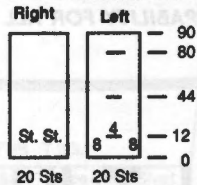

chart. After selvedge RC 0. T 1/1 I. Knit to R 36. Transfer RB sts. to MB decr. evenly across. RC 0. T 5. Knit in tuck pattern following color chart. At R 280 (292) [302] [314] place a YM on each side for armhole. At R 496 (518) [540] [562] mark center 60 sts. for neckline with YM. Remove shoulder and neckline sts. on separate WY.

FRONT:

Knit front same as back to R 322 (336) [348] [366]. Shape neckline. Remove all sts to the left of -0- on WY or Garter Bar. On left side of remaining sts. 'e' CO 5 sts. * Knit to R 456 (476) [496] [516]. On neckline edge BO 25 sts. then decr.

EOR 1 St. 5x and every 3 Rs. 1 St. 5x, making buttonholes in placket as shown on chart. At R 496 (518) [540] [562] remove shoulder sts. on WY. Reset RC to R 322 (336) [348] [366]. Replace sts. removed previously on same ndls. they were removed from. On right side 'e' CO 5 sts. and knit from *, reversing shapings and omitting buttonholes.

FRONT PLACKET FACINGS:

Right Facing: 'e' CO 20 Sts. C1.

RC 0. T 5. St. St. Knit to R 90. BO.

Left Facing: 'e' CO 20 Sts. C1.

RC 0. T 5. Knit in St. St. making

buttonholes over 4 sts. at R 12, 44,

and 80. At R 90 BO.

BODY COLOR CHART

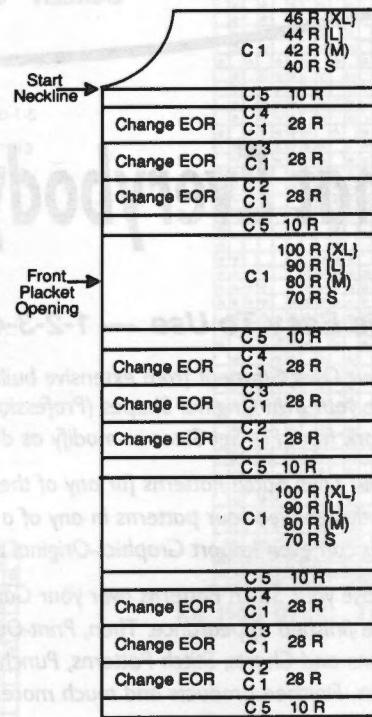

SLEEVE COLOR CHART

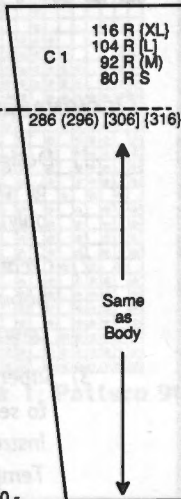

SLEEVE:

With C 1 CO 80 (88) [96] [104] sts. for 2 x 1 Rib as shown on ndl. chart. After selvedge RC 0. T 1/1 I. Knit to R 36 and transfer RB sts. to MB decr. evenly across. RC 0. T 5. Knit in tuck pattern following color chart while incr. on each side every 10 Rs. 1 St. 30x [(every 10 Rs. 1 St. 22x and every 20 Rs. 1 St. 8x)]. At R 366 (388) [410] [432] remove sts. on WY.

COLLAR:

With C 1 CO 160 sts. for 2 x 1 Rib as shown on ndl. chart. After selvedge RC 0. T 1/1 I. Knit to R 50. Transfer RB sts. to MB and remove sts. on WY.

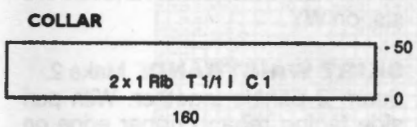
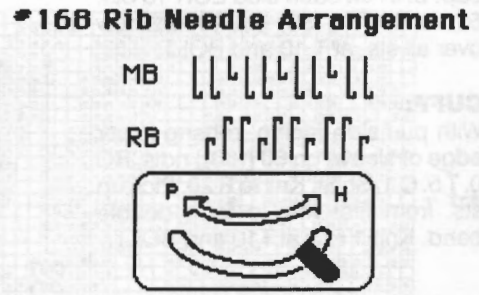
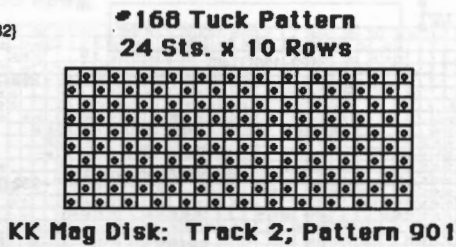
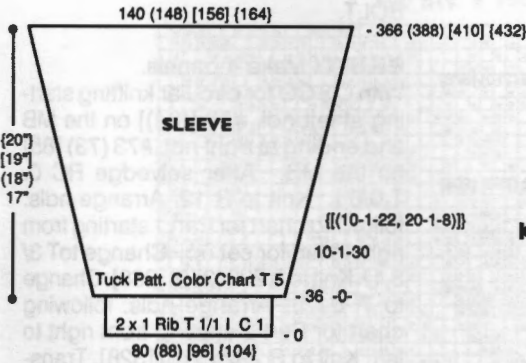

FINISHING:
Close shoulder seams. Attach placket facings to placket by rehangng on machine and binding off, or seam together by hand. Fold placket with slight edging facing front to provide "piping" appearance on placket. **Collar:** Attach collar with crochet hook starting at end of placket (approx. 1-1/2" in). If desired attach

collar by rehangng 1/2 of front/back (knit side facing) starting at end of placket to center back. Hang 1/2 of collar on these needles. BO these stitches. Move over and attach the remaining half. Attach sleeves. Close all remaining seams.

169



TWO-PIECE TEA LENGTH DRESS

Make on Compuknit III, IV or V with Ribber. Pattern for fairisle is #801 in Compuknit V Pattern Book.

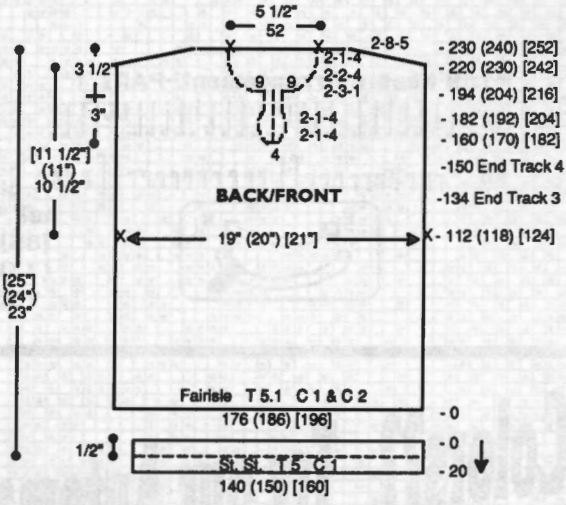

edge then BO EOR 3 Sts. 1x, 2 Sts. 4x and decr. 1 St. 4x. At R 220 (230) [242] SHR shoulder EOR 8 Sts. 5x. At R 230 (240) [252] remove shoulder sts. on WY. Reset RC to R 160 (170) [182]. Reset pattern to correct row and shape left side from *, reversing shapings.

FRONT HEM:
With purl side facing, rehang lower edge of back/front on 140 (150) [160] ndls. RC 0. T 5. C 1. St. St. Knit to R 20. Pick up sts. from first row to form double band. Knit 1 row at T10 and BOLT.

SLEEVE:
With WY CO 86 (90) [94] sts. After several rows end with 1 row Ravel Cord to the left. RC 0. T 5.1. Knit 1 row with C 1 to set pattern. Add C 2 in 'B' Feeder and knit in fairisle while incr. on each side every 3 Rs. 1 St. 20 [(14)] x and every 4 Rs. 1 St. 26 [(32)]

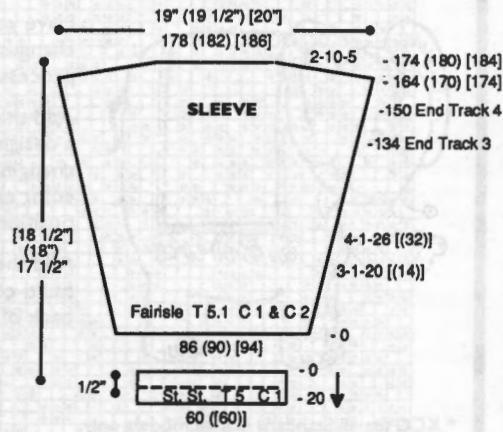

YARN: Venetia and Pearlyte
SIZES:
6/8 (10/12) [14]
AMOUNT:
C 1: Venetia - Black
1 lb. all sizes
C 2: Pearlyte - Charcoal
1 lb. all sizes
C 3: Pearlyte - Black
2 lbs. all sizes
KIT PRICE: \$92.50
TENSION:
Fairisle: T 5.1
Circular Rib: T 0/0 I
Skirt: T 3/3.1

BACK:
With WY CO 176 (186) [196] sts. After several rows end with 1 row Ravel Cord to the left. RC 0. T 5.1. Knit 1 row with C 1 to set pattern. Add C 2 in 'B' Feeder and knit in fairisle. At R 112 (118) [124] place a YM on each side for armhole. At R 220 (230) [242] SHR shoulder EOR 8 Sts. 5x. At R 230 (240) [252] mark center 52 sts. for neckline and remove neckline and shoulder sts. on separate WY.

FRONT:
Knit front same as back to R 160 (170) [182]. Shape neckline. BO center 4 sts. Place all sts. to the left in HP. Note pattern row. *On neckline edge decr. EOR 1 St. 4x. At R 182 (192) [204] incr. EOR 1 St. 4x. At R 194 (204) [216] BO 9 sts. on neckline

GAUGE:
Fairisle: 9.3 Sts., 10.24 Rs. = 1"
Skirt: 9.11 Rs. = 1"
NOTIONS:
1 - 1/2" button for top and elastic for skirt waistband.

x. At R 164 (170) [174] shape sleeve cap. SHR on each side EOR 10 Sts. 5x. At R 174 (180) [184] knit 1 row over all sts. at T 10 and BOLT.

CUFF:

With purl side facing, rehang lower edge of sleeve on 60 [(60)] ndls. RC 0. T 5. C 1. St. St. Knit to R 20. Pick up sts. from first row to form double band. Knit 1 row at T10 and BOLT.

KEY HOLE NECK OPENING HEM:

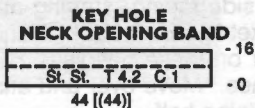

With purl side facing, rehang front split on 44 [(44)] ndls. RC 0. T 4.2. C 1. St. St. Knit to R 16. Pick up sts. from first row to form double hem. Knit 1 row at T10 and BOLT.

NECKBAND:

Close both shoulder seams. With purl side facing, rehang neckline on 118 [(118)] ndls. following chart. RC 0. T 4.2. C 1. St. St. Knit to R 16. Pick up sts. from first row to form

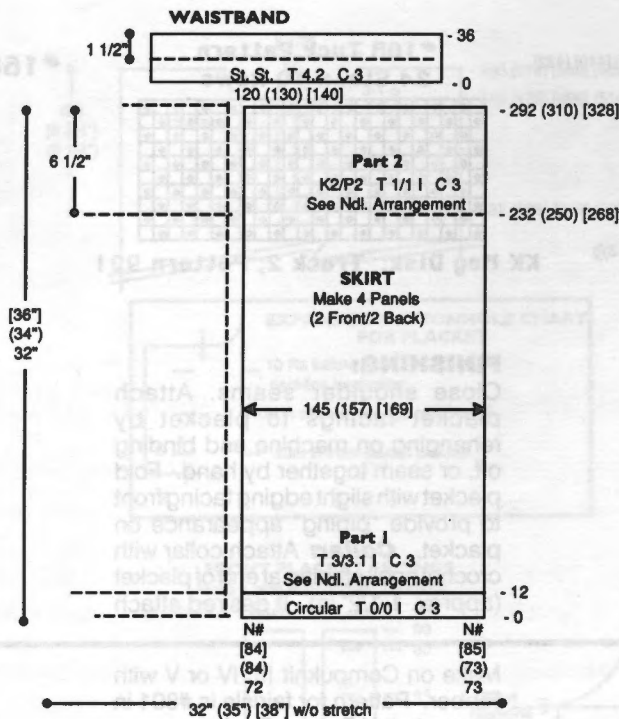
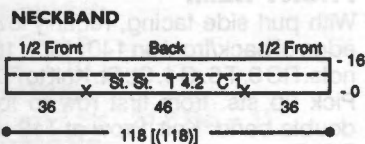

double band. Knit 1 row at T10 and BOLT.

SKIRT: Make 4 panels.

With C 3 CO for circular knitting starting at left ndl. #72 [(84)] on the MB and ending at right ndl. #73 (73) [85] on the MB. After selvage RC 0. T 0/0 I. Knit to R 12. Arrange ndls. following chart for Part 1 starting from right to left for set up. Change to T 3/3.1 I. Knit to R 232 (250) [268]. Change to T 1/1 I. Arrange ndls. following chart for Part 2 starting from right to left. Knit to R 292 (310) [328]. Transfer RB sts. to MB, knit 1 R and remove sts. on WY.

SKIRT WAISTBAND: Make 2.

Seam 2 panels together. With purl side facing rehang upper edge on 120 (130) [140] ndls. decr. evenly across. RC 0. T 4.2. C 3. St. St. Knit to R 36. Pick up sts. from first row to form double band. Knit 1 row at T 10 and BOLT.

FINISHING:

Attach sleeves. Crochet loop for buttonhole on right side of neckline. Close all remaining seams.

*** 169 Needle Arrangement - PART 1**

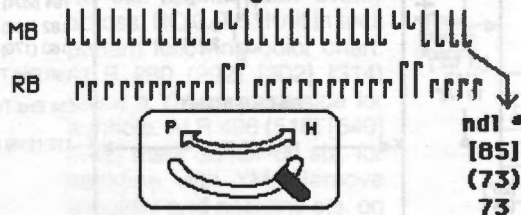

*** 169 Needle Arrangement - PART 2**

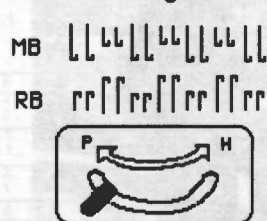

Forget to Change Colors?? Try our Automatic Color Changers!

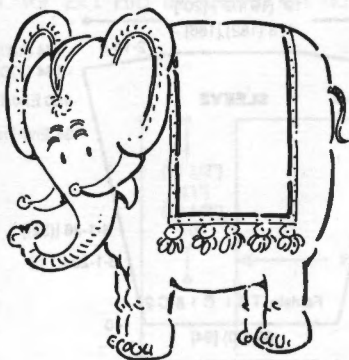

Have you ever forgotten to change yarn colors while knitting a garment that calls for multiple color changes? Or, gotten frustrated having to stop and re-thread your new colors through the yarn tension process? If the answer is "Yes," then our Automatic 4-Color Changers are for you!

Add the Knitter 4-Color Changer (KCC)* to your knitting bed by itself to knit up to four colors in a design without having to stop and re-thread on every change. You won't forget to make your changes either, as every time your knitting carriage returns to the left side of the bed, it slides into the color changer, prompting you to simply push the appropriate yarn's selection button to automatically position it in the knitting carriage for easy knitting of the new color.

Add the Ribber 4-Color Changer (RCC)* to your knitter and ribber combination to knit beautiful, multi-color Jacquard designs with up to four colors in one row. It will also eliminate the "floats" on the back of fair isle knitting. And, yes, it uses the same push-button technology detailed above.

* KCC fits all Standard Gauge models only; RCC fits all Standard and Bulky Gauge models

KCC ONLY \$129.95

SAVE \$12 on each

RCC ONLY \$139.95

Order from your local Knitknig Dealer or contact Knitknig at: 1128 Crenshaw Blvd. • Los Angeles, CA 90019 • 213-938-2077

#169 Fairisle
100 Sts. x 150 Rows

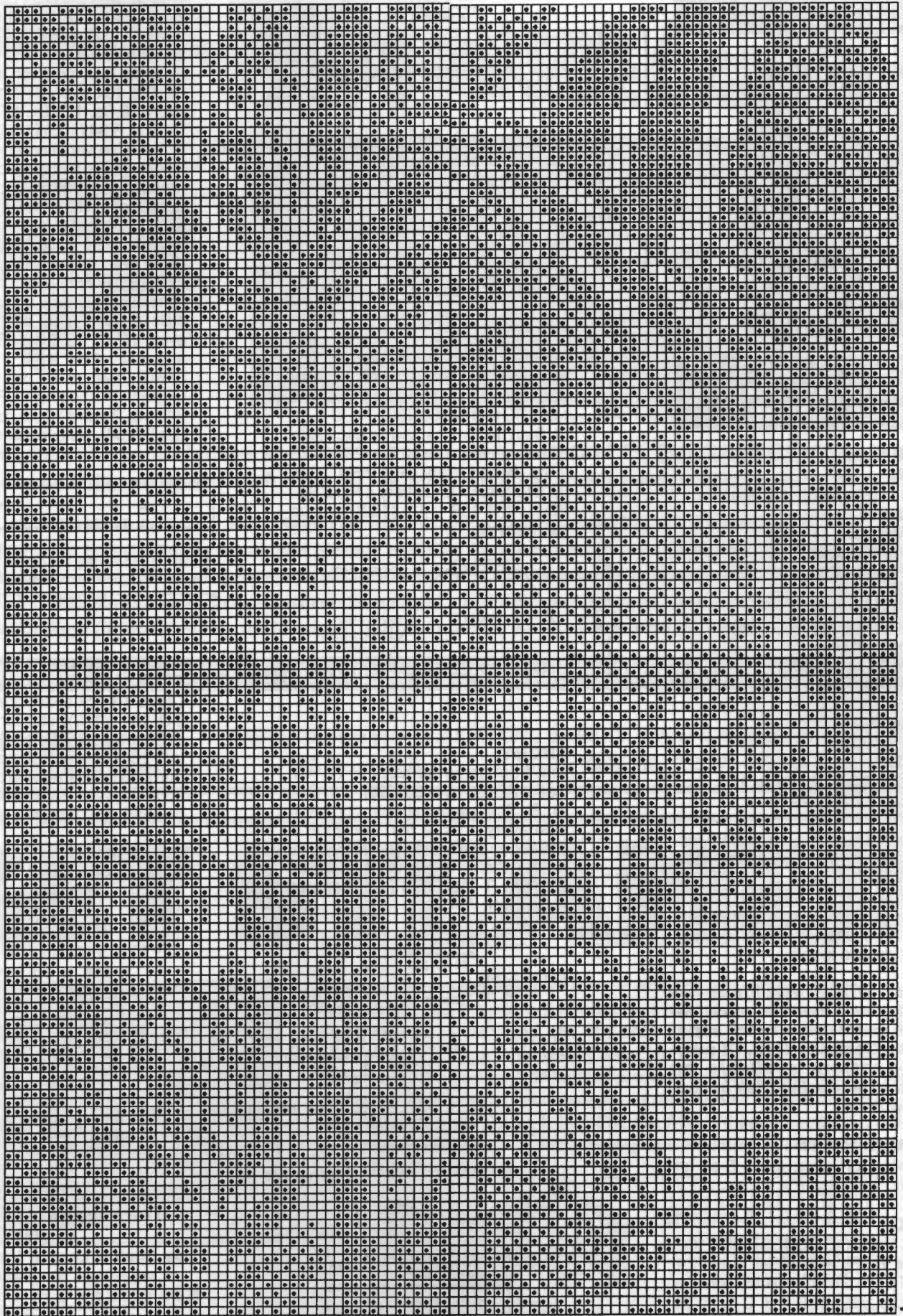

- Track 4

- Track 3

KK Mag Disk: Track 3 and 4; Pattern 901 Both
Pattern is #801 in Kompukit V Pattern Book II



RAGLAN PULLOVER with THREE-COLOR-IN-A-ROW FAIRISLE ACCENT

YARN: Softon

SIZES:

Small (Medium) [Large]

AMOUNT:

C 1: Mykonos - 1 cone
(cone averages 1 lb.)

C 2: Peach - 2 oz.

C 3: Black - 2 oz.

C 4: Ecru - 2 oz.

C 5: Knit-in elastic - Lt. Blue
1 spool all sizes

KIT PRICE: \$35.00

TENSION:

St. St.: T 8

Fairisle: T 9

Rib: T 0.2/0.2 I

GAUGE:

St. St.: 7.7 Sts., 10 Rs. = 1"

Fairisle: 7.7 Sts., 29 Rs. = 1"

Can be made on Punch Card or Electronic knitter with Ribber and Main Bed Color Changer.

Pattern #843 in Compuknit V Pattern Book. All Compuknits use variation key for double length.

Note: Other machines—Punch Card owners must re-punch pattern for color separation. Compuknit III, IV owners—pattern available on KnitMagazine Disk in converted form.

SHAPING HINT:

All full-fashion decr. are a 5-st. full fashion.

BACK:

With C 1 and C 5 CO 150 (158) [166] sts. for K1/P1 Rib. After selvedge RC 0. T 0.2/0.2 I. Knit to R 46. Transfer RB sts. to MB. RC 0. T 8. C 1. St. St. Knit to R 54 (60) [66]. RC 0. T 9. Use

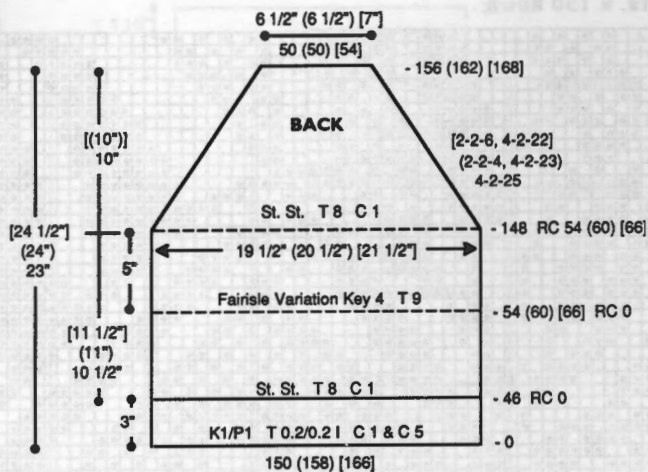

Variation key for double length. Knit in fairisle following memo window data for color changes. At R 148 reset RC to R 54 (60) [66]. T 8. C 1. St. St. Start raglan shaping on each side FF decr. every 4 Rs. 2 Sts. 25x (EOR 2 Sts. 4x and every 4 Rs. 2 Sts. 23x), [EOR 2 Sts. 6x and every 4 Rs. 2 Sts. 22x]. At R 156 (162) [168] remove sts. on WY.

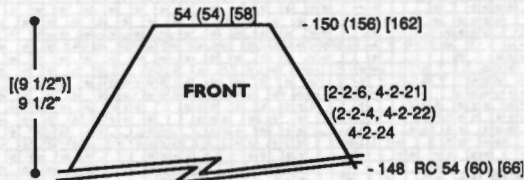

FRONT:

Knit front same as back to R 148. Reset RC to R 54 (60) [66]. T 8. C 1. St. St. Start raglan shaping on each side every 4 Rs. 2 Sts. 24x (EOR 2 Sts. 4x and every 4 Rs. 2 Sts. 22x), [EOR 2 Sts. 6x and every 4 Rs. 2 Sts. 21x]. At R 150 (156) [162] remove sts. on WY.

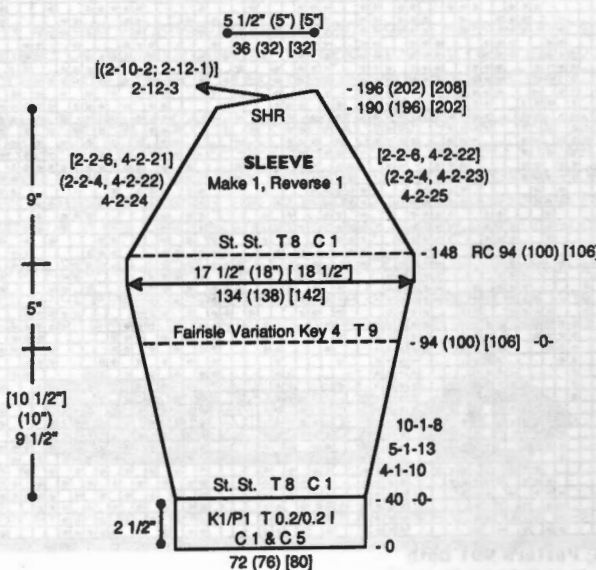

SLEEVE: Make 1, Reverse 1.

With C 1 and C 5 CO 72 (76) [80] sts. for K1/P1 Rib. After selvedge RC 0. T 0.2/0.2 I. Knit to R 40. Transfer RB sts. to MB. RC 0. T 8. C 1. Knit in St. St. while incr. on each side every 4 Rs. 1 St. 10x, every 5 Rs. 1 St. 13x and every 10 Rs. 1 St. 8x. AT THE SAME TIME at R 94 (100) [106] reset RC to 0. T 9. Use variation key for double length. Knit in fairisle following memo window data for color changes. At R 148 reset RC to R 94 (100) [106] and begin raglan shaping. FF decr. on right side every 4 Rs. 2 Sts. 25x (EOR 2 Sts. 4x and every 4 Rs. 2 Sts. 23x), [EOR 2 Sts. 6x and every 4 Rs. 2 Sts. 22x]. FF decr. on left side every 4 Rs. 2 Sts. 24x (EOR 2 Sts. 4x and every 4 Rs. 2 Sts. 21x). AT THE SAME TIME at R 190 (196) [202] begin SHR shaping EOR 12 Sts. 3 x [(10 sts. 2 x and 12 sts. 1 x)]. At R 196 (202) [208] remove sts. on WY.

NECKBAND (Not To Scale)

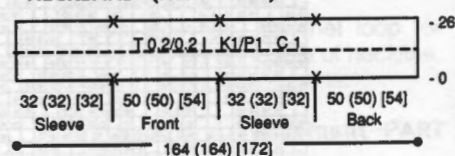

NECKBAND:

Close 3 sections of raglan together. Leave 1 back seam open. With C 1 CO 164 [(172)] sts. for K1/P1 Rib. After selvedge RC 0. T 0.2/0.2 I. Knit to R 26. Transfer RB sts. to MB. With purl side facing, rehang back/sleeve/front/sleeve on neckline sts. as shown on chart. Knit 1 row at T 10 and BOLT.

FINISHING:

Close all seams.

**170 3-Color-in-a Row
8 sts. x 18 Rows**

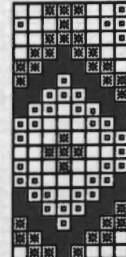

**KK Mag Disk: Track 5; Pat. 901
Pattern separated for 3-color
on disk
Use Double Length Variation Key
Compuknit V--Pattern 843**

Get Electronic Knitting and SAVE Over \$400.00

Big Features-Low \$
Compuknit/ST

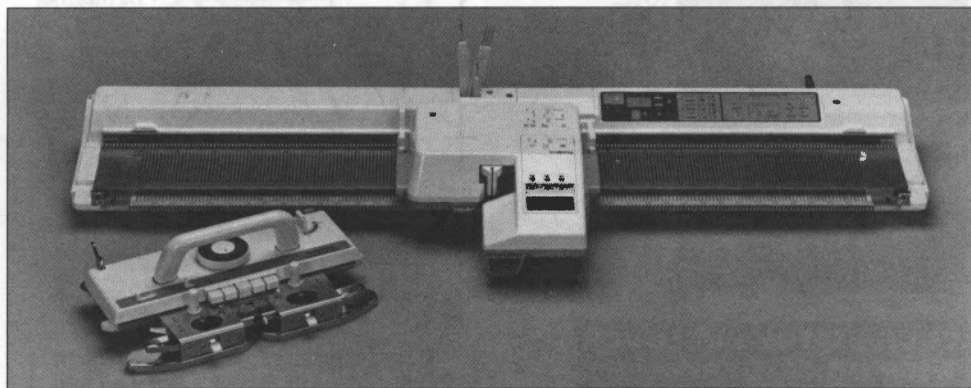

Compuknit/ST shown with Main Carriage and optional Garter Carriage

Buy a Compuknit/ST standard gauge, electronic knitter today for only \$899.95, for a SAVINGS of over \$400.00! This outstanding knitter is loaded with many of the features of electronic knitters costing twice as much:

- 50 built-in patterns including Tuck, Skip, Fair Isle, Weaving, Plating, and Thread Lace designs
- Also Includes built-in Garter Stitch and Normal and Fine Lace patterns (Lace and Garter Carriages optional)
- Additional memory for storing user-inputted patterns from 1 to 24 stitches wide and over 1000 rows long
- Like all Compuknits, original creations can be entered via the Pattern Design Computer and/or Disk Drive
- Variation keys for double-long, upside-down, pattern reverse, yarn color reverse and more

The full-feature Compuknit/ST is the only electronic knitter available today for under \$1,000



Available through your local KNITKING dealer. Or, if there is no dealer in your area, from:
1128 Crenshaw Blvd. • Los Angeles, California, 90019 • Phone (213) 938-2077

GET STEAMED



The new, top-of-the-line VaporSimac MX 170 will surely earn your "es-steam" with the powerful blasts that it produces. With a micro-pump located in the stand, the MX 170's Dual Control switch even allows you to choose between a "blast" or continuous steam output. Either way, the curl in your knitted projects will relax—so, too will you, due to the light weight effortlessness of this marvel! With a non-stick, non-stain black aluminum sole plate, the MX 170 need not be limited to knitwear; all of your fabric blocking and steaming needs can be met with professional results.

SAVE \$50

Now ONLY
\$179.95

Call your local Knitking Dealer, or contact Knitking at 213-938-2077



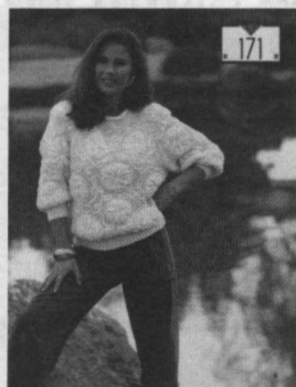

TUCK STITCH PULLOVER WITH DOILLIE TRIM

YARN: Sorbet and Primo

SIZES:

Small (Medium) [Large]

AMOUNT:

- C 1: Sorbet-Ecru
1 1/2 lbs. (1 1/2 lbs.) [2 lbs.]
- C 2: Primo-Ecru-(1 strand plated)
10 oz. (10 oz.) [12 oz.]
- C 3: Knit-in elastic-Ecru
1 spool all sizes

KIT PRICE:

\$55.00 (\$55.00) [\$70.00]

TENSION:

Tuck: T 7
Rib: T 1/1 I

GAUGE:

Tuck: 3.63 Sts., 9.16 Rs. = 1"

Make on Compuknit/Bulky or Punch Card Bulky with Ribber. Embellished on the DecoKing Custom Embellishment Machine.

Pattern Note: Pattern for tuck is #5 in Compuknit/Bulky Pattern Book. Use variation key #4 (double length) and depress 1 PART and 1 TUCK button at the same time. Garment is worn on the knit side.

Special Note:

Because of the make up of the yarn and pattern stitch, do not use large claw weights. Use 5 small claw weights spaced evenly across for body. DecoKing before ribbing and closing seams. Block each piece and back with freezer paper. Pin doillies in place and stitch around edges and center with no attachment. With large cord finger (bypassing 2 holes on shank) free form cord in place using size 18 needle moving fabric in the direction you are stitching. To end and lock cord, cut slightly above the eye and let it run to the end and lock stitch. Unravel a few rows of the cord

and with latch tool pull end through all loops and lock. You may need to loosen the presser foot in order to slide in the cord finger. If your machine jams, remove bobbin and casing and clear any thread.

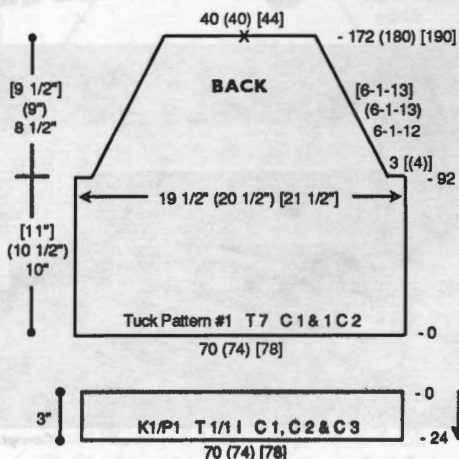

BACK:

With WY CO 70 (74) [78] sts. After several rows end with 1 row Ravel Cord to the left. RC 0. T 7. C 1 and C 2 plated. Pattern #1. Set KC. Knit 1 R to set pattern. COR. Depress 1 Part and 1 Tuck button. Knit to R 92 (96) [102] and shape raglan. On each side BO 3 [(4)] sts., then decr. every 6 Rs. 1 St. 12x, [(1 St. 13x)]. At R 172 (180) [190] mark center with YM and remove sts. on WY.

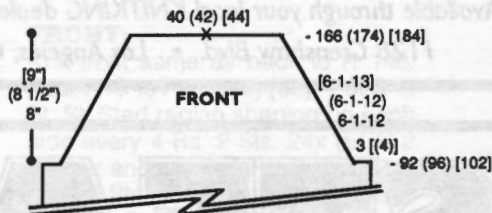

FRONT:

Knit front same as back to R 92 (96) [102] and shape raglan. On each side BO 3 [(4)] sts., then decr. every 6 Rs. 1 St. 12x, (1 St. 12x) [1 St. 13x]. At R 166 (174) [184] mark center with YM and remove sts. on WY.

WAISTBAND:

With purl side facing, rehang lower edge of front/back on 70 (74) [78] ndls. With 2 strands C 1, 1 strand C 2 and 1 strand C 3 knit 1 R. Transfer EOS to RB for K1/P1 Rib. RC 0. T 1/1 I. Knit to R 24, knitting last row at T 10/5 and BOLT.

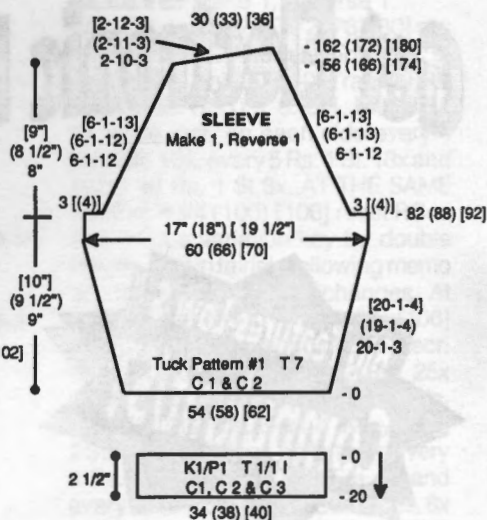

SLEEVE:

With WY CO 54 (58) [62] sts. After several rows end with 1 row Ravel Cord to the left. RC 0. T 7. C 1 and C 2 plated. Pattern #1. Set KC. Knit 1 R to set pattern. COR. Depress 1 Part and 1 Tuck button. Knit in pattern while incr. on each side every 20 Rs. 1 St. 3x (every 19 Rs. 1 St. 4x) and [every 20 Rs. 1 St. 4x]. At R 82 (88) [92] shape raglan. On each side BO 3 [(4)] sts. then decr. on right side every 6 Rs. 1 St. 12x (1 St. 13x) and [1 St. 13x.] Decr. on left side every 6 Rs. 1 St. 12x (1 St. 12x) and [1 St. 13x]. At R 156 (166) [174] SHR shoulder EOR 10 Sts. 3x (11 Sts. 3x) and [12 Sts. 3x]. At R 162 (172) [180] mark center and remove sts. on WY.

SLEEVE CUFF:

With purl side facing, rehang lower edge of sleeve on 34 (38) [40] ndls. With 2 strands C 1, 1 strand C 2 and 1 strand C 3 knit 1 R. Transfer EOS to RB for K1/P1 Rib. RC 0. T 1/1 I. Knit to R 20, knitting last row at T 10/5 and BOLT.

NECKBAND: Knit in 2 sections.

Section 1:

With purl side facing, rehang back neckline on 32 (34) [36] ndls. RC 0. T 3. With 1 strand C 1 and 2 strands

NECKBAND (Not To Scale)

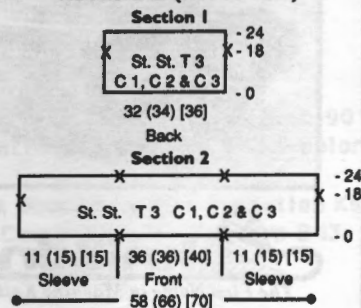

C 2 plated plus C3, knit in St. St. to R 18 and place a YM on each side for aid in seaming. Knit to R 24, knitting last row at T 10 and BOLT

Section 2:

Seam front to sleeves. With purl side facing, rehang sleeve/front/sleeve on 58 (66) [70] ndls. following chart. Knit same as section 1.

CORD:

With 1 strand C 1 'e' CO 4 sts. on standard gauge machine. Depress 1 part button and knit approximately 32 yards., 6 yards for each sleeve and 10 yards for front, 10 yards for back.

DOILLIE:

Large: Make 16.

With WY CO 62 sts. starting with ndl. #32 on left and ending with ndl. #30 on right. Knit 10 Rs. of WY ending with COL. Begin at the right and skip 2 ndls. Push back to NWP the next 3 ndls. Let the WY drop off these ndls. Skip 9 ndls. Push back the next 3 ndls. Repeat ending with 9 ndls. in WP. RC 0. T 4. 1. 2 strands C 1. Leave a long strand 2-3 times the length of the 62 sts. Pattern #2. Set KC. Knit 1 R to set pattern. COR. Depress both Tuck buttons and knit 10 Rs. With latch tool, go up from the bottom (in back of each set of 3 OW ndls. with the long strands. Catch the top strand from the back of all the strands and pull down and under all strands ending in front and cradling all the strands. Hang the stitch on the center of the 3

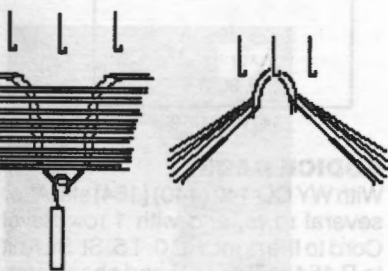

OW ndls. Release KC. Knit 4 Rs. Cut a long end. With double eye ndl. pull through all the stitches. Pull and close center. Weave the seam. Steam lightly. With knit side facing take the long end and single crochet from st. (beginning of the petal). Slip st. along the top SC end st. (end of petal). *Chain 5 SC in first st. Slip st. along the top. Single crochet in last st. Repeat from *.

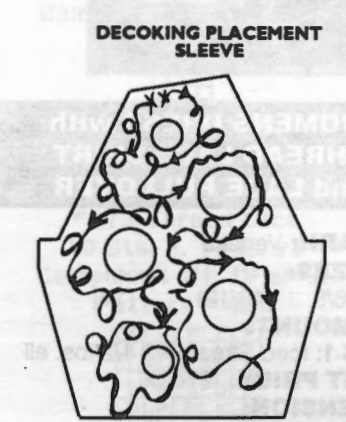
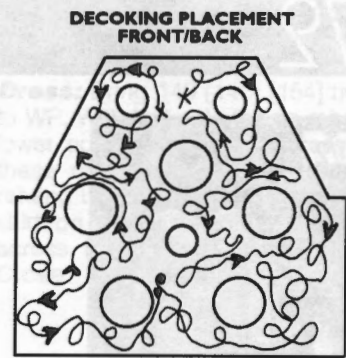
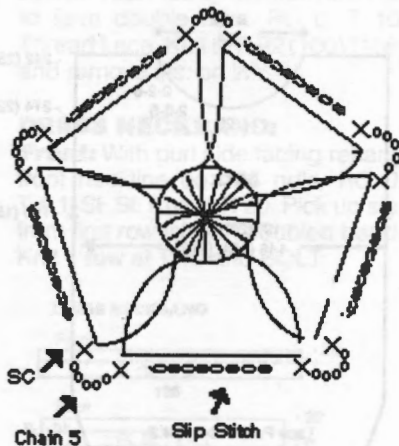

Small: Make 10.
With WY CO 50 sts. starting with ndl. #20 on left and ending with ndl. #30 on right. Knit in the same manner as Large Doillie but Tuck for 8 Rs., release KC and tuck buttons and K 2 Rs. for a total of 10 Rs.

FINISHING:
Seam neckline so last 6 Rs. roll to the right side. Close all remaining seams.

#171 Tuck Pullover Pattern #2
12 Sts. x 10 Rows

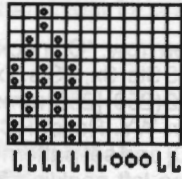

Note: Compuknit/Bulky
Use Variation Key 6 (Negative) to reverse black and white
Punch Card: Punch card in reverse black and white as shown
KK Mag Disk: Track 6; Pattern 902

#171 Tuck Pullover Pattern #2
2 Sts. x 8 Rows



KK Mag Disk:
Track 6; Pattern 901

**Make Your Life Easier . . .
Let a Knitleader Work for You**

With a KL 16 Knitleader, you can create a full-size chart of the garment you are knitting. And, as you knit, the chart rotates, telling you, on a row-by-row basis, exactly when and where to increase and decrease stitches for perfect garment shaping every time. Use it with any Knitking Standard or Bulky Gauge machines — it will even fit on the Power Drive Unit.

SAVE \$30
\$169.95

See your local Knitking Dealer or contact Knitking to order.



WOMENS DRESS with THREAD LACE SKIRT and LACE PULLOVER

YARN: Venetia

SIZES:

6/8 (10/12) [14]

AMOUNT:

C 1: Iced Stream - 2 1/2 lbs. all

KIT PRICE: \$70.00

TENSION:

Lace: T 4.2

St. St.: T 5

Thread Lace: T 10

Hems: T 4.1 or T 4.2

GAUGE:

Lace: 7.7 Sts., 9.15 Rs. = 1"

St. St.: 9 Sts., 10.52 Rs. = 1"

Thread Lace: 7 Sts., 8.7 Rs. = 1"

Make on Compuknit III, IV or V Machine. Lace is built-in Pattern #104. Thread Lace is built-in Pattern #401.

Note: Read instruction book on how to knit Thread Lace before knitting skirt.

Use Venetia yarn as thread lace.

PULLOVER BACK:

With WY CO 142 (150) [158] sts. After several rows, end with 1 row Ravel Cord to the right. RC 0. T 4.2. St. St. Knit to R 22. Pick up sts. from first row to form double hem. RC 0. Knit in lace pattern while incr. on each side every 10 Rs. 1 St. 2x. At R 150 (154) [158] place a YM on each side for armhole. At R 214 (222) [230] shape neckline. With WY or Ravel Cord knit to 'A' position center 20 sts. and all sts. to the left. Note pattern row. *On neckline edge SHR EOR 3 Sts. 5x and 2 Sts. 6x. At R 242 (250) [258] remove shoulder sts. on WY. Reset RC to R 214 (222) [230] and set pattern to correct row. Shape left neckline from *, reversing shaping. Remove shoulder and neckline sts. on separate WY.

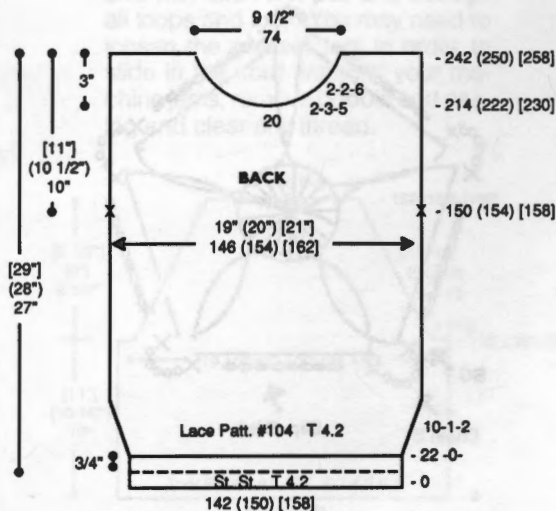

PULLOVER FRONT:

Knit front same as back to R 204 (212) [220]. Shape neckline. With WY or Ravel Cord knit to 'A' position center 20 sts. and all sts. to the left.

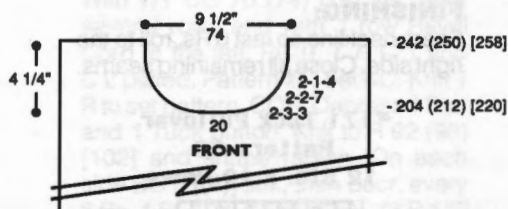

Note pattern row. *On neckline edge SHR EOR 3 Sts. 3x, 2 Sts. 7x and 1 St. 4x. At R 242 (250) [258] remove shoulder sts. on WY. Reset RC to R 204 (212) [220] and set pattern to correct row. Shape left neckline from *, reversing shaping. Remove shoulder and neckline sts. on separate WY.

PULLOVER SLEEVE:

With WY CO 68 (70) [74] sts. After

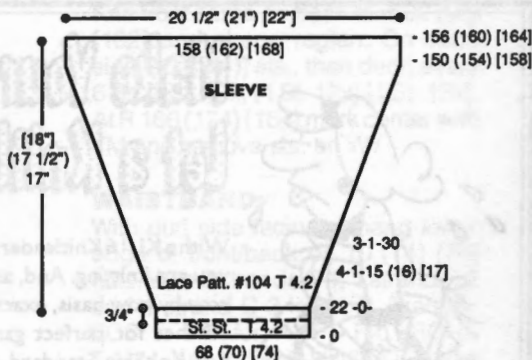

several rows, end with 1 row Ravel Cord to the right. RC 0. T 4.2. St. St. Knit to R 22. Pick up sts. from first row to form double hem. RC 0. Knit in lace pattern while incr. on each side every 4 Rs. 1 St. 15 (16) [17] x and every 3 Rs. 1 St. 30x. At R 156 (160) [164] knit 1 row at T 10 and BOLT.

PULLOVER NECKBAND:

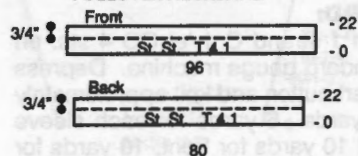

PULLOVER NECKBAND:

Front: With purl side facing, rehang front neckline on 96 ndls. RC 0. T 4.1. St. St. Knit to R 22. Pick up sts. from first row to form double band. Knit 1 row at T 10 and BOLT.

Back: With purl side facing, rehang back neckline on 80 ndls. RC 0. T 4.1. St. St. Knit to R 22. Pick up sts. from first row to form double band. Knit 1 row at T 10 and BOLT.

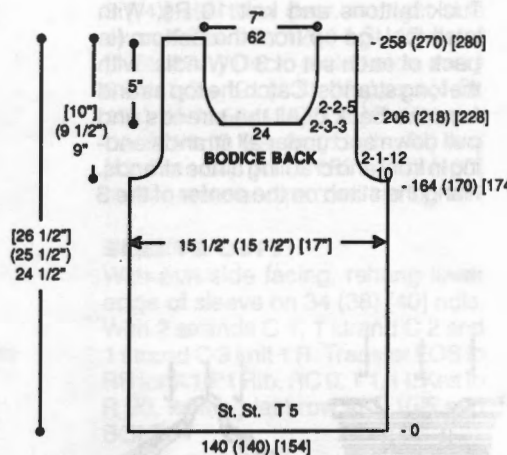

BODICE BACK:

With WY CO 140 (140) [154] sts. After several rows, end with 1 row Ravel Cord to the right. RC 0. T 5. St. St. Knit to R 164 (170) [174] and shape armhole. On each side BO 10 sts., then decr. EOR 1 St. 12x. At R 206 (218) [228] shape neckline. Place center 24 sts. in HP and all sts. to the left. *On neckline edge SHR EOR 3 Sts. 3x and 2 Sts. 5x. At R 258 (270) [280] remove shoulder sts. on WY. Reset RC to R 206 (218) [228] and shape left neckline from *, reversing shaping. Remove shoulder and neckline sts. on separate WY.

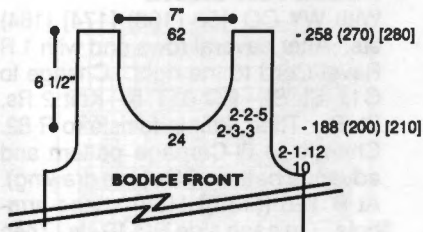

BODICE FRONT:

Knit front same as back to R 188 (200) [210] and shape neckline. Place center 24 sts. in HP and all sts. to the left. *On neckline edge SHR EOR 3 Sts. 3x and 2 Sts. 5x. At R 258 (270) [280] remove shoulder sts. on WY. Reset RC to R 188 (200) [210] and shape left neckline from *, reversing shaping. Remove shoulder and neckline sts. on separate WY.

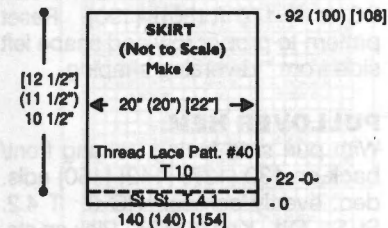

SKIRT: Make 4.

With WY CO 140 (140) [154] sts. After several rows, end with 1 row Ravel Cord to the right. RC 0. T 4.1. St. St.

Knit to R 22. Pick up sts. from first row to form double hem. RC 0. T 10. Thread Lace. Knit to R 92 (100) [108] and remove sts. on WY.

DRESS NECKBAND:

Front: With purl side facing rehang front neckline on 126 ndls. RC 0. T 4.1. St. St. Knit to R 20. Pick up sts. from first row to form doubled band. Knit 1 row at T 10 and BOLT.

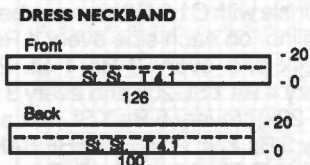

Back: With purl side facing rehang back neckline on 100 ndls. RC 0. T 4.1. St. St. Knit to R 20. Pick up sts. from first row to form doubled band. Knit 1 row at T 10 and BOLT.

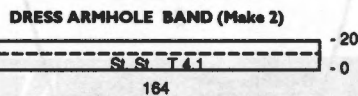

ARMHOLE BAND: Make 2.

Close shoulder seams first. With purl side facing rehang armhole on 164 ndls. RC 0. T 4.1. St. St. Knit to R 20. Pick up sts. from first row to form doubled band. Knit 1 row at T 10 and BOLT.

FINISHING:

Pullover: Close shoulder seams and attach sleeves. Close all remaining seams.

Dress: Bring 140 (140) [154] ndls. to WP. With knit side facing rehang lower edge of front/back dress on these ndls. With purl side facing rehang upper edge of 2 sections of skirt on these ndls. decr. evenly across. Knit 1 R at T 10 and BOLT. Close all remaining seams.

#172 Lace Pattern
4 Sts. x 8 Rows
Compuknit III, IV or V:
Pattern #104



#172 Thread Lace
10 Sts. x 14 Rows
Compuknit III, IV or V:
Pattern #401

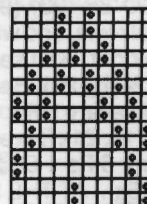

173



GARTER CARRIAGE CARDIGAN SET

YARN: Sorbet
SIZES: 6/8 (10/12) [14] [16]
AMOUNT:
C 1: Turquoise - 2 lbs. all sizes
C 2: White - 4 oz. all sizes

KIT PRICE: \$65.00

TENSION:

Fairisle.: T 5
Garter Carriage: T 5
Hem Bands: T 4.2

GAUGE:

G-Carr: 8.52 Sts., 10.4 Rs. = 1"
Fairisle: 8.97 Sts., 10 Rs = 1"

Make on Standard Gauge Machine with Garter Carriage.

CARDIGAN BACK:

With WY CO 170 (180) [188] [196] sts. After several rows end with 1 R Ravel Cord to the right. Change to C1. RC 0. T 5. Knit 2 Rs St. St. Change to Fairisle. C1 and C2. Knit to R 82. Change to C1 for G-Carr pattern. Knit to R 160 [(170)] [172] and mark each side with YM for armhole. Continue in G-Carr pattern to R 270 [(280)] [288]. Mark center 50 sts. with YM for neck opening. Remove on WY.

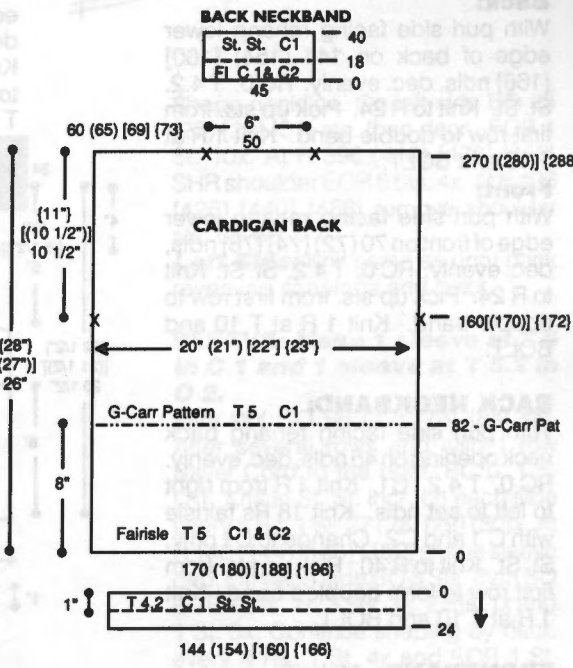

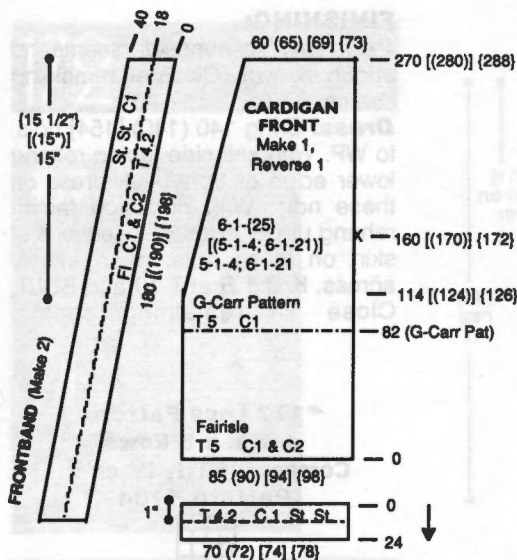

FRONT BAND COLOR CHART

Technique	# Rs	Color
St. St.	to end	C1
Fairisle	18 Rs	C1 & C2
St. St.	1 R	C1

CARDIGAN FRONT:

Make 1, Reverse 1. With WY CO 85 (90) [94] [98] sts. After several rows, end with 1 R Ravel Cord to the right. Knit same as back to R 114 [(124)] [125]. Begin shaping front by dec every 5 Rs 1 St. 4x and every 6 Rs 1 St. 21x [(every 5 Rs 1 St. 4x and every 6 Rs 1 St. 21x)] [every 6 Rs 1 St. 25x]. AT THE SAME TIME at R 160 [(170)] [172] mark each side with YM for armhole. At R 270 [(280)] [288] remove shoulder sts. on WY.

CARDIGAN HEM:

Back:

With purl side facing rehang lower edge of back on 144 (154) [160] [166] ndls, dec. evenly. RC 0. T 4.2. St. St. Knit to R 24. Pick up sts. from first row to double band. Knit 1 R at T 10 and BOLT.

Front:

With purl side facing rehang lower edge of front on 70 (72) [74] [78] ndls, dec. evenly. RC 0. T 4.2. St. St. Knit to R 24. Pick up sts. from first row to double band. Knit 1 R at T 10 and BOLT.

BACK NECKBAND:

With purl side facing rehang back neck opening on 45 ndls, dec. evenly. RC 0. T 4.2. C1. Knit 1 R from right to left to set ndls. Knit 18 Rs fairisle with C 1 and C2. Change to C1 only. St. St. Knit to R 40. Pick up sts. from first row to form doubled band. Knit 1 R at T 10 and BOLT.

FRONTBAND: Make 2

With purl side facing rehang front (including front hem) on 182 [(190)] [198] ndls. evenly. RC 0. T 4.2. C1.

Knit 1 R from right to left to set ndls. Knit 18 Rs fairisle with C 1 and C2. Change to C1 only. St. St. Knit to R 40. Pick up sts. from first row to form doubled band. Knit 1 R at T 10 and BOLT.

SLEEVE:

With WY CO 82 [(90)] [94] sts. After several rows, end with 1 R Ravel Cord to the right. Change to C1. RC 0. T 5. Knit 2 Rs. St. St. Continue in Fairisle with C1 & C2 same as back while inc. on each side every 4 Rs 1 St. 24x and every 3 Rs 1 St. 20x [(every 4 Rs 1 St. 20x and every 3 Rs 1 St. 20x)] [every 5 Rs 1 St. 18x and every 3 Rs 1 St. 20x]. AT THE SAME TIME at R 82 change to G-Carriage pattern, knit to R 170 [(176)] [180]. Remove sts. on WY.

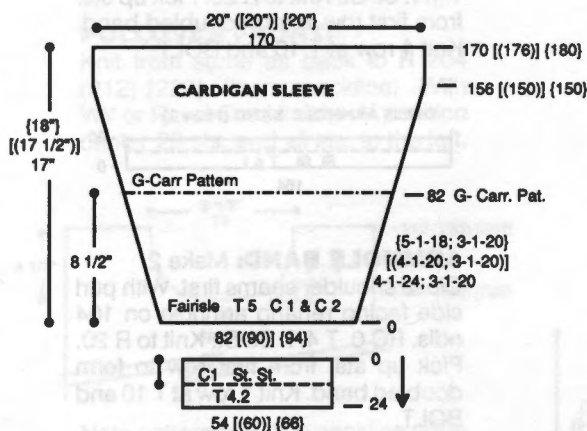

SLEEVE CUFF:

With purl side facing rehang lower edge of sleeve on 54 [(60)] [66] ndls, dec. evenly. RC 0. T 4.2. C1. St. St. Knit to R 24. Pick up sts. from first row to form doubled band. Knit 1 R at T 10 and BOLT.

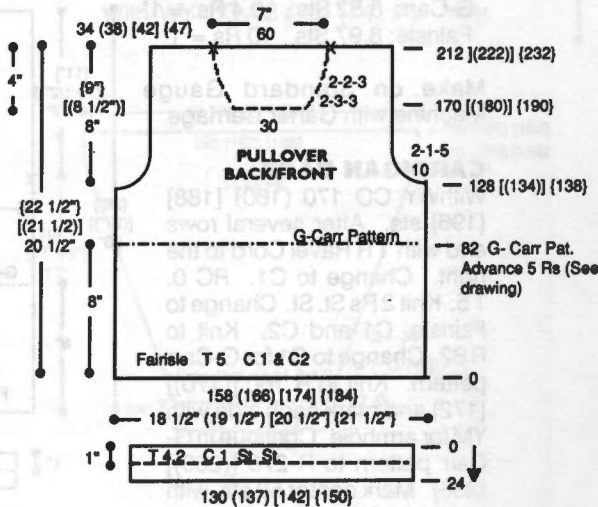

PULLOVER BAND COLOR CHART

Technique	# Rs	Color
St. St.	8 Rs	C1
Fairisle	4 Rs	C1 & C2
St. St.	2 Rs	C1

PULLOVER BACK:

With WY CO 158 (166) [174] [184] sts. After several rows end with 1 R Ravel Cord to the right. Change to C1. St. St. RC 0. T 5. Knit 2 Rs. St. St. Then, knit in fairisle to R 82. Change to G-Carriage pattern and advance pattern 5 Rs (see drawing). At R 128 [(134)] [138] shape armhole. On each side BO 10 sts. Then dec. EOR 1 St. 5 x for all sizes. At R 212 [(222)] [232] mark center 60 sts. for neck opening and remove shoulder and neck sts. on WY.

PULLOVER FRONT:

Knit front same as back to R 170 [(180)] [190]. Shape neckline. Knit center 30 sts. to 'A' position on Ravel Cord and all sts. to the left. Note pattern row. * Shape neckline on right edge dec. EOR 3 sts. 3 x and EOR 2 sts. 3 x. At R 212 [(222)] [232] remove shoulder sts. on WY. Reset RC to R 170 [(180)] [190]. Reset pattern to proper row and shape left side from * reversing shaping.

PULLOVER HEM:

With purl side facing, rehang front/back on 130 (137) [142] [150] ndls. dec. evenly across. RC 0. T 4.2. St. St. C 1. Knit to R 24. Pick up sts. from first row to form doubled band. Knit 1 R at T 10 and BOLT.

NECKBAND:

Close one shoulder seam. With purl

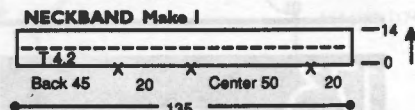

side facing, rehang neck opening on 135 ndls. following placement as shown on chart. RC 0. T 4.2. Knit 14 Rs. following color charts for bands. Pick up sts. from first row to form doubled band. Knit 1 R at T 10 and BOLT.

ARMHOLE BAND:

Close remaining shoulder seam. With purl side facing, rehang armhole opening on 138 [(144)] [150] ndls. RC 0. T 4.2. Knit 14 Rs. following color charts for bands. Pick up sts. from first row to form doubled band. Knit 1 R at T 10 and BOLT.

ARMHOLE BAND Make 2

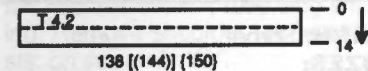

FINISHING:

Close all remaining seams.

G-Carriage - Jacket

G-Carriage - Top

Fairisle

F1 Bands

173 G-Carriage Pattern
24 Sts. x 212 Rows

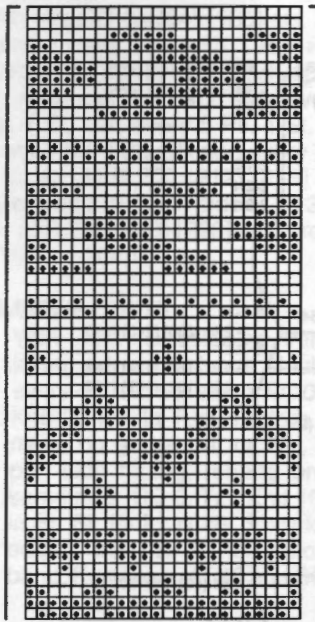

174



**WOMENS
SHEATH DRESS**

YARN: Sorbet

SIZES:

6/8 (10/12) [14] [16]

AMOUNT:

C 1: White - 1 lb. all sizes

C 2: Navy - 1 lb. all sizes

KIT PRICE: \$55.00

TENSION:

C 1 Body: T 5

Bands: T 4

C 2 Body: T 5.2

Bands: T 4.2

GAUGE:

Body: 8.35 Sts., 11.1 Rs. = 1"

Make on any Standard Machine.

Note: Back and front are each knit in 2 pieces and then seamed up the center.

BACK:

Right Side: Bring 78 (82) [86] [90] ndls. to WP. RC 0. T 4.2. C 2. Make hem with 40 Rs. following Method Two for Hems in General Instructions. After making hem, change to T 5.2. RC 0. Knit in St. St. while shaping lower edge by SHR shaping on right side EOR 10 Sts. 5x. RC 0. On right side shape by incr. every 10 Rs. 1 St. 5x. After R 54 (56) [58] [60] change to T 5. C 1. At R 152 (162) [172] [182] shape right side by decr. every 6 Rs. 1 St. 11x. AT THE SAME TIME after R 158 (166) [174] [182] change to T 5.2. C 2. After R 220 (230) [240] [250] shape right side by incr. every 6 Rs. 1 St. 11x. At R 302 (316) [330] [344] shape armhole. On right side BO 4 Sts. then BO EOR 3 Sts. 1x, 2 Sts. 1x and 1 St. 5x. At R 396 (416) [436] [456] shape neckline. On left side bring 19 (21) [23] [25] sts. to HP and SHR EOR 4 Sts. 4x. AT THE SAME TIME on the right side SHR shoulder EOR 6 Sts. 4x. At R 406 (426) [446] [466] remove shoulder and neckline sts. on separate WY.

Left Side: Knit same as right side reversing shapings and color.

FRONT:

Right Side: Knit right front same as right back to R 374 (394) [414] [434].

8" (8 1/2") [9"] [9 1/2"]
70 (74) [78] [82]

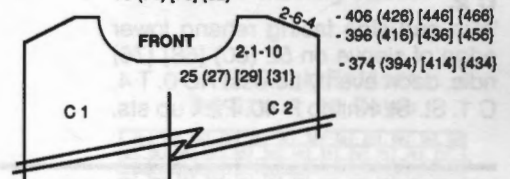

- 406 (426) [446] [466]
- 396 (416) [436] [456]
- 374 (394) [414] [434]

Shape neckline. On left side BO 25 (27) [29] [31] sts. then decr. EOR 1 St. 10x. At R 396 (416) [436] [456] SHR shoulder EOR 6 Sts. 4x. At R 406 (426) [446] [466] remove shoulder sts. on WY.

Left Side: Knit same as right back reversing shapings and color.

**SLEEVE: Make 1 sleeve at T 5
in C 1 and 1 sleeve at T 5.2 in
C 2.**

With WY CO 66 (72) [78] [84] sts. After several rows end with 1 row Ravel Cord to the right. RC 0. T 5. C 1. Knit in St. St. incr. on each side every 5 Rs. 1 St. 27 (28) [29] [30]x. At R 140 (144) [148] [152] shape sleeve cap. On each side BO 5 Sts. then BO EOR 4 Sts. 1x, 3 Sts. 1x, 2 Sts. 1x and 1 St. 5x. Continue shaping by decr. every 4 Rs. 1 St. 4x and EOR 1 St. 21 (24) [27] [30]x and EOR 2 Sts. 4x. At R 224 (234) [244] [254] BO all remaining sts.

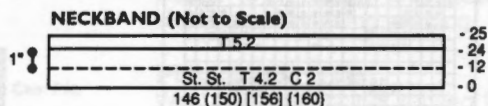
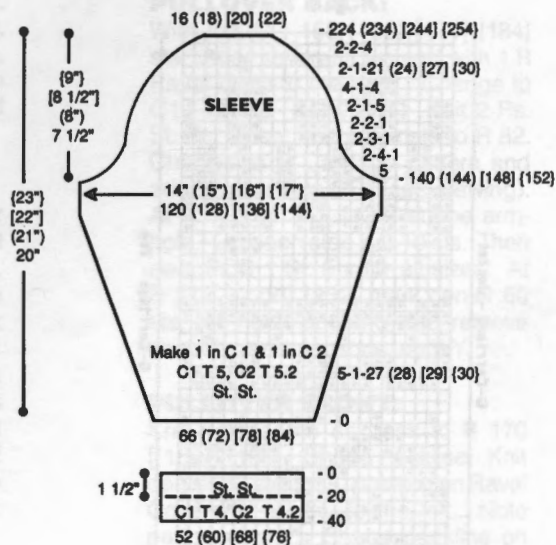
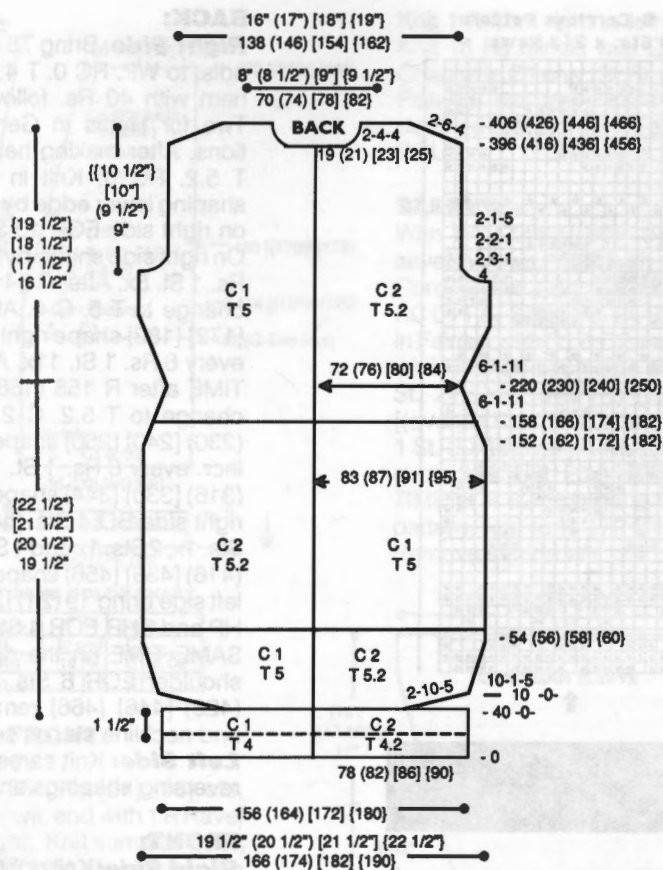

SLEEVE CUFF: Make 1 cuff at T 4 in C 1 and 1 cuff at T 4.2 in C 2.

With purl side facing rehang lower edge of sleeve on 52 (60) [68] [76] ndls. decr. evenly across. RC 0. T 4. C 1. St. St. Knit to R 40. Pick up sts.

from first row to form doubled band. Knit 1 row at T 10 and BOLT.

NECKBAND: Bring 146 (150) [156] [160] ndls. to WP. RC 0. T 4.2. C 2. Make hem with 24 Rs. following Method Two for Hems in General Instructions. Pick up sts.

from first row and knit 1 row at T 5.2. Remove sts. on WY.

FINISHING: Close center back and front seams. Close shoulder seams. Attach neckband and sleeves. Close all remaining seams.

175



WOMENS CASUAL PULLOVER

YARN: Sorbet
SIZES: Small (Medium) [Large]

AMOUNT:
C 1: Royal Blue - 1 cone all sizes approx. 1 lb. 8 oz.

KIT PRICE: \$41.50

TENSION:

St. St.: T 5

Tuck: T 6

GAUGE:

St. St.: 8 Sts., 12 Rs. = 1"

Tuck: 6 Sts., 16 Rs. = 1"

NOTIONS:

21 - 1/4" Buttons.

Make on Standard 24-Stitch Punch Card or Standard Electronic Machine.

Note: You may want to mark center for placket placement while knitting, or after for ease in stitching placket in place.

BACK: With WY CO 164 (172) [180] sts. After several rows end with 1 row Ravel Cord to the right. RC 0. T 5. Knit in St.

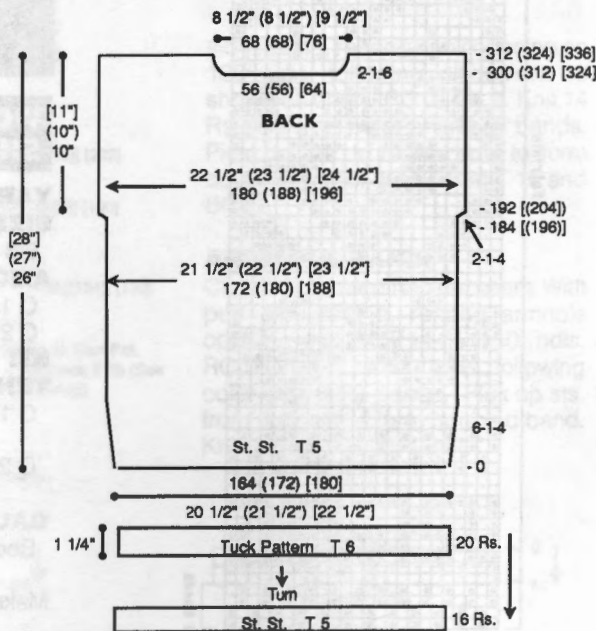

St. while incr. on each side every 6 Rs. 1 St. 4x. At R 184 [(196)] incr. on each side EOR 1 St. 4x for sleeve. At R 300 (312) [324] shape neckline. Place center 56 (56) [64] sts. in HP and all sts. to the left. *On neckline edge decr. EOR 1 St. 6x. At R 312 (324) [336] remove shoulder sts. on WY. Reset RC to R 300 (312) [324]. Shape left neckline from *, reversing shaping. Remove neckline sts. on WY.

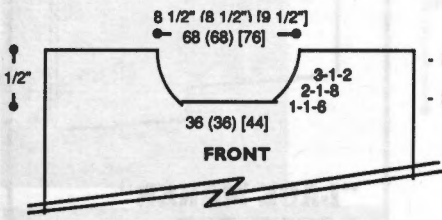

FRONT:

Knit front same as back to R 270 (282) [294]. Shape neckline. Place center 36 (36) [44] sts. in HP and all sts. to the left. *On neckline edge decr. every R 1 St. 6x, EOR 1 St. 8x and every 3 Rs. 1 St. 2x. At R 312 (324) [336] remove shoulder sts. on WY. Reset RC to R 270 (282) [294]. Shape left neckline from *, reversing shaping. Remove neckline sts. on WY.

BACK/FRONT HEM:

With knit side facing, rehang bottom of front/back doubling every 4th and 5th stitch. RC 0. T 6. Knit 20 Rs. in Tuck Pattern. Remove on garter bar or WY. With purl side facing, rehang on the same ndls. RC 0. T 5. Knit 16 Rs. in St. St. Pick up sts. from first row of lower edge of garment to form double hem. Knit 1 row at T 10 and BOLT.

SLEEVE:

With WY CO 84 (84) [100] sts. After several rows, end with 1 row Ravel Cord to the right. RC 0. T 5. Knit in St. St. while incr. on each side every 4 Rs. 1 St. 10x, every 5 Rs. 1 St. 12x, every 6 Rs. 1 St. 12x and every 7 Rs. 1 St. 4x. At R 200 (212) [218] SHR sleeve cap on each side EOR 3 Sts. 4x. At R 208 (220) [226] knit 1 row at T 10 and BOLT.

SLEEVE CUFF:

With knit side facing, rehang lower edge of sleeve doubling every 4th and 5th stitch. RC 0. T 6. Knit 20 Rs. in Tuck Pattern. Remove on garter bar or WY. With purl side facing, rehang on the same ndls. RC 0. T 5. Knit 16 Rs. in St. St. Pick up sts. from lower edge first row to form double band. Knit 1 row at T 10 and BOLT.

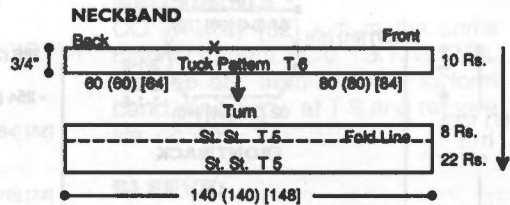
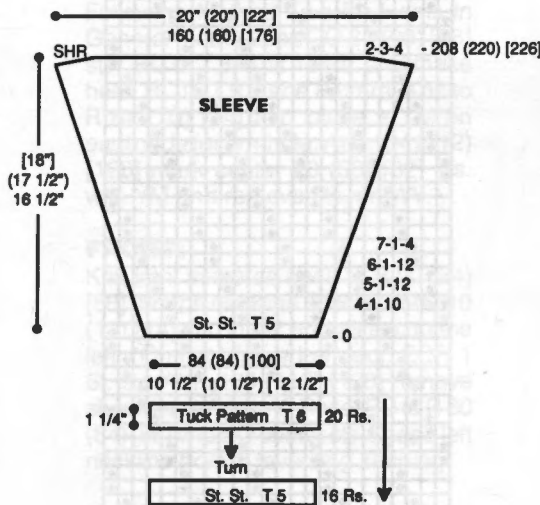

NECKBAND:

Join one shoulder. With knit side facing rehang neckline on 140 (140) [148] ndls. following chart. RC 0. T 6. Knit 10 Rs. in Tuck Pattern. Remove on garter bar or WY. With purl side facing, rehang on the same ndls. RC 0. T 5. Knit 8 Rs. in St. St. Pick up sts. from first row to form double band. Knit 22 Rs. in St. St. Knit 1 row at T 10 and BOLT.

FRONT PLACKET (Not to Scale)

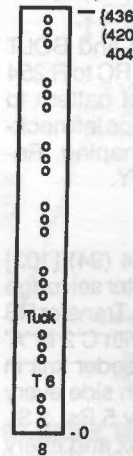

FRONT PLACKET:

CO 8 sts. RC 0. T 6. Tuck Pattern. Knit to R 406 (420) [436] and BO.

FINISHING:

Close remaining shoulder. Attach sleeves. Sew front placket down the middle of front. Sew buttons on in 7 groups of 3 buttons. Close all remaining seams.

#175 Tuck Pattern 24 Sts. x 10 Rows

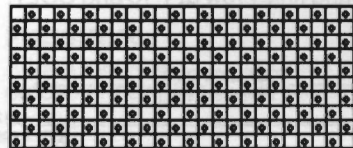

KK Mag Disk: Track 8; Pattern 901

176

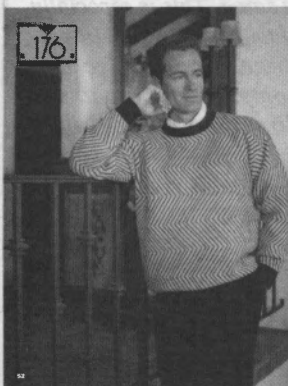

MENS FAIRISLE PULLOVER

YARN: Softon and Venetia

SIZES:

Small (Medium) [Large] [X-Large]

AMOUNT:

- C 1: Softon - Black
1 lb. (1 lb.) [1 lb.] {1-1/4 lb.}
- C 2: Venetia - Dk Champagne
1 lb. (1 lb.) [1 lb.] {1-1/4 lb.}
- C 3: Knit-in Elastic - Black
1 spool all sizes

KIT PRICE:

\$50.00 [(\$50.00)] {\$62.00}

TENSION:

- Fairisle: T 5
- Rib: T 1/1 II

GAUGE:

- Fairisle: 8.1 Sts., 12.5 Rs. = 1"
- Rib: 16 Rs. = 1"

Make on Standard 24-Stitch Punch Card or Standard Electronic Machine with Ribber.

BACK:

With C 1 and C 3 CO 162 (170) [182] [190] sts. for K1/P1 Rib. After selvedge RC 0. T 1/1 II. Knit to R 40. Transfer RB sts. to MB. RC 0. T 5. With C 2 in 'A' Feeder and C 1 in 'B' Feeder knit in fairisle while incr. on each side every 6 Rs. 1 St. 4x. At R 150 (162) [168] [180] place a YM on each side for armhole. At R 286 (300) [312] [324] mark center 64 (64) [68] [72] sts. for neckline. Knit 1 row at T 10 and BOLT.

FRONT:

Knit front same as back to R 254 (268) [280] [292]. Shape neckline. Place center 32 (32) [36] [40] sts. in HP and all sts. to the left. Note pattern row. *On neckline edge SHR every row 1 St. 6x, EOR 1 St. 8x and every 3 Rs. 1 St. 2x. At R 286 (300) [312]

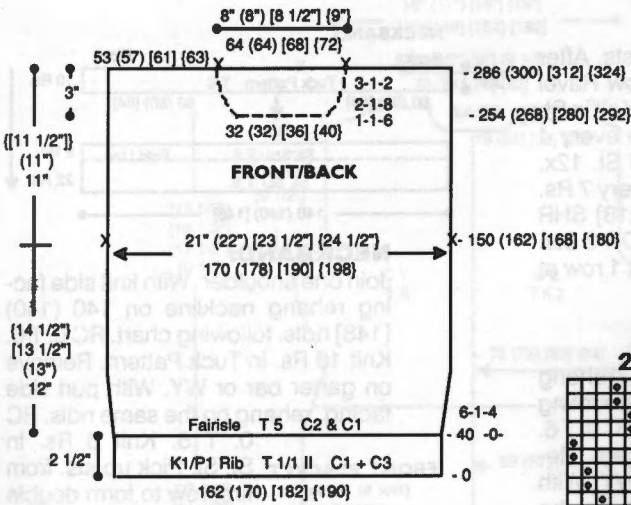

{324} knit 1 row at T 10 and BOLT shoulder stitches. Reset RC to R 254 (268) [280] [292]. Reset pattern to row noted above and shape left neckline from *, reversing shaping. Remove neckline sts. on WY.

SLEEVE: Make 2.

With C 1 and C 3 CO 94 (94) [102] [102] sts. for K1/P1 Rib. After selvedge RC 0. T 1/1 II. Knit to R 40. Transfer RB sts. to MB. RC 0. T 5. With C 2 in 'A' Feeder and C 1 in 'B' Feeder knit in fairisle while incr. on each side every 4 Rs. 1 St. 20x and every 5 Rs. 1 St. 22x (every 4 Rs. 1 St. 20x and every 5 Rs. 1 St. 22x) {[every 5 Rs. 1 St. 42x]}. At R 198 (204) [212] [216] SHR sleeve cap EOR 2 Sts. 7x. At R 212 (218) [226] [230] mark center with YM and knit 1 row at T 10 and BOLT.

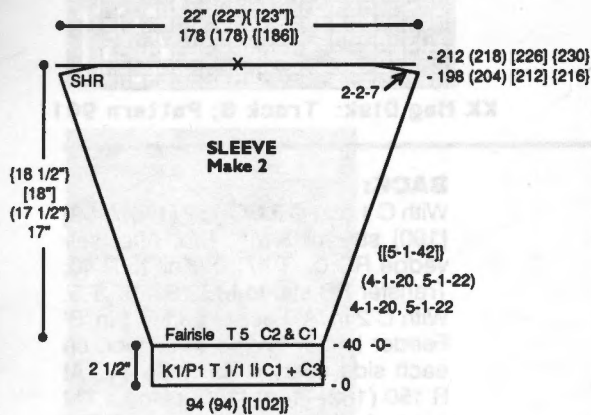

NECKBAND:

With C 1 and C 3 CO 176 (176) [182] [188] sts. for K1/P1 Rib. After selvedge RC 0. T 1/1 II. Knit to R 20. Transfer RB sts. to MB and remove sts. on WY.

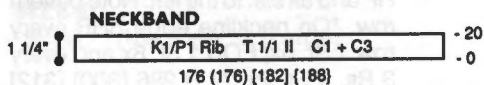

FINISHING:

Close all seams. Attach neckband to neckline with a crochet hook.

*176 Fairisle
 24 Sts. x 92 Rows

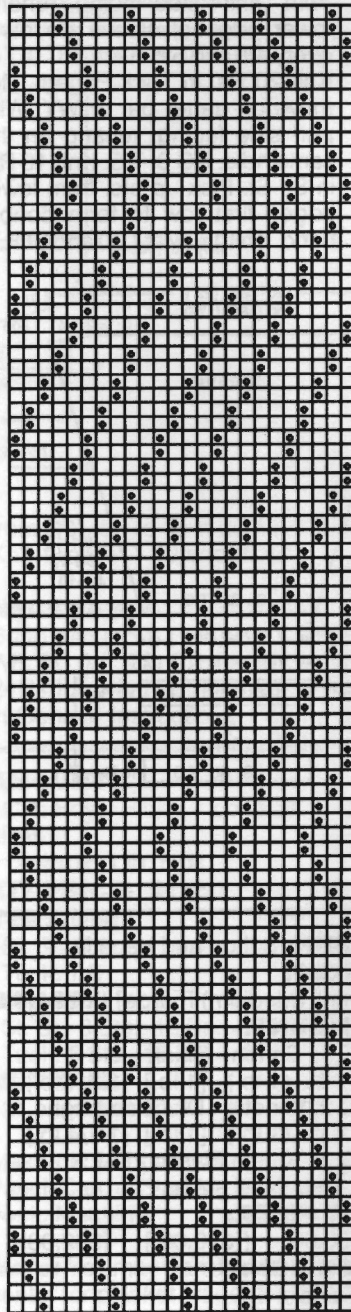

KK Mag Disk: Track 9; Pattern 901

NEW CARTRIDGES FOR COMPUKNITS

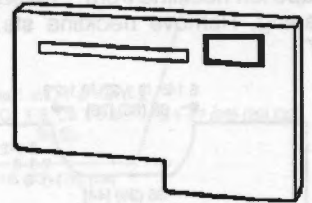

"LACE MAKER" CARTRIDGE

There's nothing more beautiful than the delicate appeal of Lace. And, with this new cartridge, you can use it (with your KC Pattern Design Computer) to create Lace and Fine Lace Patterns. The KC will automatically convert the "transfer symbols" you entered into a "data pattern" for easy communication into your Compuknit V or ST knitting machine.

Regularly priced at \$129.95, this exciting, new accessory is SALE priced at \$119.95.

"PATTERN SAVER" CARTRIDGE

If you use the Control Panel on your Compuknit V to design your own original patterns, you can now save them directly to this new "Pattern Saver" Cartridge. This little marvel effectively expands your Comp. V's memory, as its capacity and the Comp. V's are the same. This is especially evident when loading your patterns from the Cartridge into your Comp. V—unlike patterns loaded from the KC, those loaded from this Cartridge do not interfere with others created on the Compuknit V.

Regularly priced at \$89.95, this handy storage device is SALE priced at only \$69.95.

Order both cartridges early—Limited Supply

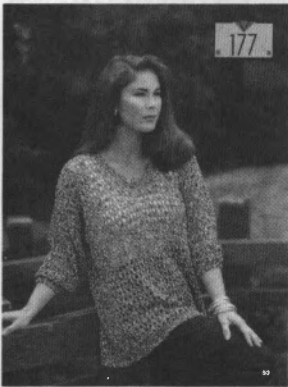

WOMENS BULKY TUNIC

YARN: Pebble - Black/White

SIZES: Small (Medium) [Large]

AMOUNT: 1 cone - approx. 1 lb.

KIT PRICE: \$28.50

TENSION:

Lace Pattern: T 9

St. St.: T 3

GAUGE:

Lace Pattern: 3.8 Sts., 4.45 Rs. = 1"

Make on any Bulky Machine.

Hand Manipulated Lace Pattern:

1. St. St. Knit 4 Rs.
2. Beginning with 3rd ndl. from left transfer EOS to the next ndl. leaving empty ndl. in WP.
3. St. St. Knit 4 Rs.
4. Beginning with 3rd ndl. from right transfer EOS to the next ndl. leaving empty ndl. in WP.
5. St. St. Knit 4 Rs.
6. Repeat steps 2 through 5.

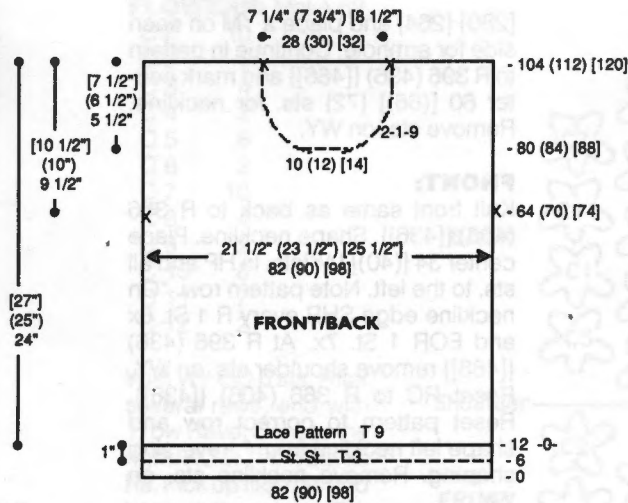

NECKBAND:

CO 74 (78) [82] sts. in the same manner as hem. RC 0. T 3. Knit 12 Rs. Pick up sts. from first row to form band. Knit 1 row at T 9 and remove sts. on WY.

SLEEVE:

Close shoulder seams. Bring 72 (76) [80] ndls. to WP. With purl side facing rehang front/back between armhole markers on these ndls. RC 0. T 9. Knit in Lace Pattern while decr. on each side every 3 Rs. 1 St. 18 (20) [21] x. At R 56 (60) [64] remove sts. on WY.

SLEEVE BAND

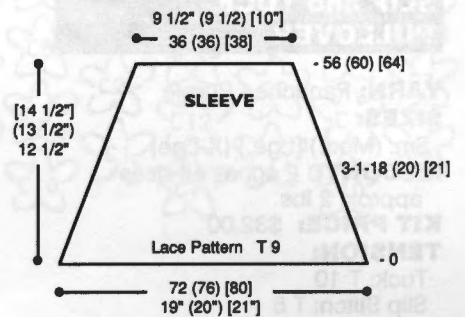
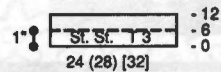

SLEEVE BAND:

Bring 24 (28) [32] ndls. to WP. Rehang lower edge of sleeve on these ndls. decr. evenly across. RC 0. T 3. St. St. Knit to R 12. Pick up sts. from first row to form double band and BO.

FINISHING:

Attach neckband to neckline with crochet hook. Close all remaining seams.

BACK:

Following Method Two for Hems in General Instructions CO 82 (90) [98] sts. RC 0. T 3. Knit 12 Rs. and make hem. RC 0. T 9. Lace Pattern. Knit to R 64 (70) [74] and place a YM on each side for armhole. At R 104 (112) [120] mark center 28 (30) [32] sts. with YM and remove sts. on WY.

FRONT:

Knit front same as back to R 80 (84) [88]. Shape neckline. Place center 10 (12) [14] sts. in HP and all sts. to the left. *On neckline edge decr. EOR 1 St. 9x. At R 104 (112) [120] remove shoulder sts. on WY. Reset RC to R 80 (84) [88] and BO center sts. Shape left neckline from *, reversing shaping.

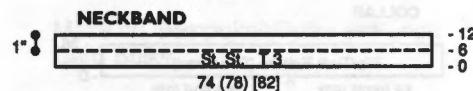

Use DesignaKnit With Your Punch Card?? Find Out How ↴



With the KNITTING-compatible dot-matrix printer, you can quickly print out a hard copy "template" of the original patterns you have created using the DESIGNAKNIT Computer-Aided Design software program (as well as any of the other Printing options available through this remarkable program). Use this template of your pattern to punch cards for use with your punch card knitter. Then, attach the new "Non-Electronic" Link to your knitter to experience "Knitting-From-The-Screen" (see ad on pg. 25). And, of course, this same Printer can be used with the KC Pattern Design Computer (and included Kwik Konnect Cable) to print-out patterns you've created on it. So, either way, You're the Winner!

- FEATURES INCLUDE:**
- Epson printer emulation
 - Form Feed feature
 - Extra large pattern print-out accommodation
 - Uses plain paper or tractor-fed paper

Includes Kwik Konnect Cable
Only \$319.95

Order one today from your local Knitting dealer or contact Knitting at:
1128 Crenshaw Blvd., Los Angeles, CA 90019 • Phone: 213-938-2077

178



SLIP and TUCK PULLOVER

YARN: Panache - Purple

SIZES:

Sm. (Med.) [Lge.] {X-Lge}

AMOUNT: 2 cones all sizes approx. 2 lbs.

KIT PRICE: \$32.00

TENSION:

Tuck: T 10

Slip Stitch: T 5

GAUGE:

Body: 7 Sts., 16.5 Rs. = 1"

Make on Standard 24-Stitch Punch Card or Standard Electronic Machine. See instruction manual for latch tool cast on.

Note: Sweater is worn on the knit side.

Pattern:

1. Knit 10 Rs. in Slip Stitch at T 5.
2. Knit 20 Rs. in Tuck at T 10.
3. Repeat steps 1 and 2 to end.

BACK:

Latch tool CO 148 (154) [162] {172} sts. Knit in pattern to R 230 (248)

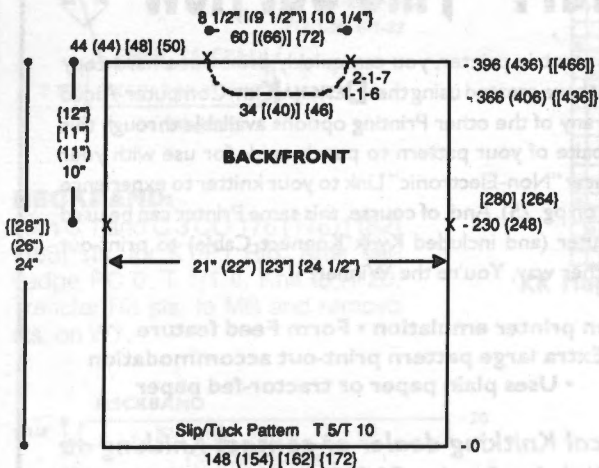

[280] {264} and place a YM on each side for armhole. Continue in pattern to R 396 (436) {[466]} and mark center 60 [(66)] {72} sts. for neckline. Remove sts. on WY.

FRONT:

Knit front same as back to R 366 (406) {[436]}. Shape neckline. Place center 34 [(40)] {46} sts. in HP and all sts. to the left. Note pattern row. *On neckline edge SHR every R 1 St. 6x and EOR 1 St. 7x. At R 396 (436) {[466]} remove shoulder sts. on WY. Reset RC to R 366 (406) {[436]}. Reset pattern to correct row and shape left neckline from *, reversing shaping. Remove neckline sts. on WY.

SLEEVE:

Latch tool CO 78 [(92)] {106} sts. Knit in pattern while incr. on each side every 7 Rs. 1 St. 31x. At R 280 (310) [310] {340} mark center and remove sts. on WY

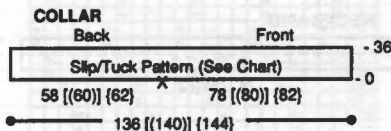
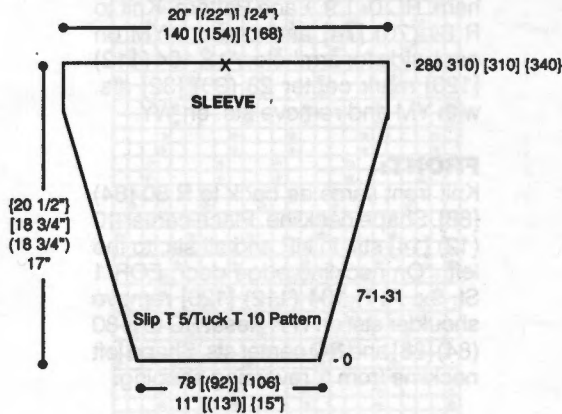

COLLAR CHART

# Rows	Patt.	Tension
6	Slip	5
20	Tuck	10
10	Slip	5

COLLAR:

Close one shoulder first. With purl side facing rehang front and back neckline on 136 [(140)] {144} ndls. following chart. RC 0. T 5. Knit 6 Rs. in Slip Stitch. Change to T 10. Knit 20 Rs. in Tuck. Change to T 5. Knit 10 Rs. in Slip Stitch. Knit 1 row at T 10 and BOLT.

FINISHING:

Close remaining shoulder. With knit side facing rehang upper edge of sleeve. With purl side facing rehang armhole between markers on these same ndls. Knit 1 row at T 10 and BOLT. Close all remaining seams.

*178 Slip and Tuck Pattern 24 Sts. x 10 Rows

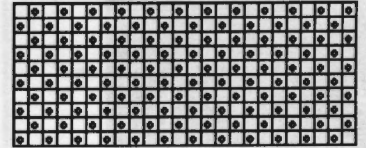

KK Mag Disk: Track 9; Pattern 901

179

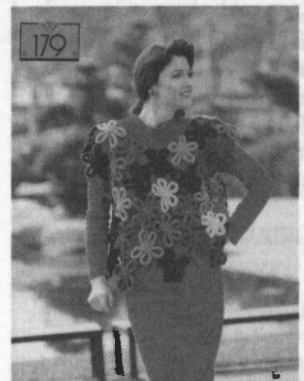

WOMENS FLOWER TOP

YARN: Mirage

SIZES: One Size Fits All

AMOUNT:

- C 1: Raspberry - 6 oz.
- C 2: Charcoal - 4 oz.
- C 3: Yellow - 3 oz.
- C 4: Royal - 2 oz.
- C 5: Black - 3 oz.
- C 6: Red - 2 oz.
- C 7: Jungle - 4 oz.
- C 8: Camel - 3 oz.
- C 9: Lilac - 2 oz.
- C 10: Coffee - 3 oz.
- C 11: Toast - 4 oz.
- C 12: Kelly - 2 oz.

KIT PRICE: \$35.00

TENSION:

Flower: T 4

Rib: T 0/0 I

GAUGE:

Flower: 4 Sts., 7 Rs. = 1"

Rib: 7 Rs. = 1"

Make on any Bulky Machine with Ribber.

Note: Top is made in flowers and assembled with a sewing needle.

FRONT NECKBAND:

With Col. 1 CO 72 sts. for K1/P1 Rib. After selvedge, RC 0. T 0/0 I. Knit 22 rows, knitting last row at T 8/4 and BOLT.

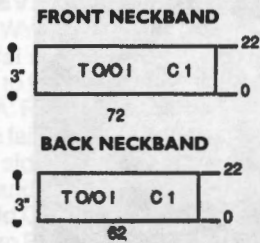

BACK NECKBAND:

With Col. 1 CO 62 sts. for K1/P1 Rib. After selvedge, RC 0. T 0/0 I. Knit 22 rows, knitting last row at T 8/4 and BOLT.

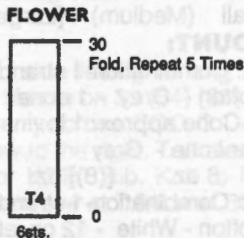

FLOWERS: Make 62.

- C1 10
- C2 7
- C3 4
- C4 2
- C5 6
- C6 2
- C7 10
- C8 4
- C9 2
- C10 6
- C11 7
- C12 2

With WY CO 6 sts. After several rows, end with 1 row Ravel Cord to the right. RC 0. T 4. *Knit 30 Rs. Pick up first row and hang on these ndls. Repeat from * 5 times and BOLT.

FINISHING:

Close neckband seams. Join flowers with sewing needle following Color Chart and attach to neckband.

COLOR CHART FOR #179 FLOWER VEST

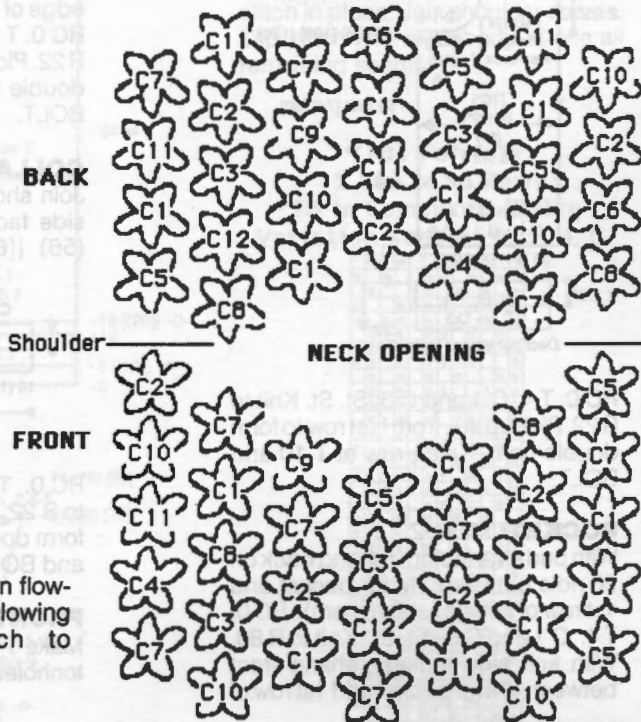

180



BOYS FAIRISLE JACKET

YARN: Mirage and Rayon Nubs

SIZES:

- 4 (6) [8] (10)

AMOUNT:

- C 1: Mirage - Wedgewood 1 lb. all sizes
- C 2: Mirage - Navy 12 oz. all sizes
- C 3: Rayon Nubs - Green/Blue 4 oz. all sizes

KIT PRICE: \$34.00

TENSION:

Fairisle: T 4

GAUGE:

Fairisle: 4.5 Sts., 6.2 Rs. = 1"

NOTIONS:

5 - 3/4" buttons.

Make on Compuknit/Bulky or Punch Card Bulky.

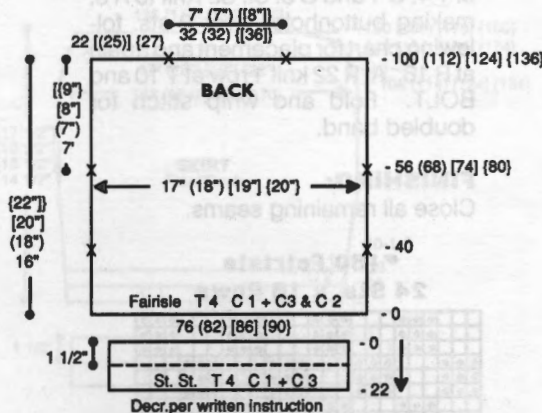

BACK:

With WY CO 76 (82) [86] [90] sts. After several rows end with 1 row Ravel Cord to the right. RC 0. T 4.

With C 1 and C 3 in 'A' Feeder and C 2 in 'B' Feeder knit in fairisle. At R 40 place a YM on each side for pocket. At R 56 (68) [74] [80] place a YM on each side for armhole. At R 100 (112) [124] [136] mark center 32 (32) [[36]] sts. for neckline. Remove neckline and shoulder sts. on separate WY.

BACK HEM:

With purl side facing, rehang lower edge of back doubling every 4th st. RC 0. T 4. C 1 and C 3. St. St. Knit to R 22. Pick up sts. from first row to form double hem. Knit 1 row at T 10 and BOLT.

FRONT: Make 1, Reverse 1.

With WY CO 38 (41) [43] [45] sts. After several rows end with 1 row Ravel Cord to the right. RC 0. T 4. With C 1 and C 3 in 'A' Feeder and C 2 in 'B' Feeder knit in fairisle. At R 40 place a YM on left side for pocket. At R 56 (68) [74] [80] place a YM on left side for armhole. At R 84 (96) [108] [120] shape neckline. On right side BO 10 (10) [[12]] sts. then decr. EOR 1 St. 6x. At R 100 (112) [124] [136] remove shoulder sts. on WY.

FRONT HEM:

With purl side facing, rehang lower edge of front doubling every 4th st.

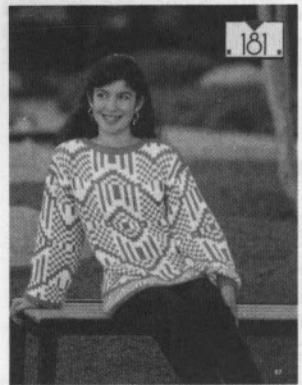

COMPUKNIT/BULKY FAIRISLE PULLOVER

YARN: Softon and Panache
SIZES:

Small (Medium) [Large]

AMOUNT:

C 1: Combination-1 strand each

Softon - Grey - 1 cone

Cone approx. 1 lb.

Panache - Grey

8 oz. [(8)] oz.

C 2: Combination-1 strand each

Softon - White - 12 oz. all

Panache - White

8 oz. [(8)] oz.

C 3: Knit-in elastic - Grey

1 spool all sizes

KIT PRICE: \$55.00

TENSION:

Fairisle: T 5.1

GAUGE:

Fairisle: 4.7 Sts., 5.26 Rs. = 1"

Make on Compuknit/Bulky with Ribber.

Note: Pattern for fairisle is #28 in Compuknit/Bulky Pattern Book. Use variation keys #1 (reverse), #2 (mirror image), #3 (double width), #4 (double length) and #5 (upside down).

Special Note: If you want to lengthen body or sleeves, add to the St. St. rows before beginning fairisle pattern. When knitting 2 x 2 ribbing, to insure a nice seam, have 2 sts. on MB on each side.

BACK/FRONT:

With C 1 CO 90 (94) [98] sts. for K2/P2 Rib. After selvedge RC 0. T 1/1. Knit to R 6 [(10)]. Transfer RB sts. to MB. RC 0. T 5.1. With C 1 in 'A' Feeder and C 2 in 'B' Feeder knit in fairisle to R 12. Cut C 2. Knit in St. St. to R 16 [(20)]. RC 0. Add C 2 in 'B' Feeder. Select variation keys # 1, 2, 3 and 4. Knit in fairisle to R 64. Place a

SLEEVE CUFF:

With purl side facing, rehang lower edge of sleeve doubling every 4th st. RC 0. T 4. C 1 and C 3. St. St. Knit to R 22. Pick up sts. from first row to form double hem. Knit 1 row at T 10 and BOLT.

COLLAR:

Join shoulder seams first. With purl side facing rehang neckline on 56 (56) [(60)] ndls. following chart.

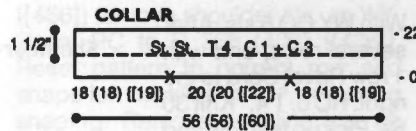

RC 0. T 4. C 1 and C 3. St. St. Knit to R 22. Pick up sts. from first row to form double band. Knit 1 row at T 10 and BOLT.

FRONT PLACKET:

Make 1 w/buttonholes, 1 without buttonholes.

FRONT PLACKET (Make 1 with buttonholes, 1 without)

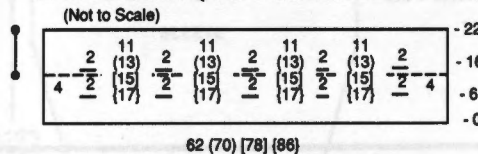

Instruction for 2-stitch buttonhole: At R 6, use a transfer tool and transfer one stitch to the left, the other to the right. Place both empty needles in WP. Knit 1 R. Make an 'e' wrap on those 'empty needles' by twisting the yarn with a transfer tool. Continue knitting and repeat buttonhole instructions on R 16.

With purl side facing rehang left side of front on 62 (70) [78] [86] ndls. RC 0. T 4. C 1 and C 3. St. St. Knit to R 6, making buttonholes over 2 sts. following chart for placement and again at R 16. At R 22 knit 1 row at T 10 and BOLT. Fold and whip stitch for doubled band.

FINISHING:

Close all remaining seams.

***180 Fairisle
24 Sts. x 16 Rows**

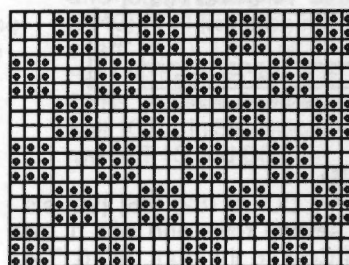

KK Mag Disk: Track 11; Pattern 901

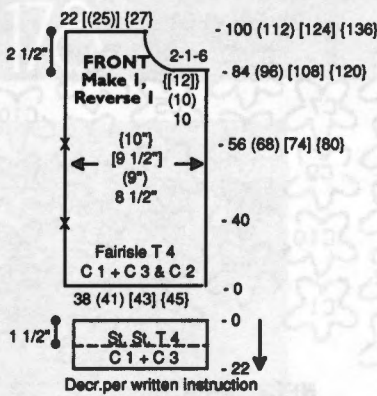

RC 0. T 4. C 1 and C 3. St. St. Knit to R 22. Pick up sts. from first row to form double hem. Knit 1 row at T 10 and BOLT.

POCKET: Make 2.

With purl side facing, rehang back on 26 ndls between YM for pocket and 1st row of fairisle (above hem). RC 0. T 4. C 1 and C 3. St. St. Knit to R 80. With knit side facing, rehang front between YM for pocket and 1st row of

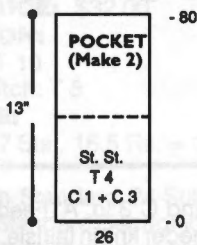

fairisle (above hem) on these ndls. Knit 1 row at T 10 and BOLT.

SLEEVE:

With WY CO 36 (40) [46] [50] sts. After several rows end with 1 row Ravel Cord to the right. RC 0. T 4. With C 1 and C 3 in 'A' Feeder and C 2 in 'B' Feeder knit in fairisle while

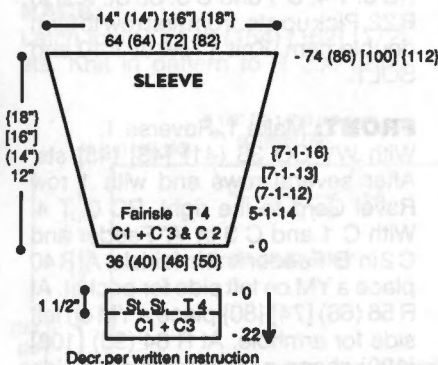

inc. on each side every 5 Rs. 1 St. 14x (every 7 Rs. 1 St. 12x) [every 7 Rs. 1 St. 13x] [every 7 Rs. 1 St. 16x]. At R 74 (86) [100] [112] knit 1 row at T 10 and BOLT.

YM on each side for armhole. After Pattern R 24 select variation key # 5. At R 112 cut C 2. Knit in St. St. to R 116 [(120)] and remove shoulder sts. on WY. RC 0. C 1 + C 3. Working on center 40 [(40)] sts., knit in St. St. while incr. on each side EOR 1 St. 3x. At R 6 [(10)] remove sts. on WY.

SLEEVE:

With WY CO 60 (64) [68] sts. After several rows end with 1 row Ravel Cord to the right. RC 0. T 5.1. With C 1 in 'A' Feeder and C 2 in 'B' Feeder knit in fairisle to R 12 and incr. 1 St. on each side. Cut C 2. Knit in St. St. to R 16 and incr. 1 St. on each side. RC 0. Add C 2 in 'B' Feeder. Advance to Pattern R 7. Select variation keys # 1, 2, 3 and 4. Knit in fairisle while incr. in each side every 6 Rs. 1 St. 9x [(every 7 Rs. 1 St. 9x)]. After Pattern R 24 select variation key # 5. At R 64 (68) [72] shape sleeve cap. On each side BO EOR 6 Sts. 5x. At R 74 (78) [82] BO remaining sts.

CUFF:

With purl side facing rehang lower edge of sleeve on 32 (34) [36] ndls. decr. evenly across. RC 0. C 1 + C 3. Knit 1 row to the right. Transfer EOS to RB for K1/P1 Rib. Knit to R 20, knitting last row at T 9/5 and BOLT.

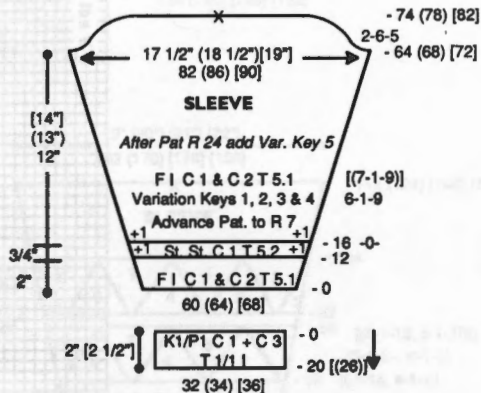
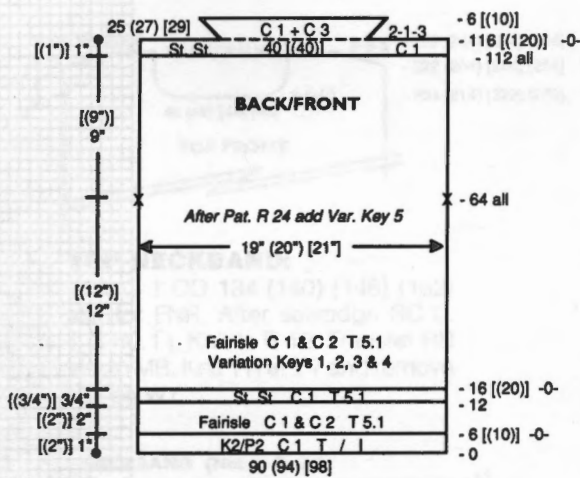

FINISHING:

Turn neck facing to inside and whip stitch in place. Join shoulder seams. Slip stitch sleeve to body. Close all remaining seams.

***181 Fairisle**
12 Sts. x 36 Rows
***28 in Compuknit/Bulky**
Variation Keys 1, 2, 3, 4, 5

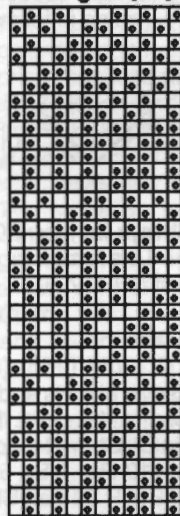

Compuknit III, IV or V:
Built-in Pattern #77

182



JR. TOP WITH MINI SKIRT

YARN: Primo
SIZES:
 Pre-Teen 14 (Jr. Med.)
 [Jr. Lge.] [Jr. X-Lge.]
AMOUNT:
 C 1: Red - 1 1/2 lbs. all sizes
 C 2: White - 8 oz. all sizes
KIT PRICE: \$40.00
TENSION:
 St. St.: T 5
 FNR: T 0.1/0.1 I

GAUGE:

St. St.: 8.35 Sts., 10.35 Rs. = 1"
 Make on any Standard Machine with Ribber.

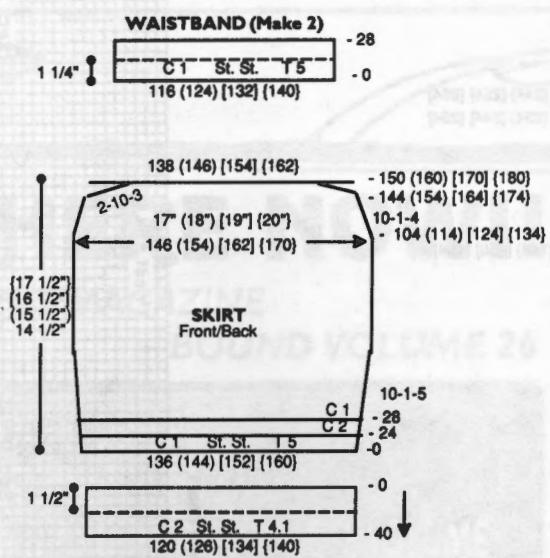

SKIRT FRONT/BACK:

With WY CO 136 (144) [152] [160] sts. After several rows end with 1 row Ravel Cord to the right. RC 0. T 5.

C 1. Knit in St. St. while incr. on each side every 10 Rs. 1 St. 5x. AT THE SAME TIME at R 24 change to C 2. Knit to R 28 and change to C 1. At R 104 (114) [124] [134] shape skirt by decr. on each side every 10 Rs. 1 St. 4x. At R 144 (154) [164] [174] SHR on each side EOR 10 Sts. 3x. At R 150 (160) [170] [180] remove sts. on WY. With the purl side facing rehang lower edge of skirt on 120 (126) [134] [140] ndls. decr. evenly across. RC 0. T 4.1. C 2. St. St. Knit to R 40. Pick up sts. from first row to form double hem. Knit 1 row at T 10 and BOLT.

WAISTBAND:

With purl side facing rehang upper edge of skirt on 116 (124) [132] [140] ndls. decr. evenly across. RC 0. T 5. C 1. Knit 28 Rs. Pick up sts. from first row to form double band and BO.

Pattern Note:

SHR Shapings:
 Follow needle numbers depicted on drawing for beginning each section. If you are working on a section at the edge of the garment and the outer needles are not affected, ignore SHR instructions for that edge. Different sizes will pick up different sections for outer edge.

If shaping triangle sections for SHR decreasing, (going in following direction)



you will always be decr. EOR 1 st. 21 x.

If shaping triangle sections for SHR increasing, (going in following direction)



you will always be incr. EOR 1 st. 20 x and have 1 sts remaining on needle bed for last SHR.

TOP BACK:

With WY CO 158 (166) [174] [182] sts. After several rows end with 1 row Ravel Cord to the right. RC 0. T 5. C 1. Knit in St. St. while incr. on each side every 10 Rs. 1 St. 5x. AT THE SAME TIME at R 30 start SHR intarsia sections. Follow chart for Sections 1 through 9. Knit sections 3, 5, 7, 9 in C2 and sections 1, 2, 4, 6, 8 in C1. *Section 1:* Place all needles in HP except for Section 1, starting at needle #65 to the right of -0-. (See drawing). Decr. SHR EOR 1 St. 21 x. *Section 2:* Place all needles in HP except for Section 2 as shown on drawing. SHR on each side EOR 1 st. 21x. *Section 3:* Place all needles in HP except 1 st. (needle #65) as shown on drawing. Incr. SHREOR on each side 1 st. 20x.

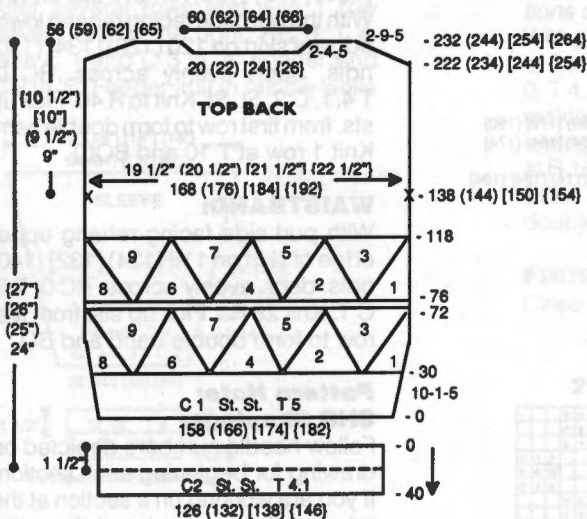

Repeat for Sections 4-9. After completing SHR sections, RC should be at 72. Knit 4 Rs with C 2. At R 76 begin SHR sections repeating Sections 1-9. with Section 1, 2, 4, 6, 8 in

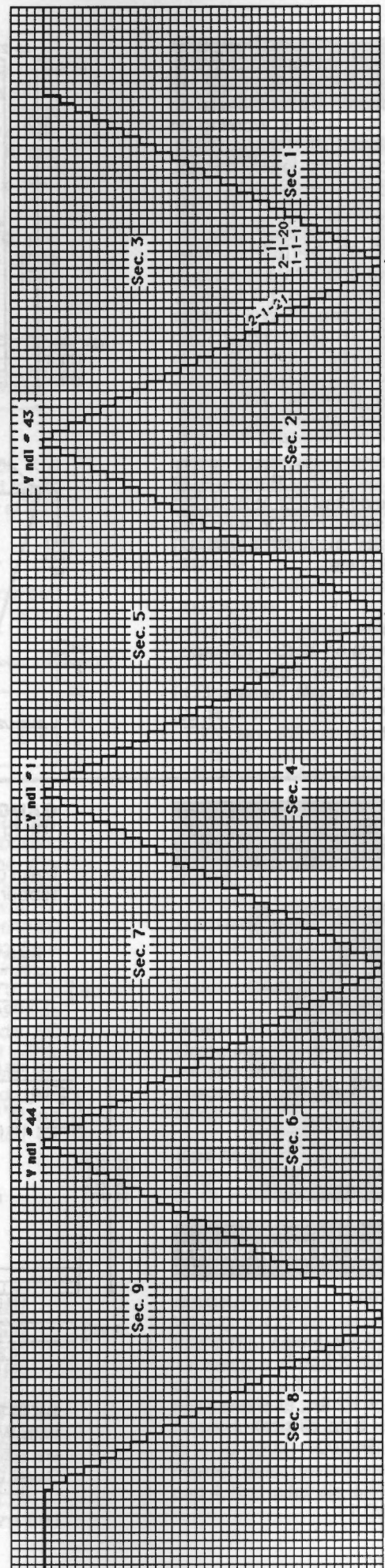

182 Short Row Intarsia Chart

C2 and Sections 3, 5, 7, 9 in C1. At end of SHR, RC 118. C 1. Knit to R 138 (144) [150] [154] and mark each side with YM for armhole. At R 222 (234) [244] [254] begin SHR shoulder shaping and neckline shap- ing. Place center 20 (22) [24] {26} Sts. in HP and all sts. to the left. *On neckline edge SHR EOR 4 Sts. 5x. AT THE SAME TIME SHR shoulder EOR 9 Sts. 5x. At R 232 (244) [254] {264} remove shoulder sts. on WY. Reset RC to R 222 (234) [244] {254} and shape neckline and shoulder from *, reversing shapings. Remove shoulder and neckline sts. on separate WY. **Hem:** With the purl side facing rehang lower edge of back on 126 (132) [138] [146] ndls. decr. evenly across. RC 0. T 4.1. C 2. St. St. Knit to R 40. Pick up sts. from first row to form double hem. Knit 1 row at T 10 and BOLT.

TOP FRONT:

Knit front same as back to R 204 (214) [222] [230]. Shape neckline. BO center 40 (42) [44] {46} sts. Place all sts. to the left in HP. *On neckline edge decr. EOR 1 St. 10x. At R 222 (234) [244] {254} SHR shoulder EOR 9 Sts. 5x. At R 232 (244) [254] {264} remove shoulder sts. on WY. Reset RC to R 204 (214) [222] [230] and shape neckline and shoulder from *, reversing shapings. Remove shoulder sts. on WY. With the purl side facing rehang lower edge of front on 126 (132) [138] [146] ndls. decr. evenly across. RC 0. T 4.1. C 2. St. St. Knit to R 40. Pick up sts. from first row to form double hem. Knit 1 row at T 10 and BOLT.

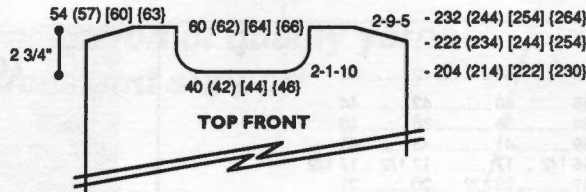

TOP NECKBAND:

With C 1 CO 134 (140) [146] [152] sts. for FNR. After selvedge RC 0. T 0.1/0.1 I. Knit to R 12. Transfer RB sts. to MB. Knit 1 R at T 7 and remove sts. on WY.

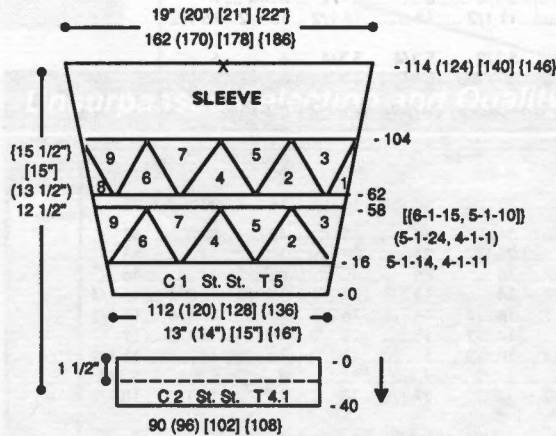
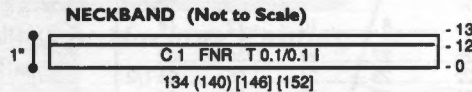

SLEEVE:

With WY CO 112 (120) [128] [136] sts. After several rows end with 1 row Ravel Cord to the right. RC 0. T 5. C 1. Knit in St. St. while incr. on each side every 5 Rs. 1 St. 14x and every 4 Rs. 1 St. 11x (every 5 Rs. 1 St. 24x and every 4 Rs. 1 St. 1x) {every 6 Rs. 1 St. 15x and every 5 Rs. 1 St. 10x}. AT THE SAME TIME at R 16 start SHR intarsia sections. Follow SHR cart same as back, following needle placement for sections from center of machine towards edges, picking up the appropriate sections and colors for size being knitted. End first section of SHR at R 58. With C2 knit 4 Rs St. St. At R 62 begin second set of SHR sections, reversing colors for Sections 1-9, same as front/back. End SHR section at R 104. Change to C1. Knit to R 114 (124) [140] [146]. Mark center with YM and remove sts. on WY. **Cuff:** With the purl side facing rehang lower edge of sleeve on 90 (96) [102] [108] ndls. decr. evenly across. RC 0. T 4.1. C 2. St. St. Knit to R 40. Pick up sts. from first row to form double hem. Knit 1 row at T 10 and BOLT.

FINISHING:

Close shoulder seams and attach neckband. Attach sleeves. Close all remaining seams.

IT'S HERE NOW!!

KNITTING MAGAZINE

BOUND VOLUME 26

- HARD BOARD COVER
- COMPLETE INSTRUCTIONS
- WILL HOLD ANOTHER COMPLETE VOLUME



PRICE: \$27.95
+ Ship/Hndlg: \$4.00



Knitkng Sizing Chart

MENS

Size	34	36	38	40	42	44
Chest	34	36	38	40	42	44
Waist	30	32	34	36	38	40
Hip	35	37	39	41	43	45
Neck	15 1/2	16	16 1/2	17	17 1/2	17 1/2
Back Waist Length	18	18 1/2	19	19 1/2	20	21
Shoulder to Shoulder	15 1/2	16	16 1/2	17	17 1/2	18
Upper Arm Circumference	9 5/8	10 3/8	11 1/8	11 7/8	12 5/8	13 3/8
Armhole Depth	6	6 1/2	9	9 1/2	10	10 1/2
Sleeve Length	19	19 1/2	19 1/2	20	20	20 1/2
Under Arm						
Wrist	6 1/2	7	7	7	7 1/2	8
Hip Depth	8 3/8	8 1/2	8 5/8	8 3/4	8 3/4	9

These are actual body sizes. Proper ease allowance is necessary as determined by the style.

CHILDREN

Size	12 mo	2 yr	4	6	8	10	12	14
Chest	19	21	23	25	27	28	30	32
Waist	19	20	21	22	23	24	25	26 1/2
Hip	20	22	24	26	28	30	32	34
Neck	9 1/4	10	10 3/4	11 1/2	12 1/8	12 5/8	13 1/8	13 5/8
Back Waist Length	7	8 1/2	9 1/2	10 1/2	12	12 3/4	13 1/2	14 1/4
Shoulder to Shoulder	7 1/2	8 1/2	9 1/2	10	11	11 1/2	12	12 1/4
Upper Arm Circumference	7	7 1/2	8	8 1/2	9	9 1/2	10	10 1/2
Armhole Depth	3 1/2	4	4 1/2	5 1/4	6	6 1/2	6 3/4	7
Sleeve Length	6	8 1/2	10	11 1/2	13	14 1/2	15 1/2	16 1/2
Under Arm								
Wrist	5	5 1/4	5 1/2	5 1/2	5 3/4	5 3/4	6	6
Hip Depth	5	5 1/4	5 1/2	5 1/2	5 3/4	6 1/4	6 3/4	7

These are actual body sizes. Proper ease allowance is necessary as determined by the style.

WOMENS

Size	6	8	10	12	14	16	18	20	22
Bust	30 1/2	31 1/2	32 1/2	34	36	38	40	42	44
Waist	22	23	24	25 1/2	27	29	31	34	36
Hip	32 1/2	33 1/2	34 1/2	36	38	40	42	44	46
Neck	13 1/8	13 3/8	13 5/8	14	14 3/8	14 3/4	15 1/4	15 3/4	16 1/4
Back Waist Length	15 1/2	15 3/4	16	16 1/4	16 1/2	16 3/4	17	17 1/4	17 1/2
Shoulder to Shoulder	13 1/2	13 1/2	14	14 1/2	15	15 1/2	16	16 1/2	17
Upper Arm Circumference	9 3/4	9 3/4	10 1/4	10 1/2	11	11 1/2	12	13	13 1/2
Armhole Depth	7	7	7 1/2	7 1/2	7 1/2	8	8	8 1/4	8 1/4
Sleeve Length	16 1/2	16 1/2	17 1/2	17 1/2	17 1/2	18	18	18 1/2	18 1/2
Under Arm									
Wrist	6	6	6 1/4	6 1/4	6 1/2	6 1/2	6 1/2	7	7
Hip Depth	7 3/4	8	8 1/4	8 1/2	8 3/4	9	9 1/4	9 1/2	9 3/4

These are actual body sizes. Proper ease allowance is necessary as determined by the style.

IS YOUR ADDRESS CHANGING?

If so, you can insure the proper handling of this change by following the three suggestions below:

- 1) When advising us of your new address, please also indicate your old address.
- 2) Please provide us with six weeks notice to affect this change.
- 3) PLEASE PRINT ALL INFORMATION LEGIBLY.



The finest quality KNITKING yarns are used to create the beautiful fashions found in KNITKING Magazine. Photographic representations may not accurately reflect the true color of the yarn due to lighting and printing processes. Please refer to your Knitkng Yarn Color Book for actual colors. Kit prices are located with the instructions for each garment. Each yarn comes in a wide selection of colors. The different types of yarns have been selected to allow for blending, mixing, and contrasting—both color and texture.

Yarn Color Book is available through KNITKING or an authorized Knitkng dealer. Content and approximate yardage of each yarn is included in

	<u>Yds./Pound</u>		<u>Yds./Pound</u>		
Alpine	100% Wool	1600	Pearlyte	100% Rayon Boucle	2200
Angora	100% Rabbit Hair (10 gr. ball)	33 yds/ball	Pebble	Boucle Cotton/Acrylic/Rayon	700
Acrylite	2/12 Acrylic	2400	Primo	100% Mercerized Cotton	2500
Caprinae	78% Mohair/13% Wool/9% Nylon	980	Rayon Nubs	100% Rayon Nub Filler Yarn	5500
Glance	100% Slinky Bright Rayon	2400	Roma	80% Acrilan/20% Antron	2600
Glance Plus	100% Slinky Bright Rayon	1650	Rubane (50 gr ball)	100% Polyamid 1/8" ribbon	82/ball
Ice Cream	54% Cotton/46% Rayon	2100	Silkie	2-Ply Orlon	2100
Lumiarn	Thin Metallic Yarn (50 gr. cone)	1200/cone	Softon	100% Soft Cotton	2000
Mini Acrylite	2/24 Weight 100% Acrylic	3600	Sorbet	54% Cotton/46% Rayon	2200
Mini Pebble	100% Rayon Slub Filler Yarn	3350	Starlite	Acrylic w/Metallic Thread	2400
Mirage	100% 4-Ply Worsted Acrylic	1000	Venetia	70% Wool/30% Rayon	2400
Night Music	Polyester Thread w/Metallic Twist	115/ball	Woolana	100% 2/12 Merino Wool	3000
Panache	100% 3-ply Acrylic	2400	Knit-in Elastic	79% Nylon/21% Elastic	430/spool

Yarn Color Book: \$25.00 + Shipping and Handling

Order your Knitkng kits in the color of your choice from Knitkng color cards. Kit and yarn prices subject to change without notice.

**Announcing the finest selection of quality yarns—
with simply the best prices and support
available anywhere...**



**yarns by
knitking**
The First Name in Machine Knitting



**Exciting New Knitking Yarn Book—Only \$25.00
The perfect way to select your yarns and colors**

Unsurpassed Selection and Quality

With over 25 different yarns and over 250 different colors in the Knitking line, you have a variety to choose from for any and all needs. The yarns include a wide selection of natural fibers and blends, along with acrylics and acrylic blends in varying weights. There are fine filler yarns for blending, elastic for knitting in and a wide array of colors and textures in all types.



Unsurpassed Support



No yarn company in the world can match Knitking's support for its customers. For 25 years, Knitking has published the internationally-acclaimed **Knitking Magazine**. Each quarterly full-color issue contains at least 20 original fashions *made exclusively with Knitking Yarns*, complete with clear instructions for machine knitting.

And At Prices Well Below The Competition

Order the exciting Knitking Yarn Book today for only \$25.00 from your local Knitking Dealer, or if you do not have one in your area, from:



1128 Crenshaw Blvd., Los Angeles, CA 90019 • Phone (213) 938-2077

174



175



176.



177



178

179



180



181



189



Punch Card Programmed Bulky

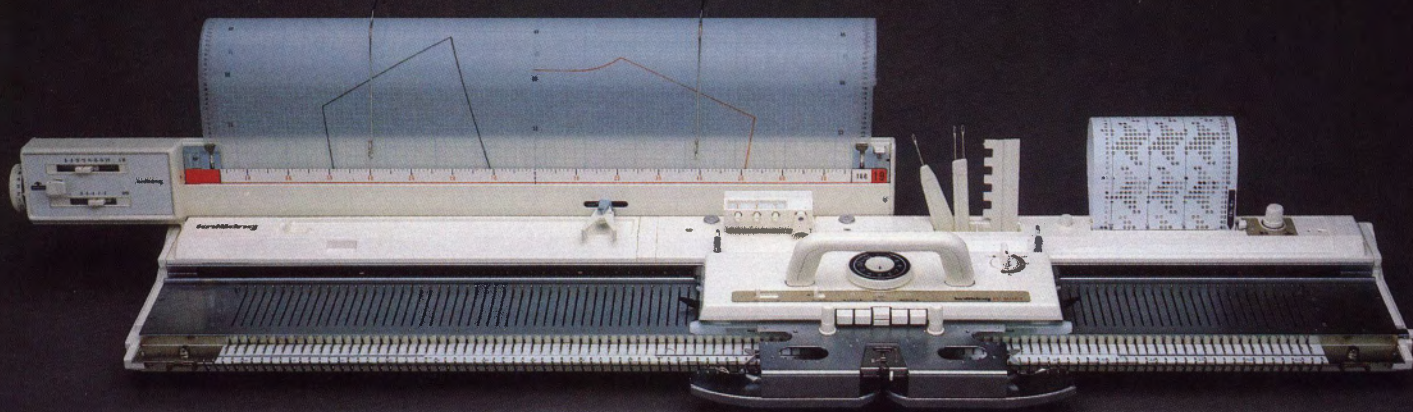

The **Knitking PC Bulky** is easily the most versatile of all Bulky knitting machines. It offers **Knitking's** exclusive **Automatic 24 Stitch Repeat Punch Card Pattern Selection** and **Single Motif Isolation** capabilities. It knits a range of yarns from sport weight to jumbo, including Angora, Mohair, Boucle, Ribbon, Cotton, Acrylic, etc.; with 114 stainless steel needles you can knit up to 38" wide, at 3 stitches per inch. The Tension Control Dial has 30 tension positions for knitting different weights of yarn.

The **PC Bulky** comes complete with **Twin Overhead Yarn Feeders**, **15 Pre-Punched Cards** (you can also make your own pattern stitch cards), **Row Counter**, complete **Tool Kit**, **Stitch Measure Scales for Knitleader**, **Carrying Case**, a detailed, well illustrated, easy-to-understand **Instruction Manual** and a one year warranty on parts and service.

The **Knitleader** is a charting accessory that fits on the back of the knitter. You draw, or trace a garment, full-size, on the furnished Mylar sheet. The chart rotates as you knit, and shows you, on a row-by-row basis, exactly where to increase and decrease stitches.

knitking

Where Savings And Value
Are Always In Fashion

1128 Crenshaw Blvd., Los Angeles, CA 90019 213-938-2077

When It Comes to Standard Bed Machines . . . We've Got the Right One For You

Standard Needle Machines

Built-in knitting patterns and stitches include Fair Isle, Tuck, Skip—even Single Motif Isolation, Weaving, Thread Lace and Plating. Capability of using Knitking's exclusive Garter Carriage accessory. Standard gauge machines can handle a wide selection of yarns ranging from fine to sport weight, to produce medium to tightly woven sweaters, skirts, dresses and other garments.

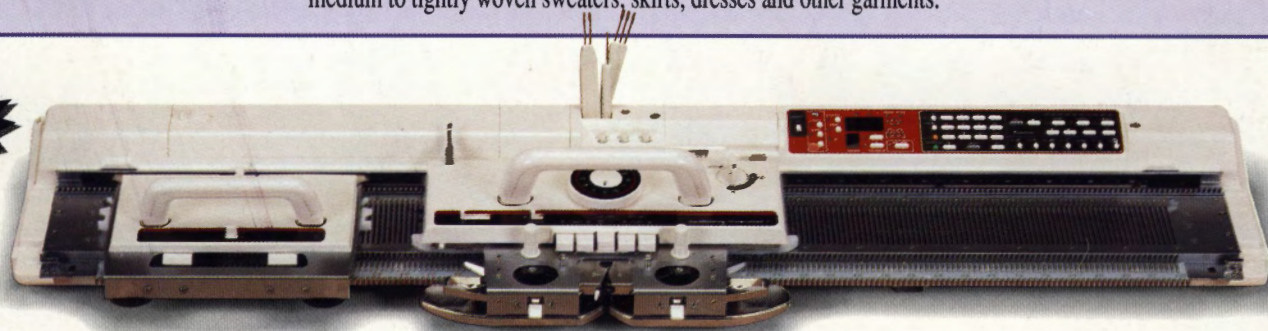

Now Only
\$1749.95

Compuknit V

Our most popular machine, this computerized model includes 615 patterns already stored in the machine's memory, plus the ability to create your original designs with the push of a few buttons. You can even "frame" any portion of a design to use in knitting, and can select from 1 to 9 different designs to be placed together to create a motif, repeating in the order of your choice.

Patterns can be as large as 200 stitches wide and 998 stitches long. Variation buttons allow you to quickly customize any design for reversing, rotating, reflecting, doubling length or width (or both), turning patterns upside down, changing foreground and background colors, plus automatic double jacquard. And, 3-color knitting is now even easier than ever before!

Exclusive accessories include the Pattern Design Computer, Disk Drive, Printer and DesignaKnit Complete Software System for Knitting Machines.

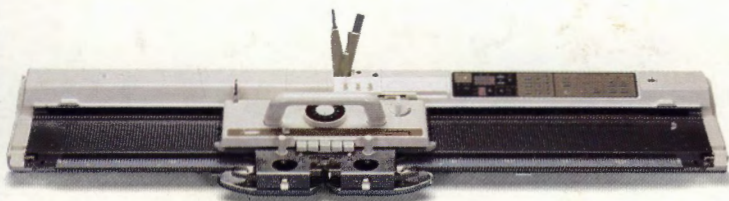

Compuknit/ST

Our most economical computerized knitter, the Compuknit/ST still offers many of the same desirable features of its big sister, the Compuknit V. Includes 50 built-in patterns, plus enough memory for the user to input her own designs—patterns ranging from 1 to 24 stitches wide and over 1000 rows long, up to a total of 26,000 stitches. Variation buttons allow any of the patterns to be reversed, turned upside down, doubled in length or have their yarn colors reversed. Intarsia and Lace Carriages are optional.

Exclusive accessories include the Pattern Design Computer, Disk Drive and Printer.

Save \$400
\$899.95

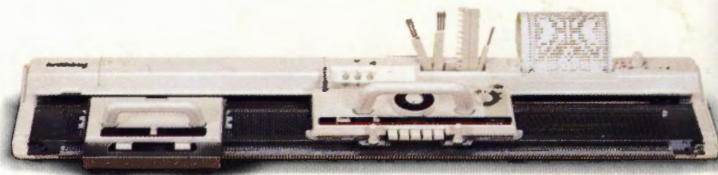

Auto KK 98

This versatile machine features punch card technology for automatic pattern knitting. Capable of repeating patterns of up to 24 stitches, with the variation of double length available at the flip of a switch. Includes Lace Carriage allowing you to create beautiful normal and fine lace garments. Intarsia Carriage optional. Most affordable standard needle machine.

Best Buy
\$699.95

 **knitking**
The First Name in Machine Knitting

Visit your local Knitking Dealer or contact Knitking for more information

1128 Crenshaw Blvd. • Los Angeles, California 90019 • (213) 938-2077