

knitking

magazine

JAN/FEB.'76





DK 237

A woman with dark, curly hair and dramatic eye makeup is shown from the chest up. She is wearing a dark fur coat with a thick collar and a sequined, long-sleeved top. She is holding a pair of round sunglasses in her right hand. The background is a solid brown color. The entire image is framed by a decorative white border with floral motifs in the corners.

DK 249

DK 250



HP 258

DK 246



DK 238

HP 259



DK 239



DK 241



DK 243

DK 242



DK 256

DK 257



DK 255

knitking

magazine

editorial

TABLE OF CONTENTS

PAGE NO.

DK 237	Woman's Jacket & Skirt . . .	14
DK 238	Woman's Blouse	15
DK 239	Woman's Cardigan	16
DK 240	Woman's Pullover and Dickey	18
DK 241	Woman's Cardigan	20
DK 242	Woman's Pullover	21
DK 243	Woman's Long Skirt	22
DK 244	Woman's Jacket	23
DK 245	Shoulder Bag	24
DK 246	Woman's Dress	24
DK 247	Woman's Pullover	26
DK 248	Woman's Skirt & Pullover . .	27
DK 249	Woman's Pullover	28
DK 250	Woman's Skirt	29
DK 251	Woman's Pullover	30
DK 252	Woman's Pullover	31
DK 253	Woman's Pullover and Gaucho Pants	32
DK 254	Woman's Pullover	34
DK 255	Woman's Cape	35
DK 256	Woman's 2-piece Suit	37
DK 257	Woman's Sleeveless Pullover.	40
HP 258	Man's Jacket	38
HP 259	Man's Pullover	41
KK 260	Boy's Pullover	42
KK 261	Girl's Cardigan	43
KK 262	Boy's Jacket	45
KK 263	Child's Poncho	46
KK 264	Child's Jacket	47
KK 265	Child's Overall & Pullover .	48
RS 266	Afghan	51

Regular readers of KNITKING MAGAZINE will have noticed that we have some new names in the range of yarns used in the knitting of garments for this and the previous two issues... We are, in fact, preparing a completely new Catalogue with samples of the most beautiful range of yarns you will find anywhere... It takes specialized equipment to cut and insert actual samples in Catalogues and because we have never found a company in the U.S. that does this work, we have KNITKING Yarn Catalogues produced in Europe... The process is a lengthy one and we are somewhat at the mercy of the manufacturer in regard to delivery dates... We are, however, taking delivery of, and using, our new yarns, so if you would like to be among the first to test their superb quality and wearability, you must take advantage of the special Sale prices listed in KNITKING NEWS of this issue.





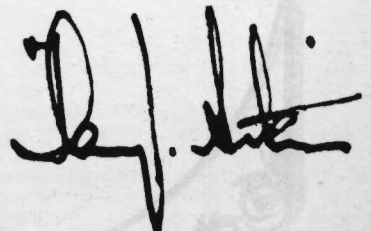











Only KNITKING MAGAZINE subscribers are eligible for the BIG DISCOUNTS and it is our way of saying 'Thank you' for supporting us through the many problems we had in 1975... 1976 is a whole new ball game and we enter it with the explosion of color that is this handsome issue... plus a determination to provide only the best in machines, yarns, patterns and services to our customers... You can depend on KNITKING to supply only the best and at the lowest possible prices.

We have another splendid issue coming up for MARCH/APRIL with a fine assortment of garments for the entire family... We are including, in response to many requests, some cute outfits for cute Bi-Centennial babies....























Pattern Symbols

Knitting - Chart Symbols

- () Size Symbols (2nd Size)
 < > 3rd Size
- B** Beginners Pattern
T Tension
G Gauge
① Color Number
-  Cast on
 Stitch
 Row
 Hem
 Bind off
-  Stockinette stitch - worn on the Knit side.
 Stockinette stitch - worn on the Purl side.
 Knit 1, Purl 1 Ribbing
 Ribbing Pattern - worn on the Knit side.
 Ribbing Pattern - worn on the Purl side.
-  Closed Dart
 Open Dart
 Put on a stitch holder
 Reverse 1 section
 On every other needle
 Number of Rows between Shapings. Make increase (or decrease) FIRST, then knit 4 rows. For example: 3 x 1  means decrease (or increase) 1 st., knit 4 rows; decrease 1 st., knit 4 rows; decrease 1 st., knit 4 rows; decrease 1 st., knit 4 rows. All decreasing (or increasing) without row numbers as shown must be shaped on every 2nd row.

-  Increase
 Increase 2 sts. With a transfer tool, move the sts. over the left (or right) leaving 2 empty needles at the point of increase. At the increase point, move 1 st. to the left, (or right) so that there is an empty needles on each side of a stitch. On each side of the center stitch, pick up a stitch from the row below and hang it onto the empty needle.
-  3 stitches on 1 needle. The 1st and 3rd stitch in a group of 3 has been hung on the 2nd or center needle.
 Short Row increase or decrease; for instance on a flared skirt knitted sideways.
 Pattern Stitch
 Pattern Stitch - worn on the Knit side.
 Pattern Stitch - worn on the Purl side.
 Norwegian Design using the Pattern Reader. Only 1 row must be registered on the Pattern Reader, so when knitting two or more colors in 1 row, knit the first color with the LEVER of Pattern Reader UP (working), then push the LEVER DOWN (non-working) for the additional colors.
 REPEAT the above for each complete row.
-  Repeat
- I = Front
 II = Back
 III = Sleeve
 IV = Skirt Front
 V = Skirt Back
 VI = Collar
 VII = Pocket
 VIII = Band
 IX = Belt
 X = Cuff
 XI = Pants Front
 XII = Pants Back

Finishing - Chart Symbols

-  Match numbers on section for assembling.
 Ease
 Fold Line
 Turn to the wrong side and hem.
- ### Stitch Symbols
-  Knit Stitch
 Purl Stitch
 Needles in holding position
 Needles back into working position.
 Empty needle (leave in working position)
 Needle not used (in the out of work position).
 Two stitches on 1 needle, either transferred from the right side or the left side, then put into holding position.
 Needle holding 2 stitches. Stitch has been transferred from the RIGHT.
 Needle holding 2 stitches. Stitch has been transferred from the LEFT.
 Center of garment section
 Pattern Reader
 JAC 40
 Adjustable Needle Selector
 Pattern Wheel
 Weaver
 Needle Shifter

DK 255

knitking

Accessory Price List

	PRICE	SHIPPING		PRICE	SHIPPING
WHIZ KING PATTERN READER - complete with Converta Tape & 2 sheets of graph transparent plastic	\$79.50	\$2.75	Reversing Bar (197 Needle KNITKING Machine only)	39.95	2.00
3-Color Yarn Feeder	29.50	1.65	Converta Tape (for charting Patterns to size)	10.95	.65
Pattern Stitch Cards for AM 3 KNITKING Machine only #17 to #48	10.50	1.40	Fluorescent Magnifying Lamp with 5 inch lens and adjustable 45 inch extension arm (specify table clamp or wall fitting)	69.50	3.50
Weaving Accessory for AM 3 KNITKING only	8.95	.85	Lumaglo Lamp	24.95	1.75
Adjustable Needle Selector (33-needle)	4.95	.60	JAC 40 (KNITKING Machine only) . . .	37.50	1.75
Cam Wheels for AM 3 KNITKING Machine only each	1.75	.15	JAC 40 Punch Cards. Please give alternate numberseach	1.50	.15
Knitting Table (suitable for all machines)	39.50	F.O.B	JAC 40 Punching Accessory with 5 blank cards	24.95	1.25
Treble Transfer Tool (pair)	3.50	.55	Blank Cardseach	1.00	.15
Multiple Transfer Tool (33 needle). .	4.50	.65	Strap for JAC 40	2.00	.30
Double Transfer Tool (pair)	2.50	.55	KNITKING Instruction Book (specify machine)	4.00	.55
Transfer Tools (1 each - 4 needle and 6 needle)	3.25	.55	KNITKING AM 3 Book - complete with Home Study Course	12.95	.65
Combined Latch Needle & Transfer Tool	1.50	.30	Inches/Centimeters Tape Measure49	.20
Combined Work Hook & Transfer Tool	1.50	.30	1 Year Subscription to KNITKING MAGAZINE (6 issues)	10.00	(no tax)
Knitting Machine Needles for KNITKING Machines only55	.15	Canada	12.00	
Ribbing Attachment Needles for KNITKING Ribbers only65	.15	Back Issues of KNITKING MAGAZINE		
Ribber Transfer Needles45	.15	Single Copy (thru Vol.10) . . .each	1.50	Postpaid
Strippers for KNITKING Ribber (pair). .	.95	.25	From Vol 11 No. 1each	3.00	Postpaid
KNITKING Sinker & Spring (specify Machine No.)25	.15	KNITKING MAGAZINE		
Shipping for 2050	Plastic bound Volumes (6 issues)		
Yarn Winder with 'Waxamajig' and Skein Holder	27.50	2.00	Bound Volumes 9 or 10each	7.95	1.25
Wax Spools each	.30	.25	Bound Volume 11each	11.95	1.50
or 4 for	1.00	.50	Carrying Bags		
			AM 3 Knitter	45.95	2.00
			P 3 Ribber	24.00	1.25

Sorry, no C.O.D's or Billings. Please send money with your order. California Residents, add Sales Tax. Effective January 1, 1976. Price Lists prior to this date are obsolete.

KNITKING, INC.
1128 Crenshaw Blvd., Los Angeles, California 90019

DK 237

WOMAN'S JACKET & SKIRT

SIZE: 8/10 (12/14) [16]
 YARN: Combinella Fina
 GRAMS: 1200 1250 1300
 TENSION: 7 to 9
 GAUGE: 14 sts. 19 rows = 5 cm (2")



Both Jacket & skirt are knitted sideways on the machine with the Purl side the right side.

FINISHING: See General Instructions. SKIRT: Weave the open sts. together then remove the waste yarn. JACKET: Sew 1 edge of Cuffs to inside and 1 to outside of sleeve edge, easing to fit.

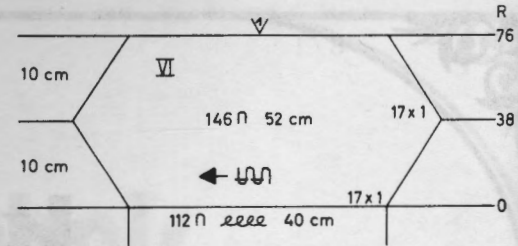

COLLAR: VI

Cast on 112 sts. and work Stockinette stitch.
 ON EACH SIDE, cast on 1 st. 17x.
 After Row 38, ON EACH SIDE, bind off 1 st. 17x. After Row 76, bind off the remaining sts.

SLEEVE: III

Cast on 115 sts. and work Stockinette stitch and SHORT ROWS.
 ON OPPOSITE SIDE OF CAM BOX, put 114 sts. into holding position, knit 2 rows. ON THE RIGHT, cast on 5 (5) [6] sts. and ON OPPOSITE SIDE OF CAM BOX, bring back into working position
 12 sts. 1x, 9 sts. 9x, 21 sts. 1x, AND AT THE SAME TIME, on every 2nd row, cast on 3 sts. 2x, 2 sts. 3x, 1 st. 17x (19x) [21x].
 Knit to Row 76 (80) [84].
 ON CAM BOX SIDE, bind off 1 st. 17x (19x) [21x], 2 sts. 3x, 3 sts. 2x, 5 (5) [6] sts. 1x and AT THE SAME TIME, after Row 100 (108) [116], ON OPPOSITE SIDE OF CAM BOX, put into holding position 21 sts. 1x, 9 sts. 9x, 12 sts. 1x.
 After Row 122 (130) [138], bring all the needles into working position and bind off loosely.

8/10

(12/14)

[16]

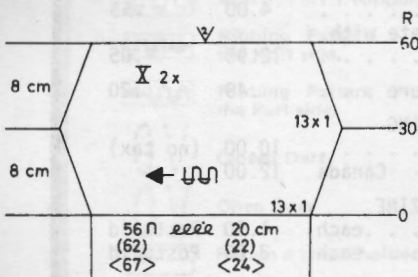
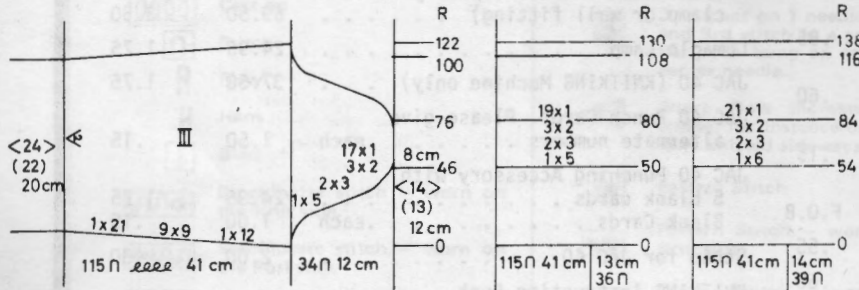

CUFFS: X Make 2.

Cast on 56 (62) [67] sts. and work Stockinette stitch.
 ON EACH SIDE, cast on 1 st. 13x.
 After Row 30, ON EACH SIDE, bind off 1 st. 13x.
 After Row 60, bind off the remaining sts.

8/10

(12/14)

[16]

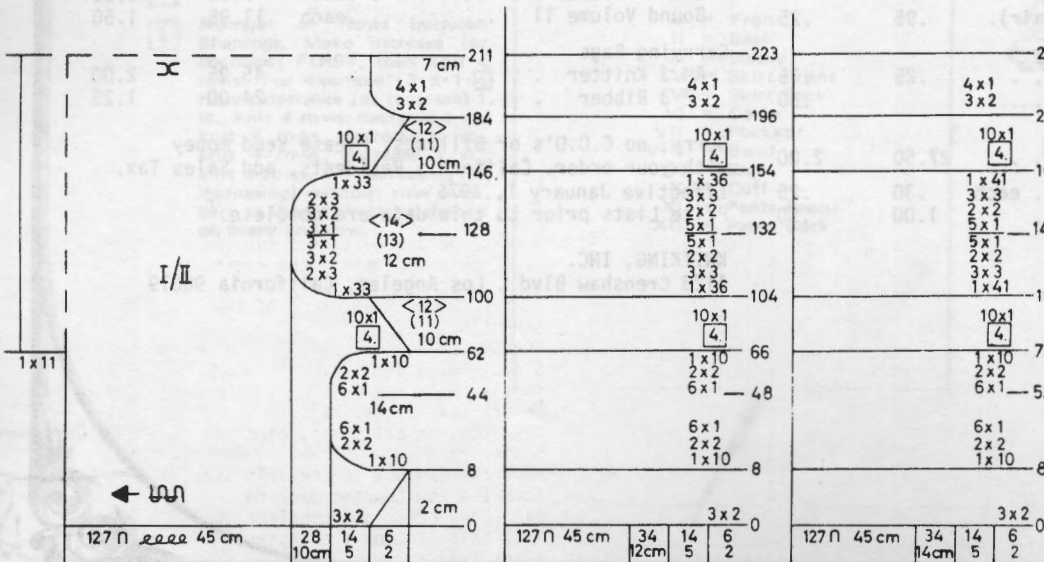

JACKET FRONT & BACK: I/II

Beginning at FRONT EDGE, cast on 169 (175) [180] sts. and work Stockinette stitch.
 ON THE RIGHT side, on every 2nd row, cast on 2 sts. 3x.
 After Row 8, bind off 10 sts. 1x, 2 sts. 2x, 1 st. 6x.
 Knit to Row 44 (48) [52].
 Cast on 1 st. 6x, 2 sts. 2x, 10 sts. 1x.
 After Row 62, (66) [70], with a separate yarn, cast on 11 sts. on the LEFT side and ON THE RIGHT side, bind off 1 st. every 4th row 10x.
 After Row 100 (104) [108], bind off 33 (36) [41] sts., then bind off 3 sts. 2x (3x) [3x], 2 sts. 3x (2x) [2x], 1 st. 3x (5x) [5x].
 Knit to Row 128 (132) [140].
 Cast on 1 st. 3x (5x) [5x], 2 sts. 3x (2x) [2x], 3 sts. 2x (3x) [3x], 33 (36) [41] sts. 1x.
 After Row 146 (154) [162], cast on 1 st. every 4th row 10x.
 After Row 184 (196) [208], bind off 2 sts. 3x, 1 st. 4x.
 Knit to Row 211 (223) [235]
 THIS IS THE CENTER BACK OF JACKET and you must now WORK BACKWARDS. Begin by knitting 15 rows, then cast on 1 st. 4x, 2 sts. 3x, etc. It will be easier for you to follow the Chart.

8/10

(12/14)

[16]

SKIRT: V

With contrast waste yarn, cast on 197 sts. and work Stockinette stitch with SHORT ROWS.
 *Knit to Row 12 (14) [16].
 ON OPPOSITE SIDE OF CAM BOX, put into holding position 165 (168) [169] sts.
 ON OPPOSITE SIDE OF CAM BOX, bring back into working position, 15 (14) [13] sts. 11x (12x) [13x].
 ON OPPOSITE SIDE OF CAM BOX, put into holding position 15 (14) [13] sts. 11x (12x) [13x].
 Bring all the needles back into working position and knit to Row 70 (78) [86].*
 Turn the Row Counter to 0 and REPEAT from * to * 9x more.
 Remove the sts. onto contrast waste yarn.

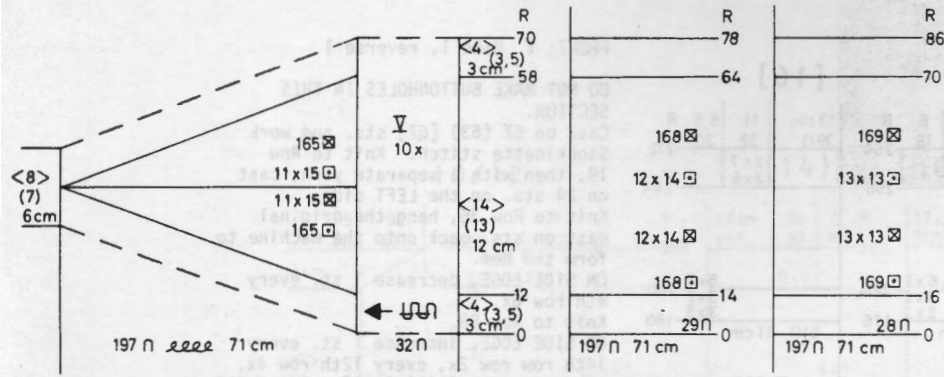

DK 238



WOMAN'S BLOUSE
 SIZE: 12 (14) [16]
 YARN: Beatrice
 GRAMS: 400 450 500
 TENSION: 5 to 7
 GAUGE: 15 sts. 21 rows = 5 cm (2")
 Stockinette stitch worn on the Purl side.

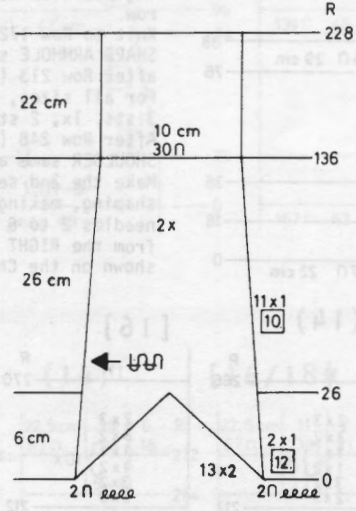

TIE: Make 2.
 Leave 26 empty needles on the LEFT SIDE of 0 and cast on 2 sts. ON EVERY 2nd ROW, on the RIGHT (left for 2nd half), cast on 2 sts. 13x and AT THE SAME TIME, on SIDE EDGE, decrease 1 st. every 12th row 2x. After Row 26, put these needles into holding position. Leave 26 empty needles to the right of 0, then cast on 2 sts. ON THE LEFT side, cast on 2 sts. 13x, and ON CAM BOX SIDE, decrease 1 st. every 12th row 2x. After Row 26, bring all the needles into working position. ON EACH SIDE, decrease 1 st. every 10th row 11x. Knit to Row 228. Bind off.

FINISHING: See General Instructions.
 Sew the straight edges of Tie together, fold in half and sew up the ends leaving an opening to fit around neckline. Turn to the right side, pin then sew 1 edge to the outside and 1 to the inside of neck edge.

BACK: II
 Cast on 135 (147) [159] sts. and work Stockinette stitch.
 Knit to Row 36. Hang the hem.
 ON EACH SIDE, decrease 1 st. every 8th row 6x.
 Knit to Row 88.
 ON EACH SIDE, increase 1 st. every 14th row 2x, every 12th row 4x.
 Knit to Row 164.
SHAPE ARMHOLE: ON EACH SIDE, bind off
 3 sts. 2x, 2 sts. 2x, 1 st. 5x. (3 sts. 2x, 2 sts. 3x, 1 st. 6x). [3 sts. 3x, 2 sts. 3x, 1 st. 5x].
 Knit to Row 240 (244) [248]. Bind off the center 21 sts., put the needles on the left into holding position and complete the right half first.
***SHAPE SHOULDER AND NECK AT THE SAME TIME.**
FOR SHOULDER, bind off
 5 sts. 3x, 6 sts. 2x. (6 sts. 5x). [6 sts. 3x, 7 sts. 2x].
FOR NECK, on all sizes, bind off
 5 sts. 3x.
 Move the Cam Box to the left side, turn the Row Counter back to 240 (244) [248] and complete the left half. Follow the instructions from *.

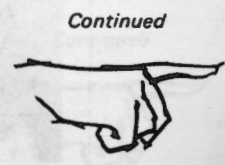
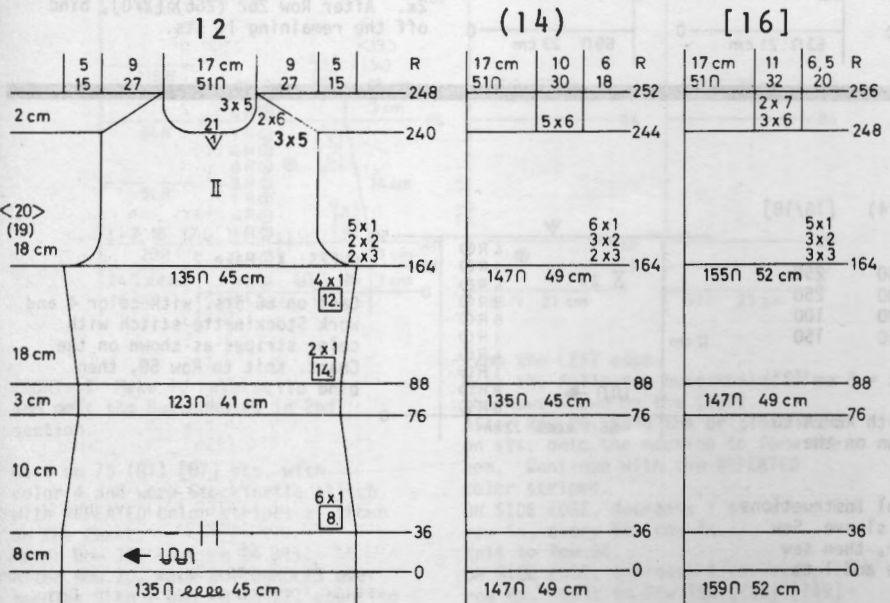

DK 238

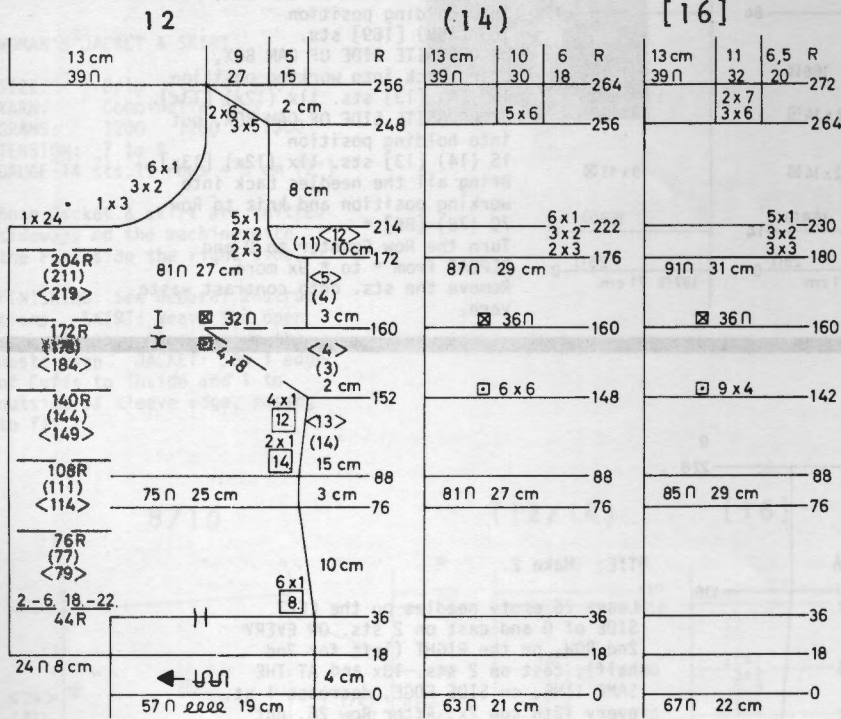

FRONT: I Make 1, reverse 1.

DO NOT MAKE BUTTONHOLES IN THIS SECTION.
 Cast on 57 (63) [67] sts. and work Stockinette stitch. Knit to Row 18, then with a separate yarn, cast on 24 sts. on the LEFT side. Knit to Row 36, hang the original cast on sts. back onto the machine to form the hem.
 ON SIDE EDGE, decrease 1 st. every 8th row 6x.
 Knit to Row 88.
 ON SIDE EDGE, increase 1 st. every 14th row 2x, every 12th row 4x. After Row 151 (147) [141], work SHORT ROWS for the BUST DART. ON OPPOSITE SIDE OF CAM BOX, put into holding position 8 sts. 4x (6 sts. 6x) [4 sts. 9x]. Bring all the needles back into working position before knitting the next row.
 Knit to Row 172 (176) [180].
 SHAPE ARMHOLE same as the back and after Row 213 (221) [229], SHAPE NECK. For all sizes, bind off 24 sts. 1x, 3 sts. 1x, 2 sts. 3x, 1 st. 6x. After Row 248 (256) [264], SHAPE SHOULDER same as the back.
 Make the 2nd section with reverse shaping, making BUTTONHOLES over needles 2 to 6 and 18 to 22 counting from the RIGHT EDGE after the Rows shown on the Chart for YOUR SIZE.

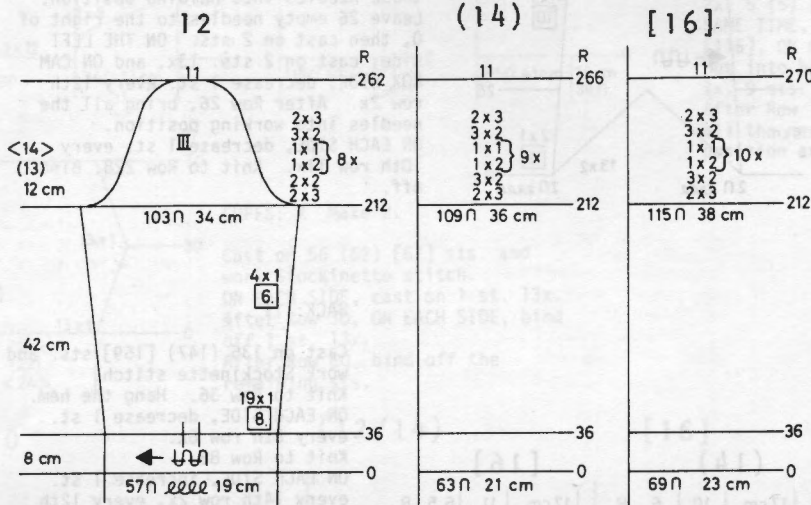

SLEEVE: III

Cast on 57 (63) [69] sts. and work Stockinette stitch. Knit to Row 36, then hang the hem.
 ON EACH SIDE, increase 1 st. every 8th row 19x, every 6th row 4x. Knit to Row 212.
 SHAPE CAP: ON EACH SIDE, bind off 3 sts. 2x, 2 sts. 2x (3x) [3x], *2 sts. 1x, 1 st. 1x and REPEAT from * 7x (8x) [9x] more, 2 sts. 3x, 3 sts. 2x. After Row 262 (266) [270], bind off the remaining 11 sts.

DK 239

WOMAN'S CARDIGAN

SIZE: 10/12 (14) [16/18]

YARN: Beatrice

GRAMS:

color 1	150	200	250
color 2	150	200	250
color 3	50	100	100
color 4	100	150	150

TENSION: 5 to 7

GAUGE: 15 sts. 21 rows = 5 cm (2")

Stockinette stitch with REPEATED color stripes as shown on the Chart.

FINISHING: See General Instructions. Gather lower edge of sleeve. Sew ends of Cuff together, then sew 1 edge to the outside and 1 to inside of sleeve.

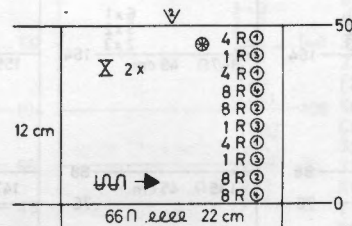

CUFFS: X Make 2.

Cast on 66 sts. with color 4 and work Stockinette stitch with color stripes as shown on the Chart. Knit to Row 50, then bind off.

Cast on 145 (157) [169] sts. with color 4 and work Stockinette stitch with REPEATED color stripes as shown on the Chart.

Knit to Row 26, then hang the hem.

ON EACH SIDE, decrease 1 st. every 8th row 5x, every 6th row 4x. Knit to Row 96.

ON EACH SIDE, increase 1 st. every 18th row 4x. Knit to Row 172.

SHAPE ARMHOLE: ON EACH SIDE, bind off

3 sts. 2x, 2 sts. 2x, 1 st. 5x. (3 sts. 2x, 2 sts. 3x, 1 st. 6x). [3 sts. 3x, 2 sts. 3x, 1 st. 6x]. Knit to Row 248 (252) [256].

Bind off the center 21 sts., put the needles on the left into holding position and complete the right half first.

*SHAPE SHOULDER AND NECK AT THE SAME TIME.

FOR SHOULDER, bind off

5 sts. 3x, 6 sts. 2x. (6 sts. 5x).

[6 sts. 2x, 7 sts. 3x].

FOR NECK, on all sizes, bind off 5 sts. 3x.

Bring the needles on the left into working position, knit 1 row to the left side, turn the Row Counter back to 248 (252) [256] and complete the left half. Follow the instructions from *.

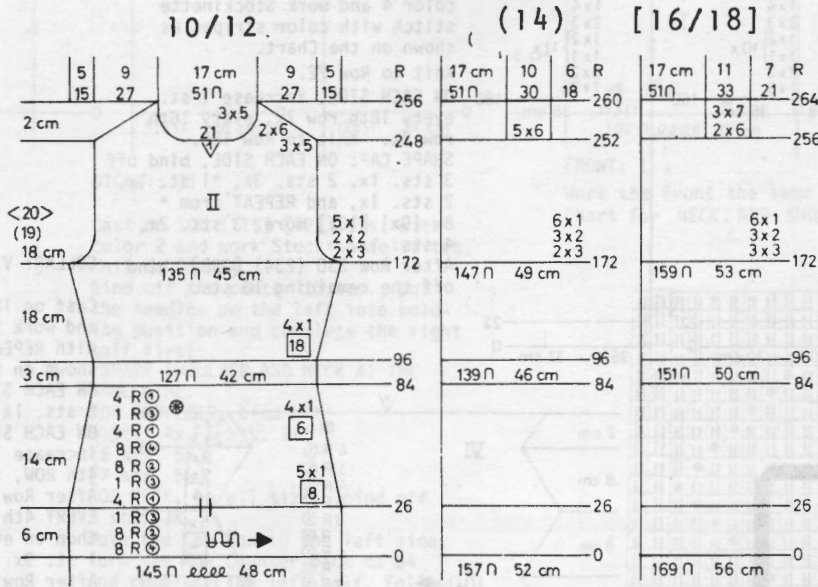

10/12

(14)

[16/18]

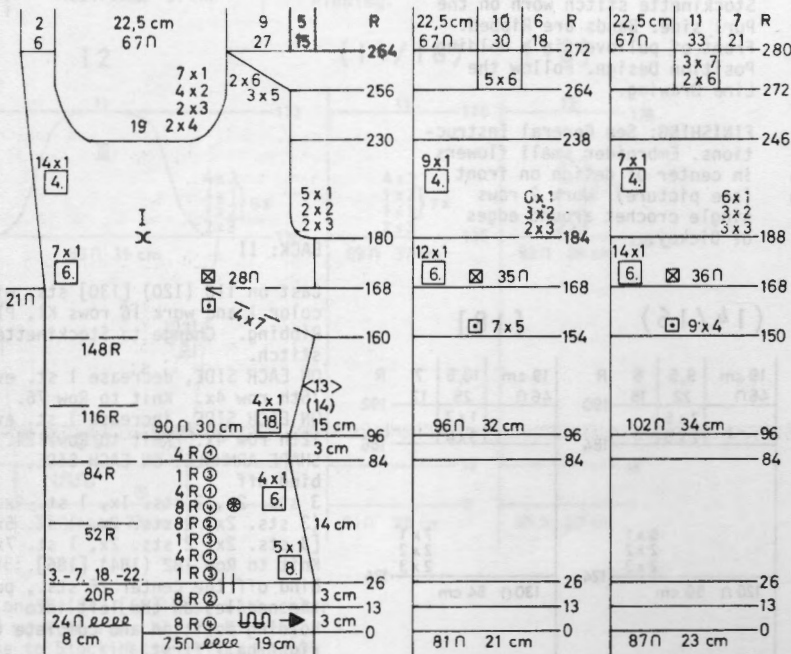

then work SHORT ROWS for the BUST DART.

ON OPPOSITE SIDE OF CAM BOX, put into holding position

7 sts. 4x.

(5 sts. 7x)

[4 sts. 9x].

Bring all the needles back into working position before knitting the next row and SHAPE FRONT FACING after Row 168.

ON FRONT EDGE, increase 1 st.

every 6th row 7x (12x) [14x],

every 4th row 14x (9x) [7x],

AND AT THE SAME TIME, after Row

180 (184) [188], SHAPE ARMHOLE

same as the back.

After Row 230 (238) [246], put

51 (54) [57] needles on the

RIGHT (left for 2nd section)

into holding position, then with

a separate yarn, bind off the

next 19 sts. and put the re-

maining sts. on the left (right

for 2nd section) into holding

position and complete the

right half first. Bring

the needles on the RIGHT

(left) into working position.

*ON NECK SIDE for all sizes,

bind off

4 sts. 1x, 3 sts. 2x, 2 sts.

4x, 1 st. 6x* and after

Row 256 (264) [272], SHAPE

SHOULDER same as the back.

Bring the needles on the left

(right) into working position,

knit 1 row to the left side, turn

the Row Counter back to 230 (238)

[246] and complete the left side,

following the bind-offs for NECK

SHAPING from * to * and don't

forget to complete the increases

for the front facing. After Row

264 (272) [280], bind off the

remaining sts.

Continued



FRONT: I Make 1, reverse 1 and omit the Buttonholes in 2nd section.

Cast on 75 (81) [87] sts. with color 4 and work Stockinette stitch with REPEATED color stripes as shown on the Chart.

After Row 13, cast on 24 sts. After Row 20, make BUTTONHOLES over needles 3 to 7 and 18 to 22, counting

from the LEFT edge. Make the following Buttonholes after the Rows shown on the Chart.

After Row 26, hang the original cast on sts. onto the machine to form the hem. Continue with the REPEATED color stripes.

ON SIDE EDGE, decrease 1 st. every 8th row 5x, every 6th row 4x. Knit to Row 96.

ON SIDE EDGE, increase 1 st. every 18th row 4x. Knit to Row 159 (153) [149]

DK 239

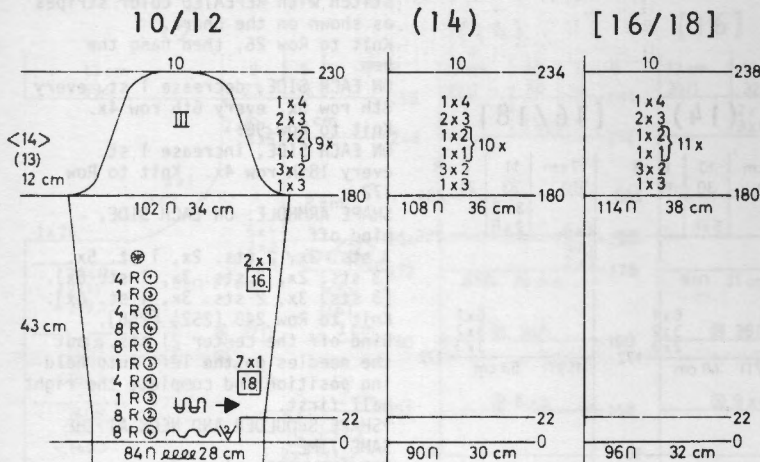

SLEEVE: III

Cast on 84 (90) [96] sts. with color 4 and work Stockinette stitch with color stripes as shown on the Chart.

Knit to Row 22.

ON EACH SIDE, increase 1 st. every 18th row 7x, every 16th row 2x. Knit to Row 180.

SHAPE CAP: ON EACH SIDE, bind off 3 sts. 1x, 2 sts. 3x, *1 st. 1x, 2 sts. 1x, and REPEAT from * 8x (9x) [10x] more, 3 sts. 2x, 4 sts. 1x.

After Row 230 (234) [238], bind off the remaining 10 sts.

COLLAR: VI

Cast on 126 sts. with color 4 and work Stockinette stitch with REPEATED color stripes as shown on the Chart.

ON EACH SIDE, bind off

2 sts. 1x, 3 sts. 2x.

ON EACH SIDE, on every 2nd row, increase 1 st. 9x, then on EVERY 4th ROW, increase 1 st. 5x.

After Row 46, ON EACH SIDE, ON EVERY 4th ROW, decrease 1 st. 5x, then on every 2nd row, decrease 1 st. 9x.

After Row 80, ON EACH SIDE, cast

on 3 sts. 2x, 2 sts. 1x.

After Row 88, bind off.

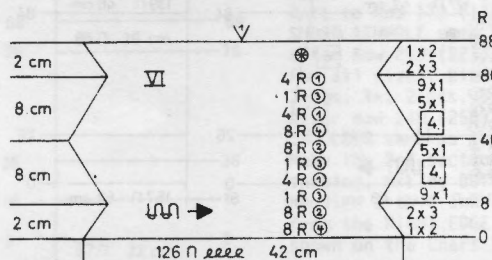

DK 240

WOMAN'S PULLOVER & DICKEY

SIZE 12 (14/16) [18/20]

YARN: color 1 - Alanda
color 2 - Regia

GRAMS:
color 1 400 450 500
color 2 150 200 200

TENSION: color 1 - 10
color 2 - 5 to 7

GAUGE:
color 1 12 sts. 15 rows = 5 cm
color 2 16 sts. 21 rows = 5 cm
Scraps of red and blue for embroidery.

Stockinette stitch worn on the Purl side. Bands are Ribbed. Front of pullover in a Holding Position Design. Follow the Line Drawing.

FINISHING: See General Instructions. Embroider small flowers in center of design on front (see picture). Work 2 rows single crochet around edges of Dickey.



BACK: II

Cast on 110 (120) [130] sts. with color 1 and work 16 rows K1, P1 Ribbing. Change to Stockinette stitch.

ON EACH SIDE, decrease 1 st. every 16th row 4x. Knit to Row 76.

ON EACH SIDE, increase 1 st. every 12th row 4x. Knit to Row 124.

SHAPE ARMHOLE: ON EACH SIDE, bind off

3 sts. 2x, 2 sts. 1x, 1 st. 4x. (3 sts. 2x, 2 sts. 2x, 1 st. 5x).

[3 sts. 2x, 2 sts. 2x, 1 st. 7x]. Knit to Row 182 (184) [186].

Bind off the center 26 sts., put the needles on the left into holding position and complete the right half first.

*SHAPE SHOULDER AND NECK AT THE SAME TIME.

FOR SHOULDER, bind off 5 sts. 4x.

(5 sts. 2x, 6 sts. 2x). [6 sts. 3x, 7 sts. 1x].

FOR NECK, on all sizes, bind off 5 sts. 2x.

Move the Cam Box to the left side, turn the Row Counter back to 182 (184) [186] and complete the left half. Follow the instructions from *.

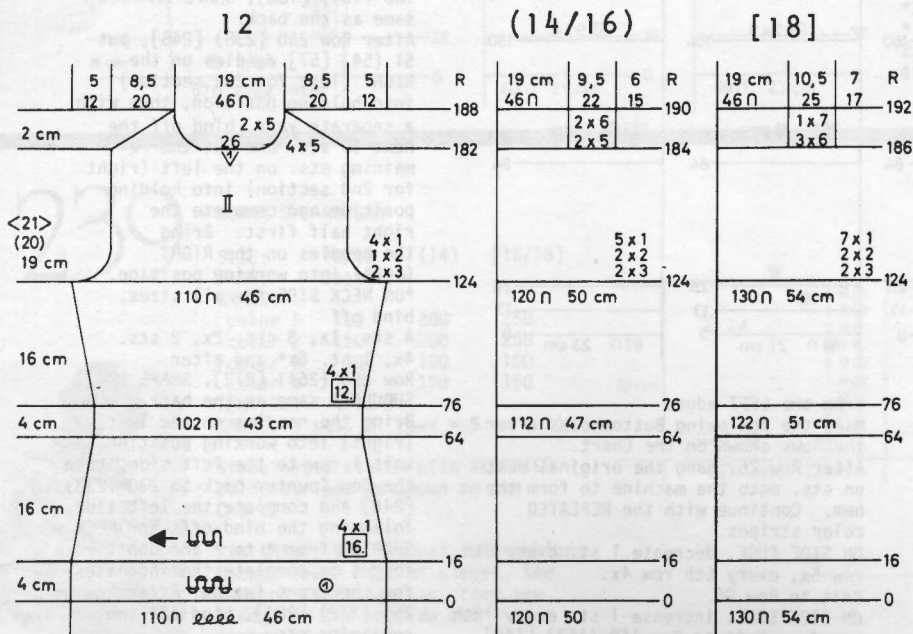

12

(14/16)

[18]

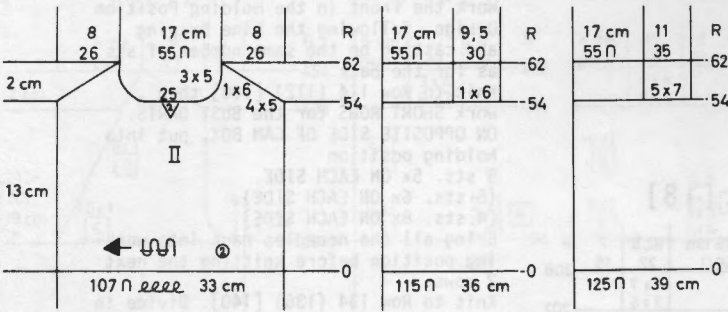

DICKEY: II

Cast on 107 (115) [125] sts. with color 2 and work Stockinette stitch. Knit to Row 54. Bind off the center 25 sts., put the needles on the left into holding position and complete the right half first.
 *SHAPE SHOULDER AND NECK AT THE SAME TIME.
 FOR SHOULDER, bind off 5 sts. 4x, 6 sts. 1x. (6 sts. 5x). [7 sts. 5x].
 FOR NECK, on all sizes, bind off 5 sts. 3x.
 Move the Cam Box to the left side, turn the Row Counter back to 54 and complete the left half. Follow the instructions from *.

12

(14/16)

[18]

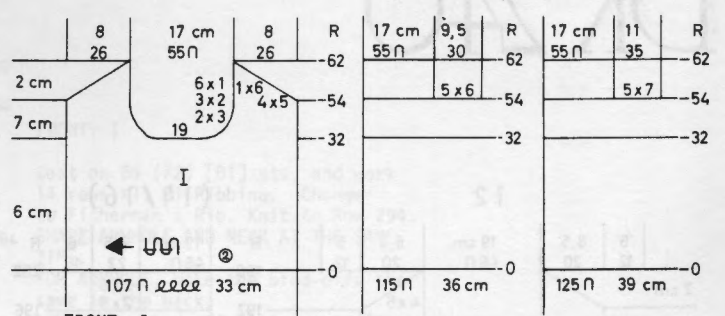

FRONT: I

Work the front the same as the back except FOR NECK. Follow the Chart for NECK, AND SHOULDER.

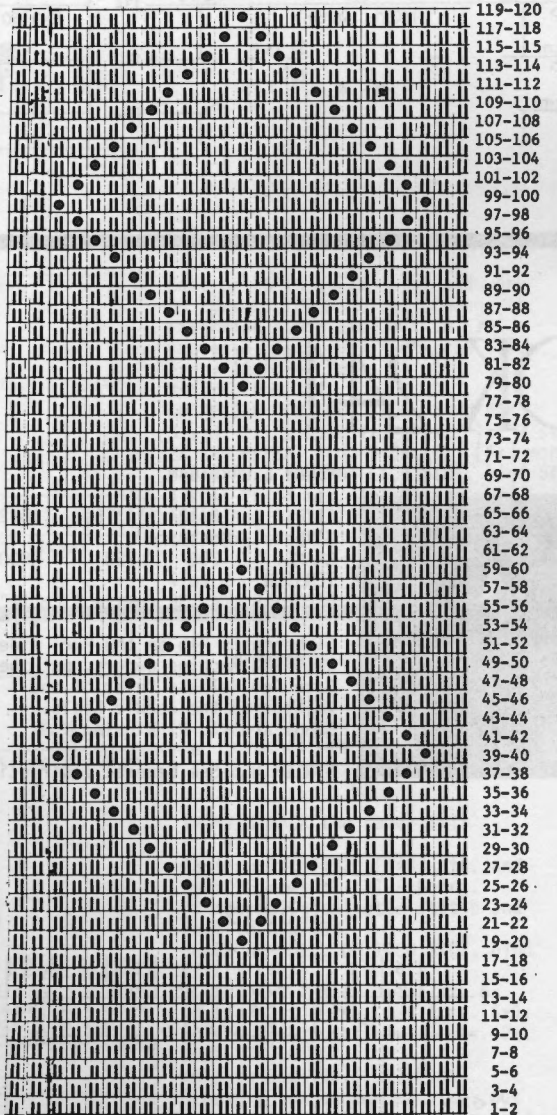

DICKEY COLLAR: VI

Cast on 162 sts. with color 2 and work 84 rows K1, P1 Ribbing then bind off the crochet method for Ribbing.

12

(14/16)

[18]

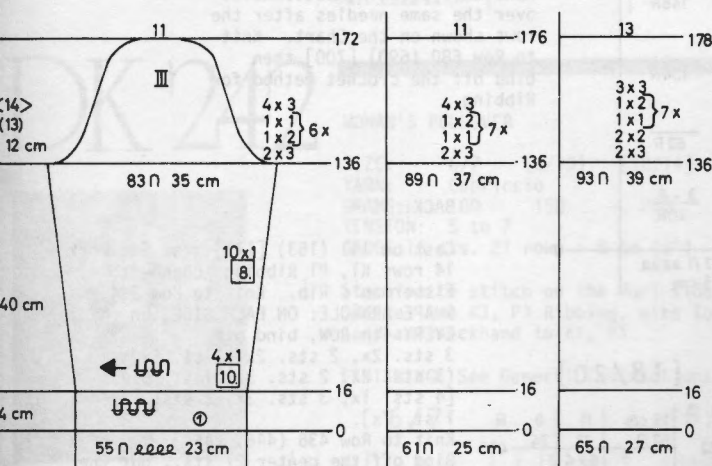

SLEEVE: III

Cast on 55 (61) [65] sts. with color 1 and work 16 rows K1, P1 Ribbing. Change to Stockinette stitch and ON EACH SIDE, increase 1 st. every 10th row 4x, every 8th row 10x. Knit to Row 136. SHAPE CAP: ON EACH SIDE, bind off 3 sts. 2x, *2 sts. 1x, 1 st. 1x and REPEAT from * 5x more, 3 sts. 4x. (3 sts. 2x, *1 st. 1x, 2 sts. 1x, and REPEAT from * 6x more, 3 sts. 4x). [3 sts. 2x, 2 sts. 2x, *1 st. 1x, 2 sts. 1x, and REPEAT from * 6x more, 3 sts. 3x]. After Row 172 (176) [178], bind off the remaining 11 (11) [13] sts.

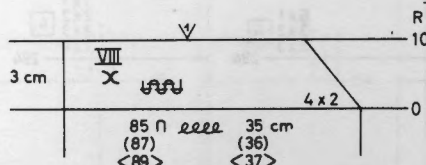

PULLOVER NECKBAND: VIII Make 1, reverse 1.

Cast on 85 (87) [89] sts. with color 1 and work K1, P1 Ribbing. On the RIGHT (left for 2nd section) decrease 2 sts. 4x. After Row 10, bind off the crochet method for Ribbing.

Continued



DK 240

PULLOVER FRONT: I

Work the front in the Holding Position Design, following the Line Drawing and casting on the same number of sts. as for the back.

Knit to Row 114 (112) [108] then work SHORT ROWS for the BUST DARTS. ON OPPOSITE SIDE OF CAM BOX, put into holding position 5 sts. 5x ON EACH SIDE. (5 sts. 6x ON EACH SIDE). [4 sts. 8x ON EACH SIDE].

Bring all the needles back into working position before knitting the next 2 rows.

Knit to Row 134 (136) [140]. Divide in the center, put the needles on the left into holding position and complete the right half first.

*SHAPE ARMHOLE same as the back, and ON NECK SIDE, for all sizes, bind off 1 st. 1x, 2 sts. 11x. Knit to Row 192 (196) [202].

SHAPE SHOULDER same as the back. Bring the needles on the left into working position, knit 1 row in pattern to the left side, turn the Row Counter back to 134 (136) [140] and complete the left half. Follow the instructions from *.

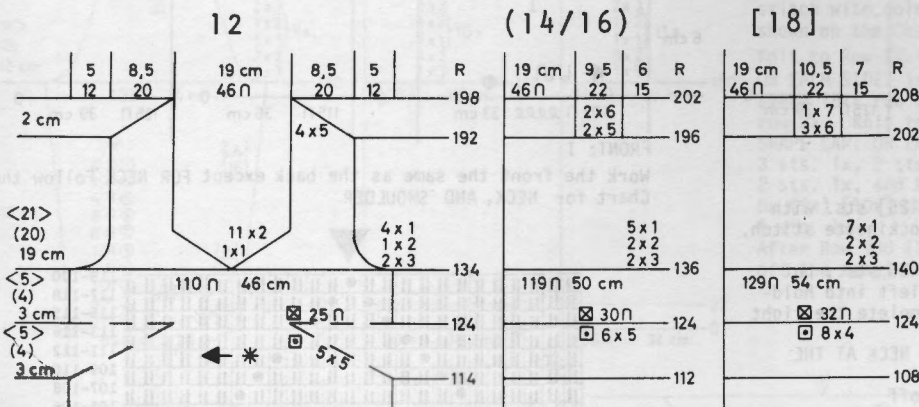

DK 241

WOMAN'S CARDIGAN

SIZE: 10/12 (14/16) [18/20]
 YARN: Beatrice
 GRAMS: 700 750 800
 TENSION: 5 to 7
 GAUGE: 15 sts. 38 rows = 5 cm (2")

Fisherman's Rib on the Purl side. KNITTING machine owners, put the Gate Cam Release Lever of the knitter to the needle heels. Bands are K1, P1 Ribbing.

FINISHING: See General Instructions.



R
 <700>
 (690)
 680

FRONT & NECK BAND: VIII

Cast on 17 sts. and work K1, P1 Ribbing. After Row 20, make BUTTONHOLES over needles 3 to 8. Make the following Buttonholes over the same needles after the rows shown on the Chart. Knit to Row 680 (690) [700] then bind off the crochet method for Ribbing.

BACK: II

Cast on 141 (153) [171] sts. and work 14 rows K1, P1 Ribbing. Change to Fisherman's Rib. Knit to Row 294. SHAPE ARMHOLE: ON EACH SIDE, on EVERY 4th ROW, bind off 3 sts. 2x, 2 sts. 2x, 1 st. 5x. (3 sts. 2x, 2 sts. 3x, 1 st. 6x). [4 sts. 1x, 3 sts. 3x, 2 sts. 2x, 1 st. 7x].

Knit to Row 438 (446) [454]. Bind off the center 27 sts.; put the needles on the left into holding position and complete the right half first.

*SHAPE SHOULDER AND NECK AT THE SAME TIME.

FOR SHOULDER, bind off 3 sts. 9x.

(3 sts. 6x, 4 sts. 3x). [3 sts. 3x, 4 sts. 6x].

FOR NECK, on all sizes, bind off 3 sts. 5x.

Bring the needles on the left into working position, transfer the proper needles to the Ribber. Knit 1 row to the left side turn the Row Counter back to 438 (446) [454] and complete the left half. Follow the instructions from *.

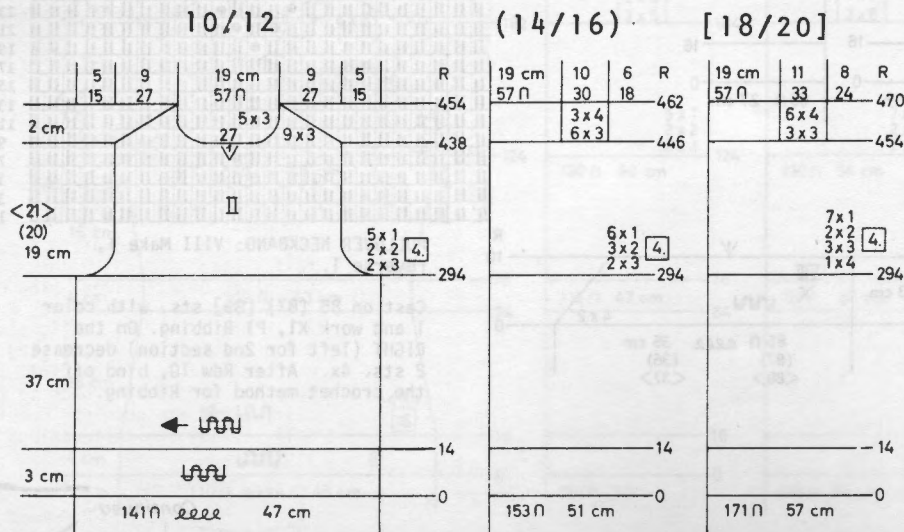

10/12

(14/16)

[18/20]

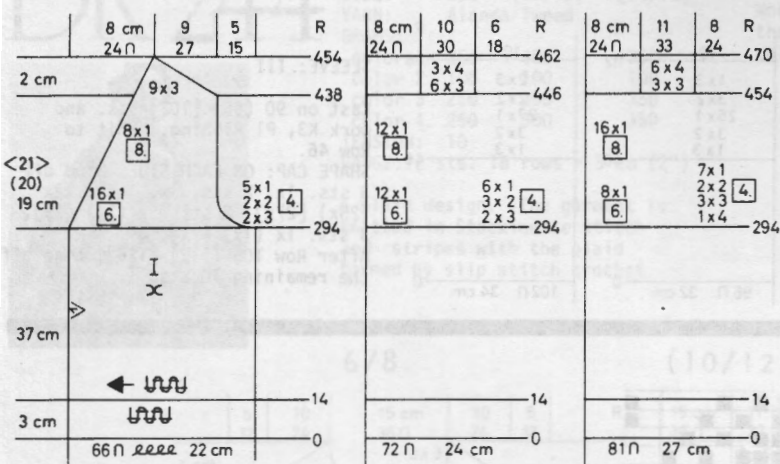

10/12

(14/16)

[18/20]

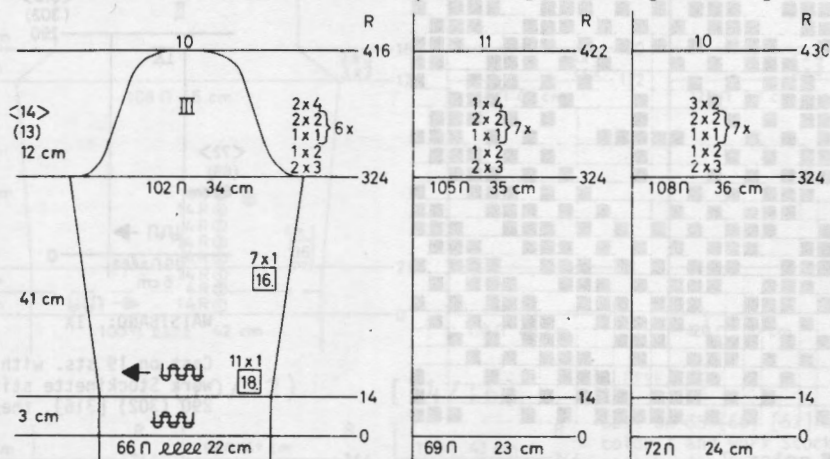

DK 242

WOMAN'S PULLOVER

SIZE: 6/7 (8/10) [12/14]

YARN: Capriccio

GRAMS: 100 150 200

TENSION: 5 to 7

GAUGE: 15 sts. 21 rows = 5 cm (2")

Stockinette stitch on the Purl side.
Sleeves are K3, P1 Ribbing, with lower band and neckband in K1, P1.

FINISHING: See General Instructions.

6/7

(8/10)

[12/14]

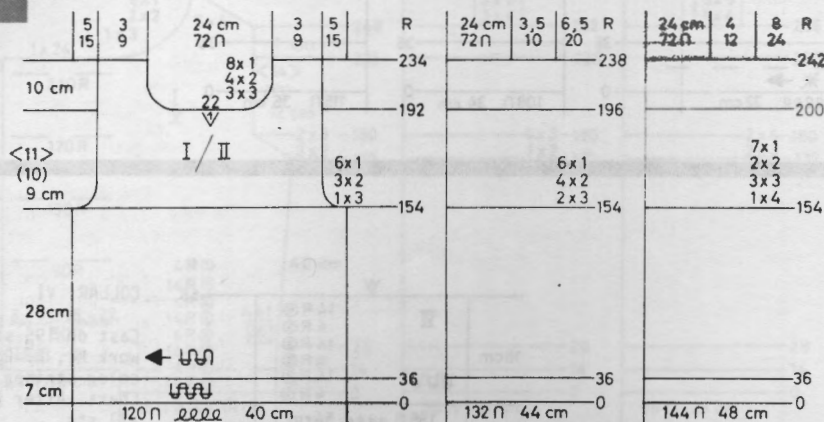

FRONT & BACK the same: I/II

Cast on 120 (132) [144] sts. and work 36 rows K1, P1 Ribbing. Change to Stockinette stitch and knit to Row 154.
SHAPE ARMHOLE: ON EACH SIDE, bind off

3 sts. 1x, 2 sts. 3x, 1 st. 6x. (3 sts. 2x, 2 sts. 4x, 1 st. 6x). [4 sts. 1x, 3 sts. 3x, 2 sts. 2x, 1 st. 7x].
Knit to Row 192 (196) [200]. Bind off the center 22 sts., put the needles on the left into holding position and complete the right half first.

*FOR NECK, on all sizes, bind off 3 sts. 3x, 2 sts. 4x, 1 st. 8x. After Row 234 (238) [242], bind off the remaining 9 (10) [12] sts. Move the Cam Box to the left side, turn the Row Counter back to 192 (196) [200] and complete the left half. Follow the instructions from *.



DK 242

6/7

(8/10)

[12/14]

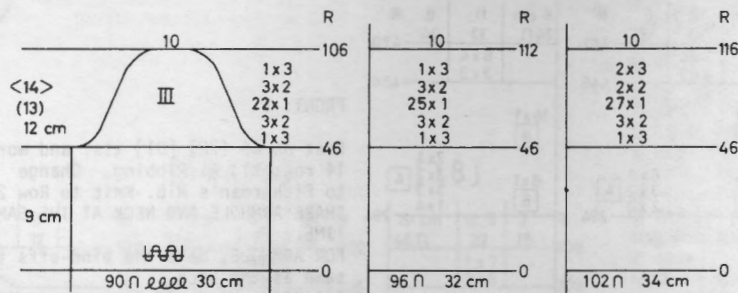

SLEEVE: III

Cast on 90 (96) [102] sts. and work K3, P1 Ribbing. Knit to Row 46.
SHAPE CAP: ON EACH SIDE, bind off 3 sts. 1x, 2 sts. 3x, 1 st. 22x (25x) [27x], 2 sts. 3x (3x) [2x], 3 sts. 1x (1x) [2x]. After Row 106 (112) [116], bind off the remaining 10 sts.

DK 243

WOMAN'S LONG SKIRT

SIZE: 6/7 (8/10) [12/14]
YARN: color 1 - Beatrice
color 2 - Capriccio

GRAMS: color 1 650 700 750
color 2 100 100 100
TENSION: 5 to 7
GAUGE: 16 sts. 22 rows = 5 cm (2")

Lower half of skirt in Norwegian Design, the remainder in Stockinette stitch. Follow the Line Drawing or use JAC 40 and Pattern No. 577.

FINISHING: See General Instructions. Sew on waistband and buckle.

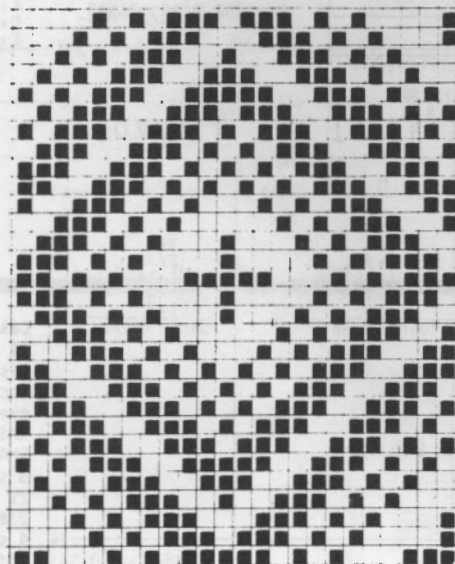

■ color 2
□ color 1

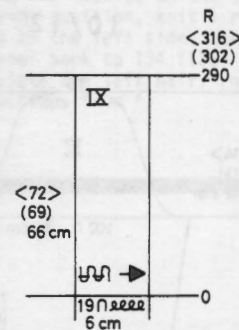

WAISTBAND: IX

Cast on 19 sts. with color 1 and work Stockinette stitch to Row 290 (302) [316], then bind off.



6/7

(8/10)

[12/14]

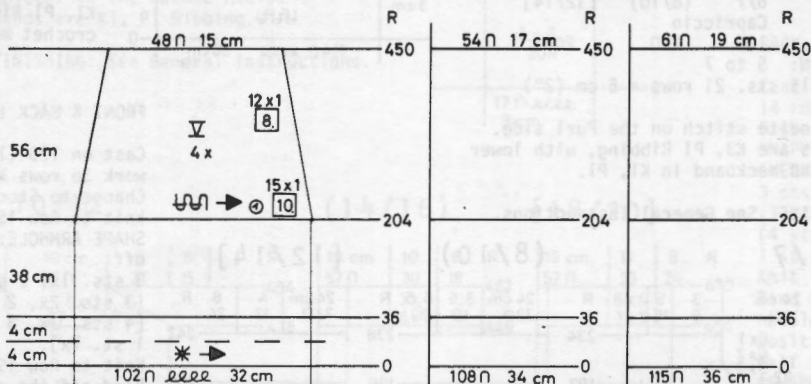

Make 4 sections. V

Cast on 102 (108) [115] sts. with color 1 and work the Norwegian Design. After Row 204, continue in Stockinette stitch with color 1. ON EACH SIDE, decrease 1 st. every 10th row 15x, every 8th row 12x. Knit to Row 450, then bind off the remaining 48 (54) [61] sts.

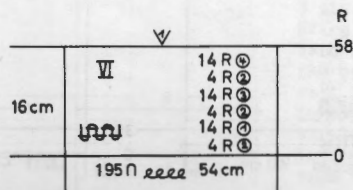

COLLAR: VI

Cast on 195 sts. with color 2 and work K1, P1 Ribbing with REPEATED color stripes as shown on the Chart. After Row 58, bind off all sts.

DK 244

WOMAN'S JACKET

SIZE: 6/8 (10/12) [14/16]
 YARN: Alanda Tweed
 GRAMS:
 color 1 250 300 350
 color 2 100 100 100
 color 3 250 300 350
 color 4 250 300 350
 TENSION: 10
 GAUGE: 12 sts. 18 rows = 5 cm (2")

FINISHING: See General Instructions.
 Work a slip stitch crochet between the 14th & 15th stitches using color 4.



A plaid design. The garment is knitted in Stockinette stitch and stripes with the plaid formed by slip stitch crochet.

BACK: II

Cast on 100 (110) [120] sts. with color 1 and work Stockinette stitch with REPEATED color stripes as shown on the Chart.
 Knit to Row 28, then hang the hem. ON EACH SIDE, increase 1 st. every 36th row 4x. Knit to Row 172. SHAPE ARMHOLE: ON EACH SIDE, bind off, 2 sts. 3x, 3 sts. 2x. (2 sts. 1x, 3 sts. 4x). [3 sts. 3x, 4 sts. 2x]. Knit to Row 248 (252) [256]. Bind off the center 18 sts. put the needles on the left into holding position and complete the right half first.
 *SHAPE SHOULDER AND NECK AT THE SAME TIME.
 FOR SHOULDER, bind off 4 sts. 6x. (4 sts. 3x, 5 sts. 3x). [4 sts. 1x, 5 sts. 5x].
 FOR NECK, on all sizes, bind off 3 sts. 3x.
 Bring the needles on the left into working position, knit 1 row to the left side, turn the Row Counter back to 248 (252) [256] and complete the left half. Follow the instructions from *.

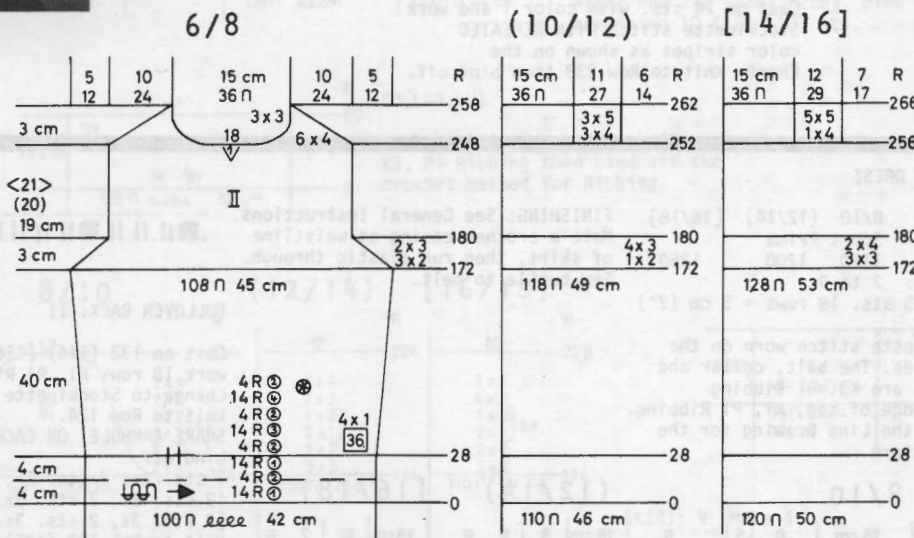

SLEEVE: III

Cast on 58 (60) [62] sts. with color 1 and work Stockinette stitch with REPEATED color stripes as shown on the Chart.
 Knit to Row 28, then hang the hem. ON EACH SIDE, increase 1 st. every 8th row 11x, every 6th row 20x. (every 8th row 8x, every 6th row 24x). [every 6th row 32x, every 4th row 4x]. Knit to Row 236. SHAPE CAP: ON EACH SIDE, bind off 2 sts. 3x, 3 sts. 2x. (2 sts. 1x, 3 sts. 4x). [3 sts. 3x, 4 sts. 2x]. After Row 244, bind off the remaining 96 (98) [100] sts.

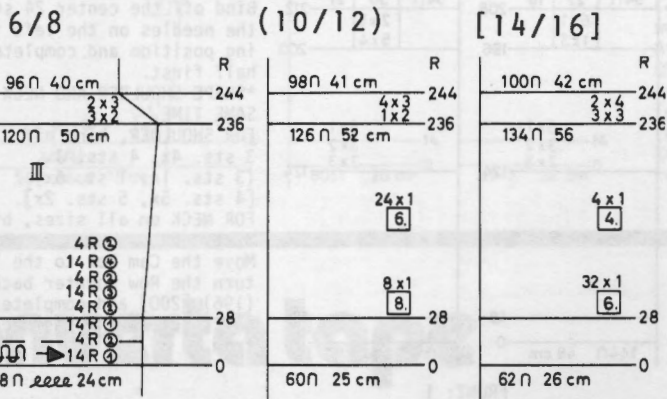

FRONT: I Make 1, reverse 1 and omit the Buttonholes.

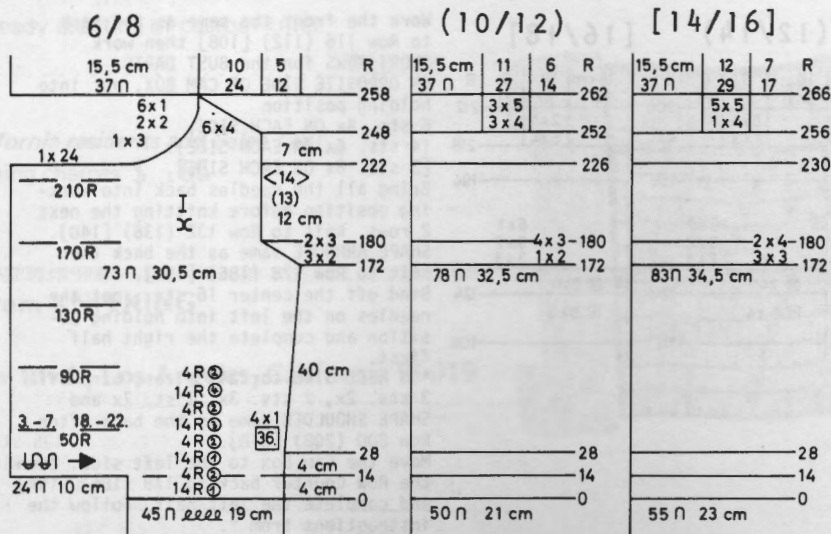

Cast on 45 (50) [55] sts. with color 1 and work Stockinette stitch with REPEATED color stripes as shown on the Chart. Knit to Row 14, then with a separate yarn, cast on 24 sts. on the LEFT (right for 2nd section) side. After Row 28, hang the original cast-on sts. back onto the machine to form the hem. ON SIDE EDGE, increase 1 st. every 36th row 4x AND AT THE SAME TIME, after Row 50, make BUTTONHOLES over needles 3 to 7 and 18 to 22 counting from the LEFT edge. Make the following Buttonholes over the same needles after the rows shown on the Chart. Knit to Row 172. SHAPE ARMHOLE same as the back, then knit to Row 221 (225) [229]. FOR NECK, on all sizes, bind off 24 sts. 1x, 3 sts. 1x, 2 sts. 2x, 1 st. 6x and SHAPE SHOULDER same as the back after Row 248 (252) [256].

DK 245

SHOULDER BAG

YARN: Alanda Tweed

GRAMS:

color 1 50

color 2 50

color 3 50

color 4 50

TENSION: 10

GAUGE: 12 sts. 18 rows = 5 cm (2")

Pattern is the same as DK 244.

FINISHING: Fold into envelope shape and sew side seams. Line bag. Sew straps to sides (see picture).

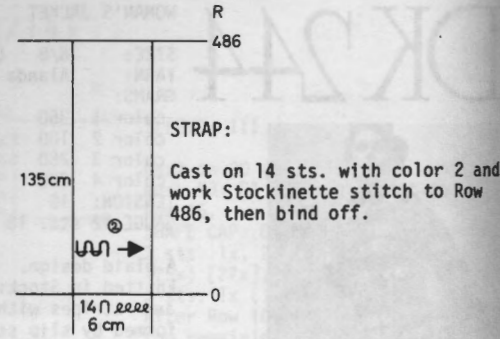
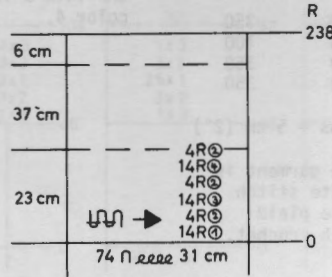

STRAP:

Cast on 14 sts. with color 2 and work Stockinette stitch to Row 486, then bind off.

BAG:

Cast on 74 sts. with color 1 and work Stockinette stitch with REPEATED color stripes as shown on the Chart. Knit to Row 238 then bind off.

DK 246

WOMAN'S DRESS

SIZE: 8/10 (12/14) [16/18]

YARN: Sport Prima

GRAMS: 1150 1200 1250

TENSION: 7 to 9

GAUGE: 15 sts. 19 rows = 5 cm (2")

Stockinette stitch worn on the Purl side. The belt, collar and sleeves are K3, P1 Ribbing. Lower edge of top, K1, P1 Ribbing. Follow the Line Drawing for the Rib Pattern.

FINISHING: See General Instructions.

Make a crochet casing at waistline of skirt, then run elastic through. Sew buckle to belt.

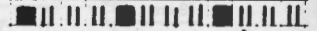

PULLOVER BACK: II

Cast on 132 (144) [156] sts. and work 18 rows K1, P1 Ribbing. Change to Stockinette stitch and knit to Row 124.
SHAPE ARMHOLE: ON EACH SIDE, bind off 3 sts. 2x, 2 sts. 2x, 1 st. 5x. (3 sts. 2x, 2 sts. 3x, 1 st. 6x). [3 sts. 3x, 2 sts. 3x, 1 st. 6x]. Knit to Row 192 (196) [200]. Bind off the center 24 sts., put the needles on the left into holding position and complete the right half first.
*SHAPE SHOULDER AND NECK AT THE SAME TIME.
FOR SHOULDER, bind off 3 sts. 4x, 4 sts. 3x. (3 sts. 1x, 1 st. 6x). [4 sts. 5x, 5 sts. 2x].
FOR NECK on all sizes, bind off 3 sts. 5x.
Move the Cam Box to the left side, turn the Row Counter back to 192 (196) [200] and complete the left half. Follow the instructions from *.

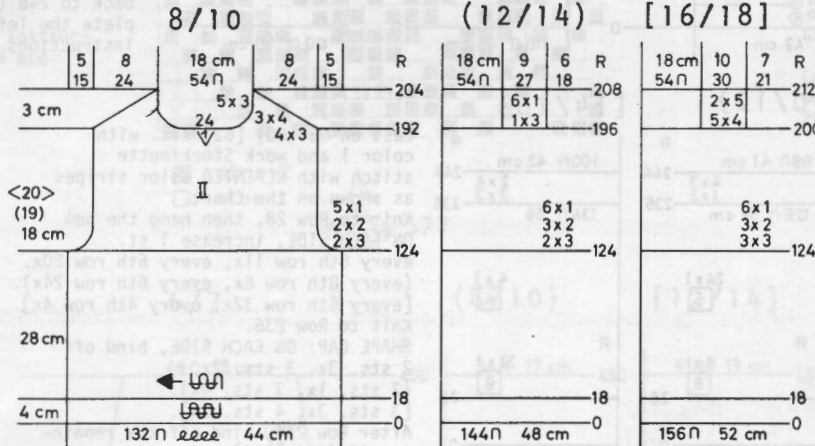

FRONT: I

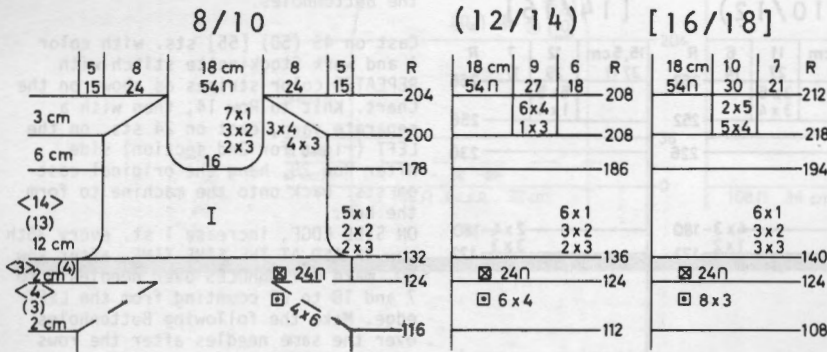

Work the front the same as the back to Row 116 (112) [108] then work SHORT ROWS for the BUST DARTS. ON OPPOSITE SIDE OF CAM BOX, put into holding position 6 sts. 4x ON EACH SIDE. (4 sts. 6x ON EACH SIDE). [3 sts. 8x ON EACH SIDE]. Bring all the needles back into working position before knitting the next 2 rows. Knit to Row 132 (136) [140]. SHAPE ARMHOLE same as the back then knit to Row 178 (186) [194]. Bind off the center 16 sts., put the needles on the left into holding position and complete the right half first.
*ON NECK SIDE for all sizes, bind off 3 sts. 2x, 2 sts. 3x, 1 st. 7x and SHAPE SHOULDER same as the back after Row 200 (208) [218].
Move the Cam Box to the left side, turn the Row Counter back to 178 (186) [194] and complete the left half. Follow the instructions from *.

8/10

(12/14) [16/18]

SLEEVE: III

Cast on 54 (60) [66] sts. and work 14 rows K1, P1 Ribbing. Change to K3, P1 Ribbing. ON EACH SIDE, increase 1 st. every 8th row 14x, every 6th row 8x. Knit to Row 174. SHAPE CAP: ON EACH SIDE, bind off 3 sts. 2x, 2 sts. 2x, *1 st. 2x, 2 sts. 1x, and REPEAT from * 4x more, 3 sts. 2x, 4 sts. 2x. (3 sts. 3x, 2 sts. 1x, *1 st. 2x, 2 sts. 1x, and REPEAT from * 5x more, 3 sts. 1x, 4 sts. 2x). [3 sts. 2x, 2 sts. 2x, *1 st. 2x, 2 sts. 1x, and REPEAT from * 5x more, 3 sts. 4x, 4 sts. 1x. After Row 220 (224) [228], bind off the remaining 10 (12) [10] sts.

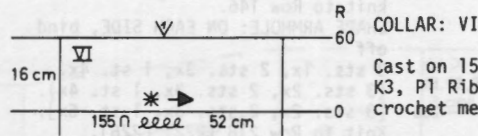
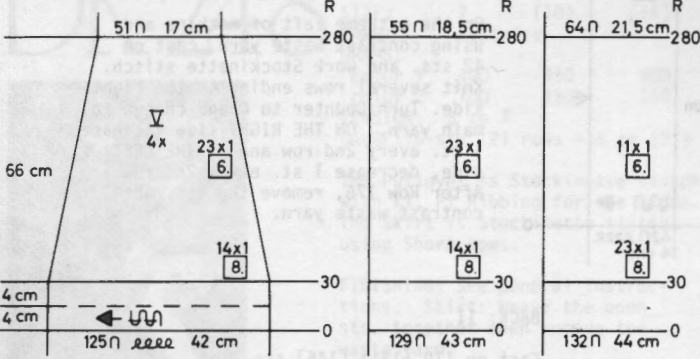

COLLAR: VI

Cast on 155 sts. and work 60 rows K3, P1 Ribbing then bind off the crochet method for Ribbing.

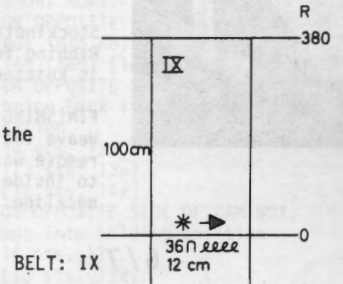

BELT: IX

Cast on 36 sts. and work 380 rows K3, P1 Ribbing then bind off the crochet method for Ribbing.

8/10 (12/14) [16/18]

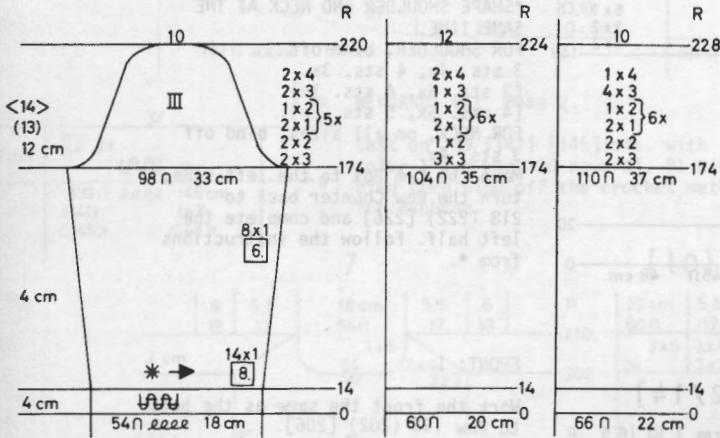

SKIRT: V Make 4.

Cast on 125 (129) [132] sts. and work Stockinette stitch. After Row 30, hang the hem. ON EACH SIDE, decrease 1 st. every 8th row 14x, every 6th row 23x. (every 8th row 14x, every 6th row 23x). [every 8th row 23x, every 6th row 11x]. Knit to Row 280 then bind off the remaining 51 (55) [64] sts.

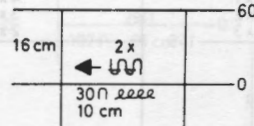

POCKET TABS: Make 2.

Cast on 30 sts. and work 60 rows Stockinette stitch then bind off.

converta tape

For simple and speedy charting of custom knits.

List Price \$10.95

(California residents add Sales Tax)

Shipping charges: \$.65

Order direct from KNITKING

1128 Crenshaw Blvd., Los Angeles, California 90019

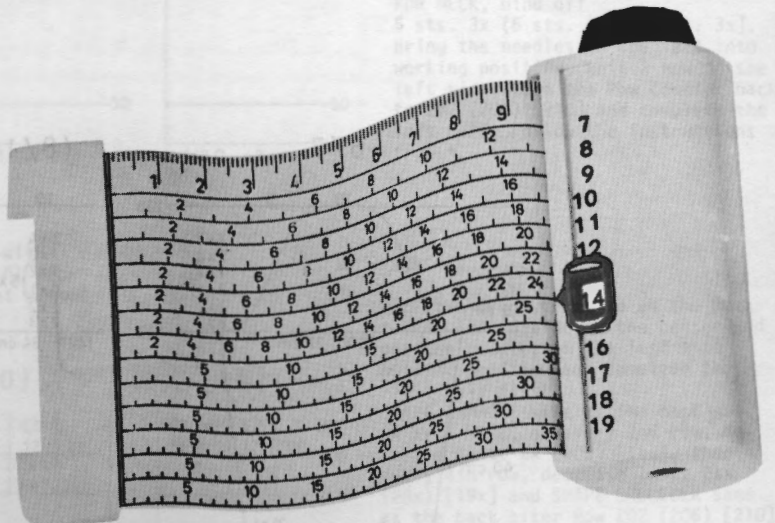

DK 247



WOMAN'S PULLOVER

SIZE: 6/7 (8/10 [12/14])
 YARN: Beatrice
 GRAMS: 300 350 400
 TENSION: 5 to 7
 GAUGE: 15 sts. 21 rows = 5 cm (2")

Stockinette stitch with K1, P1 Ribbing for Bands. The Collar is knitted on the bias.

FINISHING: See General Instructions. Weave the open sts. of collar then remove waste yarn. Sew 1 edge to inside and 1 to outside of neckline.

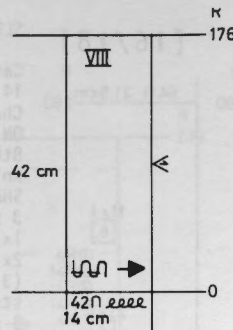

COLLAR: VIII

On the extreme left of machine and using contrast waste yarn, cast on 42 sts. and work Stockinette stitch. Knit several rows ending on the right side. Turn Counter to 0 and change to main yarn. ON THE RIGHT side increase 1 st. every 2nd row and ON THE LEFT side, decrease 1 st. every 2nd row. After Row 176, remove the sts. onto contrast waste yarn.

BACK: II

Cast on 119 (131) [145] sts. and work 20 rows K1, P1 Ribbing. Change to Stockinette stitch and knit to Row 146. SHAPE ARMHOLE: ON EACH SIDE, bind off

3 sts. 1x, 2 sts. 3x, 1 st. 4x. (3 sts. 2x, 2 sts. 3x, 1 st. 4x). [3 sts. 2x, 2 sts. 3x, 1 st. 6x]. Knit to Row 218 (222) [226], bind off the center 21 sts., put the needles on the left into holding position and complete the right half first.

*SHAPE SHOULDER AND NECK AT THE SAME TIME.

FOR SHOULDER, bind off

3 sts. 4x, 4 sts. 3x.

(3 sts. 6x, 4 sts. 1x).

[4 sts. 5x, 5 sts. 2x].

FOR NECK, on all sizes, bind off 3 sts. 4x.

Move the Cam Box to the left side, turn the Row Counter back to 218 (222) [226] and complete the left half. Follow the instructions from *.

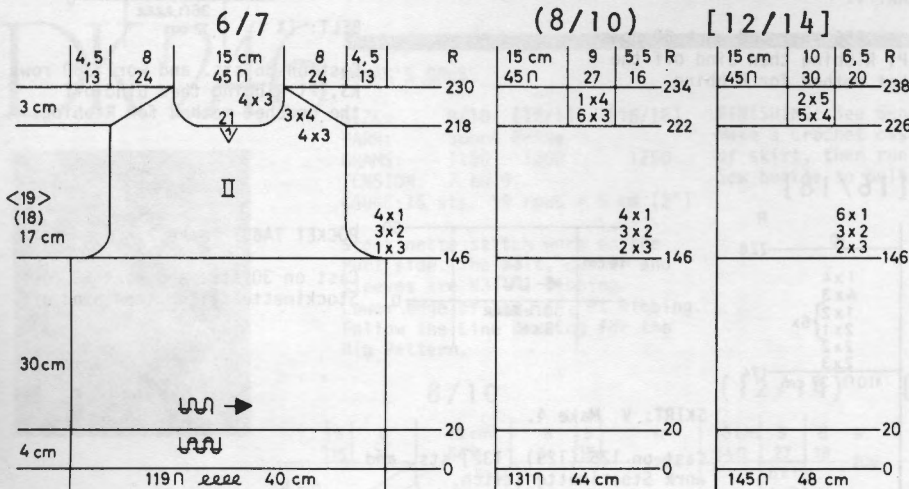

FRONT: I

Work the front the same as the back to Row 198 (202) [206].

Bind off the center 15 sts., put the needles on the left into holding position and complete the right half first.

*FOR NECK, on all sizes, bind off 3 sts. 2x, 2 sts. 2x, 1 st. 5x and SHAPE SHOULDER same as the back after Row 218 (222) [226].

Move the Cam Box to the left side, turn the Row Counter back to 198 (202) [206] and complete the left half. Follow the instructions from *

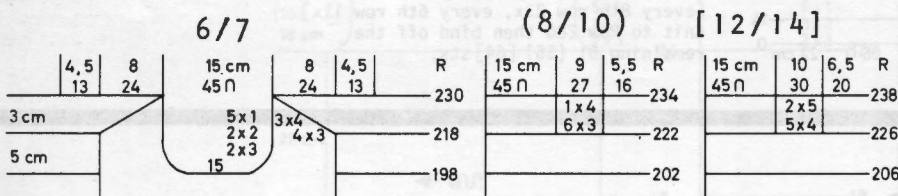

SLEEVE: III

Cast on 54 (60) [66] sts. and work 20 rows K1, P1 Ribbing. Change to Stockinette stitch and ON EACH SIDE, increase 1 st. every 8th row 21x.

Knit to Row 188.

SHAPE CAP: ON EACH SIDE, bind off 3 sts. 2x, 2 sts. 2x, *1 st. 3x, 2 sts. 1x, and REPEAT from * 3x more, 2 sts. 2x, 3 sts. 3x.

(3 sts. 2x, 2 sts. 2x, *1 st. 3x, 2 sts. 1x, and REPEAT from * 4x more, 3 sts. 1x, 4 sts. 2x).

[3 sts. 1x, 2 sts. 3x, *1 st. 3x, 2 sts. 1x, and REPEAT from * 4x more, 3 sts. 5x].

After Row 238 (242) [246], bind off the remaining 10 sts.

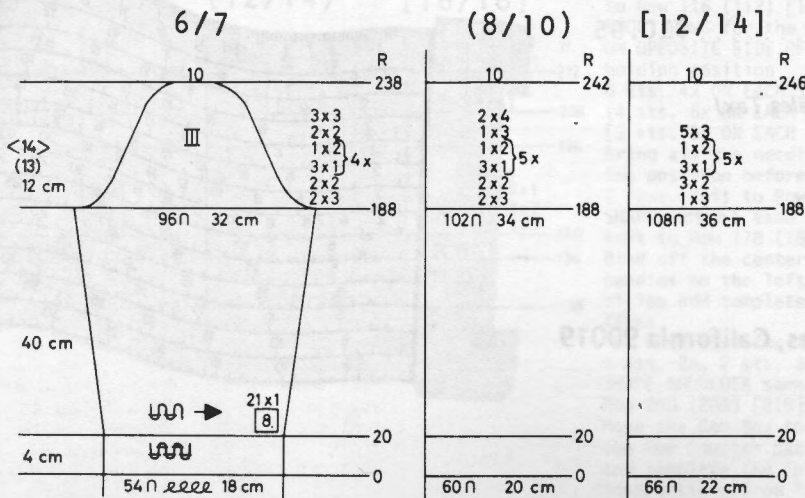

DK 248

WOMAN'S SKIRT & V NECK PULLOVER

SIZE: 7 (10) [14]
 YARN: Beatrice
 GRAMS:
 color 1 400 450 500
 color 2 100 150 150
 TENSION: 5 to 7
 GAUGE: 15 sts. 21 rows = 5 cm (2")

The Pullover is Stockinette stitch with K1, P1 Ribbing for the bands. The Skirt is Stockinette stitch using Short Rows.

FINISHING: See General instructions. Skirt: Weave the open-sts. together then remove the waste yarn.



SKIRT: V

OPEN CAST ON with waste yarn 197 sts. and work Stockinette stitch. Knit several rows ending with Cam Box on the left. Knit 1 row with a ravel cord. Turn the Row Counter to 0. Change to Main yarn.

*Knit to Row 12, then work SHORT ROWS.

ON OPPOSITE SIDE OF CAM BOX, put into holding position 168 (169) [168] sts.

ON OPPOSITE SIDE OF CAM BOX, bring back into working position, 14 sts. 12x.

(13 sts. 13x).

[12 sts. 14x].

ON OPPOSITE SIDE OF CAM BOX, put into holding position 14 sts. 12x.

(13 sts. 13x).

[12 sts. 14x].

ON OPPOSITE SIDE OF CAM BOX, bring all the needles back into working position, then knit to Row 74 (82) [90].

Put the Row Counter back to 0 and REPEAT from * 9x more.

Remove the sts. onto contrast waste yarn.

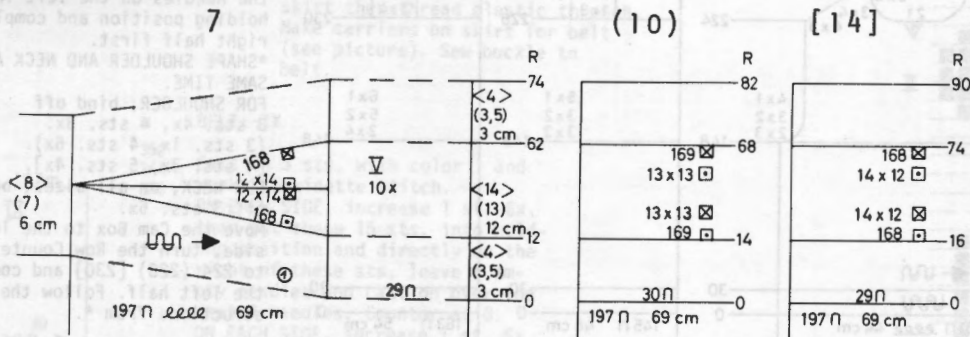

R NEKBAND: VII Make 2.

Cast on 139 (141) [145] sts. with color 1 and work 10 rows K1, P1 Ribbing then bind off the crochet method for Ribbing.

PULLOVER BACK: II

Cast on 124 (136) [148] sts. with color 1 and work 30 rows K1, P1 Ribbing. Change to the REPEATED color stripes as shown on the Chart and knit to Row 114.

SHAPE ARMHOLE: ON EACH SIDE, bind off 3 sts. 2x, 2 sts. 3x, 1 st. 6x. (3 sts. 3x, 2 sts. 3x, 1 st. 6x). [4 sts. 1x, 3 sts. 2x, 2 sts. 4x, 1 st. 6x].

Knit to Row 202 (206) [210]. Bind off the center 24 sts., put the needles on the left into holding position and complete the right half first.

*SHAPE SHOULDER AND NECK AT THE SAME TIME.

FOR SHOULDER, bind off

3 sts. 3x, 4 sts. 2x.

(3 sts. 3x, 4 sts. 2x).

[3 sts. 3x, 4 sts. 2x].

FOR NECK, bind off

5 sts. 3x (6 sts. 3x) [7 sts. 3x].

Bring the needles on the left into working position, knit 1 row to the left side, turn the Row Counter back to 202 (206) [210] and complete the left half. Follow the instructions from *.

FRONT: I

Work the front the same as the back to Row 114, divide in the center and put the needles on the left into holding position and complete the right half first.

*SHAPE ARMHOLE same as the back and ON NECK SIDE, on every 2nd row, decrease 1 st. 6x (10x) [14x], then every 4th row, decrease 1 st. 21x (20x) [19x] and SHAPE SHOULDER same as the back after Row 202 (206) [210]. Bring the needles on the left into working position, knit 1 row to the left side, turn the Row Counter back to 114 and complete the left half. Follow the instructions from *.

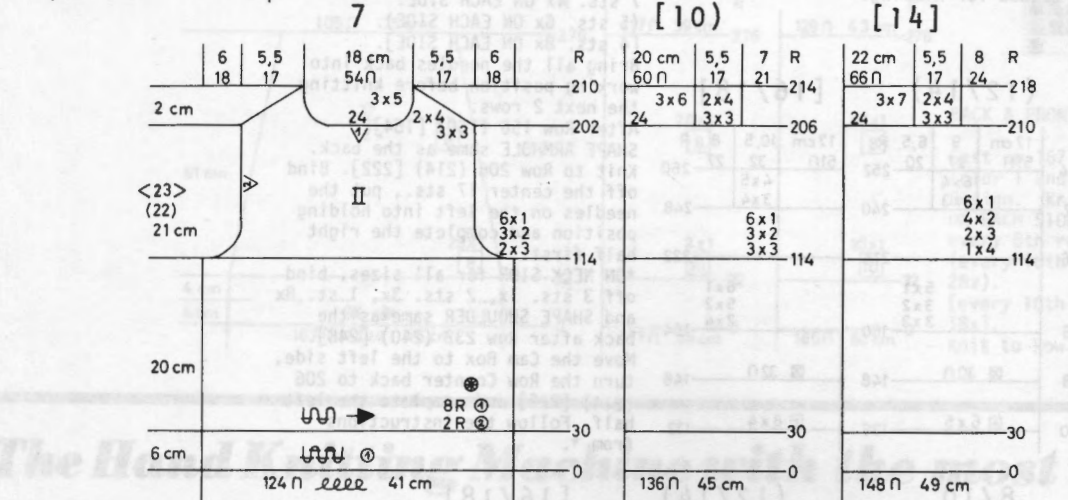
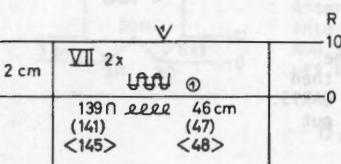

R ARMBANDS: VII Make 2.

Cast on 151 (153) [157] sts. with color 1 and work 10 rows K1, P1 Ribbing then bind off the crochet method for Ribbing.

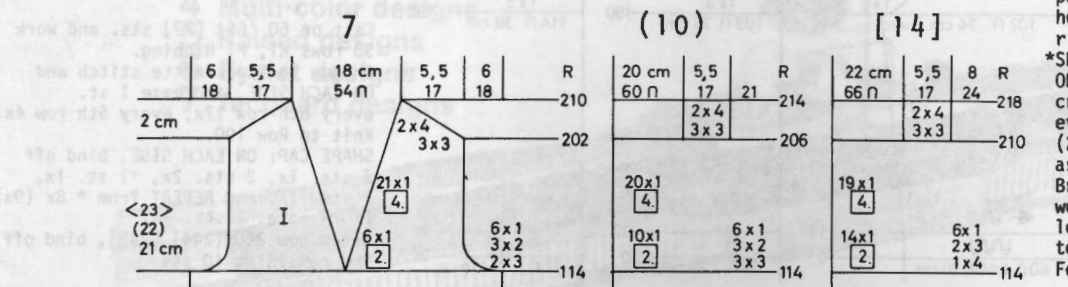
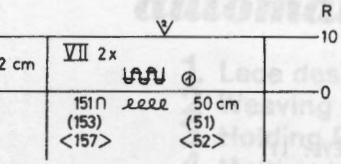

DK 249

WOMAN'S PULLOVER

SIZE: 8/10 [12/14] [16/18]
 YARN: Capriccio
 GRAMS: 150 200 250
 TENSION: 5 to 7
 GAUGE: 15 sts. 21 rows = 5 cm (2")

Stockinette stitch worn on the Purl side. The bands are K1, P1 Ribbing.

FINISHING: See General Instructions.



BACK: II

Cast on 131 (145) [163] sts. and work 30 rows K1, P1 Ribbing. Change to Stockinette stitch and knit to Row 148.
 SHAPE ARMHOLE: ON EACH SIDE, bind off 3 sts. 2x, 2 sts. 3x, 1 st. 4x. (3 sts. 3x, 2 sts. 3x, 1 st. 5x). [4 sts. 2x, 2 sts. 5x, 1 st. 6x]. Knit to Row 224 (228) [230]. Bind off the center 21 sts., put the needles on the left into holding position and complete the right half first.
 *SHAPE SHOULDER AND NECK AT THE SAME TIME.
 FOR SHOULDER, bind off 3 sts. 4x, 4 sts. 3x. (3 sts. 1x, 4 sts. 6x). [4 sts. 3x, 5 sts. 4x].
 FOR NECK, on all sizes, bind off 3 sts. 5x.
 Move the Cam Box to the left side, turn the Row Counter back to 224 (228) [230] and complete the left half. Follow the instructions from *.

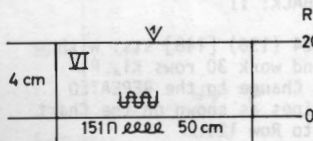
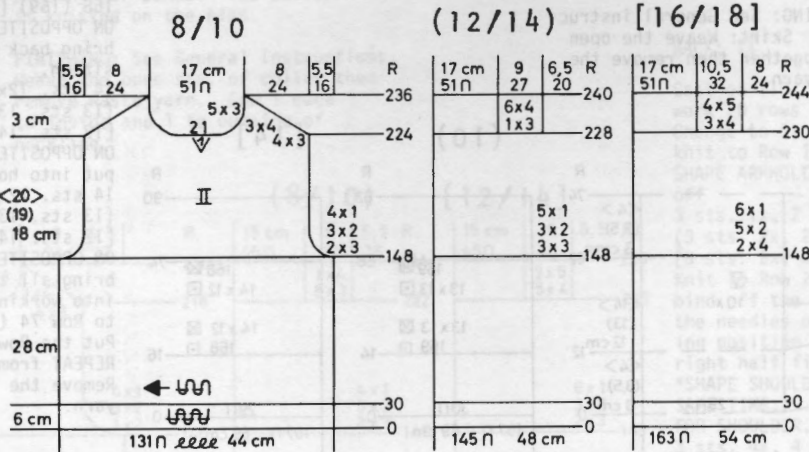

NECKBAND: VI

Cast on 151 sts. and work 20 rows K1, P1 Ribbing then bind off the crochet method for Ribbing.

FRONT: I

Work the front the same as the back to Row 140 (136) [132], then work SHORT ROWS for the BUST DARTS. ON OPPOSITE SIDE OF CAM BOX, put into holding position 7 sts. 4x ON EACH SIDE. (5 sts. 6x ON EACH SIDE). [4 sts. 8x ON EACH SIDE]. Bring all the needles back into working position before knitting the next 2 rows.
 After Row 156 (160) [164]. SHAPE ARMHOLE same as the back. Knit to Row 206 (214) [222]. Bind off the center 17 sts., put the needles on the left into holding position and complete the right half first.
 *ON NECK SIDE for all sizes, bind off 3 sts. 1x, 2 sts. 3x, 1 st. 8x and SHAPE SHOULDER same as the back after Row 232 (240) [248]. Move the Cam Box to the left side, turn the Row Counter back to 206 (214) [222] and complete the left half. Follow the instructions from *.

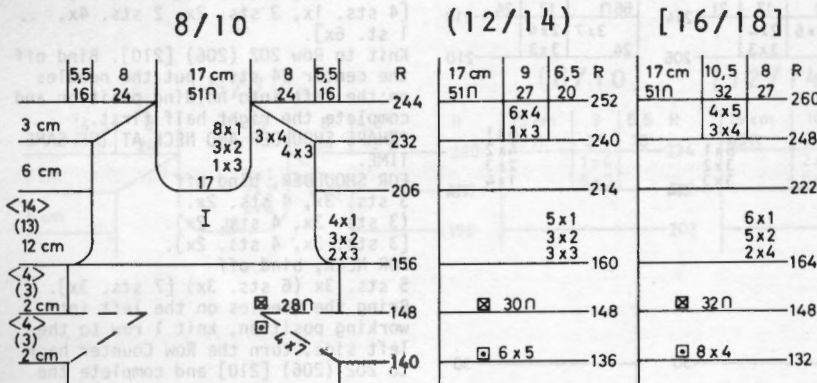

8/10

(12/14)

[16/18]

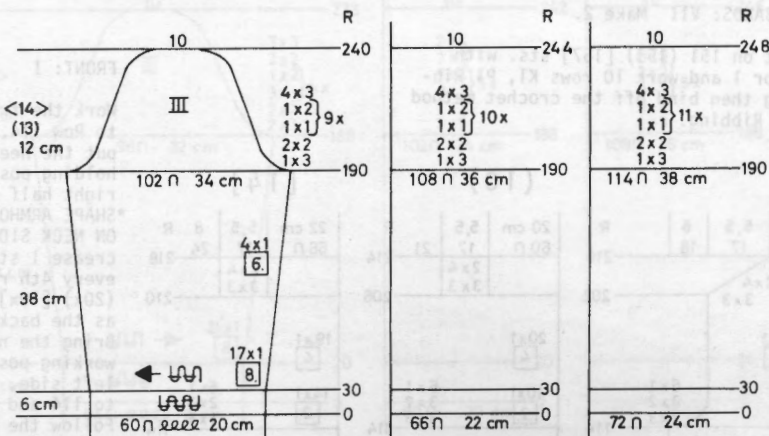

SLEEVE: III

Cast on 60 (66) [72] sts. and work 30 rows K1, P1 Ribbing. Change to Stockinette stitch and ON EACH SIDE, increase 1 st. every 8th row 17x, every 6th row 4x. Knit to Row 190.
 SHAPE CAP: ON EACH SIDE, bind off 3 sts. 1x, 2 sts. 2x, *1 st. 1x, 2 sts. 1x, and REPEAT from * 8x (9x) [10x] more, 3 sts. 4x.
 After Row 240 (244) [248], bind off the remaining 10 sts.

DK 250

WOMAN'S SKIRT

SIZE: 8/10 (12/14) [16/18]
 YARN:
 color 1 Beatrice
 color 2 Capriccio
 GRAMS:
 color 1 300 350 400
 color 2 100 150 150
 TENSION: 5 to 7
 GAUGE: 15 sts. 20 rows = 5 cm (2")



560

A Norwegian Design that follows the Line Drawing or use JAC 40 and Pattern No. 560.

FINISHING: See General Instructions. Fold belt in half over 2" stiffening and weave seam together. Make crochet casing for top of skirt then thread elastic through. Make carriers on skirt for belt (see picture). Sew buckle to belt.

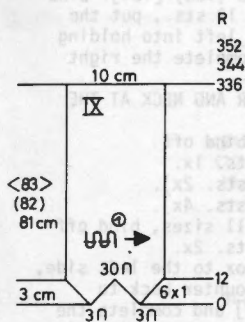
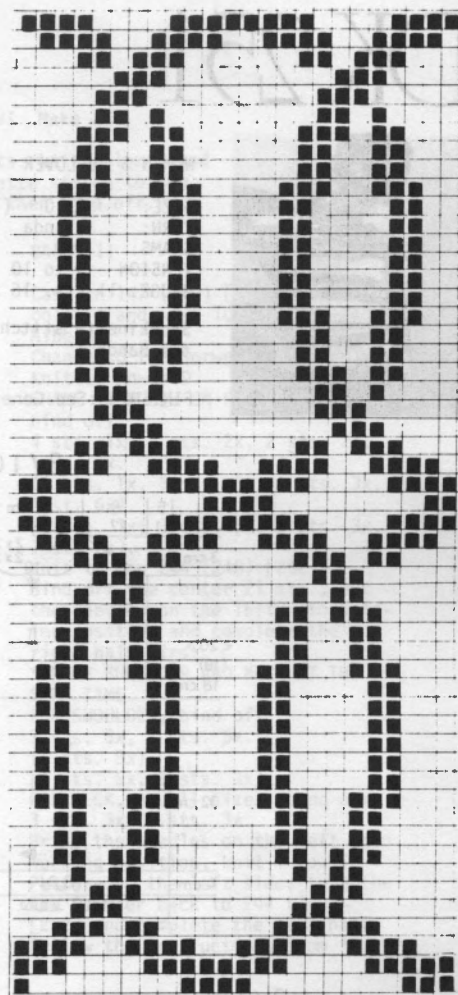

BELT: IX

Cast on 3 sts. with color 1 and work Stockinette stitch.
 ON EACH SIDE, increase 1 st. 6x, then put these 15 sts. into holding position and directly on the right of these sts. leave 6 empty needles and cast on over the next 3 needles. Counter at 0.
 ON EACH SIDE, increase 1 st. 6x. After Row 12, bring all the needles into working position and knit to Row 336 (344) [352] then bind off the 30 sts.

8/10

(12/14)

[16/18]

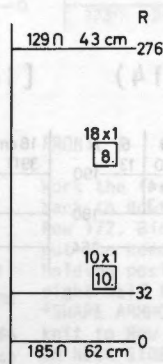
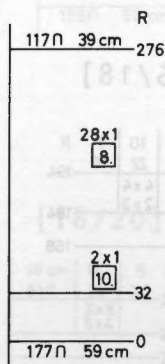
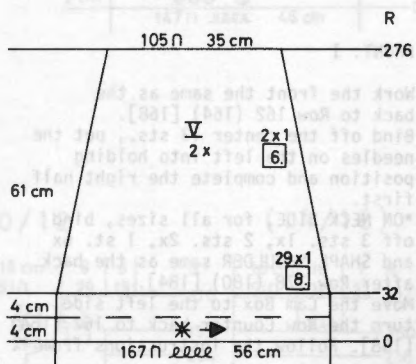

BACK & FRONT: V

Cast on 167 (177) [185] sts. with color 1 and work the Norwegian Design. Knit to Row 32.
 ON EACH SIDE, decrease 1 st. every 8th row 29x, every 6th row 28x. (every 10th row 2x, every 8th row 28x).
 [every 10th row 10x, every 8th row 18x].
 Knit to Row 276 then bind off.

□ color 2
 ■ color 1

The Hand Knitting Machine with the most advanced automatic pattern selector

- 1 Lace designs
- 2 Weaving designs
- 3 Holding Position designs
- 4 Multi-color designs
- 5 Raised designs
- 6 Eyelet designs
- 7 Jacquard designs

Knit - Purl
 and fancy
 ribbed patterns

All knitted automatically without combs or weights. A multitude of fancy ribbed designs can be obtained with the cam operated push button controls.

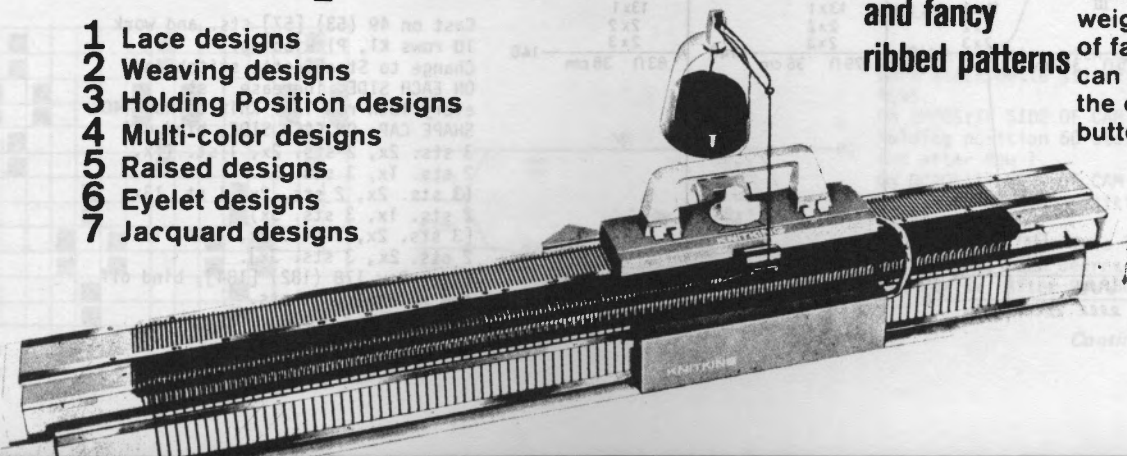

DK 251



WOMAN'S PULLOVER

SIZE: 8/10 (12/14) [16/18]
 YARN: Alanda
 GRAMS: 300 350 400
 TENSION 9 to 10
 GAUGE: 11 sts. 16 rows = 5 cm (2")

Stockinette stitch with K1,P1 for the Bands.

FINISHING: See General Instructions.

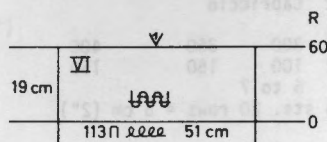

COLLAR: VI

Cast on 113 sts. and work 60 rows K1, P1 Ribbing then bind off the crochet method for Ribbing.

BACK: II

Cast on 95 (105) [115] sts. and work 14 rows K1, P1 Ribbing. Change to Stockinette stitch and knit to Row 120.

SHAPE ARMHOLE: ON EACH SIDE, bind off 3 sts. 1x, 2 sts. 2x, 1 st. 4x. (3 sts. 1x, 2 sts. 3x, 1 st. 4x). [3 sts. 2x, 2 sts. 2x, 1 st. 6x]. Knit to Row 178 (180) [184]. Bind off the center 19 sts., put the needles on the left into holding position and complete the right half first.

*SHAPE SHOULDER AND NECK AT THE SAME TIME.

FOR SHOULDER, bind off

2 sts. 5x, 3 sts. 1x.

(3 sts. 4x, 4 sts. 2x).

[3 sts. 2x, 4 sts. 4x].

FOR NECK, on all sizes, bind off

3 sts. 2x, 2 sts. 2x.

Move the Cam Box to the left side, turn the Row Counter back to 178 (180) [184] and complete the left half. Follow the instructions from *.

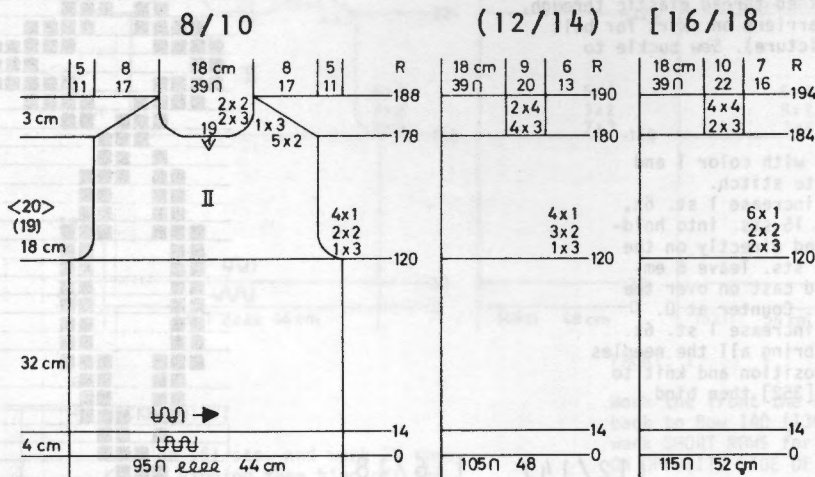

8/10 (12/14) [16/18]

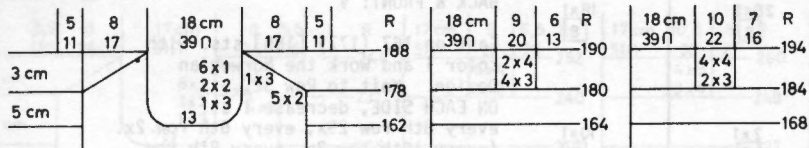

FRONT: I

Work the front the same as the back to Row 162 (164) [168].

Bind off the center 13 sts., put the needles on the left into holding position and complete the right half first.

*ON NECK SIDE, for all sizes, bind off 3 sts. 1x, 2 sts. 2x, 1 st. 6x and SHAPE SHOULDER same as the back after Row 178 (180) [184].

Move the Cam Box to the left side, turn the Row Counter back to 162 (164) [168]. Follow the instructions from *.

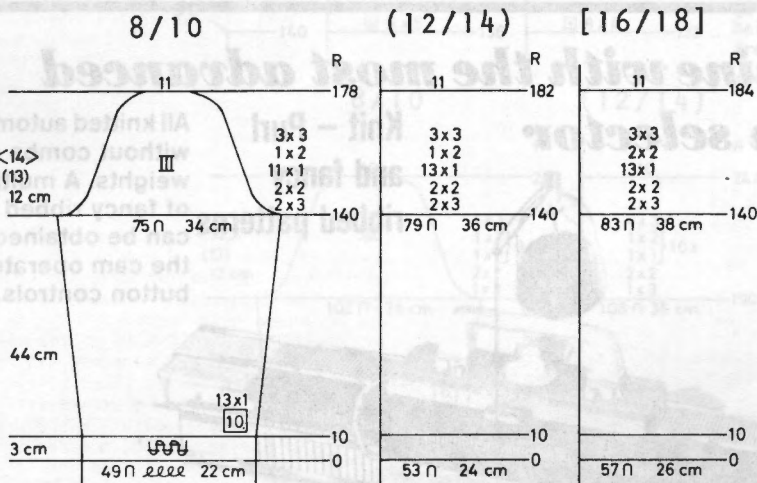

SLEEVE: III

Cast on 49 (53) [57] sts. and work 10 rows K1, P1 Ribbing.

Change to Stockinette stitch and ON EACH SIDE, increase 1 st. every 10th row 13x. Knit to Row 140.

SHAPE CAP: ON EACH SIDE, bind off

3 sts. 2x, 2 sts. 2x, 1 st. 11x,

2 sts. 1x, 3 sts. 3x.

(3 sts. 2x, 2 sts. 2x, 1 st. 13x,

2 sts. 1x, 3 sts. 3x).

[3 sts. 2x, 2 sts. 2x, 1 st. 13x,

2 sts. 2x, 3 sts. 3x].

After Row 178 (182) [184], bind off the remaining 11 sts.

DK 252



WOMAN'S PULLOVER

SIZE: 10/12 (14/16) [18/20]
 YARN: Crocus
 GRAMS
 color 1 400 450 500
 color 2 250 300 350
 TENSION: 5 to 7
 GAUGE: 16 sts. 22 rows = 5 cm (2")

A Norwegian Design with K1, P1 Ribbing for the sleeve and lower band. Follow the Line Drawing for Pattern or you can punch your own card.

FINISHING: See General Instructions.

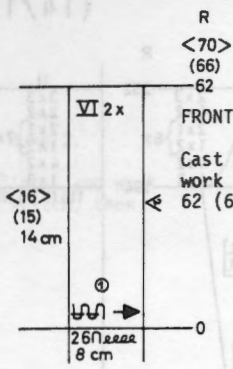

R
 <70>
 (66)
 62

FRONT BAND: VI Make 2.

Cast on 26 sts. with color 1 and work Stockinette stitch to Row 62 (66) [70] then bind off.

BACK: II

Cast on 147 (159) [173] sts. with color 1 and work 10 rows K1, P1 Ribbing.

Change to the Norwegian Design. Knit to Row 160.

SHAPE ARMHOLE: ON EACH SIDE, bind off

4 sts. 1x, 3 sts. 2x, 2 sts. 2x, 1 st. 5x.
 (4 sts. 1x, 3 sts. 2x, 2 sts. 3x, 1 st. 6x).
 [4 sts. 1x, 3 sts. 3x, 2 sts. 3x, 1 st. 7x].

Knit to Row 244 (248) [252]. Bind off the center 21 sts., put the needles on the left into holding position and complete the right half first.

*SHAPE SHOULDER AND NECK AT THE SAME TIME.

FOR SHOULDER, bind off

3 sts. 3x, 4 sts. 5x. (4 sts. 8x).

FOR NECK, on all sizes, bind off 3 sts. 3x, 2 sts. 3x.

Bring the needles on the left into working position, knit 1 row in Pattern to the left side, turn the Row Counter back to 244 (248) [252] and complete the left half. Follow the instructions from *.

10/12

(14/16) [18/20]

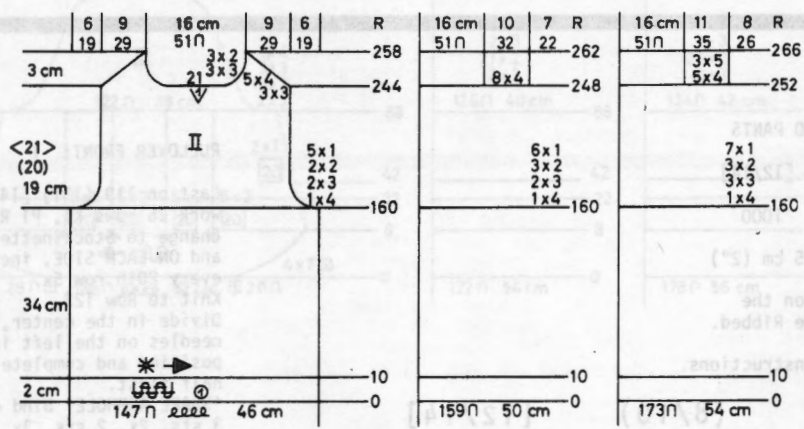

FRONT: I

Work the front the same as the back to Row 160, then knit to Row 172. Bind off the center 13 sts. put the needles on the left into holding position and complete the right half first.

*SHAPE ARMHOLE same as the back then knit to Row 233 (237) [241].

ON NECK SIDE, for all sizes, bind off 3 sts. 2x, 2 sts. 3x, 1 st. 7x and

SHAPE SHOULDER same as the back after Row 256 (260) [264].

Bring the needles on the left into working position, knit 1 row in Pattern to the left side, turn the Row Counter back to 172 and complete the left half. Follow the instructions from *.

10/12

(14/16) [18/20]

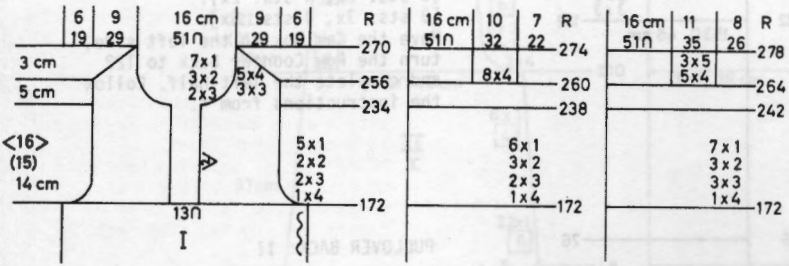

COLLAR: VI

Cast on 151 sts. with color 1 and work Stockinette stitch with SHORT ROWS.

ON OPPOSITE SIDE OF CAM BOX, put into holding position 60 sts. at Row 0 and after Row 1.

ON OPPOSITE SIDE OF CAM BOX, bring back into working position, 20 sts. 3x ON EACH SIDE.

ON EACH SIDE, increase 1 st. every 6th row 6x, then decrease 1 st. every 6th row 6x. After Row 80, bind off.

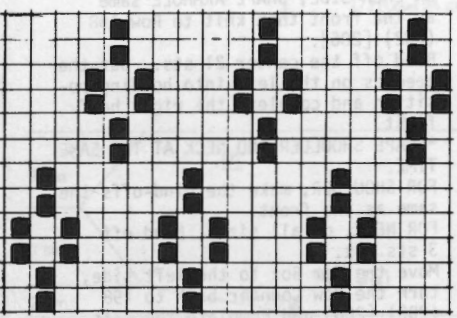
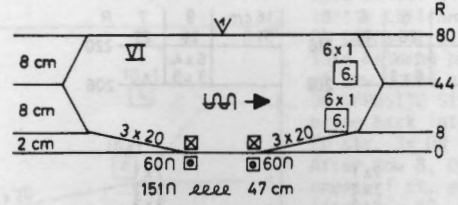

■ color 1
 □ color 2

Continued

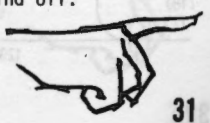

DK 252

10/12

(14/16)

[18/20]

SLEEVE: III

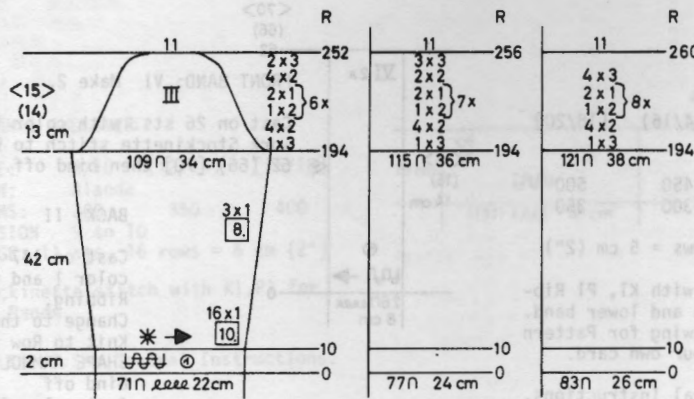

Cast on 71 (77) [83] sts. with color 1 and work 10 rows K1, P1 Ribbing. Change to the Norwegian Design and ON EACH SIDE, increase 1 st. every 10th row 16x, every 8th row 3x. Knit to Row 194.
 SHAPE CAP: ON EACH SIDE, bind off 3 sts. 1x, 2 sts. 4x, *2 sts. 1x, 1 st. 2x and REPEAT from * 5x more, 2 sts. 4x, 3 sts. 2x. (3 sts. 1x, 2 sts. 4x, *2 sts. 1x, 1 st. 2x and REPEAT from * 6x more, 2 sts. 2x, 3 sts. 3x). [3 sts. 1x, 2 sts. 4x, *2 sts. 1x, 1 st. 2x, and REPEAT from * 7x more, 3 sts. 4x].
 After Row 252 (256) [260], bind off the remaining 11 sts.

DK 253



WOMAN'S PULLOVER & GAUCHO PANTS

SIZE: 6/7 (8/10) [12/14]
 YARN: Crocus
 GRAMS: 850 900 1000
 TENSION: 5 to 7
 GAUGE: 16 sts. 22 rows = 5 cm (2")

Stockinette stitch worn on the Purl side. The bands are Ribbed.

FINISHING: See General Instructions.

PULLOVER FRONT: I

Cast on 119 (131) [143] sts. and work 26 rows K1, P1 Ribbing. Change to Stockinette stitch and ON EACH SIDE, increase 1 st. every 20th row 5x. Knit to Row 122.
 Divide in the center, put the needles on the left into holding position and complete the right half first.
 *SHAPE ARMHOLE; bind off 3 sts. 2x, 2 sts. 3x, 1 st. 4x. (3 sts. 2x, 2 sts. 3x, 1 st. 7x). [3 sts. 3x, 2 sts. 3x, 1 st. 7x]. Knit to Row 179 (183) [187].
 ON NECK SIDE, for all sizes, bind off 8 sts. 1x (9 sts. for left half) 3 sts. 1x, 2 sts. 4x, 1 st. 6x, and SHAPE SHOULDER after Row 198 (202) [206] by binding off 2 sts. 1x, 3 sts. 7x. (3 sts. 6x, 4 sts. 2x). [3 sts. 3x, 4 sts. 5x].
 Move the Cam Box to the left side, turn the Row Counter back to 122 and complete the left half. Follow the instructions from *.

6/7

(8/10)

[12/14]

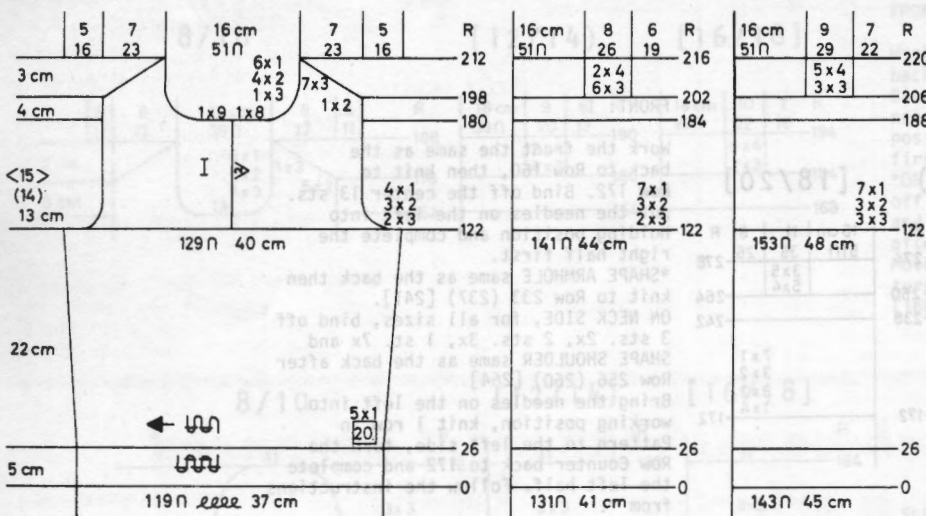

PULLOVER BACK: II

Work the back section the same as the front to Row 122.
 ON EACH SIDE, SHAPE ARMHOLE same as the front then knit to Row 198 (202) [206].
 Bind off the center 21 sts., put the needles on the left into holding position and complete the right half first.
 *SHAPE SHOULDER AND NECK AT THE SAME TIME.
 FOR SHOULDER, make the bind-offs the same as the front.
 FOR NECK, on all sizes, bind off 3 sts. 5x.
 Move the Cam Box to the left side, turn the Row Counter back to 198 (202) [206] and complete the left half. Follow the instructions from *.

6/7

(8/10)

[12/14]

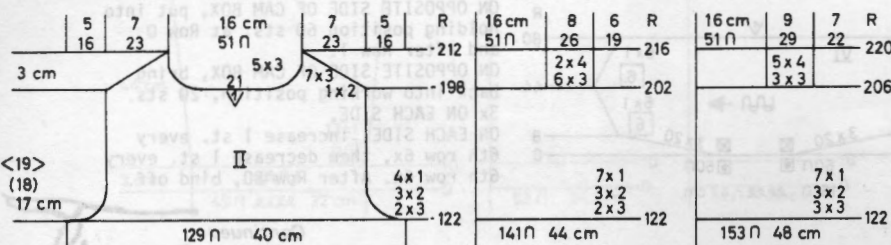

SLEEVE: III

NOTE: To make the 8 stitch decreases 5x, you can follow the Chart or you may remove the stitches onto contrast waste yarn, hang them back onto machine and decrease 8 sts. evenly across, then on the following 8 stitch decrease rows, space the decreases between the previous ones so that they are not on top of one another.

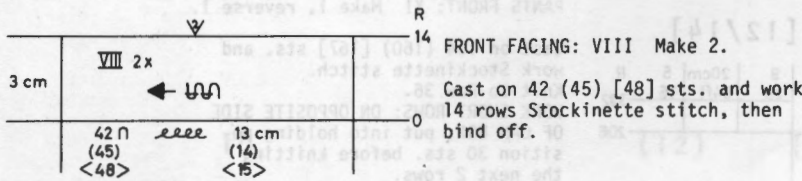

Cast on 166 (172) [178] sts. and work Stockinette stitch and SHORT ROWS.
ON OPPOSITE SIDE OF CAM BOX, put into holding position 28 sts. at Row 0 and after Row 1.
ON OPPOSITE SIDE OF CAM BOX, bring back into working position 7 sts. 4x ON EACH SIDE.
After Row 8, begin the DART decreases as above NOTE - OR - ON EACH SIDE, hang the 32nd and 34th sts. onto the 33rd st. the 65th and 67th sts. onto the 66th st. and move the sts. in to fill the empty needles. Make the following DART decreases directly above on every 20th row 4x more AND AT THE SAME TIME, after Row 42, ON EACH SIDE, decrease 1 st. every 20th row 2x.
After Row 88, SHAPE CAP: ON EACH SIDE, bind off 3 sts. 2x, 2 sts. 18x, 3 sts. 3x, 4 sts. 1x.
(3 sts. 2x, 2 sts. 21x, 3 sts. 2x, 4 sts. 1x).
[3 sts. 2x, 2 sts. 23x, 3 sts. 3x].
After Row 136 (140) [144], bind off the remaining 12 sts.

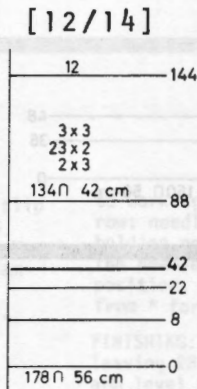
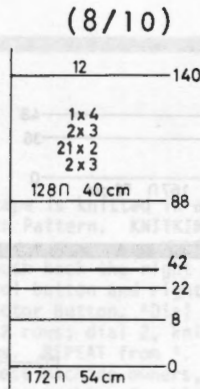
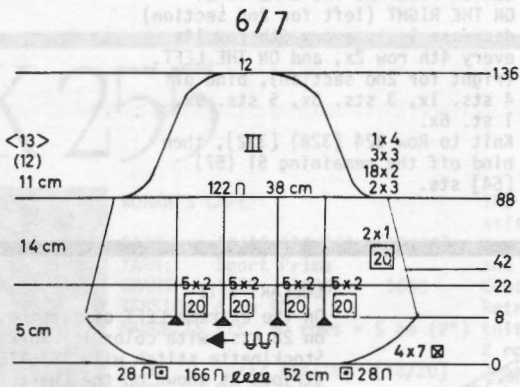

PANTS BACK: XII Make 1, reverse 1.

Cast on 173 (179) [189] sts. and work Stockinette stitch.
Knit to Row 36.
Work SHORT ROWS: ON OPPOSITE SIDE OF CAM BOX, put into holding position 30 sts. before knitting the next 2 rows.
ON OPPOSITE SIDE OF CAM BOX, bring back into working position 5 sts. 6x ON EACH SIDE.
After Row 48, ON EACH SIDE, decrease 1 st. every 6th row 23x, every 4th row 6x. Knit to Row 210.
SHAPE CENTER BACK AND SIDE EDGE AT THE SAME TIME.
ON THE LEFT SIDE (right for 2nd section) decrease 1 st. every 6th row 14x, every 4th row 2x.
ON THE RIGHT SIDE (left for 2nd section) bind off 4 sts. 3x, 3 sts. 4x, 2 sts. 6x, 1 st. every 6th row 12x.
After Row 298 (302) [306], work SHORT ROWS.
ON OPPOSITE SIDE OF CAM BOX, put into holding position 7 sts. 6x. Bring all the needles back into working position before knitting the next row. Knit to Row 336 (340) [344]. Bind off the remaining 51 (57) [64] sts.

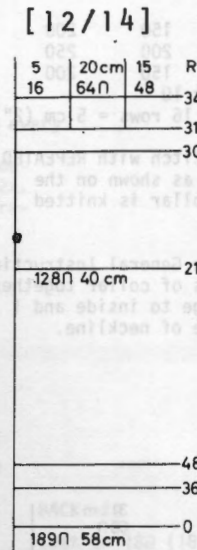
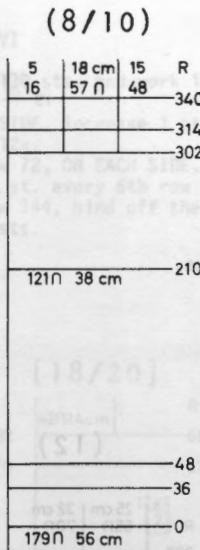
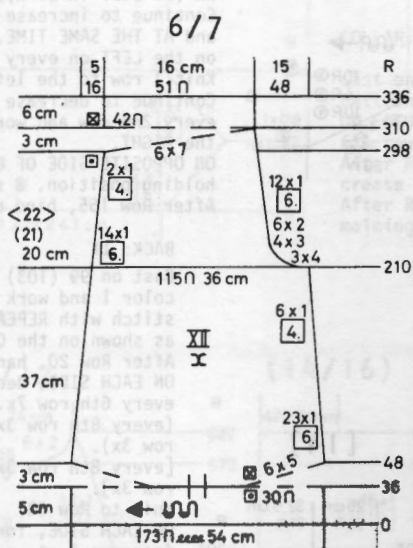

COLLAR: VI

Cast on 151 sts. and work Stockinette stitch and SHORT ROWS.
ON OPPOSITE SIDE OF CAM BOX, put into holding position 60 sts. at Row 0 and after Row 1.
ON OPPOSITE SIDE OF CAM BOX, bring back into working position, 20 sts. 3x ON EACH SIDE.
After Row 8, ON EACH SIDE, increase 1 st. every 4th row 10x.
After Row 48, ON EACH SIDE, decrease 1 st. every 4th row 10x.
After Row 96, bind off all sts.

Continued

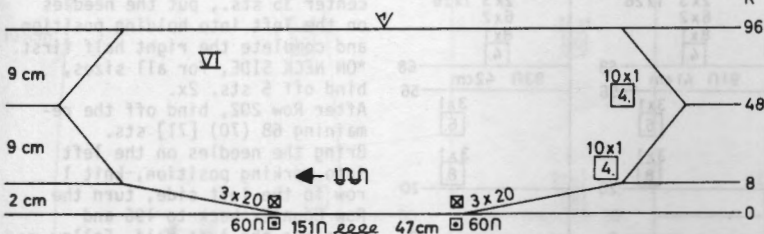

DK 253

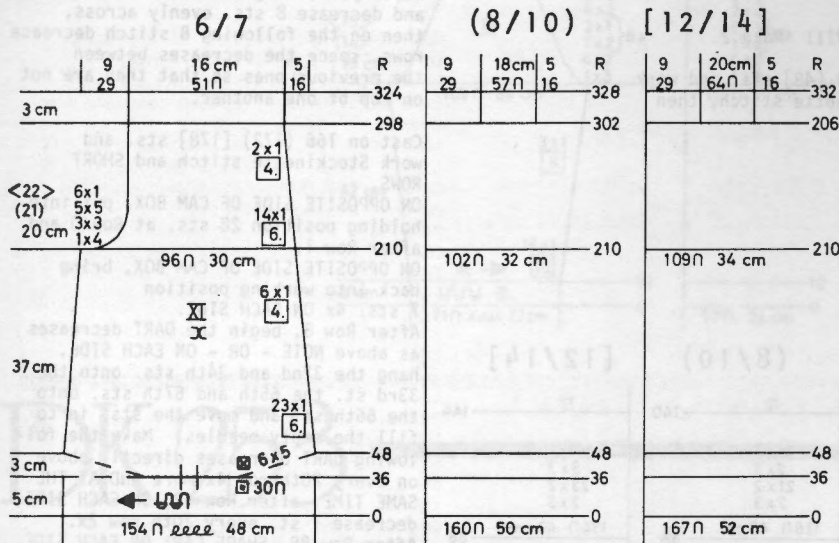

PANTS FRONT: XI Make 1, reverse 1.

Cast on 154 (160) [167] sts. and work Stockinette stitch.
 Knit to Row 36.
WORK SHORT ROWS: ON OPPOSITE SIDE OF CAM BOX, put into holding position 30 sts. before knitting the next 2 rows.
ON OPPOSITE SIDE OF CAM BOX, bring back into working position 5 sts. 6x ON EACH SIDE.
 After Row 48, ON EACH SIDE, decrease 1 st. every 6th row 23x, every 4th row 6x.
 After Row 210 SHAPE SIDE EDGE AND CENTER FRONT AT THE SAME TIME.
ON THE RIGHT (left for 2nd section) decrease 1 st. every 6th. row 14x, every 4th row 2x, and ON THE LEFT (right for 2nd section), bind off 4 sts. 1x, 3 sts. 3x, 5 sts. 5x, 1 st. 6x.
 Knit to Row 324 (328) [332], then bind off the remaining 51 (57) [64] sts.

DK 254



WOMAN'S PULLOVER

SIZE: 10 (12) [14]
 YARN: color 1 Alanda
 color 2 Alanda tweed
 color 3 Alanda
 GRAMS: color 1 100 150 200
 color 2 150 200 250
 color 3 100 150 200
 TENSION: 9 or 10
 GAUGE: 11 sts. 16 rows = 5 cm (2")

Stockinette stitch with REPEATED color stripes as shown on the Chart. The collar is knitted on the bias.

FINISHING: See General Instructions. Sew short ends of collar together then sew 1 edge to inside and 1 to the outside of neckline.

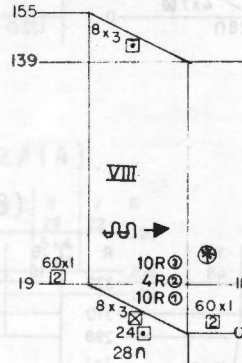

COLLAR: VIII

On the extreme LEFT of machine, cast on 28 sts. with color 1. Work Stockinette stitch with REPEATED color stripes as shown on the Chart.
ON OPPOSITE SIDE OF CAM BOX, put into holding position, 24 sts. Knit 2 rows. ON THE RIGHT SIDE, increase 1 st. after Row 2 and every 2nd row 60x in all and AT THE SAME TIME, on the LEFT, bring back into working position 3 sts. 8x (36 sts. in work).
 Continue to increase 1 st. on the RIGHT and AT THE SAME TIME, decrease 1 st. on the LEFT on every 2nd row to Row 138. Knit 1 row to the left side.
 Continue to decrease 1 st. on the LEFT every 2nd row and work SHORT ROWS on the RIGHT.
ON OPPOSITE SIDE OF CAM BOX, put into holding position, 3 sts. 8x. After Row 155, bind off 28 sts.

BACK: II

Cast on 99 (103) [105] sts. with color 1 and work Stockinette stitch with REPEATED color stripes as shown on the Chart.
 After Row 20, hang the hem.
ON EACH SIDE, decrease 1 st. every 6th row 7x. (every 8th row 3x, every 6th row 3x).
 [every 8th row 3x, every 6th row 3x].
 Knit to Row 68.
ON EACH SIDE, for all sizes, increase 1 st. every 4th row 8x, then cast on 2 sts. 6x, 3 sts. 2x, then 27 (26) [26] sts. 1x. Knit to Row 196. Bind off the center 35 sts., put the needles on the left into holding position and complete the right half first.
***ON NECK SIDE, for all sizes, bind off 5 sts. 2x.**
 After Row 202, bind off the remaining 68 (70) [71] sts.
 Bring the needles on the left into working position, knit 1 row to the left side, turn the Row Counter back to 196 and complete the left half. Follow the instructions from *.

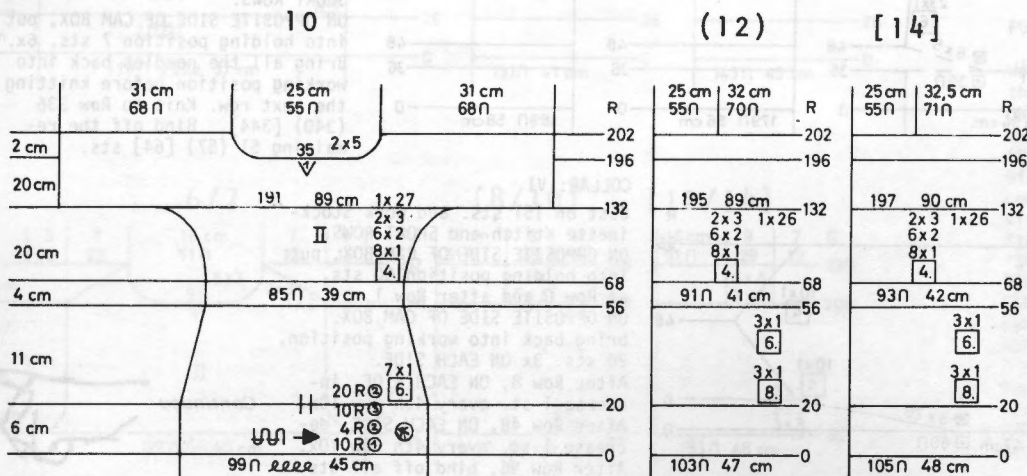

FRONT: I

Work the front the same as the back to Row 164. Bind off the center 21 sts., put the needles on the left into holding position and complete the right half first.

*ON NECK SIDE, for all sizes, bind off 3 sts. 2x, 2 sts. 2x, 1 st. 7x.

Knit to Row 202 and bind off the remaining 68 (70) [71] sts.

Bring the needles on the left into working position, knit 1 row to the left side, turn the Row Counter back to 164 and complete the left half. Follow the instructions from *.

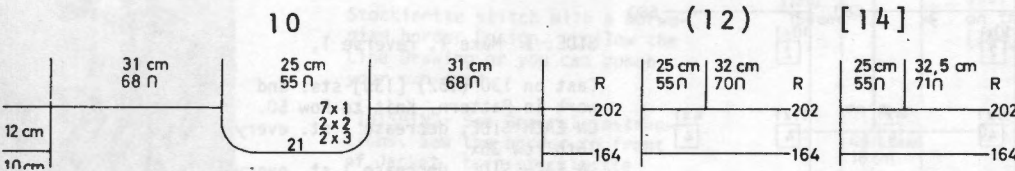

DK 255



WOMAN'S CAPE

SIZE: 10/12 (14/16) [18/20]
 YARN: Sport Prima
 GRAMS: 1550 1600 1650
 TENSION: 8 to 10
 GAUGE: 15 sts. 30 rows = 5 cm (2")

SIZE: 10/12 (14/16) [18/20]
 YARN: Sport Prima
 GRAMS: 1550 1600 1650
 TENSION: 8 to 10
 GAUGE: 15 sts. 30 rows = 5 cm (2")

The cape is knitted in a slip stitch Pattern. KNITTING machine owners, use WHEEL No. 6 and push back the right Cam Control button and right Retractor Button. *Dial 1, knit 2 rows; dial 2, knit 2 rows. REPEAT from *.

Japanese machine owners, set your machine for Slip Stitch. *Needles 1, 3, 5, etc. go into holding position, knit 1 row; the needles return

to working position, knit 1 row; needles 2, 4, 6 go into holding position, knit 1 row, the needles return to working position, knit 1 row. REPEAT from * for Pattern.

FINISHING: Sew seams together leaving 28 cm (11") open at arm level between front and side sections for arm openings. Work 3 rows single crochet around openings then turn to the inside and hem.

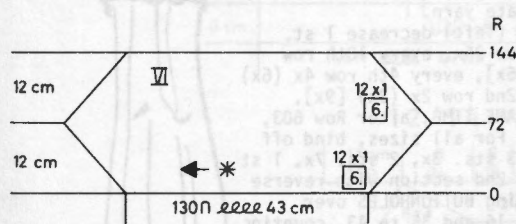

COLLAR: VI

Cast on 130 sts. and work in Pattern. ON EACH SIDE, increase 1 st. every 6th row 12x. After Row 72, ON EACH SIDE, decrease 1 st. every 6th row 12x. After Row 144, bind off the remaining sts.

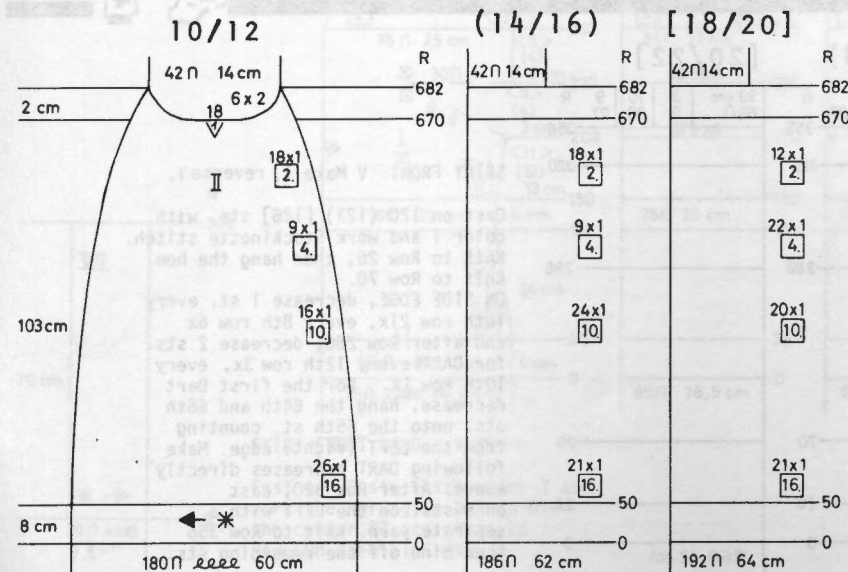

BACK: II

Cast on 180 (186) [192] sts. and work in Pattern. Knit to Row 50. ON EACH SIDE, decrease 1 st. every 16th row 26x (21x) [21x], every 10th row 16x (24x) [20x], every 4th row 9x (9x) [22x], every 2nd row 18x (18x) [12x], AT THE SAME TIME after Row 670, bind off the center 18 sts., put the needles on the left into holding position and complete the right half first.

*ON NECK SIDE, for all sizes, bind off 2 sts. 6x.

Bring the needles on the left into working position, knit 1 row in Pattern to the left side, turn the Row Counter back to 670 and complete the left half. Follow the instructions from *.



Continued

DK 255

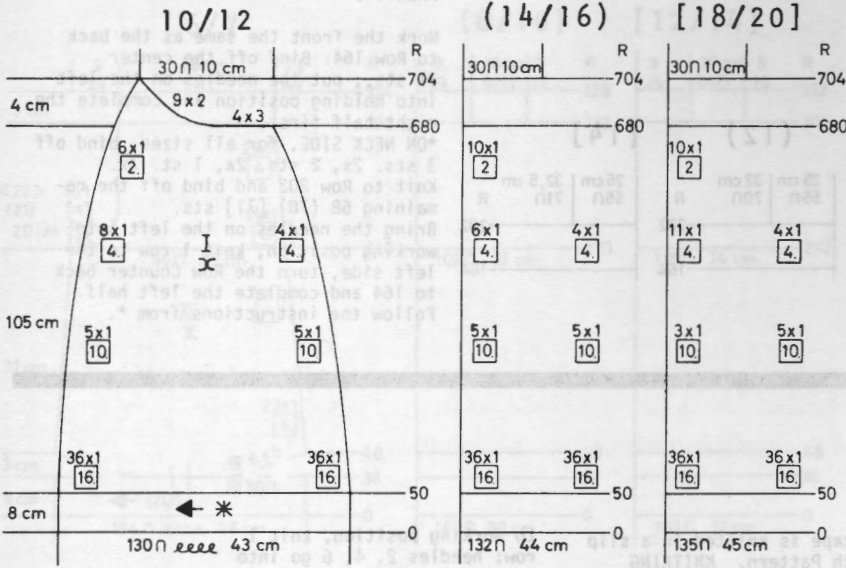

SIDE: I Make 1, reverse 1.

Cast on 130 (132) [135] sts. and work in Pattern. Knit to Row 50.
ON EACH SIDE, decrease 1 st. every 16th row 36x.
ON EACH SIDE, decrease 1 st. every 10th row 5x for the first 2 sizes.
For Size 18/20, ON THE RIGHT (left for 2nd section) decrease 1 st. every 10th row 5x and on the LEFT (right) decrease 1 st. every 10th row 3x.
ON EVERY 4th row, on the RIGHT, (left) decrease 1 st. 4x for all sizes, and on the LEFT (right) decrease 1 st. 8x (6x) [11x], every 2nd row 6x (10x) [10x] and AT THE SAME TIME, after Row 680, ON NECK SIDE for all sizes, bind off 3 sts. 4x, 2 sts. 9x.

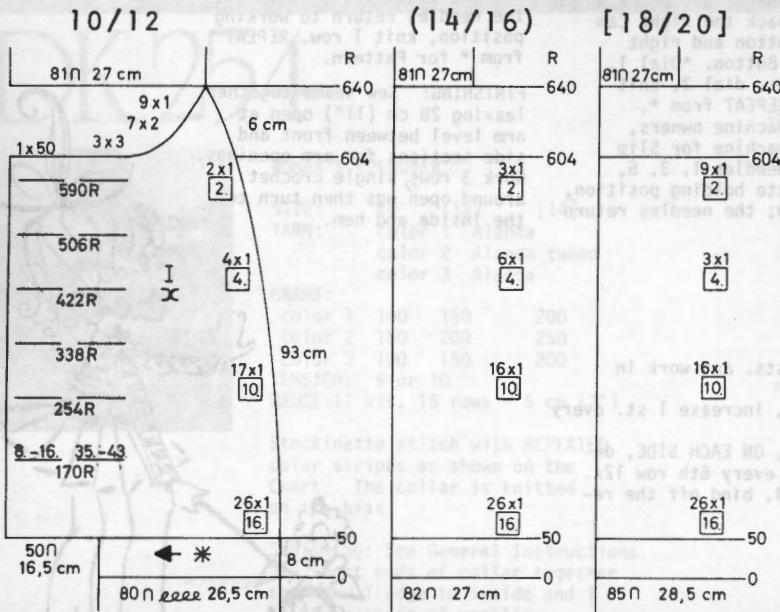

FRONT: I Make 1, reverse 1.
DO NOT MAKE BUTTONHOLES in this section.

Cast on 80 (82) [85] sts. and work in Pattern. Knit to Row 50.
ON THE LEFT (right) cast on 50 sts. with a separate yarn.
ON THE RIGHT (left) decrease 1 st. every 16th row 26x, every 10th row 17x (16x) [16x], every 4th row 4x (6x) [3x], every 2nd row 2x (3x) [9x], and AT THE SAME TIME, after Row 603, SHAPE NECK. For all sizes, bind off 50 sts. 1x, 3 sts. 3x, 2 sts. 7x, 1 st 9x. Work the 2nd section with reverse shaping, making BUTTONHOLES over needles 8 to 16 and 35 to 43, counting from the RIGHT edge after Rows 170, 254, 338, 422, 506, 590.

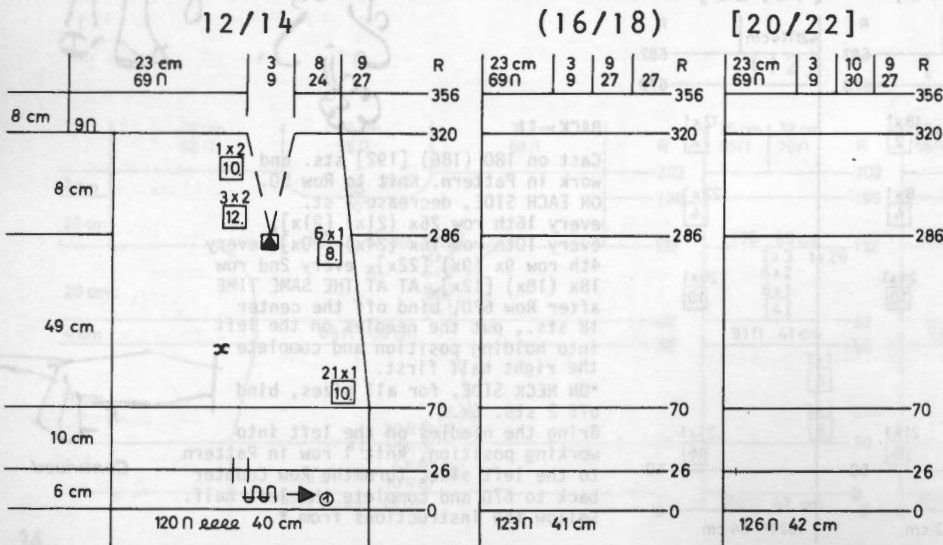

SKIRT FRONT: V Make 1, reverse 1.

Cast on 120 (123) [126] sts. with color 1 and work Stockinette stitch. Knit to Row 26, then hang the hem. Knit to Row 70.
ON SIDE EDGE, decrease 1 st. every 10th row 21x, every 8th row 6x and after Row 286, decrease 2 sts. for DART every 12th row 3x, every 10th row 1x. For the first Dart decrease, hang the 64th and 66th sts. onto the 65th st. counting from the LEFT (right) edge. Make following DART decreases directly above. After Row 320, cast on 9 sts. on the LEFT with a separate yarn. Knit to Row 356 then bind off the remaining sts.

DK 256

WOMAN'S 2-PIECE SUIT

SIZE: 12/14 (16/18) [20/22]
 YARN: Beatrice
 GRAMS:
 color 1 1050 1100 1150
 color 2 250 300 350
 TENSION: 4 to 6
 GAUGE: 15 sts. 22 rows = 5 cm (2")

Stockinette stitch with a Norwegian border Design. Follow the Line Drawing or you can punch your own card.

FINISHING: See General Instructions. Sew the border to front of Jacket, turn stockinette section to the inside and sew in place. Sew the border design to the right front section.

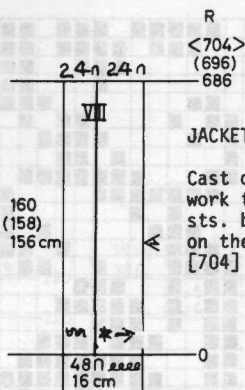

JACKET FRONT BAND: VIII

Cast on 48 sts. with color 1 and work the Norwegian Design over 23 sts. beginning with the 2nd needle on the Right. Knit to Row 686 (696) [704] then bind off.

JACKET BACK: II

Cast on 146 (158) [176] sts. with color 1 and work Stockinette stitch.

Knit to Row 26. Hang the hem. ON EACH SIDE, decrease 1 st. every 12th row 8x, every 10th row 2x.

Knit to Row 150. ON EACH SIDE, increase 1 st. every 12th row 6x.

Knit to Row 220.

SHAPE ARMHOLE: ON EACH SIDE, bind off

3 sts. 2x, 2 sts. 3x, 1 st. 6x. (3 sts. 2x, 2 sts. 4x, 1 st. 7x). [3 sts. 3x, 2 sts. 5x, 1 st. 7x].

Knit to Row 304 (308) [312]. Bind off the center 26 sts., put the needles on the left into holding position and complete the right half first.

*SHAPE SHOULDER AND NECK AT THE SAME TIME.

FOR SHOULDER, bind off

3 sts. 8x.

(3 sts. 5x, 4 sts. 3x).

[3 sts. 1x, 4 sts. 7x].

FOR NECK, on all sizes, bind off

3 sts. 2x, 4 sts. 2x.

Move the Cam Box to the left side,

turn the Row Counter back to

304 (308) [312] and complete the

left half. Follow the instructions

from *.

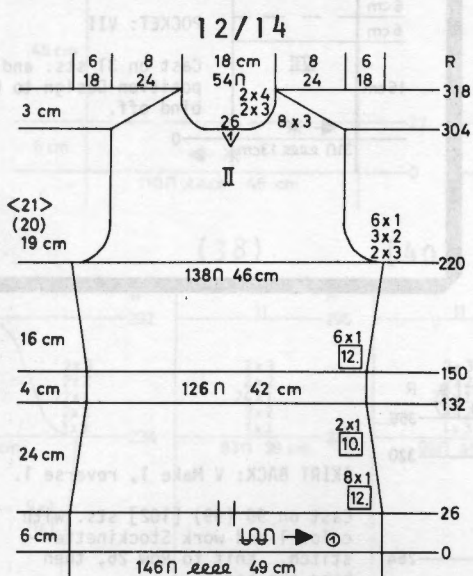

(16/18)

[20/22]

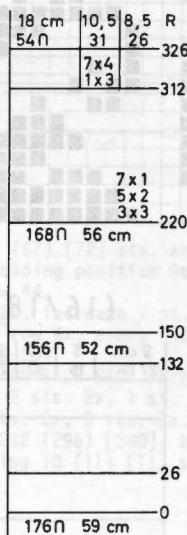
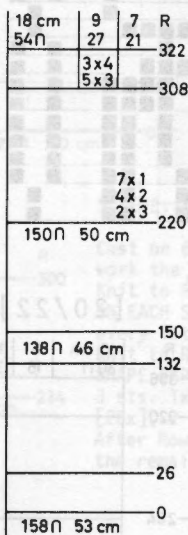

12/14

(16/18)

[20/22]

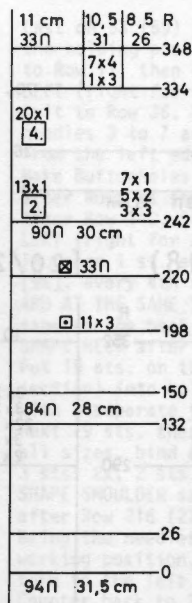
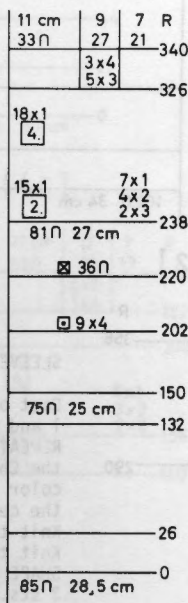
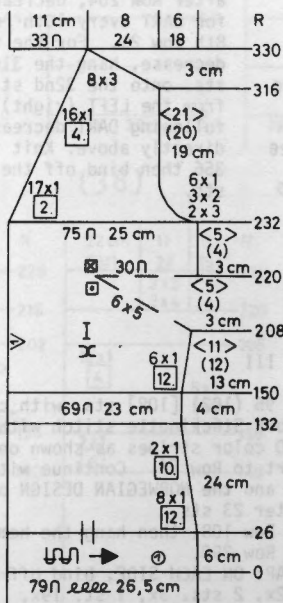

JACKET FRONT: I Make 1, reverse 1.

Cast on 79 (85) [94] sts. with color 1 and work Stockinette stitch.

Knit to Row 26. Hang the hem.

ON SIDE EDGE, decrease 1 st. every 12th row 8x, every 10th row 2x.

Knit to Row 150.

ON SIDE EDGE, increase 1 st. every 12th row 6x and AFTER ROW 207 (201) [197], work SHORT ROWS for the BUST DART.

ON OPPOSITE SIDE OF CAM BOX, put into holding position

5 sts. 6x.

(4 sts. 9x).

[3 sts. 11x].

Bring all the needles back into working position before knitting the next row.

After Row 232 (238) [242], SHAPE ARMHOLE same as the back and AT THE SAME TIME, ON NECK SIDE, decrease 1 st.

every 2nd row 17x (15x) [13x], every 4th row 16x (18x) [20x] and SHAPE SHOULDER same as the back after Row

316 (326) [334].

SKIRT FRONT BAND: VIII

Cast on 29 sts. with color 1 and work the Norwegian Design over the center 23 sts. Knit to Row 308 then bind off.

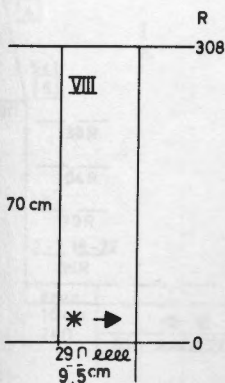

Continued

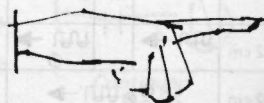

DK 256

□ color 1
■ color 2

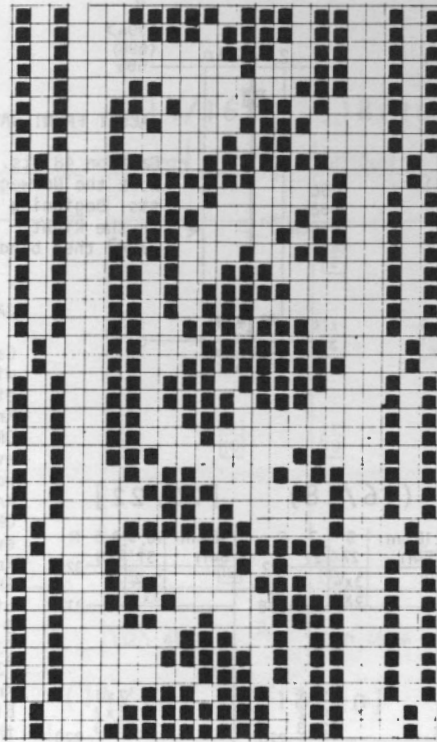

HP 258



MAN'S JACKET

SIZE: 34 (38) [40]
YARN: Sport Prima
GRAMS: 850 900 950
TENSION: 9 or 10
GAUGE: 12 sts. 22 rows = 5 cm (2")

A Holding Position Design worn on the Purl side. KNITTING machine owners use WHEEL NO. 2. Follow the Line Drawing.

FINISHING: See General Instructions

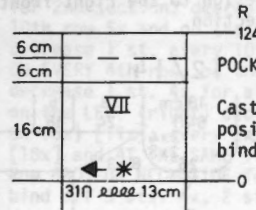

POCKET: VII

Cast on 31 sts. and work the holding position Design to Row 124, then bind off.

12/14

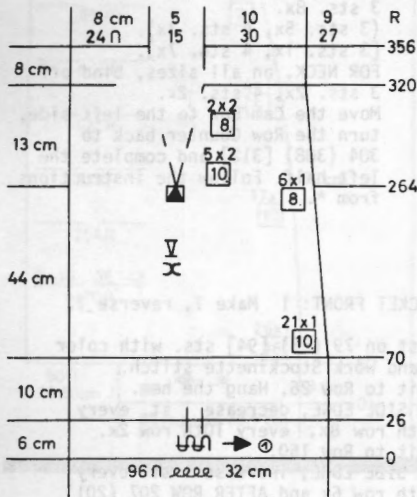

(16/18)

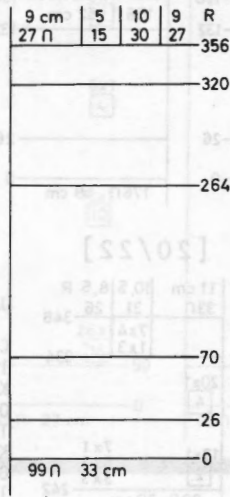

[20/22]

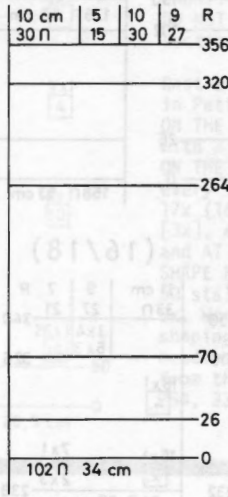

SKIRT BACK: V Make 1, reverse 1.

Cast on 96 (99) [102] sts. with color 1 and work Stockinette stitch. Knit to Row 26, then hang the hem.
ON SIDE EDGE, decrease 1 st. every 10th row 21x, every 8th row 6x and after Row 264, decrease 2 sts. for DART every 10th row 5x, every 8th row 2x. For the first DART decrease, hang the 31st and 33rd sts. onto the 32nd st. counting from the LEFT (right) edge. The following DART decreases lie directly above. Knit to Row 356 then bind off the remaining sts.

12/14

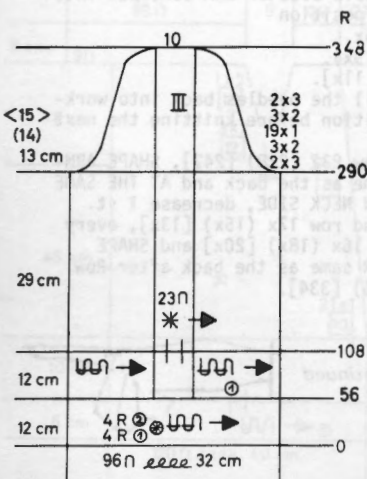

(16/18)

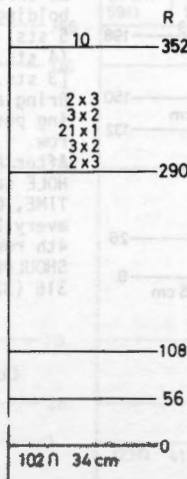

[20/22]

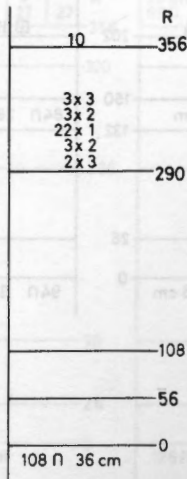

SLEEVE: III

Cast on 96 (102) [108] sts. with color 1 and work Stockinette stitch with REPEATED color stripes as shown on the Chart to Row 56. Continue with color 1 and the NORWEGIAN DESIGN over the center 23 sts. Knit to Row 108, then hang the hem. Knit to Row 290.
SHAPE CAP: ON EACH SIDE, bind off 3 sts. 2x, 2 sts. 3x, 1 st. 19x, 2 sts. 3x, 3 sts. 2x. (3 sts. 2x, 2 sts. 3x, 1 st. 21x, 2 sts. 3x, 3 sts. 2x). [3 sts. 2x, 2 sts. 3x, 1 st. 22x, 2 sts. 3x, 3 sts. 3x]. After Row 348 (352) [356], bind off the remaining sts.



BACK: II

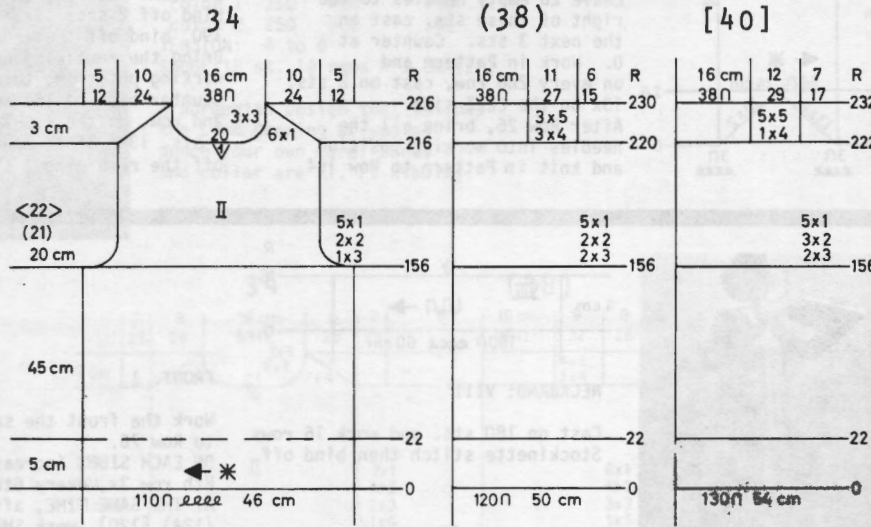

Cast on 110 (120) [130] sts. and work the holding position Design. Knit to Row 156.
 SHAPE ARMHOLE: ON EACH SIDE, bind off 3 sts. 1x, 2 sts. 2x, 1 st. 5x. (3 sts. 2x, 2 sts. 2x, 1 st. 5x). [3 sts. 2x, 2 sts. 3x, 1 st. 5x]. Knit to Row 216 (220) [222]. Bind off the center 20 sts., put the needles on the left into holding position and complete the right half first.
 *SHAPE SHOULDER AND NECK AT THE SAME TIME.
 FOR SHOULDER, bind off 4 sts. 6x (4 sts. 3x, 5 sts. 3x). [4 sts. 1x, 5 sts. 5x].
 FOR NECK, on all sizes, bind off 3 sts. 3x.
 Bring the needles on the left into working position, knit 1 row in Pattern to the left side, turn the Row Counter back to 216 (220) [222] and complete the left half. Follow the instructions from *.

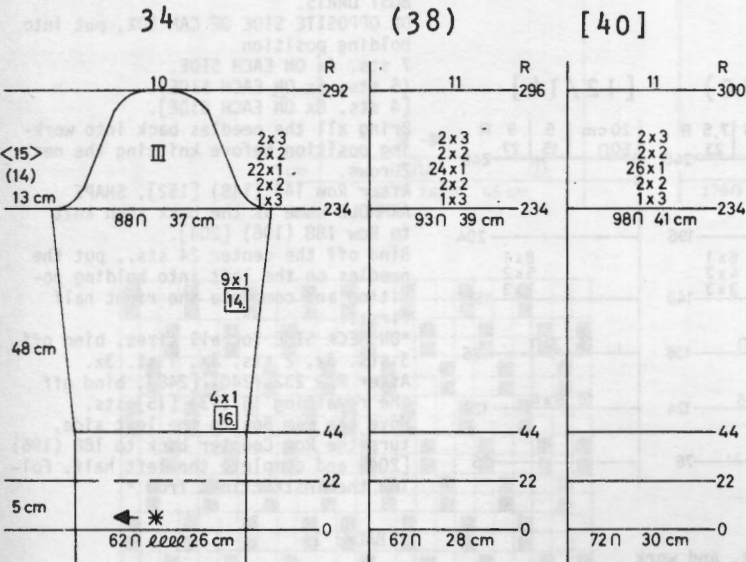

SLEEVE: III

Cast on 62 (67) [72] sts. and work the holding position Design. Knit to Row 44.
 ON EACH SIDE, increase 1 st. every 16th row 4x, every 14th row 9x. Knit to Row 234.
 SHAPE CAP: ON EACH SIDE, bind off 3 sts. 1x, 2 sts. 2x, 1 st. 22x (24x) [26x], 2 sts. 2x, 3 sts. 2x. After Row 292 (296) [300], bind off the remaining 10 (11) [11] sts.

FRONT: I Make 1, reverse 1 and omit the Buttonholes.

Cast on 53 (59) [63] sts. and work the holding position Design. Knit to Row 11, then cast on 24 sts. on the LEFT (right for 2nd section). Knit to Row 36. Make BUTTONHOLES over needles 3 to 7 and 18 to 22 counting from the left edge.
 Make Buttonholes over the same needles after Rows as shown on the Chart. After Row 140, SHAPE FACING on the LEFT (right for 2nd section). Increase 1 st. every 6th row 5x (7x) [9x], every 4th row 14x (12x) [10x] AND AT THE SAME TIME, SHAPE ARMHOLE same as the back after Row 156 and SHAPE NECK after Row 202 (206) [208]. Put 19 sts. on the LEFT (right for 2nd section) into holding position and with a separate yarn, bind off the next 19 sts. then on NECK SIDE for all sizes, bind off 3 sts. 2x, 2 sts. 3x, 1 st. 5x and SHAPE SHOULDER same as the back after Row 216 (220) [222].
 Bring the needles on the left into working position, knit 1 row in Pattern to the left side, turn the Row Counter back to 202 (206) [208] and complete the left half.
 Make the bind-offs for neck same as you did before and don't forget to continue with the increases for the facing. After Row 226 (230) [232], bind off the remaining 7 sts.



Continued

HP 258

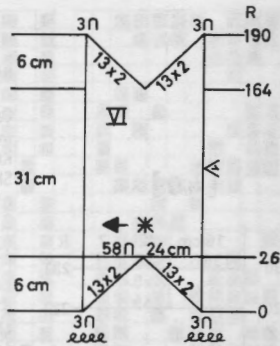

COLLAR: VI

ON THE LEFT SIDE OF 0, leave 26 empty needles, then cast on 3 sts. Work in Pattern.
ON THE RIGHT, on every 2nd row, cast on 2 sts. 13x. Put these sts. into holding position. Leave 26 empty needles to the right of these sts. cast on the next 3 sts. Counter at 0. Work in Pattern and on every 2nd row, cast on 2 sts. 13x on the LEFT side.
After Row 26, bring all the needles into working position and knit in Pattern to Row 164.

Divide in the center and put the needles on the left into holding position and complete the right half first.
ON EVERY 2nd row, on the LEFT, bind off 2 sts. 13x. After Row 190, bind off the remaining 3 sts. Bring the remaining needles into working position, turn the Row Counter back to 164 and on EVERY 2nd row, on the RIGHT, bind off 2 sts. 13x, After Row 190, bind off the remaining 3 sts.

DK 257

WOMAN'S SLEEVELESS PULLOVER

SIZE: 6/7 (8/10) [12/14]
YARN: Beatrice
GRAMS: 250 300 350
TENSION: 4 to 6
GAUGE: 15 sts. 20 rows = 5 cm (2")

Stockinette stitch.

FINISHING: See General Instructions.

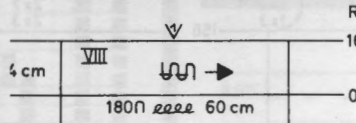

NECKBAND: VIII

Cast on 180 sts. and work 16 rows Stockinette stitch then bind off.

FRONT: I

Work the front the same as the back to Row 76.
ON EACH SIDE, increase 1 st. every 8th row 3x, every 6th row 6x and AT THE SAME TIME, after Row 128 (124) [120], work SHORT ROWS for the BUST DARTS.
ON OPPOSITE SIDE OF CAM BOX, put into holding position
7 sts. 4x ON EACH SIDE.
(5 sts. 6x ON EACH SIDE).
[4 sts. 8x ON EACH SIDE].
Bring all the needles back into working position before knitting the next 2 rows.
After Row 144 (148) [152], SHAPE ARMHOLE same as the back then knit to Row 188 (196) [204].
Bind off the center 24 sts., put the needles on the left into holding position and complete the right half first.
*ON NECK SIDE for all sizes, bind off 3 sts. 3x, 2 sts. 3x, 1 st. 3x.
After Row 232 (240) [248], bind off the remaining 12 (13) [15] sts.
Move the Cam Box to the left side, turn the Row Counter back to 188 (196) [204] and complete the left half. Follow the instructions from *.

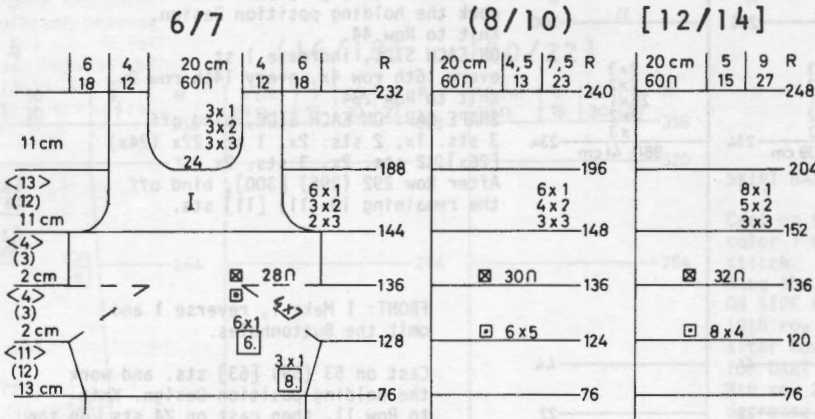

ARMBANDS: VIII Make 2.

Cast on 156 (159) [162] sts. and work 16 rows Stockinette stitch then bind off.

BACK: II

Cast on 120 (132) [144] sts. and work Stockinette stitch.
Knit to Row 16, then hang the hem.
ON EACH SIDE, decrease 1 st. every 6th row 9x.
Knit to Row 76.
ON EACH SIDE, increase 1 st. every 8th row 3x, every 6th row 6x. Knit to Row 136.
SHAPE ARMHOLE: ON EACH SIDE, bind off
3 sts. 2x, 2 sts. 3x, 1 st. 6x.
(3 sts. 3x, 2 sts. 4x, 1 st. 6x).
[3 sts. 3x, 2 sts. 5x, 1 st. 8x].
Knit to Row 216 (224) [232].
Bind off the center 30 sts., put the needles on the left into holding position and complete the right half first.
*ON NECK SIDE, for all sizes, bind off 5 sts. 3x. After Row 224 (232) [240], bind off the remaining 12 (13) [15] sts.
Move the Cam Box to the left side, turn the Row Counter back to 216 (224) [232] and complete the left half. Follow the instructions from *.

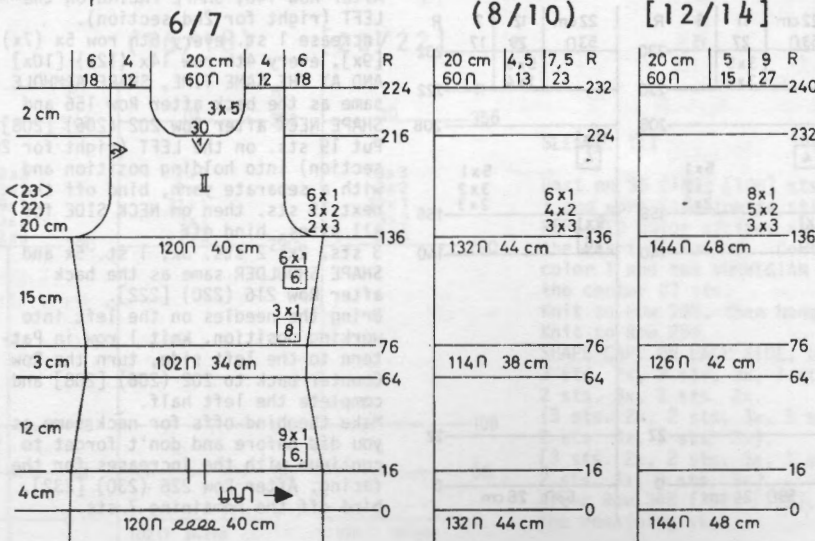

HP 259

MAN'S PULLOVER
 SIZE: 34 (38) [40]
 YARN: Beatrice
 GRAMS:
 color 1 350 400 450
 color 2 250 300 300
 TENSION: 4 to 6
 GAUGE: 18 st. 19 rows = 5 cm (2")



A Norwegian Design that follows the Line Drawing or you may punch your own card. Bands and collar are K1, P1 Ribbing.
 FINISHING: See General Instructions.

BACK: II
 Cast on 165 (179) [195] sts. with color 1 and work 18 rows K1, P1 Ribbing.
 Change to the Norwegian Design and knit to Row 180.
 SHAPE ARMHOLE: ON EACH SIDE, bind off
 4 sts. 1x, 3 sts. 2x, 2 sts. 4x, 1 st. 7x.
 (5 sts. 1x, 3 sts. 3x, 2 sts. 4x, 1 st. 6x).
 [6 sts. 1x, 3 sts. 3x, 2 sts. 5x, 1 st. 7x].
 Knit to Row 260 (264) [268].
 Bind off the center 21 sts., put the needles on the left into holding position and complete the right half first.
 *SHAPE SHOULDER AND NECK AT THE SAME TIME.
 FOR SHOULDER, bind off 4 sts. 7x.
 (4 sts. 3x, 5 sts. 4x).
 [5 sts. 6x, 6 sts. 1x].
 FOR NECK, on all sizes, bind off 5 sts. 2x, 3 sts. 3x.
 Bring the needles on the left into working position, knit 1 row in Pattern to the left side, turn the Row Counter back to 260 (264) [268] and complete the left half. Follow the instructions from *.

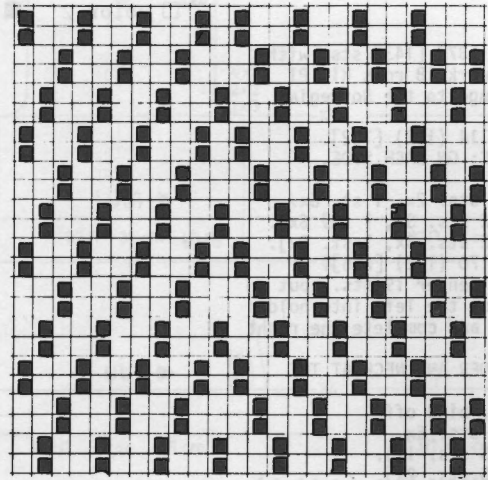
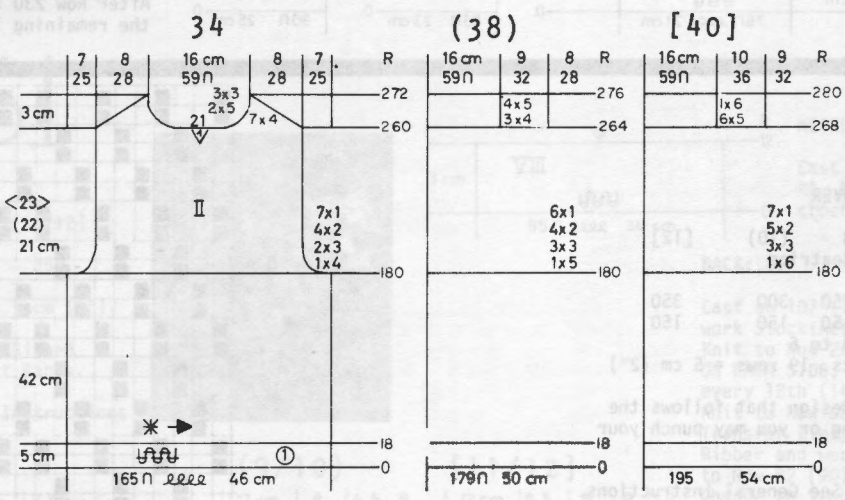

□ color 2
 ■ color 1

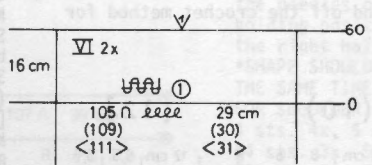

COLLAR: VI Make 2.
 Cast on 105 (109) [111] sts. with color 1 and work 60 rows K1, P1 Ribbing then bind off the crochet method for Ribbing.

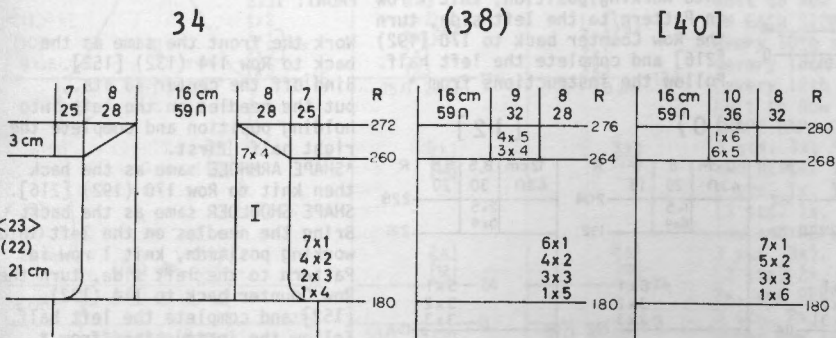

FRONT: I
 Work the front the same as the back to Row 180.
 Bind off the center 59 sts., put the needles on the left into holding position and complete the right half first.
 *SHAPE ARMHOLE same as the back, then knit to Row 260 (264) [268] and SHAPE SHOULDER same as the back.
 Bring the needles on the left into holding position, knit 1 row in Pattern to the left side, turn the Row Counter back to 180 and complete the left half. Follow the instructions from *.



HP 259

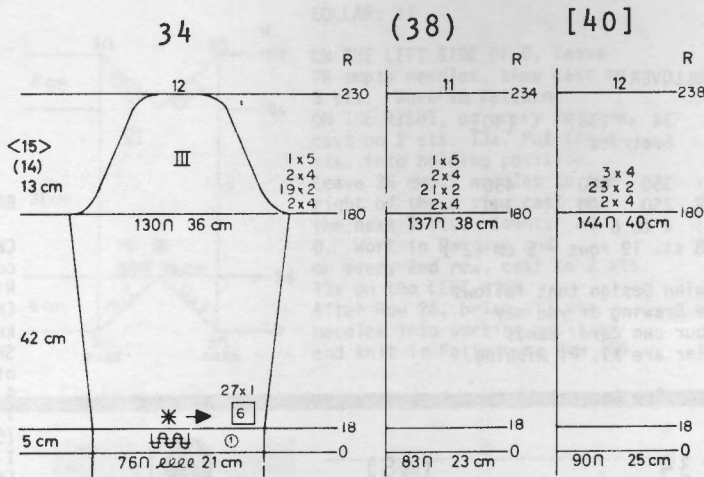

SLEEVE: III

Cast on 76 (83) [90] sts. with color 1 and work 18 rows K1, P1 Ribbing.
Change to the Norwegian Design and ON EACH SIDE, increase 1 st. every 6th row 27x.
Knit to Row 180.
SHAPE CAP: ON EACH SIDE, bind off 4 sts. 2x (2x) [2x], 2 sts. 19x (21x) [23x], 4 sts. 2x (2x) [2x], 5 (5) [4] sts. 1x.
After Row 230 (234) [238], bind off the remaining 12 (11) [12] sts.

KK 260



BOY'S PULLOVER

SIZE: 8 (10) [12]
YARN: Beatrice
GRAMS:
color 1 250 300 350
color 2 150 150 150
TENSION: 4 to 6
GAUGE: 18 sts. 19 rows = 5 cm (2")

Norwegian Design that follows the Line Drawing or you may punch your own card.

FINISHING: See General Instructions.

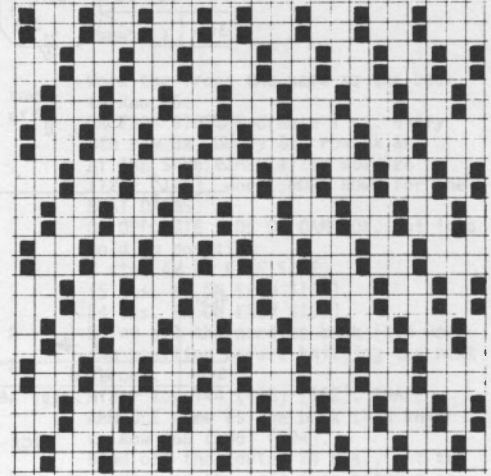

□ color 2 ■ color 1

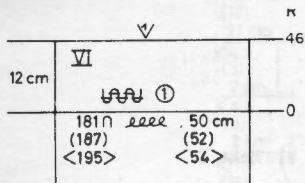

COLLAR: VI

Cast on 181 (187) [195] sts. with color 1 and work 46 rows K1, P1 Ribbing. then bind off the crochet method for Ribbing.

BACK: II

Cast on 129 (137) [143] sts. with color 1 and work 18 rows K1, P1 Ribbing. Change to the Norwegian Design.
Knit to Row 114 (132) [152].
SHAPE ARMHOLE: ON EACH SIDE, bind off
3 sts. 2x, 2 sts. 2x, 1 st. 6x.
(3 sts. 2x, 2 sts. 3x, 1 st. 6x).
[3 sts. 3x, 2 sts. 3x, 1 st. 5x].
Knit to Row 170 (192) [216].
Bind off the center 19 sts., put the needles on the left into holding position and complete the right half first.
*SHAPE SHOULDER AND NECK AT THE SAME TIME.
FOR SHOULDER, bind off
3 sts. 1x, 4 sts. 6x.
(4 sts. 6x, 5 sts. 1x).
[4 sts. 5x, 5 sts. 2x].
FOR NECK on all sizes, bind off
3 sts. 2x, 2 sts. 3x.
Bring the needles on the left into working position, knit 1 row in Pattern to the left side, turn the Row Counter back to 170 (192) [216] and complete the left half. Follow the instructions from *.

FRONT: I

Work the front the same as the back to Row 114 (132) [152]. Bind off the center 43 sts., put the needles on the left into holding position and complete the right half first.
*SHAPE ARMHOLE same as the back then knit to Row 170 (192) [216]. SHAPE SHOULDER same as the back. Bring the needles on the left into working position, knit 1 row in Pattern to the left side, turn the Row Counter back to 114 (132) [152] and complete the left half. Follow the instructions from *.

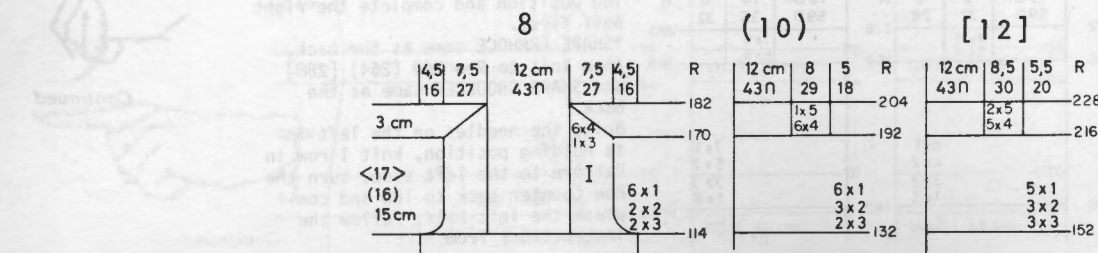
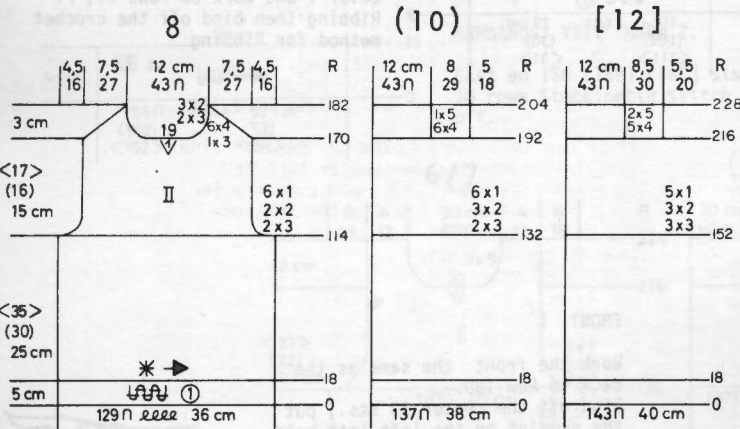

8

(10)

[12]

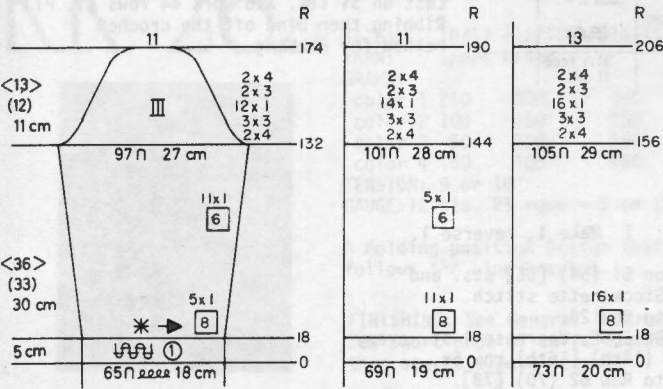

SLEEVE: III

Cast on 65 (69) [73] sts. with color 1 and work 18 rows K1, P1 Ribbing.
 Change to the Norwegian Design and ON EACH SIDE, increase 1 st. every 8th row 5x (11x) [16x], every 6th row 11x (5x) [0x].
 Knit to Row 132 (144) [156].
 SHAPE CAP: ON EACH SIDE, bind off 4 sts. 2x, 3 sts. 3x, 1 st. 12x (14x) [16x], 3 sts. 2x, 4 sts. 2x.
 After Row 174 (190) [206], bind off the remaining 11 sts.

KK 261

GIRL'S CARDIGAN

SIZE: 7/8 (9/10) [11/12]
 YARN: Allegro
 GRAMS: 300 300 350
 TENSION: 6 to 8
 GAUGE: 14 sts. 18 rows = 5 cm (2")

Stockinette stitch with Ribbed Collar, Pocket and front Bands.

FINISHING: See General Instructions.

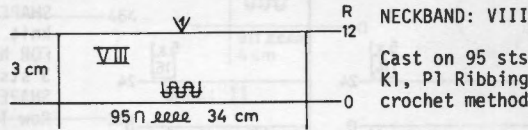

NECKBAND: VIII

Cast on 95 sts. and work 12 rows K1, P1 Ribbing then bind off the crochet method for Ribbing.

BACK: II

Cast on 107 (113) [117] sts. and work Stockinette stitch. Knit to Row 24.
 ON EACH SIDE, decrease 1 st. every 12th (14th) [16th] row 5x. Knit to Row 62 (70) [78].
 Transfer every other stitch to the Ribber and work K1, P1 Ribbing to Row 82 (90) [98].
 Change to Stockinette stitch and knit to Row 122 (130) [138].
 SHAPE ARMHOLE: ON EACH SIDE, bind off 3 sts. 1x, 2 sts. 2x, 1 st. 4x. (3 sts. 1x, 2 sts. 3x, 1 st. 4x). [3 sts. 1x, 2 sts. 3x, 1 st. 5x].
 Knit to Row 172 (184) [196].
 Bind off the center 15 sts., put the needles on the left into holding position and complete the right half first.
 *SHAPE SHOULDER AND NECK AT THE SAME TIME.
 FOR SHOULDER, bind off 4 sts. 4x, 5 sts. 1x. (4 sts. 3x, 5 sts. 2x). [4 sts. 2x, 5 sts. 3x].
 FOR NECK, on all sizes, bind off 3 sts. 3x.
 Move the Cam Box to the left side, turn the Row Counter back to 172 (184) [196] and complete the left half. Follow the instructions from *.

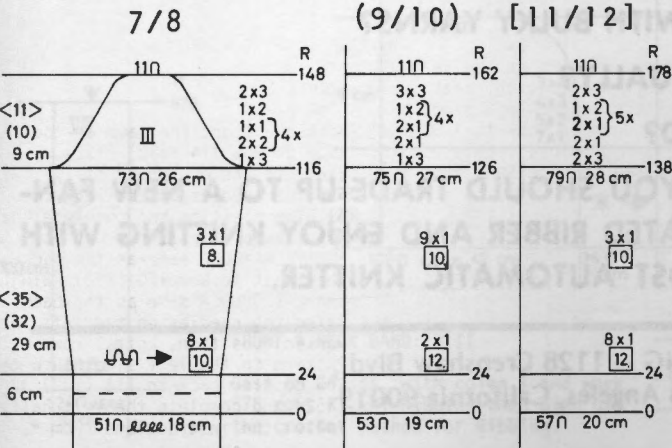
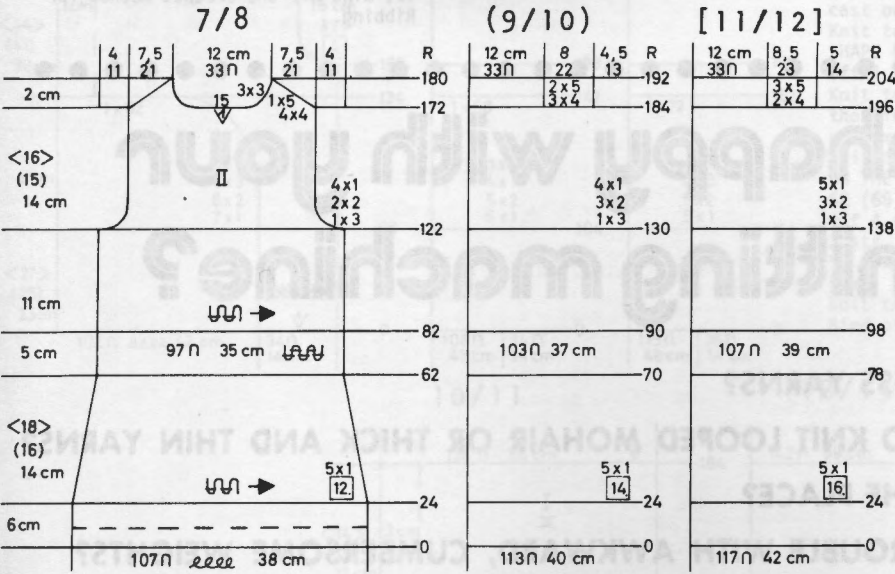

SLEEVE: III

Cast on 51 (53) [57] sts. and work Stockinette stitch. Knit to Row 24.
 ON EACH SIDE increase 1 st. every 10th row 8x, every 8th row 3x. (every 12th row 2x, every 10th row 9x). [every 12th row 8x, every 10th row 3x].
 Knit to Row 116 (126) [138].
 SHAPE CAP: ON EACH SIDE, bind off 3 sts. 1x, *2 sts. 2x, 1 st. 1x, and REPEAT from * 3x more, 2 sts. 1x, 3 sts. 2x. (3 sts. 1x, 2 sts. 2x, *1 st. 2x, 2 sts. 1x, and REPEAT from * 3x more, 3 sts. 3x). [3 sts. 2x, 1 st. 2x, *2 sts. 1x, 1 st. 2x, and REPEAT from * 4x more, 3 sts. 2x].
 After Row 148 (162) [178], bind off the remaining 11 sts.



Continued

KK 261

R POCKET: VIII Make 2.

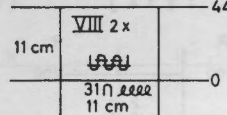

Cast on 31 sts. and work 44 rows K1, P1 Ribbing then bind off the crochet method for Ribbing.

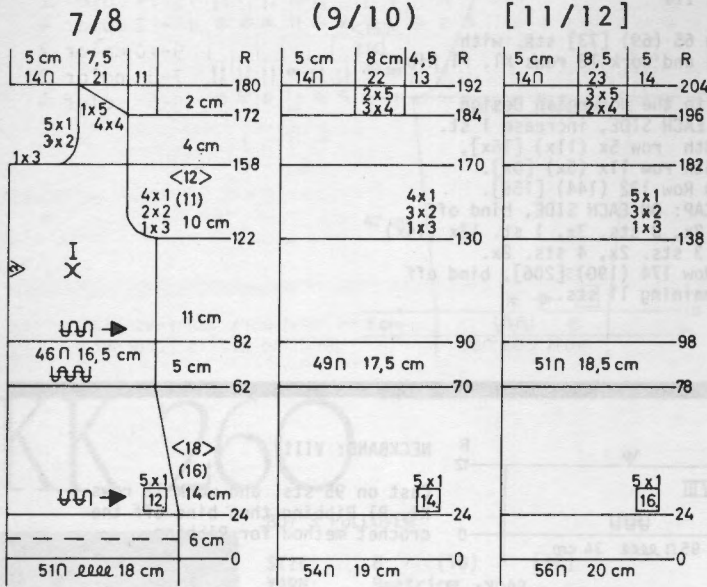

FRONT: I Make 1, reverse 1.

Cast on 51 (54) [56] sts. and work Stockinette stitch. Knit to Row 24. ON SIDE EDGE, decrease 1 st. every 12th (14th) [16th] row 5x. Knit to Row 62 (70) [78]. Transfer every other stitch to the Ribber and work K, P1 Ribbing to Row 82 (90) [98]. Change to Stockinette stitch and knit to Row 122 (130) [138]. SHAPE ARMHOLE same as the back then knit to Row 157 (169) [181]. FOR NECK on all sizes, bind off 3 sts. 1x, 2 sts. 3x, 1 st. 5x and SHAPE SHOULDER same as the back after Row 172 (184) [196].

BUTTON & BUTTONHOLE BAND: VIII Make 2 and omit buttonholes in 2nd section.

VIII 2x		U	
3 cm	<32-36> (30-34.) 28-32.	<52-55> (48-52.) 45-49.	<70-74> (66-70.) 62-66.
		121n (123)	43 cm (46) <49>

Cast on 121 (123) [137] sts. and work K1, P1 Ribbing. After Row 6, make BUTTONHOLES over the needles as shown on the Chart for your size. After Row 12, bind off the crochet method for Ribbing.

are you unhappy with your present knitting machine?

- DOES IT REFUSE TO KNIT FANCY DRESS YARNS?
- DOES IT JAM UP WHEN YOU TRY TO KNIT LOOPED MOHAIR OR THICK AND THIN YARNS?
- DOES IT DROP STITCHES ALL OVER THE PLACE?
- ARE YOU CONTINUALLY HAVING TROUBLE WITH AWKWARD, CUMBERSOME WEIGHTS?
- ARE YOU UNABLE TO MAKE A LARGE GARMENT WITH BULKY YARNS?
- DO YOU HAVE TO SELECT PATTERN STITCHES MANUALLY?
- DO YOU HAVE TO LATCH YOUR RIBBING BY HAND?
- IF YOU ARE HAVING ANY OF THESE PROBLEMS YOU SHOULD TRADE UP TO A NEW FANTASTIC PUSH BUTTON KNITTING WITH COORDINATED RIBBER AND ENJOY KNITTING WITH THE WORLDS FINEST, MOST VERSATILE AND MOST AUTOMATIC KNITTER.

Send for your color brochure to: KNITTING - 1128 Crenshaw Blvd., Los Angeles, California 90019

KK 262

BOY'S JACKET

SIZE: 10/11 (12/13) [14/15]
 YARN: Sport Prima
 GRAMS:
 color 1 250 300 350
 color 2 100 150 200
 color 3 50 100 150
 color 4 50 100 150
 TENSION: 9 or 10
 GAUGE: 12 sts. 21 rows = 5 cm (2")



2 R 3
4 R 1

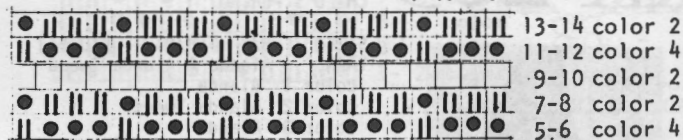

A Holding position Design that follows the Line Drawing.

FINISHING: See General Instructions.
 Sew short ends of cuffs together then sew to sleeve edges.

10/11

(12/13)

[14/15]

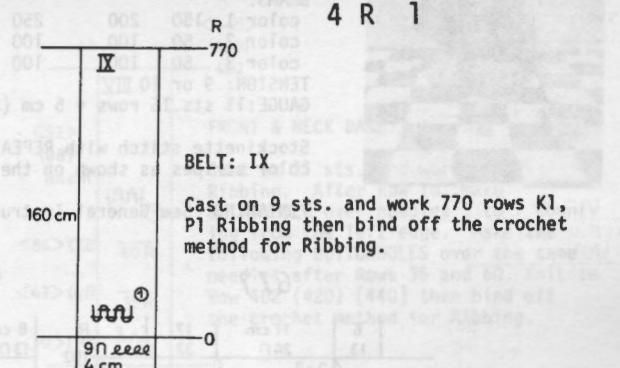
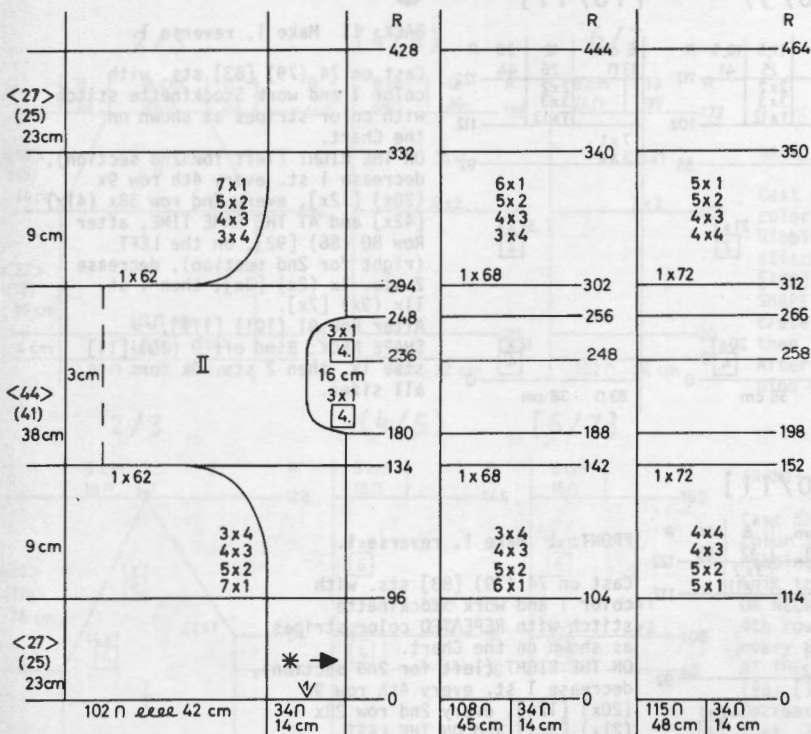

BACK: II
 Cast on 34 sts. to the extreme right of machine and work in Pattern. Knit to Row 96.
ON THE LEFT side, increase 1 st. 7x (6x) [5x], then cast on 2 sts. 5x (5x) [5x], 3 sts. 4x (4x) [4x], 4 sts. 3x (3x) [4x].
 After Row 134 (142) [152], with a separate yarn, on the LEFT side, cast on 62 (68) [72] sts. Knit to Row 180 (188) [198].
SHAPE NECK: For all sizes, bind off 1 st. every 4th row 3x. Knit to Row 236 (248) [258], then increase 1 st. every 4th row 3x.
 Knit to Row 294 (302) [312].
ON THE LEFT SIDE, bind off 62 (68) [72] sts. then bind off 4 sts. 3x (3x) [4x], 3 sts. 4x (4x) [4x], 2 sts. 5x (5x) [5x], 1 st. 7x (6x) [5x].
 Knit to Row 428 (444) [464]. Bind off the remaining 34 sts.

10/11

(12/13)

[14/115]

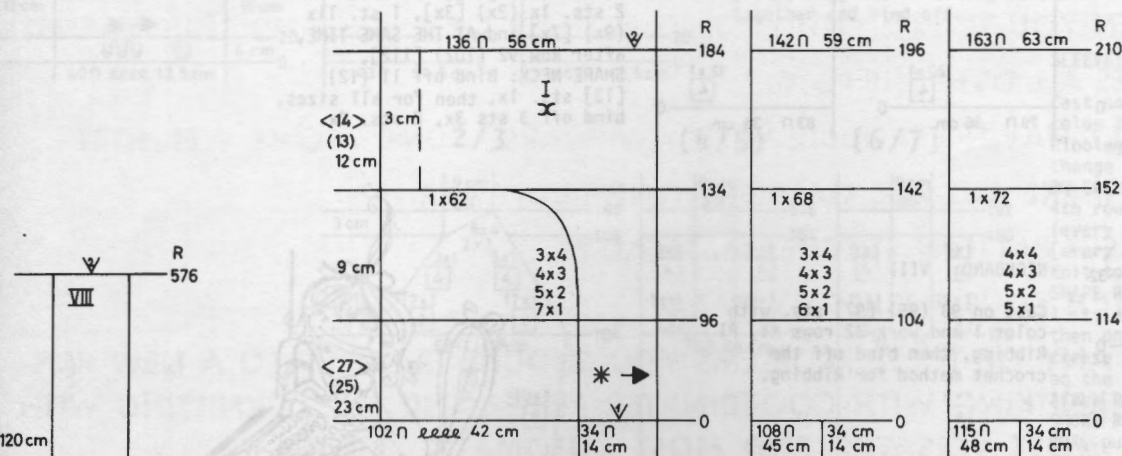

FRONT: I Make 1, reverse 1.
 Cast on 34 sts. to the extreme right (left for 2nd section) of machine and work in Pattern. Knit to Row 96 (104) [114].
ON THE LEFT (right) increase 1 st. 7x (6x) [5x], then cast on 2 sts. 5x (5x) [5x], 3 sts. 4x (4x) [4x], 4 sts. 3x (3x) [4x].
 After Row 134 (142) [152], with a separate yarn, cast on 62 (68) [72] sts. on the LEFT (right) side. Knit to Row 184 (196) [210] then bind off 136 (142) [163] sts.

FRONT & NECK BAND: VIII

Cast on 24 sts. with color 1 and work 576 rows K1, P1 Ribbing then bind off the crochet method for Ribbing.

SLEEVE CUFFS: VIII Make 2.

Cast on 69 sts. with color 1 and work 10 rows K1, P1 Ribbing then bind off the crochet method for Ribbing.

KK 263

CHILD'S PONCHO

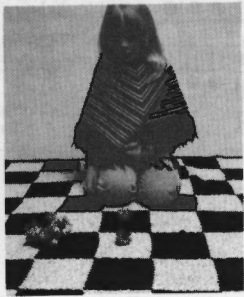

SIZE: 6/7 (8/9) [10/11]
 YARN: Alanda & Alanda Tweed
 color 1 Alanda
 color 2 Alanda Tweed
 color 3 Alanda
 GRAMS:
 color 1 150 200 250
 color 2 50 100 100
 color 3 50 100 100
 TENSION: 9 or 10
 GAUGE: 11 sts. 16 rows = 5 cm (2")

Stockinette stitch with REPEATED color stripes as shown on the Chart.

FINISHING: See General Instructions.

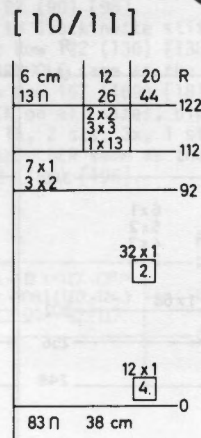
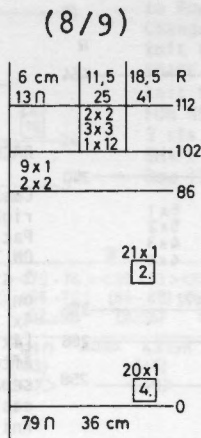
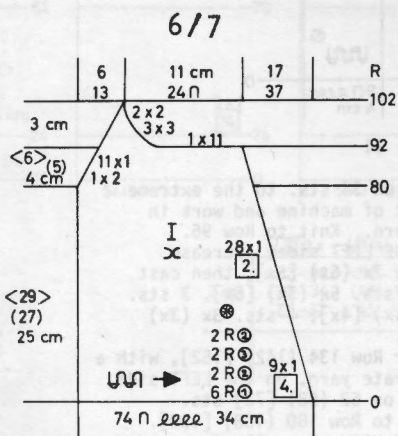
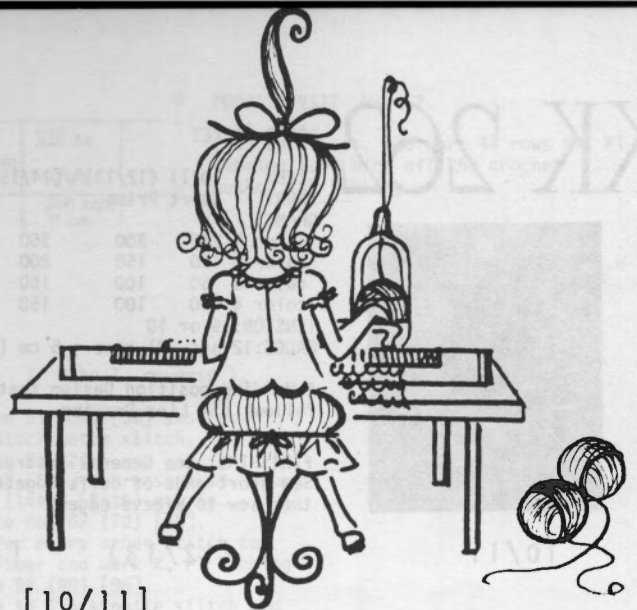

BACK: II Make 1, reverse 1.

Cast on 74 (79) [83] sts. with color 1 and work Stockinette stitch with color stripes as shown on the Chart.
 ON THE RIGHT (left for 2nd section), decrease 1 st. every 4th row 9x (20x) [12x], every 2nd row 38x (41x) [42x] and AT THE SAME TIME, after Row 80 (86) [92], on the LEFT (right for 2nd section), decrease 2 sts. 1x (2x) [3x], then 1 st. 11x (9x) [7x].
 After Row 91 (101) [111], SHAPE NECK: Bind off 9 (10) [11] sts. 1x, then 2 sts. 3x for all sizes.

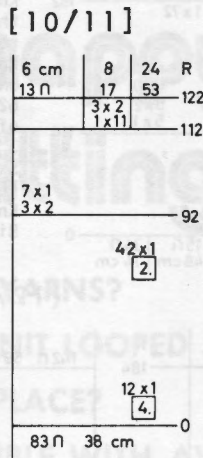
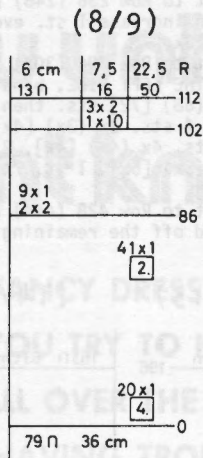
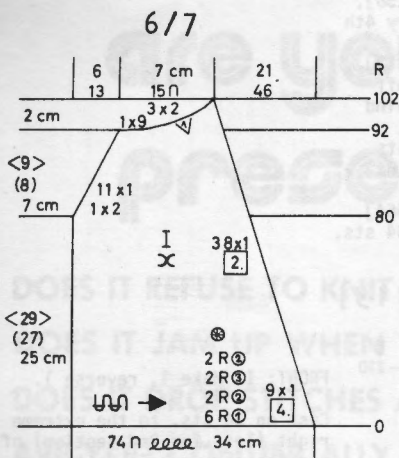

FRONT: I Make 1, reverse 1.

Cast on 74 (79) [83] sts. with color 1 and work Stockinette stitch with REPEATED color stripes as shown on the Chart.
 ON THE RIGHT (left for 2nd section), decrease 1 st. every 4th row 9x (20x) [12x], every 2nd row 28x (21x) [32x] and ON THE LEFT (right for 2nd section) after Row 80 (86) [92], decrease 2 sts. 1x (2x) [3x], 1 st. 11x (9x) [7x] and AT THE SAME TIME, after Row 92 (102) [112], SHAPE NECK: Bind off 11 (12) [13] sts. 1x, then for all sizes, bind off 3 sts 3x, 2 sts. 2x.

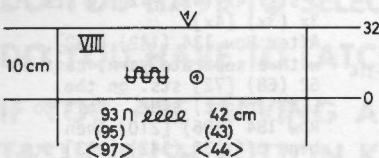

NECKBAND: VIII

Cast on 93 (95) [97] sts. with color 1 and work 32 rows K1, P1 Ribbing, then bind off the crochet method for Ribbing.



KK 264

CHILD'S JACKET

SIZE: 2/3 (4/5) [6/7]
 YARN: Allegro
 GRAMS:
 color 1 150 200 250
 color 2 50 100 100
 TENSION: 6 to 8
 GAUGE: 15 sts. 20 rows = 5 cm (2")

A Holding Position Design in 2 colors on the front section only. Follow the Line Drawing. KNITKING machine owners, use Special Wheel 4B.

FINISHING: See General Instructions.

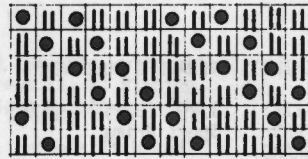

11-12 color 2
 9-10 color 1
 7- 8 color 2
 5- 6 color 1
 3- 4 color 2
 1- 2 color 1



R
 <440>
 (420)
 402

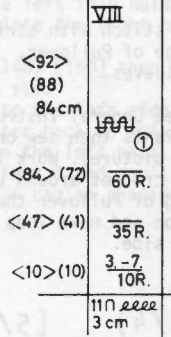

FRONT & NECK BAND:

Cast on 11 sts. and work K1, P1 Ribbing. After Row 10, make **BUTTONHOLE** over needles 3 to 7 counting from the left edge. Make the following **BUTTONHOLES** over the same needles after Rows 35 and 60. Knit to Row 402 (420) [440] then bind off the crochet method for Ribbing.

BACK:

Cast on 90 (96) [102] sts. with color 1 and work 20 rows K1, P1 Ribbing. Change to Stockinette stitch and knit to Row 84 (96) [108].
SHAPE RAGLAN: ON EACH SIDE, decrease 2 sts. 5x (6x) [7x] then 1 st. 23x (24x) [25x]. After Row 140 (156) [172], bind off the remaining 24 sts.

FRONT: I Make 1, reverse 1.

Cast on 40 (43) [46] sts. with color 1 and work 20 rows K1, P1 Ribbing. Change to Pattern and knit to Row 64 (76) [88].
ON NECK SIDE, decrease 1 st. every 4th row 14x (12x) [10x], then every 6th row 1x (3x) [5x] and **AT THE SAME TIME,** after Row 84 (96) [108], **SHAPE RAGLAN:** Decrease 1 st. 22x (2 sts. 1x, 1 st. 23x) [2 sts. 2x, 1 st. 24x]. After Row 128 (144) [160], hang the remaining 6 sts. together and bind off.

SLEEVE: III Make 1, reverse 1.

Cast on 36 (42) [48] sts. with color 1 and work 20 rows K1, P1 Ribbing.
Change to Stockinette stitch and ON EACH SIDE, increase 1 st. every 4th row 6x, every 6th row 10x. (every 6th row 16x). [every 6th row 10x, every 8th row 6x]. Knit to Row 104 (116) [128].
SHAPE RAGLAN: ON EACH SIDE, decrease 1 st. every 2nd row 17x (19x) [21x], then on the **BACK** side of sleeve, decrease 1 st. every 4th row 5x and on the **FRONT** SIDE, 1 st. 3x. After Row 148 (164) [180], work **SHORT ROWS:** ON OPPOSITE SIDE OF CAM BOX, put into holding position 3 sts. 2x, 4 sts. 5x. Bring all the needles back into working position then bind off loosely. Work the 2nd Sleeve with reverse shaping, casting on from right to left. Cam Box will be on the **LEFT** side at Row 0.



2/3

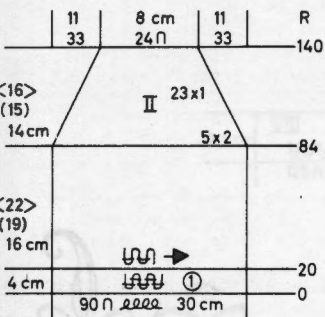

(4/5)

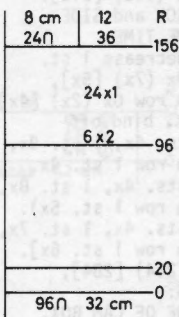

6/7

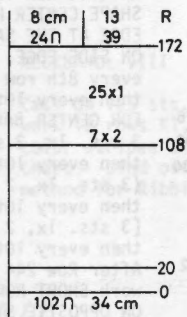

2/3

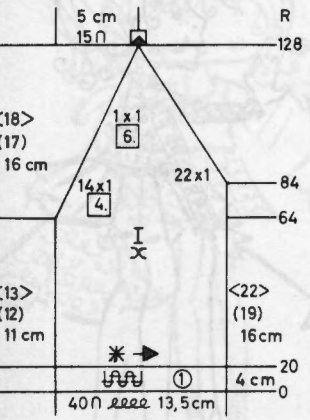

(4/5)

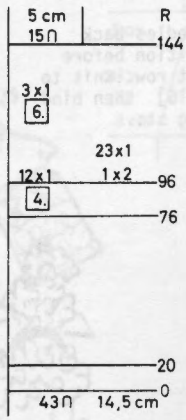

[6/7]

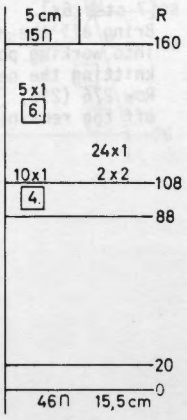

2/3

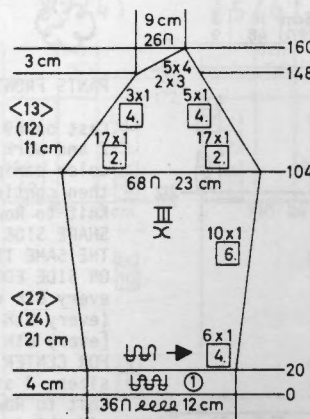

(4/5)

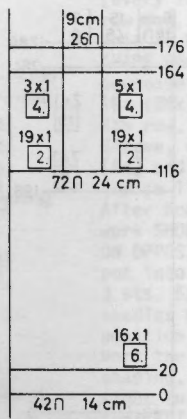

[6/7]

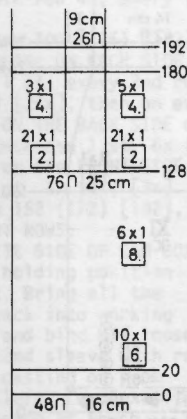

KK 265

CHILD'S OVERALL & PULLOVER



SIZE: 1/2 (3/4) [5/6]
 YARN: Sport Prima
 GRAMS:
 color 1 150 200 200
 color 2 100 100 100
 color 3 150 200 200
 color 4 50 50 50
 TENSION: 6 to 8
 GAUGE: 15 sts. 20 rows = 5 cm (2")

Stockinette stitch with stripes
 on lower edge of Pullover,
 Pants and Sleeves.

FINISHING: See General Instructions.
 Sew Bib to Pants then sew on
 Straps (see picture). Work 1
 row single crochet around back
 neck opening of Pullover then
 sew on button and make loop
 on opposite side.

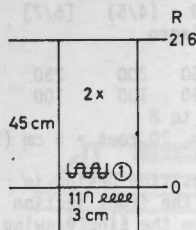

STRAPS: Make 2.

Cast on 11 sts. with color 1 and work
 216 rows K1, P1 Ribbing then bind off
 the crochet method for Ribbing.

PANTS BACK: XII Make 1, reverse 1.

Cast on 69 (72) [75] sts. with
 color 2 and work Stockinette
 stitch with color stripes as
 shown on the Chart, then
 continue with color 1.
 Knit to Row 180 (196) [212].
 SHAPE CENTER BACK and SIDE
 EDGE AT THE SAME TIME.
 ON SIDE EDGE, decrease 1 st.
 every 8th row 9x (7x) [5x],
 then every 10th row 0x (2x) [4x].
 FOR CENTER BACK, bind off
 3 sts. 1x, 2 sts. 4x, 1 st. 9x,
 then every 10th row 1 st. 4x.
 (3 sts. 1x, 2 sts. 4x, 1 st. 8x,
 then every 10th row 1 st. 5x).
 [3 sts. 1x, 2 sts. 4x, 1 st. 7x,
 then every 10th row 1 st. 6x].
 After Row 244 (264) [284],
 work SHORT ROWS:
 ON OPPOSITE SIDE OF CAM BOX,
 put into holding position
 6 sts. 6x.
 (6 sts. 3x, 7 sts. 3x).
 [7 sts. 6x].
 Bring all the needles back
 into working position before
 knitting the next row. Knit to
 Row 276 (296) [316] then bind
 off the remaining sts.

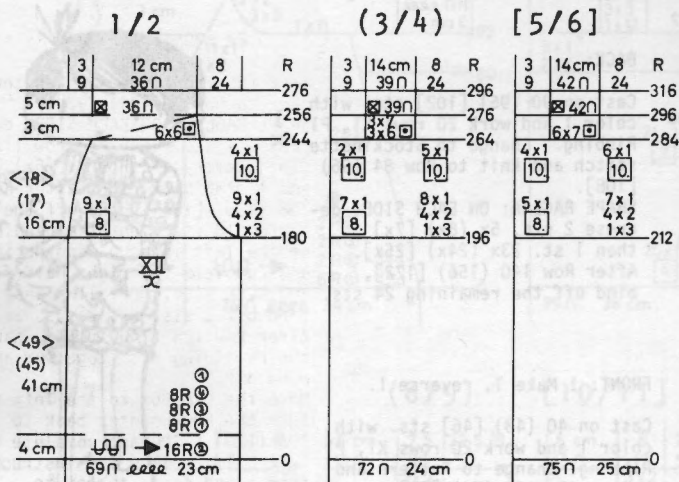

BIB:

Cast on 45 sts. with color 2 and work
 Stockinette stitch. Knit 10 rows then
 change to color 4 and work 18 rows.
 Continue with color 4 over 15 stitches
 ON EACH SIDE and work the center 15
 sts. with color 1. Knit 26 rows
 then continue with color 4 over all
 the needles and knit 18 rows.
 Change to color 2 and work to Row 92,
 then bind off.

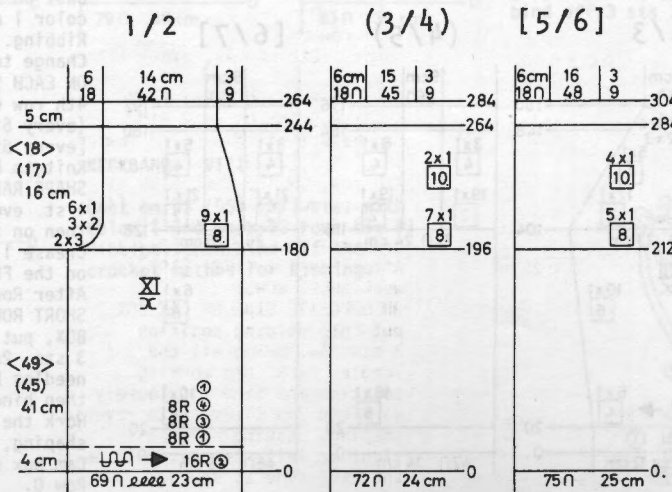
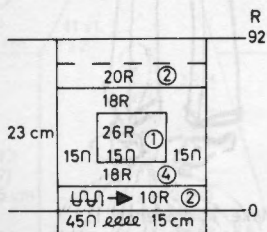

PANTS FRONT: XI Make 1, reverse 1.

Cast on 69 (72) [75] sts. with color
 2 and work Stockinette stitch with
 color stripes as shown on the Chart
 then continue with color 1.
 Knit to Row 180 (196) [212].
 SHAPE SIDE EDGE and CENTER FRONT AT
 THE SAME TIME.
 ON SIDE EDGE, decrease 1 st.
 every 8th row 9x.
 (every 8th row 7x, every 10th row 2x).
 [every 8th row 5x, every 10th row 4x].
 FOR CENTER FRONT, bind off for all
 sizes, 3 sts. 2x, 2 sts. 3x, 1 st. 6x.
 Knit to Row 264 (284) [304] then bind
 off the remaining 42 (45) [48] sts.

PULLOVER BACK: II

Cast on 84 (90) [96] sts. with color 2 and work 20 rows K1, P1 Ribbing with color stripes as shown on the Chart.

Change to Stockinette stitch and color 3. Knit to Row 76 (84) [92].
SHAPE RAGLAN: ON EACH SIDE, on every 2nd row, decrease 1 st. 18x (22x) [26x], then every 4th row 1 st. 6x (5x) [4x], and after Row 104 (116) [128], divide in the center, put the needles on the left into holding position and complete the right half first.

*Knit to Row 136 (148) [160] then bind off the remaining sts.

Move the Cam Box to the left side, turn the Row Counter back to 104 (116) [128] and complete the left half. Follow the instructions from * and don't forget to complete the raglan shaping.



PULLOVER FRONT: I

Work the front the same as the back to Row 76 (84) [92].
SHAPE RAGLAN: ON EACH SIDE, decrease 1 st. every 2nd row 11x (15x) [19x], every 4th row 7x (6x) [5x] and AT THE SAME TIME, after Row 108 (120) [132], bind off the center 18 sts., put the needles on the left into holding position and complete the right half first.
*ON NECK SIDE, for all sizes, bind off 3 sts. 2x, 2 sts. 3x. After Row 128 (140) [152], hang the remaining sts. together and bind off.
Move the Cam Box to the left side, turn the Row Counter back to 108 (120) [132] and complete the left half. Follow the instructions from * and don't forget to complete the raglan shaping.

1/2

(3/4)

[5/6]

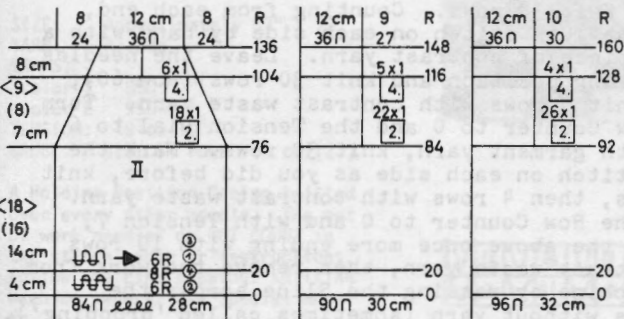

NECKBAND: VIII

Cast on 125 sts. with color 1 and work 12 rows K1, P1 Ribbing with color stripes as shown on the Chart. Bind off the crochet method for Ribbing.

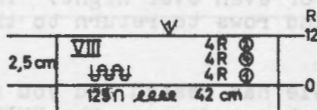

1/2

(3/4)

[5/6]

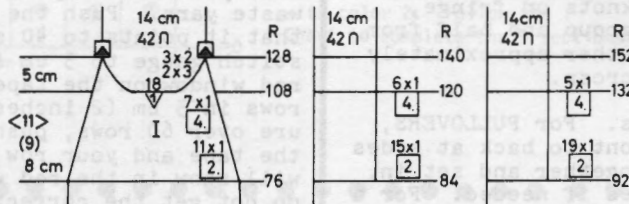

SLEEVE: III Make 1, reverse 1.

Cast on 45 (49) [51] sts. with color 2 and work 20 rows K1, P1 Ribbing with color stripes as shown on the Chart.

Change to Stockinette stitch and continue with color 3.
ON EACH SIDE, increase 1 st. every 8th row 10x. (every 8th row 4x, every 10th row 8x). [every 10th row 4x, every 12th row 6x].

Knit to Row 100 (116) [132].
SHAPE RAGLAN: ON EACH SIDE, decrease 1 st. every 2nd row 18x (24x) [24x], then on every 4th row, ON THE BACK SIDE OF Sleeve, decrease 1 st. 6x (4x) [5x] and on the FRONT SIDE, decrease 1 st. 4x (2x) [3x]. After Row 152 (172) [192], work SHORT ROWS:

ON OPPOSITE SIDE OF CAM BOX, put into holding position 3 sts. 5x. Bring all the needles back into working position and bind off loosely. Work the 2nd sleeve with reverse shaping, casting on from right to left. Cam Box will be on the LEFT side at Row 0.



1/2

(3/4)

[5/6]

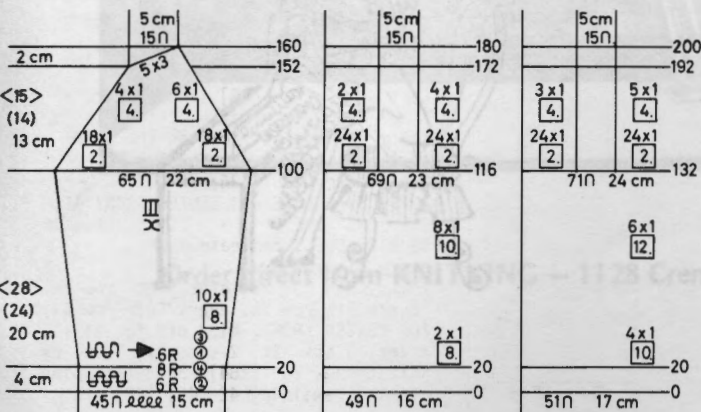

General Instructions

GENERAL INSTRUCTIONS FOR THIS ISSUE

FULL FASHION DECREASING AND INCREASING

For Stockinette stitch, always use the Full Fashion method for decreasing or increasing.

TO DECREASE: Hang the 3rd stitch onto the 2nd stitch, then move the stitches in to fill the empty needle.

TO INCREASE: Move the 2 end stitches 1 needle outward, then pick up the 3rd stitch from the row below and hang it onto the empty needle.

NORWEGIAN DESIGNS

In the instructions, each row of the Norwegian Design is counted as 1 row but several movements of the Cam Box are needed to complete 1 row.

NORWEGIAN DESIGN WHEN USING THE PATTERN READER

When you use the Pattern Reader and knit a Norwegian Design using several colors, it is necessary to move the trip control lever so that only 1 row registers.

TO MAKE FRINGE

Cut yarn **DOUBLE** the length of fringe desired (wind around a cardboard or book). Using 2 or more strands of yarn (depending on weight of yarn) fold in half and with a crochet hook, draw folded loop through knitting from the wrong side. Pull strands through loop and tighten.

To make an additional row of knots on fringe, take half the strands from 1 group and half from the next group, then knot together approximately 1" to 2" below and continue across.

FINISHING: Block all sections. For **PULLOVERS, JACKETS** and **DRESSES:** Join front to back at sides and shoulders. Sew sleeves together and set in. Hem lower edge and sleeve edges if needed. For a double neckband or armhole band, sew 1 edge to the inside and 1 to the outside of neck or armhole. For a single ribbed band, sew 1 edge to the outside of neck or armhole edge. For a Cardigan or Jacket with buttonholes, finish buttonholes and sew on buttons.

PANTS: Join front to back at sides. Sew inside leg seams, then join center front and back. Make hem at waistline and insert elastic. Hem lower edge of pants legs.

THE SAMPLE SWATCH

Before you begin to knit any garment, you will need to knit a sample piece using the yarn you have chosen for your garment, so that you can check the stitch and row gauge which must measure the correct number of stitches and rows in 5 cm (2 inches).

For each Pattern in **KNITKING MAGAZINE**, we give you 3 Tension Numbers to work from and if you use the specified yarn for the garment, you should be able to get the correct stitch and row gauge using one of these numbers. Here is a very easy way to make your sample swatch and count the stitches and rows **WITHOUT** actually counting, by using our **KNITKING CONVERTA TAPE**.

Supposing the Tension Numbers for the Stitch and Row Gauge are given as 5 to 7. Set the Tension Dial to the first number which is 5. With contrast waste yarn, and using the quick cast-on method, cast on 60 stitches and knit 10 rows. Change to garment yarn and turn the Row Counter to 0. Knit 30 rows. Counting from each end, knit the 10th stitch on each side by hand with a small piece of contrast yarn. Leave the needles in working position and knit 30 rows (Row 60), then knit 4 rows with contrast waste yarn. Turn the Row Counter to 0 and the Tension Dial to 6 and with garment yarn, knit 30 rows. Mark the 10th stitch on each side as you did before, knit 30 rows, then 4 rows with contrast waste yarn. Turn the Row Counter to 0 and with Tension 7, repeat the above once more ending with 10 rows of contrast waste yarn, then remove the work from the machine by passing the Slide across the needles without yarn (sometimes called 'dropping').

Pull and stretch the sample piece both lengthwise and diagonally from corner to corner, then lengthwise again. Do not count the stitches and rows immediately, but allow the sample to rest for several hours or even over night. This will allow the stitches and rows to return to their basic form.

When your sample has rested and you are ready to count the stitches and rows, the **KNITKING CONVERTA TAPE** will do the figuring for you without any counting on your part. Use the Tape as follows:

To measure the stitches, pull out the Tape to measure **BETWEEN** the 40 stitches in the center that you marked by hand knitting with contrast waste yarn. Push the red marker on the Tape so that it points to 40 stitches on the Tape. Your stitch gauge to 5 cm (2 inches) will show in the red window on the tape. To find the number of rows in 5 cm (2 inches), place the tape to measure over 60 rows, push the red marker to 60 on the tape and your row gauge for 5 cm (2 inches) will show in the red window... Easy..? If you do not get the correct stitch and row gauge in the first part of your sample, then try the other two.

If you do not own a **KNITKING CONVERTA TAPE**, you must mark a 5 cm (2 inch) square in the center of the knitting, then count the number of stitches and rows within the square.



RS 266

AFGHAN

SIZE: Approximately 53" X 72"
 YARN: Alanda
 GRAMS:
 color 1 850
 color 2 950
 TENSION: 9 to 10
 GAUGE: 7 sts. 34 rows = 5 cm (2")

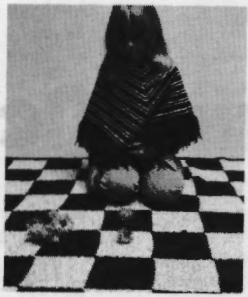

A Holding Position Design knitted over every other needle. The out of work needles do NOT COUNT in the stitch gauge or instructions. Follow the Line Drawing. KNITTING machine owners, use Special Wheel No. 4.

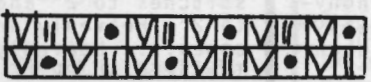

3-4
1-2



FINISHING: Weave or sew the strips together. Work 4 rows single crochet around the edges.

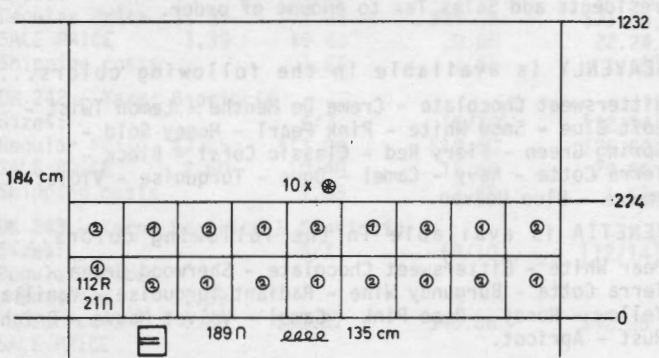

Each strip is knitted over 21 needles. Cast on 21 sts. with color 1 over every other needle. *Knit in the Holding Position Design to Row 112. Change to color 2 and work the Holding Position Design to Row 224. Change to Color 1 and REPEAT from *, changing the colors after every 112 rows. After Row 1232, bind off. Work the next strip beginning with color 2. Follow the Chart to complete the 9 sections in all.

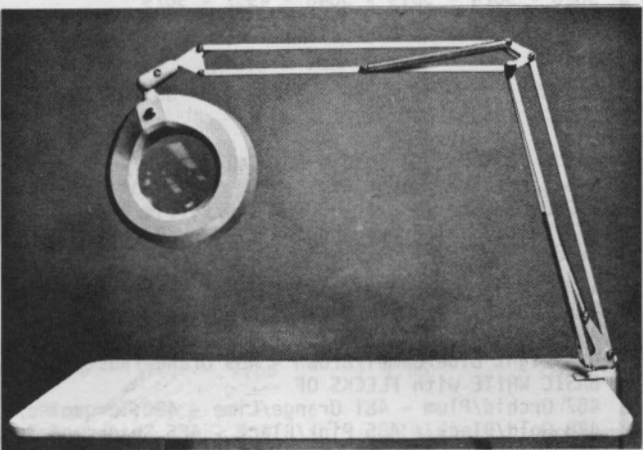

knitkng magnifier lamp

A perfect gift item for any knitter. It has a large (5") magnifying lens and a cool fluorescent tube light. It stays in any position and is wonderful for general illumination for you to work under when joining seams, etc. Color: light grey.

List Price: \$69.50
 (California residents add Sales Tax)
 Shipping Costs: \$3.00

Order direct from KNITKING - 1128 Crenshaw Blvd., Los Angeles, California 90019



Knitking News

KNITKING YARNS

In our Editorial for this issue, we refer to the new KNITKING YARN CATALOGUE being made for us in Europe... We also want to tell you what a difficult time we had in deciding between the many types and weights of yarns... We were tempted to include some of the cheaper yarns, but finally decided against it. The KNITKING name is synonymous with quality and we always advise our customers to use the best yarn they can afford... When you put time and effort into the knitting of a garment, it is nice to know that it will retain its shape and good looks through many washings... The time worn maxim "Anything worth doing is worth doing well" still hold true, especially in the making of clothes.

We have an outstanding offer for all subscribers who make garments from this issue... All yarns are discounted especially for you... This offer can only be extended until the end of February, so don't delay in sending your order listing your choice of colors.

NEW TOOLS AND OTHER SPECIALS

We couldn't find sufficient space to include everything in the pages of this issue so for U.S. readers only, we are including a loose one page sheet supplement, but we do want all readers to know about the new JAC 40 PUNCHING ACCESSORY and BLANK CARDS... With this new easy to use tool, you can create your own original JAC 40 designs or you can reproduce designs from this and previous issues of KNITKING MAGAZINE.

The list price of the JAC 40 PUNCHING TOOL complete with operating instructions and five blank cards is \$24.95. Our introductory price is \$22.50 plus \$1.25 shipping costs. California residents must add Sales Tax.

MACHINE KNIT CLASSICS

Several issues ago, we offered a book of Machine Knit Classics to our subscribers. It is printed in England and included in its pages are Classic Sweaters and Cardigans for toddlers, children, women and men. There is a total of 21 garments in a full range of sizes and you can use any yarn that knits 14 stitches to 2 inches. The low price for this excellent book is \$1.50 postage paid anywhere in the U.S. (California residents must add 9¢ Sales Tax).

BIG YARN DISCOUNTS FOR SUBSCRIBERS

You save in many ways when you subscribe to KNITKING MAGAZINE... The big discounts on yarns for patterns in this issue are only available to subscribers... and as you can see, it is possible to save the cost of a one year subscription on many of the Pattern Kits... For U.S. readers we are including an extra loose page with some New Year Specials that can only be available in the U.S.

All of the new yarns and new colors are not yet available so we are providing the following list of everything in stock at this time. Colors shown in the present catalogue are listed by

number... New yarns are listed by number and color. Please place your order early and be sure of your choice of colors... If possible, give alternate choices.

Our beautiful cone yarns, Heavenly and Venetia can be used for several of the garments in this issue... Heavenly knits up ideally at 15 or 16 stitches to 2" and Venetia at 16 or 17 stitches to 2". Heavenly and Venetia both are on 1 1/2 lb. cones... Heavenly retails at \$16.56 per cone... The SPECIAL PRICE to subscribers is \$13.25 per cone. Venetia lists at \$21.36 per cone, the SPECIAL subscriber price is \$17.10 per cone. The shipping costs for Cone yarn are \$1.60 for first cone plus 90¢ for each additional cone.

Please be sure to include Shipping costs and California residents add Sales Tax to amount of order.

HEAVENLY is available in the following colors....

Bittersweet Chocolate - Creme De Menthe - Lemon Twist - Soft Blue - Snow White - Pink Pearl - Honey Gold - Spring Green - Fiery Red - Classic Coral - Black - Terra Cotta - Navy - Camel - Bone - Turquoise - Violet Mauve - Blue Heaven.

VENETIA is available in the following colors....

Pear White - Bittersweet Chocolate - Sherwood Green - Terra Cotta - Burgundy Wine - Radiant Turquoise - Vanilla - Yellow - Honey - Rose Pink - Camel - Velvet Mauve - Bright Rust - Apricot.

COMBINELLA FINA: 8321 White/Orange/Lilac - 8303 White/Lilac - 8305 White/shades of Turquoise - 8315 Shades of Yellow/Orange - 8313 Bone/light Rust/dark Rust - 8317 Shades of Rust - 8325 Olive Green/Gold/Rust - 8319 Grey/Medium Blue/Gold.

BEATRICE: 4976 - 4978 - 5027 - 4991 - 5006 - 5021 - 5026 - 5024 - 5019 - 3048 - 4957 - 5029

ALANDA: 402 - 401 - 412 - 407 - 403 - 409 - 413 - 406 - 404

REGIA: 55 - 56 - 327 - 324 - 17 - 33 - 315 - 541 - 7238 - 2066 - 1953 - 522

CAPRICCIO: 801 Gold - 802 Gold/Brown/Rust - 803 Silver - 805 Bone/Camel/Light Grey - 808 Shades of Grey/Black - 812 Bone/Camel/Brown - 809 Lilac/Purple/Black/Silver - 813 Gold/Camel/Brown - 815 Pink/Grey/Black - 816 Shades of Turquoise/Black

ALANDA TWEED: 493 Olive/Lime/Light Blue - 490 Camel/Rust/Brown - 495 Light Blue/Turquoise/Royal Blue - 492 Yellow/Shades of Olive - 491 Camel/Light & Dark Brick - 494 Light Blue/Camel/Brown - 489 Orange/Rust/Brown - BASIC WHITE with FLECKS OF
487 Orchid/Plum - 481 Orange/Lime - 480 Turquoise/Blue - 488 Gold/Black - 485 Pink/Black - 486 Shades of Turquoise - 482 Shades of Olive Green

SPORT PRIMA: 862 - 850 - 940 - 941 - 939 - 942 - 842

ALLEGRO: 518 - 502 - 503 - 505 - 549 - 556 - 511 - 517 - 522 - 520 - 558 - 559 - 517 - 524 - 527 - 502 - 519 - 556 - 513 NEW COLORS: 577 Bright Blue - 523 Light Blue - 576 Aqua - 580 Orange - 508 Yellow

CROCUS: 31 - 05 - 17 - 24 - 14 - 07 - 11 - 03 - 14 - 8

DK 237 - Yarn: Combinella Fina				
Sizes:	8/10	(12/14)	[16]	
Regular Price	\$1.99	\$47.76	\$49.75	\$51.74
SALE PRICE	1.59	38.16	39.75	41.34
Shipping costs		2.15	2.15	2.15
DK 238 - Yarn: Beatrice				
Sizes:	12	(14)	[16]	
Regular Price	\$1.99	\$15.92	\$17.91	\$19.90
SALE PRICE	1.39	11.12	12.51	13.90
Shipping costs		1.65	1.65	1.65
DK 239 - Yarn: Beatrice				
Sizes:	10/12	(14)	[16/18]	
Regular Price	\$1.99	\$17.91	\$25.87	\$29.85
SALE PRICE	1.39	12.51	18.07	20.85
Shipping costs		1.65	1.65	1.65
DK 240 - Yarn: Alanda & Regia				
Sizes:	12	(14/16)	[18]	
Regular Price				
Alanda	\$1.19			
Regia	1.59	\$14.29	\$18.67	\$19.86
SALE PRICE				
Alanda	\$.83			
Regia	1.11	\$ 9.97	\$11.91	\$12.74
Shipping costs		1.65	1.65	1.65
DK 241 - Yarn: Beatrice				
Sizes:	10/12	(14/16)	[18/20]	
Regular Price	\$1.99	\$27.86	\$29.85	\$31.84
SALE PRICE	1.39	19.46	20.85	22.24
Shipping costs		1.65	1.65	1.65
DK 242 - Yarn: Capriccio				
Sizes:	6/7	(8/10)	[12/14]	
Regular Price	\$3.25	\$13.00	\$19.50	\$26.00
SALE PRICE	2.60	10.40	15.60	20.80
Shipping costs		1.65	1.65	1.65
DK 243 - Yarn: Beatrice & Capriccio				
Sizes:	6/7	(8/10)	[12/14]	
Regular Price				
Beatrice	\$1.99			
Capriccio	3.25	\$38.87	\$40.86	\$42.85
SALE PRICE				
Beatrice	\$1.39			
Capriccio	2.60	\$29.10	\$29.86	\$31.25
Shipping costs		1.65	1.65	1.65
DK 244 - Yarn: Alanda Tweed				
Sizes:	6/8	(10/12)	[14/16]	
Regular Price	\$1.99	\$33.83	\$39.80	\$45.77
SALE PRICE	1.59	27.03	31.80	36.57
Shipping costs		1.65	1.65	1.65
DK 245 - Yarn: Alanda Tweed				
Shoulder Bag				
Regular Price	\$1.99	\$7.96		
SALE PRICE	1.59	6.36		
Shipping costs		1.65		
DK 246 - Yarn: Sport Prima				
Sizes:	8/10	(12/14)	[16/18]	
Regular Price	\$1.79	\$41.17	\$42.96	\$44.75
SALE PRICE	1.25	28.75	30.00	31.25
Shipping costs		2.15	2.15	2.15
DK 247 - Yarn: Beatrice				
Sizes:	6/7	(8/10)	[12/14]	
Regular Price	\$1.99	\$11.94	\$13.93	\$15.92
SALE PRICE	1.39	8.34	9.73	11.12
Shipping costs		1.65	1.65	1.65
DK 248 - Yarn: Beatrice				
Sizes:	7	(10)	[14]	
Regular Price	\$1.99	\$19.90	\$23.88	\$25.87
SALE PRICE	1.39	13.90	16.68	18.07
Shipping costs		1.65	1.65	1.65
DK 249 - Yarn: Capriccio				
Sizes:	8/10	(12/14)	[16/18]	
Regular Price	\$3.25	\$19.50	\$26.00	\$32.50
SALE PRICE	2.60	15.60	20.80	26.00
Shipping costs		1.65	1.65	1.65

DK 250 - Yarn: Beatrice & Capriccio				
Sizes:	8/10	(12/14)	[16/18]	
Regular Price				
Beatrice	\$1.99			
Capriccio	3.25	\$24.94	\$33.43	\$35.42
SALE PRICE				
Beatrice	\$1.39			
Capriccio	2.60	\$18.74	\$25.33	\$26.72
Shipping costs		1.65	1.65	1.65
DK 251 - Yarn: Alanda				
Sizes:	8/10	(12/14)	[16/18]	
Regular Price	\$1.19	\$ 7.14	\$ 8.33	\$ 9.52
SALE PRICE	.83	4.98	5.81	6.64
Shipping costs		1.65	1.65	1.65
DK 252 - Yarn: Crocus				
Sizes:	10/12	(14/16)	[18/20]	
Regular Price	\$1.99	\$25.87	\$29.85	\$33.83
SALE PRICE	1.39	18.07	20.85	23.63
Shipping costs		1.65	1.65	1.65
DK 253 - Yarn: Crocus				
Sizes:	6/7	(8/10)	[12/14]	
Regular Price	\$1.99	\$33.83	\$35.82	\$39.80
SALE PRICE	1.39	23.63	25.02	27.80
Shipping costs		1.65	1.65	1.65
DK 254 - Yarn: Alanda & Alanda Tweed				
Sizes:	10	(12)	[14]	
Regular Price				
Alanda	\$1.19			
Alanda Tweed	1.99	\$10.73	\$15.10	\$19.47
SALE PRICE				
Alanda	\$.83			
Alanda Tweed	1.59	\$ 8.09	\$11.34	\$14.59
Shipping costs		1.65	1.65	1.65
DK 255 - Yarn: Sport Prima				
Sizes:	10/12	(14/16)	[18/20]	
Regular Price	\$1.79	\$55.49	\$57.28	\$59.07
SALE PRICE	1.25	38.75	40.00	41.25
Shipping costs		2.65	2.65	2.65
DK 256 - Yarn: Beatrice				
Sizes:	12/14	(16/18)	[20/22]	
Regular Price	\$1.99	\$51.74	\$55.72	\$59.70
SALE PRICE	1.39	36.14	38.92	41.70
Shipping costs		2.15	2.15	2.15
DK 257 - Yarn: Beatrice				
Sizes:	6/7	(8/10)	[12/14]	
Regular Price	\$1.99	\$ 9.95	\$11.94	\$13.93
SALE PRICE	1.39	6.95	8.34	9.73
Shipping costs		1.65	1.65	1.65
HP 258 - Yarn: Sport Prima				
Sizes:	34	(38)	[40]	
Regular Price	\$1.79	\$30.43	\$32.22	\$34.01
SALE PRICE	1.25	21.25	22.50	23.75
Shipping costs		1.65	1.65	1.65
HP 259 - Yarn: Beatrice				
Sizes:	34	(38)	[40]	
Regular Price	\$1.99	\$23.88	\$27.86	\$29.85
SALE PRICE	1.39	16.68	19.46	20.85
Shipping costs		1.65	1.65	1.65
KK 260 - Yarn: Beatrice				
Sizes:	8	(10)	[12]	
Regular Price	\$1.99	\$15.92	\$17.91	\$19.90
SALE PRICE	1.39	11.12	12.51	13.90
Shipping costs		1.65	1.65	1.65
KK 261 - Yarn: Allegro				
Sizes:	7/8	(9/10)	[11/12]	
Regular Price	\$1.39	\$ 8.34	\$ 8.34	\$ 9.73
SALE PRICE	1.11	6.66	6.66	7.77
Shipping costs		1.00	1.00	1.00
KK 262 - Yarn: Sport Prima				
Sizes:	10/11	(12/13)	[14/15]	
Regular Price	\$1.79	\$16.11	\$23.27	\$30.43
SALE PRICE	1.25	11.25	16.25	21.25
Shipping costs		1.65	1.65	1.65

(continued)

KNITKING NEWS (continued)

KK 263 - Yarn: Alanda & Alanda Tweed				
Sizes:	6/7	(8/9)	[10/11]	
Regular Price				
Alanda	\$1.19			
Alanda Tweed	1.99	\$6.75	\$11.12	\$12.31
SALE PRICE				
Alanda	\$.83			
Alanda Tweed	1.59	\$4.91	\$ 8.16	\$ 8.99
Shipping costs		1.00	1.00	1.00
KK 264 - Yarn: Allegro				
Sizes:	2/3	(4/5)	[6/7]	
Regular Price	\$1.39	\$ 5.56	\$ 8.34	\$ 9.73
SALE PRICE	1.11	4.44	6.66	7.77
Shipping costs		1.00	1.00	1.00
KK 265 - Yarn: Sport Prima				
Sizes:	1/2	(3/4)	[5/6]	
Regular Price	\$1.79	\$16.11	\$19.69	\$19.69
SALE PRICE	1.25	11.25	13.75	13.75
Shipping costs		1.65	1.65	1.65
RS 266 - Yarn: Alanda				
Afghan - Size: 53" x 72"				
Regular Price	\$1.19	\$42.84		
SALE PRICE	.83	29.88		
Shipping costs		2.65		



knitkiting carrying bags

Completely new design in heavy duty canvas with waterproof interior. For AM 3 Knitter and Yarn Container.

Price: \$45.95
 For Ribber only: \$24.00
 (California residents add Sales Tax)
 Shipping Costs: \$2.00 and \$1.25

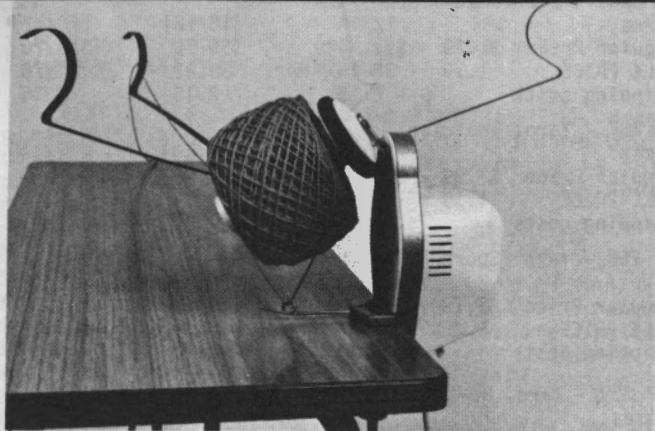

New design electric winder

Self-contained Motorized Winder (110/120 Volts) with Push Button on and off Switch ... Special Clutch device to stop Winder if yarn bunches up or jams in the guide eye ... Another excellent easy to use KNITKING product.

Price: Complete with Skein Holder \$44.95
 (California residents add Sales Tax).
 Shipping Charges: \$2.50

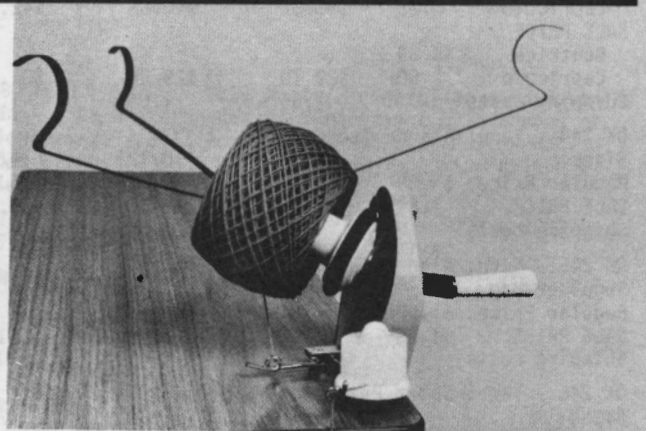

New design Yarn Winder with 'Waxamajig' and Skein Holder. As you can see from the illustration, this clever New Winder with Nylon Helical Gears winds a perfectly symmetrical ball. . . ! If you like to wax yarn (for easier knitting) you use the 'Waxamajig'. If waxing is not necessary, you bypass it ... The Skein Holder is self adjusting. You will not find a better Hand Winder anywhere.

Complete price \$27.50
 (California residents add Sales Tax)
 Shipping charges: \$2.00

Order direct from KNITKING -

1128 Crenshaw Blvd., Los Angeles, California 90019

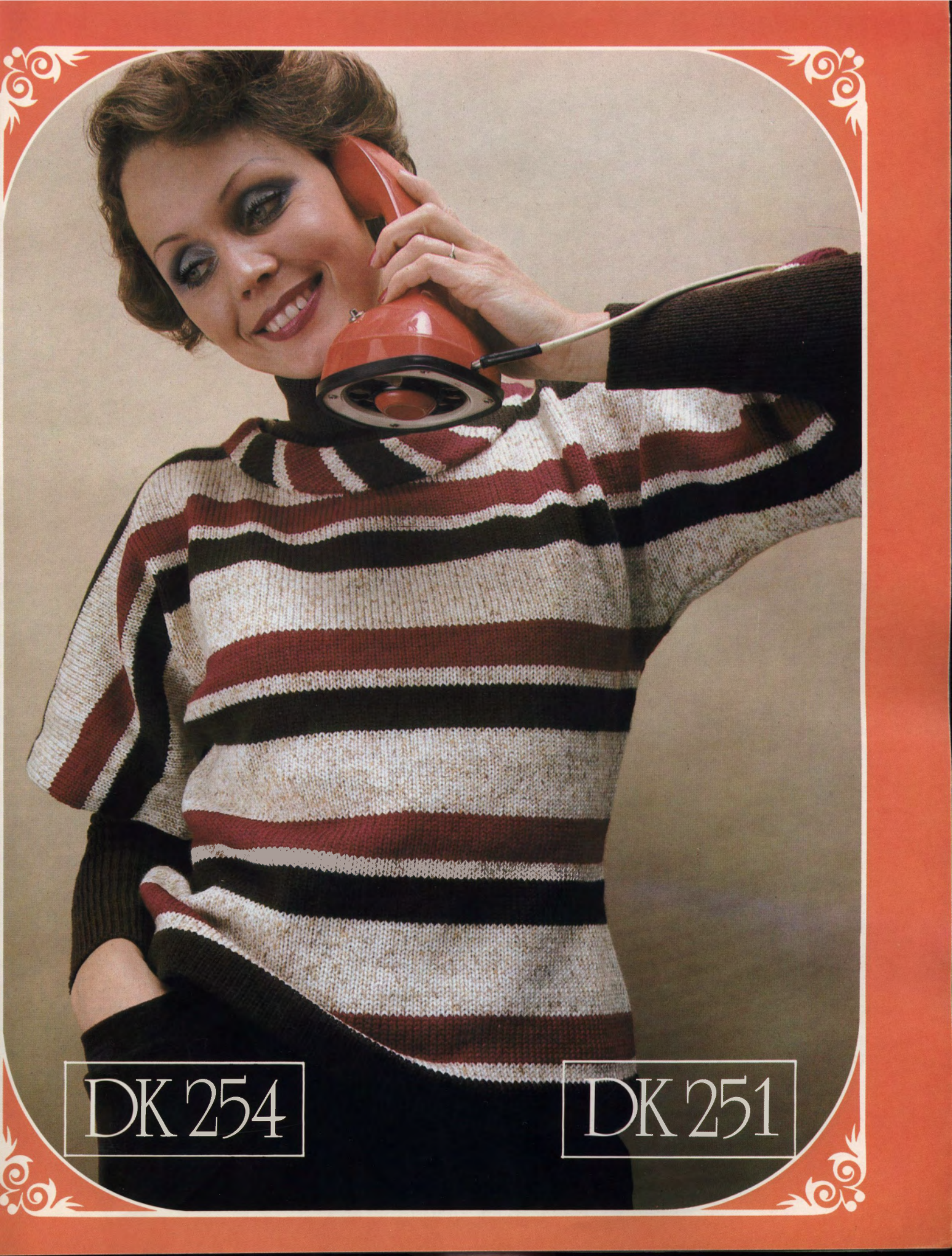

DK 254

DK 251



DK 240



DK 247



DK 252

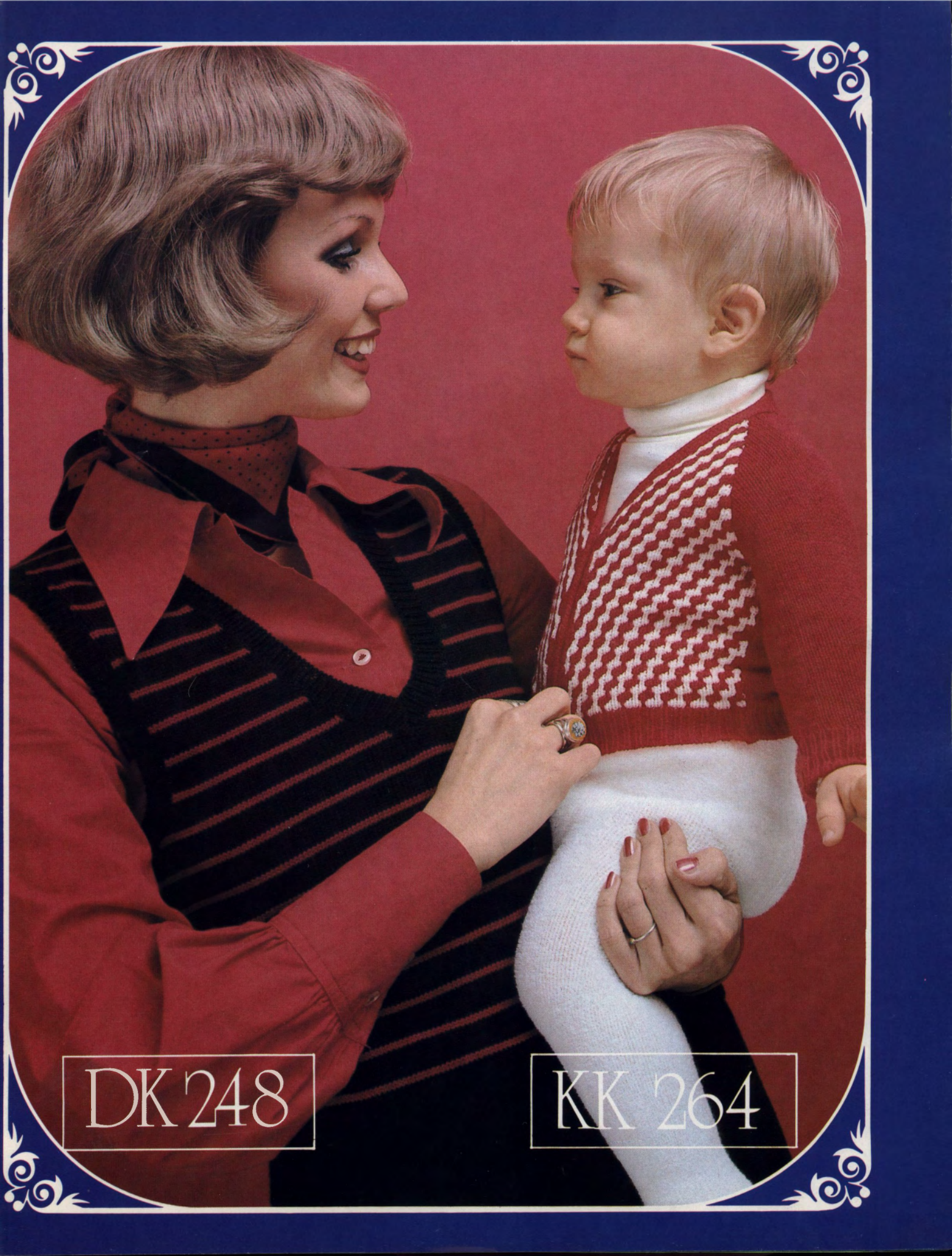

DK 248

KK 264



KK 262

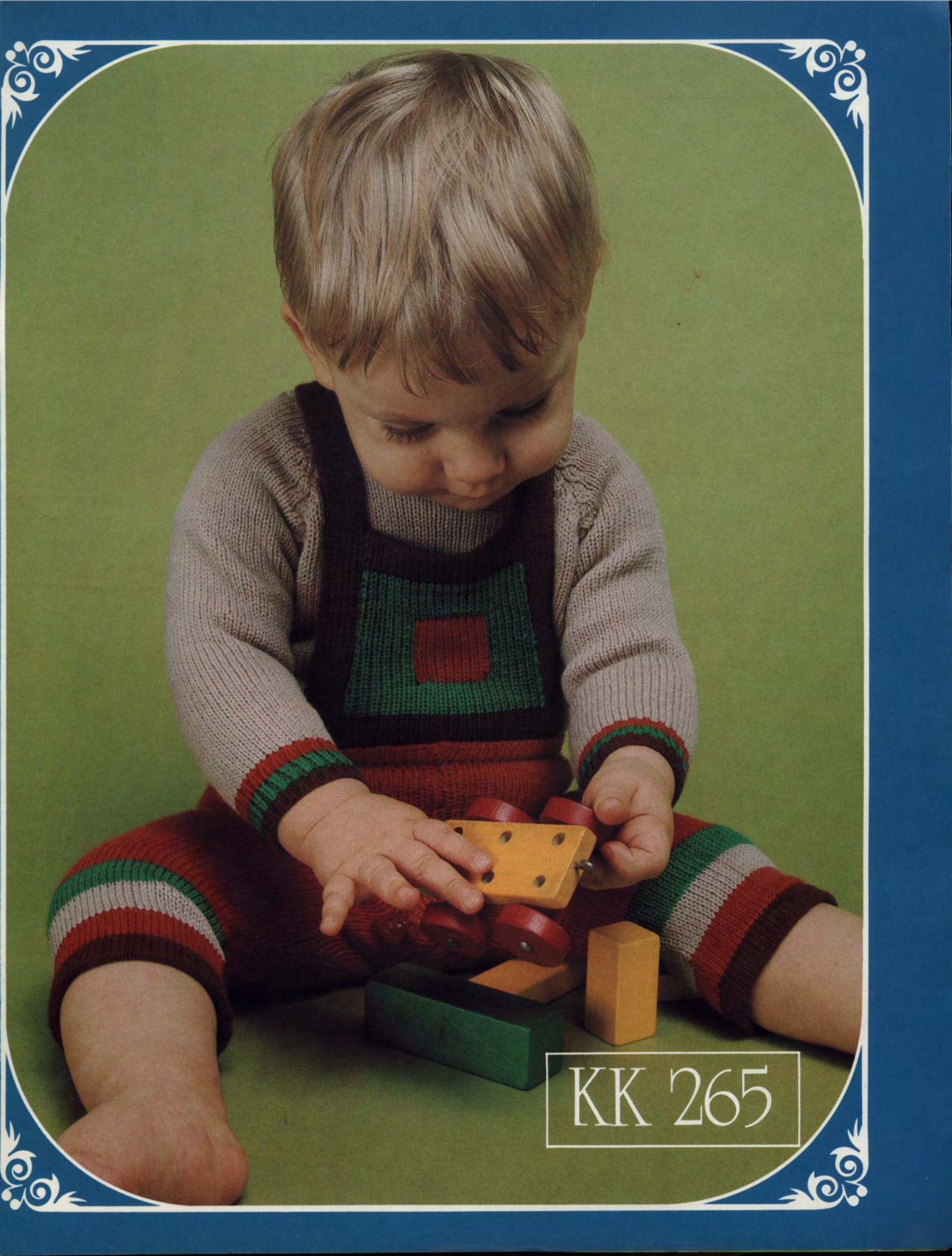

KK 265



KK 260

KK 261

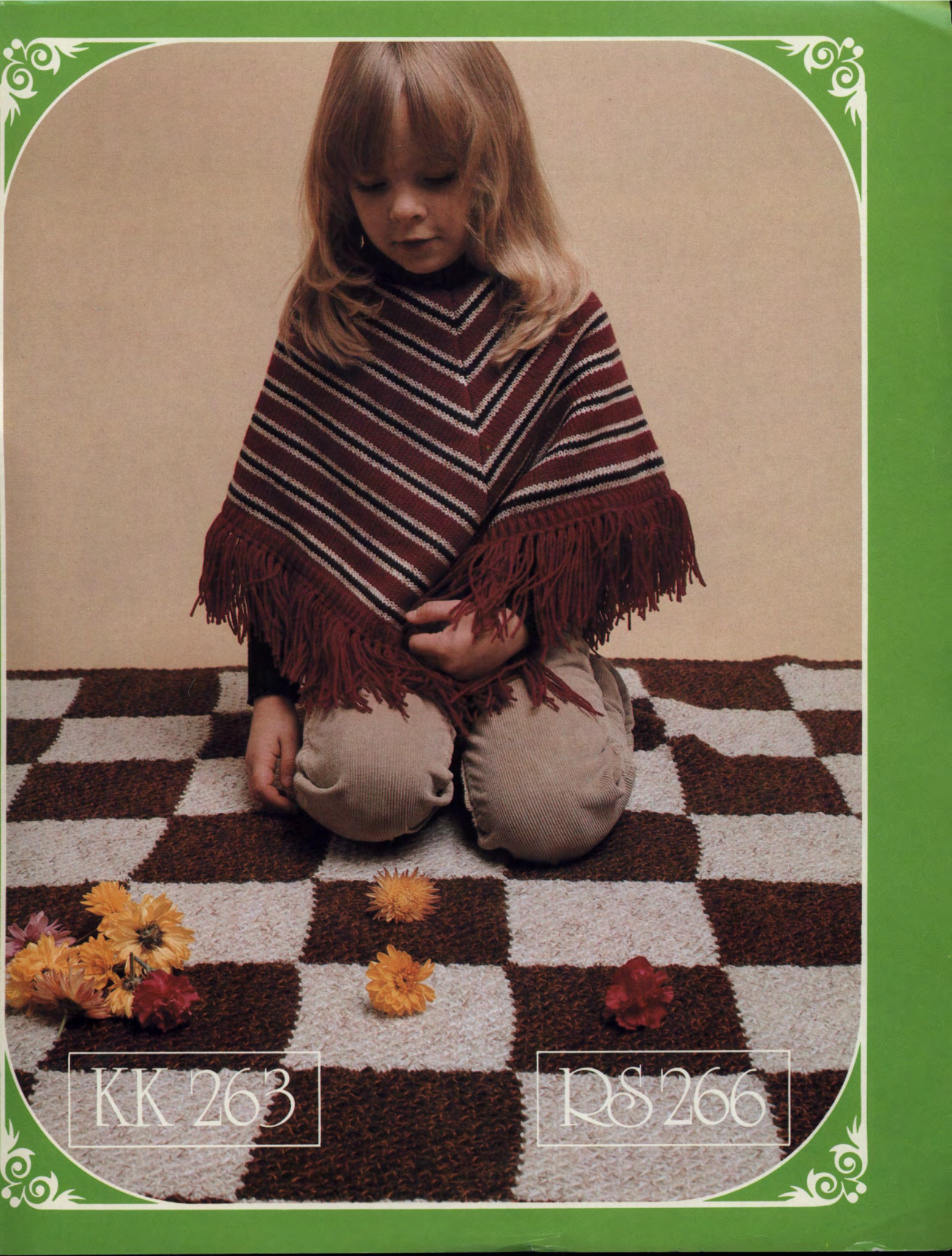

KK 263

RS 266

