

Vol. 13-No-3 March
April
1977

knitking

Magazine

Rec- June 15-1977





DK 462

X3477

HP 448



Directions p. 14

2.



DK 464

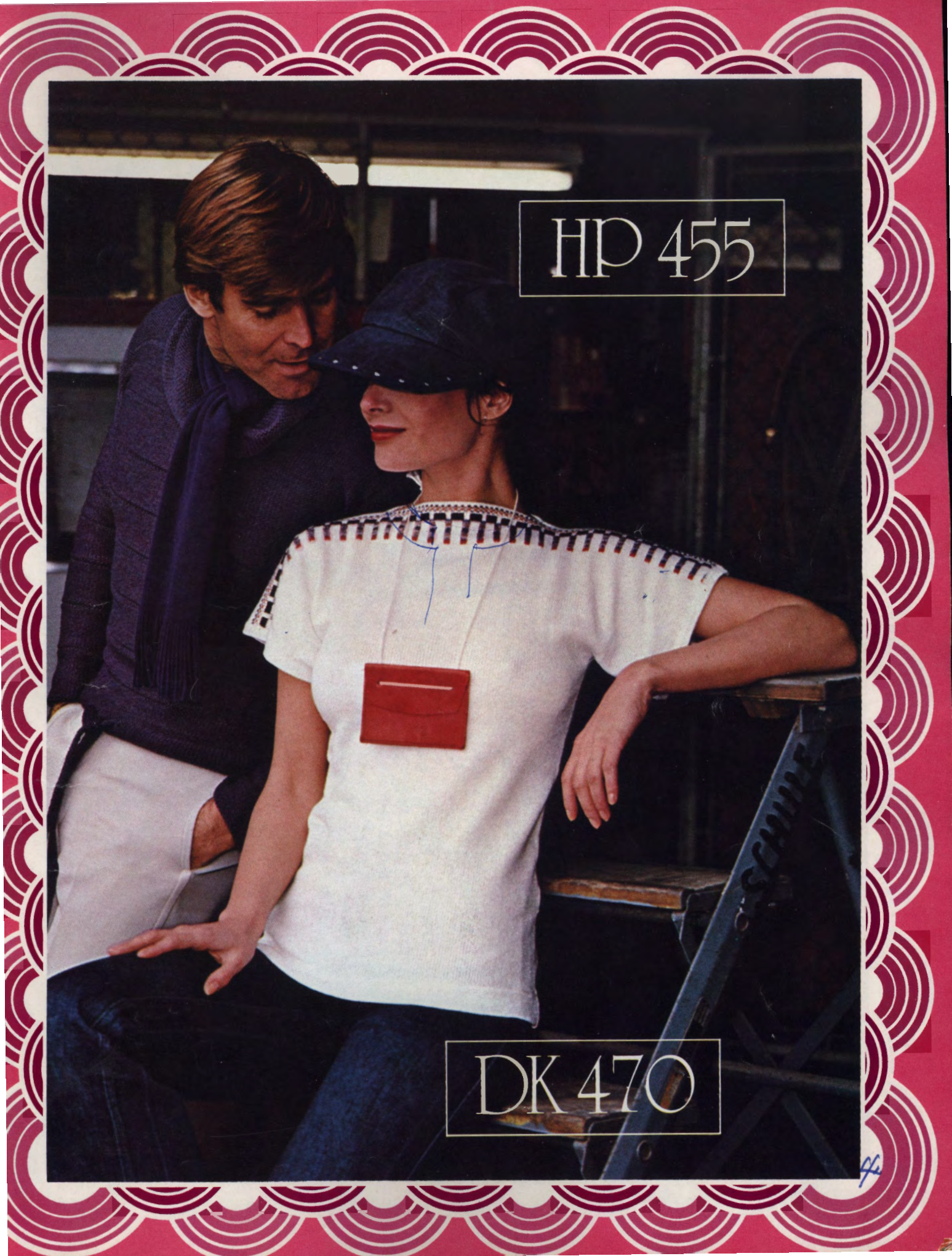

HP 455

DK 470



See p. 24

DK 460

7/8 10/12 14/16

Doris Sorensen

51

Jacket p. 25



DK 472

ca

HP 450

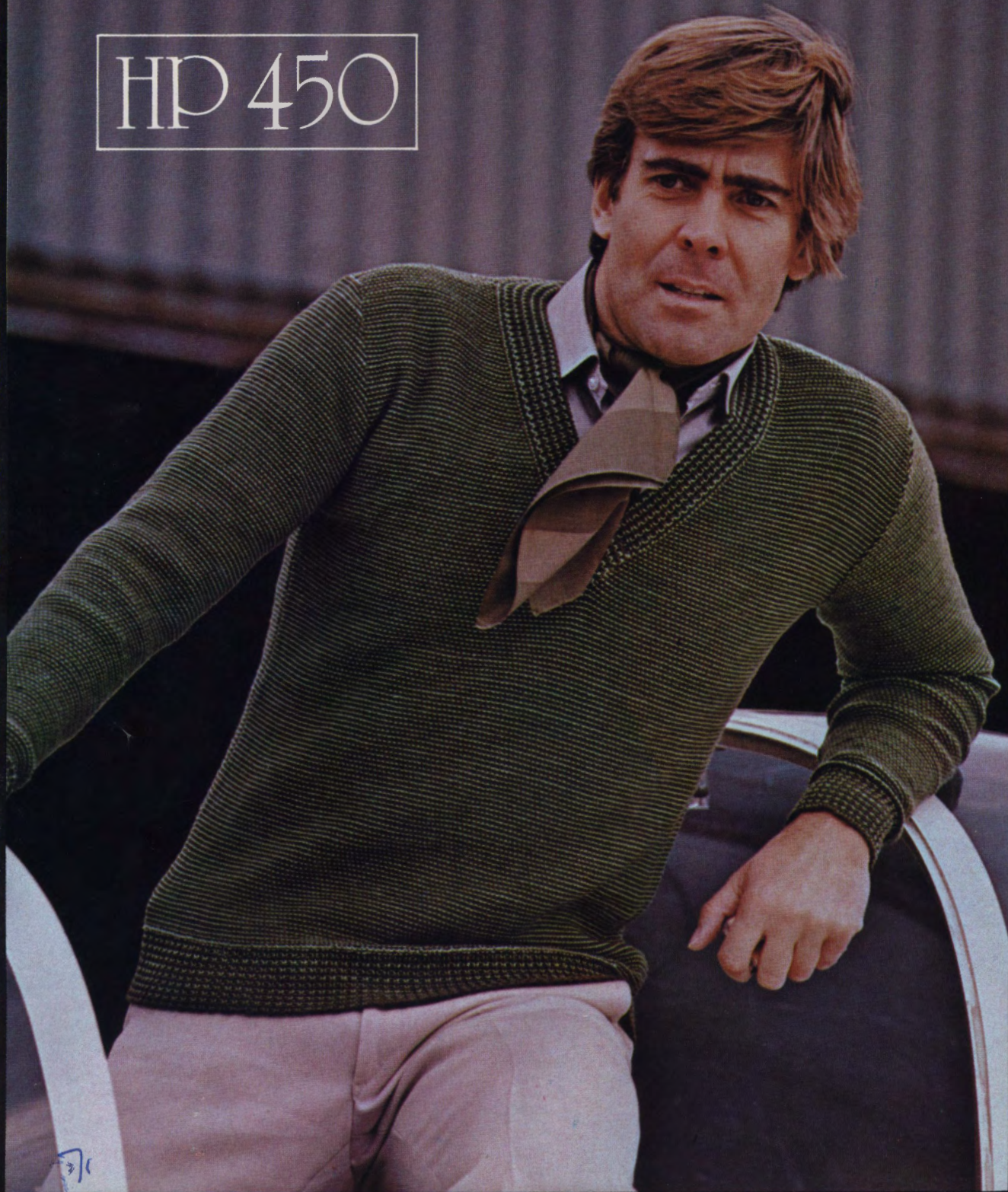

HP 451

Directions p-21 8

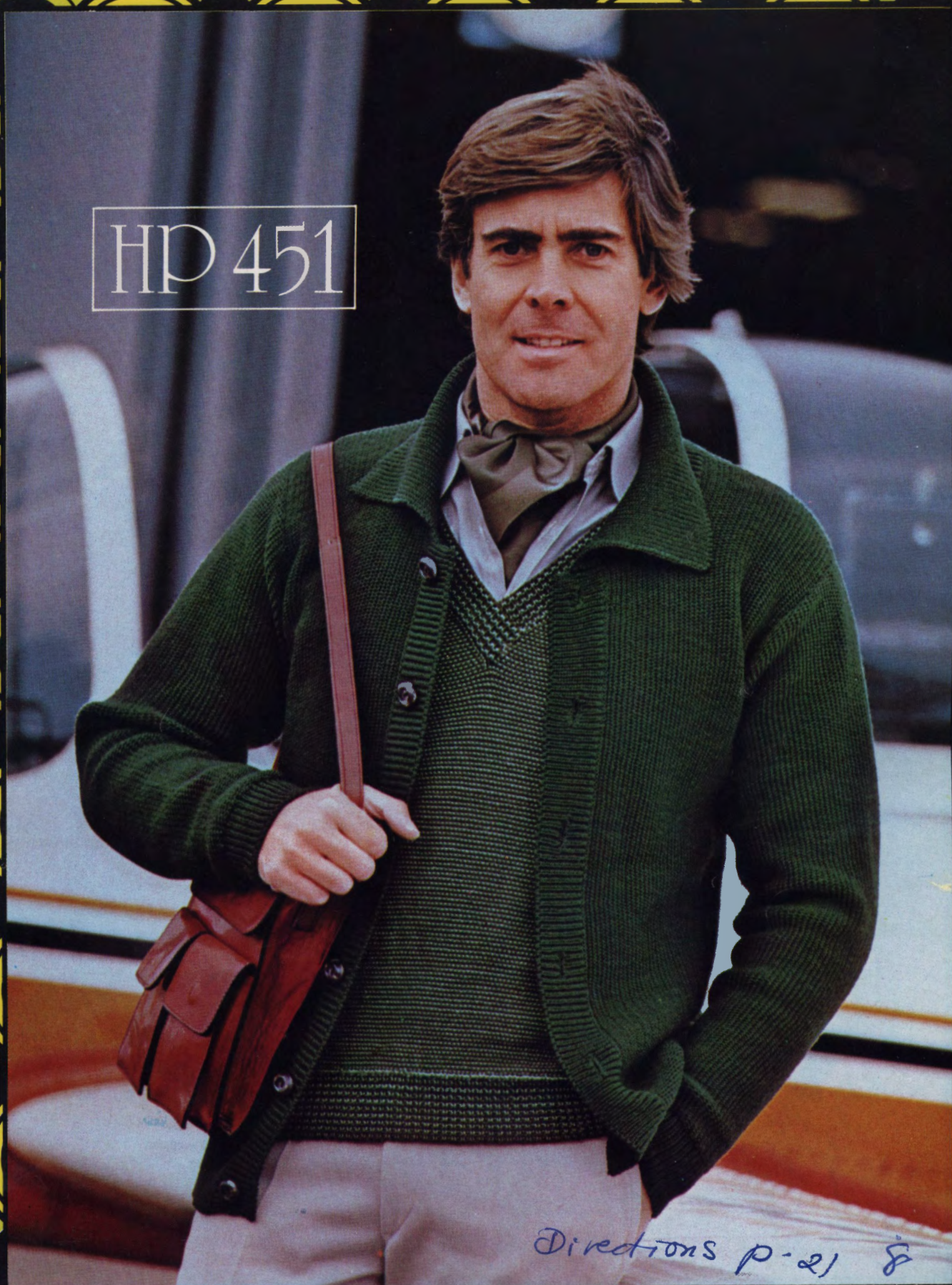

KK 453



knitking

magazine

VOLUME 13, NO. 3

TABLE OF CONTENTS

PAGE NO.

HP 448	Man's Cardigan . . . <i>picture for 2</i>	14
HP 449	Man's Pullover	15
HP 450	Man's Pullover	16
HP 451	Man's Jacket <i>picture for 8</i>	21
DK 452	Woman's Tunic	18
KK 453	Baby's Sleeping Bag	19
KK 454	Girl's Skirt & Pullover	18
HP 455	Man's Pullover	20
DK 456	Woman's Shorts	22
DK 457	Woman's Pullover	26
KK 458	Toddlers Pant Suit	23
DK 459	Woman's Halter Top	26
DK 460	Woman's Skirt & Top <i>7/8 19/12 14/16</i>	24
HP 461	Man's Pullover	28
DK 462	Woman's Pullover	30
DK 463	Woman's Jacket	32
DK 464	Woman's Raglan Pullover	27
DK 465	Woman's Dress	30
DK 466	Woman's Jacket	34
KK 467	Girl's Jacket	35
DK 468	Woman's Pullover	33
DK 469	Shoulder Bag	34
DK 470	Woman's Pullover	37
DK 471	Woman's Pullover	29
DK 472	Woman's Jacket	25
DK 473	Shoulder Bag	26

editorial

A big 'Thank You' is certainly due all those good people who take the time to write and tell us how much they look forward to KNITTING MAGAZINE... Sometimes we are taken to task for being late with an issue or two, but generally you do seem to appreciate the problems that can be encountered in the preparation and printing of a high quality publication by a company such as ours that is not in the magazine publishing business.

Your letters contain requests for specific types and styles of knitwear and among these there is an occasional one that asks for something to challenge the skill of even the technically advanced knitter. This is not easy to do as we usually try to satisfy the needs of the majority, but we have two garments in this issue, HP 448 and DK 466 that some readers will have fun knitting... If, however, you like the style of the garment, but do not want to be bothered with the detailing, you certainly can go ahead and make the man's sweater without the fancy yoke or the ladies cardigan without the Aran Isle design.

Also in this issue, we are offering the front cover garments and DK 465 in a brand new European yarn called Boucle. We have a quantity of it in stock just for readers who want to reproduce them exactly in the colors we used... Please let us know how you like the Boucle...

Talking about the colors used in our garments... We have been asked by our yarn department to suggest once more that you can make a color selection different to those used by us... Kits are not made up in advance, so you do have freedom in your color choice. Sometimes certain individual garments are so popular that we sell out entirely of the colors we used and have to write back to customers for alternates. Our Cone Yarns are made in the U.S.A. but our balled yarns come mainly from Europe... which means that it takes from 4 to 6 months to replenish stocks...

We are well stocked on practically all of our Catalogue yarns at this time so be sure to take advantage of the big discounts (given only to KNITTING MAGAZINE subscribers) explained in detail in KNITTING NEWS every issue.

Publisher: KNITTING CORPORATION, 1128 Crenshaw Blvd., Los Angeles, Calif. 90019. Telephone: (213) 938-2079. Published bi-monthly. Subscriptions: USA — \$10.00 annually, single copies \$3.00; Canada — \$12.00; other parts of the world — \$15.00. The entire contents of KNITTING MAGAZINE are copyright and must not be reproduced in any shape or form without the express permission, in writing of the publisher. © COPYRIGHT 1977 by KNITTING CORPORATION.



Knitking News

PRACTICAL KNITTING HINTS

PICKING UP STITCHES FOR A BAND

Here are some hints for picking up stitches when you wish to knit a band.

A DOUBLE BAND: Pick up the stitches from the **WRONG** side of your garment. If the purl side is the right side, pick up the stitches from the knit side. If the knit side is the right side, pick up the stitches from the purl side.

FACING: that turns in to the wrong side of garment: Pick up the stitches from the **RIGHT** side of your garment.

RIBBING BANDS: If you use the crochet method for binding off in Ribbing, pick up the sts. from the **RIGHT** side of your garment as this will give a nicer edge.

There are different methods for picking up stitches to knit a band. If you begin your garment with waste yarn and work in a Pattern stitch for the body of garment, then work the band later, you usually must decrease a specific number of rows across the knitting before working the band. Hang the sts. onto the machine, doubling the sts. as needed. Remove the waste yarn, knit 1 row Stockinette stitch, THEN transfer every other stitch to the Ribber for your K1, P1 Ribbing.

If you do not have open stitches to work from (for instance around the neck or armhole), always pick up the 2nd half of the edge stitch in order to have a neat row for the beginning of your band.

We receive letters asking for the conversion of GRAMS to OUNCES.... so we are printing a Chart which you can refer to. Most of our yarn is put up in 50 gram balls and we will use the 50 grams for our basic measure.

NUMBER OF BALLS	= GRAMS	= OUNCES
1	50	1 3/4
2	100	3 1/2
3	150	5 1/4
4	200	7
5	250	8 3/4
6	300	10 1/2
7	350	12 1/4
8	400	14
9	450	15 3/4
10	500	17 1/4
11	550	19 1/4
12	600	21
13	650	22 3/4
14	700	24 1/2
15	750	26 1/4
16	800	28
17	850	29 3/4
18	900	31 1/2
19	950	33 1/4
20	1000	35

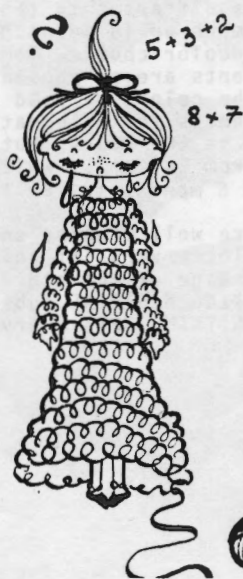

KITS - For this issue of KNITTING MAGAZINE.

HP 448 - Yarn: Allegro			
SIZES: 34/36	(38)	[40/42]	
Regular Price	\$17.49	\$19.08	\$20/67
Sale Price	13.09	14.28	15/47
Shipping Costs	1.65	1.65	1.65
HP 449 - Yarn: Binia			
SIZES: 34	(36)	[38]	
Regular Price	\$11.12	\$11.12	\$13.90
Sale Price	8.32	8.32	11.04
Shipping Costs	1.65	1.65	1.65
HP 450 - Yarn: Vienna			
SIZES: 36	(38)	[40]	
Regular Price	\$16.11	\$16.11	\$21.48
Sale Price	12.08	12.08	16.11
Shipping Costs	1.65	1.65	1.65
HP 451 - Yarn: Vienna			
SIZES: 34/36	(38/40)	[42/44]	
Regular Price	\$23.27	\$25.06	\$26.85
Sale Price	15.47	18.80	20.14
Shipping Costs	1.65	1.65	1.65
DK 452 - Yarn: Boucle			
SIZES: 10/12	(14/16)		
Regular Price	\$23.40	\$34.20	
Sale Price	17.55	25.65	
Shipping Costs	1.65	1.65	
KK 453 - Yarn: Fortissima			
SIZE: Infant			
Regular Price	\$9.54		
Sale Price	7.14		
Shipping Costs	1.00		
KK 454 - Yarn: Vienna			
SIZES: 9/10	(11/12)	[13/14]	
Regular Price	\$16.11	\$17.90	\$21.48
Sale Price	12.08	13.40	16.11
Shipping Costs	1.65	1.65	1.65
HP 455 - Yarn: Binia			
SIZES: 36	(38/40)	[42]	
Regular Price	\$15.29	\$16.68	\$19.46
Sale Price	11.44	12.48	14.56
Shipping Costs	1.65	1.65	1.65
DK 456 - Yarn: Binia			
SIZES: 8/10	(12/14)		
Regular Price	\$ 6.95	\$ 8.34	
Sale Price	5.21	6.26	
Shipping Costs	1.00	1.00	
DK 457 & DK 473 - Yarn: Binia			
SIZES: 7/8	(10/12)	[14/16]	
Regular Price	\$15.53	\$18.54	\$21.32
Sale Price	12.26	13.88	15.96
Shipping Costs	1.65	1.65	1.65
KK 458 - Yarn: Euro Sport			
SIZES: 1 to 2 years (3 to 4 years)			
Regular Price	\$ 7.74	\$10.32	
Sale Price	5.81	7.76	
Shipping Costs	1.00	1.00	
DK 459 - Yarn: Micaela = Color 1	Capriccio = Color 2.		
Regular Price	\$ 7.60	\$ 7.60	
Sale Price	5.70	5.70	
Shipping Costs	1.00	1.00	

DK 460 - Yarn: Binia
 SIZES: 7/8 (10/12) [14/16]
 Regular Price \$16.68 \$18.07 \$19.46
 Sale Price 12.48 13.52 14.56
 Shipping Costs 1.65 1.65 1.65

HP 461 - Yarn: Amore
 SIZES: 34/36 (38/40) [42]
 Regular Price \$13.41 \$14.90 \$16.39
 Sale Price 10.06 11.18 12.29
 Shipping Costs 1.65 1.65 1.65

DK 462 - Yarn: Cheri or Micaela.
 SIZES: 12/14 (16/18)
 Regular Price Micaela \$17.91 \$19.90
 Sale Price Micaela 13.41 14.90
 Shipping Costs 1.65 1.65
 1 Cone Cheri
 Regular Price 21.31 21.31
 Sale Price Cheri 15.98 15.98
 Shipping Costs 1.25 1.25

DK 463 - Yarn: Allegro
 SIZES: 8/10 (12/14) [16]
 Regular Price \$14.31 \$15.90 \$15.90
 Sale Price 10.71 11.90 11.90
 Shipping Costs 1.65 1.65 1.65

DK 464 - Yarn: Euro Sport
 SIZES: 10/12 (14/16)
 Regular Price \$24.51 \$28.38
 Sale Price 18.43 21.29
 Shipping Costs 1.65 2.15

DK 465 - Yarn Boucle
 SIZES: 8 (10) [12]
 Regular Price \$19.80 \$23.40 \$27.00
 Sale Price 14.85 17.55 20.25
 Shipping Costs 1.65 1.65 1.65

DK 466 & 469 - Yarn: Euro Sport
 SIZES: 6/8 (10/12) [14]
 Regular Price \$16.77 \$18.06 \$19.35
 Sale Price 12.61 13.95 14.55
 Shipping Costs 1.65 1.65 1.65

KK 467 - Yarn: Euro Sport
 SIZES: 7/8 (9/10) [11/12]
 Regular Price \$11.61 \$12.90 \$15.48
 Sale Price 8.71 9.70 11.64
 Shipping Costs 1.65 1.65 1.65

DK 468 - Yarn: Allegro
 SIZES: 8/10 (12/14) [16]
 Regular Price \$ 7.95 \$ 9.54 \$12.72
 Sale Price 5.95 7.14 9.52
 Shipping Costs 1.65 1.65 1.65

DK 470 - Yarn: Amore-Colors 2, 3 & 4 NOT included
 SIZES: 5/6 (7/8) [9]
 Regular Price \$ 8.94 \$8.94 \$10.42
 Sale Price 6.72 6.72 7.84
 Shipping Costs 1.00 1.00 1.00

DK 471 - Yarn: Boucle
 SIZES: 10/12 (14/16)
 Regular Price \$ 7.20 \$ 9.00
 Sale Price 5.40 6.75
 Shipping Costs 1.00 1.00

DK 472 - Yarn: Binia
 SIZES: 7/8 (10/12) [14/16]
 Regular Price \$11.12 \$12.51 \$16.68
 Sale Price 8.32 9.36 12.48
 Shipping Costs 1.65 1.65 1.65

DK 474 - Yarn: Binia
 SIZES: 8/10 (12/14)
 Regular Price \$11.12 \$12.51
 Sale Price 8.32 9.36
 Shipping Costs 1.65 1.65

BONUS PUNCH CARDS

Here are two fun cards for you to punch yourself. You can use the number of colors suggested and use your 820 Color Changer or you can use fewer colors. If you use your Color Changer, you must punch the card in REVERSE. Where the illustrated cards have holes, you leave them blank and where they are blank, you punch holes.

Use the designs on casual knits... or for childrens knits... they will love them.

6 colors are used for this Design as follows:

- 6 rows colors 1 + 2
- 2 rows color 1
- 2 rows color 2
- 2 rows color 1
- 4 rows colors 1 + 3
- 2 rows color 1
- 6 rows colors 1 + 4
- 2 rows color 1
- 4 rows colors 1 + 2
- 2 rows colors 1 + 3
- 4 rows colors 1 + 2
- 2 rows color 1
- 2 rows colors 1 + 5
- 8 rows colors 1 + 3
- 4 rows colors 1 + 2
- 4 rows colors 1 + 6
- 2 rows colors 1 + 3
- 2 rows color 1

REPEAT from the beginning.

Plan your own colors for this Card... you can use 8 or less colors for a REPEAT Design or use the Card as a BORDER Design.

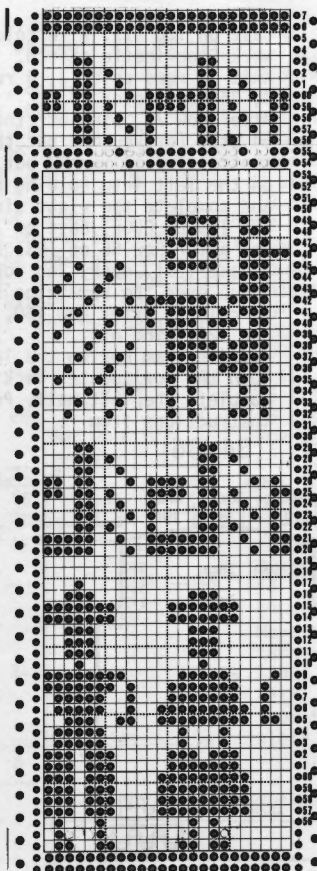
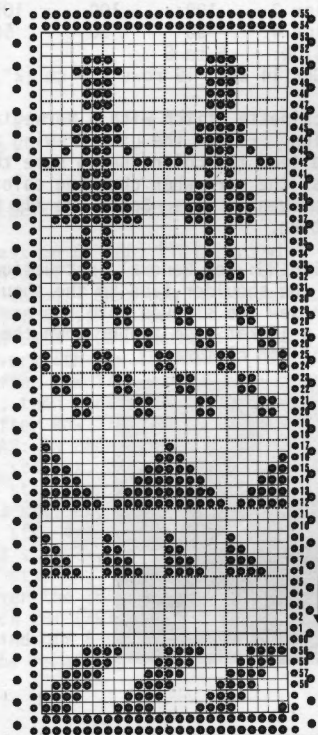

HP 448

SIZES: 34/36 (38) [40/42]
 YARN: Allegro
 GRAMS:
 Color 1 350 400 450
 Color 2 50 50 50
 Color 3 100 100 100
 Color 4 50 50 50
 TENSION: 6 to 8
 GAUGE: 14 sts. 19 rows = 5 cm (2")

Stockinette stitch with a Norwegian Design. Follow the Line Drawing and hand feed the colors being sure to cross the yarn when changing color to prevent a hole. Bands are K1, P1 Ribbing.

FINISHING: See General Instructions. Sew the shoulder tabs to the shoulders then sew the sleeves into the armholes. Sew a jacket type zipper down the front for closure.

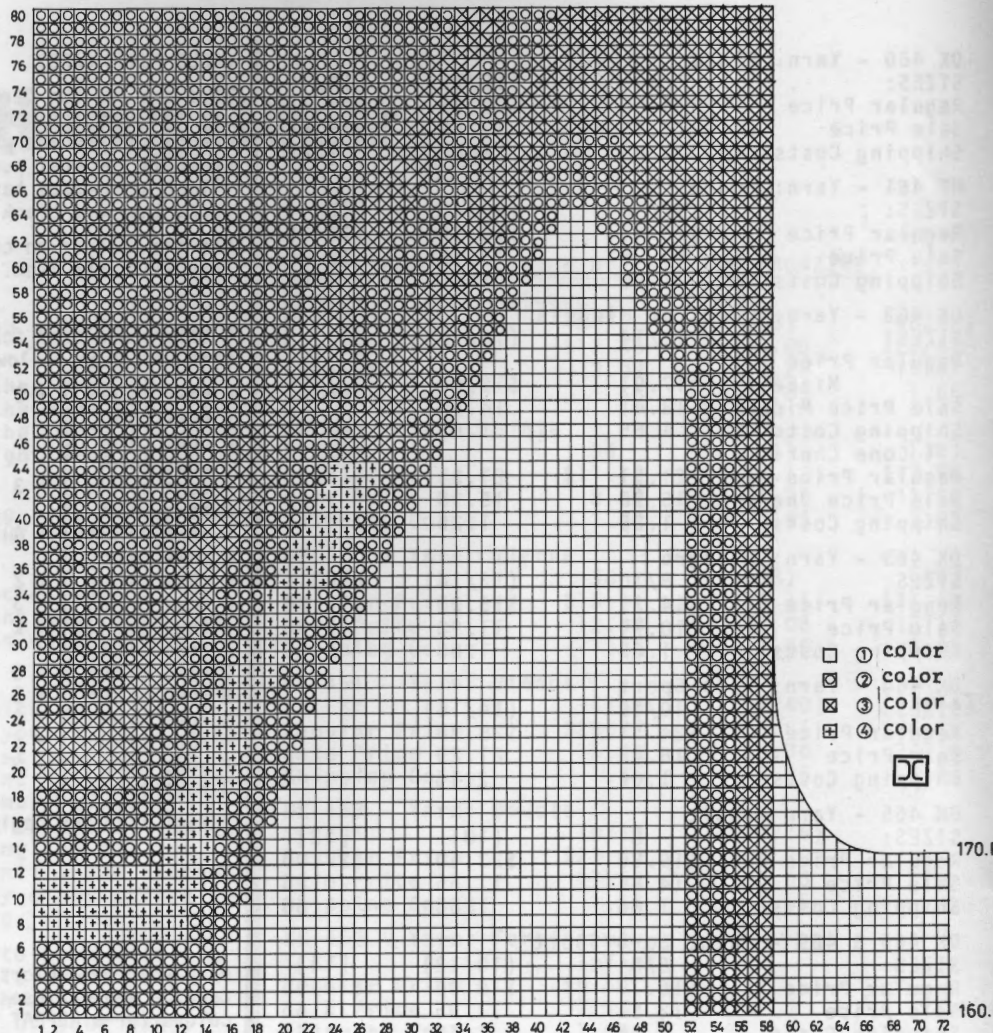

□ ① color
 ◻ ② color
 ⊕ ③ color
 ⊕ ④ color

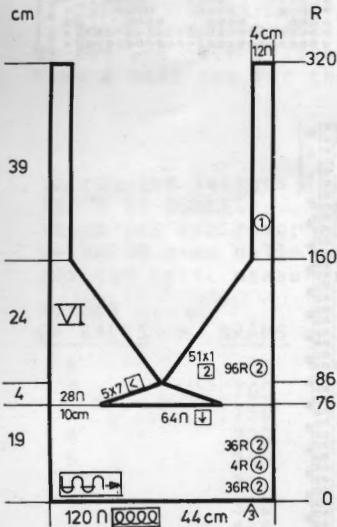

COLLAR & FACING:

Cast on 120 sts. with color 2 and work Stockinette stitch. Knit 36 rows color 2, 4 rows color 4, 36 rows color 2. After Row 76, bind off the center 64 sts. (or you may put the sts. onto contrast waste yarn), put the needles on the left into holding position and complete the right side first. *ON INSIDE EDGE, cast on 7 sts. 5x and after Row 86 on INSIDE edge, decrease 1 st. every 2nd row 51x. Continue over the remaining sts. changing to color 1 after Row 160. After Row 320, bind off. Move the Cam Box to the left side, turn the Row Counter back to 76 and complete the left half. Follow the instructions from *.

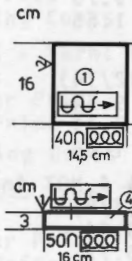

POCKET: Make 2.

Cast on 40 sts. with color 1 and work 60 rows Stockinette stitch then bind off. Sew this to sides of back marked 2.

POCKET BAND: Make 2.

Cast on 50 sts. with color 4 and work 14 rows Stockinette stitch, then bind off. Sew this to fronts of jacket marked 1.

BACK: II

Cast on 134 (142) [152] sts. with color 1 and work 40 rows K1, P1 Ribbing. Continue in Stockinette stitch with color 1. SHAPE ARMHOLE: ON EACH SIDE, bind off 4 sts. 1x, 3 sts. 1x, 2 sts. 2x, 1 st. 3x. (4 sts. 1x, 3 sts. 1x, 2 sts. 2x, 1 st. 4x). [4 sts. 1x, 3 sts. 2x, 2 sts. 2x, 1 st. 4x]. Knit to Row 234 (238) [248]. SHAPE SHOULDER: ON EACH SIDE, bind off 8 sts. 4x, 7 sts. 1x. (9 sts. 4x, 6 sts. 1x). [9 sts. 4x, 6 sts. 1x]. After Row 244 (248) [248], bind off the remaining sts.

34/36

(38)

[40/42]

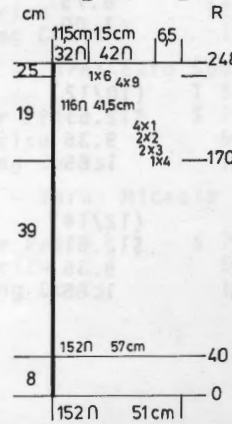
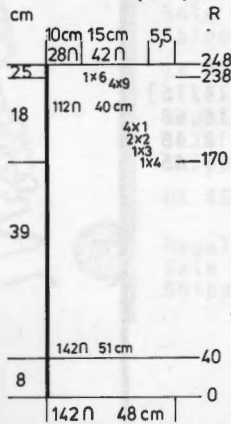
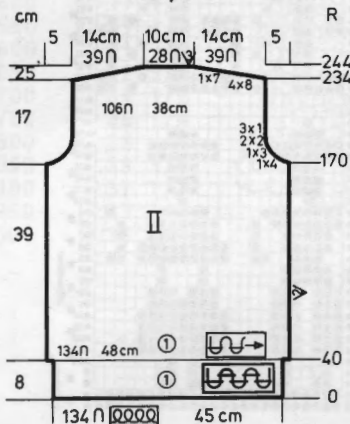

34/36

(38)

[40/42]

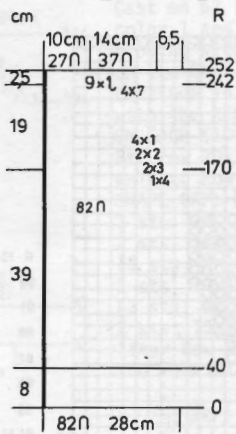
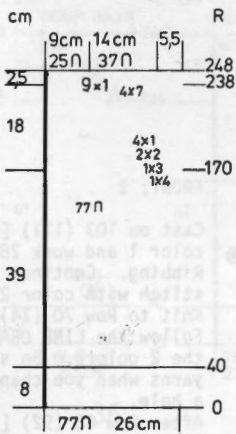
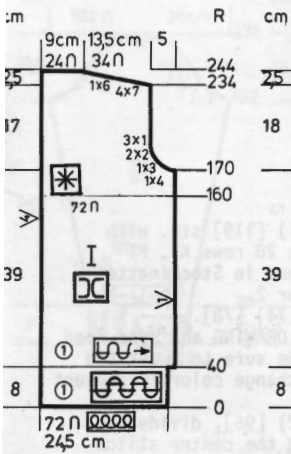

FRONT: I Make 1, reverse 1.

Cast on 72 (77) [82] sts. with color 1 and work 40 rows K1, P1 Ribbing. Continue in Stockinette stitch with color 1. Knit to Row 160.

Continue in the Norwegian Design, following the Line Drawing.

After Row 170, SHAPE ARMHOLE on the right (left for 2nd section) same as you did the back.

Knit to Row 234 (242) [242].

SHAPE SHOULDER: Bind off 7 sts. 4x, 6 sts. 1x.

(7 sts. 4x, 9 sts. 1x).

[7 sts. 4x, 9 sts. 1x].

After Row 244 (248) [252], bind off the remaining sts.



34/36

(38)

[40/42]

SLEEVES: III Make 1, reverse 1.

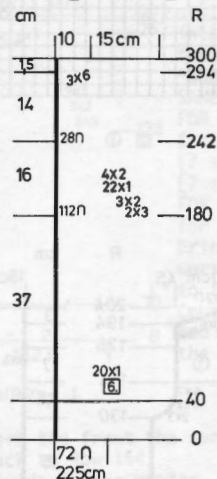
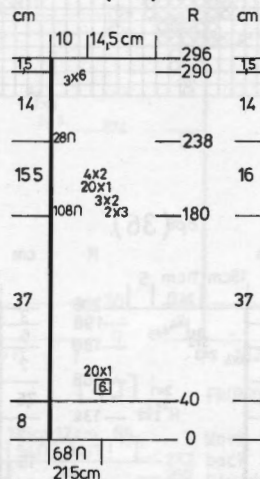
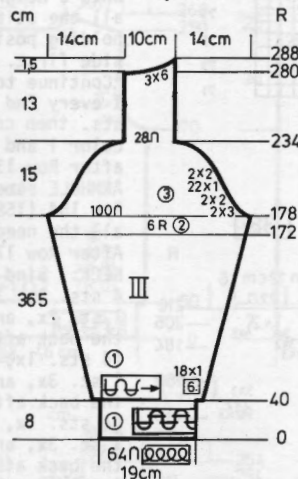

Cast on 64 (68) [72] sts. with color 1 and work 40 rows K1, P1 Ribbing. Continue in Stockinette stitch with color 1. ON EACH SIDE, increase 1 st. every 6th row 18x (20x) [20x]. After Row 172, work 6 rows color 2, then continue with color 3. After Row 178 (180) [180], SHAPE CAP: ON EACH SIDE, bind off 3 sts. 2x, 2 sts. 2x, 1 st. 22x, 2 sts. 2x. (3 sts. 2x, 2 sts. 3x, 1 st. 20x, 2 sts. 4x). [3 sts. 2x, 2 sts. 3x, 1 st. 22x, 2 sts. 4x]. Over the 28 remaining sts, knit to Row 281 (291) [295]. Bind off 6 sts. 3x, then bind off the remaining 10 sts.

HP 449

MAN'S PULLOVER

SIZES: 34 (36) [38/40]
YARN: Binia
GRAMS: Color 1 200 200 250
Color 2 200 200 250
TENSION: 9 or 10
GAUGE: 11 sts. 16 rows = 5 cm (2")

Stockinette stitch with a Norwegian Design at neck section. Follow the Line Drawing. Bands are Ribbed.

FINISHING: See General Instructions. Sew in a Zipper.

COLLAR:

Cast on 131 (139) [139] sts. with color 1 and work K1, P1 Ribbing. ON EACH SIDE, decrease 2 sts. 6x. After Row 50, bind off the center 59 (67) [67] sts., put the needles on the left into holding position and complete the right side first. *ON INNER EDGE, bind off 8 sts. 3x. Move the Cam Box to the left side, THEN bring the needles into working position. Transfer the proper sts. to the Ribber and complete the left half. Follow the instructions from *.

BACK: II

Cast on 102 (110) [118] sts. with color 1 and work 28 rows K1, P1 Ribbing. Continue in Stockinette stitch with color 2. Knit to Row 130 (134) [138]. SHAPE ARMHOLE: ON EACH SIDE, bind off 3 sts. 1x, 2 sts. 2x, 1 st. 4x. (3 sts. 1x, 2 sts. 3x, 1 st. 3x). [3 sts. 1x, 2 sts. 3x, 1 st. 4x]. Knit to Row 172 (176) [180]. Continue with color 1. Knit to Row 194 (198) [206]. SHAPE SHOULDER and watch for NECK SHAPING. FOR SHOULDER, bind off 4 sts. 4x, 6 sts. 1x, (5 sts. 4x, 4 sts. 1x), [5 sts. 4x, 7 sts. 1x]. FOR NECK, after Row 198 (202), [212], bind off the center 24 sts. put the needles on the left into holding position and complete the right side first. *ON NECK SIDE, bind off 3 sts. 1x, 2 sts. 1x, 1 st. 1x. (4 sts. 1x, 2 sts. 1x, 1 st. 1x). [4 sts. 1x, 2 sts. 1x, 1 st. 1x]. Move the Cam Box to the left side, turn the Row Counter back to 198 (202) [212] and complete the left half. Follow the instructions from * and don't forget to complete the shoulder shaping.

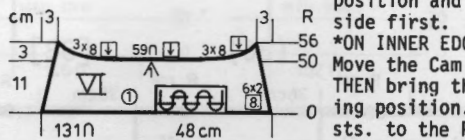

34

(36)

[38]

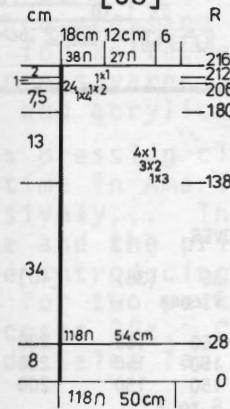
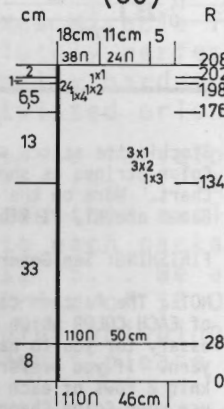
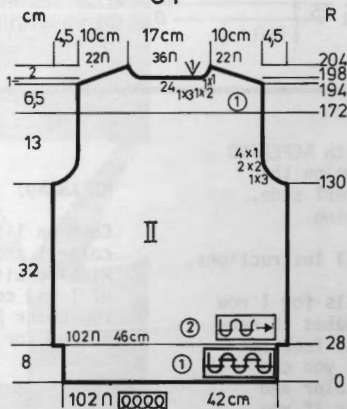

Continued



HP 449

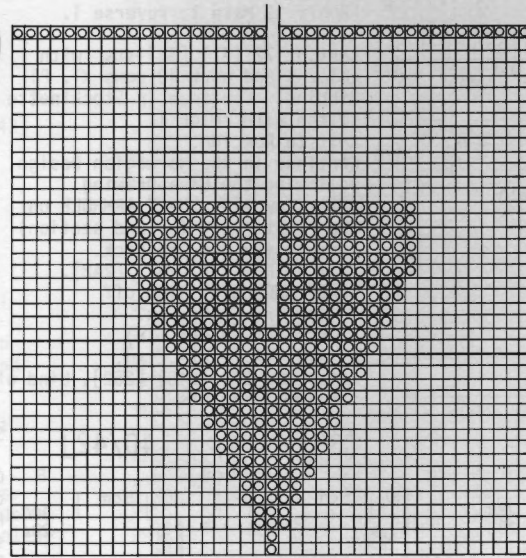

FRONT: I

R 154 \otimes
93
91
89
87
85
83
81
79
77
75
73
71

Cast on 103 (111) [119] sts. with color 1 and work 28 rows K1, P1 Ribbing. Continue in Stockinette stitch with color 2.
Knit to Row 70 (74) [78].
Follow the LINE DRAWING and hand feed the 2 colors. Be sure to twist the yarns when you change color to prevent a hole.
After Row 88 (92) [96], divide in the center. Hang the center stitch onto a neighboring needle and put all the stitches on the left into holding position to complete the right side first.

*Continue to add the 1 st. of color 1 every 2nd row until there are 11 sts. then continue with 11 sts. in color 1 and the rest in color 2 and after Row 130 (134) [138], SHAPE ARMHOLE same as the back and after Row 154 (158) [162], continue over all the needles with color 1.

After Row 177 (181) [185], SHAPE

NECK: Bind off

4 sts. 1x, 3 sts. 2x, 2 sts. 3x, 1 st. 2x, and SHAPE SHOULDER same as the back after Row 194.

(4 sts. 1x, 3 sts. 2x, 2 sts. 3x, 1 st. 3x, and SHAPE SHOULDER same as the back after Row 198).

[4 sts. 1x, 3 sts. 2x, 2 sts. 3x, 1 st. 3x, and SHAPE SHOULDER same as the back after Row 206].

Bring the needles on the left into working position, knit 1 row to the left side, turn the Row Counter back to 88 (92) [96] and complete the left half. Follow the instructions from *.

SLEEVES: III

Cast on 66 (70) [74] sts. with color 1 and work 14 rows K1, P1 Ribbing. Continue in Stockinette stitch. ON EACH SIDE, increase 1 st. every 6th row 6x.

Knit to Row 50.

SHAPE CAP: ON EACH SIDE, bind off

3 sts. 2x, 2 sts. 3x, 1 st. 10x, 2 sts. 4x.

(3 sts. 2x, 2 sts. 3x, 1 st. 12x, 2 sts. 4x).

[3 sts. 2x, 2 sts. 3x, 1 st. 12x, 2 sts. 5x].

After Row 88 (92) [94], bind off the remaining sts.

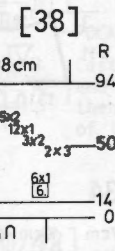
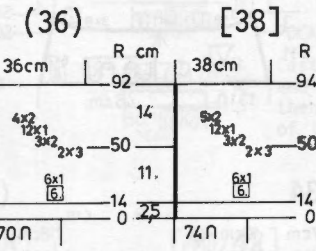
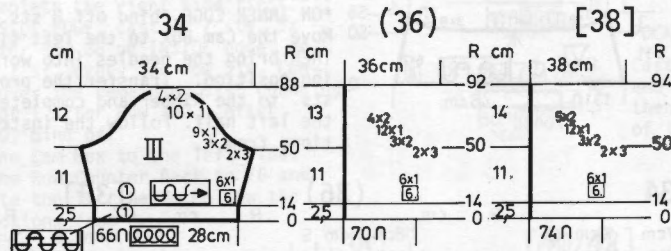
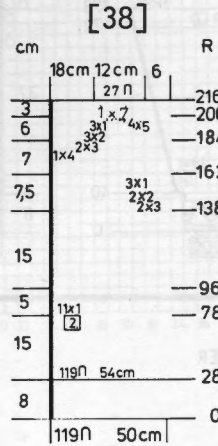
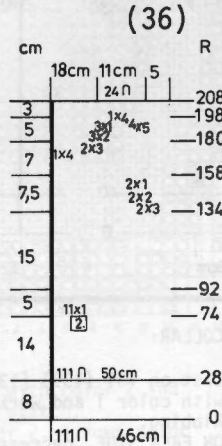
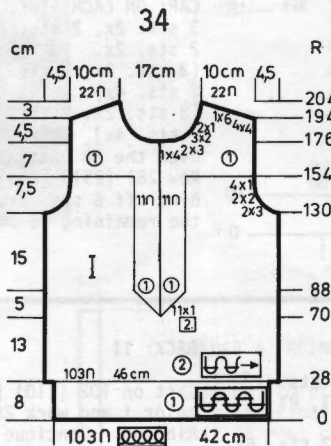

HP 450

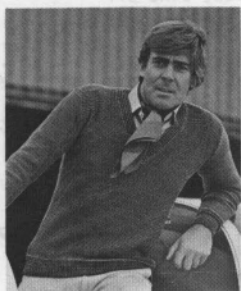

MAN'S PULLOVER

SIZES: 36 (38) [40]
YARN: Vienna
GRAMS:
Color 1 150 150 200
Color 2 150 150 200
Color 3 150 150 200
TENSION: 5 to 7
GAUGE: 14 sts. 16 rows = 5 cm (2")

Stockinette stitch with REPEATED Color Stripes as shown on the Chart. Worn on the Purl side. Bands are K1, P1 Ribbing.

FINISHING: See General Instructions.

NOTE: The Pattern calls for 1 row of EACH COLOR which makes it necessary for you to hand feed the yarn. If you prefer, you can knit 2 rows of each color and use your Color Changer if you own one.

NECKBAND: Make 2.

Cast on 115 (119) [123] sts. with color 1 and work 18 rows K1, P1 Ribbing with REPEATED color stripes of 1 row color 1, 1 row color 2, 1 row color 3. Bind off the crocheted method for Ribbing.

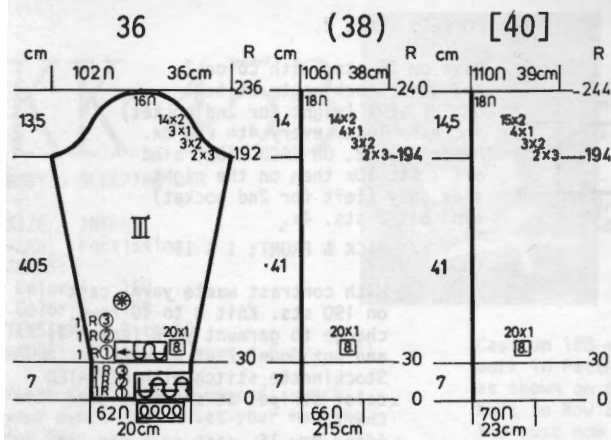

SLEEVES: III
 Cast on 62 (66) [70] sts. with color 1 and work 30 rows K1, P1 Ribbing with color stripes as shown on the Chart.
 Continue in Stockinette stitch with the REPEATED color stripes. ON EACH SIDE, increase 1 st. every 8th row 20x.
 Knit to Row 192 (194) [194].
 SHAPE CAP: ON EACH SIDE, bind off 3 sts. 2x, 2 sts. 3x, 1 st. 3x, 2 sts. 14x.
 (3 sts. 2x, 2 sts. 3x, 1 st. 4x, 2 sts. 14x).
 [3 sts. 2x, 2 sts. 3x, 1 st. 4x, 2 sts. 15x].
 After Row 236 (240) [244], bind off the remaining sts.

BACK: II
 Cast on 138 (146) [152] sts. with color 1 and work 30 rows K1, P1 Ribbing with REPEATED color stripes as shown on the Chart.
 Continue in Stockinette stitch the REPEATED color stripes.
 Knit to Row 170 (174) [178].
 SHAPE ARMHOLE: ON EACH SIDE, bind off 3 sts. 2x, 2 sts. 3x, 1 st. 3x. (3 sts. 2x, 2 sts. 2x, 1 st. 4x). [3 sts. 2x, 2 sts. 3x, 1 st. 3x].
 Knit to Row 250 (254) [262].
 Bind off the center 28 (28) [30] sts., put the needles on the left into holding position and complete the right side first.
 *SHAPE SHOULDER AND NECK AT THE SAME TIME.
 FOR SHOULDER, bind off 6 sts. 5x. (7 sts. 4x, 5 sts. 1x). [7 sts. 4x, 6 sts. 1x].
 FOR NECK, bind off 3 sts. 4x for all sizes.
 Bring the needles on the left into working position, knit 1 row (watch color) to the left side, turn the Row Counter back to 250 (254) [262] and complete the left half. Follow the instructions from *.

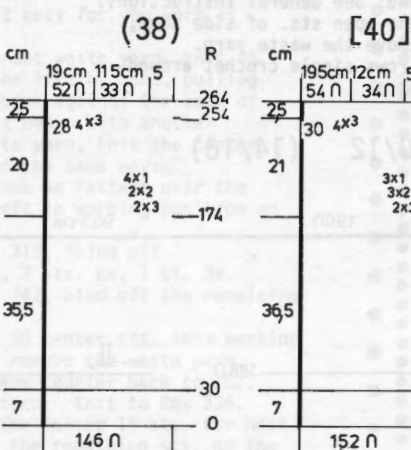
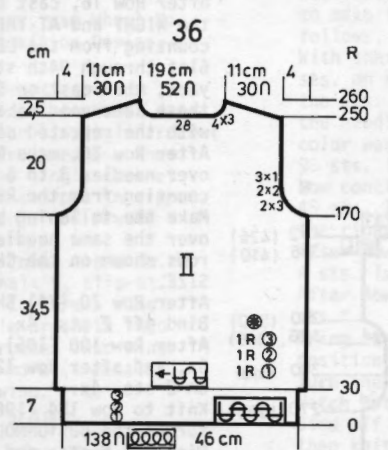

[40]
 Measurements include 195cm, 12cm, 55, 272, 262, 30, 4x3, 21, 3x1, 3x2, 2x3, 178, 365, 30, 7, 0, 152n.

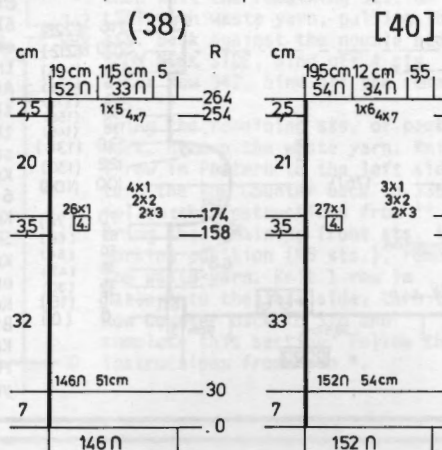
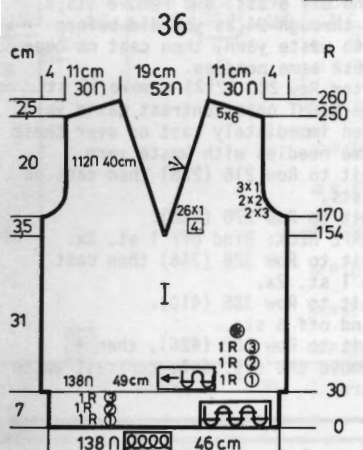

FRONT: I
 Work the front the same as the back to Row 154.
 Divide in the center, put the needles on the left into holding position and complete the right side first.
 *SHAPE NECK, but at the SAME TIME, SHAPE ARMHOLE same as the back after Row 170 (174) [178].
 FOR NECK, decrease 1 st. every 4th row 26x (26x) [27x].
 After Row 250 (254) [262], SHAPE SHOULDER same as the back.
 Bring the needles on the left into working position, knit 1 row to the left side (watch color), turn the Row Counter back to 154 (158) [162] and complete the left half. Follow the instructions from *.

NEW! Pressing Cloths

New Miracle fibre pressing cloths... absolutely perfect for knits, even for the normally hard to press yarns, especially tight twisted orlons and acrylics...

These marvelous pressing cloths are available for the first time in America... and KNITTING has them exclusively... There are two cloths to each package and the price per package is \$2.75... We are introducing them at a Special Price of \$5.00 for two packets (4 cloths) plus Shipping costs 39¢. California residents please add Sales Tax.

ORDER DIRECT FROM:
 KNITTING - 1128 Crenshaw Blvd., Los Angeles, Calif. 90019

DK 452

WOMAN'S TUNIC

SIZES: 10/12 (14/16)
 YARN: Boucle
 GRAMS:
 Color 1 150 200
 Color 2 100 150
 Color 3 100 150
 Color 4 100 150
 Color 5 100 150
 Color 6 100 150
 TENSION: 8 to 10
 GAUGE: 10 1/2 sts. 20 rows = 5 cm

Stockinette stitch with color stripes as shown on the Chart. Knitted sideways on the machine. The Purl side is the right side.

FINISHING: See General Instructions. Weave the open sts. of side seam, then remove the waste yarn. Work 2 rows single crochet around neckline.

POCKET: Make 2.

Cast on 36 sts. with color 2 and work Stockinette stitch. ON THE LEFT (right for 2nd pocket) increase 1 st. every 4th row 8x. After Row 32, ON EACH SIDE, bind off 1 st. 10x then on the right side only (left for 2nd pocket) bind off 2 sts. 4x.

BACK & FRONT: I & II

With contrast waste yarn, cast on 190 sts. Knit 8 to 10 rows, change to garment yarn (color 1) and put Counter at 0. Work Stockinette stitch with REPEATED color stripes as shown on the Chart.

After Row 16, cast on 6 sts. on the RIGHT and AT THE SAME TIME, counting from the LEFT, remove the 61st through 94th sts. onto waste yarn, then cast on 34 sts. over these same needles and continue with the repeated color stripes. After Row 26, make BUTTONHOLES over needles 3 to 6 and 9 to 12 counting from the RIGHT edge. Make the following buttonholes over the rows shown on the Chart for YOUR SIZE.

After Row 70 (74) SHAPE NECK: Bind off 2 sts. 4x, 1 st. 6x. After Row 100 (106), cast on 1 st. 6x, and after Row 122 (130), cast on 2 sts. 4x.

Knit to Row 184 (196) but don't forget the BUTTONHOLES. Bind off 6 sts. and remove sts. 61 through 94 as you did before onto waste yarn, then cast on over these same needles.

After Row 200 (212) remove 52 sts. on the RIGHT onto contrast waste yarn, then immediately cast on over these same needles with waste yarn. Knit to Row 216 (228) then cast on 6 sts.

Knit to Row 270 (286). SHAPE NECK: Bind off 1 st. 2x. Knit to Row 326 (346) then cast on 1 st. 2x.

Knit to Row 386 (410). Bind off 6 sts. Knit to Row 402 (426), then remove the sts. onto contrast waste yarn.

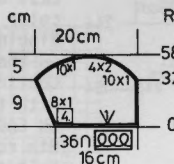

10/12 (14/16)

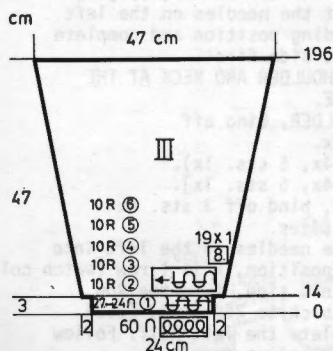

SLEEVES: III (Reverse buttonhole side for 2nd sleeve).

Cast on 60 sts with color 1 and work 14 rows K1, P1 Ribbing, making BUTTONHOLE after Row 7 over needles 24 to 27 counting from the LEFT (right). Continue in Stockinette stitch with REPEATED color stripes as shown on the Chart. ON EACH SIDE, increase 1 st. every 8th row 19x. Knit to Row 196. Bind off.

10/12 (14/16)

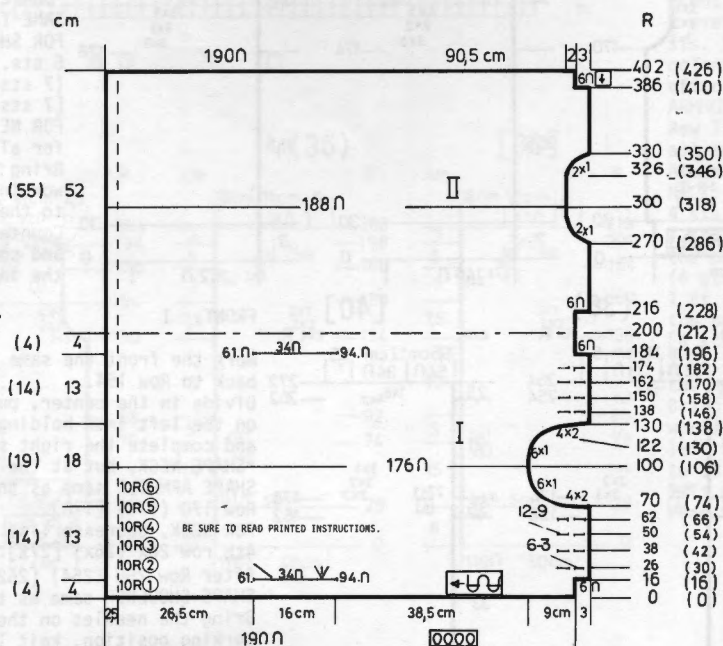

KK 454



GIRL'S SKIRT & PULLOVER

SIZES: 9/10 (11/12) [13/14]
 YARN: Vienna
 GRAMS:
 Color 1 300 350 350
 Color 2 100 100 150
 Color 3 50 50 100
 TENSION: 7 to 9
 GAUGE: 15 sts. 20 rows = 5 cm (2")

Stockinette stitch with color stripes as shown on the Chart. Lower edge and sleeve bands are K1, P1 Ribbing. Worn on the Purl side.

FINISHING: See General Instructions.

SKIRT: IV/V Make 6 sections.

Cast on 90 (96) [100] sts. with color 1 and work Stockinette stitch to Row 12. Continue with the color stripes as shown on the Chart and ON EACH SIDE, decrease 1 st. every 6th row 29x (31x) [32x]. Knit to Row 190 (200) [208]. Remove the sts. onto contrast waste yarn.

WAISTBAND: Hang the open sts. of the 6 sections back onto the machine, decreasing to 170 (182) [194] sts. With color 1, knit 1 row Stockinette stitch then transfer every other stitch to the Ribber and work 10 rows K1, P1 Ribbing then bind off the crochet method for Ribbing.

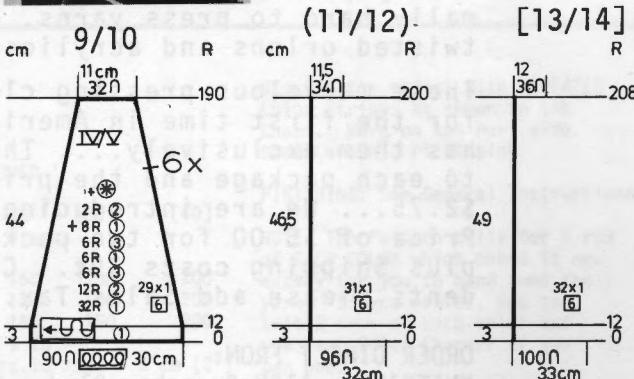

KK 453

BABY'S SLEEPING BAG

SIZE: INFANT
 YARN: Fortissima
 GRAMS:
 Color 1 150
 Color 2 150
 TENSION: 8 to 10
 GAUGE: 13 sts. 26 rows = 5 cm. (2")

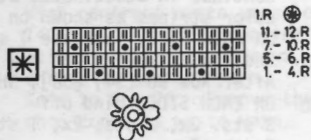

Punch Card Machine owners, punch your own card and set your machine for TUCK.
 AM 3 machine owners, use Wheel No. 3 for a Holding Position Design.

FINISHING: Fold fronts over to the center. Sew shoulders then set in sleeves. With color 1, single crochet around neck and front edges, then work 1 row reverse single crochet. Sew up lower edge and put in zipper. Make crochet flowers and sew in place. See picture.

CROCHET FLOWERS: Color 1 and No. 2 crochet hook. Chain 5, slip st. into first chain to form a ring. *Chain 3, 4 double crochets into ring, 1 single crochet into ring. REPEAT from * 3x more (4 petals). Leave end for sewing.

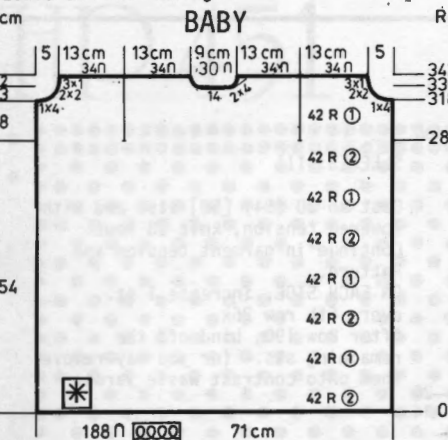

Cast on 188 sts. with color 2 and work in Pattern with color stripes as shown on the Chart.

Knit to Row 282. You must now work in 3 sections and to make it easy for you work as follows:

With contrast waste yarn, knit 45 sts. on the left by hand, pulling the sts. back against the back of the needle bed. With another color waste yarn, knit the center 98 sts. in the same way.

Now continue in Pattern over the 45 sts. left in working position on the right.

After Row 318, *bind off 4 sts. 1x, 2 sts. 2x, 1 st. 3x. After Row 342, bind off the remaining sts.*

Bring the 98 center sts. into working position, remove the waste yarn. Turn the Row Counter back to 282. Watch Pattern. Knit to Row 336.

Bind off the center 14 sts. for neck then knit the remaining sts. on the LEFT with waste yarn, pulling the sts. back against the needle bed.

**ON NECK SIDE, bind off 4 sts. 2x. After Row 342, bind off the remaining sts. **

Bring the remaining sts. of back into work. Remove the waste yarn. Knit 1 row in Pattern to the left side, turn the Row Counter back to 336 and follow the instructions from ** to **. Bring the remaining front sts. into working position (45 sts.), remove the waste yarn. Knit 1 row in Pattern to the left side, turn the Row Counter back to 318 and complete this section. Follow the instructions from * to *.

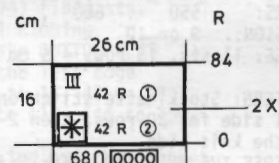
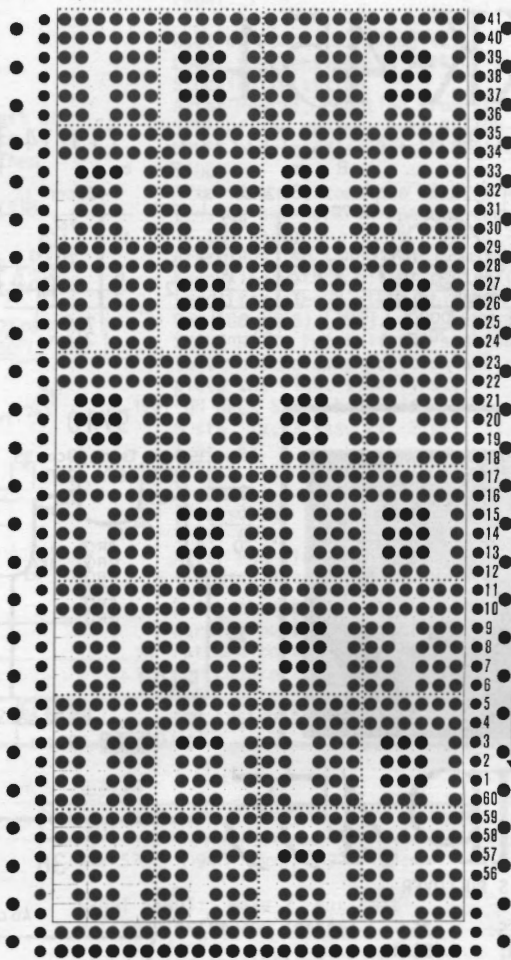

SLEEVES: III

Cast on 68 sts. with color 2 and work in Pattern with the color stripes as shown on the Chart. After Row 84, bind off.

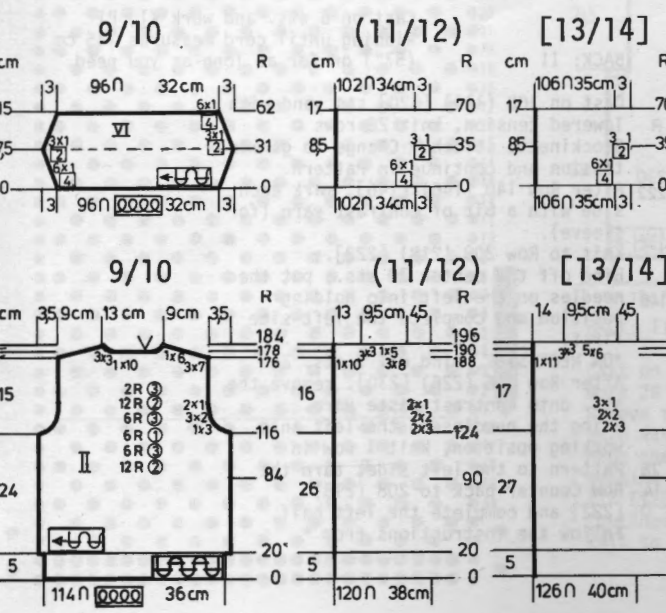

COLLAR: VI

Cast on 96 (102) [106] sts. with color 1 and work Stockinette stitch. ON EACH SIDE, increase 1 st. every 4th row 6x, every 2nd row 3x. After Row 31 (35) [35], ON EACH SIDE, decrease 1 st. every 2nd row 3x, every 4th row 6x. After Row 62 (70) [70], bind off.



PULLOVER BACK: II

With color 1, cast on 114 (120) [126] sts. and work 20 rows K1, P1 Ribbing. Continue in Stockinette stitch. After Row 84 (90) [96], work the color stripes as shown on the Chart. After Row 116 (124) [128], SHAPE ARMHOLE: ON EACH side, bind off 3 sts. 1x, 2 sts. 3x, 1 st. 2x. (3 sts. 2x, 2 sts. 2x, 1 st. 2x). [3 sts. 2x, 2 sts. 2x, 1 st. 3x]. Knit to Row 176 (188) [196]. SHAPE SHOULDER and watch for NECK SHAPING.

*FOR SHOULDER, bind off 7 sts. 3x, 6 sts. 1x, (8 sts. 3x, 5 sts. 1x), [6 sts. 5x], FOR NECK, after Row 178 (190) [200], put half the sts. on the left into holding position and complete the right side first. ON NECK SIDE, bind off 10 (10) [11] sts. 1x, then 3 sts. 3x for all sizes. Bring the needles on the left into working position, knit 1 row to the left side, turn the Row Counter back to 178 (190) [200] and complete the left half. Follow the instructions from * and don't forget to complete the shoulder shaping.

KK 454

SLEEVES: III

Cast on 66 (70) [76] sts. with color 1 and work 12 rows K1, P1 Ribbing.
Continue in Stockinette stitch with color stripes as shown on the Chart.
ON EACH SIDE, increase 1 st. every 2nd row 3x, every 4th row 2x.
After Row 30 (34) [38], SHAPE CAP:
ON EACH SIDE, bind off 3 sts. 2x, 2 sts. 2x, 1 st. 9x, 2 sts. 7x, (3 sts. 2x, 2 sts. 3x, 1 st. 7x, 2 sts. 8x), [3 sts. 2x, 2 sts. 3x, 1 st. 7x, 2 sts. 9x].
After Row 70 (74) [80], bind off the remaining sts.

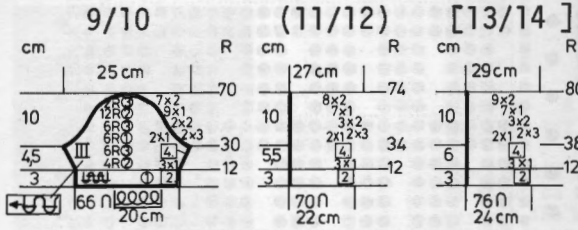

PULLOVER FRONT: 1

Work the front the same as the back to Row 116 (124) [128] working the color stripes as shown on the Chart. SHAPE ARMHOLE same as the back then knit to Row 156 (168) [172].
SHAPE NECK: Put half the sts. on the left into holding position and complete the right side first.
*ON NECK SIDE, bind off 5 sts. 1x, 3 sts. 2x, 2 sts. 2x, 1 st. 4x, (5 sts. 1x, 3 sts. 2x, 2 sts. 2x, 1 st. 4x), [6 sts. 1x, 3 sts. 2x, 2 sts. 2x, 1 st. 4x].
After Row 176 (188) [196], SHAPE SHOULDER same as the back. Bring the needles on the left into working position, knit 1 row to the left side, turn the Row Counter back to 156 (168) [172] and complete the left half. Follow the instructions from *.

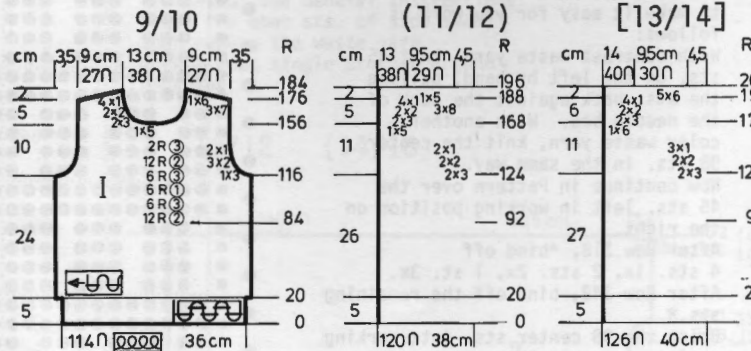

HP 455

MAN'S PULLOVER

SIZES: 36 (38/40) [42]
YARN: Binia
GRAMS: 550 600 700
TENSION: 9 or 10
GAUGE: 11 sts. 16 rows = 5 cm (2")

PATTERN: Stockinette stitch on the purl side for 20 rows, then 2 rows on the knit side.
REVERSE THE KNITTING after knitting 20 rows. *Knit 2 rows, REVERSE the Knitting, knit 20 rows, REVERSE the Knitting and REPEAT from * for Pattern.

FINISHING: See General Instructions. Thread cord through opening and tie in front - see picture.

SLEEVES: III

Cast on 50 (54) [58] sts. and with lowered tension, knit 28 rows. Continue in garment tension and Pattern.
ON EACH SIDE, increase 1 st. every 6th row 26x.
After Row 190, bind off the remaining sts. (or you may remove them onto contrast waste yarn).

CORD:

Cast on 6 sts. and work K1, P1 Ribbing until cord measures 145 cm (57") or for as long as you need.

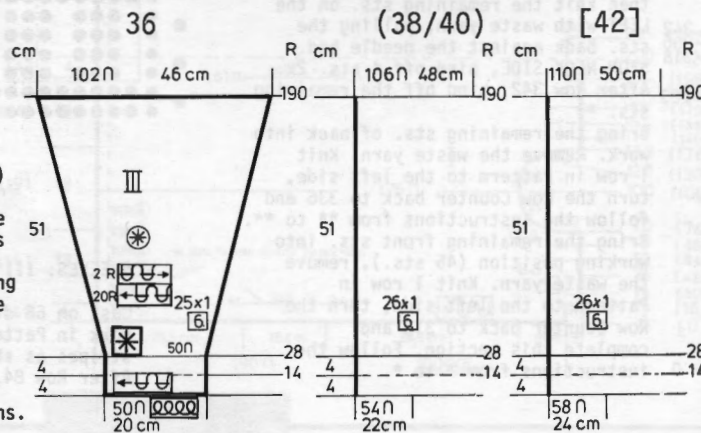

BACK: II

Cast on 108 (114) [120] sts. and with lowered tension, knit 28 rows Stockinette stitch. Change to garment tension and continue in Pattern.
After Row 140 (146) [146], mark each side with a bit of contrast yarn (for sleeve).
Knit to Row 208 (218) [222]. Bind off the center 30 sts., put the needles on the left into holding position and complete the left side first.
*ON NECK SIDE, bind off 3 sts. 3x. After Row 216 (226) [230], remove the sts. onto contrast waste yarn. Bring the needles on the left into working position, knit 1 row in Pattern to the left side, turn the Row Counter back to 208 (218) [222] and complete the left half. Follow the instructions from *.

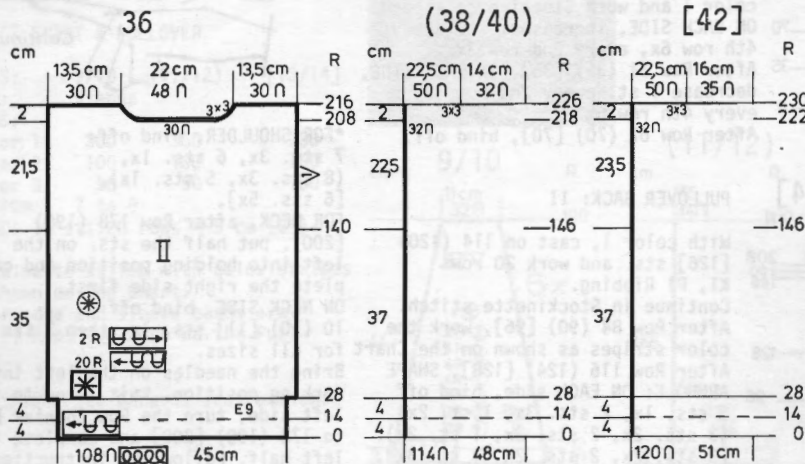

FRONT: I

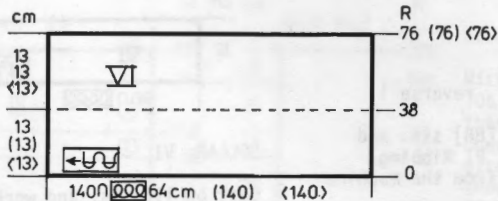

COLLAR: VI

With contrast waste yarn, cast on 140 sts. and work Stockinette stitch. Knit 8 to 10 rows, then change to garment yarn. Knit to Row 76. Remove the sts. onto contrast waste yarn.

Cast on 108 (114) [120] sts. Lower the Tension and work Stockinette stitch. After Row 21, counting from EACH SIDE of the center, make BUTTONHOLES over needles 3 to 6 ON EACH SIDE.

After Row 28, continue with garment tension and work in Pattern same as the back.

After Row 140 (146) [146], mark each side with a bit of contrast yarn (for sleeve) then knit to Row 186 (196) [196].

SHAPE NECK: Put half the sts. on the left into holding position and complete the right side first.

*ON NECK SIDE, bind off 6 sts. 1x, 3 sts. 2x, 2 sts. 3x, 1 st. 6x. (7 sts. 1x, 3 sts. 2x, 2 sts. 3x, 1 st. 6x) [7 sts. 1x, 3 sts. 2x, 2 sts. 3x, 1 st. 6x].

After Row 216 (226) [230], remove the sts. onto contrast waste yarn.

Bring the needles on the left into working position, knit 1 row in Pattern to the left side, turn the Row Counter back to 186 (196) [196] and complete the left half. Follow the instructions from *.

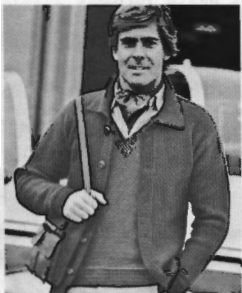
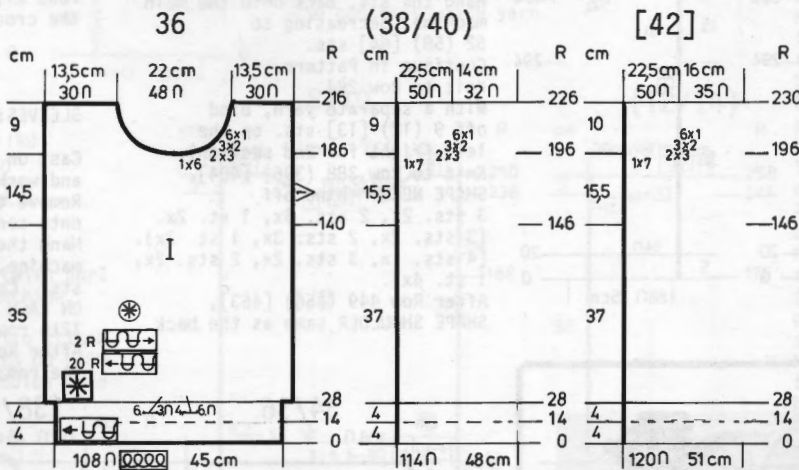

MAN'S JACKET

SIZES: 34/36 (38/40) [42/44]
 YARN: Vienna
 GRAMS: 650 700 750
 TENSION: 7 to 9
 GAUGE: 11 1/2 sts. 36 rows = 5 cm (2")

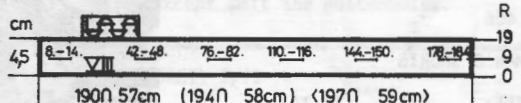

FRONT BANDS: Make 2, but omit buttonholes in 2nd section.

Cast on 190 (194) [197] sts. and work K1, P1 Ribbing. After Row 9, make BUTTONHOLES counting from the left edge over needles 8 to 14, 42 to 48, 76 to 82, 110 to 116, 144 to 150, 178 to 184.

After Row 19, bind off the crochet method for Ribbing.

Punch Card Machine - A Tuck Stitch. Punch your own card following the illustration. AM 3 Machines - A Holding Position Design. Follow the Line Drawing. Bands are K1, P1 Ribbing. The purl side is the right side.

FINISHING: See General Instructions.

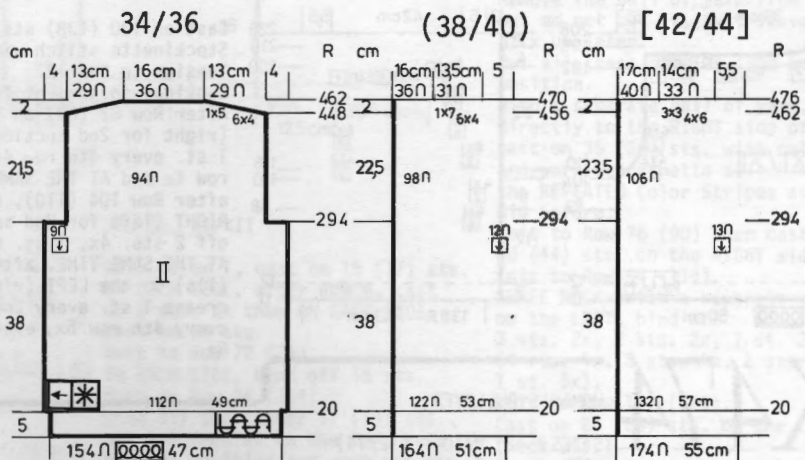

BACK: II

Cast on 154 (164) [174] sts. and work 20 rows K1, P1 Ribbing. Remove the sts. from the machine onto waste yarn. Hang the sts. back onto the main machine, decreasing to 112 (122) [132] sts. Continue in Pattern. Knit to Row 294.

SHAPE ARMHOLE: ON EACH SIDE, bind off 9 (12) [13] sts. Knit to Row 448 (456) [462]. SHAPE SHOULDER: ON EACH SIDE, bind off 4 sts. 6x, 5 sts. 1x. (4 sts. 6x, 7 sts. 1x). [6 sts. 4x, 3 sts. 3x]. After Row 462 (470) [476], bind off the remaining sts.



Continued

HP 451

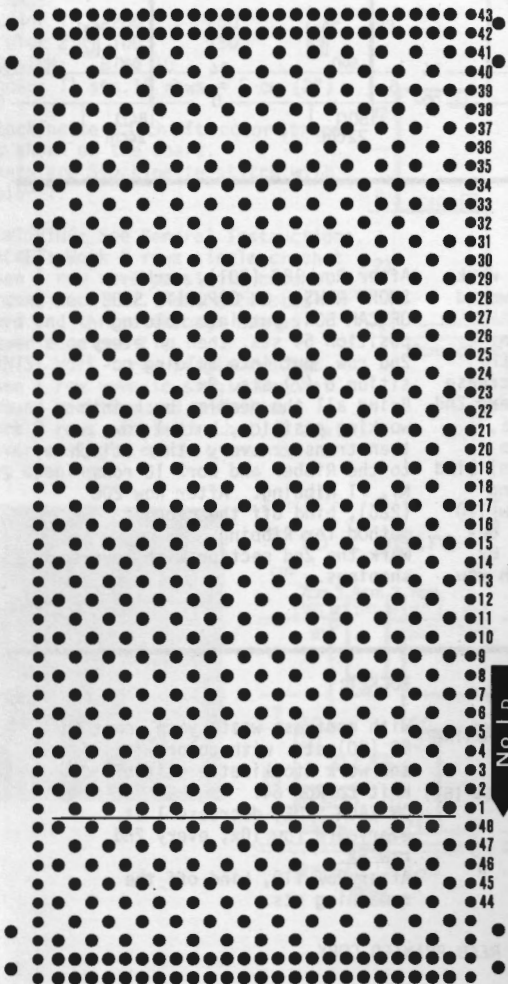

HP 451

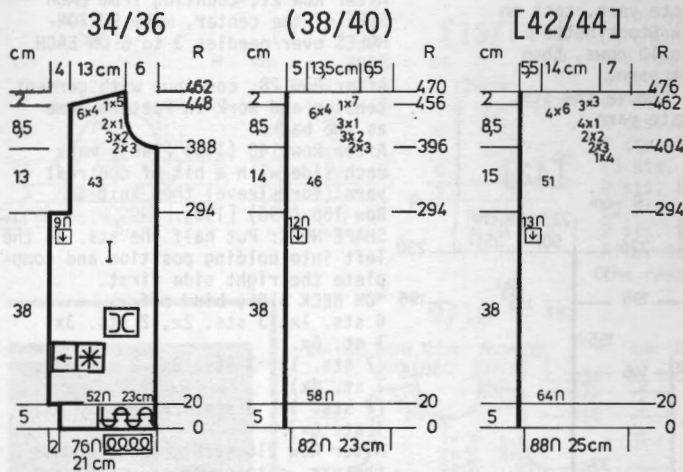

FRONT: I Make 1, reverse 1.

Cast on 76 (82) [88] sts. and work 20 rows K1, P1 Ribbing. Remove the sts. from the machine onto waste yarn. Hang the sts. back onto the main machine, decreasing to 52 (58) [64] sts. Continue in Pattern. Knit to Row 294. With a separate yarn, bind off 9 (12) [13] sts. on the left (right for 2nd section). Knit to Row 388 (396) [404]. SHAPE NECK: Bind off 3 sts. 2x, 2 sts. 3x, 1 st. 2x. (3 sts. 2x, 2 sts. 3x, 1 st. 3x). [4 sts. 1x, 3 sts. 2x, 2 sts. 2x, 1 st. 4x]. After Row 449 (456) [463], SHAPE SHOULDER same as the back.

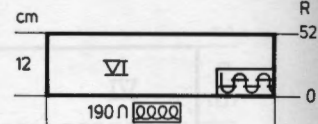

COLLAR: VI

Cast on 190 sts. and work 52 rows K1, P1 Ribbing then bind off the crochet method for Ribbing.

SLEEVES: III

Cast on 76 (80) [84] sts. and work 24 rows K1, P1 Ribbing. Remove the sts. from the machine onto contrast waste yarn. Hang the sts. back onto the main machine, decreasing to 56 (60) [64] sts. Continue in Pattern. ON EACH SIDE, increase 1 st. every 12th row 26x. After Row 404 (404) [410], bind off the remaining sts.

DK 456

WOMAN'S SHORTS

SIZES: 8/10 (12/14)
YARN: Binia
GRAMS: 250 300
TENSION: 8 to 10
GAUGE: 13 sts. 19 rows = 5 cm (2")

Stockinette stitch with 1 x 1 Rib for the waistband.

FINISHING: See General Instructions.

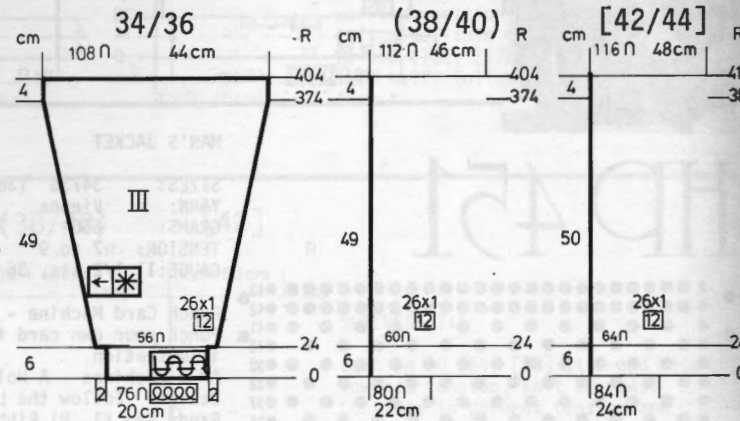

FRONT & BACK: XI/XII make 1, reverse 1.

Cast on 130 (138) sts. and work Stockinette stitch with lowered Tension to Row 12. Continue in garment Tension. After Row 82 (88) on the LEFT (right for 2nd section) increase 1 st. every 4th row 4x, every 2nd row 4x and AT THE SAME TIME, after Row 104 (110), on the RIGHT (left for 2nd section) bind off 2 sts. 4x, 1 st. 6x, and AT THE SAME TIME, after Row 110 (116) on the LEFT (right), decrease 1 st. every 2nd row 8x, every 4th row 6x, every 6th row 8x.

After Row 183 (201), work SHORT ROWS. ON OPPOSITE SIDE OF CAM BOX, put into holding position 54 sts. then on every 2nd row, put into holding position 6 (7) sts. 8x. Bring all the needles back into working position, knit 1 row, then transfer every other stitch to the Ribber and work 10 rows K1, P1 Ribbing. After Row 208 (226), bind off the crochet method for Ribbing. Work the 2nd section with reverse shapings.

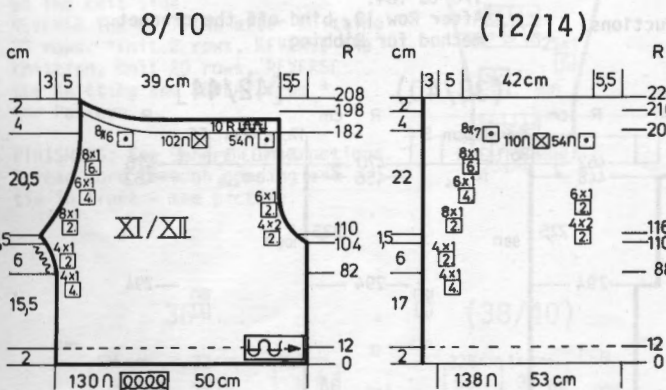

DK 474

WOMAN'S PULLOVER

SIZES: 8/10 (12/14)
YARN: Binia
GRAMS: Color 1 150 150
Color 2 250 300
TENSION: 6 to 8
GAUGE: 14 sts. 21 rows = 5 cm (2")

Stockinette stitch with color stripes on the Sleeves.

FINISHING: See General Instructions. Work 1 row single crochet around pocket.

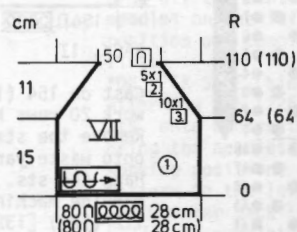

POCKET:

With contrast waste yarn, cast on 80 (80) sts. with color 1 and work Stockinette stitch. Knit to Row 64. ON EACH SIDE, decrease 1 st. every 3rd row 10x, every 2nd row 5x. After Row 110, bind off the remaining sts.

BE SURE TO READ PRINTED COPY



8/10

(12/14)

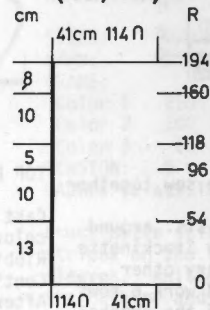
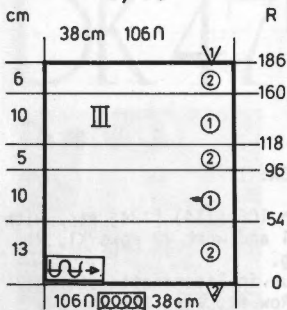

SLEEVES: III

With contrast waste yarn, cast on 106 (114) sts. Knit 8 to 10 rows then change to garment yarn and put Counter at 0. Continue in Stockinette stitch with color stripes as shown on the Chart. After Row 186 (194) remove the sts. onto contrast waste yarn.

BACK & FRONT: I/II

Cast on 132 (142) sts. with color 2 and work Stockinette stitch with lowered Tension. ON FRONT section ONLY, after Row 12, make BUTTONHOLES over needles 6 to 9 ON EACH SIDE, counting from the center. After Row 24, hang the hem and continue in garment Tension. Knit to Row 168 (176). Mark each side with a bit of contrast yarn (for sleeve set in) then knit to Row 236 (244). SHAPE NECK using SHORT ROWS. ON OPPOSITE SIDE OF CAM BOX, put half the sts. into holding position *then ON OPPOSITE SIDE OF CAM BOX, put into holding position, 14 (16) sts. 1x, 4 sts. 6x. After Row 250 (258), bind off the remaining sts. Move the Cam Box to the left side, turn the Row Counter back to 236 (244) and complete the left half. Bring 66 needles into working position and SHAPE NECK as you did before using SHORT ROWS. Follow the instructions from *. Bring all the remaining neck sts. into working position, attach yarn and knit 8 rows Stockinette stitch then bind off loosely. Work the Back section the same except omit the Buttonholes.

8/10

(12/14)

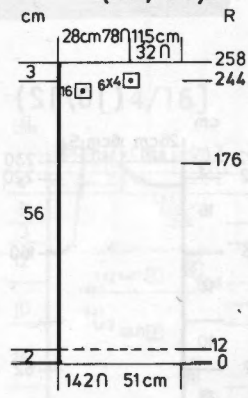
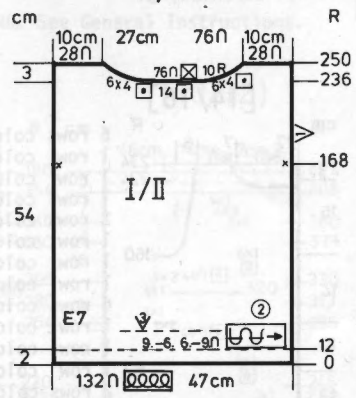
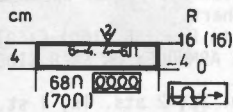

SLEEVE BANDS:
Hang the open CAST-ON sts. (with puri side facing you) onto the machine, decreasing to 68 (70) sts. With color 1, work Stockinette stitch. After Row 4, make BUTTONHOLES ON EACH SIDE of the center, over needles 4 to 6. After Row 16, bind off.

KK 458

ODDLERS PANT SUIT

SIZES: 1 to 2 3 to 4 years
FABRIC: Euro Sport
COLORS: Color 1 200 250, Color 2 100 150
TENSION: 8 to 10
GAUGE: 11 sts. 15 rows = 5 cm (2")

Stockinette stitch with color stripes as shown on the Chart. Buttons are Stockinette stitch with color 1.

FINISHING: See General Instructions. JACKET: Work 2 rows single crochet then 1 row reverse single crochet round neckline. Make a twisted cord and thread through hem at lower edge and tie.

PANTS: Work 1 row single crochet then 1 row reverse single crochet round neckline and armholes. Work 2 rows single crochet, 1 row reverse single crochet around leg openings.

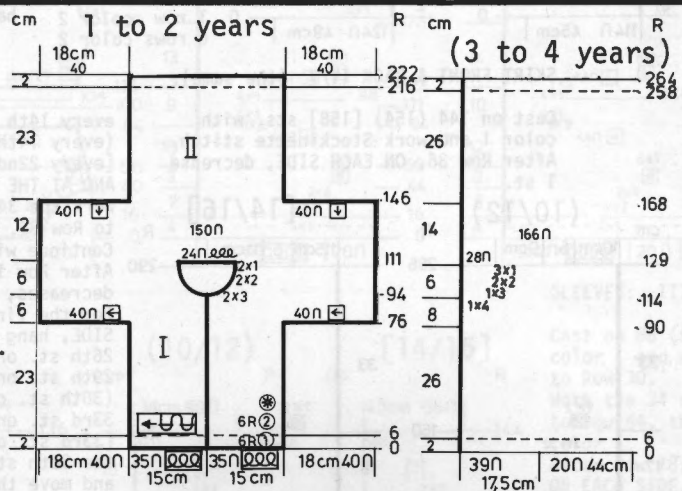

JACKET: I/II
To the LEFT of 0, cast on 35 (39) sts. with color 1 and work Stockinette stitch with REPEATED Color stripes as shown on the Chart. Knit to Row 76 (90). With a separate yarn, cast on 40 (44) sts. on the LEFT side. Knit to Row 94 (114). SHAPE NECK: Bind off 3 sts. 2x, 2 sts. 2x, 1 st. 2x. (4 sts. 1x, 3 sts. 1x, 2 sts. 2x, 1 st. 3x). Knit to Row 111 (129). Remove the ball of yarn from the feeder but do not cut it, just leave it to pick up later. Put all these needles into holding position. With a separate ball of yarn, and directly to the RIGHT side of 0, cast on 35 (39) sts. with color 1 and work Stockinette stitch with the REPEATED Color Stripes as you did before. Knit to Row 76 (90) then cast on 40 (44) sts. on the RIGHT side. Knit to Row 94 (114). SHAPE NECK: With a separate yarn, on the LEFT, bind off 3 sts. 2x, 2 sts. 2x, 1 st. 2x. (4 sts. 1x, 3 sts. 1x, 2 sts. 2x, 1 st. 3x). Knit to Row 111 (129). Cast on 24 (28) sts. on the LEFT (neck sts.). Break the yarn. Being sure ALL needles are in holding position, move the Cam Box to the left side. Bring all the needles into working position. Counter at 111 (129) and continue over all the needles to Row 146 (168). ON EACH SIDE, bind off 40 (44) sts. Knit to Row 222 (264) then bind off the remaining sts.

PANTS: XI/XII

(3 to 4 years)

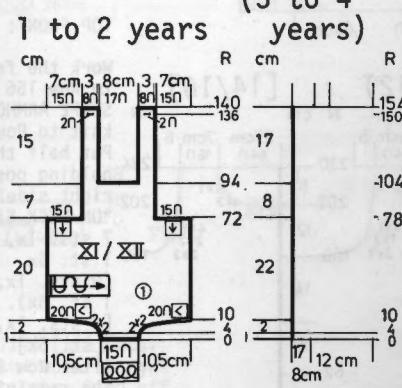

With color 1, cast on 15 (17) sts. ON EACH SIDE, after Row 4, cast on 2 sts. 2x then ON EACH SIDE, cast on 20 sts. Knit to Row 72 (78). ON EACH SIDE, bind off 15 sts. Knit to Row 94 (104). Bind off the center 17 (19) sts., put the needles on the left into holding position and complete the right side first. *Knit to Row 136 (150), then make BUTTONHOLE over the center 2 sts. Knit to Row 140 (154). Bind off. Bring the needles on the left into working position, knit 1 row to the left side, turn the Row Counter back to 94 (104) and complete the left half. Follow the instructions from *. Work the 2nd section the same but OMIT the buttonholes.



DK 460

WOMAN'S SKIRT & TOP

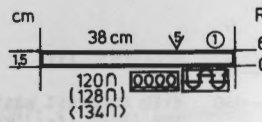

SIZES: 7/8 (10/12) [14/16]
YARN: Binia
GRAMS:
 Color 1 450 500 550
 Color 2 100 100 100
 Color 3 50 50 50
TENSION: 9 or 10
GAUGE: 12 sts. 19 rows = 5 cm (2")



ARBANDS: VIII

Both shoulders should be sew together first.
 Pick up 120 (128) [134] sts. around the armhole. Knit 1 row Stockinette stitch then transfer every other stitch to the Ribber and work 6 rows K1, P1 Ribbing. Bind off the crochet method for Ribbing.

TOP BACK: II

Cast on 106 (114) [124] sts. with color 1 and work 12 rows K1, P1 Ribbing. Continue in Stockinette stitch. After Row 62, work the 34 rows of Color Stripes as shown along side the Chart.

Knit to Row 156 (160) [160].
SHAPE ARMHOLE: ON EACH SIDE, bind off

3 sts. 2x, 2 sts. 1x, 1 st. 3x.
 (3 sts. 2x, 2 sts. 1x, 1 st. 4x).
 [3 sts. 2x, 2 sts. 1x, 1 st. 4x].
 Knit to Row 212 (220) [224].
 Bind off the center 28 (30) [32] sts., put the needles on the left into holding position and complete the right side first.

***ON NECK SIDE, bind off**
 3 sts. 5x.
 (4 sts. 1x, 3 sts. 3x).
 [4 sts. 1x, 3 sts. 3x].
 After Row 220 (230) [234], bind off the remaining 13 (14) [16] sts.
 Move the Cam Box to the left side, turn the Row Counter back to 212 (220) [224] and complete the left half. Follow the instructions from

FINISHING: See General Instructions.

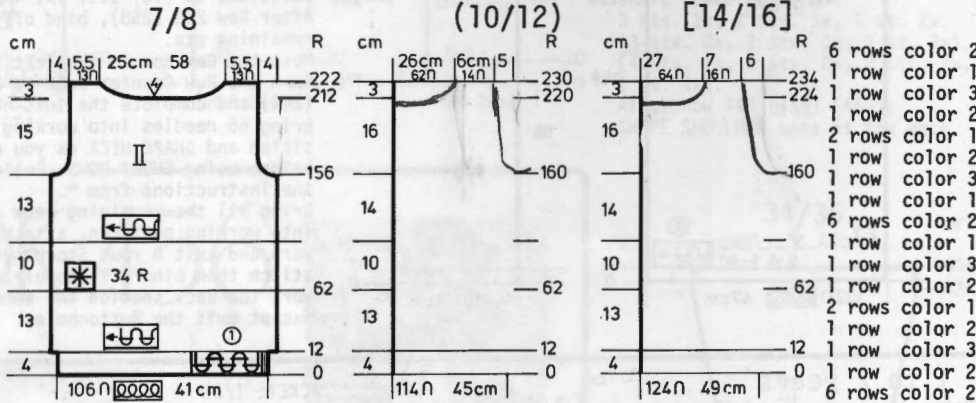

SKIRT FRONT & BACK IV/V (the same).

Cast on 144 (154) [158] sts. with color 1 and work Stockinette stitch. After Row 36, **ON EACH SIDE, decrease 1 st.**

every 14th row 17x,
 (every 14th row 17x),
 [every 22nd row 11x],
AND AT THE SAME TIME, after Row 54, work the 34 rows of color stripes to Row 88.

Continue with color 1.
 After Row 160, in addition to the side decreases, begin the DART decreases. For the first DART DECREASE, **ON EACH SIDE, hang the**
 26th st. onto the 27th st., the 29th st. onto the 28th st., (30th st. onto the 31st st. the 33rd st. onto the 32nd st.), [33rd st. onto the 34th st., the 36th st. onto the 35th st.], and move the sts. in to fill the empty needles.
 The following DART decreases lie directly above after the rows shown on the Chart.
 After Row 286 (286) [290], bind off the remaining sts.

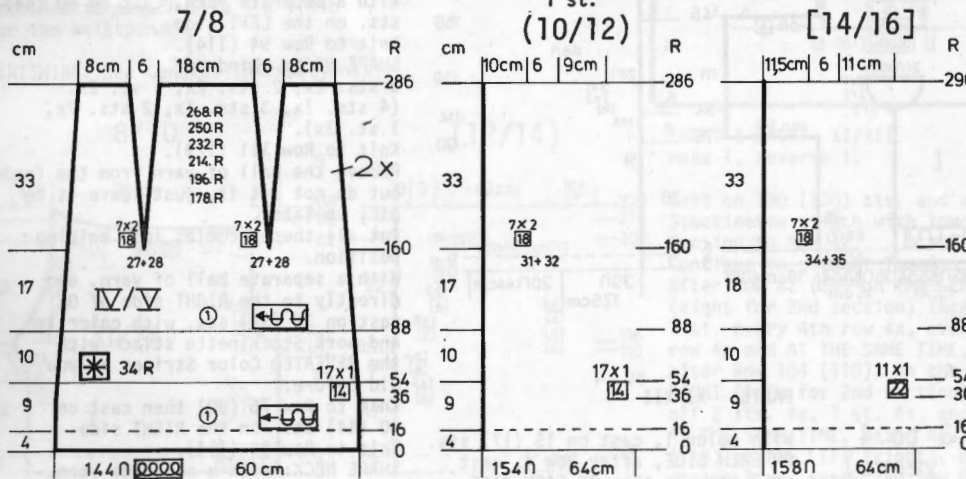

TOP FRONT: I

Work the front the same as the back to Row 156 (160) [160].
SHAPE ARMHOLE same as the back the knit to Row 194 (202) [202].
 Put half the sts. on the left into holding position and complete the right side first.

***ON NECK SIDE, bind off**
 7 sts. 1x, 5 sts. 1x, 3 sts. 4x, 1 st. 5x.
 (9 sts. 1x, 5 sts. 1x, 3 sts. 4x, 1 st. 5x).
 [9 sts. 1x, 6 sts. 1x, 3 sts. 4x, 1 st. 5x].

After Row 222 (230) [234], bind off the remaining 13 (14) [16] sts.
 Move the Cam Box to the left side, turn the Row Counter back to 194 (202) [202] and complete the left half. Follow the instructions from

NECKBAND: VIII

Sew up 1 shoulder seam, then pick up 180 (184) [184] sts. around the neck edge. Knit 1 row Stockinette stitch, then transfer every other stitch to the Ribber and work 6 rows K1, P1 Ribbing. Bind off the crochet method for Ribbing.

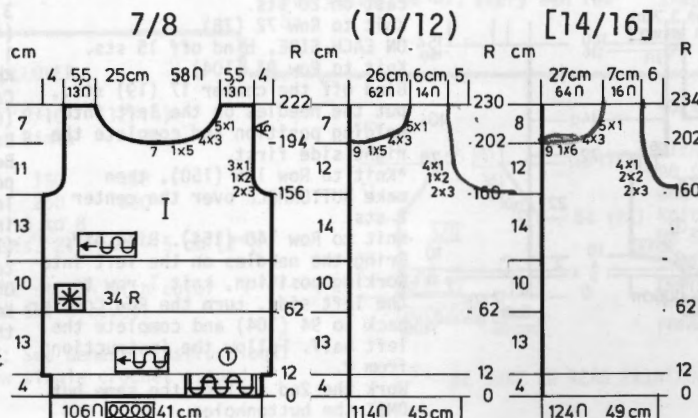

DK 472

WOMAN'S JACKET

SIZES: 7/8 (10/12) [14/16]
YARN: Binia
GRAMS:
 Color 1 250 300 350
 Color 2 100 100 150
 Color 3 50 50 100
TENSION: 9 to 10
GAUGE: 12 sts. 19 rows = 5 cm (2")

Stockinette stitch with color stripes on the front section and sleeves. Knitted sideways on the machine and worn on the purl side.

FINISHING: See General Instructions.



Make all shapings on the RIGHT SIDE. Cast on 140 (144) 144) sts. with color 1 and work Stockinette stitch. Knit to Row 16.

Work the color stripes as shown along side the Chart and AT THE SAME TIME, on every 2nd row, cast on 1 st. 4x, 2 sts. 4x, 4 sts. 2x for all sizes.

After Row 40 (44) [46] SHAPE SHOULDER and at the SAME TIME, Stripe Pattern is completed after Row 50.

FOR SHOULDER, decrease 1 st. every 7th (8th) [8th] row 6x. After Row 84 (94) [100], bind off 40 (44) [44] sts, then bind off 2 sts. 1x, 1 st. 4x for all sizes. After Row 104 (118) [128], increase 1 st. 4x, 2 sts. 1x, for all sizes, then cast on 40 (44) [44] sts. After Row 116 (128) [140], SHAPE SHOULDER: Increase 1 st. every 7th (8th) [8th] row 6x.

After Row 160 (178) [194], SHAPE NECK: Bind off 1 st. 4x for all sizes.

After Row 212 (238) [262], increase 1 st. 4x.

After Row 220 (246) [268], SHAPE SHOULDER: Decrease 1 st. every 7th (8th) [8th] row 6x. After Row 264 (296) [324], bind off 40 (44) [44] sts. then bind off 2 sts. 1x, 1 st. 4x, for all sizes.

After Row 286 (320) [354], increase 1 st. 4x, 2 sts. 1x, then cast on 40 (44) [44] sts.

After Row 296 (330) [364], SHAPE SHOULDER: Increase 1 st. every 7th (8th) [8th] row 6x and AT THE SAME TIME, after Row 330 (374) [414], work the PATTERN STRIPES and after Row 340 (380) [418], SHAPE NECK: Bind off

4 sts. 2x, 2 sts. 4x, 1 st. 4x for all sizes.

After Row 364 (408) [448], continue with color 1 and after Row 380 (424) [464], bind off the remaining sts.

COLOR STRIPES SAME AS DK 460

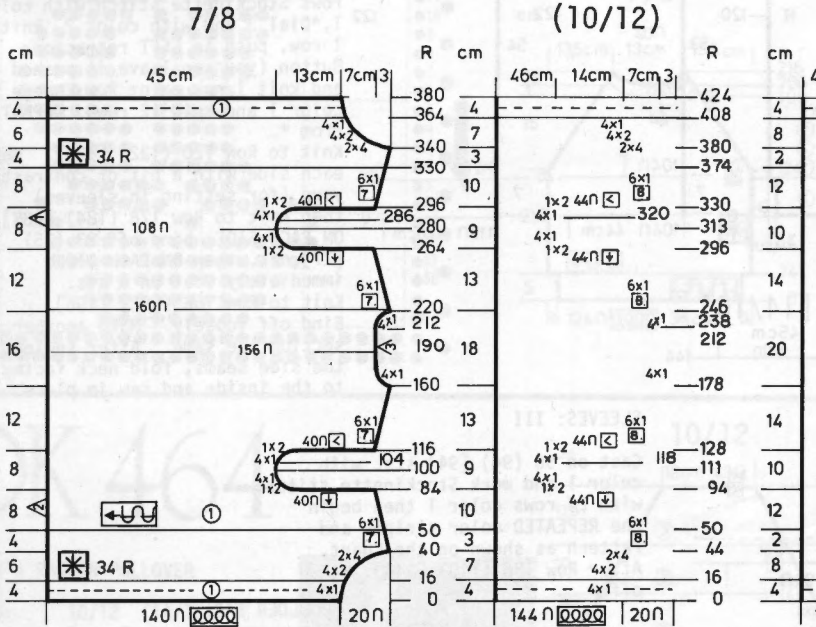

SLEEVES: III

Cast on 86 (90) [96] sts. with color 1 and work Stockinette stitch to Row 30.

Work the 34 rows of color stripes to Row 64, then continue with color 1.

After Row 78, SHAPE CAP: ON EACH SIDE, bind off

3 sts. 2x, 2 sts. 2x, 1 st. 24x, 2 sts. 1x. (3 sts. 2x, 2 sts. 2x, 1 st. 26x, 2 sts. 1x). [3 sts. 2x, 2 sts. 2x, 1 st. 27x, 2 sts. 2x].

After Row 136 (140) [144], bind off the remaining sts.

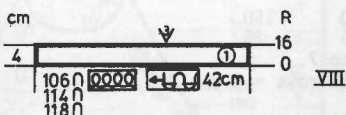
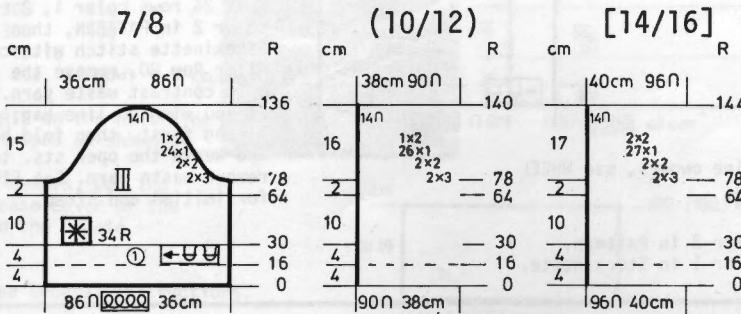

NECKBAND:

Cast on 106 (114) [118] sts. with color 1 and work 16 rows Stockinette stitch. Bind off.

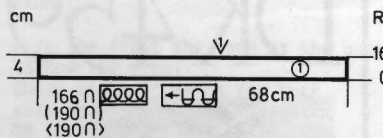

LOWER BAND:

Cast on 166 (190) [190] sts. with color 1 and work 16 rows VIII Stockinette stitch. Bind off.

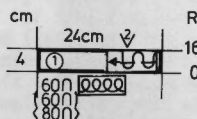

LOWER BAND:

Cast on 60 (60) [80] sts. with color 1 and work 16 rows Stockinette stitch. Bind off.

DK 457 DK 473

WOMAN'S PULLOVER & SHOULDER BAG

SIZES: 7/8 (10/12) [14/16]
 YARN: Color 1 - Binfa
 Color 2 - Capriccio

GRAMS:
 Color 1 500 550 650
 Color 2 25 50 50
 TENSION: 8 to 10
 GAUGE: 11 sts. 15 rows = 5 cm (2")

Stockinette stitch with stripes in a Holding Position Design. Punch Card machine owners, punch your own Card and set for TUCK. AM 3 machine owners, use wheel No. 4.

FINISHING: See General Instructions. BAG: Make cord over 6 sts. 4 inches long. Use to form initial and sew in place. Fold in half and sew seam. Make hem at top and stuff with dacron. Make shoulder strap 39 1/2" (100 cm) long by knitting a cord over 6 sts. and sew in place - see picture.

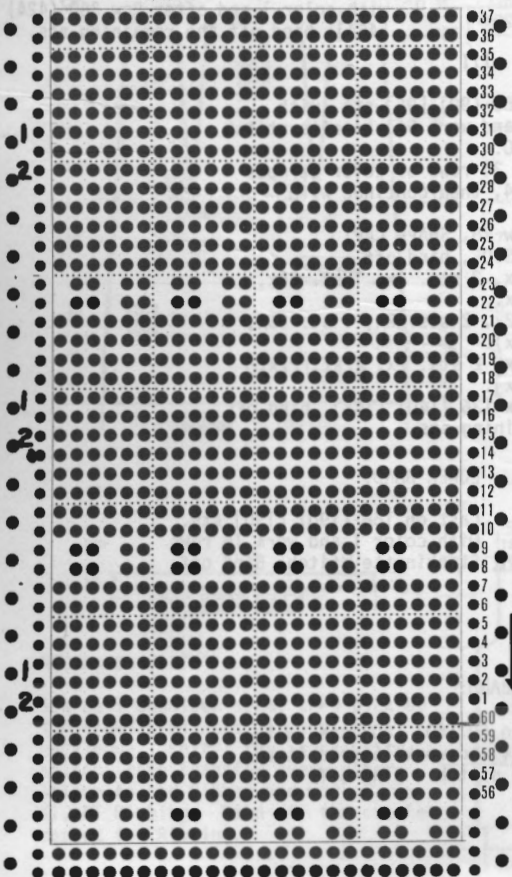
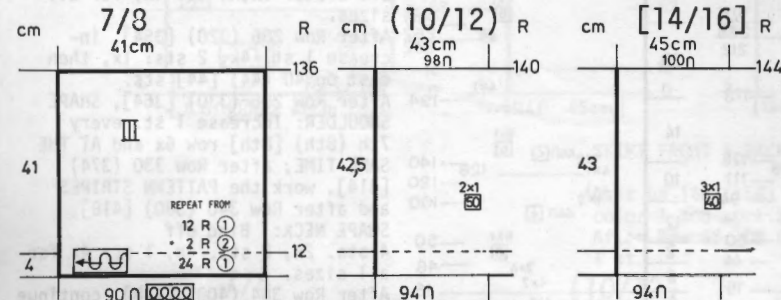
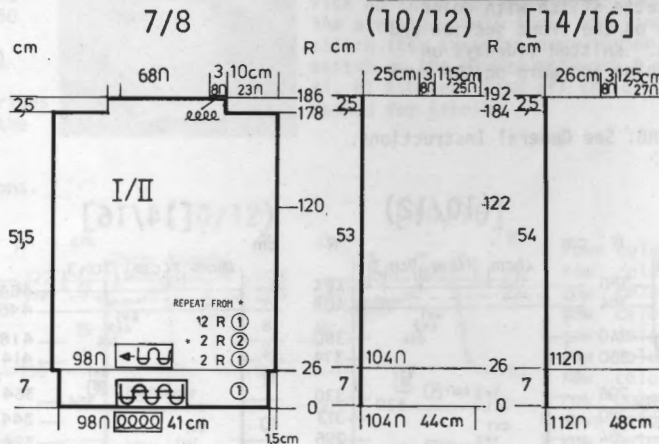

AM 3 machine owners, use WHEEL No. 4.

2 Rows Color 2 in Pattern.
 12 Rows Color 1 in Stockinette.

PULLOVER BACK & FRONT: I/II

Cast on 98 (104) [112] sts. with color 1 and work 26 rows K1, P1 Ribbing. Transfer the Ribber sts. to the main machine and continue in Stockinette stitch and Pattern. If you own a Color Changer, immediately set the needles while knitting the next row across to the left side. If you do not own a Color Changer, knit 1 row stockinette stitch to the left, then set Pattern on the next row from left to right. Push in BOTH TUCK BUTTONS and continue in Pattern of 2 rows Tuck with Capriccio and 12 rows Stockinette stitch with Binfa. AM 3 machine owners, use Wheel No. 4. After knitting 2 rows Stockinette stitch with color 1, *Dial 3 and with color 2, knit 1 row, push in LEFT retractor Button (you can leave it pushed in) and knit 1 row color 2. Change to color 1 and knit 12 rows. REPEAT from *.
 Knit to Row 120 (122) [122]. Mark each side with a bit of contrast yarn (for setting in sleeves) then knit to Row 178 (184) [188]. ON EACH SIDE, bind off 23 (25) [27] sts. then ON EACH SIDE, immediately cast on 8 sts. Knit to Row 186 (192) [196]. Bind off loosely. Make another section the same. After sewing the side seams, fold neck facing to the inside and sew in place.

SLEEVES: III

Cast on 90 (94) [94] sts. with color 1 and work Stockinette stitch with 24 rows color 1 then begin the REPEATED color stripes and Pattern as shown on the Chart. After Row 136 (140) [144], bind off.

SHOULDER BAG:

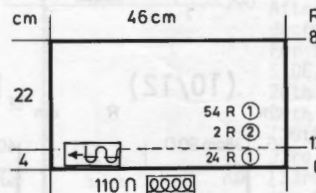

Cast on 110 sts. with color 1 and work Stockinette stitch. Knit 24 rows color 1, 2 rows color 2 in PATTERN, then 54 rows Stockinette stitch with color 1. After Row 80, remove the sts. onto contrast waste yarn. If you wish to line bag, cut lining first, then fold bag in half and weave the open sts. together. remove waste yarn. See FINISHING for initial and strap.

DK 459

WOMAN'S HALTER TOP

SIZES: 7/8 (9/10)
 YARN: Color 1 Micaela, Color 2 Capriccio
 GRAMS:
 Color 1 150 150
 Color 2 25 25
 TENSION: 5 to 7
 GAUGE: 15 sts. 23 rows = 5 cm (2")



Stockinette stitch with a single Motif in color 2.

FINISHING: See General Instructions. Make hem at neckline. Make a cord and thread through neck hem. Work 1 row single crochet with color 1 then 2 rows single crochet with color 2 around armholes.

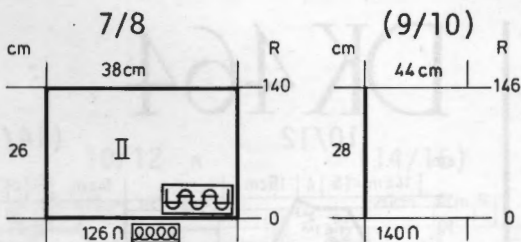
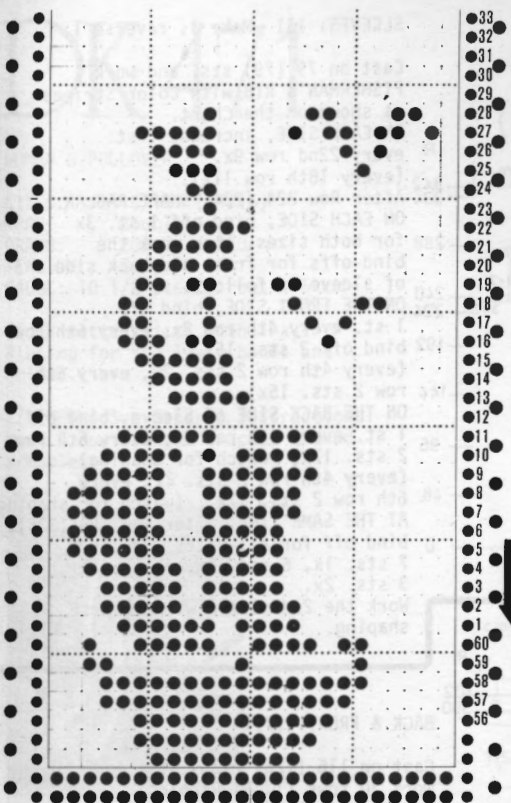

BACK: II

Cast on 126 (140) sts. with color 1 and work K1, P1 Ribbing. Knit to Row 140 (146) then bind off the crochet method for Ribbing.

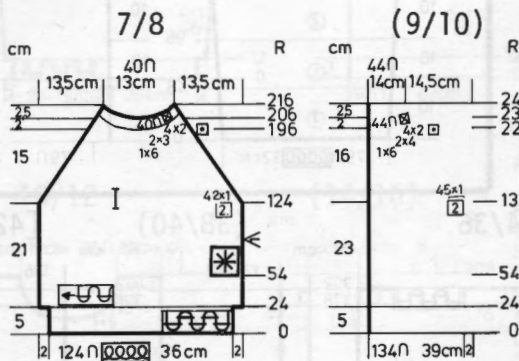

FRONT: I

Cast on 124 (134) sts. with color 1 and work 24 rows K1, P1 Ribbing. Continue in Stockinette stitch. After Row 55, Set the Pattern for the single Motif over needle 13 through 36 counting from the right side of 0.

Remember, with Punch Card machines, you must push all needles other than those used for the Motif, back into working position.

After Row 124 (132) SHAPE RAGLAN: ON EACH SIDE, decrease 1 st. every 2nd row 42x (45x) AND AT THE SAME TIME, after Row 196 (220) SHAPE NECK using SHORT ROWS.

Put half the sts. on the LEFT into holding position, then *ON NECK SIDE, put into holding-position, 6 sts. 1x, 3 sts. 2x, 2 sts. 4x. (6 sts. 1x, 4 sts. 2x, 2 sts. 4x). Put these sts. into holding position and move the Cam Box to the left side.

Put 20 sts. into working position, put the Counter at 196 (220) and work the SHORT ROWS from *. After Row 206 (230), bring all the needles into working position and knit to Row 216 (240). Bind off loosely.

DK 464

WOMAN'S RAGLAN PULLOVER

SIZES: 10/12 (14/16)
YARN: Euro Sport

GRAMS:
Color 1 300 350
Color 2 300 350
Color 3 350 400

TENSION: 8 to 10
GAUGE: 12 1/2 sts. 24 rows = 5 cm

FISHERMAN'S RIB on the Knit Side with Color stripes as shown on the Chart.

AM 3 machine owners, put the Gate Cam Release Lever of the Ribber toward the needle heels.

FINISHING: See General Instructions.

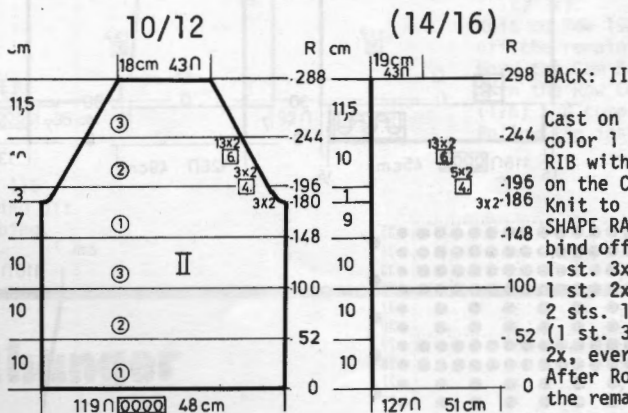

Cast on 119 (127) sts. with color 1 and work in FISHERMAN'S RIB with COLOR STRIPES as shown on the Chart.

Knit to Row 180 (186). SHAPE RAGLAN: ON EACH SIDE, bind off

1 st. 3x, then every 4th row 1 st. 2x, every 6th row 2 sts. 17x.

(1 st. 3x, every 4th row 2 sts. 2x, every 6th row 2 sts. 17x). After Row 288 (298), bind off the remaining sts.

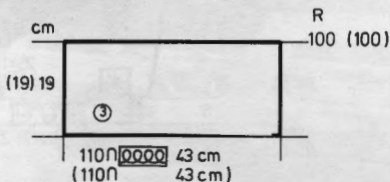

COLLAR:

Cast on 110 (110) sts. and work FISHERMAN'S RIB to Row 100, then bind off the crochet method for Ribbing.

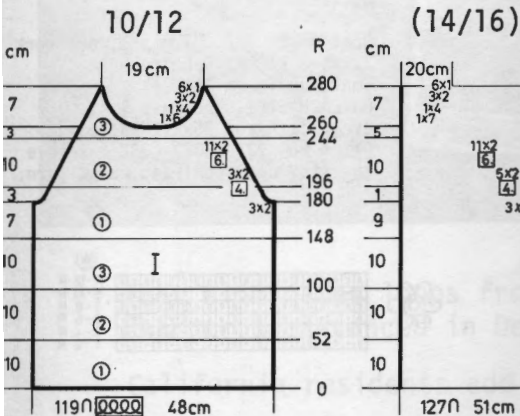

FRONT: I

Work the front the same as the back to Row 180 (186). SHAPE RAGLAN: Watch for Neck shaping.

ON EACH SIDE, bind off 1 st. 3x, every 4th row 1 st. 2x, every 6th row 2 sts. 15x. (1 st. 3x, every 4th row 2 sts. 2x, every 6th row 2 sts. 15x). AT THE SAME TIME, after Row 260 (268), divide in the center; put the needles on the left into holding position and complete the right side first (you must transfer the ribber sts. to the main machine before you can put them into holding). *ON NECK SIDE, bind off

8 sts. 1x, 4 sts. 1x, 2 sts. 3x, 1 st. 6x. (10 sts. 1x, 4 sts. 1x, 2 sts. 3x, 1 st. 6x).

Transfer the proper needles back to the Ribber, bring all the needles into working position, knit 1 row to the left side, turn the Row Counter back to 260 (268) and complete the left half. Follow the instructions from * but begin by binding off 9 (11) sts. for the first neck bind off instead of 8 (10).



HP 461

MAN'S PULLOVER

SIZES: 34/36 (38/40) [42]
 YARN: Amore
 GRAMS: 450 500 550
 TENSION: 7 to 9
 GAUGE: 12 sts. 31 rows = 5 cm (2")

AM 3 machines: A Holding Position Design using Wheel No. 6. Punch Card Machine owners, punch your own card and set for TUCK. Bands are K1, P1 Ribbing. Worn on the Purl side.

FINISHING: See General Instructions.



DK 464

10/12

(14/16)

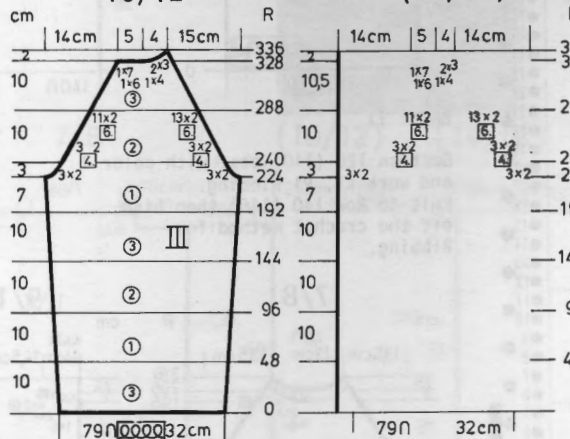

SLEEVES: III Make 1, reverse 1.

Cast on 79 (79) sts. and work FISHERMAN'S RIB with Color Stripes as shown on the Chart.
 ON EACH SIDE, increase 1 st. every 22nd row 9x. (every 18th row 11x).
 After Row 224 (224) SHAPE RAGLAN: ON EACH SIDE, bind off 1 st. 3x for both sizes, then work the bind-offs for front and back side of sleeve as follows:
 ON THE FRONT SIDE, bind off 1 st. every 4th row 2x, every 6th row bind off 2 sts. 15x. (every 4th row 2 sts. 2x, every 6th row 2 sts. 15x).
 ON THE BACK SIDE of Sleeve, bind off 1 st. every 4th row 2x, every 6th row 2 sts. 17x, (watch for Shaping) (every 4th row 2 sts. 2x, every 6th row 2 sts. 17x), (watch for shaping)
 AT THE SAME TIME, after Row 329 (335), bind off for all sizes 7 sts. 1x, 6 sts. 1x, 4 sts. 1x, 3 sts. 2x.
 Work the 2nd sleeve with reverse shaping.

34/36

(38/40)

[42]

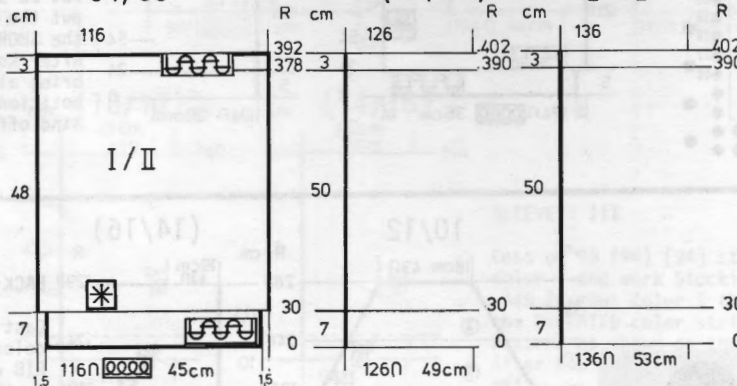

BACK & FRONT: I/II

Cast on 116 (126) [136] sts. and work 30 rows K1, P1 Ribbing. Continue in PATTERN. Knit to Row 378 (390) [390]. Transfer every other stitch to the Ribber and work K1, P1 Ribbing to Row 392 (402) [402]. Bind off. Work the 2nd section the same.

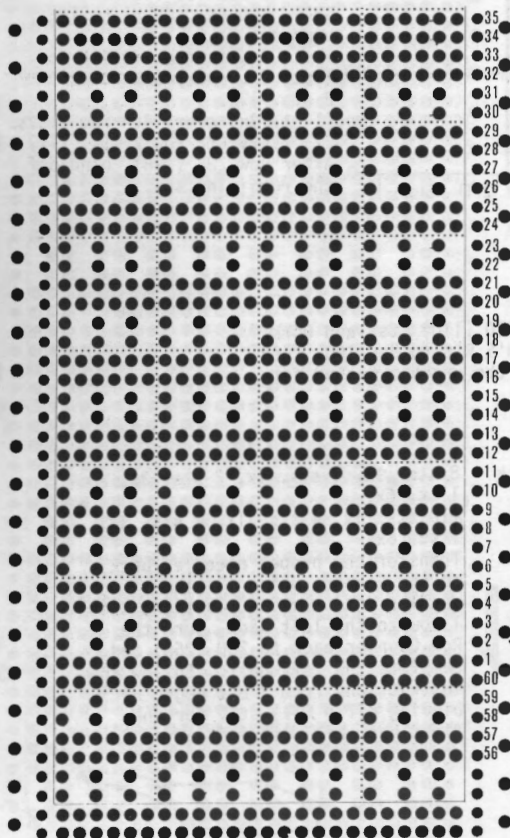

34/36

(38/40)

[42]

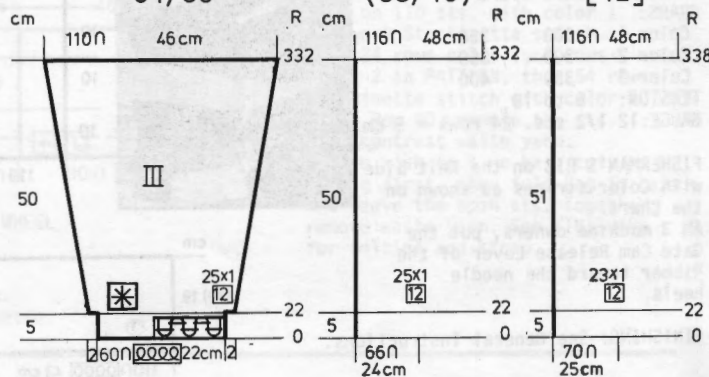

SLEEVES: III

Cast on 60 (66) [70] sts. and work 22 rows K1, P1 Ribbing. Continue in PATTERN. ON EACH SIDE, increase 1 st. every 12th row 25x (25x) [23x]. After Row 332 (332) [338], remove the sts. onto contrast waste yarn.

PUNCH CARD machine owners. Set machine on KC - card on Stop. Knit 1 row from LEFT to Right to set Pattern. Push in BOTH TUCK buttons, set Card on Go.

AM 3 machine owners use Wheel No. 6. Push in the LEFT Retractor Button and leave it there. *Dial 1, Knit across and back. All needles in work, knit 2 rows. REPEAT from *.



DK 471

WOMAN'S PULLOVER

SIZES: 10/12 (14/16)
 YARN: Boucle
 GRAMS: 200 250
 TENSION: 8 to 10
 GAUGE: 10 1/2 sts. 20 rows = 5 cm

Stockinette stitch with 1 x 1 Ribbing for the lower bands and Collar.

FINISHING: See General Instructions.
 Work 2 rows single crochet around armholes.

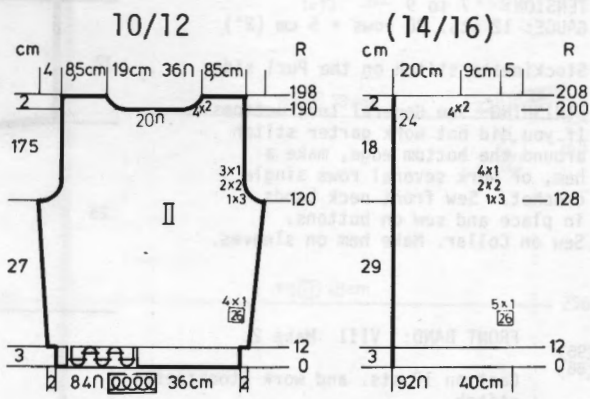

BACK: II

Cast on 84 (92) sts. and work 12 rows K1, P1 Ribbing. Continue in Stockinette stitch. ON EACH SIDE, increase 1 st. every 26th row 4x (5x). Knit to Row 120 (128). SHAPE ARMHOLE: ON EACH SIDE, bind off 3 sts. 1x, 2 sts. 2x, 1 st. 3x. (3 sts. 1x, 2 sts. 2x, 1 st. 4x). Knit to Row 190 (200). Bind off the center 20 sts., put the needles on the left into holding position and complete the right side first. *ON NECK SIDE, for both sizes, bind off 2 sts. 4x. Knit to Row 198 (208) then bind off the remaining sts. Move the Cam Box to the left side, turn the Row Counter back to 190 (200) and complete the left half. Follow the instructions from *.

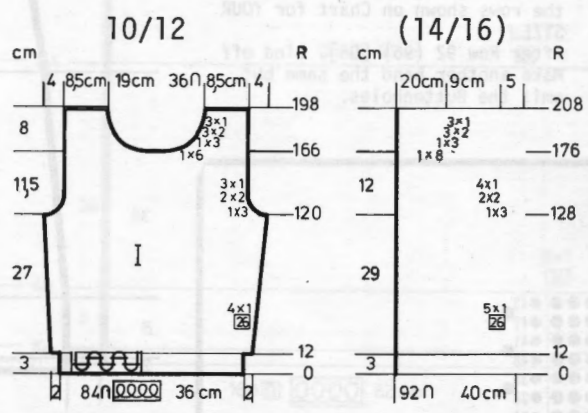

FRONT: I

Work the front the same as the back to Row 120 (128). SHAPE ARMHOLE same as the back then knit to Row 166 (176). Put half the sts. on the left into holding position and complete the right side first. *ON NECK SIDE, bind off 6 sts. 1x, 3 sts. 1x, 2 sts. 3x, 1 st. 3x. (8 sts. 1x, 3 sts. 1x, 2 sts. 3x, 1 st. 3x). Knit to Row 198 (208) then bind off the remaining sts. Move the Cam Box to the left side, turn the Row Counter back to 166, (176) and complete the left half. Follow the instructions from *.

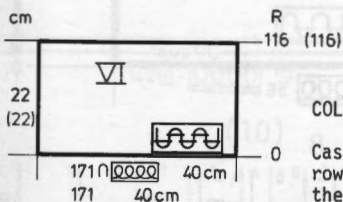

COLLAR: VI

Cast on 171 sts. and work 116 rows K1, P1 Ribbing then bind off the crochet method for Ribbing.

push button color changer

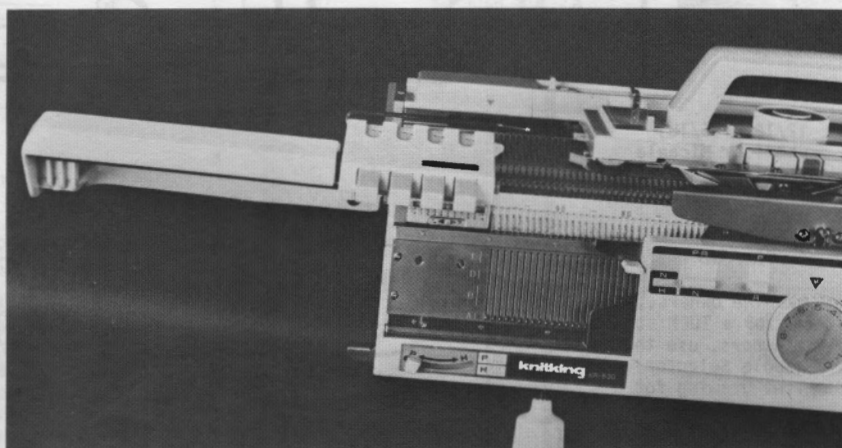

FOR 820 or 830 KNITTER AND RIBBER COMBINATION...

The KRC 830 Color Changer can only be used on the Knitter and Ribber Combination. It cannot be used on the machine alone.

The 830 Color Changer makes it possible to use up to 400 needles (Knitter and Ribber combined) and up to four colors in a double knit design

that eliminates loops from the back of your knitting... There is no other Color Changer as advanced in Design.

PRICE.... \$79.95

California residents add Sales Tax.. Shipping costs..\$2.00

DK 465



WOMAN'S DRESS

SIZES: 8 (10) [12]
 YARN: Bouclé
 GRAMS: 550 650 750
 TENSION: 7 to 9
 GAUGE: 12 sts. 20 rows = 5 cm (2")

Stockinette stitch on the Purl side.

FINISHING: See General Instructions.
 If you did not work garter stitch around the bottom edge, make a hem, or work several rows single crochet. Sew front neck bands in place and sew on buttons.
 Sew on Collar. Make hem on sleeves.

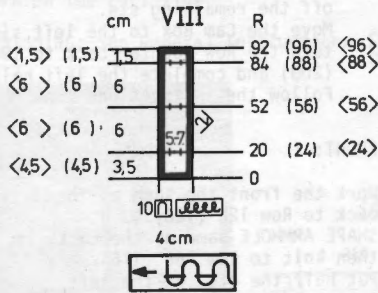
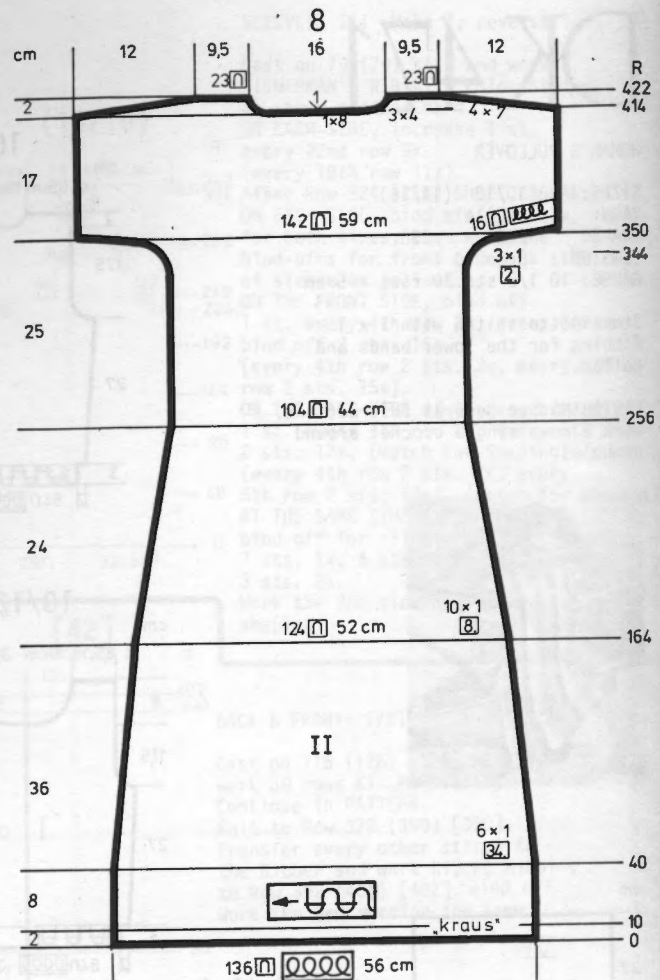

FRONT BAND: VIII Make 2.

Cast on 10 sts. and work Stockinette stitch.
 Make **BUTTONHOLES** over needles 5 to 7 counting from the left edge after the rows shown on Chart for YOUR SIZE.
 After Row 92 (96) [96], bind off
 Make another band the same but omit the Buttonholes.

DK 462

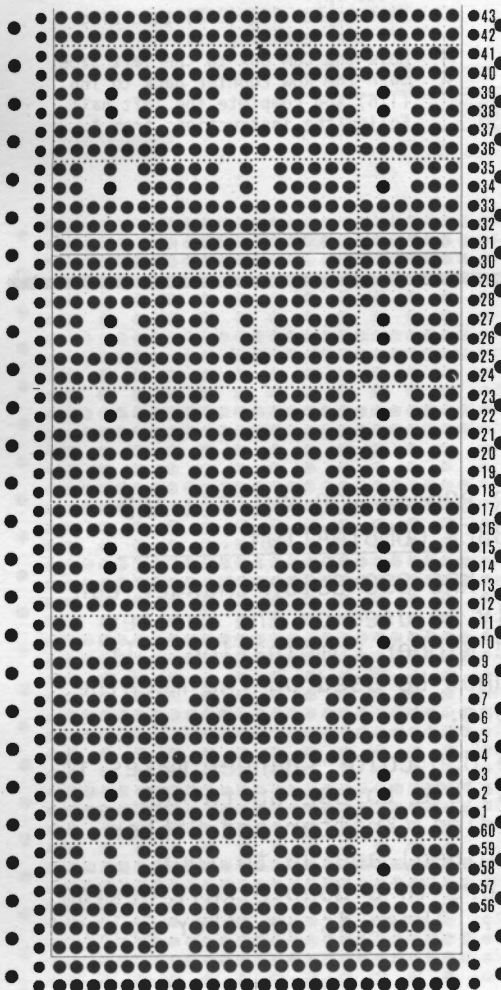

WOMAN'S PULLOVER

SIZES: 12/14 (16/18)
 YARN: Cheri or Micaela
 GRAMS: Cheri 1 Cone 1 Cone
 Micaela 450 500
 TENSION: 6 to 8
 GAUGE: 14 sts. 26 rows = 5 cm (2")

Punch card machine owners, punch your own Card for a TUCK stitch.
 AM 3 machine owners, use the Adjustable Needle Selector and follow the line drawing for a Holding Position Design.
 Worn on the Purl side.

FINISHING: See General Instructions. 50

Punch Card Machine owners - Set machine on KC, card on STOP. Knit 1 row from left to right. Set card on GO and push in BOTH TUCK Buttons.

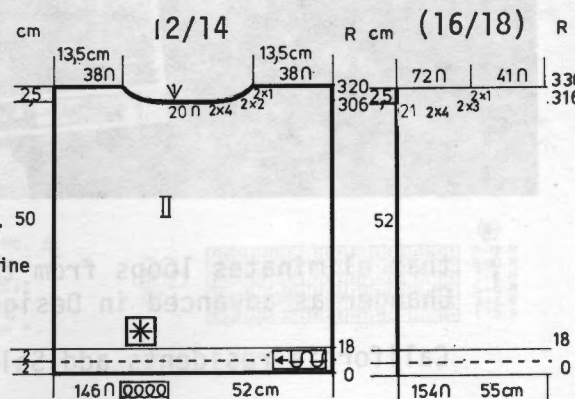
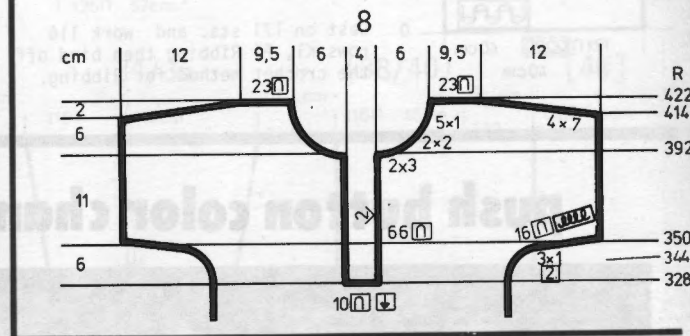

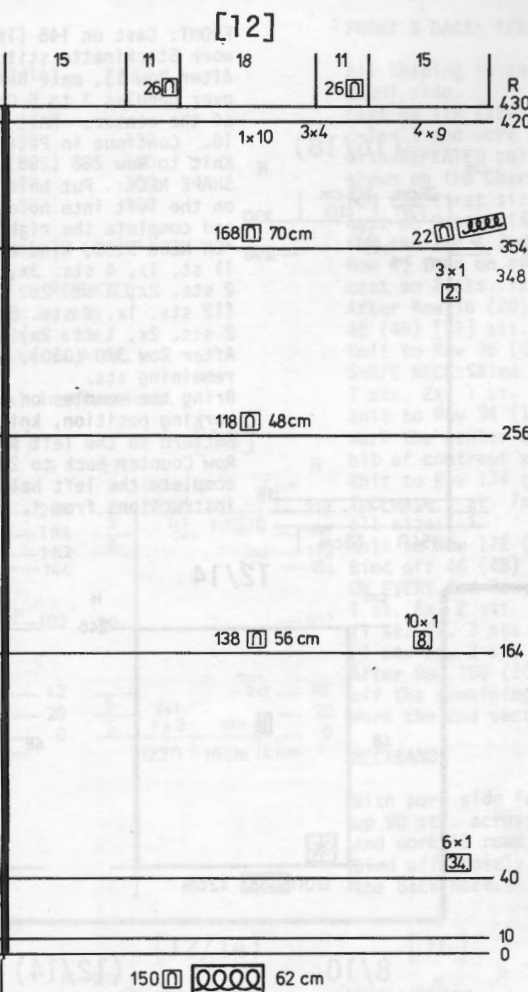
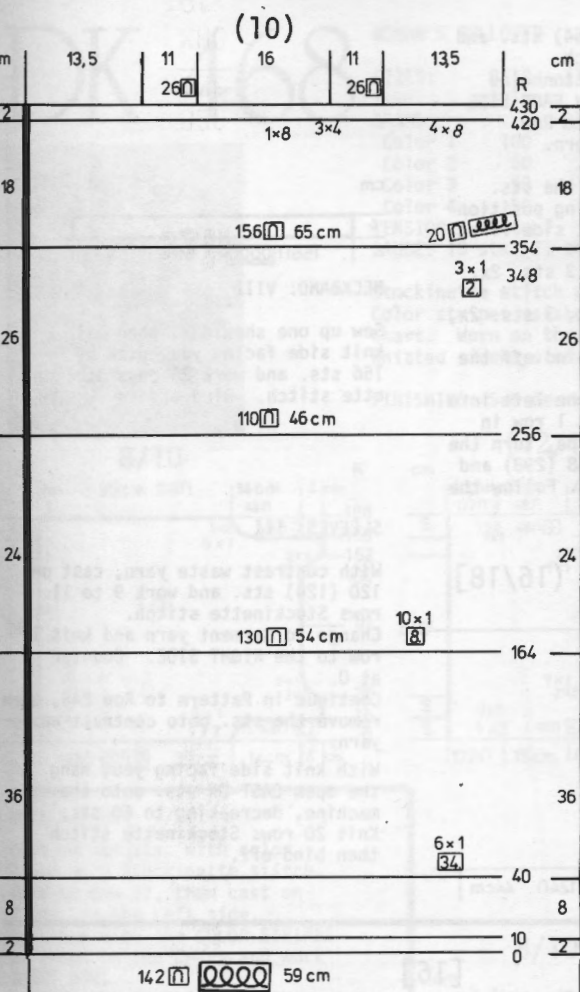

BACK: II

Cast on 136 (142) [150] sts. You may work 10 rows of garter stitch, reversing the knitting on EVERY row - or you may turn up a hem later - or crochet around the lower edge. Continue in Stockinette stitch. Knit to Row 40.

ON EACH SIDE, decrease 1 st. every 34th row 6x.

After Row 164, ON EACH SIDE, decrease 1 st. every 8th row 10x. Knit to Row 344 (348) [348].

ON EACH SIDE, cast on 16 (20) [22] sts. Knit to Row 414 (420) [420].

Divide in the center, put half the sts. on the left into holding position and complete the right side first.

*SHAPE SHOULDER AND NECK AT THE SAME TIME.

FOR SHOULDER, bind off 7 sts. 4x, 23 sts. 1x. (8 sts. 4x, 26 sts. 1x). [9 sts. 4x, 26 sts. 1x].

FOR NECK, bind off 8 (8) [10] sts. 1x, then 4 sts. 3x for all sizes.

Move the Cam Box to the left side, turn the Row Counter back to 414 (420) [420] and complete the left half. Follow the instructions from *.

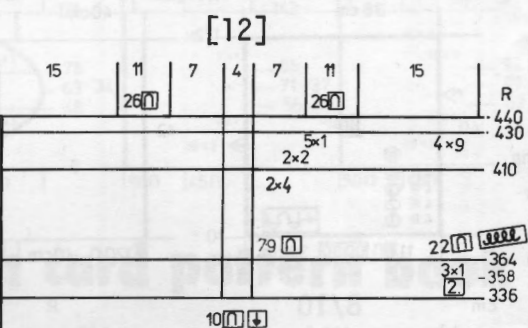
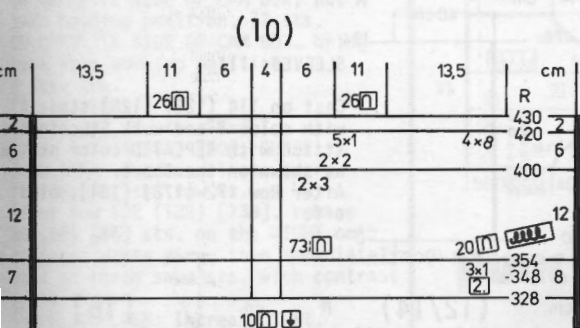

FRONT: I

Work the front the same as the back to Row 328 (328) [336]. Bind off the center 10 sts., put the needles on the left into holding position and complete the right side first.

*Knit to Row 344 (348) [358]. On every 2nd row, cast on 1 st. 3x, then cast on 16 (20) [22] sts. Knit to Row 393 (401) [411].

ON NECK SIDE, bind off 3 sts. 2x, 2 sts. 2x, 1 st. 5x. (3 sts. 2x, 2 sts. 2x, 1 st. 5x). [4 sts. 2x, 2 sts. 2x, 1 st. 5x].

After Row 414 (420) [430], SHAPE SHOULDER same as the back.

Move the Cam Box to the left side, turn the Row Counter back to 328 (328) [336] and complete the left half. Follow the instructions from *.

BACK: II

Cast on 146 (154) sts. and work 18 rows Stockinette stitch. Continue in Pattern. Knit to Row 306 (316).

SHAPE NECK: Put half the sts. on the left into holding position and complete the right side first.

*ON NECK SIDE, bind off 21 sts. 1x, 4 sts. 2x, 2 sts. 2x, 1 st. 2x. (20 sts. 1x, 4 sts. 2x, 3 sts. 2x, 1 st. 2x).

After Row 320 (330), bind off the remaining sts.

Bring the needles on the left into working position, knit 1 row in pattern to the left side, turn the Row Counter back to 306 (316) and complete the left half. Follow the instructions from *.

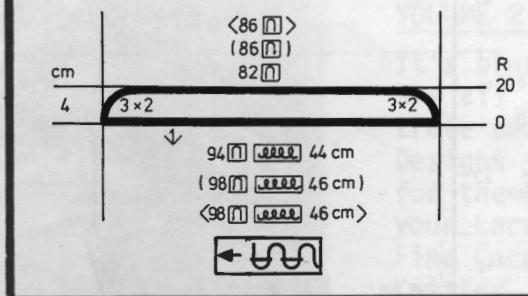

COLLAR: VI

With contrast waste yarn, cast on 94 (98) [98] sts. and work Stockinette stitch. Knit 8 to 10 rows then change to garment yarn and put Counter at 0.

ON EACH SIDE, decrease 2 sts. every 2nd row 3x.

After Row 20, bind off.

AM 3 machine owners, follow the Line Drawing and use the Adjustable Needle Selector.

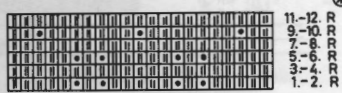

Continued

DK 462

FRONT: Cast on 146 (154) sts. and work Stockinette stitch. After Row 15, make Buttonholes over needles 3 to 5 ON EACH SIDE of the center. Knit to Row 18. Continue in Pattern. Knit to Row 288 (298).

SHAPE NECK: Put half the sts. on the left into holding position and complete the right side first. *ON NECK SIDE, bind off 11 st. 1x, 4 sts. 3x, 3 sts. 2x, 2 sts. 2x, 1 st. 2x. (12 sts. 1x, 4 sts. 3x, 3 sts. 2x, 2 sts. 2x, 1 st. 2x). After Row 320 (330), bind off the remaining sts. Bring the needles on the left into working position, knit 1 row in Pattern to the left side, turn the Row Counter back to 288 (298) and complete the left half. Follow the instructions from *.

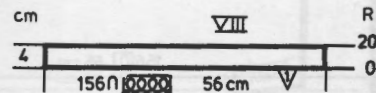

NECKBAND: VIII

Sew up one shoulder, then with knit side facing you, pick up 156 sts. and work 20 rows Stockinette stitch. Bind off

SLEEVES: III

With contrast waste yarn, cast on 120 (124) sts. and work 9 to 11 rows Stockinette stitch. Change to Garment yarn and knit 1 row to the RIGHT SIDE. Counter at 0. Continue in Pattern to Row 246, then remove the sts. onto contrast waste yarn.

With knit side facing you, hang the open CAST-ON sts. onto the machine, decreasing to 60 sts. Knit 20 rows Stockinette stitch then bind off.

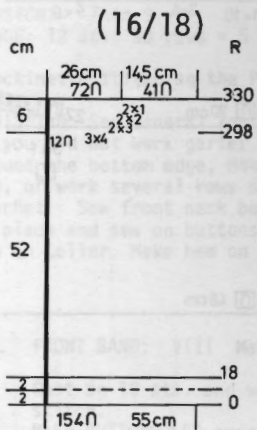
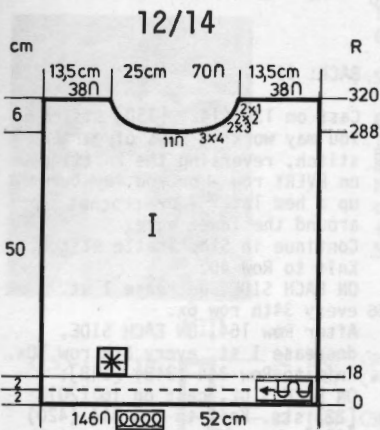

DK 463

WOMAN'S JACKET

SIZES: 8/10 (12/14) [16]
YARN: Allegro

GRAMS:			
Color 1	150	200	200
Color 2	100	100	100
Color 3	100	100	100
Color 4	100	100	100

TENSION: 5 to 7
GAUGE: 15 sts. 21 rows = 5 cm (2")

Stockinette stitch with REPEATED Color stripes as shown on the Chart. Knitted sideways on the machine. The Purl side is the right side. Sleeve bands are K1, P1 Ribbing.

FINISHING: See General Instructions.

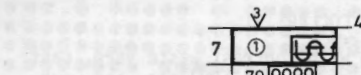

SLEEVE BANDS: Make 2. Cast on 70 (74) [74] sts. with color 1 and work 48 rows K2, P2 (or K1, P1) Ribbing. Bind off the crochet method for Ribbing.

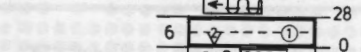

BACK NECKBAND: Cast on 64 (68) [70] sts. with color 1 and work 28 rows Stockinette stitch then bind off.

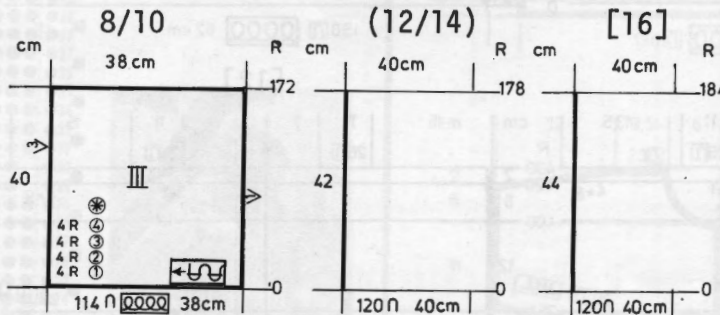
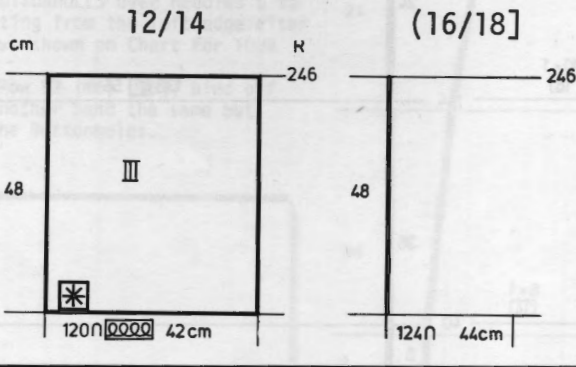

SLEEVES: III

Cast on 114 (120) [120] sts. with color 1 and work Stockinette stitch with REPEATED color stripe as shown on the Chart. After Row 172 (178) [184], bind off.

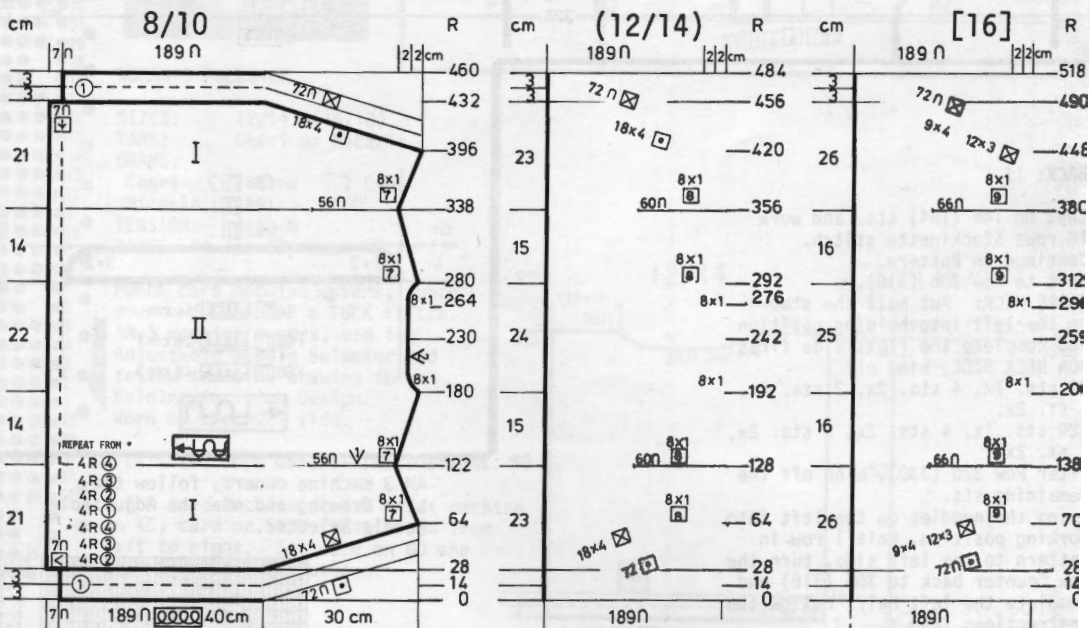

DK 468

WOMAN'S PULLOVER

SIZES: 8/10 (12/14) [16]
 YARN: Allegro
 GRAMS:
 Color 1 100 -150 150
 Color 2 50 50 100
 Color 3 50 50 100
 Color 4 50 50 100
 TENSION: 5 to 7
 GAUGE: 15 sts. 21 rows = 5 cm (2")

Stockinette stitch with REPEATED Color stripes as shown on the Chart. Worn on the Purl side. Knitted sideways on the machine.

FINISHING: See General Instructions.

FRONT & BACK: I/II

All Shaping is on the RIGHT side.
 Cast on 118 (122) [122] sts. with color 1 and work Stockinette stitch with REPEATED color stripes as shown on the Chart.
 For the first size - On every 2nd row, cast on 2 sts. 1x, 1 st. 6x.
 For the 2nd & 3rd Sizes, after Row 4, then on every 2nd row, cast on 2 sts. 1x, 1 st. 7x.
 After Row 16 (20) [20], cast on 46 (48) [51] sts.
 Knit to Row 36 (42) [46].
 SHAPE NECK: Bind off 2 sts. 2x, 1 st. 7x for all sizes. Knit to Row 94 (102) [102] then mark the center of neck with a bit of contrast waste yarn.
 Knit to Row 134 (144) [154]. Increase 1 st. 7x, 2 sts. 2x for all sizes.
 Knit to Row 172 (184) [198]. Bind off 46 (48) [51] sts. ON EVERY 2nd Row, bind off 1 st. 6x, 2 sts. 1x. (1 st. 7x, 2 sts. 1x). [1 st. 7x, 2 sts. 1x].
 After Row 188 (204) [218], bind off the remaining sts.
 Work the 2nd section the same.

NECKBAND:

With purl side facing you, pick up 90 sts. across the front neck and work 10 rows Stockinette stitch. Bind off loosely. Do the same for the back neck.

SLEEVES: III

Cast on 50 sts. with color 1 and work Stockinette stitch with REPEATED Color Stripes as shown on the Chart.
 ON EVERY 2nd row, cast on 2 sts. 18x (19x) [19x], 1 st. 4x (7x) [10x].
 After Row 63 (71) [77], mark the center of sleeve cap with a bit of contrast waste yarn.
 Knit to Row 78 (86) [92]. Bind off 1 st. 4x (7x) [10x], then bind off 2 sts. 18x (19x) [19x].
 After Row 126 (142) [154], bind off the remaining sts.

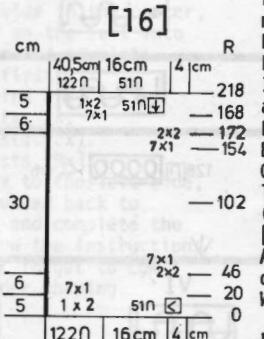
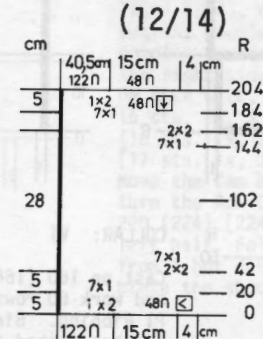
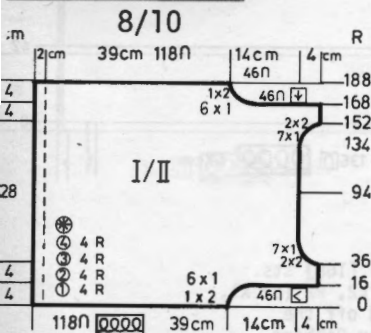

BACK & FRONT: I/II

Cast on 189 sts. with color 1 and work Stockinette stitch. Knit to Row 27, then cast on 7 sts. on the Left side. Continue with the COLOR STRIPES as shown on the Chart and work SHORT ROWS.
 ON OPPOSITE SIDE OF CAM BOX, put into holding position, 72 sts.
 ON OPPOSITE SIDE OF CAM BOX, bring back into working position 4 sts. 18x.
 4 sts. 18x.
 4 sts. 9x, 3 sts. 12x].
 After Row 64 (64) [70], SHAPE SHOULDER: Decrease 1 st. every 7th (8th) [9th] row 8x.
 After Row 122 (128) [138], remove 66 (60) [66] sts. on the RIGHT onto contrast waste yarn, then immediately cast on these same sts. with contrast waste yarn.
 SHAPE SHOULDER: Increase 1 st. every 7th (8th) [9th] row 8x.
 After Row 180 (192) [206], SHAPE NECK: Bind off 1 st. 8x.
 After Row 264 (276) [296], cast on 1 st. 8x.
 After Row 280 (292) [312], SHAPE SHOULDER: Decrease 1 st. every 7th (8th) [9th] row 8x.
 After Row 338 (356) [380], remove 66 (60) [66] sts. on the RIGHT onto contrast waste yarn, then immediately cast on these same sts. with waste yarn.
 SHAPE SHOULDER: Increase 1 st. every 7th (8th) [9th] row 8x.
 After Row 397 (421) [449], work SHORT ROWS: ON OPPOSITE SIDE OF CAM BOX, put into holding position, 4 sts. 18x.
 4 sts. 18x)
 3 sts. 12x, 4 sts. 9x].
 Bring all the needles back into working position before knitting the next row.
 After Row 433 (457) [491], cast on 4 sts. on the left with color 1 and continue with color 1 to Row 50 (484) [518]. Bind off.

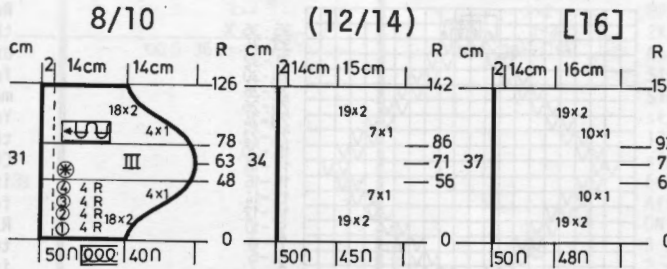

punch card pattern book

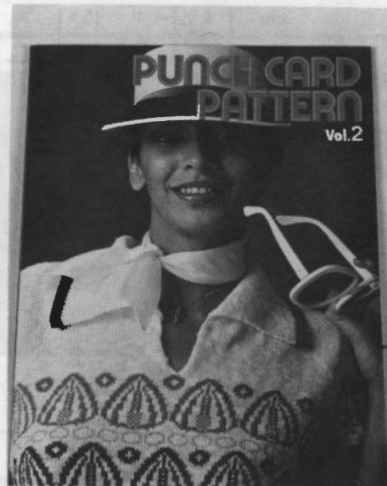

VOLUME 2

It's brand new, its contents are all in color and illustrate beautiful Punch Card Designs you can punch yourself for the KHC 820 Color Changer.. your Lace Maker and the new Fine Lacer on the new KH 830 Knitter. PRICE.... \$7.95

Calif. residents add Sales Tax. Shipping costs... 85¢

DK 466 DK 469

WOMAN'S JACKET & SHOULDER BAG

SIZES: 6/8 (10/12) [14]
 YARN: Euro Sport
 GRAMS: 650 700 750
 TENSION: 7 to 9
 GAUGE: 14 sts. 19 rows = 5 cm (2")

IMPORTANT: The Jacket as shown can only be made easily if you own a Ribber where EVERY NEEDLE can be utilized. However, if you want to simulate the ARAN ISLE which is on the Front, Sleeves and Bag, you can knit Stockinette stitch throughout and when jacket is completed, knit cords, form them into the design (see picture) then invisibly sew them in place. The back of jacket is Stockinette stitch. The bands are K2, P2 (or K1, P1) Ribbing. After Setting up the Pattern for the first Row, follow the Line Drawing.

FINISHING: See General Instructions. **SHOULDER BAG:** Fold bag in half and sew side seams. Line if you like. Sew on Shoulder strap. Embroider flowers on front (see picture).

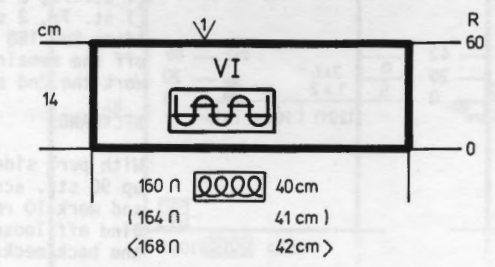
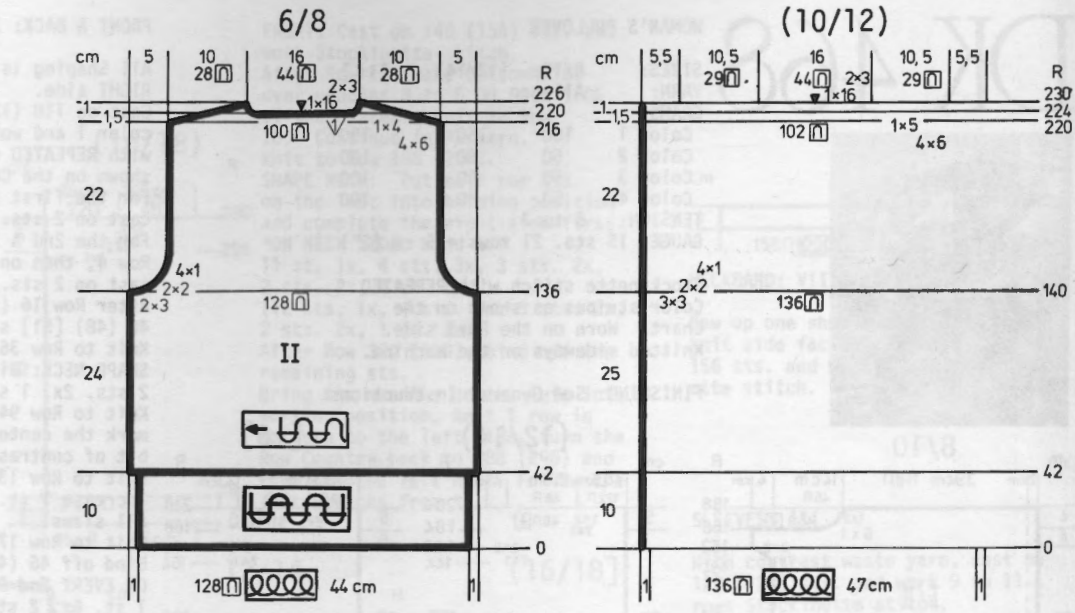

COLLAR: VI
 Cast on 160 (164) [168] sts. and work 60 rows K2, P2 (or K1, P1) Ribbing. Bind off the crochet method for Ribbing.

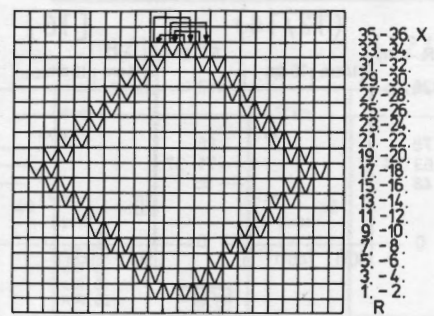

V = Knit st. REPEAT from Row 3.
 □ = Purl st.

FRONT: Make 1, reverse 1.
 Cast on 66 (70) [74] sts. and work 42 rows K2, P2 Ribbing (or K1, P1). Set up the first row of Pattern as follows:
 Remember that the purl sts. are on the main machine and the knit sts. are on the Ribber - as the stitches face you on the machine - so.. P = main machine and K= Ribber needles. You now must ADD 12 sts. across and these additional 12 sts. are NOT COUNTED in the stitch gauge or the instructions so that when binding off for any shaping, the 12 sts. on the RIBBER are bound off when you come to them but you MUST NOT COUNT THEM in the bind-offs.

Set up for first Row.
 6P, 2K, 6P, 2K, 12P, 4K, 12P, 2K, 6P, 2K, 24 (28) [32]P. You will have 12 sts. on the Ribber and you must FILL the empty main machine needles by picking up sts. from each side to fill 2 needles and where there are 4 sts. to pick up, pick up 2, knit 1 row, then pick up 2 more. (alternate when picking up).
 Continue in Pattern, following the Line Drawing.
 Knit to Row 136 (140) [148].
SHAPE ARMHOLE: Bind off 4 sts. 1x, 3 sts. 2x, 2 sts. 1x, 1 st. 4x.
 (4 sts. 1x, 3 sts. 2x, 2 sts. 3x, 1 st. 3x).
 [4 sts. 1x, 3 sts. 2x, 2 sts. 3x, 1 st. 4x].
 Knit to Row 195 (199) [207].
SHAPE NECK: Bind off 4 sts. 1x, 3 sts. 2x, 2 sts. 3x, 1 st. 6x.
 (4 sts. 1x, 3 sts. 2x, 2 sts. 3x, 1 st. 6x).
 [4 sts. 1x, 3 sts. 2x, 2 sts. 4x, 1 st. 5x].
 After Row 216 (220) [228],
SHAPE SHOULDER same as the back. Work the 2nd front with reverse shaping, setting up the first row of Pattern in Reverse.

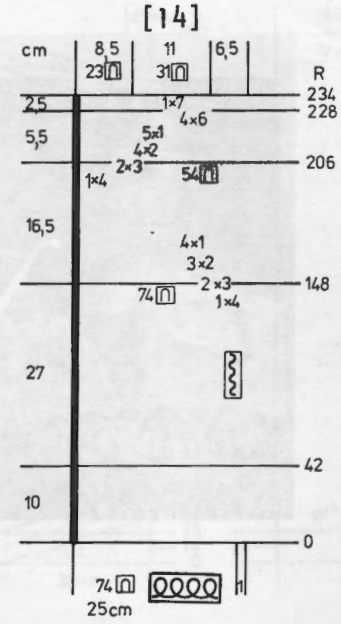
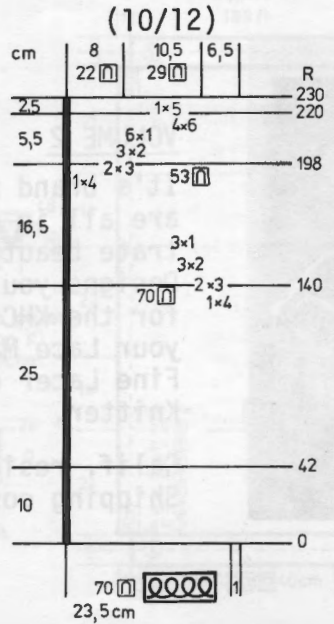
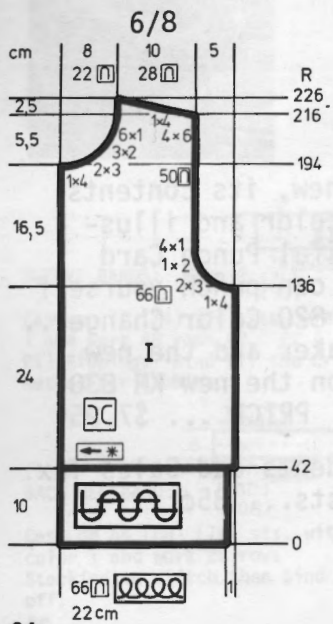

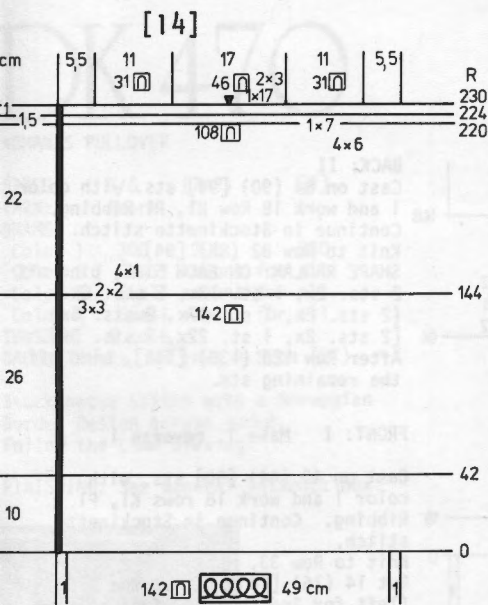

BACK: II

Cast on 128 (136) [142] sts. and work 42 rows K2, P2 (or K1, P1) Ribbing.
 Continue in Stockinette stitch.
 Knit to Row 136 (140)[144].
SHAPE ARMHOLE: ON EACH SIDE, bind off
 3 sts. 2x, 2 sts. 2x, 1 st. 4x.
 (3 sts. 3x, 2 sts. 2x, 1 st. 4x).
 [3 sts. 3x, 2 sts. 2x, 1 st. 4x].
 Knit to Row 216 (220) [220].
SHAPE SHOULDER and watch for NECK SHAPING.
FOR SHOULDER, bind off
 6 sts. 4x, 4 sts. 1x;
 (6 sts. 4x, 5 sts. 1x);
 [6 sts. 4x, 7 sts. 1x];
 *FOR NECK, after Row 220 (224) [224], divide in the center, put the needles on the left into holding position and complete the right side first.
ON NECK SIDE, bind off
 16 sts. 1x, 3 sts. 2x.
 (16 sts. 1x, 3 sts. 2x).
 [17 sts. 1x, 3 sts. 2x].
 Move the Cam Box to the left side, turn the Row Counter back to 220 (224) [224] and complete the left half. Follow the instructions from * but don't forget to complete the shoulder shaping.

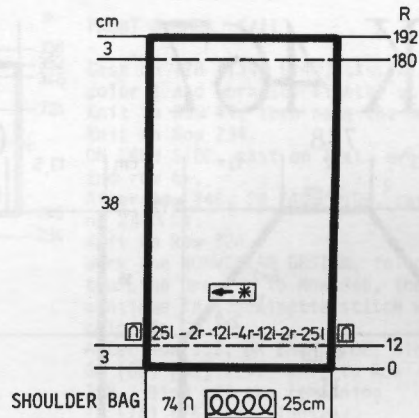

SHOULDER BAG 74 n [0000] 25cm
 Cast on 74 sts. and work 12 rows Stockinette stitch.
 Set up the Pattern as follows adding 8 sts. across as follows:
 25P, 2K, 12P, 4K, 12P, 2K, 25P.
 Continue in Pattern to Row 180.
 Transfer the Ribber sts. to the main machine and knit Stockinette stitch to Row 192.
 Bind off.
STRAP: Cast on 20 sts. half on the Ribber and Half on the main machine. Work circular knitting 90 cm (35 1/2") long then bind off. Sew in place. See picture.

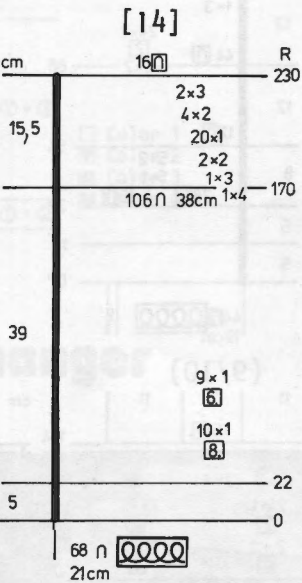
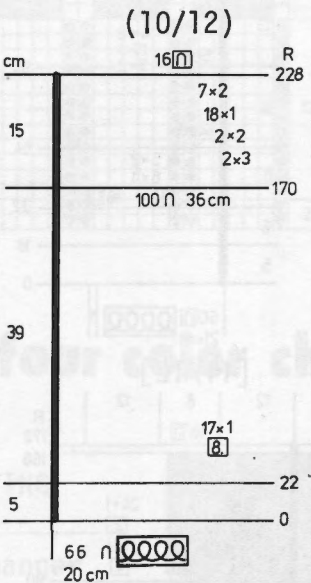
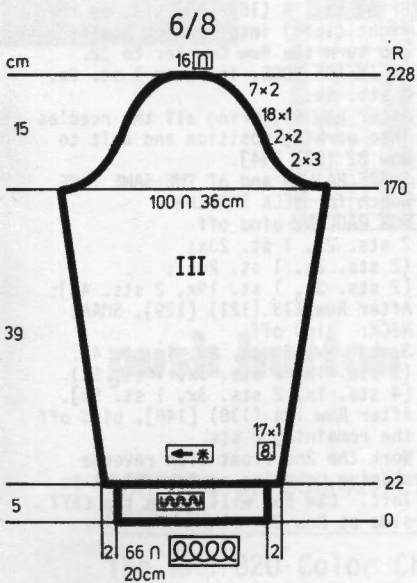

SLEEVES: III

Cast on 66 (66) [68] sts. and work 22 rows K2, P2 (or K1, P1) Ribbing.
 Set up the PATTERN in the same manner as you did for the fronts:
 8P, 2K, 13P, 2K, 12P, 4K, 12P, 2K, 13P, 2K, 8 (8) [10]P.
 Continue in Pattern and ON EACH SIDE increase (the increases on Sleeves remain in Stockinette stitch) 1 st. every 8th row 17x (17x) [10x] and for last size only, increase 1 st. every 6th row 9x.
 After Row 170, **SHAPE CAP:**
ON EACH SIDE, bind off
 3 sts. 2x, 2 sts. 2x, 1 st. 18x, 2 sts. 7x.
 (3 sts. 2x, 2 sts. 2x, 1 st. 18x, 2 sts. 7x).
 [4 sts. 1x, 3 sts. 1x, 2 sts. 2x, 1 st. 20x, 2 sts. 4x, 3 sts. 2x].
 After Row 228 (228) [230], bind off the remaining sts.

KK 467

GIRL'S JACKET

SIZES: 7/8 (9/10) [11/12]
YARN: Euro Sport
GRAMS:
 Color 1 300 350 400
 Color 2 150 150 200
TENSION: 10
GAUGE: 11 sts. 14 rows = 5 cm (2")



VIII

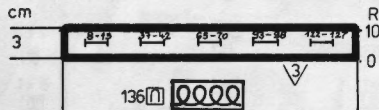

BUTTON & BUTTONHOLE BAND.

Cast on 136 sts. with color 2 and work K1, P1 Ribbing.
 After Row 5, make **BUTTONHOLES** over needles 8 to 13, 37 to 42, 65 to 70, 93 to 98, 122 to 127, counting from the left edge.
 After Row 10, remove the sts. onto contrast waste yarn.
 Make another band the same but omit the Buttonholes.

POCKET BAND: Make 2.

Cast on 30 sts. with color 2 and work 8 rows K1, P1 Ribbing then bind off the crochet method for Ribbing.

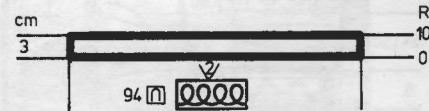

NECKBAND:

Cast on 94 sts. with color 2 and work 10 rows K1, P1 Ribbing then remove the sts. onto contrast waste yarn

Stockinette stitch worn on the Knit side. The Sleeves are Striped on lower section. Bands are K1, P1 Ribbing.

FINISHING: See General Instructions.

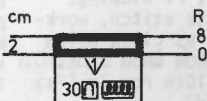

Continued

KK 467

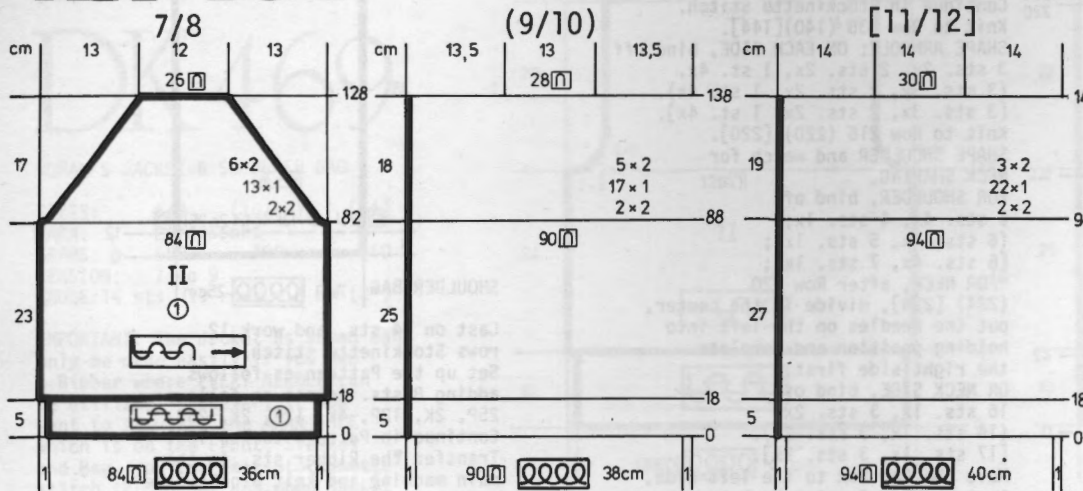

BACK: II
 Cast on 84 (90) [94] sts. with color 1 and work 18 Row K1, P1 Ribbing. Continue in Stockinette stitch. Knit to Row 82 (88) [94].
SHAPE RAGLAN: ON EACH SIDE, bind off 2 sts. 2x, 1 st. 13x, 2 sts. 6x. (2 sts. 2x, 1 st. 17x, 2 sts. 5x). [2 sts. 2x, 1 st. 22x, 2 sts. 3x].
 After Row 128 (138) [148], bind off the remaining sts.

FRONT: I Make 1, reverse 1.

Cast on 40 (44) [50] sts. with color 1 and work 18 rows K1, P1 Ribbing. Continue in Stockinette stitch. Knit to Row 33. Put 14 (16) [18] sts. on the RIGHT (left for 2nd section) into holding position and work over the 26 (28) [32] sts.

ON THE INSIDE EDGE, on every 2nd row, decrease 1 st. 6x, 2 sts. 5x.
 Put the 10 remaining sts. into holding position and move the Cam Box to the RIGHT side (left for 2nd section). Bring the 14 (16) [18] sts. on the right (left) into working position and turn the Row Counter to 32.

ON INSIDE EDGE, increase 1 st. 6x, 2 sts. 5x.
 After Row 54, bring all the needles into working position and knit to Row 82 (88) [94].
SHAPE RAGLAN and AT THE SAME TIME watch for NECK SHAPING.

FOR RAGLAN, bind off 2 sts. 2x, 1 st. 23x; (2 sts. 2x, 1 st. 24x); [2 sts. 3x, 1 st. 19x, 2 sts. 4x];
 After Row 113 (121) [129], **SHAPE NECK: Bind off 3 sts. 1x, 2 sts. 2x, 1 st. 4x. (3 sts. 1x, 2 sts. 3x, 1 st. 5x). [4 sts. 1x, 2 sts. 3x, 1 st. 5x].**
 After Row 124 (138) [146], bind off the remaining 2 sts.

Work the 2nd front with reverse shaping, casting on from right to left. Cam Box will be on the LEFT side at Row 0.

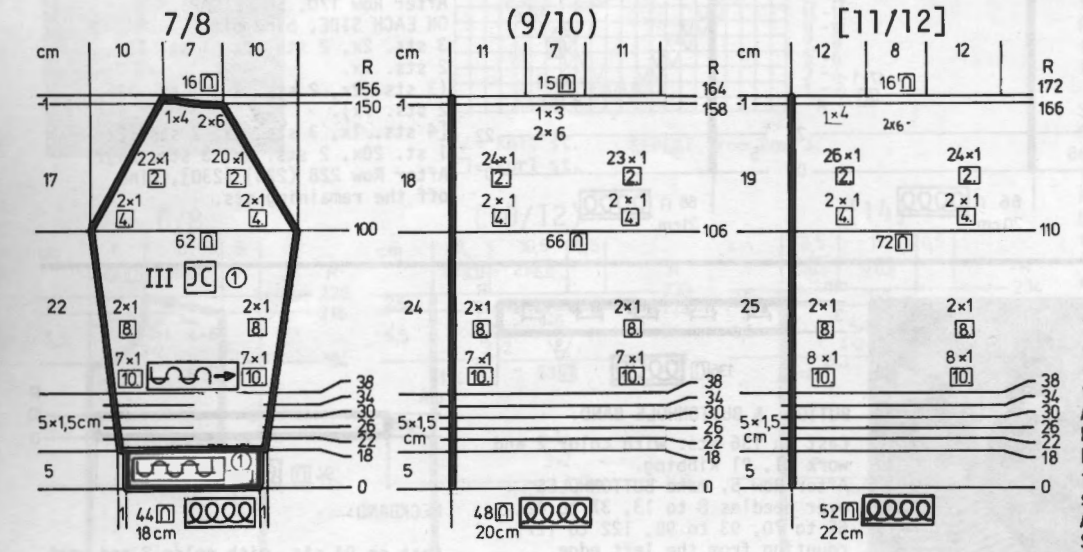
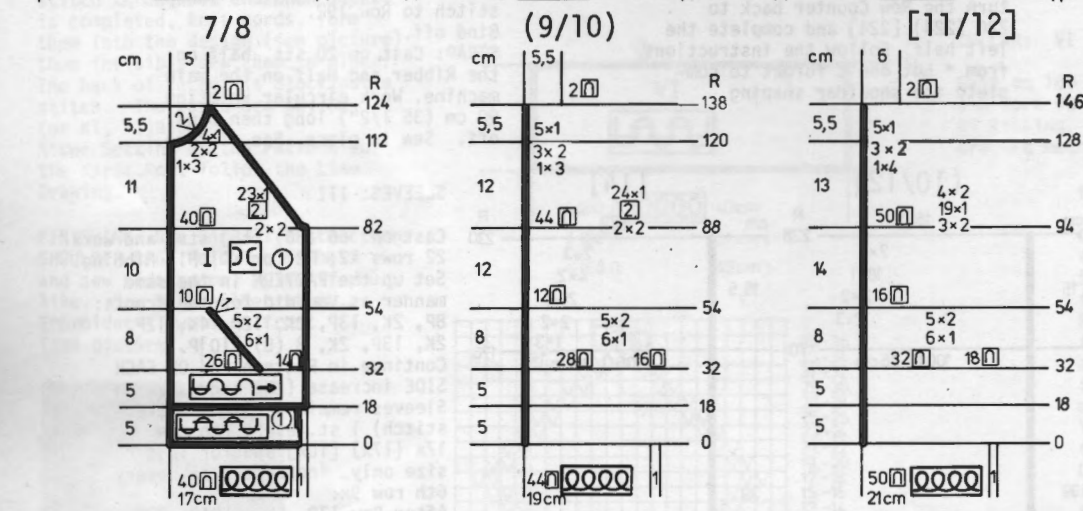

The **COLOR STRIPES** ARE: 4 rows color 2, 4 rows color 1, 4 rows color 2, 4 rows color 1, 4 rows color 2. Continue with color 1.

After Row 100 (106) [110], **SHAPE RAGLAN:**
 Please follow the **CHART** in YOUR SIZE for the different shapings on each side for the Raglan sleeve.
 After Row 151 (159) [167], work **SHORT ROWS:**
ON OPPOSITE SIDE OF CAM BOX, put into holding position, 6 sts. 2x, 4 sts. 1x. (6 sts. 2x, 3 sts. 1x). [6 sts. 2x, 4 sts. 1x].
 Bring all the needles into working position and bind off loosely. Work the 2nd sleeve with reverse shaping, casting on from right to left. Cam Box will be on the LEFT side at Row 0.

POCKET: Make 1 reverse 1.

Cast on 20 sts. and work Stockinette stitch. Knit to Row 14. **ON EVERY 2nd ROW, decrease 1 st. 6x, 2 sts. 5x.**
 After Row 36, bind off the remaining sts.

SLEEVES: III Make 1, reverse 1.

Cast on 44 (48) [52] sts. with color 1 and work 18 rows K1, P1 Ribbing. Continue in Stockinette stitch, working the color stripes as given below and **AT THE SAME TIME, ON EACH SIDE, increase 1 st. every 10th row 7x (7x) [8x], every 8th row 2x.**

DK 470

WOMAN'S PULLOVER

SIZES: 5/6 (7/8) [9]

YARN: Amore

GRAMS:

Color 1 300 300 350
 Color 2 Small amount for all.
 Color 3 Small amount for all.
 Color 4 Small amount for all

TENSION: 4 to 6

GAUGE: 17 sts. 28 rows = 5 cm (2")

Stockinette stitch with a Norwegian
 Border Design across yoke.
 Follow the Line Drawing.

FINISHING: See General Instructions.

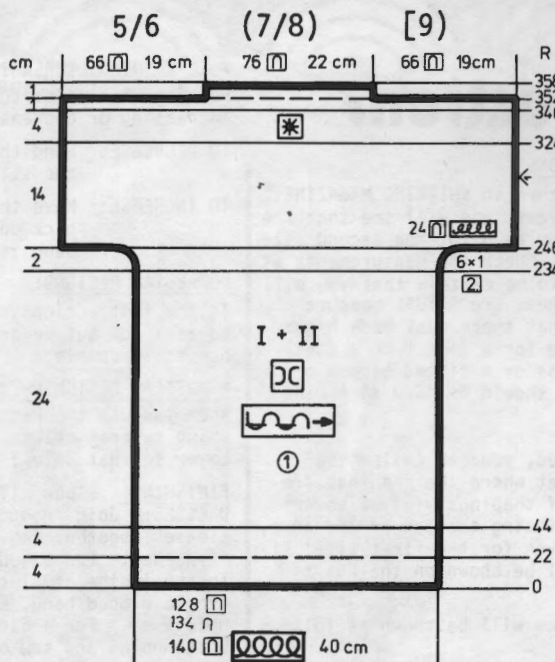

FRONT & BACK 1/II

Cast on 128 (134) [140] sts. with color 1 and work Stockinette stitch. Knit to Row 44, then hang the hem. Knit to Row 234.
 ON EACH SIDE, cast on 1 st. every 2nd row 6x.
 After Row 246, ON EACH SIDE, cast on 24 sts.
 Knit to Row 324.
 Work the NORWEGIAN DESIGN, following the Line Drawing to Row 346, then continue in Stockinette stitch with color 1.
 After Row 352, ON EACH SIDE, bind off 58 (60) [62] sts. Knit to Row 358. Bind off the remaining 72 (74) [76] sts. loosely.

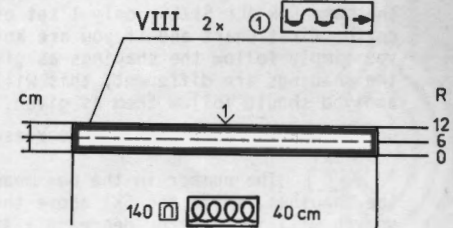

SLEEVE BANDS: VIII Make 2.

Sew up shoulders first, then with right side facing you, pick up 140 sts. along sleeve edge. Work Stockinette stitch. Knit 6 rows tension 3 to 4, 1 row main tension, 6 rows tension 3 to 4. Bind off loosely.

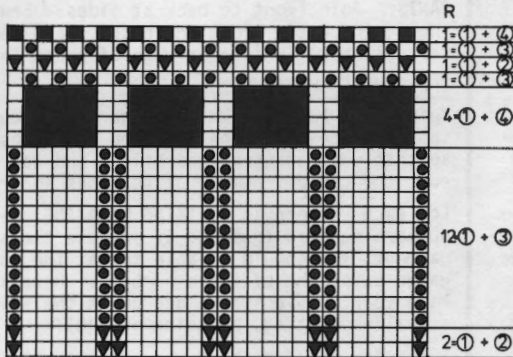

push button four color changer

FOR 820 or 830 KNITTING MACHINE...

The KHC 820 Color Changer is for the basic knitter only. You cannot use it on the Knitter Ribber combination.

With the 820 Changer, you can use as many as Four Colors in a design and up to three colors in one row...

It comes complete with extra Color Feeders... special adaptor Plate for the front of your Carriage... Push Button Changer, Instructions Manual and ten Multi-Color Punch Cards.

PRICE \$79.95

California residents add Sales Tax.. Shipping costs..\$2.00

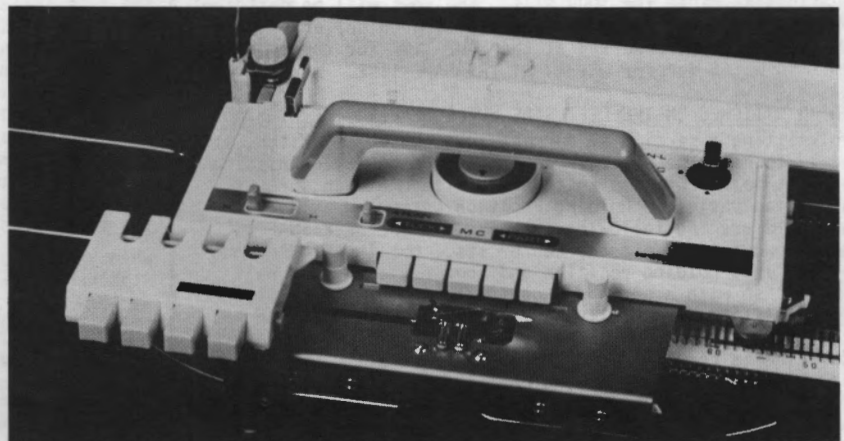

General Instructions

HOW TO READ THE CHARTS AND INSTRUCTIONS

There are 3 sizes given for each Pattern in KNITKING MAGAZINE. Above each Chart for the different sizes, you will see that the first and smaller sizes might be shown as 8/10, the second size as (12/14) and the third as [16/18]. Check the measurements at the bustline and hips on the Charts to be certain that you will knit the correct size, remembering these are ACTUAL measurements of the completed section and that there must be a bigger allowance at the bustline and hipline for a Jacket or a Coat than there would be for a fitted dress or a fitted blouse or pullover. The question in your mind should be "How do I want this garment to fit...?"

When you have chosen the size you need, you can follow the Charts as shown. You will notice that where the shapings are the same FOR ALL SIZES, only 1 set of shapings will be shown on the first Chart and if you are knitting the 2nd or 3rd size, you simply follow the shapings as given for the first size. If the shapings are different, this will be shown on the Charts and you should follow them as given.

On the Charts, increases and decreases will be shown as follows

5x1

6 The number in the box means number of ROWS between the shapings, while the 5x1 above the box means - 1 st. 5x... so you will increase or decrease 1 st. every 6th row 5x.

ARMHOLE SHAPINGS - NECK SHAPINGS - SHOULDER SHAPINGS - are made on every 2nd row UNLESS there is a number in a box along side or below the shapings. The rule is... where there is no box with a number, the shaping is made on every 2nd row.

THE PRINTED INSTRUCTIONS

You can follow the printed instructions or use them in combination with the Charts. Where there is any question in the printed instructions, you have the Charts to show you how the section will look.

The 3 sizes, with the different amounts of cast on stitches and the different shapings will look like this...

Cast on 124 (136) [148] sts. You will
Cast on 124 sts. for the first size.
Cast on 136 sts. for the 2nd size.
Cast on 148 sts. for the 3rd size.

The important thing to remember is that you MUST READ AHEAD so that you KNOW what to do for the size you are knitting. Sometimes where the number of stitches are the same but the number of times different, you will find shapings like this...
3 sts. 1x (2x) [3x], 2 sts. 1x (2x) [3x], 1 st. 3x (4x) [5x].
As you see, you MUST read ahead in order to follow the instructions as given for YOUR SIZE. The rows will be different for the different sizes in some cases... Shoulder and Neck shapings usually are worked at the SAME TIME for the back section - so watch for the words AT THE SAME TIME.

HOLDING STITCHES ON THE LEFT SIDE WHILE SHAPING THE RIGHT SIDE

When knitting a section of garment in stockinette stitch, it is easy to hold the stitches on the left side while knitting the right half, but when knitting a Pattern Stitch such as a Norwegian Design, a Holding Position Design, Weaving, etc., you should use the following method. For the NECK SHAPING, we tell you to bind off the center sts., put the needles on the left into holding position and complete the right half first... so with a strand of contrast yarn, knit ALL of the left side stitches manually by hand, pulling each stitch back against the needle bed to the OUT OF WORK position. When the right side is completed, carefully pull the stitches held on contrast, forward into working position and as you do so, undo the contrast yarn, line up the needles (KNITKING machine owners, put the stitches under the sinkers) and complete the left half.

If you own a Japanese machine, you may find that when knitting the right half with the left side held in this way, the sinker plate will mark the left side while you are knitting the right half. To prevent this marking, you can tape a piece of paper over the knitting, underneath the sinkers, or if you own a Reversing Bar, you can hang this onto the Sinkers while you are knitting the right half. When hanging the Reversing Bar, be sure the eyes of the bar go BETWEEN the Sinker Posts on the upper part of the bar so that the tips of the bar only - show above the needle bed.

FULL FASHION DECREASING OR INCREASING

For Stockinette stitch, always use the Full Fashion method for increasing or decreasing.

TO DECREASE: Hang the 3rd stitch onto the 2nd stitch then move the stitches in to fill the empty needle.

TO INCREASE: Move the 2 end stitches 1 needle outward, then pick up the 3rd stitch from the row below and hang it onto the empty needle.

NORWEGIAN DESIGNS:

In the instructions, each row of the Norwegian Design is counted as 1 row but several movements of the Cam Box (or Slide) are needed to complete 1 row.

NORWEGIAN DESIGN WHEN USING THE PATTERN READER

When you use the Pattern Reader and knit a Norwegian Design using several colors, it is necessary to move the Trip Control Lever so that only 1 row registers.

FINISHING: Block all sections. For PULLOVERS, JACKETS, and DRESSES: Join front to back at sides and shoulders. Sew sleeves together and set in. Hem lower edge and sleeve edges if needed. For a double neckband or armhole band, sew 1 edge to the inside and 1 to the outside of neck or armhole. For a single ribbed band, sew 1 edge to the outside of neck or armhole edge. For a cardigan or jacket with buttonholes, finish buttonholes and sew on buttons.

PANTS: Join front to back at sides. Sew inside leg seams, then join center front and back. Make hem at waistline and insert elastic. Hem lower edge of pants legs.

THE SAMPLE SWATCH

Before you begin to knit any garment, you will need to knit a sample piece using the yarn you have chosen for your garment, so that you can check the stitch and row gauge which must measure the correct number of stitches and rows in 5 cm (2 inches).

For each Pattern in KNITKING MAGAZINE, we give you 3 tension numbers to work from and if you use the specified yarn for the garment, you should be able to get the correct stitch and row gauge using one of these numbers. Here is a very easy way to make your sample swatch and count the stitches and rows without actually counting, by using our KNITKING Converta Tape.

Supposing the Tension Numbers for the Stitch and Row Gauge are given as 5 to 7. Set the Tension Dial to the first number which is 5. With contrast waste yarn, and using the quick cast on method, cast on 60 stitches and knit 10 rows. Change to garment yarn and turn the Row Counter to 0. Knit 30 rows. Counting from each end, knit the 10th stitch on each side by hand with a small piece of contrast yarn. Leave the needles in working position and knit 30 rows (Row 60), then knit 4 rows with contrast waste yarn. Turn the Row Counter to 0 and the Tension Dial to 6 and with garment yarn, knit 30 rows. Mark the 10th stitch on each side as you did before, knit 30 rows, then 4 rows with contrast waste yarn. Turn the Row Counter to 0 and with Tension 7, repeat the above once more, ending with 10 rows of contrast waste yarn. Remove the work from the machine by passing the Slide across the needles without yarn (sometimes called 'dropping'). Pull and stretch the sample piece both lengthwise and diagonally from corner to corner, then lengthwise again. Do not count the stitches and rows immediately, but allow the sample to rest for several hours or even over night. This will allow the stitches and rows to return to their basic form.

When your sample has rested and you are ready to count the stitches and rows, the KNITKING CONVERTA TAPE will do the counting for you without any counting on your part. Use the Tape as follows:

To measure the stitches, pull out the Tape to measure BETWEEN the 40 stitches in the center that you marked by hand knitting with contrast waste yarn - Push the red marker on the Tape so that it points to 40 stitches on the Tape. Your stitch gauge to 5 cm (2 inches) will shown in the red window on the tape. To find the number of rows in 5 cm (2 inches), place the tape to measure over 60 rows, push the red marker to 60 on the tape and your row gauge for 5 cm (2 inches) will show in the red window... Easy...? If you do not get the correct stitch and row gauge in the first part of your sample, then try the other two.

If you do not own a KNITKING CONVERTA TAPE, you must mark a 5 cm (2 inch) square in the center of the knitting, then count the number of stitches and rows within the square.

A young girl with brown hair and bangs is smiling and posing with her hands raised above her head. She is wearing a short-sleeved, button-down cardigan with horizontal stripes in blue and yellow, and blue knitted shorts with a tassel at the waist. She is standing next to a two-tiered white cake. The background is a solid tan color. The entire scene is framed by a decorative border of concentric circles in black, white, and yellow. In the bottom left corner, there is a small red toy figure.

KK 458

DK 466

p. 34

p. 35

DK 469





DK 468

HP 461

See p. 28



DK 459



DK 474

DK 456

DK 457

*Putlover
p. 26*

DK 473

*Bag
p. 26*



HP 449



DK 465





KK 467

KK 454

