

knitking
magazine

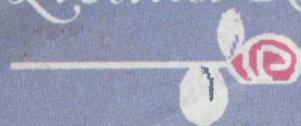

Exclusive.. 
*A Collection of
the Loveliest &
Liveliest Knits*





533



Scrumptious

Feel soft and cuddly in this elegant Sweater that is knitted with the Garter Carriage. Knit it with bulky Venetia and the fluffy Collar and Sleeve Cuffs with Angora. Sized to fit most everyone.





534



Great Shape

Mohair and Angora combine to make a cozy Sweater. It's knitted sideways on the bulky machine and the Intarsia Design splashes across the front, back and sleeves. Bands and Collar are K1, P1 Ribbing. It will fit Medium to Large.



Table of Contents

| TABLE OF CONTENTS | Volume 20 No. 3 | PAGE NO. |
|---------------------------------|-----------------|----------|
| 521—Women's Pullover | | 13 |
| 522—Women's Sleeveless Pullover | | 14 |
| 523—Women's Pullover | | 15 |
| 524—Women's Intarsia Pullover | | 16 |
| 525—Women's Pullover | | 17 |
| 526—Women's Pullover | | 18 |
| 527—Women's Skirt & Cardigan | | 19 |
| 528—Women's Pullover | | 21 |
| 529—Men's Robe | | 24 |
| 530—Men's Crew Neck Sweater | | 25 |
| 531—Child's Dragon Pullover | | 26 |
| 532—Men's Cardigan | | 28 |
| 533—Women's Bulky Pullover | | 29 |
| 534—Women's Pullover | | 30 |
| 535—Women's Polka Dot Dress | | 32 |
| 536—Women's Dress | | 34 |
| 537—Women's Vest | | 35 |
| 538—Women's Tunic | | 36 |
| 539—Women's Shrug | | 37 |
| 540—Child's Cardigan & Pullover | | 38 |
| Knitking News | | 40 |

Cover

Exclusive

Here's a collection of the most beautiful, exciting knits you will find anywhere. Our delightful Cover Model 535 will catch every eye with its scattered Polka Dots and soft surplus closing. You can knit it on any standard machine using the Intarsia method. Venetia is the yarn and you can make it in Sizes 8 to 14.



Editorial

Over a period of several weeks, prior to going to press with this issue, we questioned many customers of greater than average skills and with many years of experience in the operation of both punch card and computer knitting machines regarding their own personal collection of punch cards and computer mylar sheets and just how many different pattern stitches they have in their own collection. Most of them said between 50 and 60... some said as many as 100... the largest amount quoted was 150 and that from a customer with over 25 years of knitting experience. We do not doubt that many of our readers, if they take the time to count, can come up with a figure of 200 or more, but it takes a lot of experience and a lot of knitting to use that number of individual pattern stitches.

If you have not already turned the pages of this issue, take a look at our center page spread and the information regarding the new and incredible COMPUKNIT III (KH 930)... You will see that it has 555!!! Yes, five hundred and fifty-five complete pattern stitch designs already programmed into its computer... more than even the most prolific knitter could use knitting a garment a week for 10 years... every one with a different pattern stitch programmed exactly as illustrated in a special manual supplied with each machine. You can, of course, program any part of a pattern stitch... you can, at the touch of a control, widen, lengthen, reverse, mirror image, etc., etc. You can knit Jacquard designs, Tuck Stitch designs, Weaving designs, Lace designs (thread lace and transfer lace), Skip Stitch designs, Single Motif designs up to 200 stitches wide and many many more things too numerous to mention in this editorial.

The COMPUKNIT III has a programming unit built in and you can program your own original designs directly into the machine without mylar sheets or punch cards... additionally, and what a big plus this is... a Floppy Disk Drive plugs into the back of the machine to record, for recall, any or all of your original pattern stitch designs. One single mini-micro disk will record up to 40 complete pattern stitches. Obviously, the potential supply of pattern stitch designs is limitless.

There is no other automatic knitting machine in the world, irrespective of price or brand, to compare or compete with the COMPUKNIT III... It is in a class of its own!! If you have any thoughts of trading up, there is no better time than now. The price of our first two shipments is guaranteed despite the continuing decline in the value of the Dollar against the Yen and you will never be offered more for your knitter in trade than in our Introductory Offer... mailed to all U.S. subscribers under separate cover. The COMPUKNIT III will add new excitement and tremendously increase versatility plus simplicity to machine knitting. We are already producing some beautiful KNITKING MAGAZINE patterns on our sample machine. Be sure to watch out for them.

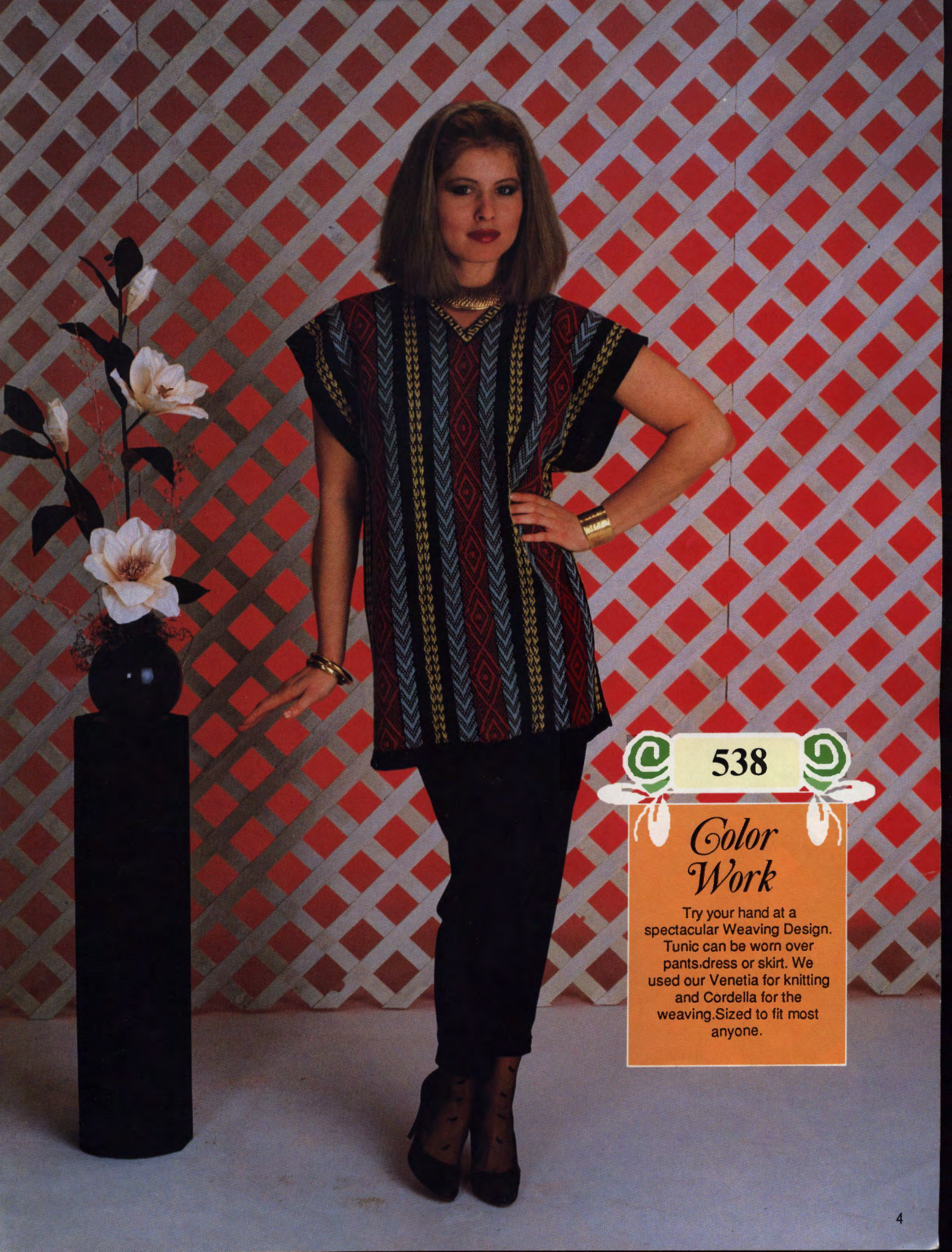

538

Color Work

Try your hand at a spectacular Weaving Design. Tunic can be worn over pants, dress or skirt. We used our Venetia for knitting and Cordella for the weaving. Sized to fit most anyone.



521



Large is Lovely

Large Designs on Sweaters
are definitely top fashion
and you knit this striking
Intarsia Design on any
standard bulky machine. Use
our bulky Venetia, Angora
and small amount of
Capriccio.
One size fits all.





528

Innovation

Something new, something different that only a Garter Carriage can produce.

Different patterns abound, set off with textured yarn for the stripes plus cables located here and there. Use bulky Venetia with a nubby tweed.

Sizes 4 to 14.

536

Sensuous

Flattering to a pretty figure, you can wear this dress to any special affair. It is a diamond lace Design on bodice and sleeves. Venetia is the yarn.



537

Aristocratic

An elegant Vest adds glamour to a simple dress. It's in a Fair Isle Design using Venetia and sparkling Mami Rex. The edge trim is Lace.





524



Dramatic

Any bulky machine can be used to knit this striking Sweater with Intarsia Design. The bands are 1X1 ribbing. Use our bulky Venetia yarn with Angora. Sizes 8 to 14.



527

Westward Ho!

A two-piece Suit is a great addition to any fashionable wardrobe. The Skirt is knitted on main machine with ribber.

The Jacket can be made on any Electronic machine. Flowers and Birds are a Fair Isle Design with Angora as the contrast color. Trim at top of ribbing on sleeves and small stripes that outline the birds is Angora.

Sizes 8 to 14.





525



Flawless

Turn on your Garter Carriage and go out for lunch. A beautiful Sweater will practically knit itself. Bulky Venetia knits on standard or electronic machine at Tension 10. Even the 1X1 ribbing is made using the fantastic Garter Carriage.
Sizes Small, Medium and Large.

General Instructions

THE PRINTED INSTRUCTIONS

Follow the printed instructions or use them in combination with the Charts. Where there is any question in the instructions, you have the Charts to show you how the section will look.

Be sure to READ AHEAD so that you KNOW what to do for the size you are knitting. In the shapings, where the number of stitches are the same but the number of times different, you might find shapings like this...3 sts. 1 x (2x) [3x]—so that for the first size you will bind off 3 sts. 1x, 2nd size 3 sts. 2x, 3rd size 3 sts. 3x. Sometimes the ROWS will be different for each size—so you must watch out for different row numbers.

Shoulder and neck shapings for the back section of a garment usually are shaped at the same time—so ALWAYS WATCH for the words AT THE SAME TIME.

HOLDING STITCHES ON THE LEFT SIDE WHILE SHAPING THE RIGHT SIDE

There are different ways to hold stitches on one side while completing the other side. Usually, we tell you to bind off the center sts. for neck and put the left side into holding position while completing the right side. The easiest way and really the best way for beginners is to take a piece of RAVEL CORD and hand knit the center neck stitches, pulling them back against the needle bed of machine to the "A" or out of work position. The stitches remain in the HOOKS of the needles so you are really only knitting them HALF WAY. With another color of Ravel Cord, knit the remaining sts. on the left side in the SAME WAY.

It is important to protect these held stitches in some way—so you can either hang a REVERSING BAR so that the EYES of the Bar go BETWEEN the Gate Pegs on the machine and that the UPPER TIPS of Bar only—show above the needle bed...OR the simplest way is to use a piece of 1 inch masking tape and GENTLY place it beneath the knitting—right below the gate pegs. Do NOT press the tape—only enough pressure to hold it in place. This will prevent the Carriage (or Slide) from marking the held section.

It is VERY IMPORTANT that you mark the PATTERN ROW where you divide for the split for NECK (or SHOULDER) shaping....If you are using a PUNCH CARD—MARK THE CARD—if you are using an ELECTRONIC machine, MARK THE DESIGN WINDOW. Also take note of the Row number for the division. When you are ready to work the left section, bring the HELD stitches back to B (working) position by pulling each end of the Ravel Cord GENTLY and rip it off—be sure to align all needles straight in the B or knitting position.

Now you are ready to REFER TO YOUR OWN INSTRUCTION MANUAL for your machine—to set the controls to begin knitting the left half. The neck stitches can be bound off after completing the right side or you can leave them in hold until each side is finished, then bind them off or remove them onto contrast waste yarn ready to be picked up for knitting a neckband or for other finishing.

FULL FASHION DECREASING OR INCREASING

For Stockinette stitch, use the Full Fashion method for decreasing or increasing (except for regular cap shaping on sleeves where you decrease the edge stitch).

TO DECREASE: Hang the 3rd stitch onto the 2nd stitch then move the end stitches in to fill the empty needle.

TO INCREASE: Move the 2nd end stitches 1 needle outward, then pick up the 3rd stitch from the row below and hang it onto empty needle.

PATTERN SYMBOLS (Code for Symbols on page 13.)

() Symbol for 2nd size.

[] Symbol for 3rd size.

There are up to 3 sizes given for Patterns in KNITTING MAGAZINE. For example, the Charts and printed instructions will show the cast-on as...124—First size. (132)—Second size. [140]—Third size.

R= ROW

Needles in holding position.

Needles back into working position.

For Short Row Knitting

THE SAMPLE SWATCH

Before you knit any garment, you must knit a sample swatch using the yarn you have chosen for your garment. If you do not get the correct Stitch and Row Gauge as given for a Pattern in KNITTING MAGAZINE—try different tensions. If you are using the specified yarn, you should be able to get the correct gauge using a smaller or larger tension. If you are using a different yarn, you may have to make several swatches—but the gauge is very important.

To make a sample swatch—Cast on 60 stitches with waste yarn and knit 6 rows. Mark the tension number for your sample swatch by making holes (you can do this with a Lace Carriage or by hand), 4 transfers for Tension 4, 6 transfers for Tension 6, etc. Knit 6 more rows.

Change to garment yarn and set Counter at 0. Knit 30 rows (in Stockinette stitch or Pattern stitch—according to the garment). With Contrast waste yarn knit the 10th stitch FROM EACH SIDE—by hand. Knit 30 rows. Change to waste yarn and knit 12 rows. Remove the sts. from the machine by pushing the Carriage (or Slide) across without yarn.

Pull and stretch the sample swatch both lengthwise and diagonally from corner to corner, then lengthwise again. Gently block the swatch (KNITTING PRESSING CLOTHS are great for this)—or you can allow the sample to rest several hours or even over night so that the stitches can return to their basic form.

THE KNITTING STITCH/ROW GAUGE and STITCH/ROW CALCULATOR can be used to find the NUMBER OF STITCHES or ROWS TO 1 INCH.

The KNITTING STITCH/ROW GAUGE will give you the NUMBER OF STITCHES or ROWS to 1 inch. After knitting a sample swatch by following our instructions, place the STITCH/ROW GAUGE horizontally with the START LINE on the INSIDE of LEFT stitch mark on sample.

Keep it straight then read the number on the Gauge directly below the inside RIGHT mark on Gauge. This will give you the STITCH GAUGE TO 1 INCH. For instance, if the number is 8, then you have 8 stitches to 1 INCH. To find the ROWS TO 1 INCH, measure from the first row of garment yarn, VERTICALLY to the last row. Read the NUMBER from the LOWER EDGE of GAUGE same as you did for stitches and if the number should be 14, you have 14 rows to 1 inch.

The STITCH/ROW CALCULATOR will now give you the number of sts. or rows needed for a specific measurement. Line the ARROW to the number 8 (8 sts. to 1 inch) and should you need 20 inches of stitches, find the number 20 below and right above the 20 the Calculator shows 160 sts. It works the same way for rows using the Row Gauge.

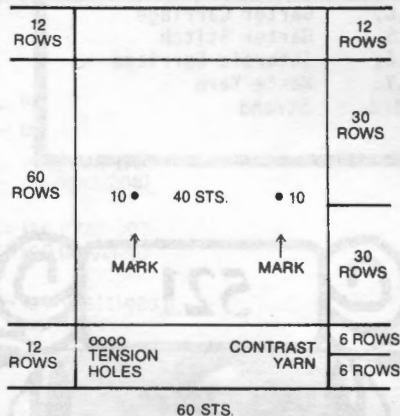

FINISHING

Gently block all sections—For PULLOVERS, JACKETS and DRESSES: Join the front to back at shoulders and sides. Sew sleeves together and set in. Hem lower edge and sleeve edges if needed. For a double neckband or armhole, band sew 1 edge to inside and 1 to the outside of neck or armhole. For a single ribbed band, sew 1 edge to the outside of neck or armhole edge. For a cardigan or jacket with buttonholes, finish buttonholes and sew on buttons.

PANTS: Join front to back at sides. Sew inside leg seams, then join to center front and back. Make hem at waistline and insert elastic. Hem lower edge of pants' legs.

Needle not used—in out of work position.

3x1

The number in the box is the number of Rows between shapings. The 3 x 1 above the box gives you the sts. and number of times to make the decreases (or increases)—FOR EXAMPLE: 3 x 1 over the box with 4 means—At the given Row number, *decrease 1 st. knit 4 rows* and REPEAT from * to * 2 times more for a total of 3 times in all. All decreasing (or increasing) WITHOUT ROW NUMBER IN BOX must be made on EVERY 2nd ROW.

CODE FOR SYMBOLS

| | |
|---------|--------------------|
| Carr. | Carriage |
| CO | Cast on |
| BO | Bind off |
| Col. | Color |
| Dec. | Decrease |
| Inc. | Increase |
| EON | Every Other Needle |
| EOR | Every Other Row |
| FNR | Full Needle Rib |
| HP | Holding Position |
| MB | Main Bed |
| RB | Ribber Bed |
| K | Knit |
| P | Purl |
| Pat. | Pattern |
| Ndls. | Needles |
| St. | Stitch |
| St. st. | Stockinette Stitch |
| T | Tension |
| WP | Working Position |
| L.C. | Lace Carriage |
| G.C. | Garter Carriage |
| G.S. | Garter Stitch |
| I.C. | Intarsia Carriage |
| W.Y. | Waste Yarn |
| Strd. | Strand |

BACK:

K1 P. Rib. Col. 1. Cast on 109 sts. Knit 30 Rows. Transfer Rib sts. to MB. Continue St. st. with Col. 1. Knit to Row 80. With 2 strds. Col. 3, knit 2 rows. With 1 strd. Col. 2 Angora, T-2, knit to Row 86. BEGIN INTARSIA DESIGN. Follow the Chart to Row 122. With 2 strds. Col. 3, knit 2 rows. Row 124, change to Col. 1. Knit to Row 204. Remove center 38 sts. onto W.Y. Remove right and left 36 shoulder sts. onto W.Y.

FRONT:

Same as back to Row 184. Bind off center 20 sts. put sts. on left into HP and complete right side first. *ON NECK SIDE, on every 2nd row, decrease 1 st. 9x. Remove onto W.Y. Bring Ndls. on left to WP, Row Counter back to 184 and complete left half. Follow Instructions from *.

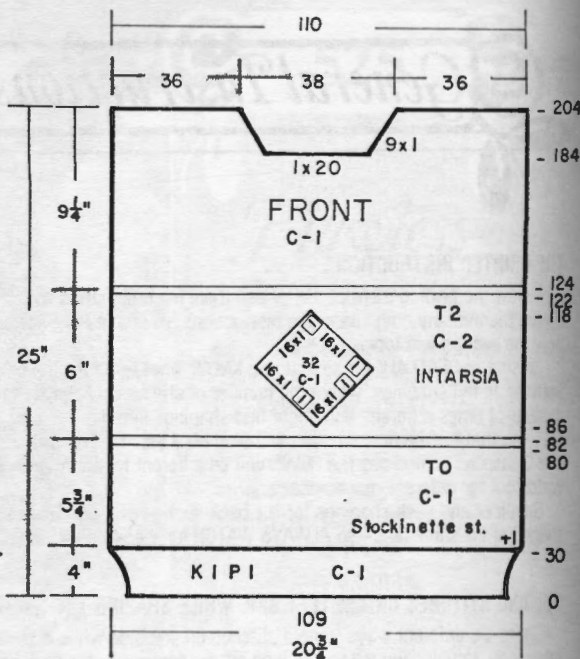

BODICE CHART HALF SIDE SHOWN

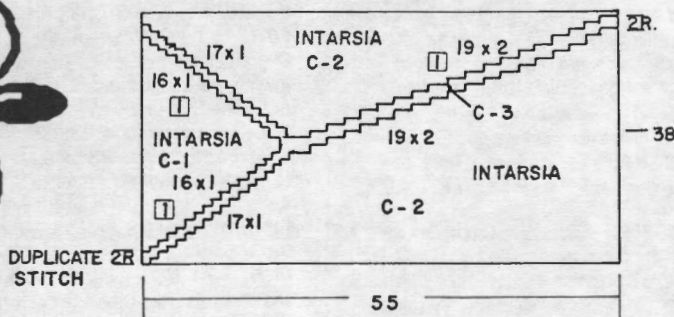

SLEEVES: Watch for Tension changes.

With W.Y. cast on 96 sts. After knitting several rows, end with 1 row Ravel Cord to the right side. Counter 0. Single strd Col. 1, knit to R 50. With 2 strds. Col. 3, knit 2 rows. With Col. 2 Angora, knit St. st. to R 56. Begin INTARSIA DESIGN and work as shown on the Chart to Row 88. Continue St. st. to R 92. With 2 strds. Col. 3, knit 2 rows. SHAPE CAP: Work Short Rows. ON OPPOSITE SIDE OF CARRIAGE, bring into HP 6 sts. 6x ON EACH SIDE. Bring all Ndls. OPPOSITE CARRIAGE back into working position before knitting next 2 rows. After R 112, remove onto waste yarn.

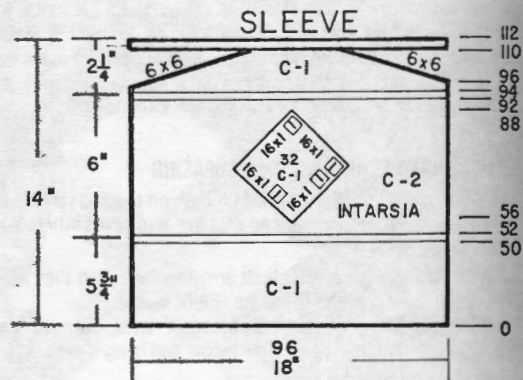

SLEEVE CHART HALF SIDE SHOWN

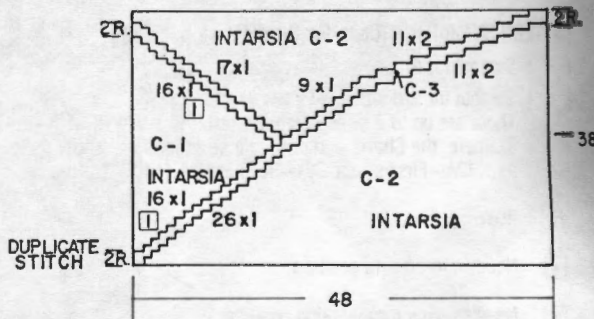

SLEEVE BANDS:

K1, P1 Rib. Col. 1. Cast on 41 sts. Knit 30 Rows. Transfer Rib sts. to MB. With wrong side facing, hang open sleeve sts. onto these Ndles, decreasing evenly across. Knit 1 Row over all sts. Bind off.

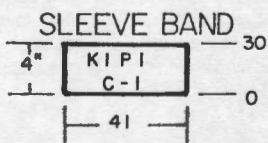

WOMENS PULLOVER

SIZES: One Size fits all.
 YARN: Bulky Venetia = Col. 1
 Angora = Col. 2
 Capriccio = Col. 3
 Angora = Col. 4
 AMOUNT:
 Col. 1 1 1/2 lbs.
 Col. 2 10 Balls
 Col. 3 1 Ball
 Col. 4 2 Balls
 TENSION: 0 Rib. 0/0 II
 Intarsia with Angora T-2
 GAUGE: 10.5 sts. 17 Rows = 2" (5 cm)

Make on any Bulky Machine with Ribber. Intarsia method for Diamond Design. Outline in Duplicate Stitch.

NECKBAND NO. 1. Make 1.

With Color 1, 'e' cast on 90 sts. Knit 20 Rows St. st. Bind off.

NECK BAND

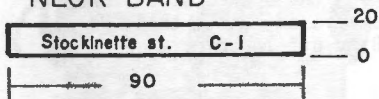

NECK BAND No. 2. Make 1.

With Color 1, 'e' cast on 100 sts. Work St. st. Knit 2 rows, change to Col. 2 and knit 10 rows. Change to Col. 1, knit 10 rows. Bind off.

NECK BAND

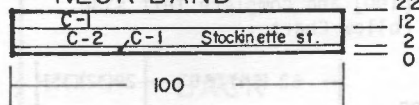

FINISHING:

Close both shoulders. Take Col. 1 Neckband and weave narrow ends together forming a circle. Attach to neck edge (Purl side showing) and allow it to roll naturally to front. (Roll should be thick and approximately 1" wide). Stitch into place.

Attach Col 2 Neckband in same manner taking care to see that only the Angora shows (Col. 1 is inside roll). Stitch into place. (See Photo).

With Col. 4, work DUPLICATE STITCH. Follow the Chart and outline Diamond Design on Front, Back and Sleeves and the angled lines. (See Photo). Close side and sleeve seams.

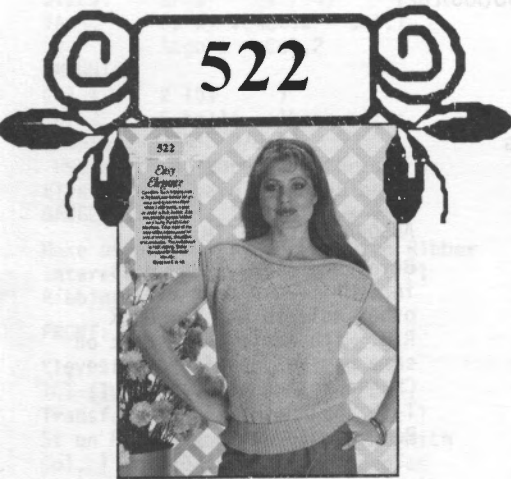

WOMENS SLEEVELESS PULLOVER

SIZES: 6/8 (10/12) [14/16]

YARN: Bulky Venetia = Col. 1
Rainbow Metallic = Col. 2

AMOUNT:
Col. 1 1 1/2 lbs. for all sizes.
Col. 2 2 spools for all sizes.

TENSION: Tuck St. 3, Rib. 0/0 II
GAUGE: 8 1/2 sts. 19 Rows = 2" (5 cm)

Make on any Punch Card Bulky machine. Main section is Tuck St. Use Card No. 2 from original set for KNITTING KH 260. Upper Bodice is Thread Lace. Punch Card. Bands are K1, P1 Ribbing. Knit side is the right side

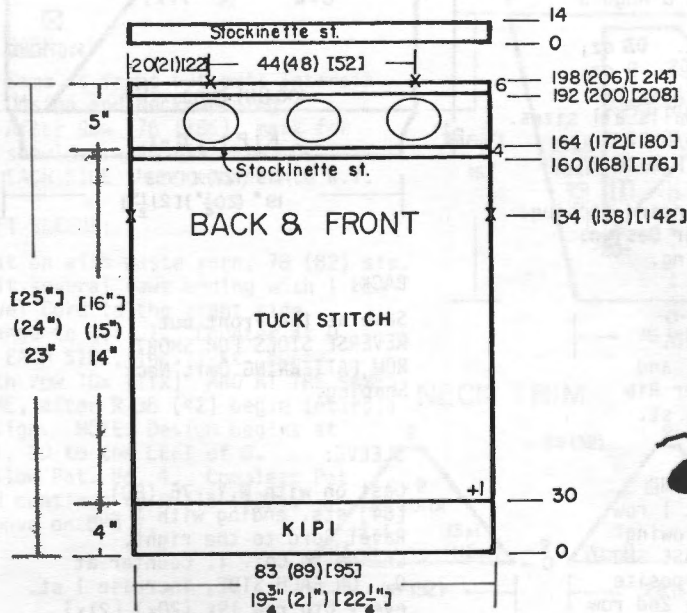

FRONT/BACK: The same.

K1, P1 Rib. With color 1, cast on 83 (89) [95] sts. Knit 30 rows. Transfer Rib sts. to MB and continue in TUCK PAT. to R 134 (138) [142]. Mark each side for arm opening. Continue in Pat. to R 160 (168) [176]. Cancel Tuck Pat. Knit 3 rows St. st. SET THREAD LACE PAT. LEFT TO RIGHT and with DOUBLE STRANDS Col. 2 in B Feeder, knit in Pat. to R 192 (200) [208]. Cancel Thread Lace and continue in St. st. T 2 to Row 198 (206) [214]. Mark each side for Neck opening (see Chart) then remove onto W.Y.

NECK AND SHOULDER TRIM:

With KNIT SIDE facing, hang the open sts. of Front back onto machine. With color 1 and T 2. Knit 14 rows. Bind off. REPEAT FOR BACK.

SLEEVE BAND MAKE 2

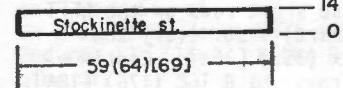

SLEEVE BANDS: Close shoulders first.

Bring 59 (64) [69] Ndl. into WP. With knit side facing, pick up sts. along arm opening from marker to marker and hang onto these Ndl. With Col. 1, T 2, knit 14 rows. Bind off LOOSELY. REPEAT for other arm opening.

FINISHING:

Close side seams. Join Sleeve Curl to Shoulder Curl. DO NOT PRESS WITH IRON OR STEAM. USE WET BLOCKING METHOD. See Practical Knitting Hints, this issue.



523

Bind off the center 42 (44) [46] sts. Leave the left side in HP and complete right side first. ON NECK SIDE, dec. 1 st. EOR 10x. After Row 192 (202) [212], remove onto waste yarn. Turn Counter back to 170 (180) [190] and complete left side. Follow Chart .

SLEEVE CUFF:

K1, P1 Rib. Col. 2. Cast on 51 (57) [63] sts. Knit to Row 26. Transfer Rib sts. to MB. Hang the open sts. of lower sleeve edge onto these Ndl's. Bind off loosely.

WOMENS PULLOVER

SIZES: 6/8 (10/12) [14]
 YARN: BULKY Venetia & Angora
 AMOUNT:
 Col. 1 15 oz. 16 oz. 17 oz.
 Col. 2 7 oz. 8 oz. 9 oz.
 Col. 3 2 oz. all sizes.
 Col. 4 Angora - 3 balls all sizes.
 TENSION: 10 Rib. 6/6 II
 GAUGE: 12 1/2 sts. 18 Rows = 2"

Can be made on any standard machine. Short Rows are used for Design. Bands are K1, P1 Ribbing.

FRONT:

With Col. 1, K1, P1 Rib. Cast on 119 (127) sts. and knit 26 rows. Transfer Rib sts. to MB. Increase 1 st. on the right. ON THE RIGHT SIDE, put 14 (17) [20] sts. into HP Attach Col. 2 and knit 1 row to the left side. Following the Chart, work DECREASE SHORT ROWS. Put 1 needle opposite Carriage into HP every 2nd row and BE SURE TO WRAP inside needle in HP (or you can use automatic wrap if you know how). After R 100 (106) [112] begin decrease short rows on the LEFT (see Chart) 1 st. every 2nd row 34x (35x) [36x]. Continue short rows to R 168 (176) [184]. All Ndl's. in HP. Turn Counter back to 100 (106) [112]. Carriage on the LEFT. With Col. 3 Work INCREASE SHORT ROWS. Push back into WP 1 st. every 2nd row 34x (35x) [36x]. After Row 169 (177) [185] work decrease short rows, 1 st. to HP 12x (13x) [14x]. After Row 192 (202) [212], Put these sts. into holding position. Turn Counter back to 26, and Carriage on the Right side. Bring the 14 (17) [20] sts. on right into WP. With Col. 1, work INCREASE SHORT ROWS, Bring back into working position 1 st. every 2nd row 83x (88x) [93x]. After Row 170 (180) [190], SHAPE NECK:

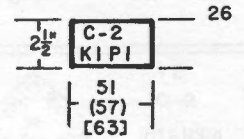
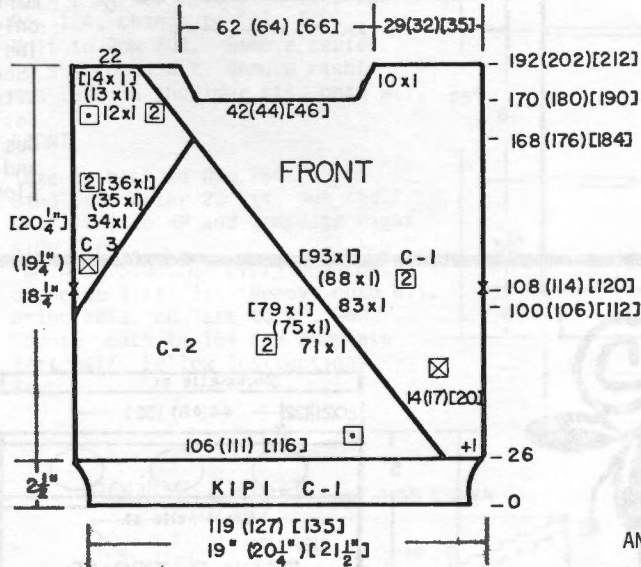

BACK:

Same as the Front but REVERSE SIDES FOR SHORT ROW PATTERNING. Omit Neck Shaping.

SLEEVE:

Cast on with W.Y. 76 (80) [84] sts. ending with 1 row Ravel Cord to the right. Change to Col. 1. Counter at 0. ON EACH SIDE, increase 1 st. every 6th row 19x (20x) [21x]. Knit to R 130 (134) [138]. SHAPE CAP: ON OPPOSITE SIDE OF CARRIAGE, bring into HP 10 sts. 4x ON EACH SIDE. After R 138 (142) [146], knit 2 rows over all sts. Remove on W.Y.

ANGORA SLEEVE TRIM:

Bring 180 (188) [196] Ndl's. into WP. Push back every other Ndle to NWP for MOCK RIB. With waste yarn, cast on same way as you did for sleeve. Change to Angora (Col 4) T-10 and knit 20 Rows. Remove onto waste yarn.

ANGORA SLEEVE TRIM

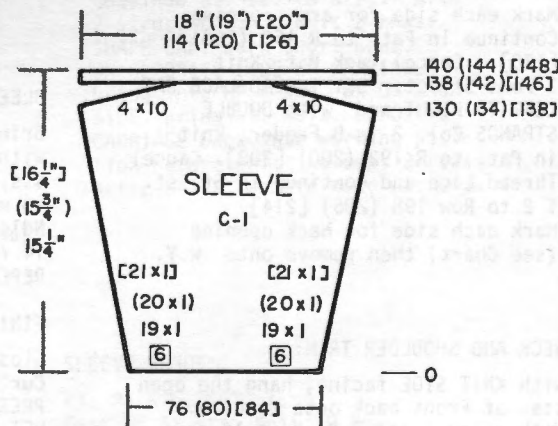
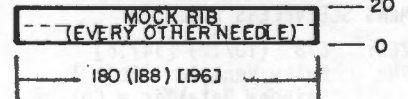

FINISHING:

Close both shoulders. Bring into WP 114 (120) [126] Ndl's. With right side (knit) facing, using markers as guides, hang front/back sleeve opening onto these Ndl's. Pick up open sts. of Angora Trim from last row knitted and hang onto same Ndl's. Fold Angora Trim in half (as in making a hem) and hang first row of open sts. onto same Ndl's. With wrong side facing, hang open sts. of sleeve top on same Ndl's, knit 1 row over ALL STS. WITH LOOSE TENSION then bind off LOOSELY. NECK OPENING: With color 1 work 1 row slip st. crochet around neck then 1 row single crochet with Angora. Close sleeve and side seams.

524



WOMENS INTARSIA PULLOVER

SIZES: 8/10 (12/14)
YARN: Bulky Venetia = Col.1
 Angora = Col.2

AMOUNT:
 Col.1 2 lbs }
 Col.2 6 balls } both sizes
TENSION: 3 Rib 0/0 II

Use matching thread or thread elastic with yarn for Ribbing.
GAUGE: 10 Sts. 14 1/2 Rows=2"

Make on any Bulky Machine with Ribber Intarsia Method. Bands are K1, P1 Ribbing.

FRONT:

K1, P1 Rib. Col. 1. Cast on 101 (107) sts. and knit 24 rows. Transfer Rib sts to MB and inc. 1 St on Right. Continue in St St with Col. 1 to R50 (58). Bring needles to Intarsia Position then begin the Intarsia Pattern No.1. On Right Side at Nd1. No. 30, Knit 2 rows with Col. 2 over 1 Nd1. then ON EACH SIDE, inc. 1 St in Pat. 19x, but AT THE SAME TIME, AFTER Row 76 (84), begin Pat. No. 2. Note that Pat. ends 4(7) sts. from left side. Follow the decreases as shown on Chart. After Row 108 (112) mark each side for setting in sleeves. At Row 114 (122) begin Pat. 3. and AT THE SAME TIME, after Row 142 (146) divide for neck. Knit the left half with a Ravel Cord back to "A" (Non Working Position) and continue the right side. ON NECK SIDE decrease 1 st every 2nd row 18x (20x). After Row 178 (186) Remove the remaining sts onto W.Y. Bring the sts. on left into WP and carefully remove the Ravel Cord. Turn Counter back to 154 (162). ON NECK SIDE, decrease 1 St. every 4th row 8x (10x). After Row 178 (186), remove onto W.Y.

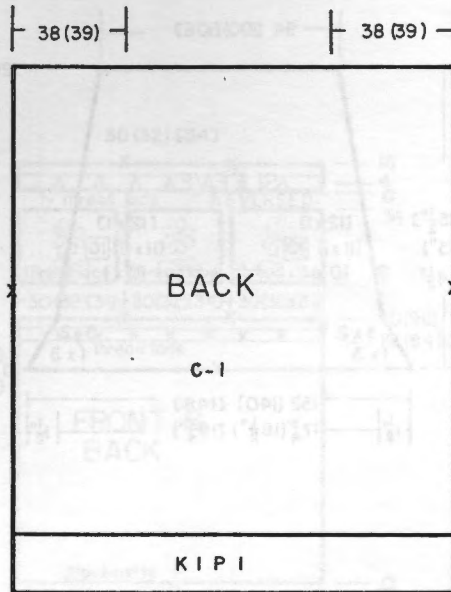

BACK:

Same as front but omit Intarsia Design and Neck opening. After Row 178 (186), mark for shoulder - 38 (39) sts. ON EACH SIDE then remove onto W.Y.

LEFT SLEEVE:

Cast on with waste yarn, 78 (82) sts. Knit several rows ending with 1 row Ravel Cord to the right side. Change to Col. 1. Counter at 0. ON EACH SIDE, inc. 1 st. every 10th row 10x (11x) AND AT THE SAME TIME, after R 38 (42) begin Intarsia Design. NOTE: Design begins at Nd1. 20 to the LEFT of 0. Follow Pat. No. 4. Complete Pat and continue to R 118 (122). Remove onto W.Y.

RIGHT SLEEVE:

Same as left sleeve, but follow Pat. No. 5. Complete and remove Onto W.Y.

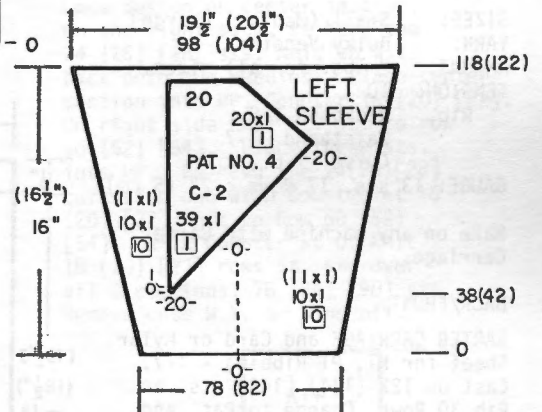
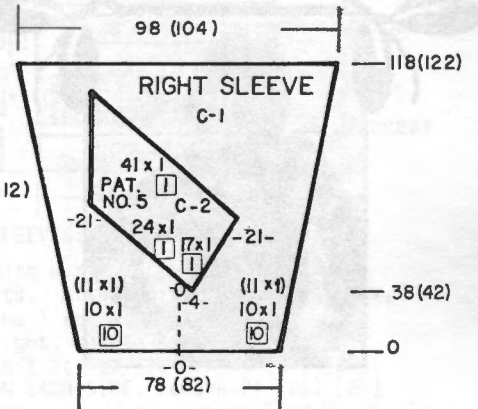

NECK TRIM

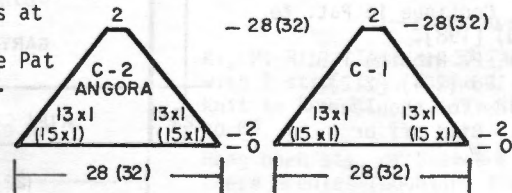

NECK TRIM: Make 1 Col. 1, 1 Col. 2.

Cast on 28 (32) sts. using 'e' cast on. Work St. st. ON EACH SIDE, decrease 1 st. every 2nd row 13x (15x). After R 28 (32) bind off. Sew 2 sides together with right side inside. Turn to the right side and attach. See Photo.

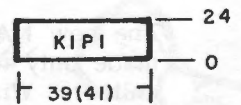
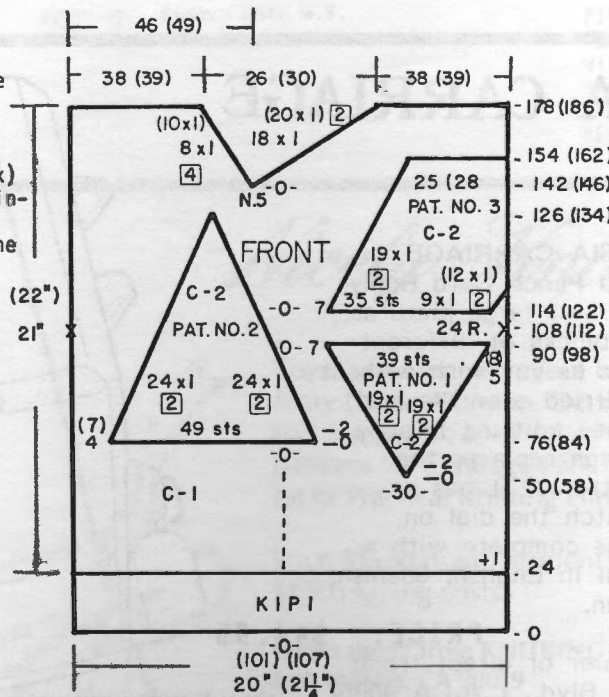

CUFFS:

K1; P1 Rib. Col. 1. Cast on 39 (41) sts. Knit 24 rows. Transfer Rib sts. to MB. With wrong side facing, pick up the open sts. from lower sleeve edge and hang onto these Nd1s. doubling every 2nd st. Bind off.

FINISHING: See General Instructions. Single Crochet around Neck opening.



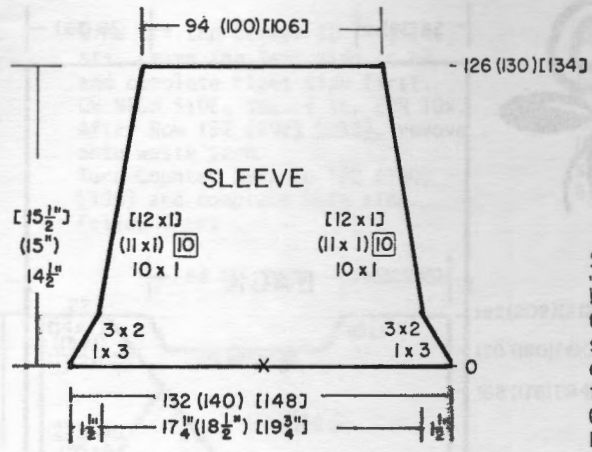

SLEEVES:
 With waste yarn and standard Carriage, cast on 132 (140) [148] sts. Knit several rows St. st. ending with 1 row with Ravel Cord to the right side..
 Change to G.C. and continue in Pat. Knit 2 rows then begin decreases. ON EACH SIDE, bind off 3 sts. 1x, 2 sts. 3x, 1 st. every 10th row 10x (11x) [12x]. After Row 126 (130) [134], remove onto W.Y.

WOMENS PULLOVER

SIZES: Small (Medium) [Large]
YARN: Bulky Venetia
AMOUNT: 2 lbs. for all sizes.
TENSION: 10
 Rib. Neckband T-8
 Waistband T-7
 Cuffs T-6.2

GAUGE: 13 sts. 17 Rows = 2" (5 cm)

Make on any machine with Garter Carriage.

BACK/FRONT:

GARTER CARRIAGE and Card or Mylar Sheet for K1, P1 Ribbing - T-7. Cast on 122 (134) [146] sts. and Rib 30 Rows. Change to Pat. and T-10.. Knit to Row 108 (112) [116]. Mark each side for setting in sleeves. Continue in Pat. to Row 182 (190) [198]. Change to K1, P1 Ribbing T-8. Knit to Row 196 (204) [212]. Mark each side for shoulders (See Chart). Bind off or remove onto W.Y.

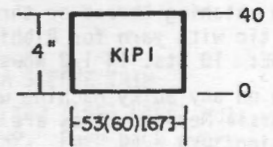
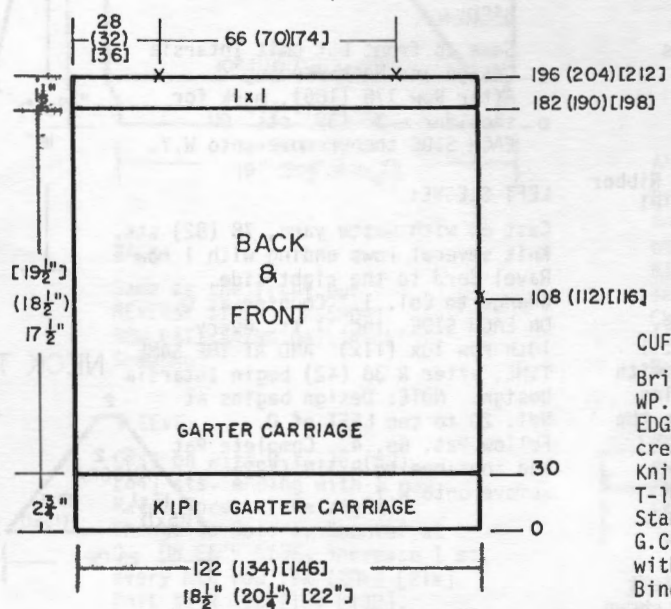

CUFFS:

Bring 53 (60) [67] Ndl. to WP. the open sts. of SHORT EDGE onto these needles, decreasing evenly across. Knit 1 row Stockinette st. with T-10 from right to left with Standard Carr. Change to G.C. and K1, P1 Ribbing with T-6.2 and knit 40 rows. Bind off.

FINISHING: See General Instructions.

INTARSIA CARRIAGE KA 2600

The new KA 2600 INTARSIA CARRIAGE is made only for the KH 260 Punch Card Bulky knitter. With it, you can knit large pictures, argyle designs or random blocks of different textures in as many colors as you wish without strands of yarn (floats) carried over the purl side of your knitting. When knitting Intarsia designs, the Intarsia Carriage replaces the main carriage of your knitter. It has a tension control dial to match the dial on your machine and it comes complete with a detailed instruction manual in English, Spanish, German, French and Italian.

PRICE: \$44.95

Order from your local dealer or direct from:
KNITKING, 1128 Crenshaw Blvd., L.A.CA 90019

(plus \$2.50 shipping costs)

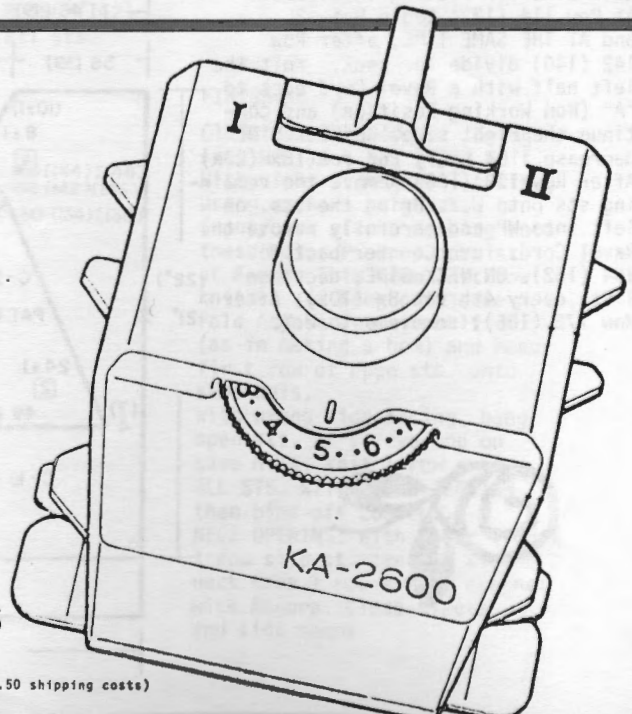

526

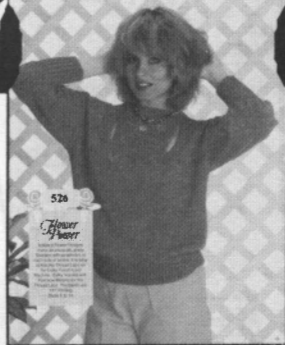

WOMENS PULLOVER

SIZES: 6/8 (10/12) [14]
 YARN: Bulky Venetia = Col. 1
 Metallic Rainbow = Col. 2

AMOUNT:
 Col. 1 20 oz 24 oz. 28 oz.
 Col. 2 2 Spools all sizes.
 TENSION: 3 K1, P1 Rib 0/0 II
 GAUGE: 9 1/2 sts. 14 Rows = 2" (5 cm)

Made on 260 BULKY Machine with isolated Thread Lace Design. Use 1 strd. Color 1, 1 Strd. Color 2 unless otherwise stated. Punch Cards.

FRONT/BACK: The same.

K1, P1 Rib. Cpl. 1. Cast on 81 (87) [93] sts. Knit to Row 22. Transfer Rib sts. to MB. Remove onto W.Y.
 Bring 90 (96) [102] Ndl's. to WP. Hang the sts. held on W.Y. onto these Ndl's. increasing evenly across. (Pick up st. from row below to fill empty needles).
 Counter 0. Knit St. st. to Row 77 (83) [89].
 Insert Card No. 1 and set Pat. LEFT TO RIGHT on next Row.
 Use 2 strands of Col. 2 in FEEDER B and work 1 Pat.
 Continue in St. st. to Row 90 (96) [102].

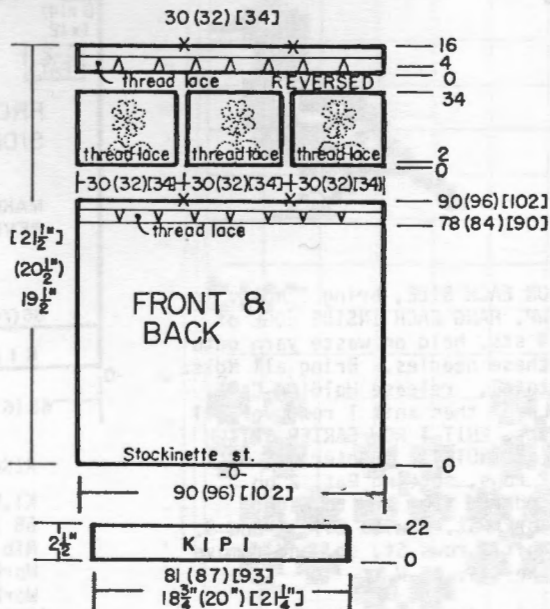

Divide into 3 sections. Mark Needle Bed and remove each section separately onto W.Y. Each section will be knitted separately. ISOLATED THREAD LACE DESIGN. *Re-hang one section back onto machine 30 (32) [34] sts. Knit 1 row to the left. Insert Card No. 2. Set Motif Cams in place. Set Pat. next Row to the Right. 2 strands col. 2 in Feeder B. Knit to Row 34. Remove onto W.Y. REPEAT FROM * for other 2 sections.

TOP SECTION:

Bring 90 (96) [102] Ndl's. into WP. Re-hang the 3 sections just completed onto these Ndl's. Knit 3 rows St. st. REVERSE CARD NO. 1 and SET PAT. Knit 1 row to the right. Knit to Row 16. Mark for Neck opening. Remove onto W.Y.

SLEEVE

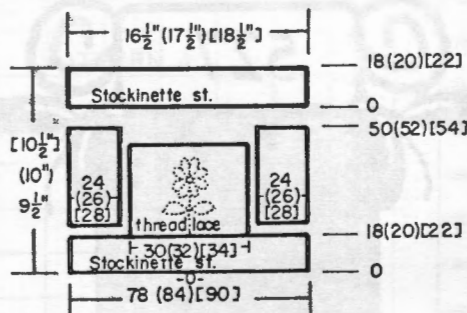

SLEEVES:

With W.Y. cast on 78 (84) [90] sts. After knitting several rows, and 1 row with Ravel Cord to the right, change to Main Yarn. Knit St. st. to Row 18 (20) [22]. ON EACH SIDE, remove 24 (26) [28] sts. onto W.Y. Using Card No. 2, knit 32 rows of Isolated Thread Lace design on center section. On the right side, re-hang the 24 (26) [28] sts. held on W.Y. back onto the needles. Place center section into HP. Counter 18 (20) [22]. On right side knit St. st. to row 50 (52) [54]. Place these sts. into HP. Re-hang the 24(26)[28] [left side and with Counter at 18 (20) [22] knit to Row 50 (52) [54]. With Counter at 0, knit 18 (20) [22] rows St. st. over all 3 sections. 78 (84) [90] sts. Remove onto W.Y. or bind off.

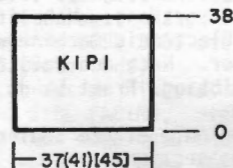

K1, P1 Rib. Cast on 37 (41) [45] sts. with 1 strd. Col. 1 and 1 strd. Col. 2. Knit to Row 38. Transfer Rib sts. to MB.

Hang open sts. of Sleeve onto these needles (doubling the sts. as needed). Knit 1 row across all sts. Bind off LOOSELY.

FINISHING: See General Instructions. Neck Opening, Design Slits. With 2 strds Col. 1, 1 strd Col. 2 and using No. 5 Crochet Hook, work 1 row single crochet and 1 row REVERSE single crochet.

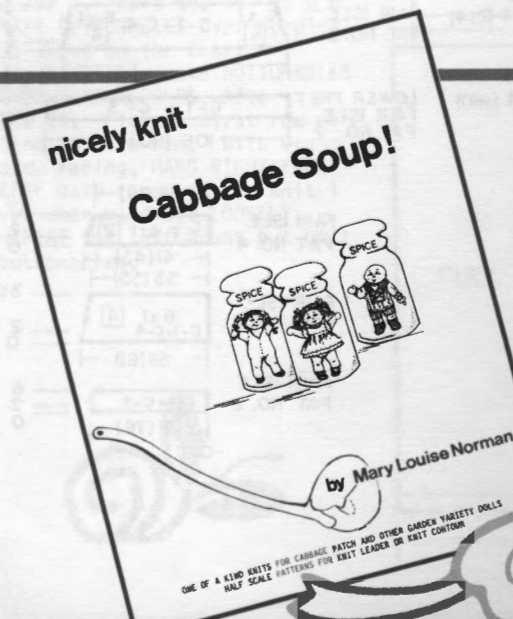

Nicely Knit Lines

There's another excellent book from the pen of Mary Louise Norman. Dedicated to "The knitters of the world who love dolls," it contains 33 garment patterns for Cabbage Patch and other Dolls plus a lot of Practical Knitting Hints...

Price \$15.50 (Calif. residents add Sales Tax) plus \$1.50 mailing costs.

Order direct from KNITKING—1128 Crenshaw Blvd., Los Angeles, CA 90019



WOMENS SKIRT AND CARDIGAN

SIZES: 8/10 (12/14)
YARN: Venetia = Col. 1
 Angora = Col. 2, 3, 4.

AMOUNT:
 Col. 1 3 lbs. all sizes.
 Col. 2, 3, 1 ball each
 Col. 4 2 balls

TENSION: Jacket T 10 Rib 4/4 I Skirt, See Chart.

GAUGE: 13 1/2 sts. 20 rows = 2" (5 cm)

Use 2 Strands Yarn for Cardigan. 1 strand yarn for Skirt.
 Stockinette st. with Fair Isle Designs. Design is isolated on front sections. Make it on any Electronic machine with Ribber. Neck and Waistband K1, P1 Ribbing. Front bands St. st.

IMPORTANT: At the beginning of Yoke sections, you must make 1 row GARTER STITCH. You can use Garter Bar and REVERSE the knitting, knit 1 row, then reverse again and continue instructions, OR you can change this row from PURL ST. facing to a KNIT STITCH using Latch Tool, OR use KG 88 GARTER CARRIAGE to make a KNIT ROW in PLACE of a PURL ROW.

CARDIGAN BACK:

K1, P1 Rib. Col. 1. Cast on 129 (137) sts. Knit 30 rows. Transfer Rib sts. to MB. Inc. 1 st. on right. Continue in St. st. After Row 154 (160), SHAPE ARMHOLE: ON EACH SIDE, bind off 6 (7) sts. 1x, 4 (5) sts. 1x, 2 sts. 1x, 1 st. 4x. After Row 204 (214) begin SHORT ROWS for YOKE SHAPING. Bring center 26 (30) sts. to HP and also the 36 sts. on the left. (Be sure to ALWAYS wrap inside needle when working Short Rows). Knit 2 rows.*Bring to HP 2 sts. 16x. 4 sts. remain. Knit 8 rows over the 4 sts. Remove on W.Y.* Bring 36 sts. on left into WP. Leave the center neck sts. in HP. Knit 1 row to left, Turn Counter to 204,(214) and Complete the left half. Follow instructions from * to *.

ON EACH SIDE, bring 8 Ndl. to WP. HANG EACH INSIDE EDGE of 4 sts. held on waste yarn onto these needles. Bring all Ndl. to HP, release Holding Cam Lever then knit 1 row over all sts. KNIT 1 ROW GARTER STITCH (SEE NOTE). Counter 0. Knit 2 rows, setting Pat. 2 on 2nd row from Left to Right. Work Pat. 2 with Col. 1 and 3. Knit 2 rows St. st. and remove the sts. on W.Y.

Bring into WP 90 (94) Ndl. Pick up sts. held on W.Y. onto these Ndl. DECREASING EVENLY ACROSS. Counter 0. With Col. 1, knit 2 rows, setting Pat. 3 on 2nd row from LEFT TO RIGHT. Work Pat. 3 with Col. 1 and 4 BUT AT THE SAME TIME, ON EACH SIDE, decrease 1 st. every 4th row 6x. When Pat. is completed, knit 2 rows St. st. with Col. 1. Remove on W.Y. Bring into WP 62 (66) Ndl. Pick up sts. held on W.Y. onto these Ndl. DECREASING EVENLY ACROSS. With Col. 1, knit 2 rows St. st. setting Pat. 4 on 2nd row from LEFT TO RIGHT. Work Pat. 4 with Col. 1 and 3. AT THE SAME TIME, ON EACH SIDE, decrease 1 st. every 2nd row, 4x. When Pat. is completed, Knit 2 rows St. st. with Col. 1. Remove onto W.Y.

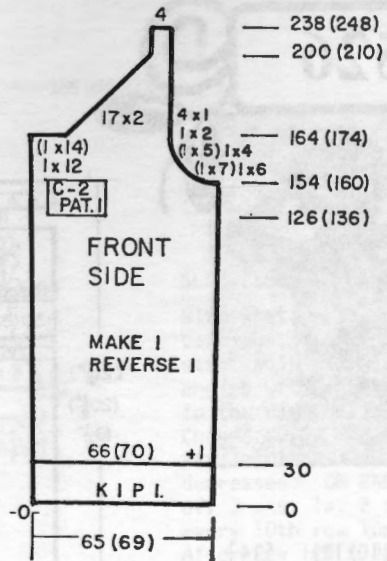

RIGHT FRONT: Make 1, reverse 1.

K1,P1. Rib. Col. 1. Cast on RIGHT of 0. 65 (69) sts. Knit 30 rows. Transfer Rib sts. to MB. Inc. 1 st. on right. Work same as back to Row 126 (136). Work isolated Pat. 1 with COL. 1 and 2. (SEE CHART). AT THE SAME TIME, after Row 154 (160) SHAPE ARMHOLE same as back. After Row 164 (174)SHAPE NECK. ON OPPOSITE SIDE OF CARR, bring into HP, 12 (14) Ndl. (wrap Yarn) Continue working Short Rows - 2 sts. 17x. After Row 200 (210) 4 sts. remain. Knit 38 rows over these 4 sts. Remove on W.Y. All needles in HP. ON THE RIGHT, bring into WP, 28 Ndl. Hang INSIDE EDGE of last 38 rows onto these Ndl. Bring all Ndl to HP. Knit 1 row St. st. over ALL Ndl. Make 1 row GARTER STITCH same as you did for back. Counter 0. FOLLOW THE PAT. SEQUENCE same as you did for the back, NOTING THE DIFFERENCE in the NUMBER OF STS. AND WORKING THE DECREASES ON RIGHT SIDE ONLY (SEE CHART)

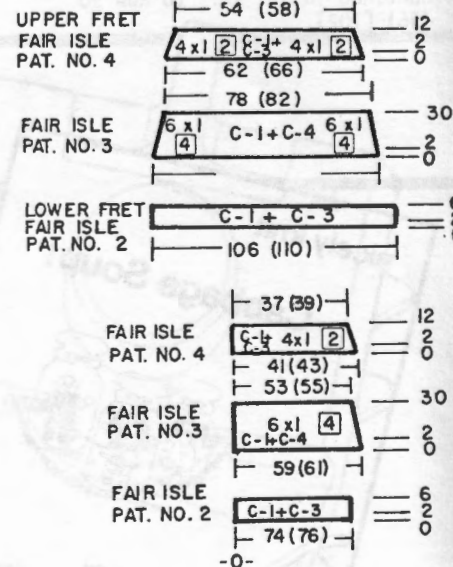
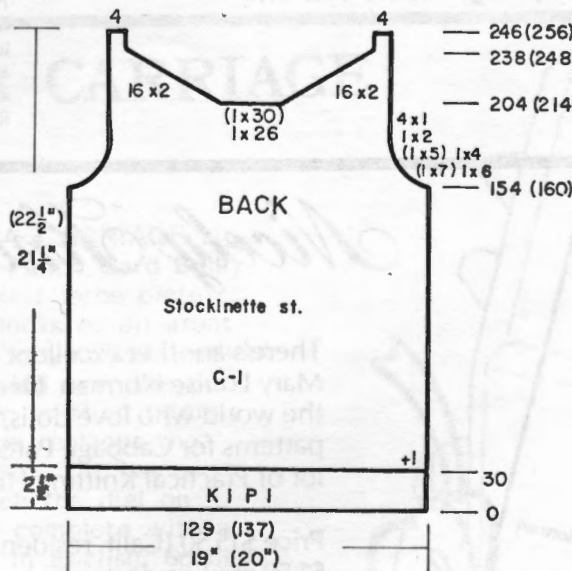

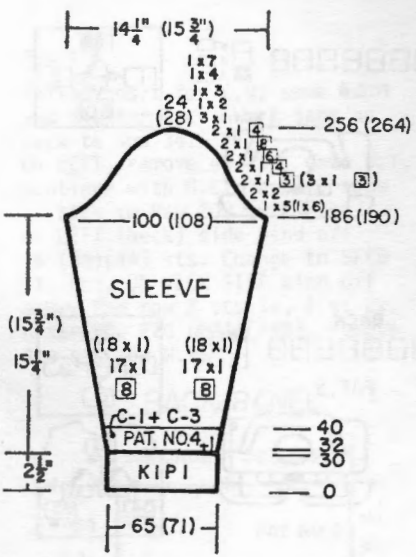

SLEEVES:
 K1, P1 Rib. Col. 1
 Cast on 65 (71) sts.
 30 rows. Transfer Rib sts.
 to MB. Add 1 st. on right.
 Knit 2 rows St. st. with
 Col. 1, setting Pat. 4 on
 2nd row. With Col. 1 and 3,
 Knit in Pat. to Row 40.
 Continue St. st. with Col. 1
 AND AT THE SAME TIME ON EACH
 SIDE, increase 1 st. every
 8th row 17x (18x).
 After Row 186 (190), SHAPE
 CAP: Please follow the
 Chart for Cap shaping as
 shown on Chart for your size.
 After Row 256 (264), bind
 off remaining sts.

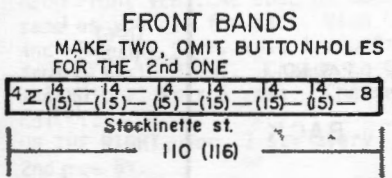

FRONT BANDS:
 OPEN CAST ON 110 (116) sts. with
 W.Y. After several rows end
 with 1 row Ravel Cord to the
 Right. Counter 0, change to
 color 1. Work St. st. to R 6.
 MAKE BUTTONHOLES over needles
 as shown on the Chart.
 After Row 14, make BUTTONHOLES
 OVER SAME NEEDLES. After
 Row 20. Pick up first row of
 band to form hem. With wrong
 side facing, HANG RIGHT FRONT
 EDGE onto these Ndl's. Knit 1
 row then bind off LOOSELY.
 REPEAT for left front but omit
 buttonholes.

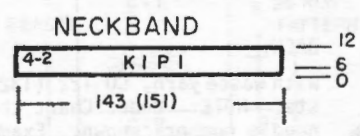
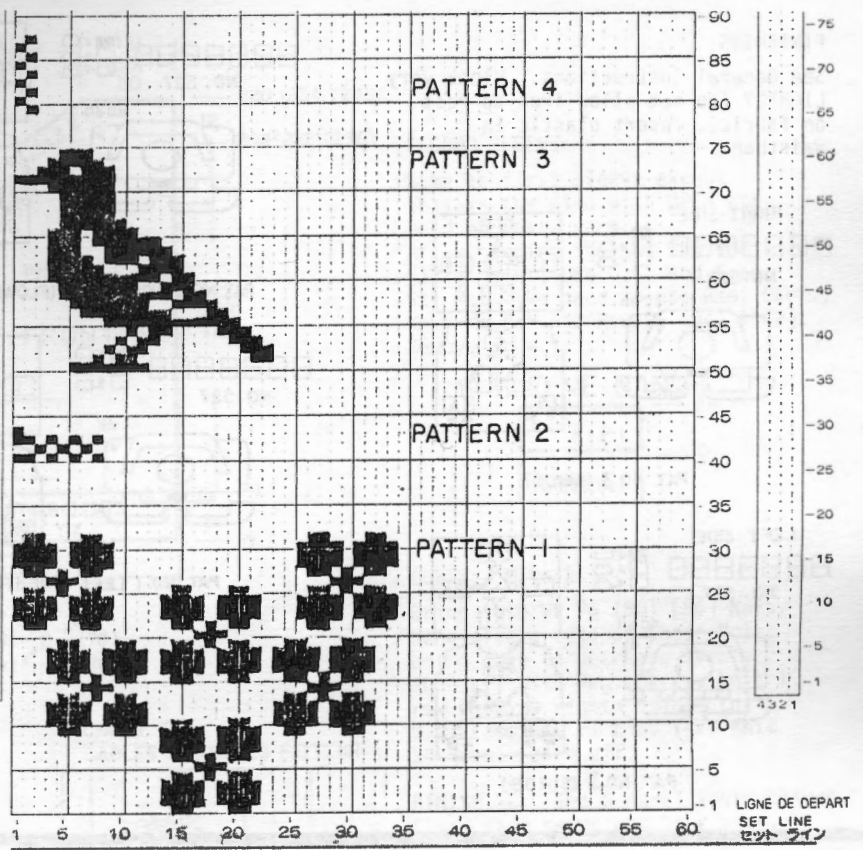

NECKBAND: Close Shoulders.
 K1, P1 Rib. Col. 1. Cast on 143
 (151) sts. Knit 6 rows. Make
 BUTTONHOLE on the LEFT SIDE over
 Ndl's. 5 and 6 (both beds).
 After Row 12, transfer Rib sts. to
 MB. With WRONG SIDE FACING, pick
 up sts. along neck edge onto these
 Ndl's. Knit 1 row, then bind off
 loosely.

FINISHING: See General Instructions.
 When setting in sleeve, make 4
 pleats on top of Cap, 2 facing
 front, 2 facing back. Sew on
 Buttons.

SKIRT: FRONT AND BACK THE SAME.
 FNR: Color 1, single strand. Cast
 on 192 (200) sts. After knitting
 SELVEDGE ROWS, Transfer sts. ON EACH
 BED as follows:
 ON MAIN BED, ON EACH SIDE OF 0,
 transfer st. from Ndl. 5 to neigh-
 boring needle on the RIGHT. Put empty
 needles OUT OF WORK. ON EACH SIDE,
 transfer every 9th st. to neighboring
 needle to the right. Put empty
 Ndl's. out of work.
 ON RIBBER, To the LEFT of 0, transfer
 stitch 1 to neighboring needle on
 the LEFT. ON EACH SIDE, transfer
 every 9th st. to needle on LEFT.
 Put empty needles out of work.
 Continue in Ribbing Pattern as
 set up, CHANGING TENSION AFTER ROWS
 AS SHOWN ON THE CHART.
 After Row, 240 (248), Trans. Rib sts.
 to MB, knit 1 row St.st. Remove on W.Y.
 Bring 144 (152) Ndl's. to WP. Hang
 open sts. back onto these Ndl's. de-
 creasing evenly across. Counter 0.
 With T 4, knit to Row 34 (36). Re-
 move on W.Y.
 Bring 130 (138) Ndl's. to WP. Hang
 open sts. onto these Ndl's. de-
 creasing evenly across. Counter 0. Knit
 34 (36) rows. With T 10, knit 1 row
 to left. With T 4, continue in
 St. st. to Row 58 (60). Pick up the
 T 10 loose row to form hem. Knit 1
 row, bind off Loosely.

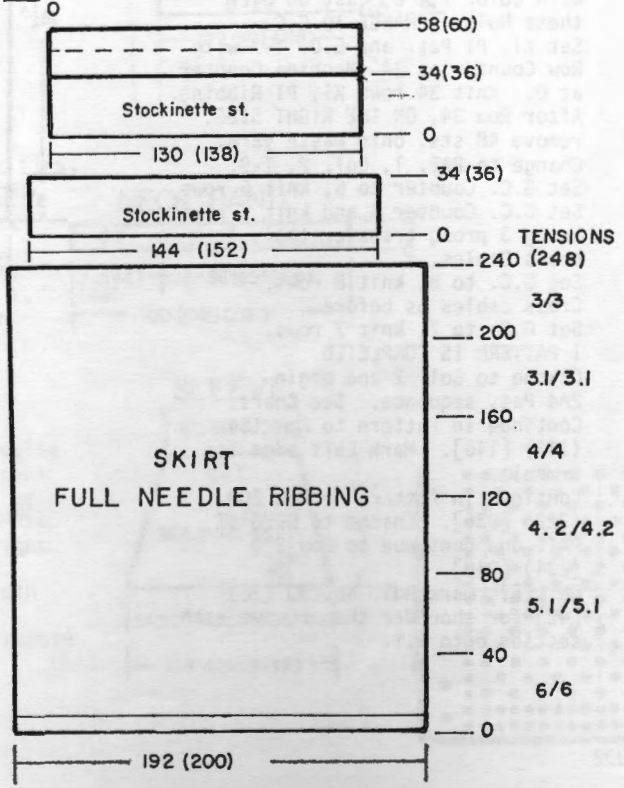

CONTINUED NEXT PAGE

FINISHING:

See General Instructions. Block very LIGHTLY (do not allow iron to rest on fabric). Insert elastic in Waistband.

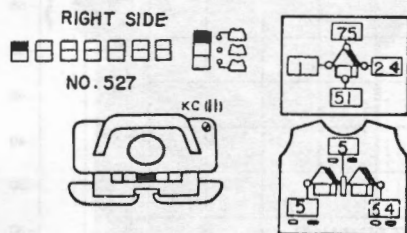

PAT. NO. 3 (BIRDS)

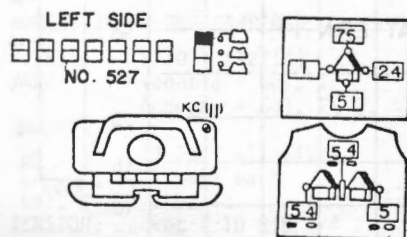

PAT. NO. 3 (BIRDS)

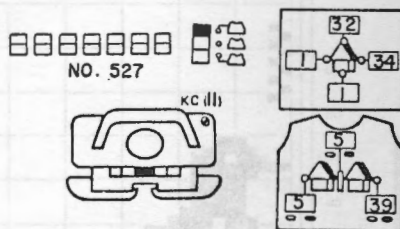

PAT. NO. 1 RIGHT SIDE (FLOWERS)

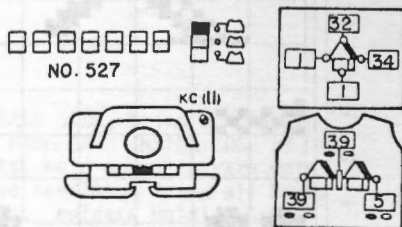

PAT. NO. 1 LEFT SIDE (FLOWERS)

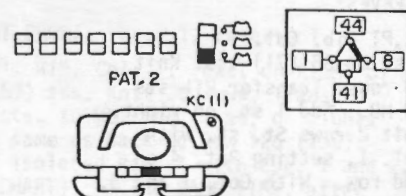
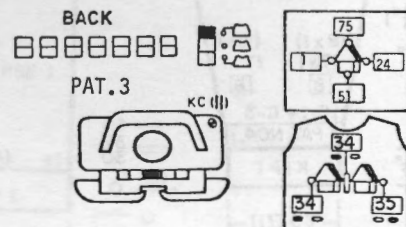
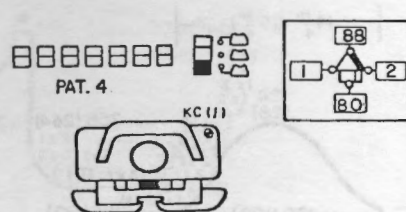

BACK:

With waste yarn, CO 122 (132) [142] sts. NOTE: Under Chart there are needle numbers shown. Example: Cast on 122 sts. Chart shows Ndle No. 66 on the LEFT and Ndle. No. 56 on RIGHT. If you do not use the designated Ndle. Nos. the Pat. will not be correct.

After several rows with W.Y. and 1 row Ravel Cord to the RIGHT, bring all the needles to HP then with color 1, 'e' cast on over these Ndl's. CHANGE TO G.C.

Set K1, P1 Pat. and G.C. T-7 with Row Counter at 34. Machine Counter at 0. Knit 34 rows K1, P1 Ribbing. After Row 34, ON THE RIGHT SIDE, remove 48 sts. onto waste yarn. Change to PAT. 1, Col. 2, T-9.

Set G.C. Counter to 6, knit 6 rows. Set G.C. Counter 5 and knit 5 rows. Using 3 prong transfer tool, cross Cables.

Set G.C. to 8, knit 8 rows. Cross cables as before. Set G.C. to 7, knit 7 rows. 1 PATTERN IS COMPLETED.

Change to Col. 2 and begin 2nd Pat. sequence. See Chart. Continue in Pattern to Row 134 (142) [146]. Mark Left edge for armhole.

Continue in Pattern to Row 208 (222) [236]. Change to SEED ST. PAT. and continue to Row 220 (234) [248].

ON LEFT, mark Ndl. No. 30 (36) [42] for shoulder then remove each section onto W.Y.

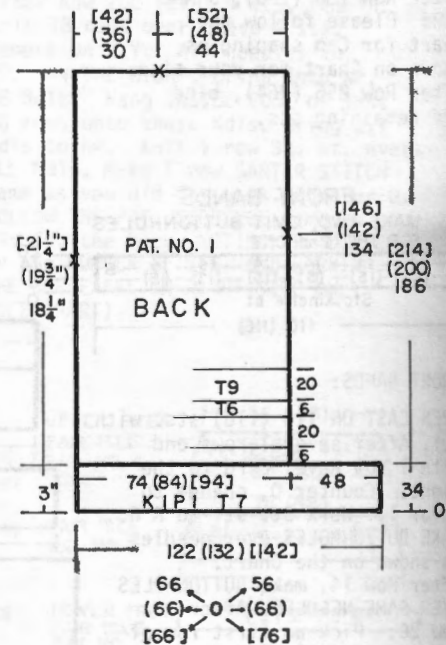

WOMENS PULLOVER

SIZES: 4/6 (8/10) [12/14]

YARN: Bulky Venetia = Col. 1
 Nubby Tweed = Col. 2

AMOUNT:

Col. 1 1 1/2 1 1/2 2 lbs.
 Col. 2 5 oz. for all sizes.

TENSION: KG Carriage T-9

GAUGE: 13 sts. 20 Rows = 2" (5 cm)

Can be made on any machine with GARTER CARRIAGE. Punch Cards for KG 89 (or draw on Mylar Sheet for KG 88) for Pat. 1 and 2. For Garter Stitch, see KG Instruction Manual for correct card or Mylar Sheet. For Seed St., Punch Card machine owners, use Standard Card No. 1. Electronic Machine owners, select section of any every other needle (that alternates each row) Pat.



FRONT:

Follow chart for C.O. same as you did for back. Work same as back to Row 34.
 ON LEFT, remove 48 Sts. onto W.Y. Continue with G.C. in Pat. same as back to Row 208 (222)[236]
 ON LEFT (Neck) side bind off 36 (38)[44] sts. Change to SEED St. Pat. ON NECK SIDE bind off every 2nd row 2 sts. 3x, 1 st 2x. After Row 220 (234)[248], remove the sts. on W.Y.

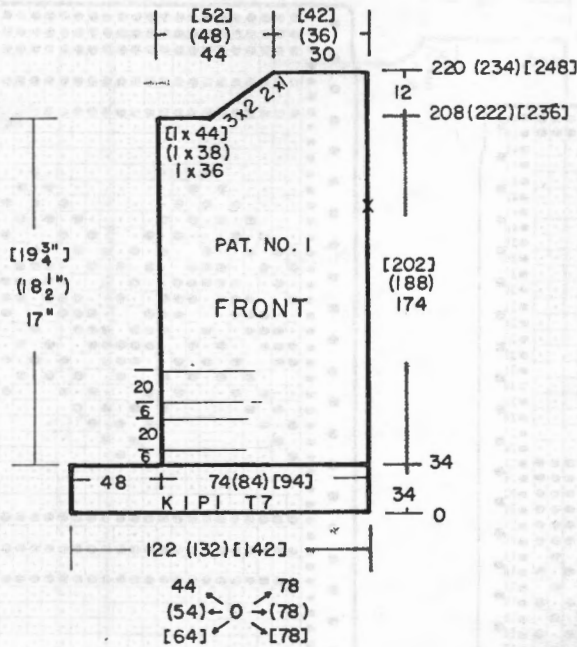

SECOND SLEEVE:

Same as first sleeve except this is the side with OPEN sts. held on waste yarn. After hanging the sts. on 108 (120) [132] Ndl's., Use G.C. and Seed St. Pat. (No need to use Reg. Carr.) Knit in Pat. to Row 86 (94) [102]. Remove on W.Y.

SLEEVE BAND

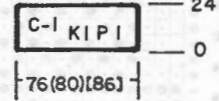

CUFFS: Make 2.

Bring into WP 76 (80) [86] Ndl's. Hang sleeve edge on these Ndl's. being sure to decrease evenly across. With Reg. Carr., knit 1 row left to right. Change to G.C. and K1, P1 Rib. T-7. Knit 24 Rows. Bind off.

FINISHING: See General Instructions. Close side seams and Neck edge.

BACK PANEL

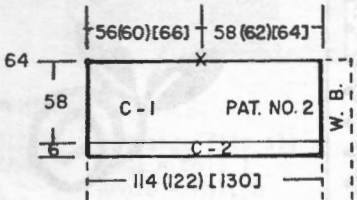

BACK, SIDE PANEL

Bring into WP 114 (122) [130] ndls. With wrong side facing, hang BACK VERTICAL EDGE on these Ndl's. With Col. 2 and regular Carr. T-9 knit 1 row St. st. from LEFT TO RIGHT. Change to G.C. and PAT. 2. Knit 6 rows. Change to Col. 1 and continue in Pat. 2 for additional 58 rows. (Mark for Sleeve - See Chart). Remove the sts. on W.Y.

CHART FOR CABLES & STRIPES PATTERN

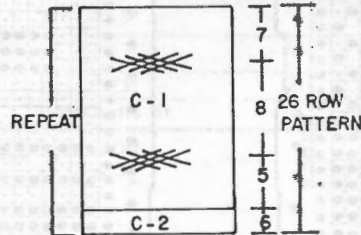

FRONT, SIDE PANEL

Bring into WP, 102 (110) [118] Ndl's. With WRONG side facing, hang Front VERTICAL EDGE on these Ndl's. same as you did for back. With Col. 2 and Regular Carr. knit 1 row St. st. from LEFT TO RIGHT. Change to G.C. and PAT. 2, knit 6 rows. Change to Col. 1. ON THE RIGHT, inc. 2 st. every 2nd row 6x. Cont. in Pat to R 64. Mark for armhole as shown on Chart then remove onto W. Y.

FRONT PANEL

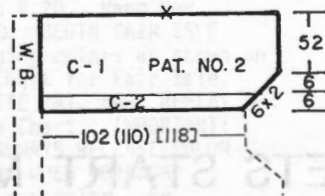

NECKBAND: - Close left shoulder first.

Bring into WP 100 (108) [118] Ndl's. With WRONG SIDE facing, hang Neck opening on these Ndl's. With Col. 1 and Reg. Carr. knit 1 row LEFT to RIGHT. Change to G.C. and Col. 1, T-7. Knit 12 rows Garter Stitch. Bind off.

NECK BAND

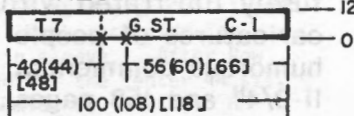

SLEEVE: - Close 2nd Shoulder.

Bring into WP, 108 (120) [132] Ndl's. With wrong side facing, using markers as guide, hang sleeve opening these Ndl's. (This edge will be the one with closed Sts.) With Reg. Carr. knit 1 row from left to right. Change to G.C. and Seed St. Pat. ON EACH SIDE, dec. 1 st. every 6th Row 14x (15x) [16x]. After Row 86 (94) [102], with Reg. Carr, remove onto W.Y.

SLEEVE

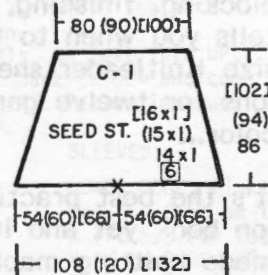

GARTER STITCH

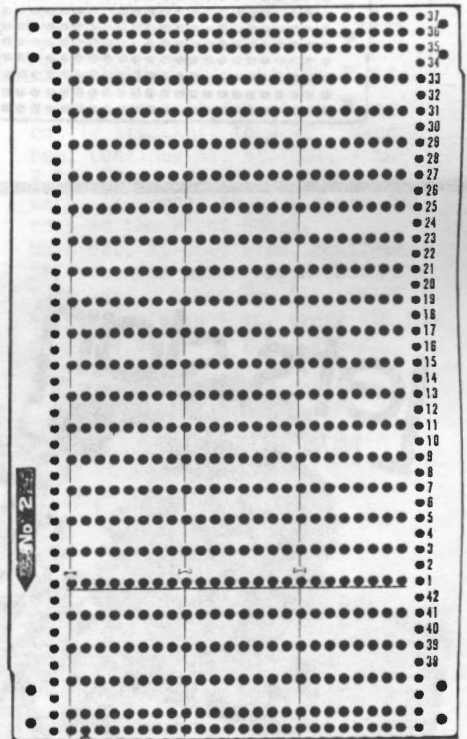

SEED STITCH

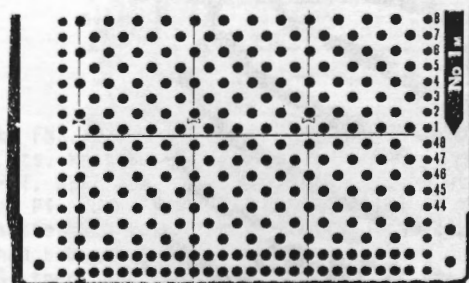

CONTINUED

KH 820 through 891 Punchcard.
 Other machine owners punch card thru R 31
 then punch 2 rows of holes for connecting card.

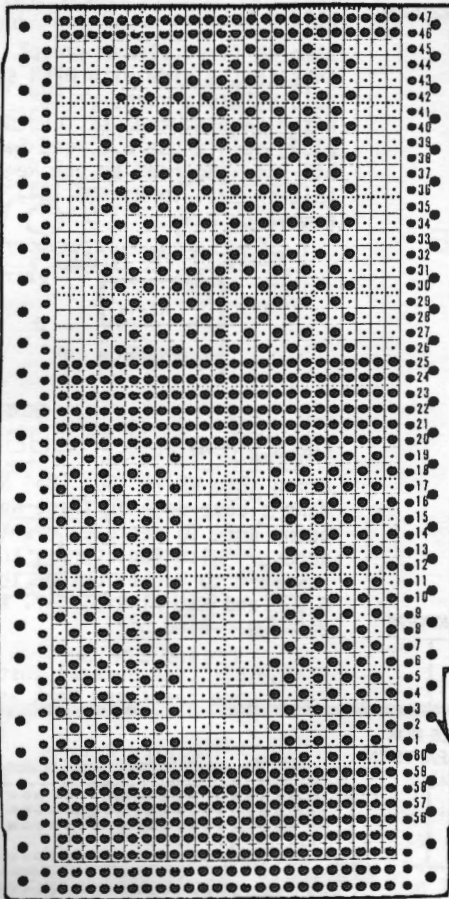

Pattern No.1

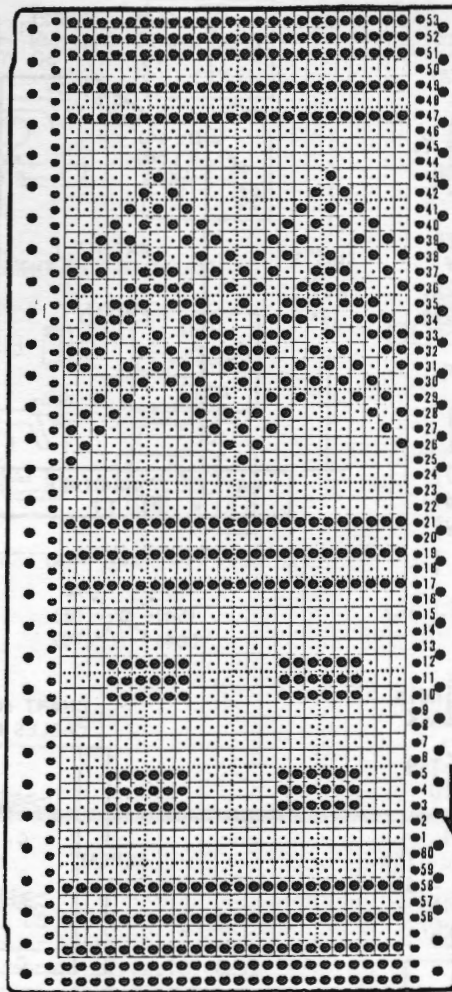

PATTERN NO. 2



LETS START MACHINE KNITTING...

This is the book we have all been waiting for.. A step by step volume of instructions... profusely illustrated with hundreds of line drawings, caricatures of people mouthing instructions and humorous comments.. It's a large book 8-3/4 x 11-3/4" and 158 pages... packed full of good easy to understand information embracing practically everything one needs to know about knitting, blocking, finishing, etc... It's so complete it even tells you when to take a coffee break! Six full size Knitleader sheets are included with instructions for twelve garments....All illustrated in full color...

It's the best practical machine knitting instruction book yet and it's excellent for all Japanese made knitting machines.

Order from your local dealer or direct from KNITKING at 1128 Crenshaw Blvd., Los Angeles , California 90019.

529



MENS ROBE

SIZES: One size fits all
YARN: Roma = Col. 1
 Amore = Col. 2

AMOUNT:
 Col. 1 2 lbs.
 Col. 2 1 ball
 Col. 3 1 ball
 Col. 4 1 ball

TENSION: St. st. 5, Fair Isle
 Ten. 6, Pin Tuck FNR 2/2 I

GAUGE: 15.5 sts. 22 rows = 2" (5 cm)

Make on any Punch Card or Electronic machine with Ribber. A Fair Isle border Design. Use Color Changer.

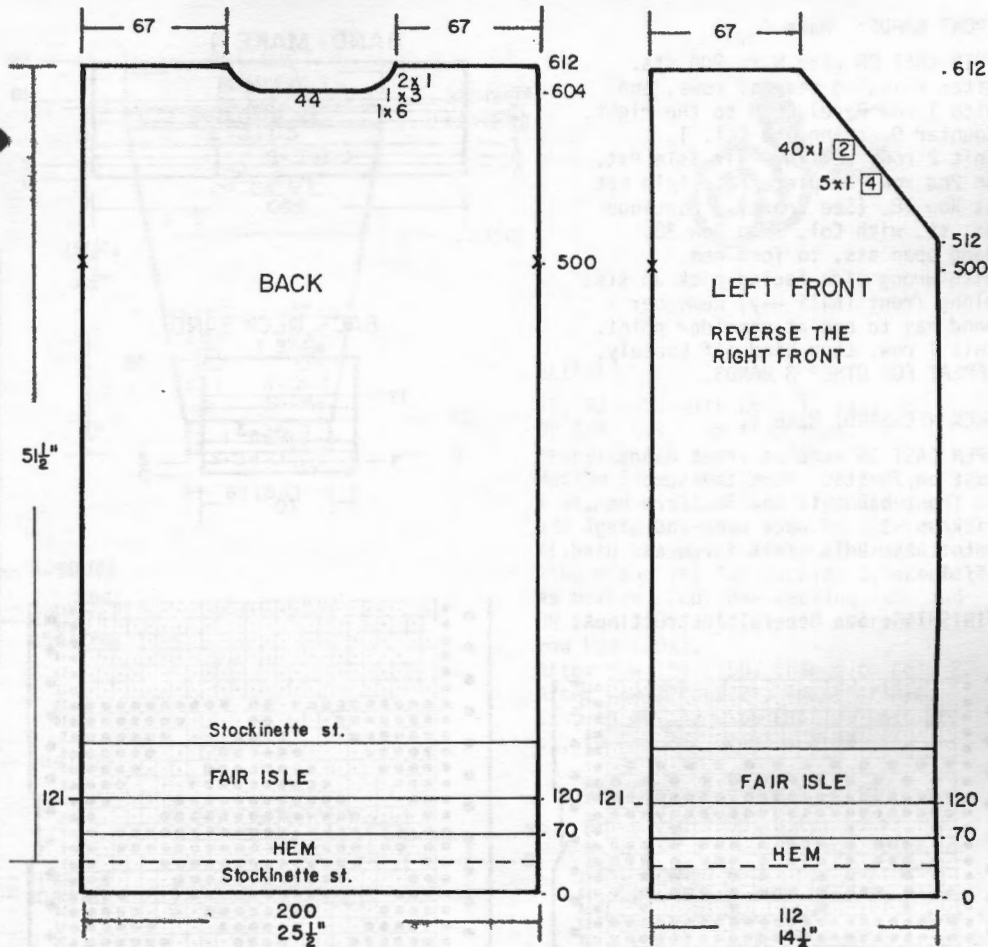

CHART FOR FAIR ISLE

| | |
|----|-----------|
| 58 | C-1 + C-2 |
| 56 | C-1 |
| 54 | C-1 + C-3 |
| 48 | C-1 + C-3 |
| 46 | C-1 |
| 44 | C-1 + C-2 |
| 42 | C-1 |
| | |
| 16 | C-1 + C-4 |
| 14 | C-1 |
| 12 | C-1 + C-2 |
| 10 | C-1 |
| 4 | C-1 + C-3 |
| 2 | C-1 |
| 0 | C-1 + C-2 |

BACK:

Bring 200 Ndl. to WP. Bring EON Ndl. to Selecting or E. position. Set Carriage for Skip (or Slip) st. With Col. 1, knit 1 row to left. Cancel Skip (or Slip) and continue in St. st. to R 70. Hang Hem. Knit to R 120. BEGIN FAIR ISLE PAT. 1, changing colors as shown on the special Chart for Fair Isle. Work 1 COMPLETE PAT. then REPEAT to * shown on Chart. IMPORTANT: REMEMBER TO ALWAYS RELEASE COLOR CHANGER BUTTON WHEN WORKING St. st. with one color. Be sure to mark each side with bit of yarn every 100 rows. This will make seaming garment together easier. When Pat. is completed, continue St. St. with Col. 1 to Row 500. Mark each side for setting in sleeve. After Row 604, bind off the center 44 sts. put the Ndl. on left into HP and complete right side first. ON NECK SIDE, bind off 6 sts. 1x, 3 sts. 1x, 1 st. 2x.

*After Row 612, remove the sts. on waste yarn. Bring the Ndl. on left into WP, turn Counter back to 604 and complete left half. Follow instructions from *.

SLEEVES:

LOWER EDGE, Pin Tuck. FNR. 2/2 I. Col. 1. Cast on 166 sts. Knit to R 17. Set PIN TUCK PAT. NEXT ROW. Knit to R 36. Cancel Pin Tuck Pat. Knit to Row 50. Transfer Rib sts. to MB. Knit 1 row then remove on W.Y. REVERSE THE KNITTING then hang the open sts. on same number of Ndl.

LEFT FRONT: (reverse for Right).

Using same method as back, cast on 112 sts. Knit to R 70. Hang hem. Continue St. st. Col. 1 to R 120. Begin Fair Isle Pat same as back. (remember to mark every 100 rows on the right edge). When Pat. is completed, continue St. st. with Col. 1 to R 500. Mark left edge. After Row 512, SHAPE NECK: Decrease 1 st. every 4th row 5x, then decrease 1 st. every 2nd row 40x. After Row 612, remove onto W.Y.

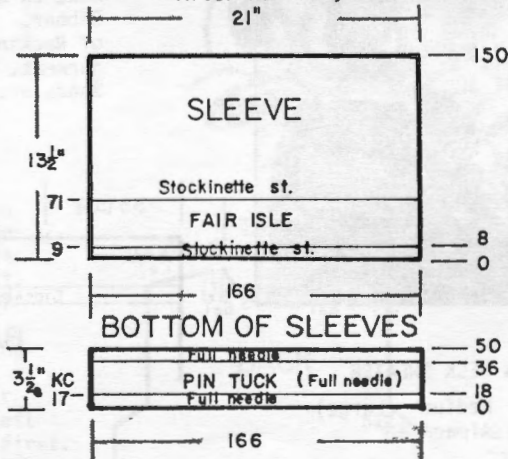

CONTINUED

FRONT BANDS: Make 4.

OPEN CAST ON with W.Y. 200 sts. After knitting several rows, end with 1 row Ravel Cord to the right. Counter 0, change to Col. 1. Knit 2 rows setting Fair Isle Pat. on 2nd row. Complete Fair Isle Pat at Row 18. (See Chart). Continue St. st. with Col. 1 to Row 38. Hang open sts. to form hem. With wrong side facing pick up sts. along front (half way) Remember 1 band has to end at shoulder point. Knit 1 row, then bind off Loosely. REPEAT FOR OTHER 3 BANDS.

BACK NECKBAND: Make 1.

OPEN CAST ON same as front bands. Cast on 70 sts. Work the same as front bands to Row 38. Form hem. Pick up sts. of back neck and hang onto these Ndis. Knit 1 row and bind off loosely.

FINISHING: See General Instructions.

BAND-MAKE 4

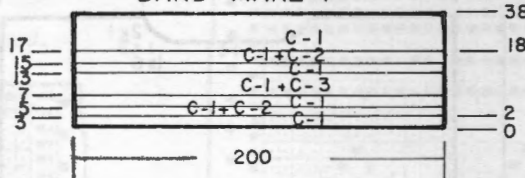

BACK NECK BAND MAKE 1

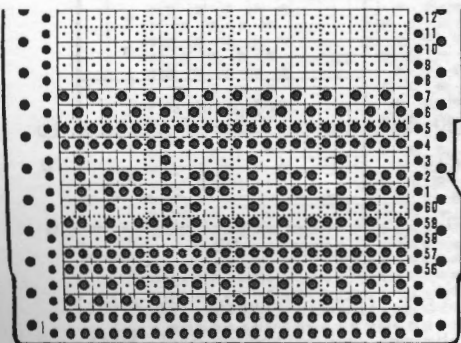
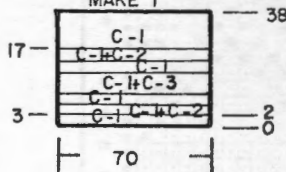

FRONT BANDS

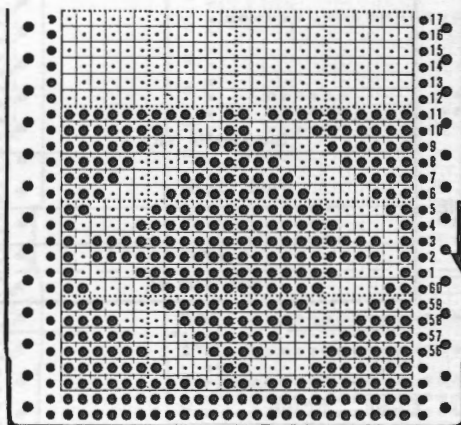

PIN TUCK

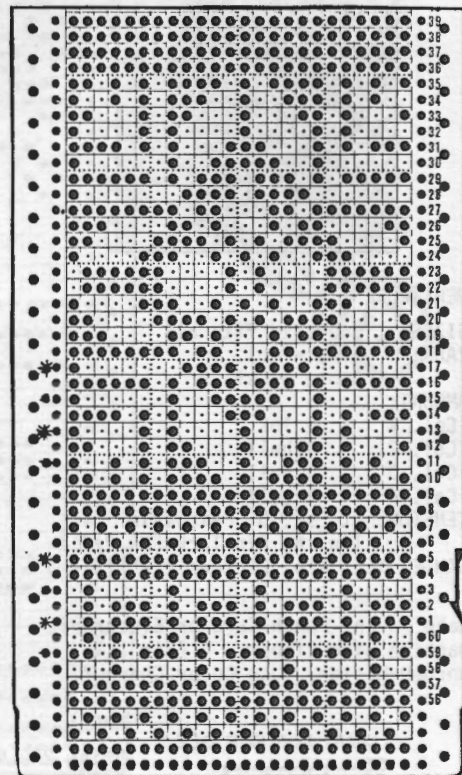

PATTERN NO. 1



Make on any standard Machine with Ribber. Be sure to knit a sample of Racking Pattern before making garment. See Instruction Manual. Bands are 2 x 2 Ribbing.

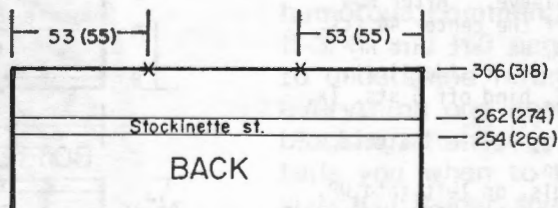

BACK:

2/2 Rib. With color 1, cast on 158 (166) sts. Knit 36 rows. Transfer Rib sts. to MB. Add 1 st. on right edge. Knit 2 rows St. st. with T 8.*Transfer every other st. to Ribber. Put Racking Indicator on 5, Set for Half Pitch. Knit 1 row to the left. Set Racking Indicator to 4, Knit 2 rows with Col. 2. **Racking Indicator to 5, knit 2 rows. Racking Indicator to 4, knit 2 rows. REPEAT FROM **FOR PATTERN to R 106(110) Transfer the Rib sts. to MB. T 8. With Col. 3, knit 8 rows. Transfer every other st. to Ribber, following the Instructions from *. With color 1, knit in Pattern. After Row 184 (192), Change to Color 2 and mark each side for sleeve opening. After Row 254 (266), Transfer the Rib sts. to MB and knit 8 rows St. st. with color 3. Transfer every other st. to Ribber, set for Racking Pat. same as before with Col. 1. Continue in Racking Pat. to Row 306 (318). Transfer Rib sts. to MB, knit 1 row St. st. Mark each side for neck opening, then bind off LOOSELY.

MENS CREW NECK SWEATER

SIZES: Medium (Large)
YARN: Alpacana

AMOUNT:
Col. 1 8 9 balls
Col. 2 5 6 balls
Col. 3 1 1 ball

TENSION: Racking Pat. 6/6 I
2x2 Rib 4/4 I

GAUGE: 13 1/2 Sts 24 Rows 2" (5 cm)

FRONT:

Work the front the same as the back to neck Shaping after Row 272 (284)

In Center bind off 20 (21) Sts. Mark direction of Racking Indicator (This is Important). Put all needles on the left into HP and complete right side first.

*ON NECK SIDE, bind off 2 sts. 3x, 1 St. 10x (12x). After Row 306 (318), transfer Rib sts. to MB knit 1 row then bind off LOOSELY. Bring the needles on the left into WP. Set Racking Indicator, Counter at 272 (284) and complete the left half. Follow instructions from *.

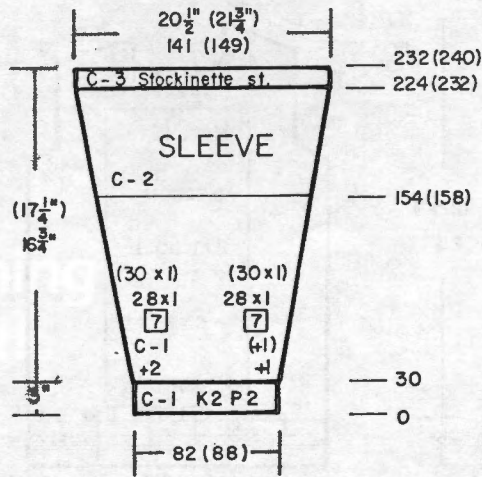

SLEEVES:

K2, P2 Rib. With Col. 1, cast on 82 (88) sts. Knit 30 rows. Transfer Rib sts. to MB. For Medium Size, add 2 sts. on left, 1 st. on right. For large Size, add 1 st. on right side. Knit 2 rows St. st. Transfer every other st. to Ribber and set for Racking Pat. same as before. Continue Racking Pat. and ON EACH SIDE, inc. 1 st. every 7th row 28x (30x). After Row 154 (158) change to Col. 2. After Row 224 (232), Transfer Rib. sts. to MB and with Col. 3, knit St. st. to Row 232 (240). Bind off.

NECKBAND: Close 1 shoulder.

Bring 140 (150) Ndl. to WP. With right side facing, pick up sts. around neckline. With Col. 1, knit 1 row from LEFT to RIGHT. Trans. necessary Ndl. to ribber for 2 x 2 Rib. Knit 28 rows. Transfer rib sts. to MB, bind off.

FINISHING:

See General Instructions. Fold Neckband to the outside and stitch into place.

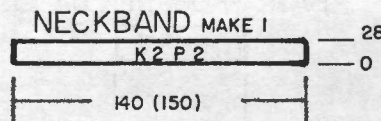
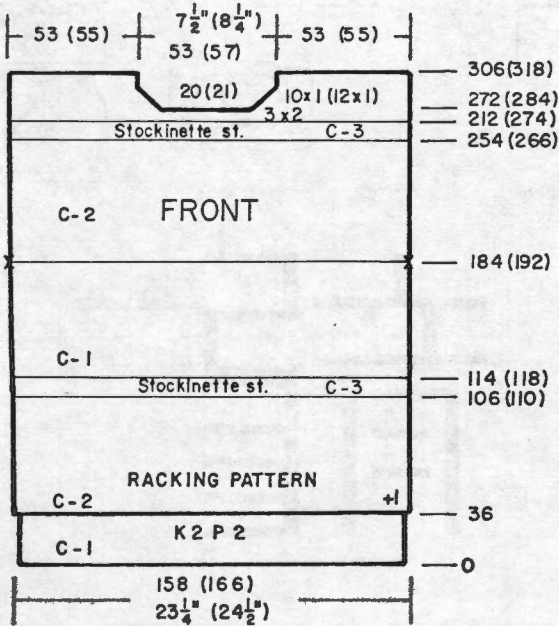

531



Make on any Electronic machine. For full size copy of Design, send \$1.00 plus self addressed, stamped envelope. St.St. with Fair Isle Design on Front section. Bands are K1, P1 Ribbing.



BACK:

1 x 1 Rib. With color 1, cast on 125 (133) sts. Follow col. changes shown on Chart and knit to Row 24. Transfer Rib sts to MB. Inc. 1 st. on right. Continue St. st to R142 (146) SHAPE ARMHOLE: On EACH SIDE, bind off 4 sts 1x, 2 sts. 5x. After Row 200 (208) bind off the center 24 (28) sts., put the Ndl. on left into HP and complete right side first. *SHAPE SHOULDER AND NECK AT THE SAME TIME. FOR NECK, bind off 3 sts. 1x, 2 sts. 1x, 1 st. 1x and for SHOULDER, bind off 8 sts. 3x, 7 (9) sts. 1x. Bring the Ndl. on left into WP. Row counter at 200 (208) and complete left half. Follow instructions from *.

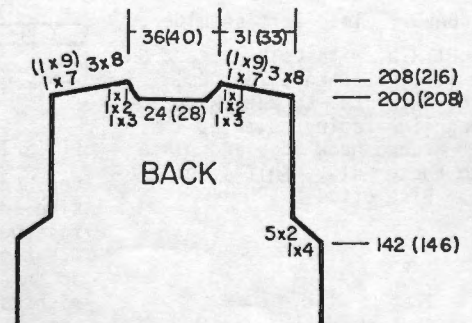

CHILDS DRAGON PULLOVER

SIZES: 10/12 (14/16)

YARN: Alanda = Col.1

Cordella = Col.2

AMOUNT:

Col.1 10 11 Balls

Col.2 1 Ball both sizes

TENSION: 10 Rib 5/5 I

GAUGE: 12 1/2 Sts 17 Rows = 2"

3 Snap Fasteners

CONTINUED

FRONT:

Work same as back to R36 (40).
 Work the SINGLE MOTIF PAT one
 time only, SHAPING ARMHOLE same
 as back after Row 142 (146).
 Continue in St. st. to R 184
 (192). Bind off the center
 12 (16) sts. , put the Ndls. on
 left into HP and complete right
 side first. ON NECK SIDE, bind
 off 5 sts. 1x, 3 sts. 1x, 2 sts. 1x,
 1 st. 2x and after row 196
 (204) SHAPE SHOULDER SAME AS BACK.
 Bring Ndls. on left into WP,
 Row Counter 184 (192) and complete
 left half following Chart.

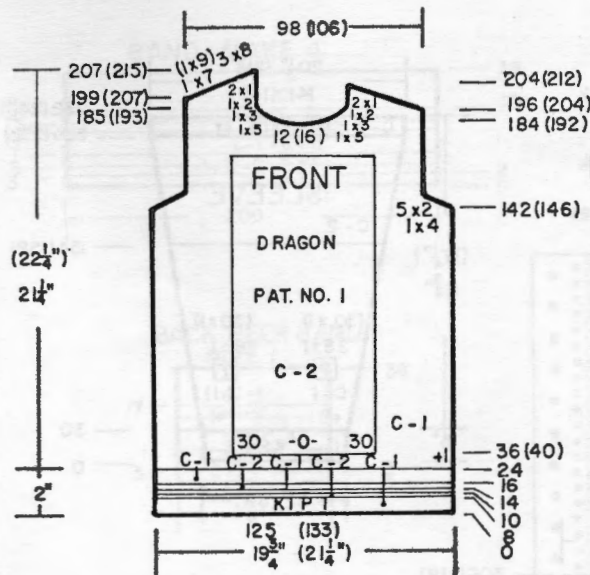

SLEEVES:

1 x 1 Rib. With Col. 1, cast on
 65 (69) sts. Follow Col changes
 same as back/front. Knit 24 rows
 Transfer Rib sts to MB. Inc. 1 St.
 on the right. Continue St. st.
 with Col. 1. ON EACH SIDE, INC.
 1 st. every 8th row 15x (16x)
 After Row 112 (116) Work isolated
 Pat 2 and AT THE SAME TIME , after
 R150 (154) mark each side with
 piece of contrast yarn and after
 Row 154 (158). ON EACH SIDE
 decrease 1 st 9x. After R172
 (176), bind off remaining sts.
 Make 2nd sleeve without Design.

BACK SHOULDER BAND;

With Col. 2, cast on 38 40 Sts.
 Knit 18 rows St.St. Hang hem.
 With wrong side facing, hang open
 sts. of left shoulder onto these
 Ndls. Knit 1 loose row across
 then bind off.

BACK SHOULDER BAND

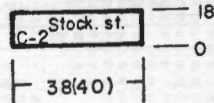

FRONT SHOULDER BAND



FRONT SHOULDER BAND:

K1, P1 Rib. Cast on 47 (49) Sts.
 with Col.1. Follow Color changes as
 shown on the Chart to Row 10.
 Transfer Rib sts to MB. With wrong
 side facing, pick up the open sts.
 of shoulder and place onto these
 Ndls. Knit 1 loose row then bind
 off.

NECK BAND

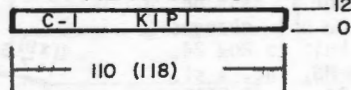

FINISHING:

See General Instructions. Close
 side seams and attach 3 snap
 fasteners to shoulder opening.
 Close other shoulder by picking
 up the open sts. of back with
 right side facing you. Put these
 sts. BEHIND THE LATCHES. Pick up
 front shoulder sts. with WRONG side
 facing you and leave st. in the
 HOOKS of Ndls. Knit the front sts.
 through back sts. Knit 1 loose row
 then bind off.

NECKBAND: Close left shoulder.

K1, P1 Rib. With Col. 1, cast on
 110 (118) sts. Knit 12 rows.
 Trans. Rib sts. to MB. With
 wrong side facing, pick up sts.
 from around neck edge and place
 onto these Ndls. Knit 1 loose
 row. Bind off.

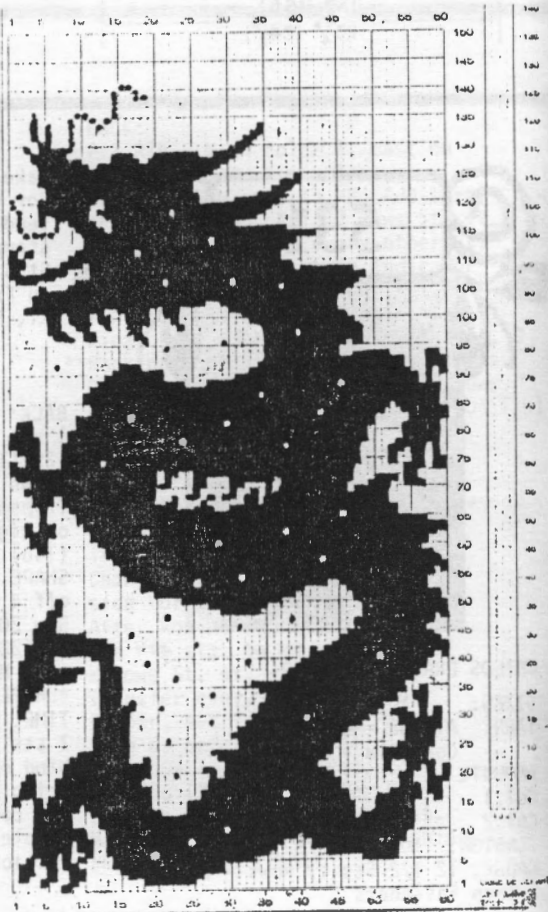
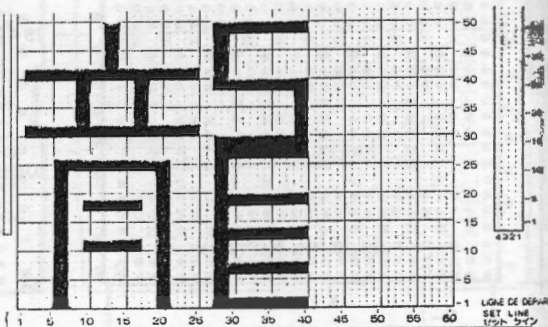
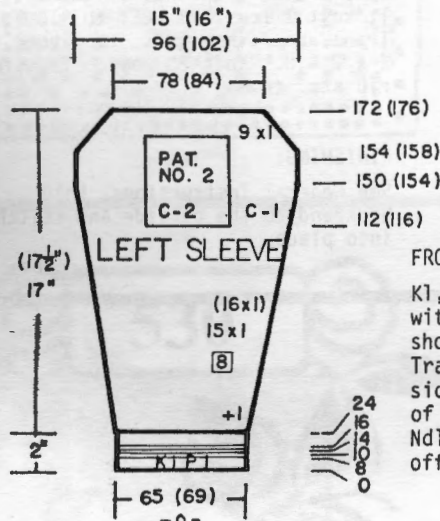

KNITKING

Introduces something
to smile about!!!



The Sensational All New COMPUKNIT III (KH 930)

- The COMPUKNIT III has a total of 555 Pattern Stitch designs permanently programmed into its computer ...
- A Stitch Pattern Book comes with the machine and it illustrates, in full color, every one of the 555 Pattern Stitches. If, for example, you wish to knit Pattern Stitch #419, you push buttons 4-1-9 on the Control Panel.
- No Mylar Sheets or Punch Cards are used or accepted by the COMPUKNIT III.
- You can electronically widen, lengthen, reverse – horizontally and vertically program a single motif up to 200 stitches wide. You can program exactly where you want your pattern to start and where you want it to finish.
- The COMPUKNIT III knits punch (thread) Lace with the main carriage in addition to Transfer Lace with the Lace Carriage.
- No separate carriage is needed for Intarsia knitting ... that capability is also built into the COMPUKNIT III.
- A Regular Carriage and a Lace Carriage are standard (see back of this brochure). The new KG 93 Garter Carriage (optional) electronically casts on, binds off and knits a multitude of fancy Rib and Garter Stitch designs. The KG 93 track is built into the COMPUKNIT III. You can program a Garter Stitch pattern, switch on the carriage and leave to do other things ... the machine will switch itself off when your garment section is completed and will automatically switch off if the yarn runs out.
- The COMPUKNIT III has a Memory Unit built in. You can program your own designs into it.
- You can build a library of your own Pattern Stitch designs by adding an FB 100 FLOPPY DISK DRIVE. It plugs directly into the COMPUKNIT III (no other computer is needed). One floppy disk will hold up to 40 Pattern Stitch designs.
- The KL 116 Knitleader, the KHC 820 and the KRC 830 Color Changers all coordinate with the COMPUKNIT III.

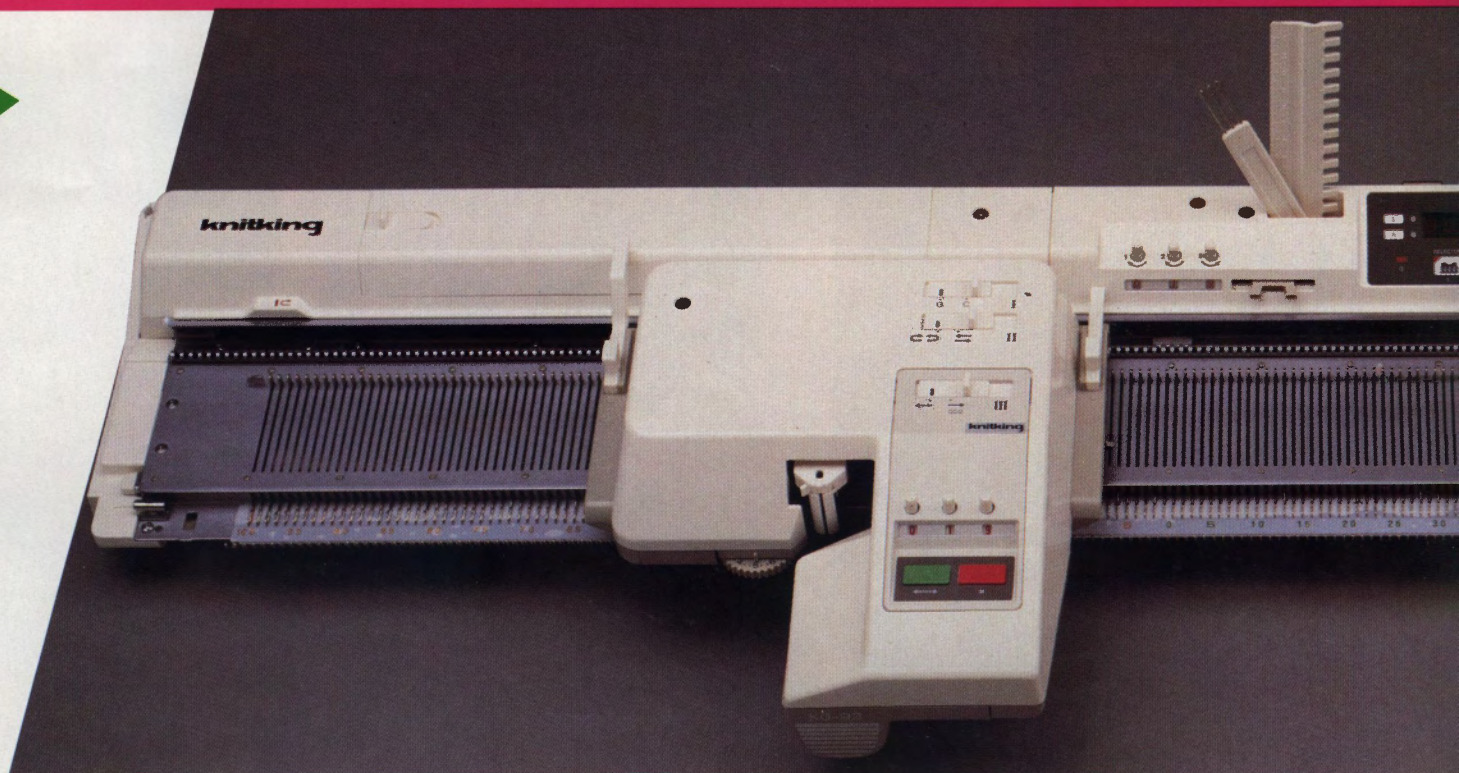

COMPUKNIT III

KH 930

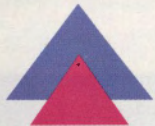
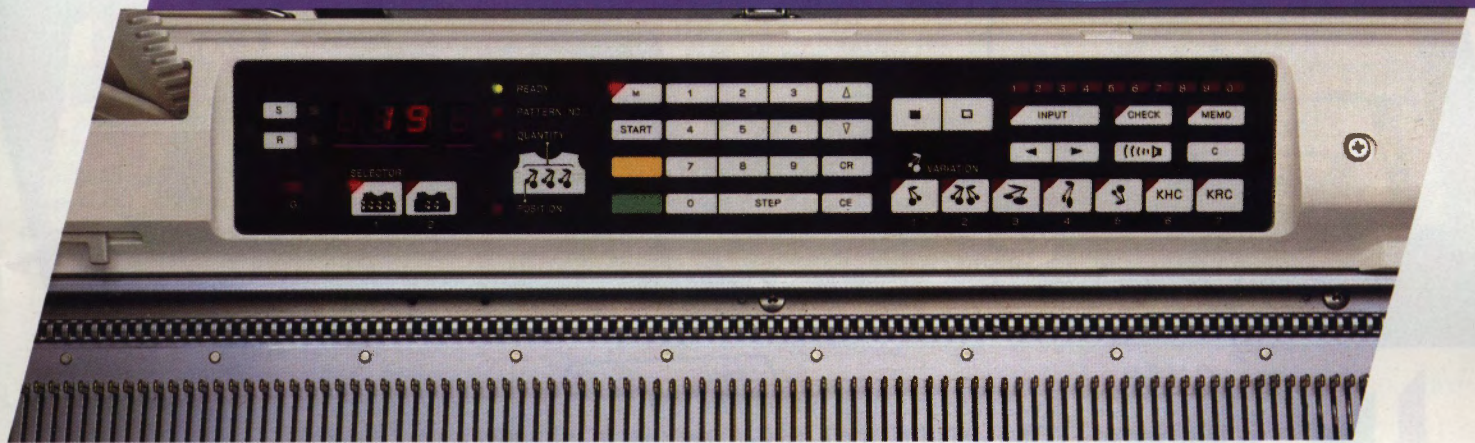

The Programming Panel of the COMPUKNIT III... Everything you need to program the pattern design of your choice from the 555 already in the machine plus all of your own originals.



knitking

KNITKING CORPORATION,

1128 Crenshaw Blvd.,
Los Angeles, California 90019.

Tel: 213-938-2077.

FOR UNLIMITED VERSATILITY

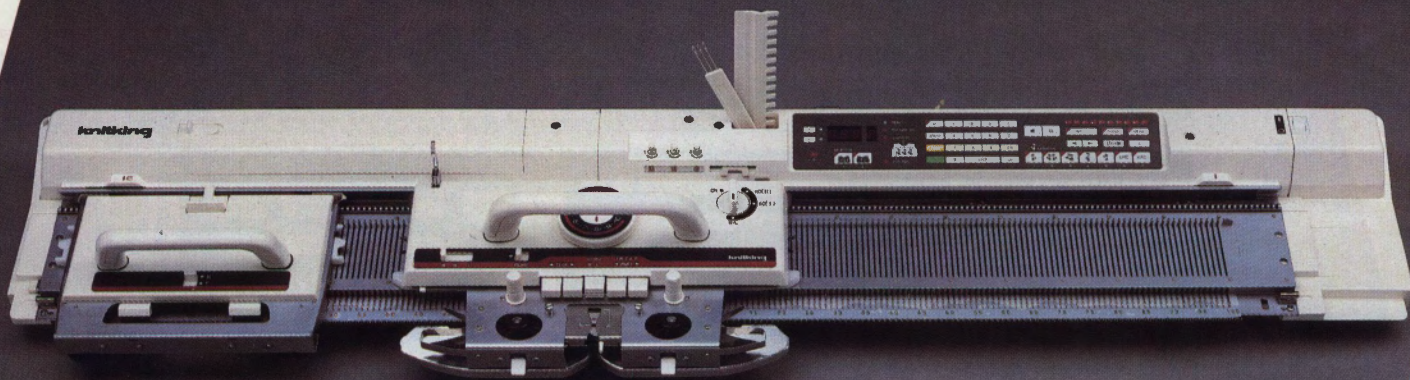

COMPUKNIT III with Lace Carriage and regular Knitting Carriage. Both carriages are standard with the purchase of a COMPUKNIT III. The Lace Carriage knits true Transfer Lace. It automatically knits beautiful yarn-over designs in any combination up to the full 200 needle width of the knitter. It also knits Fine Lace. The Computer permits isolation of Lace designs anywhere you wish in a garment.

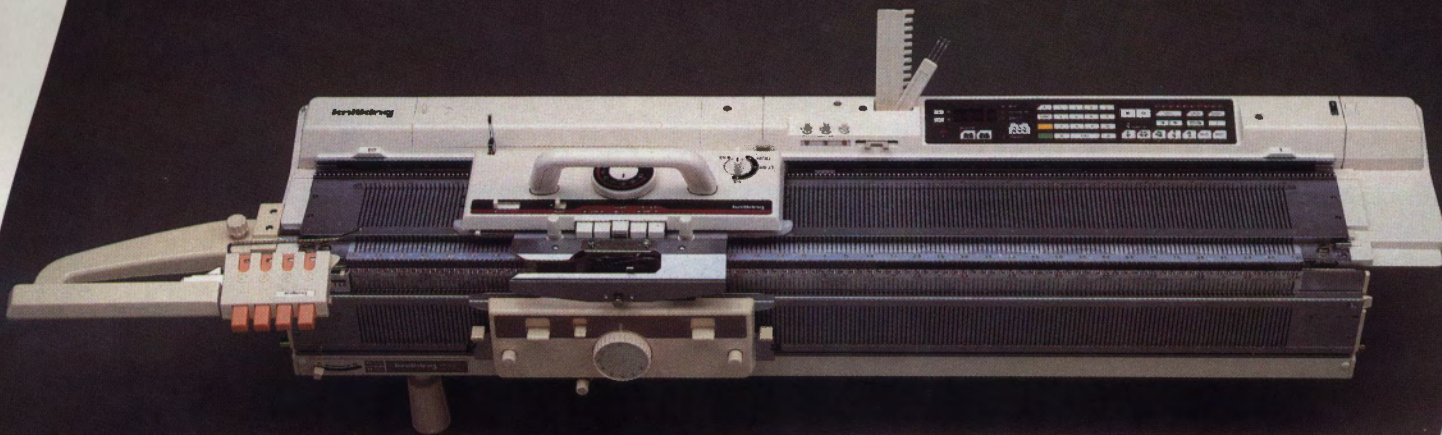

The COMPUKNIT III is illustrated with the KR 900 Ribbing Attachment and the KRC 830 Color Changer (both optional accessories). The Ribbing Attachment knits any combination of knit and purl ribs, racking designs, cable stitches, tubular knitting, etc. Add the KRC 830 Automatic Color Changer and you can knit up to four colors in one row in double knit jacquard. You can also introduce yarns of various textures into a garment. The KHC 820 Color Changer (not shown) operates on the basic machine for the knitting of multi-color designs in Stockinette Stitch.

Order from your local Dealer or direct from **KNITKING CORPORATION**, 1128 Crenshaw Blvd., Los Angeles, California 90019. Tel: 213-938-2077.

532



MANS CARDIGAN

SIZES: 38/40 (42/44)

YARN: Venetia

AMOUNT:

Col. 1 1 lb.

Col. 2 4 oz.

TENSION: St. st. 4.1

2 x 2 Rib. 4/4 II

GAUGE: 17 sts. 24 Rows = 2" (5 cm)

Make on any Standard Machine with Ribber. Sleeves and Waistband 2 x 2 Rib. Neck and Front Band, FNR.

BACK:

2 x 2 Rib. With color 2. Cast on 182 (194) sts. Knit 36 rows. Transfer Rib sts. to MB. Inc. 1 st. ON EACH SIDE. Change to Col. 1 and continue in St. st. After Row 196 (204), SHAPE ARMHOLE: ON EACH SIDE, bind off 3 sts. 5x, 2 sts. 2x (2 sts. 3x). After Row 310 (322), bind off center 56 (60) sts., for neck, put the sts. on left into holding position and complete right side first. *ON NECK SIDE, decrease 2 sts. 4x. After Row 320 (332), remove onto W.Y. Bring Ndl. on left into WP, turn Row Counter back to 310 (322) and complete left half. Follow instructions from *.

FRONT: Make 1, reverse 1.

With Col. 2, cast on 90 (98) sts. 2 x 2 Rib same as back. Knit 36 rows. Transfer Rib sts. to MB. Change to Col. 1 and continue in St. st. After R 173 (181), dec. 1 st. then on every 4th row, dec. 1 st. 34x (37x) BUT AT THE SAME TIME after R 196 (204), SHAPE ARMHOLE same as back. After Row 320 (332), remove on W.Y.

SLEEVES:

2 x 2 Rib. With Col. 2, cast on 90 (102) sts. Knit 32 rows. Transfer Rib sts. to MB. Increase 1 st. EACH SIDE. Change to Col. 1 and continue St. st. ON EACH SIDE, inc. 1 st. every 5th Row 44x. After Row 258 (264), SHAPE CAP: ON EACH SIDE dec. 2 sts. 1x, 1 st. 8x, 1 st. every 4th row 2x. After R 284 (292), remove on W.Y.

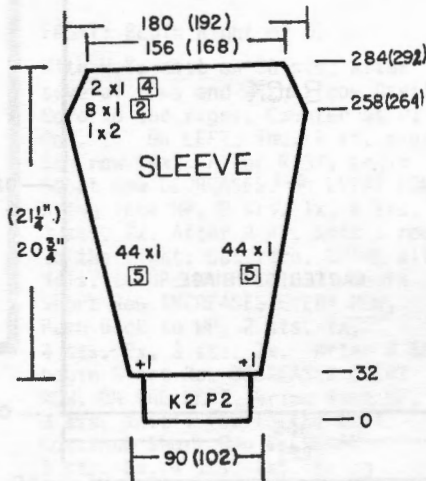
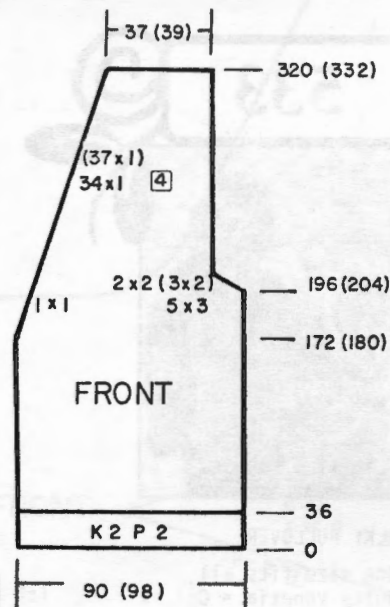

BAND

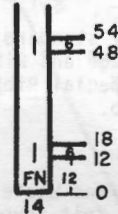

BAND: Made in 1 Piece.

FNR. With Col. 2, cast on 14 sts. Use Fine Needle Bar to prevent dropped sts. T 2/2 I. Make VERTICAL BUTTONHOLES. Each buttonhole is 6 rows and you must knit each half separately (only count 6 rows however). Make first Buttonhole after Row 12 and the following buttonholes after Row 48, 88, 128, 168. Knit approx. a total of 840 rows. Remove on W.Y.

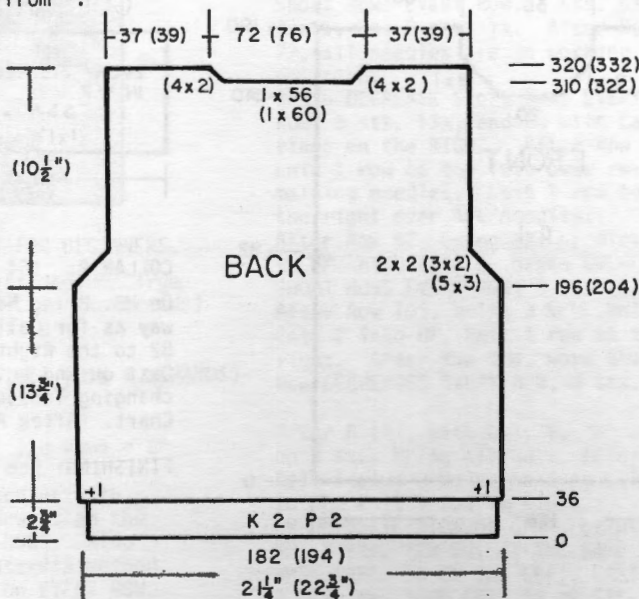

FINISHING: See General Instructions. Attach Band (beginning with the cast on end) down front and around neck. If band is too long, rip back to fit, if too short, rehang onto machine and knit additional rows. Sew on buttons.



533

533

533

533

533

533

533

533

533

533

533

533

533

533

533

533

533

533

533

533

533

533

533

533

533

533

533

533

533

533

533

533

533

533

533

533

533

533

533

533

533

533

533

533

533

533

533

533

533

533

533

533

533

533

533

533

533

533

533

533

533

533

533

533

533

533

533

533

533

533

533

533

533

533

533

533

533

533

533

533

533

533

533

533

533

533

533

533

533

533

533

533

533

533

533

533

533

533

533

533

WOMENS BULKY PULLOVER

SIZE: One size fits all
 YARN: Bulky Venetia = Col. 1
 Angora = Col. 2

AMOUNT:
 Col. 1 2 lbs.
 Col. 2 12 balls
 TENSION: Garter Carr. T-10
 K1/P/ Rib. T-7

GAUGE: 13 1/2 sts. 17 1/2 Rows = 2"

Can be made on any standard machine with Garter Carriage and Ribber. Collar is 1 x 1 Special Ribbing. Cuffs are Mock Rib.

BACK:

Standard Carriage and Waste Yarn. Cast on 142 sts. Knit several rows ending with 1 row Ravel Cord to the right. Bring all Ndl. to E pos. With Col. 1, 'e' cast on. Knit 1 row to the left. Change to G.C. and K1, P1 on Mylar Sheet or Punch Card. Knit 30 rows. Remove on W.Y. Bring 156 Ndl. to working position. Hang the Ribbing held on waste yarn onto these needles, increasing evenly across by picking up a sts. from row below to fill empty Ndl. Change to Standard Carriage. Knit 1 row to the left. Change to G.C. and Pattern. Counter 0. Knit to Row 92. Mark each side for sleeve opening. Continue in Pat. to R 190. Remove center 36 sts. on WY and 60 sts. EACH SIDE for shoulder on WY.

FRONT:

Same as Back to Row 140. SHAPE NECK: Remove center 20 sts. on W.Y. Mark Card. Remove Sts. on the left onto W.Y.
 *ON NECK SIDE, decrease 1 st. every 2nd row 8x. After Row 190, remove the sts. on WY. Carefully bring the Ndl. on left to working position and remove WY. Be sure sts. are in the Ndl. hooks. Turn Counter back to 140 and complete left half. Follow Instructions from *.

SLEEVE:

Standard Carriage and Waste Yarn same as for back. Cast on 120 sts. After waste knitting, change to G.C. and Pat. with color 1. ON EACH SIDE, inc. 1 st. every 6th row 16x. After Row 100, remove on WY.

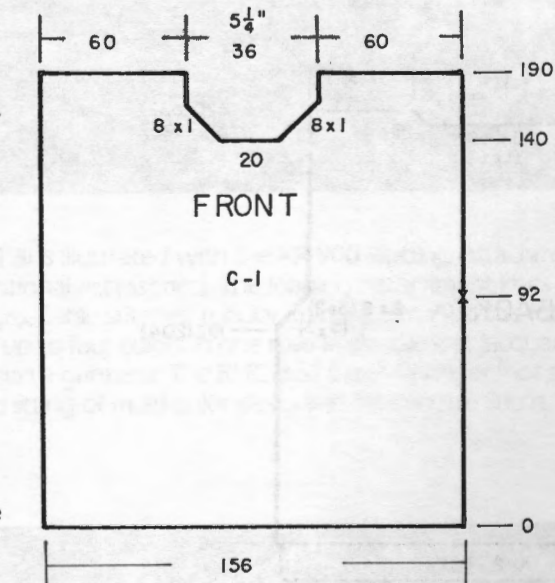
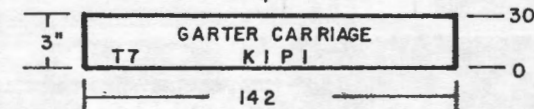
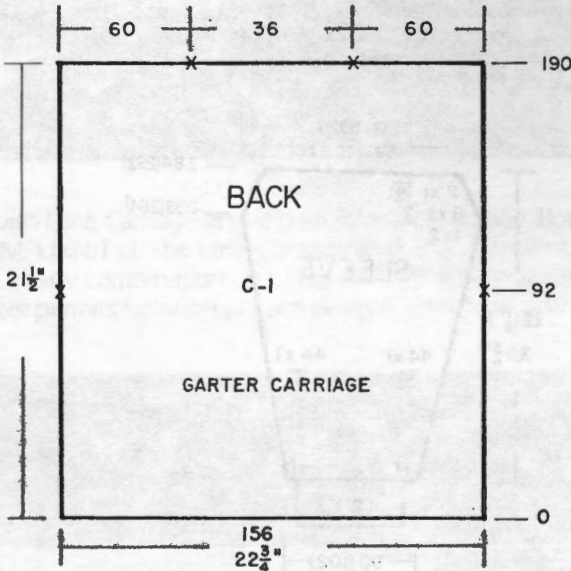
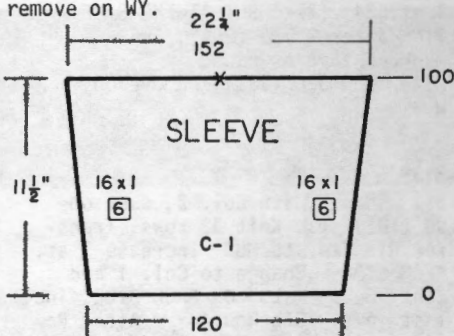

CUFF MAKE 2

C-2
 64 NEEDLES W.P.
 (EVERY OTHER NEEDLE
 MOCK RIB)

128

CUFF: Make 2. Mock Rib.

Bring 128 Ndl. to Working Position. PUSH BACK every other Ndl. to A (NON WORKING) position. With waste yarn, cast on and knit several rows. Change to Col. 2 (T-10) and knit to Row 50. Remove on WY.

COLLAR 1: 199 Sts.

On MB, bring Ndl. 1 to the RIGHT of 0 and Ndl. 3 to the LEFT of 0 into WP then bring every 3rd Ndl. each side to WP. Total, 67 Ndl. Set Ribber on Half Pitch and bring to WP, 1 Ndl. centered BETWEEN the 2 MB Ndl. CAST ON LOOSELY. WATCH FOR TENSION CHANGES AS SHOWN ON CHART. After the circular selvedge, knit to Row 60, changing tensions as shown. Transfer Rib sts. to MB and remove on W.Y.

COLLAR 1

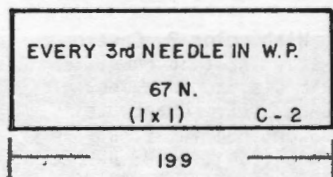

| TENSIONS | |
|----------|----|
| 60 | 60 |
| 3/3 | 48 |
| 4/4 | 36 |
| 5.1/5 | 24 |
| 6.2/6.1 | 12 |
| 8/7.1 | 0 |

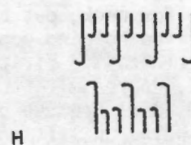

COLLAR 2

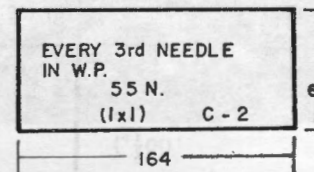

| TENSIONS | |
|----------|----|
| 60 | 60 |
| 3/3 | 48 |
| 4/4 | 36 |
| 5.1/5 | 24 |
| 6.2/6.1 | 12 |
| 8/7.1 | 0 |

COLLAR 2: 164 Sts.

On MB. Bring Ndl. to work, same way as for Collar 1 but end with 82 to the Right of 0. Cast on and knit same as Collar 1 changing Tensions as shown on Chart. After Row 60, remove on WY.

FINISHING: See General Instructions.

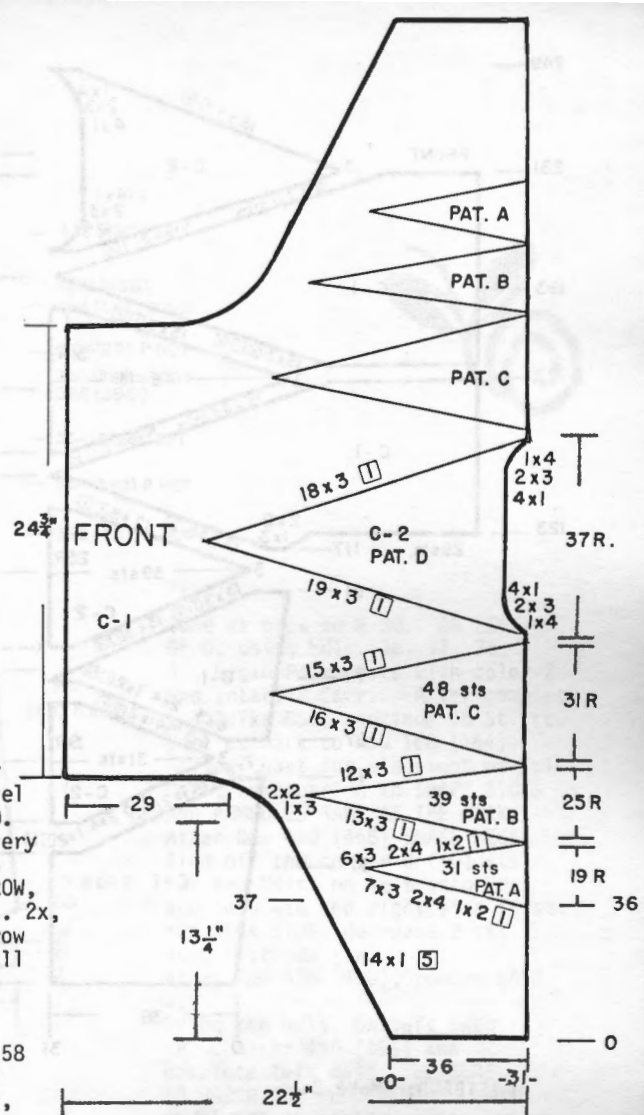
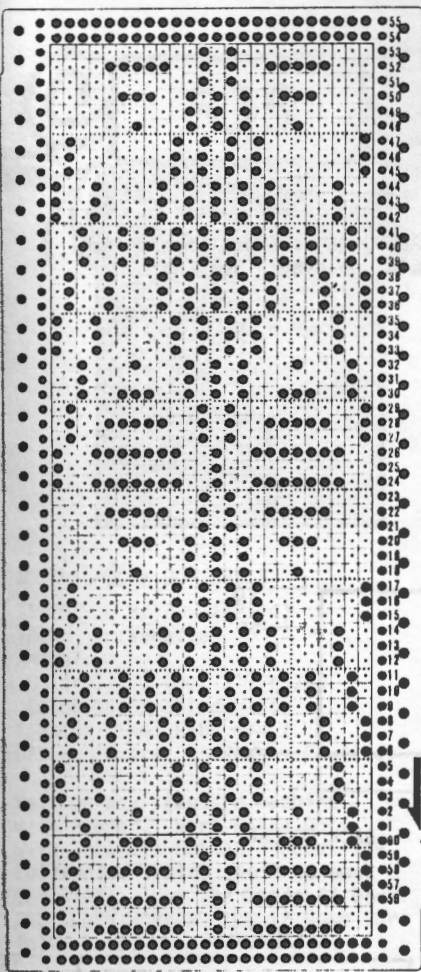

FRONT: Begin Right of 0.

With W.Y. cast on 36 sts. After several rows end with 1 row Ravel Cord to the right. Counter at 0. Col. 1. ON LEFT, inc. 1 st. every 5th row 14x. After R 37, begin Short Row DECREASES. ON EVERY ROW, bring into HP, 2 sts. 1x, 4 sts. 2x, 3 sts. 7x. After R 47, knit 1 row to the right. Cut yarn. Bring all Ndls. to HP. With Col. 2, begin Short Row INCREASES EVERY ROW, Push back to WP, 2 sts. 1x, 4 sts. 2x, 3 sts. 7x. After R 58 begin Short Row DECREASES EVERY ROW. ON THE LEFT, bring into HP, 3 sts. Knit 1 row to the LEFT. Continue Short Row DECREASES 3 sts. 6x, 4 sts. 2x. Bring remaining 2 sts. on right into HP. Cut yarn. After Row 67 (Carriage on left) Attach Col. 1. Begin Short Row INCREASES (all needles are in HP). Push back into WP all needles holding Col. 1 plus 3 needles holding Col. 2. Knit 1 row to the right. Begin Increase Short Rows EVERY ROW, 3 sts. 6x, 4 sts. 2x, 2 sts. 1x. After Row 77, all needles are in working position. Begin DECREASE Short Rows EVERY ROW. 3 sts. 13x, ending with Carriage on the RIGHT. After Row 90, knit 1 row to the left over remaining needles. Knit 1 row to the right over ALL needles. After Row 92, bring all needles to HP. With Col. 2, begin INCREASE SHORT ROWS EVERY ROW, 3 sts. 13x After Row 105, bring 3 Ndls. holding Col. 2 into HP. Knit 1 row to the right. After Row 106, work Short Row DECREASES EVERY ROW, 3 sts. 12x.

After R 117, with Col. 1, 'e' cast on 3 sts. Bring all Ndls. holding Col. 1 plus 3 Ndls. holding Col. 2 to WP. Knit 1 row to Right. ON OPPOSITE SIDE OF CARR, bring to WP, 3 sts. 12x BUT AT THE SAME TIME WHEN CARR. IS ON THE LEFT, CAST ON 2 STS. 2x, THEN CAST ON 29 STS.

After R 130, all Ndls. in WP. ON SAME SIDE AS CARR. bring to HP, 3 Ndls. Knit 1 row to left. SHORT ROW DECREASES ON EACH SIDE, 3 sts. 16x. After R 146, cut yarn. Bring all Ndls. to HP. With Col. 2, begin SHORT ROW INCREASES EVERY ROW. Push back to WP, 3 sts. 16x. After Row 162, ON LEFT SIDE, bring 3 sts. Col. 2 to HP, then continue with Col. 2 and complete SHORT ROW DECREASES EVERY ROW, 3 sts. 15x. After Row 177, All Ndls. in HP. Push back to WP, all Ndls. holding Col. 1 plus 3 Ndls. holding Col. 2. With Col. 1, continue Short Row Increases EVERY ROW, 3 sts. 15x. After Row 193, all Ndls. in WP. With Col. 1, begin Decrease Short Rows EVERY ROW. ON OPPOSITE SIDE OF CARR. bring into HP, 3 sts. 19x. After Row 212, Carr. on right, cut yarn. Bring all Ndls. to HP. With Col. 2, begin Short Row Decreases EVERY ROW, 3 sts. 19x, BUT AT THE SAME TIME, SHAPE NECK: Bind off 4 sts. 1x, 3 sts. 2x, 1 st. 4x. MARK RIGHT EDGE after Row 230 for CENTER OF GARMENT.

CONTINUE IN ESTABLISHED PATTERN TO COMPLETE SECOND HALF WITH REVERSE SHAPINGS remembering to increase for NECK after Row 234 and bind off for UNDERARM after Row 341.

534



WOMENS PULLOVER -NOT FOR BEGINNERS.

SIZE: One size fits Medium/Large
YARN: Mohair = Col. 1 (4 strands)
Angora = Col. 2

AMOUNT:
Col. 1 1 1/2 lbs. (USE 4 STRANDS)
Col. 2 18 balls

TENSION: 6 Rib. 1/1 I
GAUGE: 7 1/2 sts. 10 1/2 Rows = 2"

Make on any Bulky machine with Ribber. Knitted sideways on the machine using SHORT ROWS. Also can be made using Intarsia method. Short Rows are made on EVERY ROW. (See Practical Knitting Hints this issue).

CONTINUED

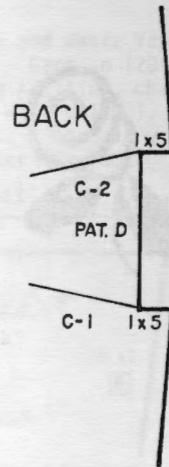
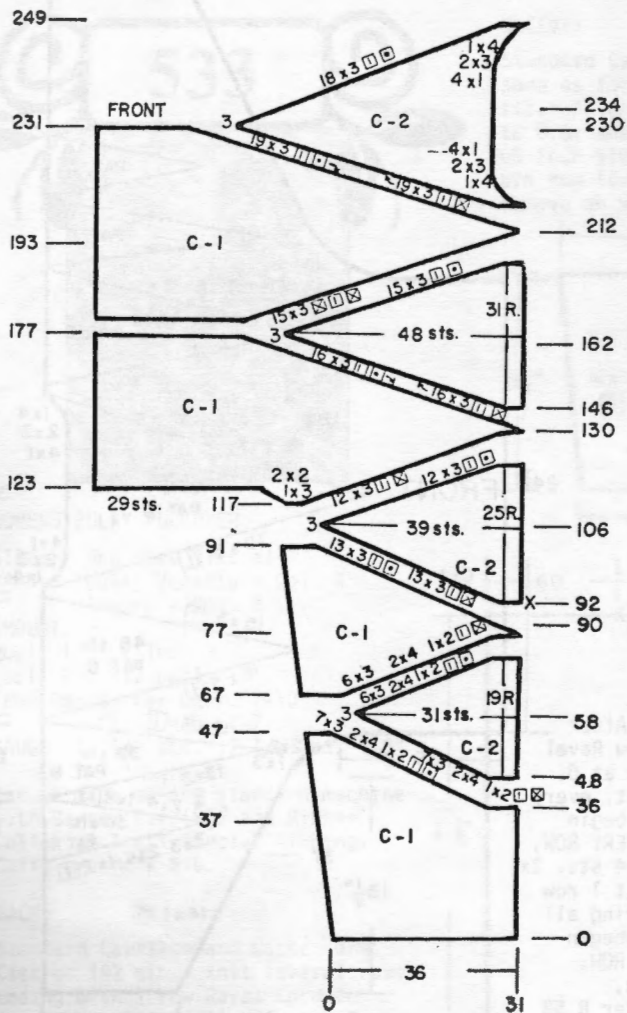

BACK: Same as Front Except for NECK shaping. See Chart.

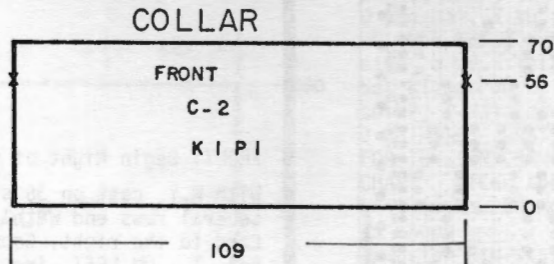

FRONT COLLAR:

K1, P1 Rib. Col. 2. T O/O 11. Cast on 109 sts. Knit to 56 then mark each side with bit of yarn. Knit to Row 70. Transfer the Rib sts. to MB then remove onto W.Y.

BACK COLLAR:

Same as Front Collar but cast on 79 sts.

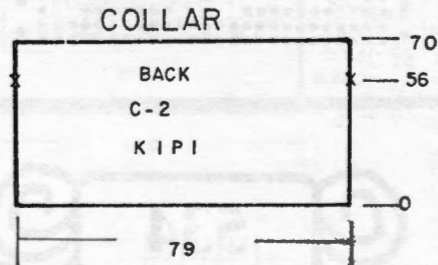

FINISHING:

See General Instructions. Weave Collar sections together, right side to Marked Row, then weave remaining on the WRONG side. Pin and baste to Neck edge, with WRONG side of Collar to right side of garment. With color 2, slip st. crochet through open sts. onto neckline then remove waste yarn.

WAISTBAND: Make 2.

K1, P1 Rib. 4 strands Col. 1 PLUS 1 strand Knitting-in Elastic. T 1/1 I. Cast on 57 sts. Knit to Row 24. Transfer Rib sts. to MB. Pick up sts. along waist edge and place onto these needles, spacing the sts. evenly across. Knit 1 row then bind off loosely.

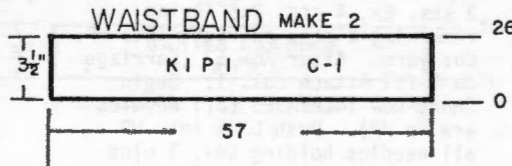

CUFFS: Make 2. Col. 1

K1, P1 Rib. same as Waistband. Cast on 35 sts. Knit to R52. Transfer Rib sts. to MB, pick up open sts. from sleeve edge decreasing evenly across. Knit 1 row, then bind off loosely.

CUFF MAKE 2

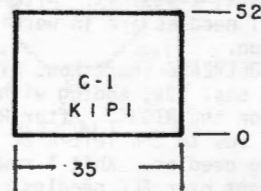

MACHINE KNITTING FASHION

The leading knitting publication from England. It contains 36 complete and outstanding patterns for women, men and children. Illustrated in full color, this edition (8½"x11") has a special KH 260 section and a stunning assortment of fairisle designs.

Garments are knitted with Punch Card, Electronic and Bulky machines. At \$6.95 postpaid anywhere in the world, its definitely a 'Best Buy'.

Order direct from KNITTING...
1128 Crenshaw Blvd., Los Angeles, California 90019

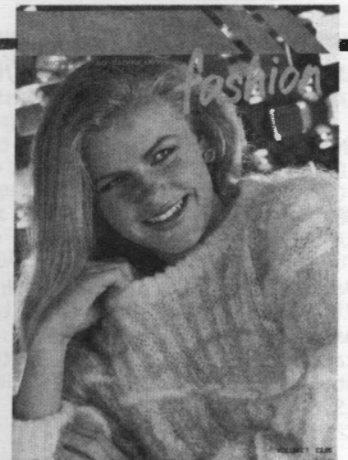

535



WOMENS POLKA DOT DRESS

SIZES: 8/10 (12/14)
 YARN: Venetia
 AMOUNT:
 Color 1 2 lbs. all sizes.
 Color 2 Small amount
 TENSION: 4 Rib. 4/4 I
 GAUGE: 16 sts. 25 Rows = 2" (5 cm)

Knit on any standard machine with Ribber. Work Polka Dots with Intarsia Method. Bands are Full Ndle. Rib.
 IMPORTANT: Use the Intarsia Carr. ONLY WHEN WORKING the 22 Rows for Polka Dots.

BACK:

Full Ndl. Rib. Cast on 182 (190) sts. Knit 10 rows. Transfer Rib sts. to MB. Knit 2 rows St. st. Work Short Rows. ON OPPOSITE SIDE OF CARR. Bring into HP, 40 Ndl. before knitting the next 2 rows. Be sure to wrap inside Ndle in HP to prevent a hole. ON OPPOSITE SIDE OF CARR. bring back into WP 10 sts. 4x ON EACH SIDE. Continue in St. st. ON EACH SIDE, dec. 1 st. every 30 Rows 12x. Knit to R 382 (390). SHAPE ARMHOLE: ON EACH SIDE, bind off 4 (5) sts. 1x, 3 (4) sts. 1x, 3 sts. 1x, 2 sts. 1x, 1 st. 11x. Knit to R 470 (480). SHAPE NECK: Bind off the center 46 (48) sts. Put the Ndl. on left into HP and complete right side first. *ON NECK SIDE, dec. 1 st. 3x (4x). After Row 478 (490), remove on W.Y. Bring the Ndl. on left to WP Turn Counter back to 470 (480) and complete left half. Follow instructions from *.

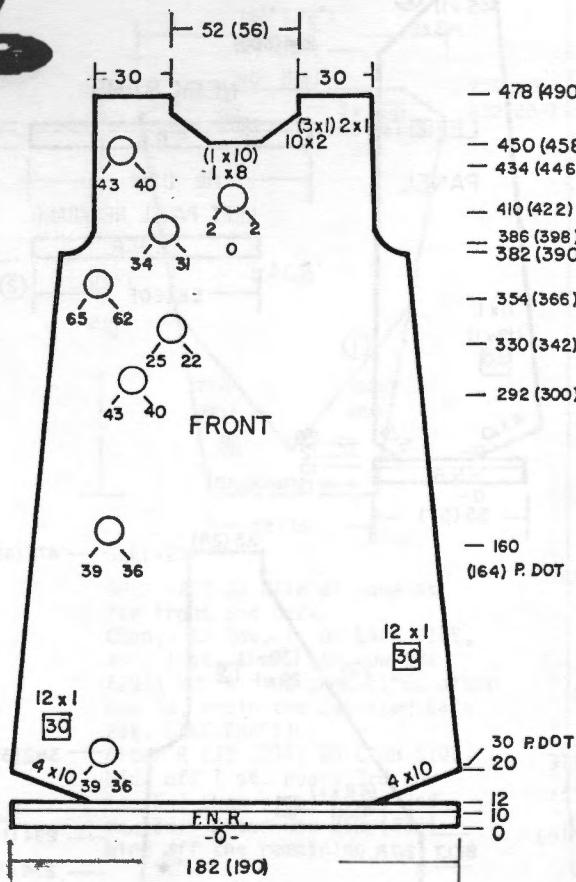

- 478 (490)
- 450 (458)
- 434 (446) P DOT
- 410 (422) P DOT
- 386 (398) P DOT
- 382 (390)
- 354 (366) P DOT
- 330 (342) P DOT
- 292 (300) P DOT

FRONT:

Same as back to R 30. ON LEFT OF 0, using Ndl. 36, 37, 38, 39, begin Polka Dots with color 2 and Intarsia Carr.. After completing Polka Dot, continue in St. st. same as back to Row 160 (164). Follow Chart for placement of Polka Dots, remembering to SHAPE SIDES AND ARMHOLES SAME AS THE BACK. After Row 450 (458) SHAPE NECK: Bind off the center 8 (10) sts. Put the Ndl. on left into HP and complete the right side first. *ON NECK SIDE, decrease 2 sts. 10x, 1 st. 2x (3x). After Row 478 (490), remove onto W.Y. Bring the Ndl. on left into WP. Counter 450 (458) and complete left half. BE SURE TO WATCH FOR PLACEMENT OF LAST POLKA DOT and follow instructions from *.

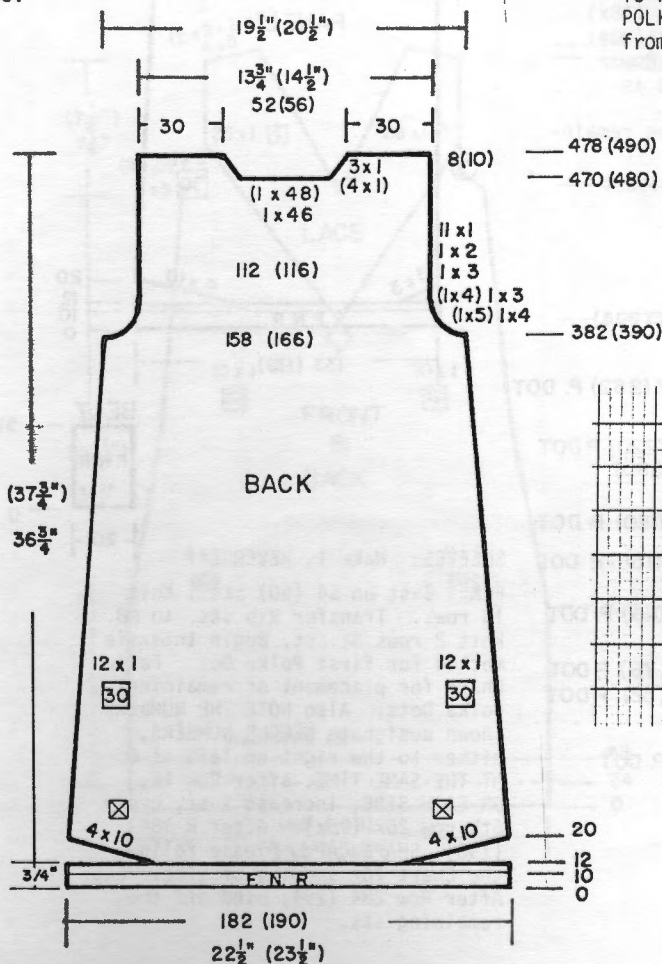

- 478 (490)
- 470 (480)

- 382 (390)

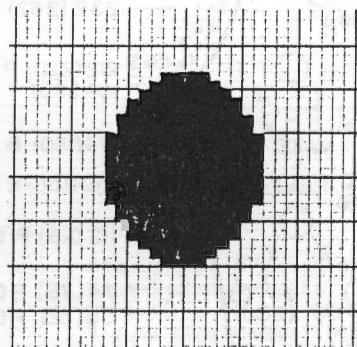

CONTINUED

LEFT PANEL:

FNR. Cast on 55 (57) sts. Knit 10 rows. Transfer Rib sts. to MB. Knit 2 rows St. st. Work Short Rows. ON OPPOSITE SIDE OF CARR. bring into HP 40 Ndl's. Knit 1 row to left. Wrap inside Ndl. to avoid hole. ON OPPOSITE OF CARR. bring into HP, 9 Ndl's. Knit 1 row to right. (ALWAYS wrap inside needle to prevent hole). ON OPPOSITE SIDE OF CARR. bring back to WP, 10 sts. 4x on LEFT and 3 sts. 3x on RIGHT. Continue in St. st. and ON THE LEFT EDGE, dec. 1 st. every 30 rows 12x AND AT THE SAME TIME, after Row 294 (300) ON THE RIGHT EDGE, decrease 1 st. every 2nd row 43x (45x).

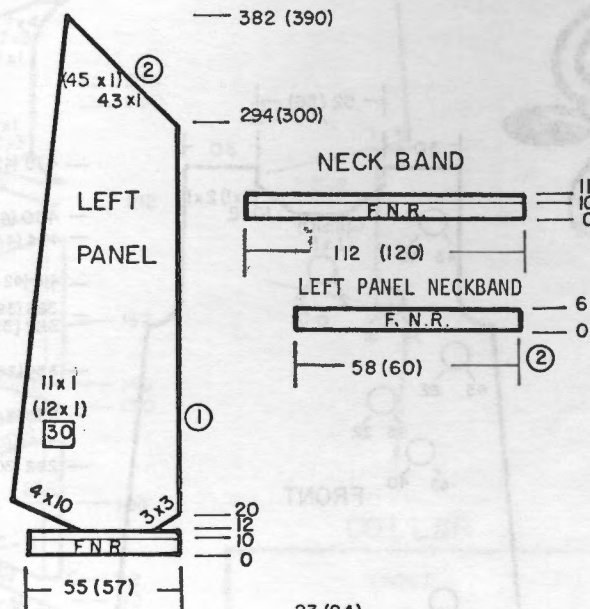

NECKBAND: Close left shoulder.

FNR. Cast on 112 (120) sts. Knit 10 rows. Transfer Rib sts. to MB. With wrong side facing, hang neck opening onto these Ndl's. Knit 1 LOOSE ROW then bind off.

LEFT PANEL NECKBAND:

FNR. Cast on 58 (60) sts. Knit 6 rows. Transfer Rib sts. to MB. Pick up sts. from NECK EDGE OF LEFT PANEL (match No. 2 in circles). Knit 1 loose row then bind off.

LEFT PANEL FRONT BAND:

FNR. Cast on 160 (164) sts. Knit 6 rows. Transfer Rib sts. to MB. Pick up sts. along LEFT PANEL FRONT EDGE (match No. 1 in circles). Knit 1 loose row then bind off.

RIGHT PANEL:

FNR. Cast on 133 (139) sts. Knit 10 rows. Transfer Rib sts. to MB. Knit 2 rows St. st. then work Short Rows. ON OPPOSITE SIDE OF CARR. bring into HP 9 sts. Knit 1 row to left. (wrap inside Ndl.) ON OPPOSITE SIDE OF CARR. bring into HP 40 Ndl's. Knit 1 row to right (wrap inside Ndl.) ON OPPOSITE SIDE OF CARR. bring back to WP, 3 sts. 3x on LEFT and 10 sts. 4x on RIGHT. ON THE RIGHT, decrease 1 st. every 30 Rows 12x, AND AT THE SAME TIME, after Row 294 (300) ON THE LEFT, dec. 1 st. every 2nd row 46x (48x) then 1 st. every 3rd row 29x (30x) AND AT THE SAME TIME, after Row 383 (390) SHAPE ARMHOLE same as the back. After R 478 (490), remove the remaining sts. on W.Y.

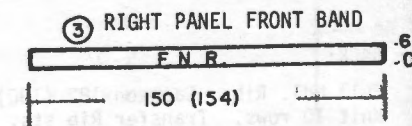
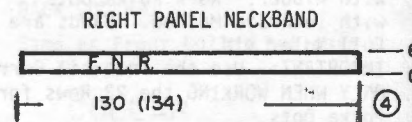
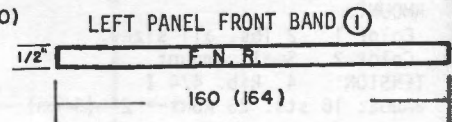
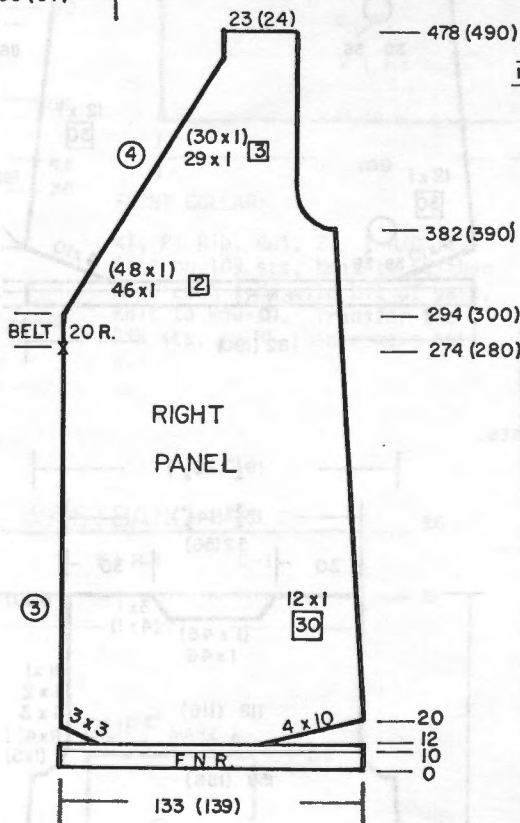

RIGHT PANEL NECKBAND:

FNR. Cast on 130 (134) sts. Knit 6 rows. Transfer Rib sts. to MB. Pick up sts. from NECK EDGE OF RIGHT PANEL (match No. 4 in circles). Knit 1 loose row then bind off.

RIGHT PANEL FRONT BAND:

FNR. Cast on 150 (154) sts. Knit 6 rows. Transfer Rib sts. to MB. Pick up sts. along RIGHT PANEL FRONT EDGE (match No. 3 in circles). Knit 1 loose row then bind off.

NOTE: Please not on Chart that approximately 20 rows are allowed for placement of Belt. Be sure Right Panel front band is attached below this point.

BELT:

FNR. Cast on 20 sts. Knit 50 rows. Bind off and attach to RIGHT PANEL FRONT EDGE (See Chart and Picture).

FINISHING: See General Instructions Trim each sleeve with 3 buttons. Attach 2 1/4" Belt Buckle to Belt. Sew a small snap fastener to inside of right side Panel. (See Photo).

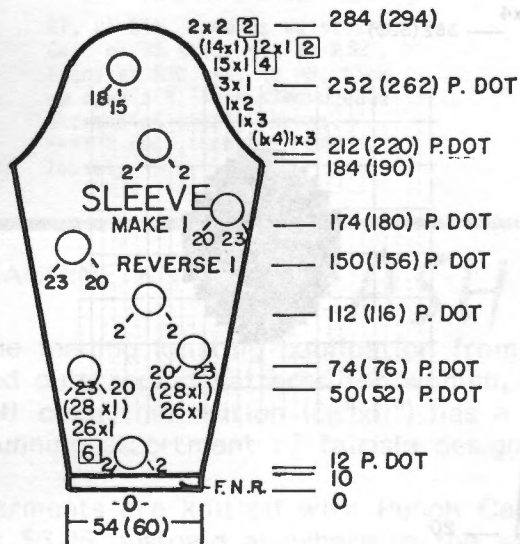

SLEEVES: Make 1, REVERSE 1

FNR. Cast on 54 (60) sts. Knit 10 rows. Transfer Rib sts. to MB. Knit 2 rows St. st. Begin Intarsia method for first Polka Dot. Follow Chart for placement of remaining Polka Dots. Also NOTE THE NUMBERS shown designate NEEDLE NUMBERS, either to the right or left of 0. AT THE SAME TIME, after Row 16, ON EACH SIDE, increase 1 st. every 6th row 26x (28x). After R 184 (190), SHAPE CAP: Please follow the Chart for shaping of sleeve Cap. After Row 284 (294) bind off the remaining sts.

536



WOMENS DRESS

SIZES: 8/10 (12/14)
 YARN: Venetia = Col. 1
 Mami Rex = Col. 2

AMOUNT:
 Col. 1 22 oz. 24 oz.
 Col. 2 1 spool all sizes.
 Sequins & Beads optional.

TENSION: 6
 GAUGE: 15 sts. 23 Rows = 2" (5 cm)

Make on any Punch Card or Electronic machine. Lace is isolated.

IMPORTANT: When working the isolated Lace Pat. the needles ON EACH SIDE OF CENTER must be pushed back to WP manually BEFORE using the Lace Carriage to transfer sts. (SEE CHART).

BACK/FRONT: The same.

With WY cast on 180 (188) sts. Knit several rows ending with 1 row with Ravel Cord from left to right. Change to Col. 1 and continue in St. st. Counter 0. Knit 24 rows. Transfer every 2nd st. to adjacent needle for Picot (you can use Lace Carriage to make the transfers) leave empty needles in WP. Continue St. st. and after Row 48, hang the hem. Knit to Row 100. ON EACH SIDE, dec. 1 st. every 20th row 9x, then 1 st. every 10th row 10x.

After R 300 (306) begin isolated Lace Pat. After Row 406 (414) DIVIDE FOR NECK. NOTE PAT. ROW Number. Put half the sts. on left into Holding position by knitting the sts. with a Ravel Cord back to A (non working) position and complete the the right side first.

*SHAPE ARMHOLE AND NECK AT THE SAME TIME. FOR ARMHOLE, bind off 3 sts. 3x, 2 sts. 2x (3x) and ON NECK SIDE, dec. 1 st. every 4th row 26x. After Row 500 (512) SHAPE SHOULDER: Bind off 8 sts. 4x (9 sts. 2x, 8 sts. 2x). Carefully bring the needles on the left into WP and remove Ravel Cord. Be sure sts. are in hooks of Ndis. Turn Row Counter back to 406 (414). Set to correct Pat Row and complete left half. Follow instructions from *.

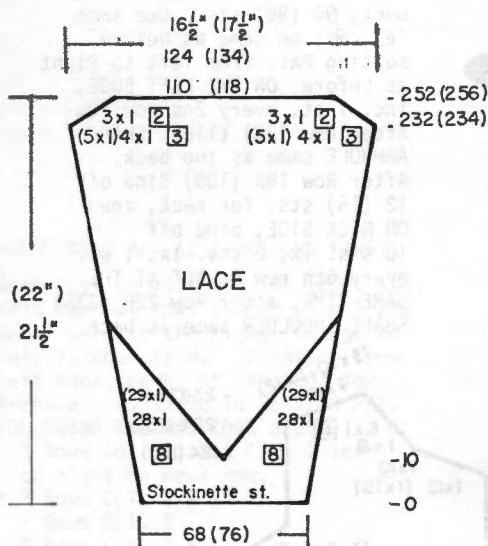

SLEEVES:

OPEN CAST ON WITH WY same as for front and back. Change to Col. 1. ON EACH SIDE, inc. 1 st. every 8th row 28x (29x) BUT AT THE SAME TIME, after Row 10, begin the Isolated Lace Pat. (SEE CHART). After R 232 (234) ON EACH SIDE, bind off 1 st. every 3rd row 4x (5x) then 1 st. every 2nd row 3x. After Row 252 (256) bind off the remaining sts.

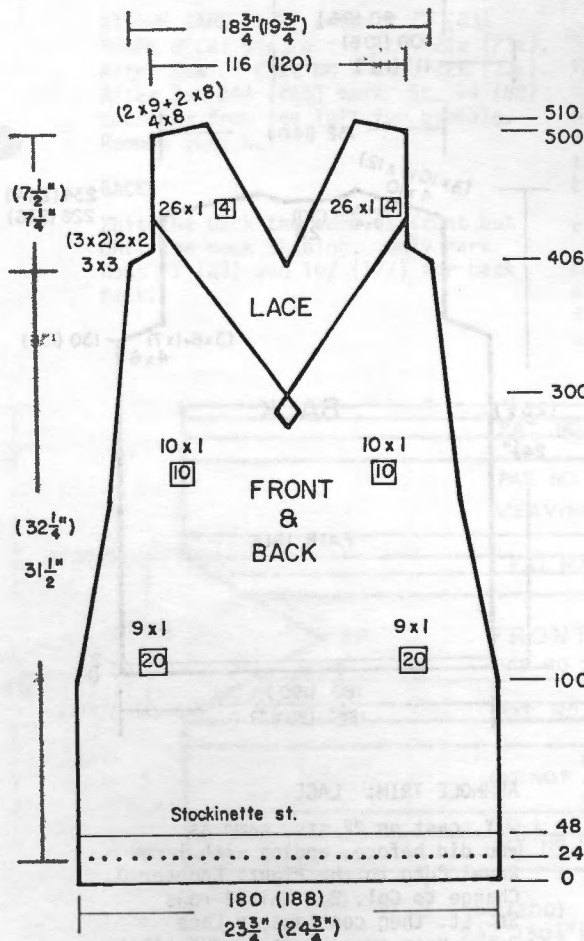
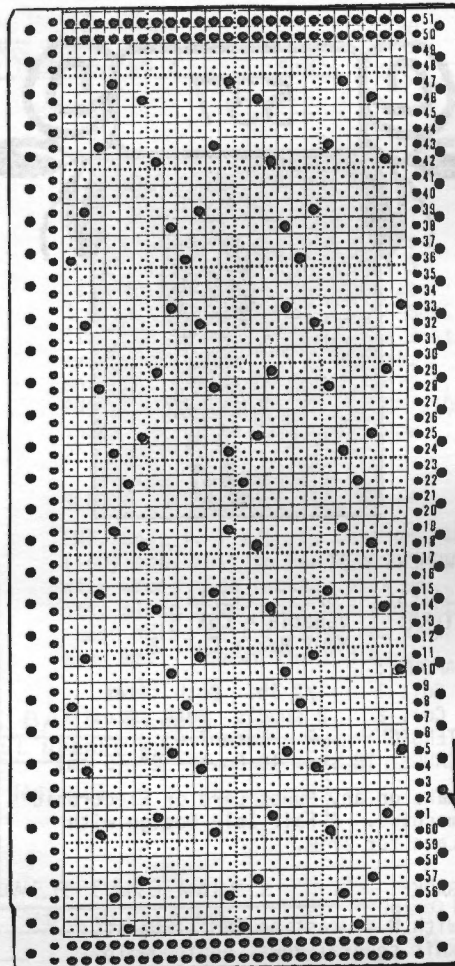

— 510 (522)
 — 500 (512)

— 406 (414)

— 300 (306)



FINISHING:

See General Instructions. With 2 strands of Col. 1, work 1 row slip stitch crochet around sleeve edge, then with 1 strd. Mami Rex, work 4 rows slip st. Work slip st. around neck opening in the same way except work 5 rows Mami Rex. Bead and Sequin trim is optional. In center of each diamond, on Bodice only, sew on 1 sequin and 3 Bugle beads.



FRONT: Make 1, reverse 1.

With W.Y. cast on same as for back, 90 (96) sts. Use same 'e' cast on same as before setting Pat. from left to Right as before. ON THE LEFT EDGE, inc. 1 st. every 2nd row 10x. After Row 130 (136), SHAPE ARMHOLE same as the back. After Row 183 (189) Bind off 12 (15) sts. for neck, then ON NECK SIDE, bind off 10 sts. 1x, 8 sts. 1x, 1 st. every 6th row 6x BUT AT THE SAME TIME, after Row 226 (236) SHAPE SHOULDER same as back.

EDGE TRIM: LACE.

W.Y. cast on 22 sts. same as before, end 1 row Ravel Cord to the right. Counter 0. Change to Col. 2. Knit 2 rows St. st. then continue in Lace Pat. Knit approximately 3 yards. Remove on W.Y.

EDGE TRIM



LACE TRIM



22 = 20

WOMENS VEST

SIZES: 8/10 (12/14)
YARN: Venetia = Col 1
Mami Rex = Col. 2

AMOUNT:
Col. 1 1/2 lb. Both sizes.
Col. 2 2 spools Both sizes.
TENSION: 7 Lace T 4
GAUGE: 18 sts. 19 Rows = 2" (5 cm)

Make on any Punch Card or Electronic machine. A Fair Isle Design with Lace for Trim.

BACK:

With W.Y. cast on 180 (190) sts. Knit several Rows. ending with 1 row Ravel Cord to the right. Bring needles to E position and with Col. 1 'e' cast on from left to right. Counter 0. Knit 1 row to the left then set for Fair Isle Pat. from left to right. Continue in Pat. to R 130 (136). SHAPE ARMHOLE: ON EACH SIDE, bind off 6 sts. 4x, (7 sts. 1x, 6 sts. 3x). Knit to Row 226 (236). Bind off the center 28 (30) sts. for Neck. Mark Pat. Row number. Put the Ndl. on the left into HP and complete right side first. *SHAPE SHOULDER AND NECK AT THE SAME TIME. For SHOULDER, bind off 10 sts. 4x (10 sts. 3x, 12 sts. 1x) and ON NECK SIDE, bind off 4 sts. 3x (6 sts. 1x, 4 sts. 2x).. Bring the Ndl. on left into WP Turn Row Counter back to 226 (236) Set Pat. to correct Row number and complete left half. Follow instructions from *.

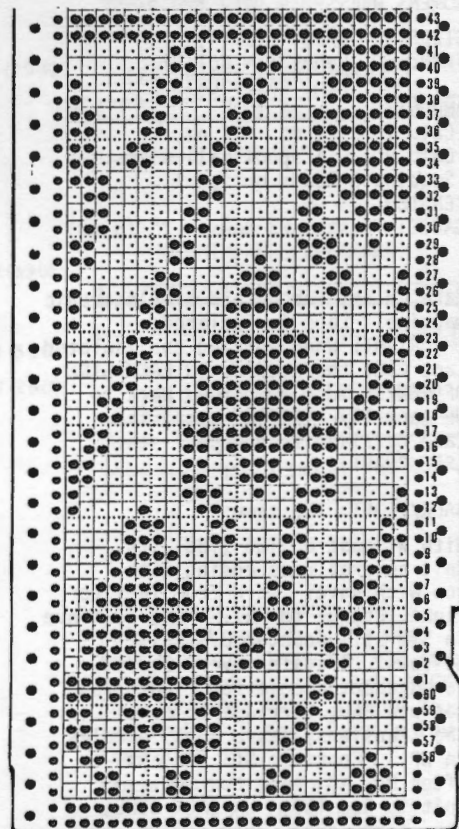
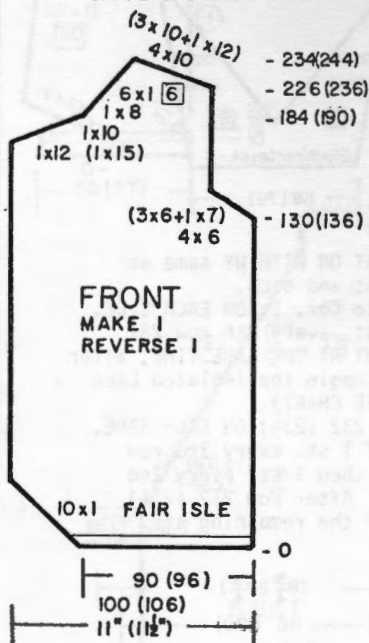

SLEEVE TRIM

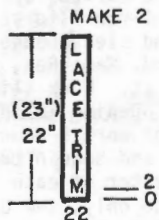

ARMHOLE TRIM: LACE.

W.Y. cast on 22 sts. same as you did before, ending with 1 row Ravel Cord to the right. Counter 0. Change to Col. 2. Knit 2 rows St. st. then continue in Lace Pat. Knit approximately 22" (23") then remove on W.Y.

FINISHING:

Close BOTH shoulders. With knit side facing, sew Lace Trim to outer edge of garment. Fold to inside and sew in place. We lined our Vest to cover the floats. If you wish to line yours, you will need 1 1/2 yards of lining material (36" wide). Before closing shoulders or seams, make Pat. from sections, allowing 1/2" to 5/8" for seams. Sew seams and insert lining. Fold edges of lining and sew in place.

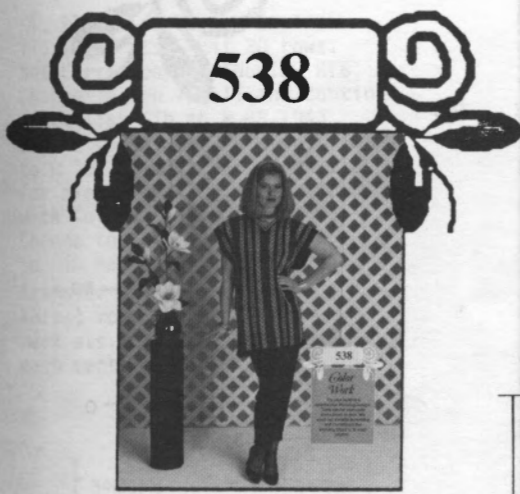
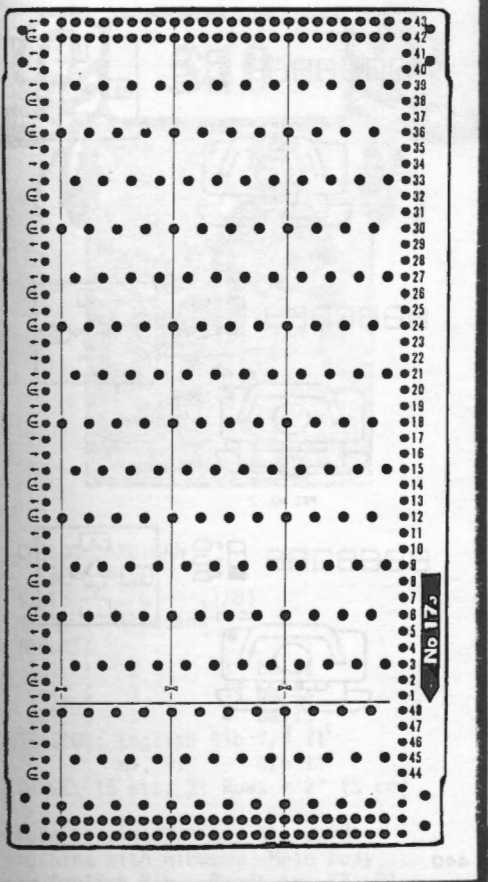

WOMENS TUNIC
SIZES: 12/14 (16/18)
YARN: Venetia = Col. 1
 Cordella = Col. 2, 3, 4.
AMOUNT:
 Col. 1 1 lb. 1 1/4 lb.
 Col. 2, 3, 4. 1 Ball each Col.
TENSION: 6 Rib, 5/5 II(900 Meth)
GAUGE: 13 sts. 22 Rows = 2" (5 cm)
 Make on any machine with Weaving Controls and Ribber. Bands are FNR. The purl side is right side.

NECK BAND MAKE 1

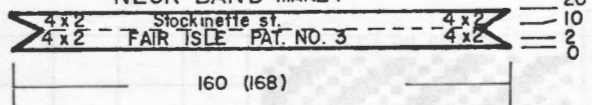

NECKBAND:

OPEN CAST ON with W.Y. same as for front and back. 160 (168) sts. Change to Col. 1 and knit 1 row. Set for Fair Isle Pat 3 left to Right. Continue in Pat 3 with Col. 1 & 2 and AT THE SAME TIME, ON EACH SIDE, decrease 2 sts. every 2nd row 4x. Cancel Pat. and continue St. st. with Col. 1 AND AT THE SAME TIME, ON EACH SIDE, increase 2 sts. 4x. After Row 20, remove onto W.Y.

SLEEVE BANDS: Close shoulders.

FNR, Col. 1. T 5/5 II. Cast on 148 (160) sts. Knit to Row 20. With wrong side facing, pick up sts. along lower edge and hang onto these Ndls. Knit 1 loose row then bind off. Repeat for 2nd band.

FRONT:READ ALL INSTRUCTIONS FIRST.

OPEN cast on with WY, 196 (200) sts. Knit several rows ending with 1 row Ravel Cord to the right. Change to Col. 1. Counter 0. Counting from left edge, mark St. 74 (80) for Armhole. Continue in WEAVING PAT. FOLLOWING INSTRUCTIONS BELOW.

- 3 Rows Col. 1, Set Pat. 1 left to right on next row.
- * 3 Rows Col. 1 & 2
- 2 Rows Col. 1
- 3 Rows Col. 1 & 2
- Stop Pat. 1
- 9 (11) Rows Col. 1. Set Pat. 2 left to right on next row.
- 11 Row Col. 1 & 3
- 2 Rows Col. 1
- 22 Rows Col. 1 & 4
- 2 Rows Col. 1
- 11 Rows Col 1 & 3
- Stop Pat. 2.
- 9 (11) rows Col 1. Set Pat. 1 left to right on next row.
- REPEAT FROM * 2x MORE, then
- REPEAT Pat. 1 1x MORE.
- 4 (6) rows Col. 1

SLEEVE BAND MAKE 2

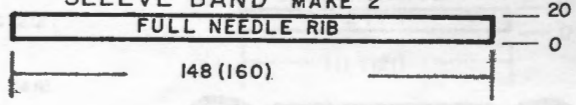

LOWER BAND MAKE 2

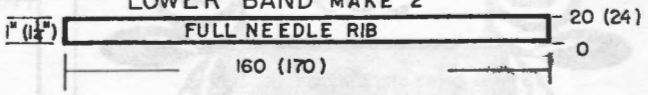

AT THE SAME TIME, after R 77 (83) SHAPE NECK: Bind off 2 sts. 22x (23x). After Row Cast on 2 sts. 22x (23x). After Row 244 (260) mark St. 74 (80) counting from the left for armhole. Remove onto W.Y.

LOWER BANDS: Make 2. T 5/5 II

FNR, Col. 1. Cast on 160 (170) sts. Knit to Row 20 (24). With wrong side facing, pick up sts. along lower edge and hang onto these Ndls. Knit 1 loose row then bind off.

BACK:

Knit the back the same as front but OMIT the neck shaping. Only mark Rows 77 (83) and 167 (177) for back neck.

FINISHING:

Fold Neckband in half, then weave around Neck edge with points at center front. Weave the open sts. of front and back together at sides.

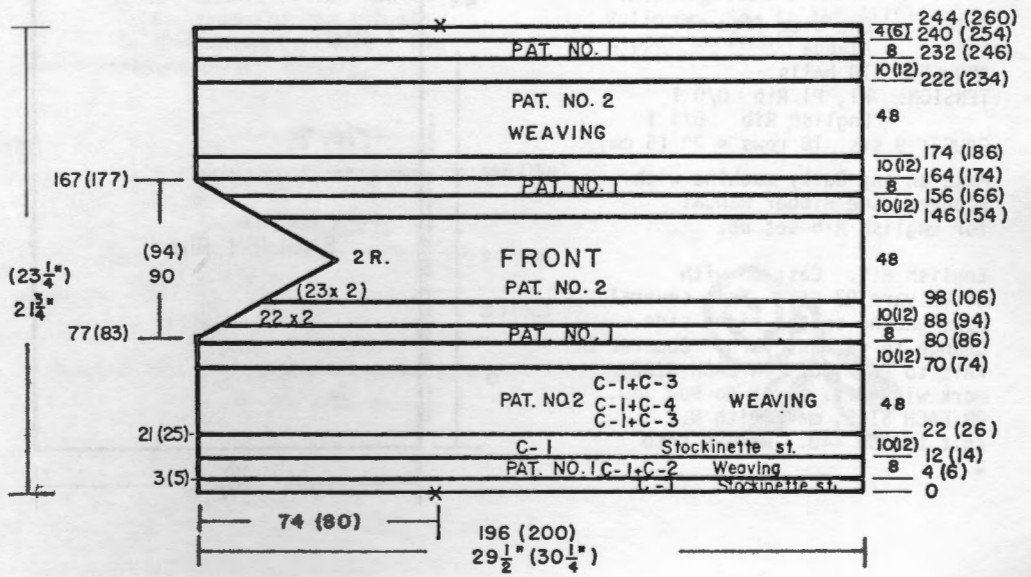

CONTINUED

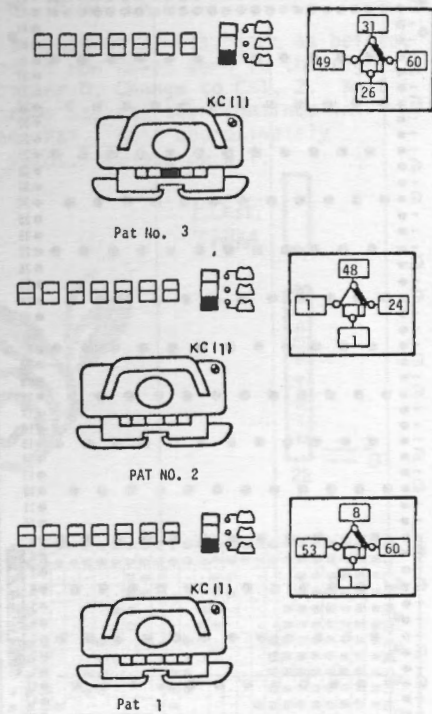
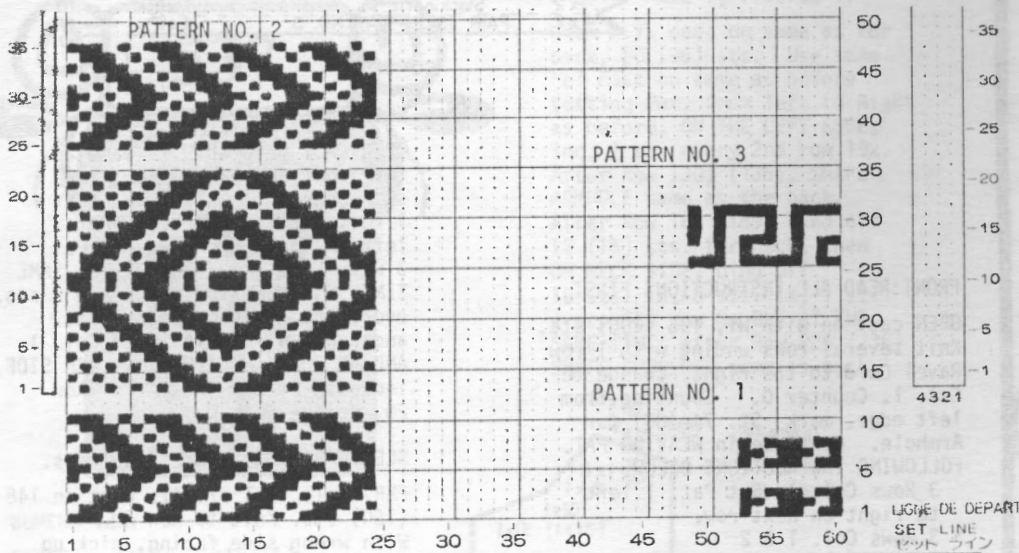

WOMENS SHRUG

SIZES: One size fits all
YARN: Alanda
AMOUNT: 10 balls
TENSION: K1, P1 Rib 0/0 I
 English Rib 6/4 I
GAUGE: 9 sts. 18 rows = 2" (5 cm)

Make on any Bulky machine with Ribber. See Ribber Manual for English Rib set up.

English Rib. Cast on with waste yarn 93 sts. Knit several Rows ending on the right side. Change to garment yarn. Counter 0. Knit to Row 100. ON EACH SIDE, mark with W.Y. Knit to Row 340. ON EACH SIDE, mark with W.Y. Knit to Row 440. Remove onto W.Y.

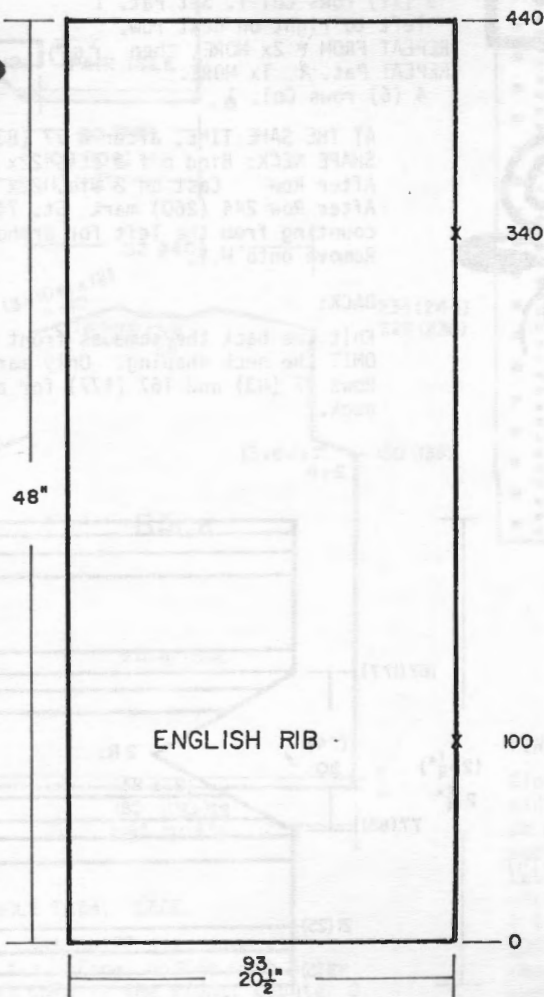

ENGLISH RIB

93
20 1/2

440

340

100

0



CUFF MAKE 2

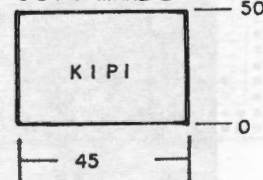

CUFFS: Make 2.

K1, P1 Rib. Cast on 45 sts. Knit to Row 50. Transfer the Ribber sts. to MB. With wrong side facing, hang open sts. from one end onto these Ndl. decreasing evenly across. (approximately 3 sts. on each Ndl.) Carefully knit 1 loose row then bind off. REPEAT FOR OTHER END of Shrug.

FINISHING: Beginning at Cuff end, sew sides together up to W.Y. marker. Repeat on other end.

540



FRONT: Make 1, reverse 1.

K1, P1 Rib. Col. 4. Cast on 59 (63) sts. Knit 20 rows. Set for English Rib and knit to Row 88 (94). Change to Col. 1 and knit to Row 134 (148). Change to Col. 5. Knit to Row 201 (211) ON NECK SIDE, bind off 15 sts. then on every 3rd row, bind off 2 sts. 5x (6x).

After Row 224 (238) remove the sts. on W.Y.

After Row 224 (238), transfer the Rib sts. to MB. Knit 1 row then remove the sts. on W.Y.

CUFFS:

K1, P1 Rib. Cast on 59 (63) sts. with color 4. Knit 20 rows, transfer Rib sts. to MB. with wrong side facing, pick up open sts. of sleeve, decreasing evenly across. Knit 1 row, then bind off loosely.

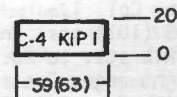

CHILDS CARDIGAN

SIZES: 5/6 (7/8)

YARN: Alpacana

AMOUNT:

Col. 1 2 3 balls

Col. 4 3 4 balls

Col. 5 3 4 balls

TENSION: English Rib 7/7 II

K1, P1 6/6 II

GAUGE: 15 sts. 31 Rows = 2" (5 cm)

Make Cardigan on any Standard machine with Ribber. Main body is English Rib. Bands are K1, P1 Ribbing.

BACK:

K1, P1 Rib. Col. 4. Cast on 115 (123) sts. Knit 20 rows. Set Carriages for ENGLISH RIB. Change to Ten 7/7 II and continue in English Rib to R 88 (94). Change to Col. 1. Continue in Pat. to R 134 (140). Mark each side for sleeve opening. Continue with Col. 1 to Row 138 (148). Change to Col. 5 and continue in Rib Pat. to Row 224 (238). Transfer the Rib. st. to MB. Knit 1 row. ON EACH SIDE, mark sts. for SHOULDER. Remove each section onto W.Y.

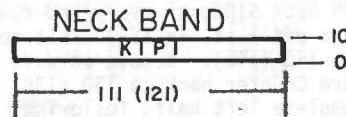
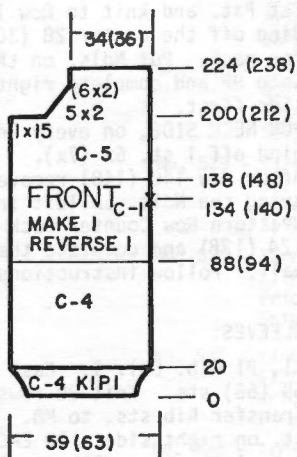

NECKBAND:

Close shoulders same as for Pullover finishing instructions. K1, P1 Rib. With Col. 5, cast on 111 (121) sts. Knit 10 rows. With wrong side facing, hang the open sts. of neck onto these Ndl's. Knit 1 row then bind off.

SLEEVES:

ENGLISH RIB: With waste yarn, cast on 109 (117) sts. Knit several rows then change to Color 4. Continue in English Rib, changing colors as shown on the Chart. After Row 148 (154), transfer the rib sts. to main machine. Knit 1 row then bind off loosely.

FINISHING:

See General Instructions. For closing shoulders, see Finishing instructions for Pullover. Sew in 16" (17") zipper on front.

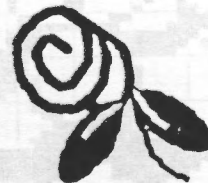
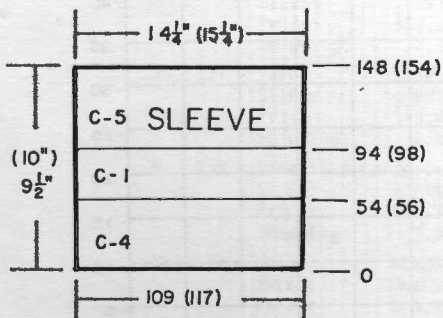
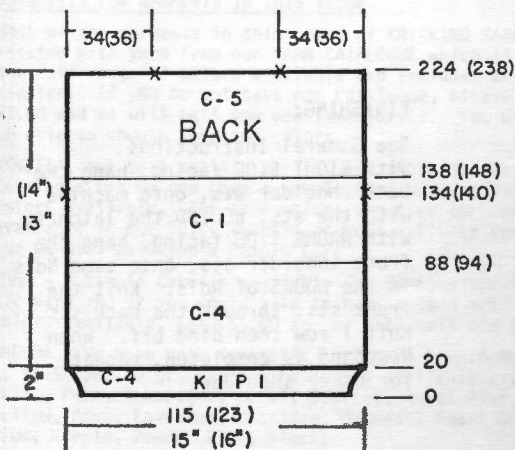

CONTINUED

CHILDS PULLOVER

SIZES: 5/6 (7/8)

YARN: Alpacana

AMOUNT:

- Col. 1 4 5 balls
- Col. 2 1 1 ball
- Col. 3 Small amount.

TENSION: St.st. 9 K1, P1 6/6 II

GAUGE: 13 sts. 17 Rows = 2" (5 cm)

Made on any Electronic machine with Ribber. Pattern is knitted DOUBLE WIDTH and DOUBLE LENGTH and is a Single Motif on front section.

BACK:

K1, P1 Rib. Col. 1.

Cast on 95 (101) sts. Knit 20 Rows. Transfer Rib sts. to MB. Add 1 st. on the right edge. Continue in St. st. with Ten. 9 to Row 88 (92). Mark each side for Sleeve opening. Knit to Row 130 (136). BACK NECK SHAPING: Bind off the center 32 (34) sts. Put Ndl. on left into HP and complete right side first.

*ON NECK SIDE, on every 2nd row, bind off 1 st. 4x (5x). Knit to Row 140 (148). Remove on W.Y. Turn Counter back to 130 (136) and complete left half, following instructions from *. After Row 140 (148) remove on W.Y.

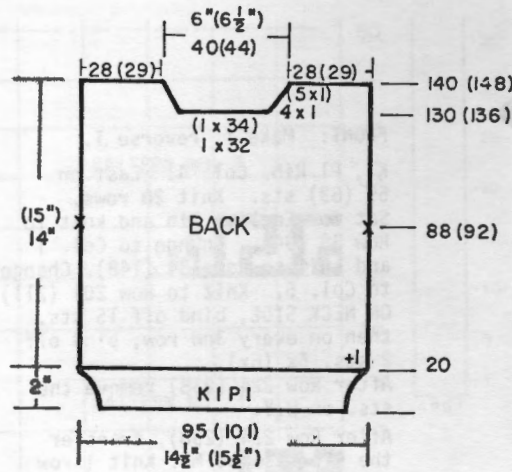

FRONT:

Work front same as back to R 21. Set Pat. and knit to Row 124 (128). Bind off the center 28 (30) sts. for neck. Put Ndl. on the left into HP and complete right side first.

*ON NECK SIDE, on every 2nd row, bind off 1 st. 6x (7x). After Row 140 (148) remove on W.Y. Bring the Ndl. on left into WP, turn Row Counter back to 124 (128) and complete the left half. Follow instructions from *.

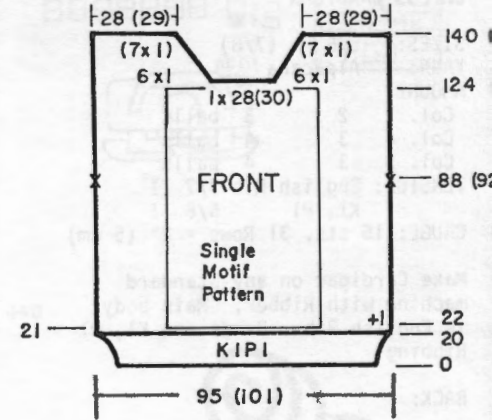

SLEEVES:

K1, P1 Rib. Col. 1. Cast on 59 (65) sts. Knit 20 rows. Transfer Rib sts. to MB. Add 1 st. on right side. ON EACH SIDE, inc. 1 st. every 9th row 10x. Knit to R 114 (118). Bind off or remove onto W.Y.

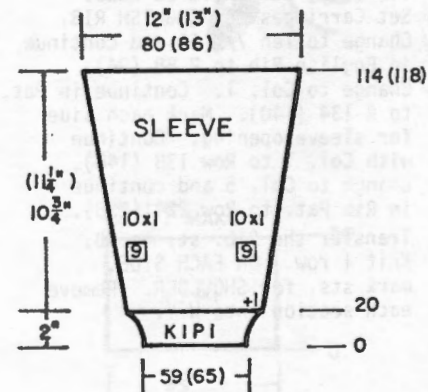

FINISHING:

See General Instructions. With RIGHT SIDE facing, hang the back shoulder sts. onto machine with the sts. BEHIND the latches. With WRONG SIDE facing, hang the front shoulder sts. onto same Ndl. in the HOOKS of Ndl. Knit the front sts. through the back sts. Knit 1 row then bind off. When Neckband is completed, repeat for other shoulder.

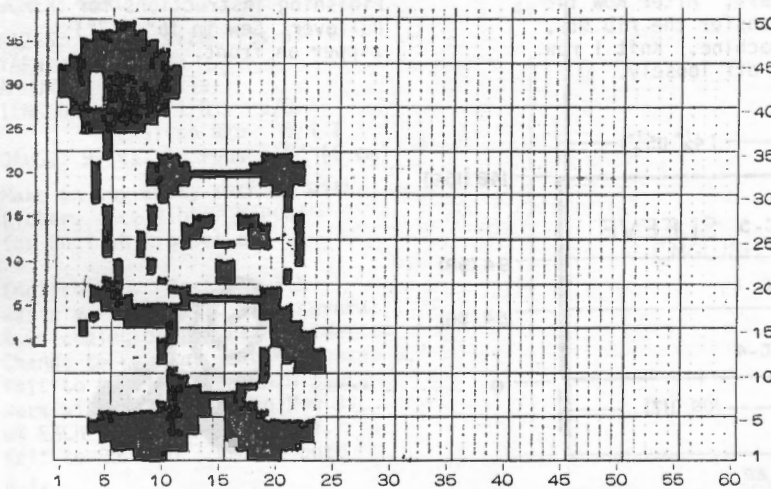
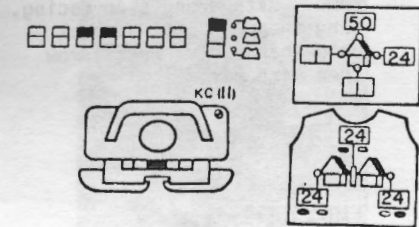

KnitKING News

VOLUME 20 NO. 3

PRACTICAL KNITTING HINTS

IMPORTANT: WE NEED TO SAVE SPACE.

Beginning with this issue of KNITKING MAGAZINE, we are changing over to the use of SYMBOLS to abbreviate some of the standard words or expressions used frequently in the instructions. This should save space and you will note there are a few other changes, all to your advantage. Please refer to CODE FOR SYMBOLS which will always be on Page 13 in every issue. We believe you will like it all.

GARTER CARRIAGE - ROWS ON CHARTS used in combination with GARTER CARRIAGE ROWS

When you are using the KG 88 or KG 89 Garter Carriage, the Charts show rows for the knitting of garment, so you begin with your Counter at 0 and it advances to the Row Number at completion of a section. The GARTER CARRIAGE, is ALWAYS SET for the number of rows needed to a specific point and the Row Counter works backwards to 0 and then stops. Do not ignore the machine Row Counter, use BOTH COUNTERS.

SHORT ROWS ON EVERY ROW - Set Controls to Hold Needles placed in Holding Pos.

Pattern 534 in this issue of KNITKING MAGAZINE, has SHORT ROWS MADE ON EVERY ROW. Our KNITTING TECHNIQUE Book, pages 45 and 47 show drawings for both INCREASE and DECREASE Short Rows ON EVERY ROW. We recommend this excellent book. Its price is normally \$23.95, its Sale Price \$19.95 with Shipping costs \$1.25. Do practice the following technique before you attempt this different garment.

DECREASE SHORT ROWS ON EVERY ROW

ON OPPOSITE SIDE OF CARR. bring required number of Ndl. to HP. Knit across, wrap inside Ndl. in HP. *ON SAME SIDE AS CARR. bring required Ndl. to HP. Pass the yarn OVER and UNDER the Ndl. in HP. and bring the required Ndl. OPPOSITE CARR to HP. and knit across. REPEAT FROM * ON EVERY ROW.

INCREASE SHORT ROWS ON EVERY ROW

*ON SAME SIDE AS CARR. push the required number of Ndl. in HP to WP. Pass the yarn OVER and UNDER THESE Ndl. AT THE SAME TIME, ON OPPOSITE SIDE OF CARR. push back the required number of Ndl. from HP to WP. Knit across. REPEAT FROM *.

PRACTICAL KNITTING HINTS - VOLUME 20 No. 3

YARN KITS FOR GARMENTS IN THIS ISSUE

Most of the garments in this issue of KNITKING MAGAZINE were knitted with yarn from our YARN CATALOGUE which illustrates the full range of colors available and includes actual samples. If you do not have our Catalogue, please send \$3.00 and we will mail you one immediately. You will then be able to choose your own colors.

VENETIA, our best selling yarn is not shown in the above Catalogue but we now have a Sample Card showing all the colors available. The same colors shown on the card are available in our Bulky Venetia as well. Please send \$1.00 and we will mail you a Sample Card

ROMA - A Sample Card is available for ROMA, a lovely synthetic yarn and if you would like to have a card with all the colors available, send \$1.00 and we will mail one to you.

ANGORA - We have some fantastic 100% pure French Angora at \$6.50 per 10 gr. ball. The colors available are: White, Pink, Champagne, Coral, Scarlet, Royal Blue, Canary Yellow, Aqua, Lavender, Orchidee, Oatmeal, Pearl Grey, Plum, Purple, Powder Blue, Black.

- | | | | |
|-------------------|----------------------------------|----------|---------|
| No. 521 - Yarn: | Bulky Venetia, Angora, Capriccio | | |
| SIZES: | One Size Fits All | | |
| Price: | \$92.41 | | |
| Shipping: | 3.50 | | |
| No. 522 - Yarn: | Bulky Venetia & Rainbow Metallic | | |
| SIZES: | 6/8 | (10/12) | [14/16] |
| Price: | \$27.51 | \$27.51 | \$27.51 |
| Shipping: | 2.50 | 2.50 | 2.50 |
| No. 523 - Yarn: | Bulky Venetia | | |
| SIZES: | 6/8 | (10/12) | [14] |
| Price: | \$40.26 | \$42.24 | \$44.22 |
| Shipping: | 2.50 | 2.50 | 3.00 |
| No. 524 - Yarn: | Bulky Venetia & Angora | | |
| SIZES: | 8/10 | (12/14) | |
| Price: | \$64.68 | \$64.68 | |
| Shipping: | 4.00 | 4.00 | |
| No. 525 - Yarn: | Bulky Venetia | | |
| SIZES: | Small | (Medium) | [Large] |
| Price: | \$31.68 | \$31.68 | \$31.68 |
| Shipping: | 2.50 | 2.50 | 2.50 |
| No. 526 - Yarn: | Bulky Venetia & Rainbow Metallic | | |
| SIZES: | 6/8 | (10/12) | [14] |
| Price: | \$35.70 | \$39.66 | \$43.62 |
| Shipping: | 3.50 | 3.50 | 4.00 |
| No. 527 - Yarn: | Venetia & Angora | | |
| SIZES: | 8/10 | (12/14) | |
| Price: | \$69.52 | \$69.52 | |
| Shipping: | 4.50 | 4.50 | |
| No. 528 - Yarn: | Bulky Venetia & Nubby Tweed | | |
| SIZES: | 4/6 | (8/10) | [12/14] |
| Price: | \$27.95 | \$27.95 | \$35.63 |
| Shipping: | 3.50 | 3.50 | 3.50 |
| No. 529 - Yarn: | Roma & Amore | | |
| SIZES: | One Size Fits All | | |
| Price: | \$29.25 | | |
| Shipping: | 3.50 | | |
| No. 530 - Yarn: | Alpacana | | |
| SIZES: | Medium | (Large) | |
| Price: | \$36.40 | \$41.60 | |
| Shipping: | 2.50 | 2.50 | |
| No. 531 - Yarn: | Alanda & Cordella | | |
| SIZES: | 10/12 | (14/16) | |
| Price: | \$17.99 | \$19.59 | |
| Shipping: | 1.85 | 1.85 | |
| No. 532 - Yarn: | Venetia | | |
| SIZES: | 38/40 | (42/44) | |
| Price: | \$19.80 | \$19.80 | |
| Shipping: | 2.50 | 2.50 | |
| No. 533 - Yarn: | Bulky Venetia & Angora | | |
| SIZES: | One Size Fits All | | |
| Price: | \$126.93 | | |
| Shipping: | 5.50 | | |
| No. 534 - Yarn: | Mohair & Angora | | |
| SIZES: | Medium/Large | | |
| Price: | \$113.24 | | |
| Shipping: | 5.50 | | |
| No. 535 - Yarn: | Venetia | | |
| SIZES: | 8.10 | (12/14) | |
| Price: | \$33.66 | \$33.66 | |
| Shipping: | 3.50 | 3.50 | |
| No. 536 - Yarn: | Venetia & Mami Rex | | |
| SIZES: | 8/10 | (12/14) | |
| Price: | \$27.53 | \$27.53 | |
| Shipping: | 2.50 | 2.50 | |
| No. 537 - Yarn: | Venetia & Mami Rex | | |
| SIZES: | 8/10 | (12/14) | |
| Price: | \$19.42 | \$19.42 | |
| Shipping: | 2.50 | 2.50 | |
| No. 538 - Yarn: | Venetia & Cordella | | |
| SIZES: | 12/14 | (16/18) | |
| Price: | \$25.77 | \$25.77 | |
| Shipping: | 3.00 | 3.00 | |
| No. 539 - Yarn: | Alanda | | |
| SIZES: | One Size Fits All | | |
| Price: | \$16.00 | | |
| Shipping: | 2.50 | | |
| No. 540 A - Yarn: | Alpacana | | |
| SIZES: | 5/6 | (7/8) | |
| Price: | \$15.60 | \$15.60 | |
| Shipping: | 2.50 | 2.50 | |
| No. 540 B - Yarn: | Alpacana | | |
| SIZES: | 5/6 | (7/8) | |
| Price: | \$20.80 | \$28.60 | |
| Shipping: | 2.50 | 2.50 | |

Essentials...

Order from your local Dealer or direct from
KNITKING—1128 Crenshaw Blvd.,
 Los Angeles, California 90019

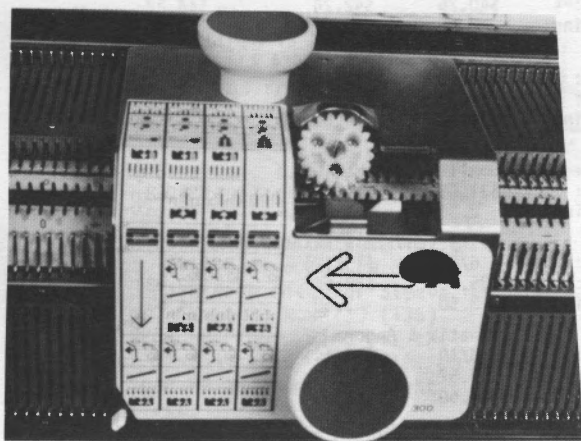

For fast and accurate transfer of stitches from Ribber to Knitter, the Automatic Transfer Carriage is **ESSENTIAL**.

Model 8300 is for Ribbers KR 900, KR 880, KR 850 and KR 830 and machine Models KR 830 through KH 910.

The PM 10 Automatic Punch Card puncher is essential for speedy punching of all your punch card designs. It's O.K. for all **KNITKING**, Singer, Studio and Toyota punch card machines except the Singer/Studio F-370 machine which uses the PM 70 Automatic Puncher.

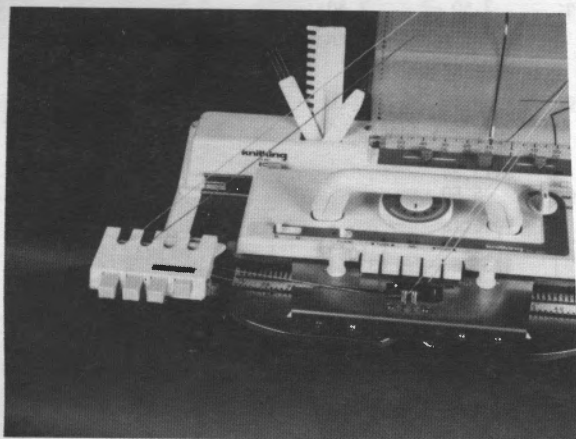
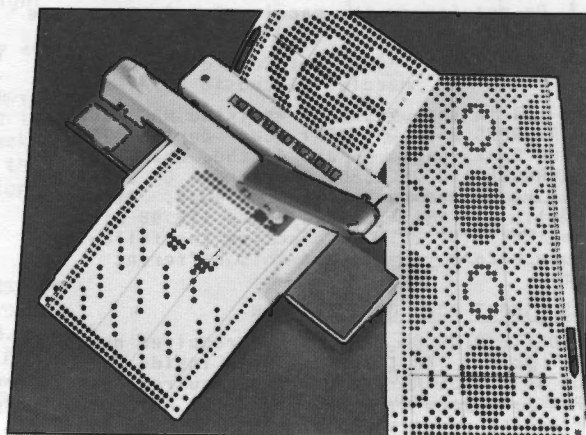

The KHC 820 Color Changer is essential for automatic changing of colors when knitting on **KNITKING** machine Models KH 820 through KH 910.

The KRC 830 Color Changer is essential for automatic color changing and the knitting of four color designs when using a Knitter and Ribber combination. It operates on Models KH 820 through KH 910 with Ribbing Attachment.

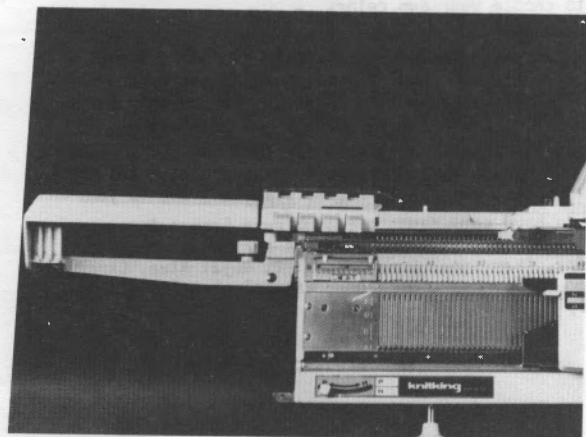

NEW, DEMONSTRATOR AND TRADED MACHINES AT GIVE AWAY PRICES. . .

Nobody can beat our prices, so if you want a second machine, place your order as fast as possible... Maybe you have a friend who cannot afford a brand new machine... If so, please tell her about our low, low prices... and if you want a machine not listed below, let us know... We have too many to list them all. All Prices F.O.B. Los Angeles. Shipment via U.P.S.

| KNITKING | | | | KNITKING | | | |
|-----------------|---|--------------------|------------|--|---|------------------|------------|
| | CONDITION | LIST PRICE | SALE PRICE | | CONDITION | LIST PRICE | SALE PRICE |
| KNITKING | | | | GARTER CARRIAGES | | | |
| KH 910 | COMPUKNIT ELECTRONIC W/Lacemaker, OK for use with KG 88 Garter Carr. (Demo-New Machine Guar.) | Like New \$ 999.95 | \$ 699.00 | KG 88 | Garter Carriage for KH 910, KH 881, KH 860 (Demo New Machine Guar.) | Like New 319.95 | 229.00 |
| KH 910 | COMPUKNIT ELECTRONIC W/Lacemaker - Same machine as listed above. | Very Good 999.95 | 599.00 | KG 89 | Garter Carriage for KH 891, 890 (Demo - New Machine Guar.) | Like New 309.95 | 229.00 |
| KH 910 | COMPUKNIT ELECTRONIC W/Lacemaker & Ribber (Demo-New Machine Guar.) | Like New 1299.90 | 849.00 | SILVER REED (Same as Singer/Studio) | | | |
| KH 891 | Punch Card Knitter W/built in Knitleader & Lacemaker. OK for use With KG 89 Garter Carr. (Demo-New Machine Guar.) | Like New 629.95 | 499.00 | SK 700 | New Model Punch Card Knitter and SRP 60 Ribber | New 949.00 | 649.00 |
| KH 891 | Punch Card Knitter with built in Knitleader, Lacemaker, & Ribber (Demo-New Machine Guar.) | Like New 929.90 | 649.00 | SINGER/STUDIO | | | |
| KH 260 | New Model Bulky Punch Card Knitter (Demo - New Machine Guar.) | Like New 629.95 | 449.00 | FK 370 | 250 Needle Knitter with FRP 70 Ribber * FK 370 Lacemaker - | Like New 1059.85 | 699.00 |
| KR 260 | Ribber | Like New 329.95 | 249.95 | SK 312 | Punch Card Knitter | Very Good 349.00 | 125.00 |
| KH 230 | Bulky- (Demo) | Like New 399.95 | 229.00 | TOYOTA | | | |
| KH 230 | Bulky -With Ribber | Excellent 699.90 | 350.00 | KS 787 | Punch Card Knitter with Lacemaker | Excellent 250.00 | |
| KH 710 | GENIE Push Button Pat. Selection | Like New 299.50 | 180.00 | KS 747 | Punch Card Knitter with Lacemaker and Ribber | Excellent 275.00 | |
| | | | | KS 727 | Punch Card Knitter | Excellent 125.00 | |

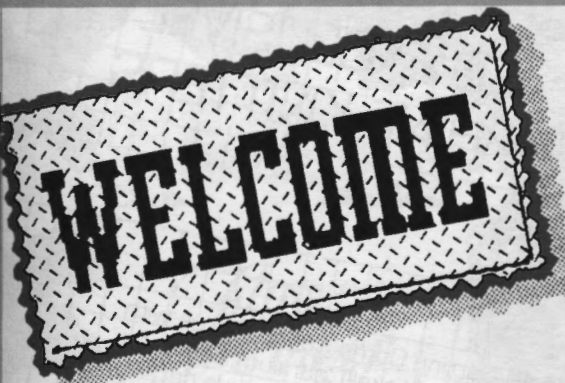

SEMINAR & OPEN HOUSE 1986

knitking

Among the teachers in attendance: Yukiko Mitsumata, Mary Louise Norman, Sara Brooks, Tami Noboyuki, Mary Nishizaki, Mitsi Tani, Eva Eisenstein and the team that makes the garments for KNITKING MAGAZINE.

September 15 through 20.

Join us! Our open house runs from September 15 through 20 and will be held at KNITKING, 1128 Crenshaw Blvd, Los Angeles, Calif. 90019.

Come and meet our experts along with many acknowledged guest authorities. You'll get to see great new products too!

Enjoy! You'll love our daily Fashion Show and Contest! Daily winners will receive prizes and are eligible for the finals and a GRAND PRIZE at the close of the seminar.

Win! All types of garments are eligible, so start knitting now! (Sorry, knitting machine dealers and employees of KNITKING not eligible)

It's Free! Just bring yourself and some friends and join us for prizes, events, and free coffee and doughnuts.

Our regular seminar visitors will tell you ours is the best, so remember to come and meet us here at

KNITKING

September 15 through 20.

knitking

KNITTING COMPUTER

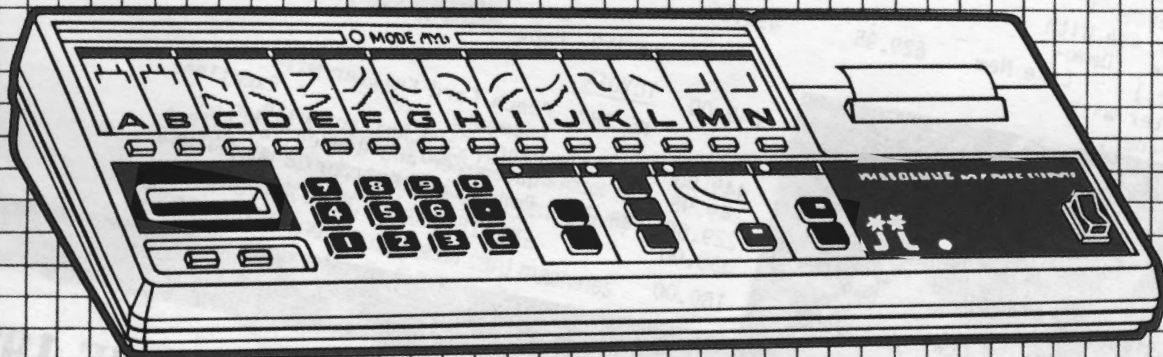

A UNIQUE SELF-CONTAINED
COMPUTER DESIGNED EXCLUSIVELY
FOR HAND AND MACHINE KNITTERS.

Every shape of garment sections, necklines, armholes, etc., is represented by a 'MODE' button. Push a Mode Button, program in your Stitch and Row Gauge, follow it with the Width and Length of the garment section, then watch the printer print out complete knitting instructions.

The Computing of knitting patterns can be done with standard computers plus expensive software, and you can easily spend thousands of dollars to obtain the same results as produced by the KNITKING Knitting Computer at a fraction of the price.

The KNITKING Knitting Computer operates with built in re-chargeable Nickel Cadmium Batteries.. A charger is standard equipment as is a detailed Instruction Manual and some spare rolls of print out tape.

Price: \$499.00 (California residents add Sales Tax)
Order from your local dealer or direct from

**KNITKING — 1128 Crenshaw Blvd.,
Los Angeles, CA 90019**



526

Flower Power

Isolated Flower Designs make an unusually pretty Sweater with peepholes at each side of center. It is easy to knit the Thread Lace on the bulky Punch Card Machine. Bulky Venetia with Rainbow Metallic for the Thread Lace. The bands are 1X1 Ribbing. Sizes 6 to 14.



532



His Choice

A man will always choose a classic Cardigan for special occasions and this one will be easy to knit on any standard machine with Ribber. Knit it with our Venetia yarn in sizes 38 to 44.





523



Best Bet

Head to the race track in this up to the minute Sweater and have a glorious day. Use Short Rows for the clever design and band the sleeves with fluffy Angora. Knit it on any bulky machine with 3 colors of bulky Venetia plus the Angora.





539

Chill Chaser

Everyone needs a soft cover up and when you knit one for yourself, friends will want one too. It is sometimes called a Shrug and makes a fantastic gift for all ages. Knit it with Alanda.





522

Easy Elegance

Combine Tuck knitting with a Thread Lace border for an easy and quick knit Shell. Wear it with pants, a skirt or under a Suit Jacket. Just two straight pieces knitted on a bulky Punch Card Machine. Take note of the new rolled edges used for trim at neckline, shoulders and armholes. The waistband is 1X1 ribbing. Bulky Venetia with Rainbow Metallic. Sizes are 6 to 16.





530



First Class

He'll never part with this great Sweater knitted in his favorite colors. It's a racking pattern knitted on Main Machine with Ribber. Bands are K2, P2. Use our Alpacana and knit it in sizes Medium, Large.



KNITKING KH 891 WITH KG 89 ELECTRIC CARRIAGE

Feed in a pattern stitch card. Set the row counter to a specific number of rows, then push the start button and you can leave to watch T.V. or cook the dinner, read a book, etc., while your knitter knits merrily along. When it has knitted the preset number of rows, it will switch itself off. If it runs out of yarn, it will switch itself off. The KG 89 Electric Carriage will knit an unlimited variety of fancy Garter Stitch designs in addition to standard ribs.

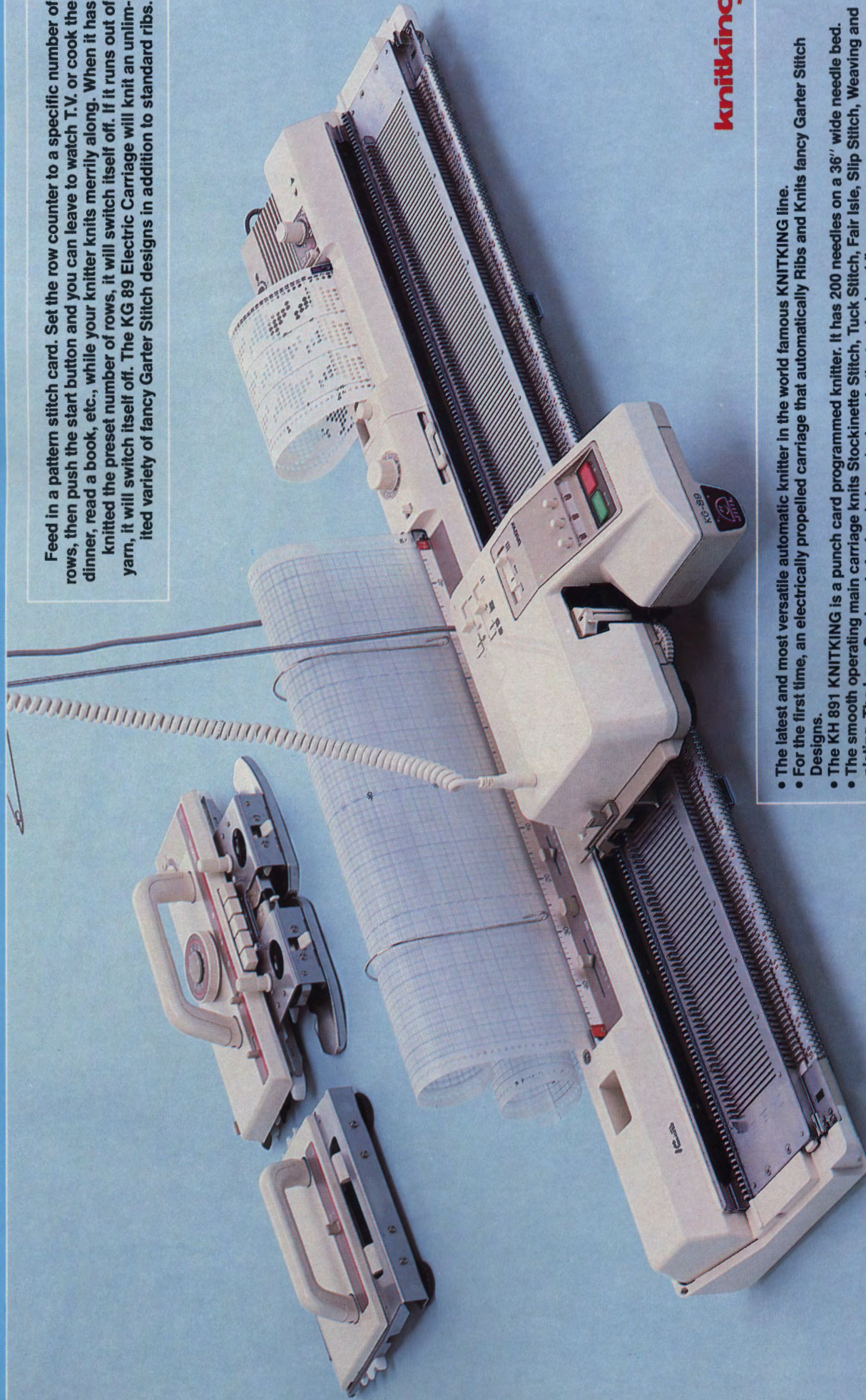

knitking

- The latest and most versatile automatic knitter in the world famous KNITKING line.
- For the first time, an electrically propelled carriage that automatically Knits fancy Garter Stitch Designs.
- The KH 891 KNITKING is a punch card programmed knitter. It has 200 needles on a 36" wide needle bed.
- The smooth operating main carriage knits Stockinette Stitch, Tuck Stitch, Fair Isle, Slip Stitch, Weaving and plating. The Lace Carriage is for lovely lace designs, both standard and fine.
- 20 Pre-Punched Pattern Cards for all types of pattern knitting are included with every machine. The built-in Knitleader Charting accessory tells you on a row by row basis when to increase and when to decrease. Simplifies the knitting of garments to accurate size.
- A complete kit of Tools, spare needles, cabling tools, lubricating oil and two, step by step Instruction Manuals with over 400 illustrations are included and there is a one year warranty on parts and service.

Order from your local dealer or direct from **KNITKING—1128 Crenshaw Blvd.**
Los Angeles, CA 90019

540

Fashion Duo

Made for a little girl, the cute Sweater has a Bear with Balloon on the front section.

The zippered Jacket is in large stripes of English Rib. It's made on the Electronic machine with Ribber. A small boy would like it too, in more masculine colors.

Sizes 4 to 10.



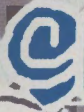

531



Dramatic Dragon

A Dragon covers the whole front of this boys handsome Pullover. The oriental lettering on the sleeve spells out the word Dragon.... A girl would also be delighted with it or she may steal her brother's. Knit it on any Electronic machine using Alanda and Cordella. Sizes 10 to 16.



529

WrapUp

Knit an elegant Robe for your man to wear at his leisure. Make it on any standard Punch Card machine with a Fair Isle Design border trim. Belt it with a twisted cord. Roma and Amore for the yarn and one size will fit most anyone with exception of the length which you can shorten or lengthen as needed.



KNITKING Punch Card Programmed Bulky with KR 260 Ribbing Attachment

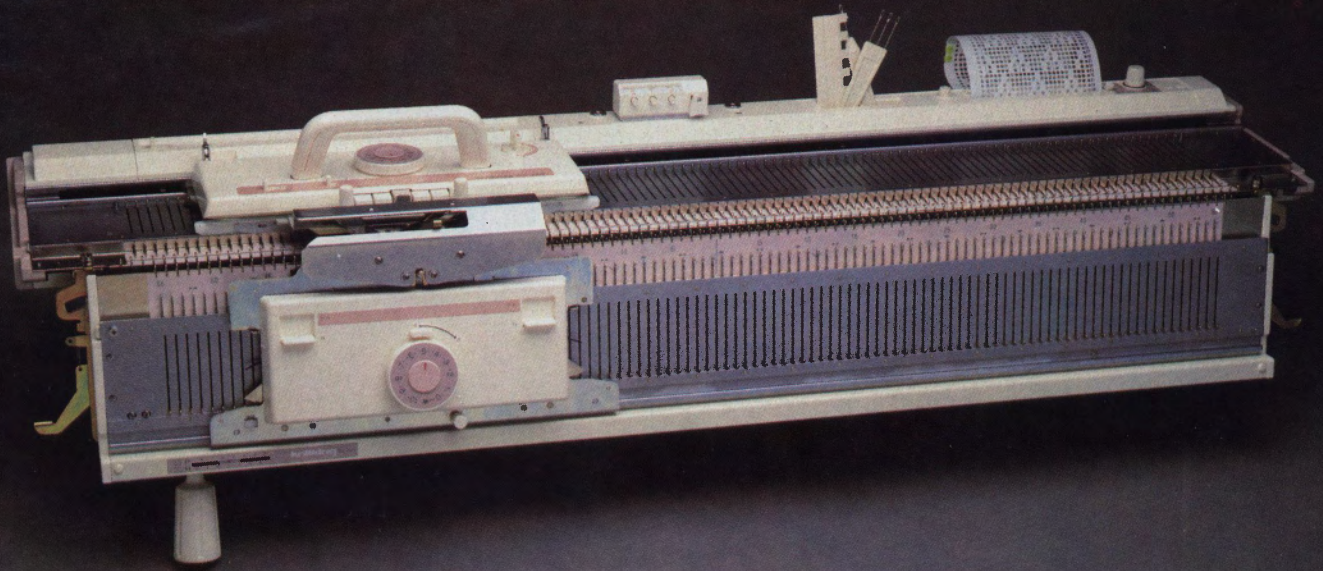

Add a Ribbing Attachment to your KH 260 KNITKING Bulky Knitter and substantially increase its versatility. The KR 260 Ribber allows you to knit all of the standard ribs 1x1, 2x2, 3x1, or any other combination of knit and purl you desire, plus tubular knitting. With 110 needles on the Ribber and 114 needles on the KH 260 Knitter, you have a total of 224 needles. You can knit fully ribbed dresses and sweaters with weights of yarn from fingering up to heavy bulky. You can knit Zig-Zag racking designs, Cable Stitch designs...Herringbone designs, Tuck Stitch Rib designs, Fishermans Rib, etc., etc...

A KR 260 Ribber comes complete with tools, cast on combs, weights, manual and one year limited warranty on parts, detailed instruction and service.

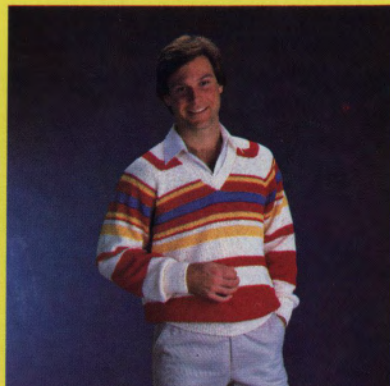

KNITKING Punch Card Programmed Bulky

The very latest and easily the most versatile of all Bulky knitting machines. It's the first with automatic PUNCH CARD PATTERN selection and it knits a range of yarns from sport weight to jumbo, including Angora, Mohair, Boucle, Ribbon, Cotton, Acrylic, etc. The KNITKING KH 260 has 114 stainless steel needles in a needle bed 40" wide. At 3 stitches per inch, it knits up to 38" wide. The Tension Control Dial has 30 tensions for knitting different weights of yarn... Comes complete with TWIN OVERHEAD FEEDERS, 15 PRE-PUNCHED PATTERN CARDS, ROW COUNTER, complete TOOL KIT, STITCH MEASURE SCALES for Knitcorder, CARRYING CASE, a detailed, well illustrated, easy to understand INSTRUCTION MANUAL and a one year warranty on parts and service.

Accepts standard 24 stitch Punch Cards for:

- Fair Isle Patterns
- Weaving
- Skip Stitch and Tuck Stitch
- Automatic Plaiting
- Thread Lace
- Isolation Motifs

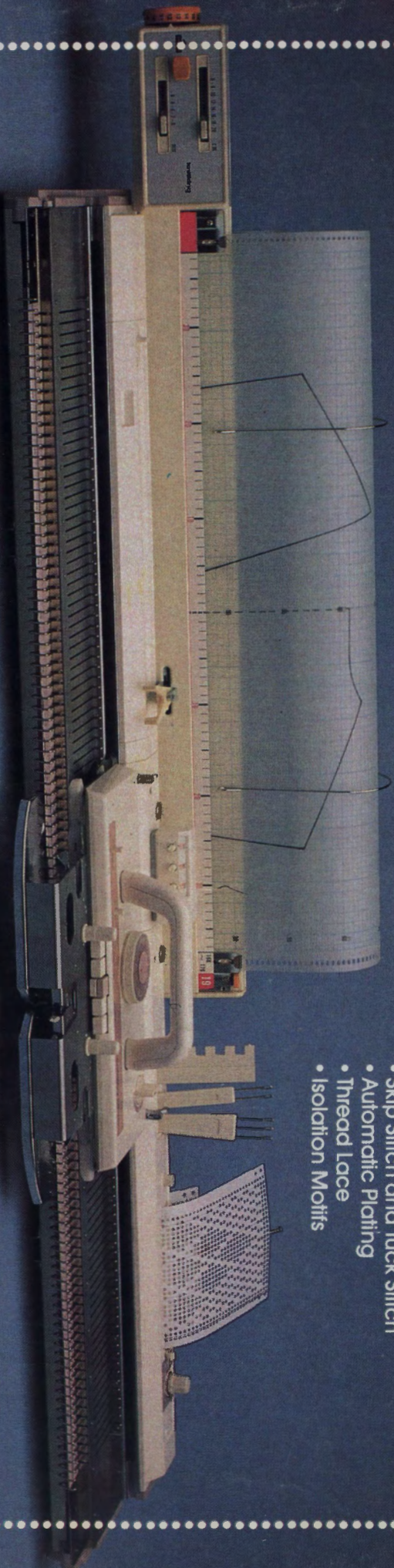

Model KH 260

Order from your local Dealer or direct from:
KNITKING CORPORATION — 1128 Crenshaw Blvd.,
Los Angeles, CA 90019 Telephone: (213) 938-2077