



knitking
magazine



Special Feature

New and Beautiful
Glamour
Garments for the
Fuller Figure





Roses, Roses, Everywhere

Turn your talents into a sumptuous Evening Dress. Any Electronic machine with Ribber makes the Fair Isle Design with no floats on the back if you use a KR 850 or KR 900 Ribber. It is knitted with Venetia and Mami Rex for sparkle. The instructions include a lovely Stole for a Cover-up.





Couture

Gloriously gorgeous you'll love wearing this elegant 2-piece Dress. The Skirt is double knit with ribber. The top is a Fair Isle Design with no floats on the back if you use a KR 850 or a KR 900 Ribber. The yarn is Venetia and Mami Rex. Sizes 8 to 14.





Table of Contents

KNITTING MAGAZINE—VOLUME 21, NO. 1

TABLE OF CONTENTS	PAGE NO.
562—WOMENS SWEATER	13
563—YOUNG MANS SWEATER	15
564—WOMENS DRESS	16
565—WOMENS DRESS AND JACKET	17
566—WOMENS JACKET	18
567—WOMENS DRESS	19
568—WOMENS TWO-PIECE DRESS	21
569—WOMENS SWEATER	22
570—WOMENS LARGE SIZE JACKET	23
571—WOMENS SKIRT AND TOP	24
572—WOMENS HOUSECOAT	25
573—WOMENS PULLOVER	27
574—WOMENS JACKET	28
575—WOMENS TWO-PIECE DRESS	29
576—WOMENS SWEATER	30
577—BABY ENSEMBLE	31
578—MENS SWEATER	33
579—WOMENS SKIRT AND TOP	33
580—MENS SWEATER	35
581—WOMENS TUNIC	37
582—WOMENS DRESS AND JACKET	38
583—WOMENS TWO-PIECE DRESS	41



Editorial

Our previous issue Volume 20 No. 4 hit the jackpot...and we thank you for the hundreds of letters and phone calls telling us how much you liked it...we liked it too.

We have discovered over the years that it is just not possible to make all of our readers happy all of the time but we do our best to satisfy all tastes and to keep up-to-date with style and fashion... It is obvious that the majority of readers prefer classic styles rather than the many fashion extremes featured in fashion magazines and since most members of our design department have similar tastes, we invariably have a selection of garments in each issue that stimulate favorable comment. It is unusual to have the entire edition applauded... Our designers thank you, they do great work in designing, charting, knitting and finishing and are happy that their efforts are appreciated.

At the beginning of each year it is our pleasure to inform readers of things to come...and for 1987 some amazing new products are predicted.

Our suppliers continue to surprise us, especially in regard to the skills of their designers and engineers. We introduced the **COMPUKNIT III** in Mid-1986 and its sales took off like a rocket... There is always a hold your breath period after the introduction of a new model, despite its initial period of sales and market testing in its country of origin, and we are happy to broadcast the fact the **COMPUKNIT III** lives up to all expectations and is a remarkably trouble-free machine.

The design and function of the **COMPUKNIT III** with optional Floppy Disk Drive, obviously predicted improvements to come and we can now tell you that they are on their way... A "Pattern Design System" has been developed incorporating a personal computer on which you can create your own patterns for storage on a Floppy Disk and immediate transfer to a **COMPUKNIT III** knitter, eliminating the need for pre-drawing on graph paper... By combining three primary colors, red, green and blue in eight gradations of light to dark, it is possible to program as many as 512 colors onto the computer screen... Although all specifications are not yet completely clear to us, we do understand that some pre-programmed Floppy Disks are part of the Pattern Design System... We hope to be able to inform you soon regarding the date of availability of these exciting new developments...in the meantime we must emphasize that they are not adaptable to any other model or brand of knitting machine. Only the **COMPUKNIT III (KH 930)** will accept the Floppy Disk Drive which is essential for the operation of the Pattern Design System.

Over the past few years several electric motor drive units have been put on the market and advertised as suitable for several brands of knitting machines. Although tempted to offer them for sale to our customers, we resisted the temptation... For one reason we were not entirely happy with their function, but mainly because we always believed that our suppliers would design a unit specifically for their machines... They have done it!!! We will soon be offering a 'state of the art' Electric Drive Unit adaptable to Punch Card machines from KH 880 to KH 891, for Bulky machines KH 230 and KH 260 and for Electronic machines KH 910 and KH 930 (**COMPUKNIT III**). A microcomputer controls width of knitting from 1 to 200 stitches. It moves at speeds up to 34 rows per minute. It can be programmed to stop at any desired row and is equipped with a sensor device for automatic shutoff in the event of yarn breakage or knots in the yarn and is suitable for delicate yarns as well as bulky yarns.

If you are considering trading your old machine, the **COMPUKNIT III** has no peer and if you are thinking about a Motor Drive Unit, please wait for the KKE 100.

Our 1986 Seminar was rated the greatest ever and we are already preparing for a bigger Seminar in 1987. It will run from September 14th through the 19th. Plan to be with us.

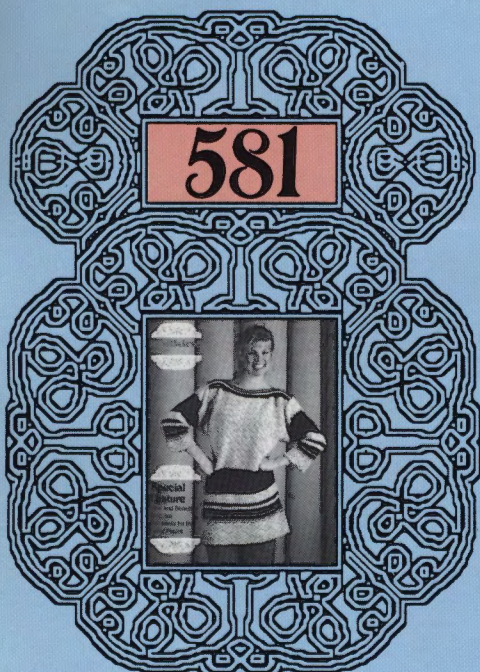

Cover

To celebrate the beginning of our New Year, Volume 21, No. 1 is bigger and better than ever. Do knit our COVER MODEL TUNIC... It's a Weaving Pattern using our Glace yarn for the background Alpacana for weaving. Sizes 10 to 18.

Publisher: KNITTING CORPORATION, 1128 Crenshaw Blvd., Los Angeles, Calif. 90019. Telephone: (213) 938-2079. Published quarterly. Subscriptions: USA—\$18.00 annually, single copies \$5.00; \$21.00 all other countries. The entire contents of KNITTING MAGAZINE are copyright and must not be reproduced in any shape or form without the express permission, in writing, of the publisher.

© COPYRIGHT 1987 KNITTING CORPORATION





576

Creative Creation



Striking color combinations for a sideways knitted Pullover is just what you need for those on-the-go days. The diamond Design is worked using Short Row Knitting- the results are superb. Bands are K1, P1 Ribbing. Roma is the yarn.





Fashion Delight

A selected and isolated Lace Design is a part of this dreamy two-piece Dress knitted with our Venetia yarn. Make it on any Electronic machine and create a sensation.





Impressive

A gorgeous ensemble is a Dress with a matching Jacket that can travel through all seasons. A very easy Fair Isle Design with full needle ribbing for the bands. Knit it on any standard Punch Card or Electronic machine with Ribber.





Racy

Take off to any special event wearing this two-piece Dress. The Top is knitted sideways with spaced out stripes. The Skirt is also knitted sideways, with short rows for the flip and fashionable flare at lower edge. Knit it with Venetia and Capriccio. Sizes 8 to 16.





Great Moments

A simple sheath of a Dress to catch every eye. Use your Electronic machine for the Fair Isle Pattern, your ribber for the bands. Venetia is the yarn we used. Sizes 8 to 16.





Gracious

A lovely two-piece Dress is made using a Lace and Stockinette stitch combination for the top with mini cables. The skirt is Stockinette stitch and is knitted sideways on the machine. Choose any flattering color of Venetia.





Special Request

Designed for the larger figure, a lovely Thread Lace Dress is knitted on the COMPUKNIT III (KH930). A matching fabric trim adds a touch of elegance. The yarn is Glacé.

Sizes 18 to 24.





Double Your Pleasure

A special color-coded Pullover combines a Fair Isle Design with Stockinette Stitch. The Turtle Neck Collar is really a separate removeable under-vest. Collar and sleeve bands are ribbed. Knit it with our Roma Yarn.



General Instructions

THE PRINTED INSTRUCTIONS

Follow the printed instructions or use them in combination with the Charts. Where there is any question in the instructions, you have the Charts to show you how the section will look.

Be sure to READ AHEAD so that you KNOW what to do for the size you are knitting. In the shapings, where the number of stitches are the same but the number of times different, you might find shapings like this...3 sts. 1 x (2x) [3x]—so that for the first size you will bind off 3 sts. 1x, 2nd size 3 sts. 2x, 3rd size 3 sts. 3x. Sometimes the ROWS will be different for each size—so you must watch out for different row numbers.

Shoulder and neck shapings for the back section of a garment usually are shaped at the same time—so ALWAYS WATCH for the words AT THE SAME TIME.

HOLDING STITCHES ON THE LEFT SIDE WHILE SHAPING THE RIGHT SIDE

There are different ways to hold stitches on one side while completing the other side. Usually, we tell you to bind off the center sts. for neck and put the left side into holding position while completing the right side. The easiest way and really the best way for beginners is to take a piece of RAVEL CORD and hand knit the center neck stitches, pulling them back against the needle bed of machine to the "A" or out of work position. The stitches remain in the HOOKS of the needles so you are really only knitting them HALF WAY. With another color of Ravel Cord, knit the remaining sts. on the left side in the SAME WAY.

It is important to protect these held stitches in some way—so you can either hang a REVERSING BAR so that the EYES of the Bar go BETWEEN the Gate Pegs on the machine and that the UPPER TIPS of Bar only—show above the needle bed...OR the simplest way is to use a piece of 1 inch masking tape and GENTLY place it beneath the knitting—right below the gate pegs. Do NOT press the tape—only enough pressure to hold it in place. This will prevent the Carriage (or Slide) from marking the held section.

It is VERY IMPORTANT that you mark the PATTERN ROW where you divide for the split for NECK (or SHOULDER) shaping....If you are using a PUNCH CARD—MARK THE CARD—if you are using an ELECTRONIC machine, MARK THE DESIGN WINDOW. Also take note of the Row number for the division. When you are ready to work the left section, bring the HELD stitches back to B (working) position by pulling each end of the Ravel Cord GENTLY and rip it off—be sure to align all needles straight in the B or knitting position.

Now you are ready to REFER TO YOUR OWN INSTRUCTION MANUAL for your machine—to set the controls to begin knitting the left half. The neck stitches can be bound off after completing the right side or you can leave them in hold until each side is finished, then bind them off or remove them onto contrast waste yarn ready to be picked up for knitting a neckband or for other finishing.

FULL FASHION DECREASING OR INCREASING

For Stockinette stitch, use the Full Fashion method for decreasing or increasing (except for regular cap shaping on sleeves where you decrease the edge stitch).

TO DECREASE: Hang the 3rd stitch onto the 2nd stitch then move the end stitches in to fill the empty needle.

TO INCREASE: Move the 2nd end stitches 1 needle outward, then pick up the 3rd stitch from the row below and hang it onto empty needle.

PATTERN SYMBOLS (Code for Symbols on page 13.)

() Symbol for 2nd size.

[] Symbol for 3rd size.

There are up to 3 sizes given for Patterns in KNITKING MAGAZINE. For example, the Charts and printed instructions will show the cast-on as...124—First size. (132)—Second size. [140]—Third size.

R= ROW

☐ Needles in holding position.

☒ Needles back into working position.

< For Short Row Knitting

THE SAMPLE SWATCH

Before you knit any garment, you must knit a sample swatch using the yarn you have chosen for your garment. If you do not get the correct Stitch and Row Gauge as given for a Pattern in KNITKING MAGAZINE—try different tensions. If you are using the specified yarn, you should be able to get the correct gauge using a smaller or larger tension. If you are using a different yarn, you may have to make several swatches—but the gauge is very important.

To make a sample swatch—Cast on 60 stitches with waste yarn and knit 6 rows. Mark the tension number for your sample swatch by making holes (you can do this with a Lace Carriage or by hand), 4 transfers for Tension 4, 6 transfers for Tension 6, etc. Knit 6 more rows.

Change to garment yarn and set Counter at 0. Knit 30 rows (in Stockinette stitch or Pattern stitch—according to the garment). With Contrast waste yarn knit the 10th stitch FROM EACH SIDE—by hand. Knit 30 rows. Change to waste yarn and knit 12 rows. Remove the sts. from the machine by pushing the Carriage (or Slide) across without yarn.

Pull and stretch the sample swatch both lengthwise and diagonally from corner to corner, then lengthwise again. Gently block the swatch (KNITKING PRESSING CLOTHS are great for this)—or you can allow the sample to rest several hours or even over night so that the stitches can return to their basic form.

THE KNITKING STITCH/ROW GAUGE and STITCH/ROW CALCULATOR can be used to find the NUMBER OF STITCHES or ROWS TO 1 INCH.

The KNITKING STITCH/ROW GAUGE will give you the NUMBER OF STITCHES or ROWS to 1 inch. After knitting a sample swatch by following our instructions, place the STITCH/ROW GAUGE horizontally with the START LINE on the INSIDE of LEFT stitch mark on sample.

Keep it straight then read the number on the Gauge directly below the inside RIGHT mark on Gauge. This will give you the STITCH GAUGE TO 1 INCH. For instance, if the number is 8, then you have 8 stitches to 1 INCH. To find the ROWS TO 1 INCH, measure from the first row of garment yarn, VERTICALLY to the last row. Read the NUMBER from the LOWER EDGE of GAUGE same as you did for stitches and if the number should be 14, you have 14 rows to 1 inch.

The STITCH/ROW CALCULATOR will now give you the number of sts. or rows needed for a specific measurement. Line the ARROW to the number 8 (8 sts. to 1 inch) and should you need 20 inches of stitches, find the number 20 below and right above the 20 the Calculator shows 160 sts. It works the same way for rows using the Row Gauge.

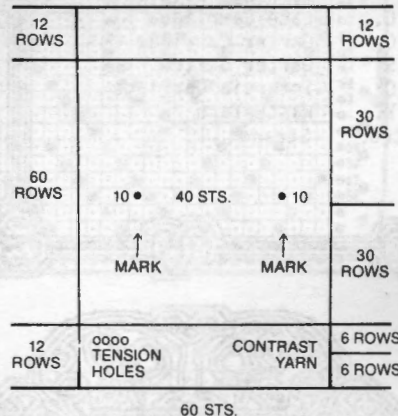

FINISHING

Gently block all sections—For PULLOVERS, JACKETS and DRESSES: Join the front to back at shoulders and sides. Sew sleeves together and set in. Hem lower edge and sleeve edges if needed. For a double neckband or armhole, band sew 1 edge to inside and 1 to the outside of neck or armhole. For a single ribbed band, sew 1 edge to the outside of neck or armhole edge. For a cardigan or jacket with buttonholes, finish buttonholes and sew on buttons.

PANTS: Join front to back at sides. Sew inside leg seams, then join to center front and back. Make hem at waistline and insert elastic. Hem lower edge of pants' legs.

☑ Needle not used—in out of work position.

3x1

☐ The number in the box is the number of Rows between shapings. The 3 x 1 above the box gives you the sts. and number of times to make the decreases (or increases)—FOR EXAMPLE: 3 x 1 over the box with 4 means—At the given Row number, *decrease 1 st. knit 4 rows* and REPEAT from * to * 2 times more for a total of 3 times in all. All decreasing (or increasing) WITHOUT ROW NUMBER IN BOX must be made on EVERY 2nd ROW.



CODE FOR SYMBOLS

Carr.	Carriage
CO	Cast on
BO	Bind off
Col.	Color
Dec.	Decrease
Inc.	Increase
EON	Every Other Needle
EOR	Every Other Row
FNR	Full Needle Rib
HP	Holding Position
MB	Main Bed
RB	Ribber Bed
K	Knit
P	Purl
Pat.	Pattern
Ndls.	Needles
St.	Stitch
St. st.	Stockinette Stitch
T	Tension
WP	Working Position
L.C.	Lace Carriage
G.C.	Garter Carriage
G.S.	Garter Stitch
I.C.	Intarsia Carriage
W.Y.	Waste Yarn
Strd.	Strand

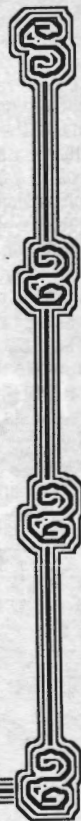

VEST: FRONT/BACK the same (1 Size only).

K1, P1 Rib: With Col. 1, cast on 140 sts. Knit 70 Rows. Transfer Rib sts. to MB and remove on W.Y. On MB, bring 110 Ndls. to WP. Hang K1, P1 Ribbing just completed back onto these Ndls. decreasing evenly across. Continue in St. st. with Col. 1. After Row 150, bind off the center 30 sts. Put the Ndls. on the left into HP and complete the right side first. *SHAPE NECK: ON NECK EDGE, decrease 1 st. EOR 20x BUT AT THE SAME TIME, after R 180, SHAPE SHOULDER: Bind off 4 sts. 5x. Bring the Ndls. on left to WP Turn Counter back to 150 and complete the left half. Follow Instructions from *. Make second section the same.

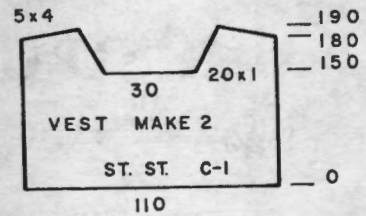

VEST COLLAR:

Arrange MB and Ribber Ndls as shown on Needle Chart. 180 sts. Cast on and after selvedge rows, knit 150 rows. Transfer Rib sts. to MB. Pick up the first row of knitting to form hem. Close 1 shoulder of Front/Back. With wrong side facing, hang neck edge onto these Ndls. Bind off LOOSELY.

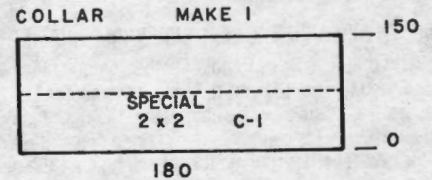
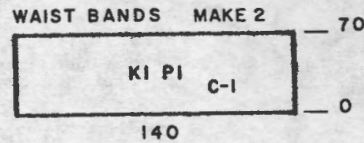

PULLOVER BACK:

With Col. 1, cast on 164 (174) [184] sts. With T 4, knit 32 rows. Pick up first row of knitting to form hem. Knit 1 row to the left. Set Pattern. Knit 1 row to the right to select the Ndls. SET CONTROL TO DOUBLE LENGTH. Change to Tension 5 and begin Fair Isle Design. SEE FAIR ISLE CHART FOR NUMBER OF ROWS AND COLOR CHANGES. Continue in Pattern. After R 138 (142) [146], mark each side for setting in sleeve and continue in Pattern. After R 220 (226) [232] SHAPE NECK: Bind off the center 46 (50) [54] sts Put the Ndls. on the left into HP and complete the right side first. *ON NECK EDGE, bind off 1 st. 4 (5) [6]x. After R 228 (236) [244], bind off or remove onto W.Y. the remaining sts. Bring the Ndls. on the left into W.P. Turn Counter back to 220 (226) [232] SET CORRECT PATTERN ROW and complete the left half. Follow the instructions from *.

FINISHING:

Close second shoulder. For side seams, close only the ribbing rows, leave the remaining sides OPEN.

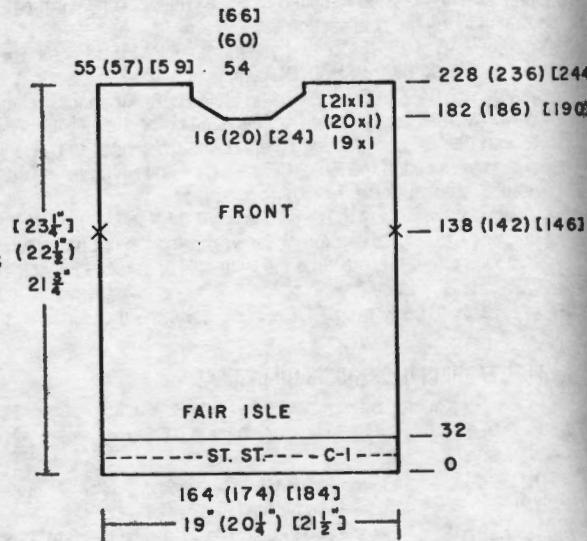

PULLOVER FRONT:

Work the same as the Back to Row 182 (186) [190]. SHAPE NECK: Bind off the center 16 (20) [24] sts. put the Ndls. on the left into HP and complete the right side first. (MARK PAT. ROW) ON NECK EDGE, bind off 1 st. 19 (20) [21]x. After R 228 (236) [244], bind off or remove onto W.Y. the remaining sts.

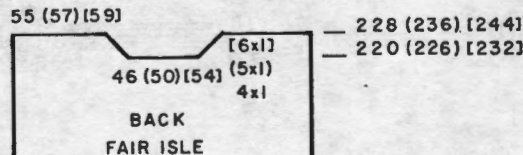

WOMENS TWO-PIECE SWEATER SET

SIZES:	Small	Medium	Large
YARN:	Roma		
AMOUNT:			
Col. 1	1 1/4	1 1/2	1 1/2 lbs.
Col. 2	8 oz.	8 oz.	8 oz.
Col. 3	4 oz.	4 oz.	4 oz.
TENSION:	Fair Isle 5, St. st. 4 Rib. 2/1.2 II		
GAUGE:	Fair Isle 17 sts. 19 R's = 2" St. st. 16 sts. 23 R's = 2"		

Make on Standard or Electronic Machine using Punch Card or Mylar Sheet Drawing. Use KH 820 Color Changer for easy color changing. Outfit consists of a Sleeveless Turtleneck Vest and a long sleeved Pullover. Bands are Ribbed.



SLEEVES: Tension 4 - St. st. Col. 1.

Set MB and Ribber Ndl. into SPECIAL ARRANGEMENT AS SHOWN ON CHART. 74 (80) [86] sts. COL. 1. Cast on in usual manner and knit 40 rows. Transfer Rib sts. to MB and continue in St. st. with Tension 4. ON EACH SIDE, increase 1 st. every 4th row 44 (45) [46]x. After R 234 (240) [246], with waste yarn, mark center of work then bind off or remove onto W.Y.

SHOULDER BANDS: Make 2, St. st. T 4 - Col. 1.

With W.Y. cast on 57 (59) [61] sts. After several rows, end with 1 row Ravel Cord to the right. Change to Col. 1. Knit 30 rows. Pick up first row of knitting to form hem. Knit 1 row over all sts. and remove onto W.Y.

CLOSE ONE SHOULDER IN THE FOLLOWING MANNER.

Bring 55 (57) [59] Ndl. to WP. With RIGHT SIDE FACING, hang left shoulder of BACK onto these Ndl. Now hang open sts. of SHOULDER BAND onto same Ndl. (double end sts.) With WRONG SIDE FACING, hang left shoulder of Front on same Ndl. BIND OFF LOOSELY OVER ALL STS.

NECKBAND: St. st. Col. 1. T 4.

Bring to WP 162 (170) [178] Ndl. With wrong side facing, hang neck edge onto these Ndl. Knit 26 rows. Bind off LOOSELY.

Close second shoulder in the same manner as before, being SURE TO ADD the shoulder band BETWEEN THE FRONT/BACK sections.

SLEEVE BANDS: Make 2 St. st. T 4 Col. 1.

With WY, cast on 168 (178) [188] sts. After several rows, end with 1 row Ravel Cord to the right. Change to Col. 1 and Knit 30 rows. Pick up first row of knitting to form hem. Knit 1 row over all sts. and remove on W.Y.

Bring 162 (170) [178] Ndl. to WP. With RIGHT SIDE FACING, hang the Armhole edge onto these Ndl. then hang SLEEVE BAND on same Ndl., decreasing evenly across. With WRONG SIDE FACING, hang SLEEVE EDGE on same Ndl. MANUALLY knit 1 row across all sts. then bind off LOOSELY.

SIDE BANDS: Make 2, St. st. Col. 1 T 4.

With W.Y. cast on 84 (87) [90] sts. Knit in the same manner as Sleeve Bands. Knit 30 rows, Pick up first row of knitting to form hem. Remove on W.Y.

Bring to WP 84 (87) [90] Ndl. WITH RIGHT SIDE FACING, hang side edge of FRONT onto these Ndl. WITH WRONG SIDE FACING, hang side BAND Manually knit 1 row across all sts. Bind off LOOSELY.

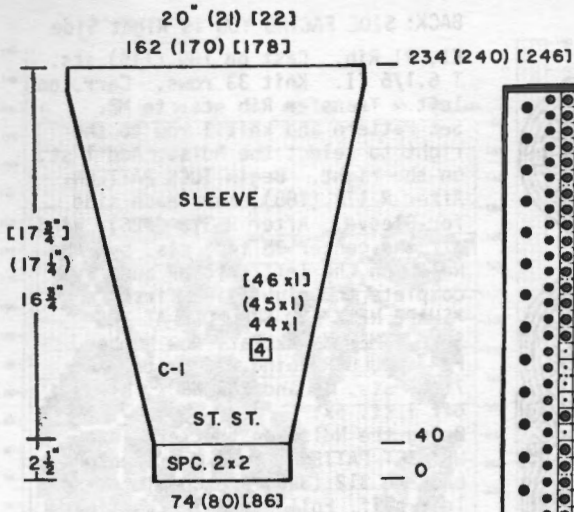

SHOULDER BAND MAKE 2

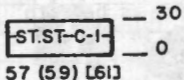

NECK BAND

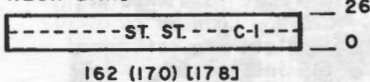

SLEEVE BANDS MAKE 2

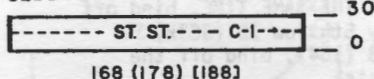

SIDE BANDS MAKE 2

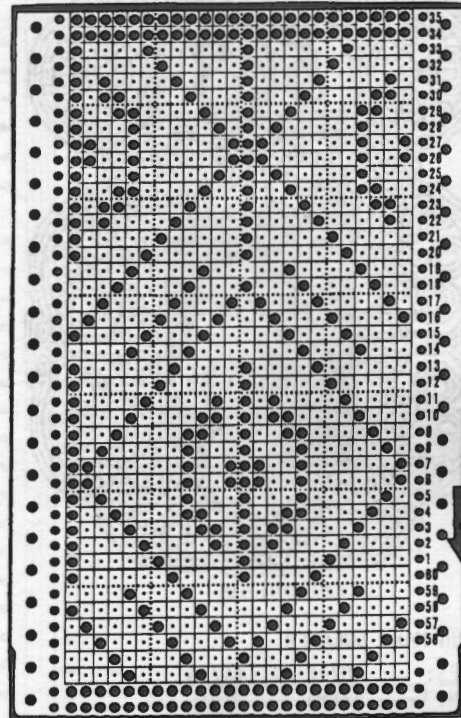
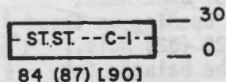

DOUBLE LENGTH FAIR ISLE CHART

C2-C3	12 R
C2-C1	28R
C2-C3	12 R
C2-C1	28R
	0

SPECIAL 2x2 RIB

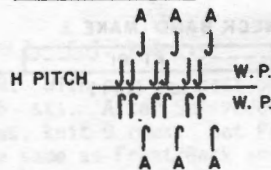

FINISHING:

See General Instructions. Turn Neck Band to inside and sew in place.

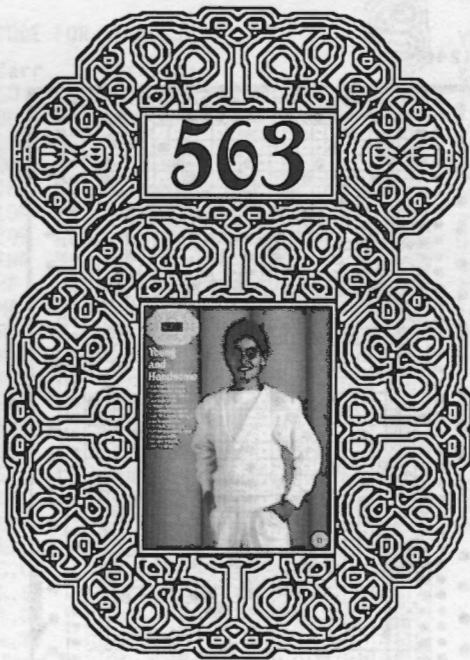

YOUNG MANS SWEATER

SIZES: 10/12 (14/16)
YARN: Extra
AMOUNT: 12 13 Balls
TENSION: 10 for Pattern Stitch
 Rib = See Instructions
GAUGE: Tuck St. 12.5 sts. 20 R's = 2"
 Eng. Rib. 13 sts. 25 R's = 2"

Make on any Standard Punch Card or Electronic machine with Ribber.

NOTE:

The Yarn is Springy and will Bunch up in the Tuck Stitch Pattern, So Use EXTRA WEIGHTS.

BACK: SIDE FACING YOU is Right Side
 K1, P1 Rib. Cast on 109 (115) sts. T 6.1/6 II. Knit 33 rows. Carr. on left. Transfer Rib sts. to MB. Set Pattern and knit 1 row to the right to select the Ndls. Add 1 st. on the right. Begin TUCK PATTERN. After R 178 (188), mark each side for Sleeve. After R 312 (326), bind off the center 38 (42) sts. put the Ndls. on the left into HP and complete the right side first. *SHAPE NECK AND SHOULDER AT THE SAME TIME. Mark Pat. Row Number. FOR SHOULDER, bind off 6 sts. 4x, 7 (8) sts. 1x and FOR NECK, bind off 1 st. 5x. Bring the Ndls. on the left into WP. SET PATTERN, turn Row Counter back to 312 (326) and complete the left half. Follow the instructions from *.

FRONT:

Work the front the same as back to Row 154 (164). Divide in the center MARK PATTERN ROW NUMBER. Put the Ndls. on the left onto W.Y. complete the right side first. *ON NECK EDGE, bind off 2 sts. every 12th row 12 (13)x AND AT THE SAME TIME, after R 178 (188) mark side edge for sleeve. After R 312 (326) SHAPE SHOULDER same as the back. Bring the Ndls. on the left into WP, SET PATTERN. Turn Row Counter to 154 (164) and complete the left half. Follow the instructions from *.

V NECK INSERT:

K1, P1 Rib. Cast on 59 (63) sts. After selvedge rows, change Carriage Settings for ENGLISH RIB and continue in Pat. AT THE SAME TIME, bind off 1 st. every 5th row 28 (30)x. After R 148 (154), bind off the remaining sts.

NECK BANDS: Make 2 - T 6.1/6 II

Close Shoudlers first. K1 P1 Rib. Cast on 133 (141) sts. After Selvedge, knit 30 rows. Transfer Rib sts. to MB then pick up first row to form hem and hang onto needles. Starting at center of back Neck, hang 1 side of Neck opening on these same Ndls. (Allow 28 (32) Ndls. for back of Neck, the balance for Front. Knit 1 row MANUALLY over all Ndls. then bind off LOOSELY REPEAT FOR OTHER SIDE.

SLEEVES:

Bring 117 (123) Ndls. to WP. With wrong side facing, hang armhole edge of Front/Back onto these Ndls. Knit 1 R to the Left. SET TUCK PATTERN and Knit 20 Rows. ON EACH SIDE, bind off 1 st. every 8th row 25 (26)x. After R 224 (232) bring Ribber to WP, transfer every other st. to Ribber and with T 6.1/6 II Knit 34 rows. (If using Garter Carriage use T 4.2). After R 258 (266), transfer Rib sts. to MB then bind off.

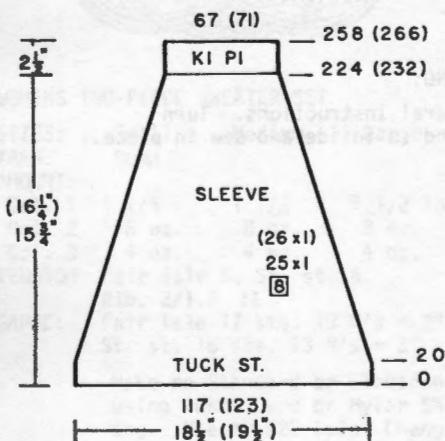
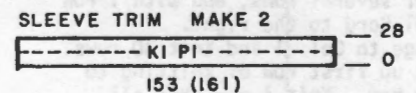
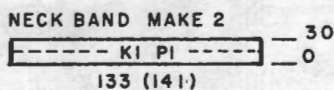
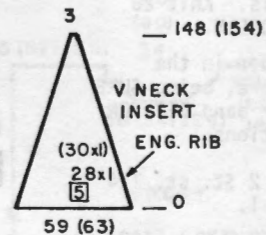
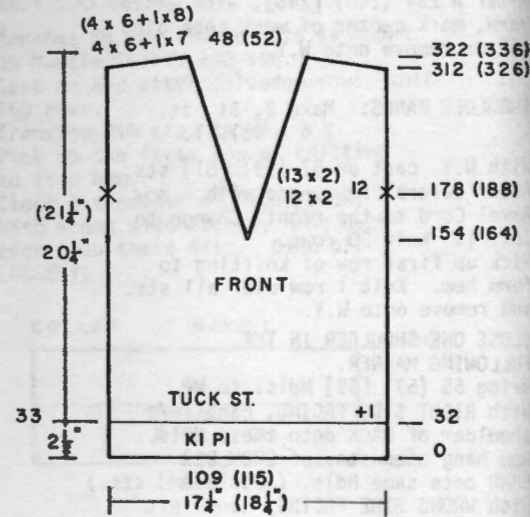
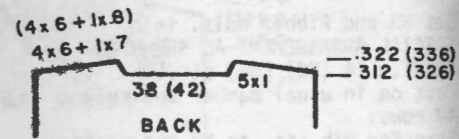

SLEEVE TRIM: Make 2, T 6.1/6 I
 K1, P1 Rib. Cast on 153 (161) Knit 28 rows. Transfer Rib sts. to MB then pick up first row to form hem. Bind off.

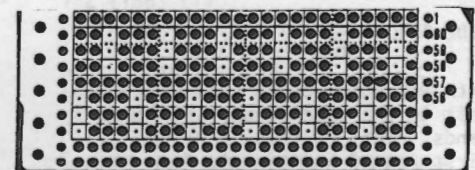

Punch Card Through R49. Then punch 2 rows of Holes for connecting card.

FINISHING:

See General Instructions. Sew V-Neck Insert by hand, to Neck Edge. Repeat for Sleeve Trim.





564



WOMENS DRESS

SIZES: 8/10 (12/14) [16]
YARN: Venetia = Col. 1
Mami Rex (reg) = Col. 2

AMOUNT:
Col. 1 2 Lbs. all Sizes
Col. 2 6 Spools all Sizes.
TENSION: Pat. 4/4 - FNR BANDS 5/5 I
GAUGE: 15 sts. 34 rows = 2" (5 cm)

Made on KH 910 with KR 900 Ribber and KRC 830 Color Changer.
A Fair Isle Design. See Practical Knitting Hints this issue for no floats on the back of knitting.

FRONT/BACK: Make 1, reverse 1.

FNR. Cast on 148 (156) [164] sts. with Col. 1.

After selvedge rows, knit 9 rows ending with Carr. on left.
SET PATTERN. (See Practical Knitting Hints this issue).

After R 698 (706) [714] ON EACH SIDE, bind off 9 (10) [11] sts. 1x then follow the Chart for your size working the decreases and be sure to note the different decreases for each side that are worked at the same time.

After R 800 (816) [832], transfer Ribber sts. to MB and bind off. Make second half with Reverse shaping.

NECKBAND: Col. 1.

FNR. Cast on 200 sts. After selvedge rows, set Counter to 0.
*Push left Part Button IN on Ribber, push right PR button UP. Knit 2 rows. Push right Part Button IN, Left PR Button UP, knit 2 rows. REPEAT FROM *
After R 24, transfer Ribber sts. to MB. Knit 1 row over all sts. and remove onto contrast waste yarn.

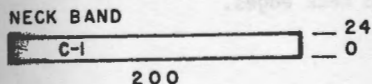

200

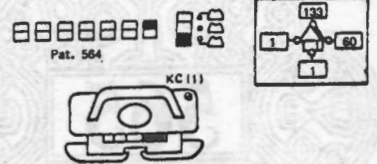
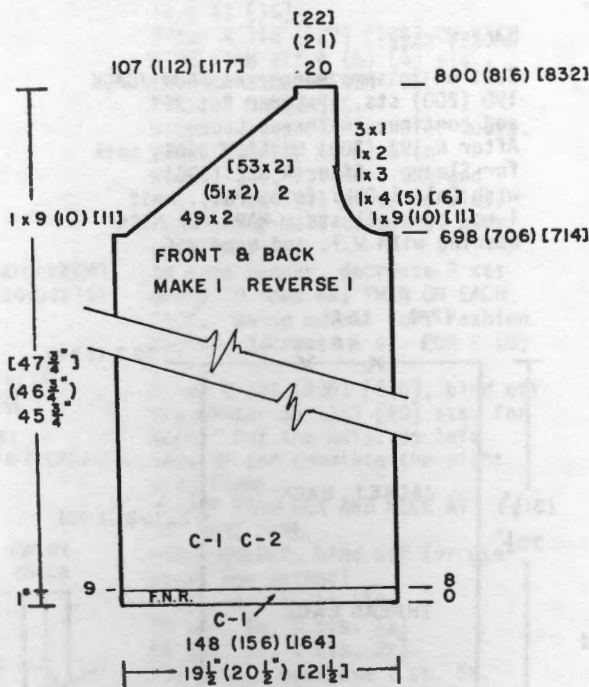
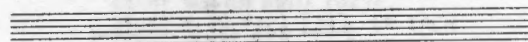
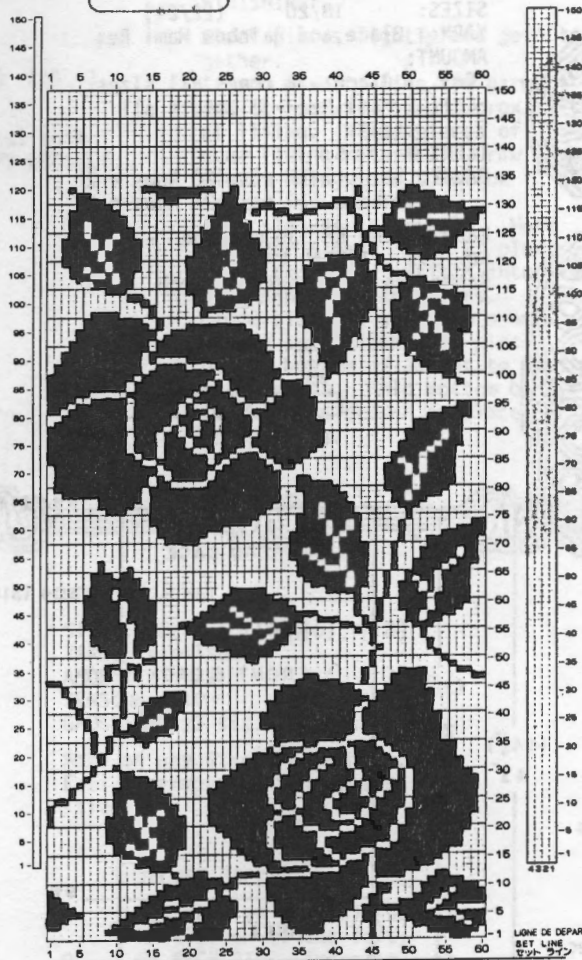

ARMBAND: Make 1, Col. 1

FNR. Cast on 102 (110) [118] sts. After selvedge, knit 8 rows. Join Shoulder and with wrong side facing, hang arm edge onto these Ndl's. Bind off LOOSELY over all sts.

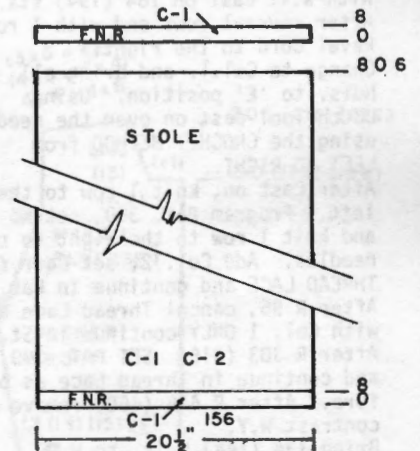
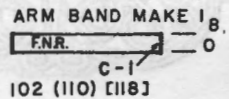

STOLE: Col. 1 & 2.

FNR. With col. 1, cast on 156 sts. After Selvedge rows, knit 9 rows. Set Pattern the same as Front/Back and proceed in the same manner by pushing PR Buttons UP and PR Buttons DOWN just as you did before. After R 806. Transfer Ribber sts. to MB. Knit 1 row across the doubled sts. then remove on W.Y. With Col. 1 cast on FNR 156 sts. After selvedge rows, knit 10 rows. Transfer Ribber sts. to MB and with wrong side facing, hang the open sts. of the Stole onto these Ndl's. Bind off.

FINISHING:

Follow General Instructions. If Band across the front is not tight enough, run elastic through and adjust to fit.



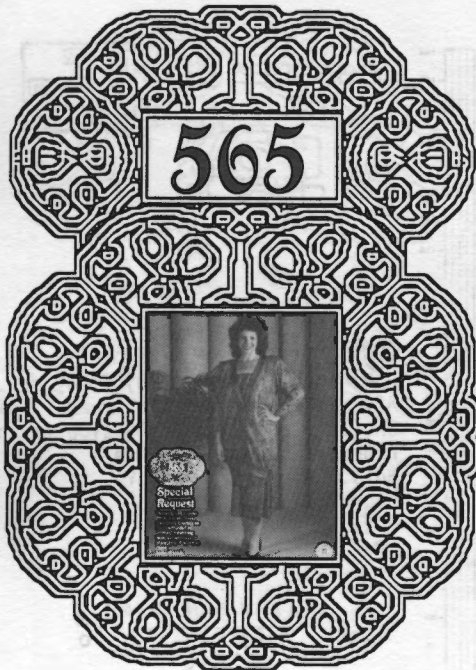

WOMENS DRESS and JACKET

SIZES: 18/20 (22/24)
 YARN: Glace and Rainbow Mami Rex
 AMOUNT:
 Col. 1 Glace - 2 cones all sizes.
 Col. 2 Mami Rex - 8 spools all sizes.
 TENSION 5
 GAUGE: St. st. 15 sts. 20 Rows = 2"
 Lace 15 sts. 21 Rows = 2"
 Made on the KH 930 machine - Pat. No. 399 - THREAD LACE.
 Bands are Stockinette stitch.

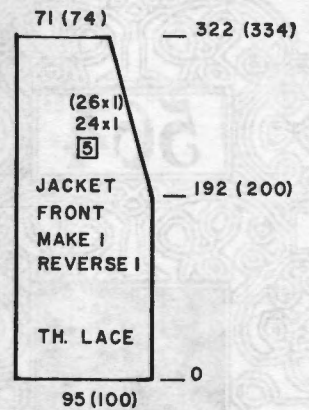

JACKET FRONT: Make 1, reverse 1.
 Using same method as Back, cast on 95 (100) sts.
 Knit in Thread Lace Pattern.
 After R 192 (200), mark sleeve edge for Armhole and begin decreases on Neck side.
 ON NECK SIDE, dec. 1 st. every 5th row 24 (26)x. After R 322 (334), stop Pat. and with col. 1 ONLY knit 1 row. Bind off.

FRONT/BACK: The same.

With W.Y. cast on 184 (194) sts. After several rows end with 1 row Ravel Cord to the right. Change to Col. 1. and bring all Ndl. to 'E' position. Using Latch Tool cast on over the needles using the CROCHET METHOD from LEFT TO RIGHT.
 After Cast on, knit 1 row to the left. Program Pat. 399, set KC II and knit 1 row to the right to select needles. Add Col. 2, set Carr for THREAD LACE and continue in Pat. After R 96, cancel Thread Lace and with Col. 1 ONLY continue in St. St. After R 303 (315) SET PAT. 399 and continue in Thread Lace as before. After R 448 (460) remove on contrast W.Y.
 Bring 134 (144) Ndl. to W.P. With wrong side facing, hang open sts. of Front/back just completed onto the Ndl. decreasing evening across. Cancel Pat. With Col. 1, knit 16 rows. Hang first row St. st. onto these Ndl. to form hem. Mark Ndl. 35 (37) with W.Y. for location of Shoulder straps. Bind off.

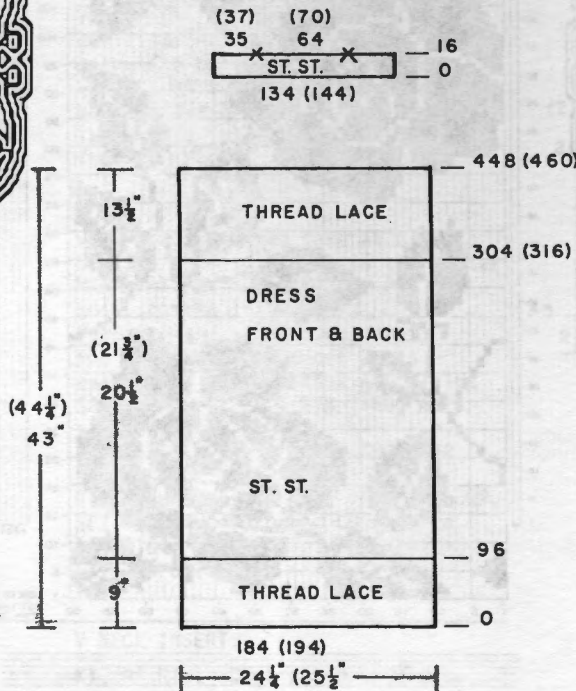

JACKET BACK:

Cast on in same manner as FRONT/BACK 190 (200) sts. Program Pat 399 and continue in Thread Lace. After R 192 (200) ON EACH SIDE, mark for Sleeve. After R 322 (334) with Col. 1 ONLY (stop Pat.) knit 1 row over all sts. MARK FOR NECK opening with W.Y. and bind off.

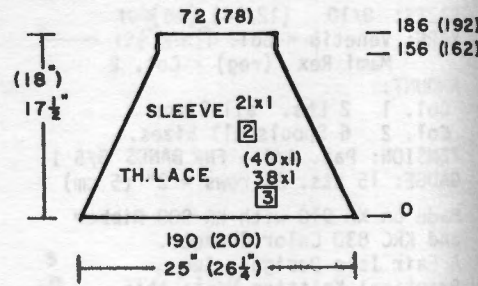

SLEEVES:

Cast on same method as before , 190 (200) sts. SET THREAD LACE PATTERN. ON EACH SIDE, bind off 1 st. every 3rd row 38 (40)x then 1 st. EOR 21x. After R 156 (162), knit straight in Pat. to Row 186 (192), Remove onto W.Y.

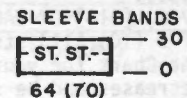

SLEEVE BANDS: Col. 1. St. st.

'e' cast on 64 (70) sts. Knit 30 rows. Pick up first row of knitting to form hem. With WRONG SIDE facing, hang open sts. of sleeve edge onto these Ndl. decreasing evenly across. Bind off LOOSELY.

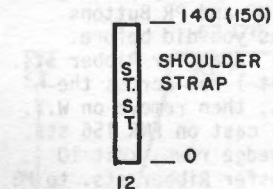

SHOULDER STRAPS: Make 2 Col. 1. 'e' cast on 12 sts. Knit St. st. for approx. 140 (150) rows or desired length. Bind off.

FINISHING:

Join side seams. Sew Shoulder Strap at W.Y. markers. Thread elastic through top if desired for individual fit.

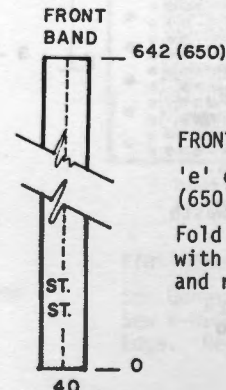
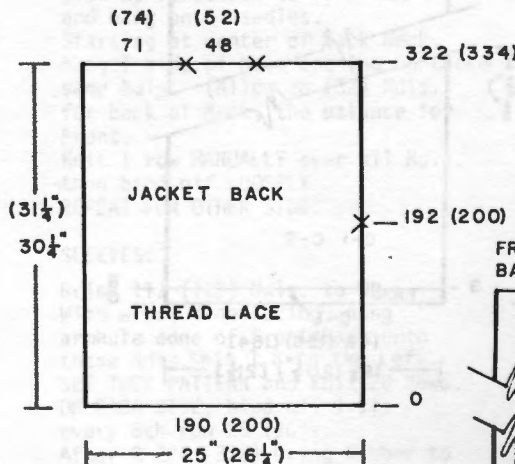

FRONT BAND: Make 1 Col. 1 St.st.

'e' cast on 40 sts. Knit 642 (650) rows. Bind off.
 Fold Front Band lengthwise and with tapestry needle, join to front and neck edges.

680 (700)

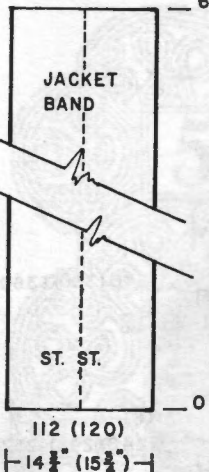

JACKET BAND (lower edge) Col. 1
St. st.

'e' cast on 112 (120) sts. Knit
680 (700) rows. Bind off LOOSELY.

FINISHING:

Block pieces lightly and join together.

If you wish to line the garment Jacket you will need approx. 3 yds. of lining. Place pieces of Jacket over lining material. Draw around pieces being sure to allow 1" all around for seaming.

Join sleeves to armhole. Make shoulder pleat. Form 2" pleat on front and back. Stitch into place and then close shoulders.

Close side and underarm seams. Join Lining and stitch into place.

Gather bottom of Jacket to desired measurement. Fold bottom band in half and stitch in place.

See picture.



WOMENS JACKET

SIZES: 10/12 (14/16) [18]

YARN: Papillon

AMOUNT: 1 1/2 1 3/4 2 lbs.

TENSION: 10+

GAUGE: 13 sts. 19 rows = 2"

Make on any Standard machine.
Entire garment is Stockinette
stitch.

JACKET BACK:

'e' cast on 54 (58) [62] sts.
Knit 1 row to the left.

ON EACH SIDE, increase 1 st.

EVERY ROW 28 (30) [32]x.

After R 30 (32) [34], ON EACH
SIDE, Inc. 1 st. every 6 rows
13 (14) [15]x.

After R 116 (122) [128] ON EACH
SIDE, bind off 4 (5) [6] sts..

ON EACH SIDE, BEGIN FULL
FASHION DECREASES.

With 2 - 3 prong transfer tools,
transfer sts. 4, 5, 6 to
Ndls. 7, 8, 9. Move the end
sts. in to fill empty needles.
Push empty Ndls to out of work
position.

In same manner, decrease 3 sts.
every 10 rows 4x, THEN ON EACH
SIDE, using normal Full Fashion
Method, decrease 1 st. EOR 7 (8)
[9]x.

After R 196 (206) [216], bind off
the center 36 (38) [40] sts. for
Neck. Put the Ndls. on left
into HP and complete the right
side first.

*SHAPE SHOULDER AND NECK AT
THE SAME TIME.

FOR SHOULDER, bind off (or use
short row method)

4 sts. 4x, 6 sts. 1x.

(5 sts. 4x, 4 sts. 1x)

[6 sts. 3x, 4 sts. 2x].

FOR NECK,, decrease 1 st. 5x.

Bring the Ndls. on the left
to W.P. Row Counter back to
196 (206) [216] and complete
left half. Follow instructions
from *.

[3x6 + 2x4]
(4x5 + 1x4)
4x4 + 1x6

206 (216) [226]

180 (188) [196]

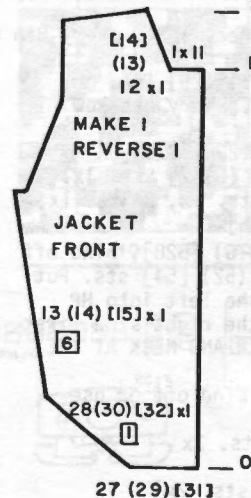

27 (29) [31]

FRONT: Make 1, reverse 1.

'e' cast on 27 (29) [31] sts.
and work same as BACK but the
SHAPING IS ON ONE SIDE ONLY.
After R 180 (188) [196], ON
NECK EDGE, bind off 11 sts. then
ON NECK EDGE, decrease 1 st. EOR
12 (13) [14]x. AT THE SAME TIME,
after R 196 (206) [216], SHAPE
SHOULDER SAME AS BACK.

90 (96) [102]
[3x6 + 2x4]
(4x5 + 1x4)
4x4 + 1x6

206 (216) [226]
196 (206) [216]

7 (8) [9] x1 [2]
4 x 3 [10]

4 (5) [6]
116 (122) [128]

30 (32) [34]

0

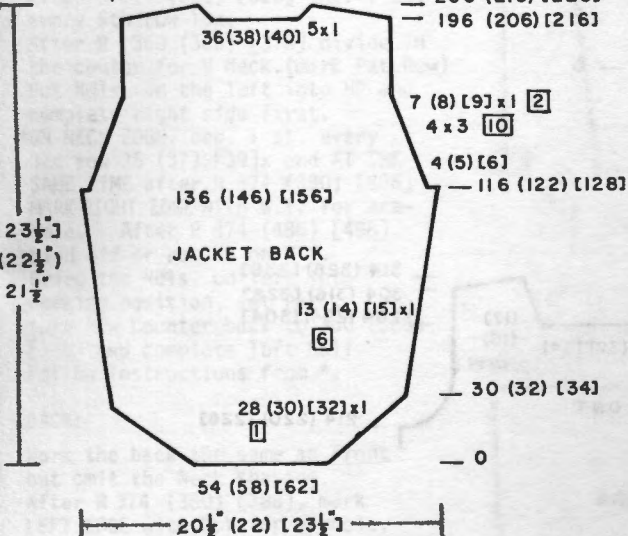

CONTINUED



SLEEVES:

'e' cast on 56 (60) [66] sts.
 Knit 30 rows. Mark each side with W.Y. (fold for Cuff).
 After R 36, ON EACH SIDE, increase 1 st. every 4th row 32 (33) [34]x.
 After R 166 (170) [174]. ON EACH SIDE, work FULL FASHION DECREASES same as you did before - 3 sts. every 10th row 4x. then dec. 1 st. EOR 21 (23) [25]x.
 After R 250 (258) [266], bind off remaining sts.

FINISHING:

See General Instructions.
 With size 2 or 3 crochet hook, work 4 rows single crochet around all edges. Fold Cuff and tack in place.

WOMENS LONG SLEEVED SWEATER

SIZES: 10/12 (14/16) [18]

YARN: Venetia

AMOUNT: 1 lb. 1 lb.4 oz. 1 lb.6 oz.

TENSION: 4.1 Stockinette stitch.

GAUGE: 16 sts. 28 rows = 2"

Make on any Standard machine in Stockinette stitch.

BACK:

'e' cast on 166(178)[190] Sts.
 Knit 70 Rows.
 ON EACH SIDE, Dec. 1 St. every 8th Row 4 (5)[6]x.
 After R 110(118)[126] Inc. on EACH Side 1 St. Every 8th Row 4,(5)[6]x.
 After Row 214 (220)[226] ON EACH SIDE BO 5 (6)[7] Sts. 1x. 4 Sts. 1x, 3 Sts. 1x, 2 Sts. 1x, 1 St. 11(12)[15]x.
 After R 304 (316) [328], bind off the center 50 (52) [54] sts. Put the Ndl's. on the left into HP and complete the right side first.
 *SHAPE SHOULDER AND NECK AT THE SAME TIME.
 FOR SHOULDER, bind off or use Short Rows, 5 Sts. 2x, 6 Sts. 3x (6 sts. 5x) [6 sts. 3x, 7 sts. 2x]
 FOR NECK, dec. 1 st. EOR 5x. Bring the Ndl's. on left to WP, turn Row Counter back to 304 (316) [328] and complete left half. Follow instructions from *.

FRONT:

'e' cast on 166 (178) [190] sts. and work same as back to Row 284 (294) [304].
 Bind off the center 30 (32) [34] sts. put the Ndl's. on the left into HP and complete the right side first.
 *ON NECK EDGE, dec. 1 st. EOR 15 (16) [17]x and after R 304 (316) [328], SHAPE SHOULDER SAME AS BACK.
 Bring the Ndl's. on left to WP. Turn Row Counter back to 284 (294) [304] and complete the left half. Follow instructions from *.

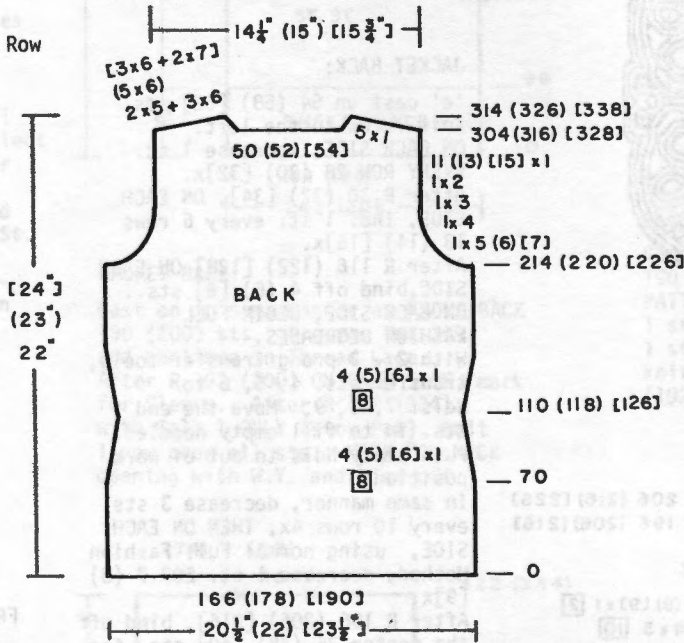
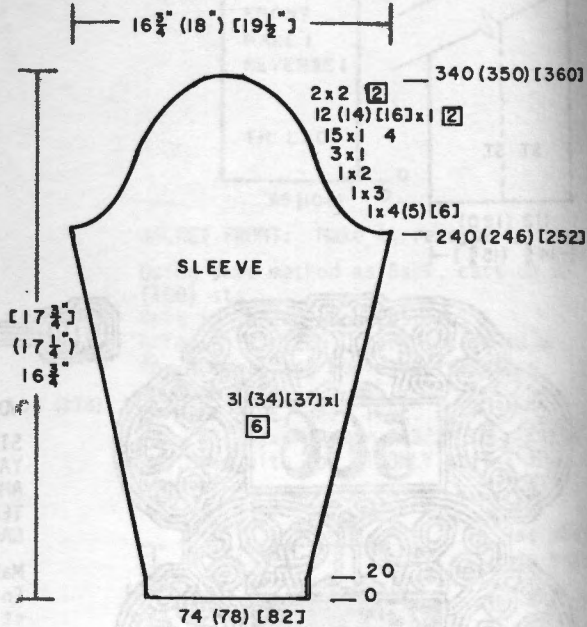
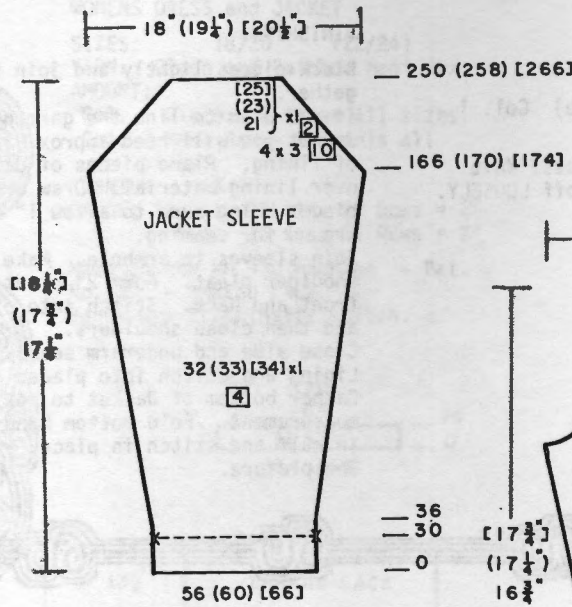

SLEEVES:

'e' cast on 74 (78) [82] sts. Knit to R 20.
 ON EACH SIDE, Inc. 1 st. every 6th row 31 (34) [37]x.
 After R 240 (246) [252] SHAPE CAP: Please follow the Chart for your size to work the decreases ON EACH SIDE.
 After R 340 (350) [360], bind off the remaining sts.

FINISHING:

See General Instructions. Work 1 row single crochet around Neck, lower edge and Sleeve edge.

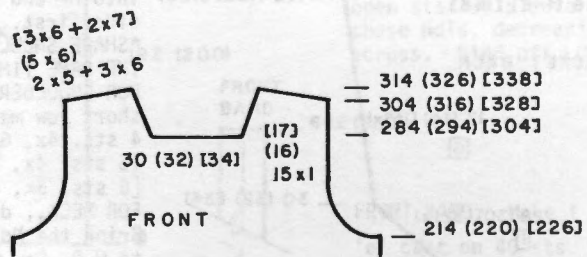

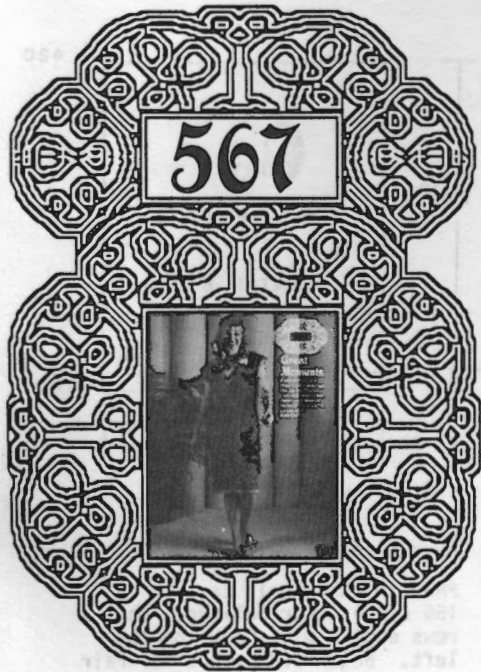

SLEEVE BAND MAKE 2

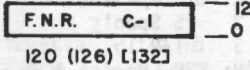

SLEEVE BANDS: Make 2 Col. 1

FNR: Cast on 120 (126) [132] sts.
Knit 12 rows. Transfer Rib. sts.
to MB then remove onto W.Y.

NECK BAND

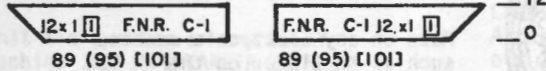

NECKBANDS: Make 2 Col. 1

FNR: Cast on 89 (95) [101] sts.
ON RIGHT SIDE (left for 2nd section)
increase 1 st. EVERY ROW 12x.
After R 12, transfer Rib Sts. to
MB then remove onto W.Y.

FINISHING:

See General Instructions. Weave
Neckbands and Sleeve Bands in
place.

WOMENS DRESS

SIZES: 8/10 (12/14) [16]

YARN: Venetia

AMOUNT:

Col. 1 1 lb. 1 lb. 1 lb. 2 oz.

Col. 2 1 lb. 1 lb. 1 lb. 2 oz.

TENSION: Pat. 5 FNR 5/5 II

GAUGE: 17 sts. 23 Rows = 2" (5 cm)

Make on any Electronic machine with
Ribber for Full Needle Rib.
A Fair Isle Design with Full
Needle Ribbing.

FRONT:

FNR. Cast on 150 (160) [170] sts.

After Selvedge, knit 10 rows.

Transfer Rib sts. to MB and knit 1
row to the left.

SET PATTERN and knit 1 row to the
right to select Ndle. Begin Fair
Isle Pat. BUT AT THE SAME TIME,
ON EACH SIDE, increase 1 st. every
20 rows 10x.

After R 238 (244) [250] ON EACH SIDE,
Dec. 1 st. every 7th row 10x.

After R 314 (320) [326] inc. 1 st.
every 6th row 10x.

After R 360 (368) [376] divide in
the center for V Neck. (mark Pat.Row)
Put Ndl. on the left into HP and
complete right side first.

*ON NECK EDGE, dec. 1 st. every
3rd row 35 (37) [39]x and AT THE
SAME TIME after R 374 (380) [386]
MARK RIGHT EDGE with W.Y. for arm-
holes; After R 474 (486) [498]
bind off or remove on W.Y.

Bring the Ndl. on left into
working position, set Pat.,
turn Row Counter back to 360 (368)
[376] and complete left half.
Follow Instructions from *.

BACK:

Work the back the same as Front
but omit the Neck shaping.

After R 374 (380) [386], mark
LEFT EDGE with W.Y. for armhole.
After R 474 (476) [488] mark for
shoulders with W.Y. then bind
off or remove onto W.Y.

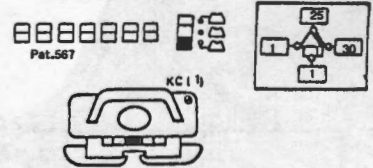
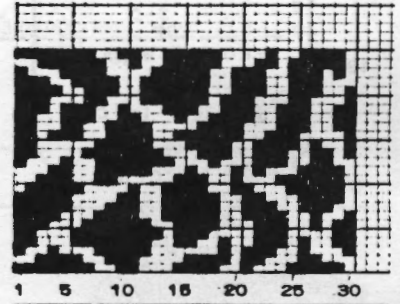
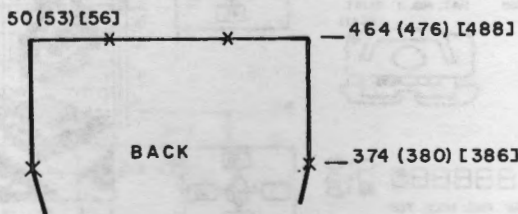
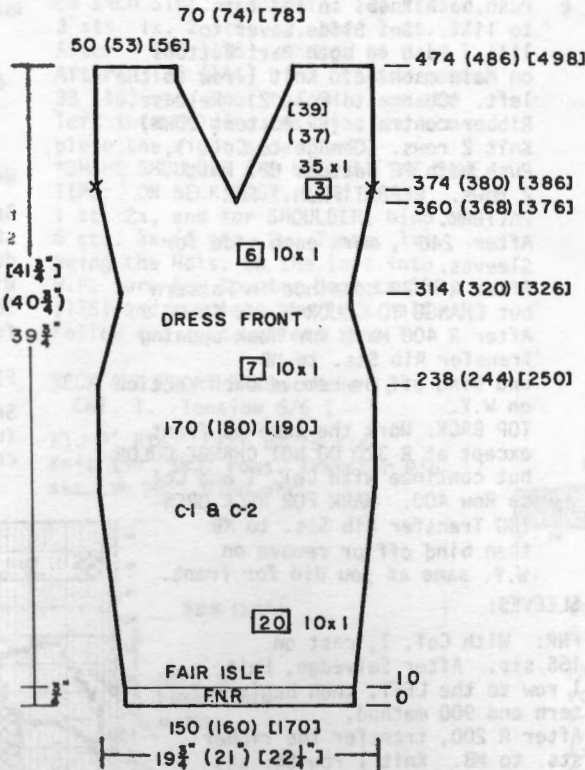



WOMENS TWO-PIECE DRESS

SIZES: One size fits 8 to 14
 YARN: Venetia = Color 1 and 3
 Mami Rex = Color 2

AMOUNT:
 Col. 1 1 3/4 lbs.
 Col. 2 5 Spools
 Col. 3 1/2 lb.
 TENSION: FNR -Bodice & Skirt 4/4
 900 Method
 For Hem T 5/5 I
 K1, P1 - 1/1 II
 GAUGE: 14 sts. 33 Rows = 2"

Make on any Electronic machine such as KH 910 or on the KH 930 using Pattern No. 7. Pattern is knitted with ribber throughout, using the KR 900 Ribber and KRC 830 or KRC 900 Color Changer.

TOP: BACK AND FRONT: USE FINE NDL.BAR

K1, P1 Rib: With Col. 3, cast on 153 sts. After Selvedge, change to T 1/1 II and knit to R 80. SET MACHINE FOR FULL NEEDLE RIB. (See Practical Knitting Hints this issue). Change to Col. 1 and knit 1 row to the left. SET PATTERN T 4/4. Push up Both PR Buttons on Ribber. Knit 1 row to the right to select the Ndl's. Push both Knobs in and turn to lili. Set Slide Lever to lili. Push in both Part Buttons on Main machine. Knit 1 row to the left. *Change to Col. 2. Release Ribber controls (PR Buttons DOWN) Knit 2 rows. Change to Col. 1, Push both PR Buttons UP. Knit 2 rows. REPEAT FROM * FOR PATTERN. After 240, mark each side for Sleeves. After R 320 continue in Pattern but CHANGE TO COLOR 3 and COLOR 2. After R 400 Mark for Neck opening Transfer Rib Sts. to MB and bind off or remove each section on W.Y. TOP BACK: Work the same as front except at R 320 DO NOT CHANGE COLOR but continue with Col. 1 and Col. 2 to Row 400. MARK FOR NECK OPENING Transfer Rib Sts. to MB then bind off or remove on W.Y. same as you did for front.

SLEEVES:

FNR: With Col. 1, cast on 156 sts. After Selvedge, knit 1 row to the LEFT, then begin Pattern and 900 method. After R 200, transfer the ribber sts. to MB. Knit 1 row St. st. to the left and remove on W.Y.

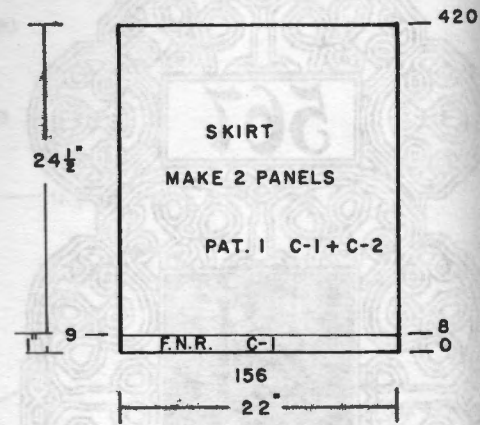

SKIRT: Make 2 Panels

FNR: With Col. 1, cast on 156 sts. After Selvedge, knit 9 rows ending with Carr. on the left. Begin 900 method for Fair Isle Design. (See Practical Knitting Hints this issue). After R 420, transfer Rib sts. to MB. Knit 1 row then remove onto W.Y.

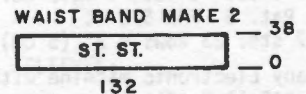

WAISTBANDS: Make 2.

Bring to WP 132 Ndl's. Hang open sts. of Skirt onto these Ndl's. decreasing evenly across. With Col. 1 tension 4, knit 38 rows. Pick up first row to form hem. Bind off LOOSELY.

FINISHING:

See General Instructions. Insert Elastic through waist casing.

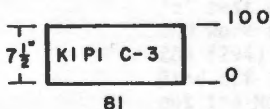
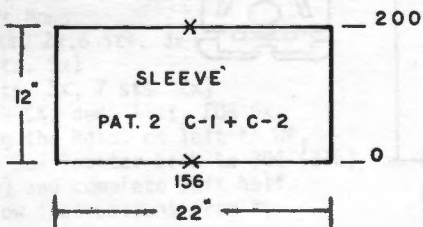
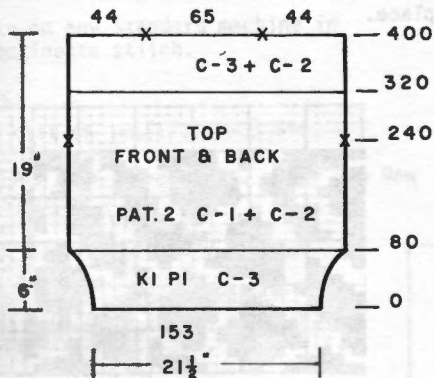

SLEEVE BANDS: Col. 3 T 1/1 II

K1, P1 Rib: With Col. 3, cast on 81 sts. Knit 100 rows. Transfer Rib sts. to MB. Pick up sts. from sleeve edge and hang onto these Ndl's, decreasing evenly across. Bind off LOOSELY.

FINISHING:

See General Instructions. Work 2 rows single crochet around Neck opening.

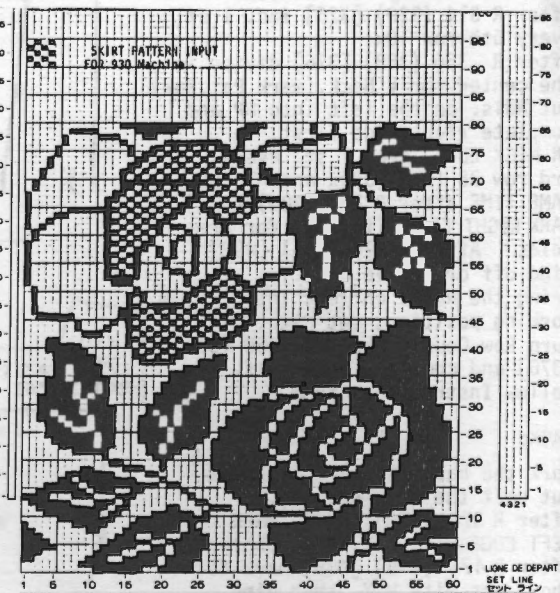
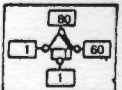
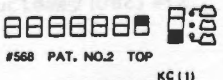
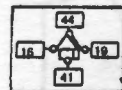
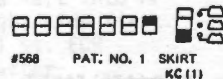

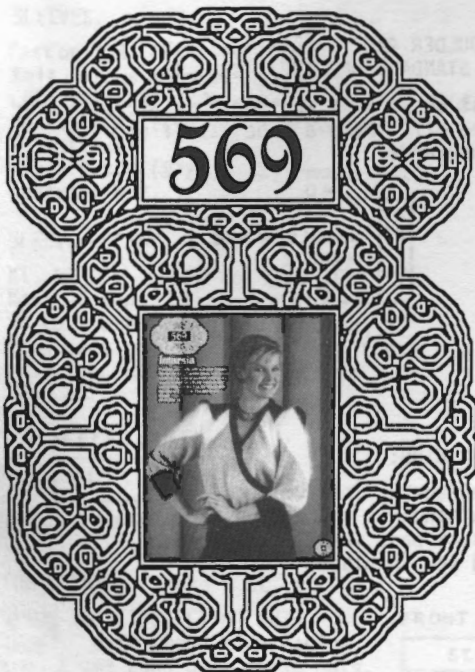

WOMENS SWEATER

SIZES: 8/10 (12/14)
 YARN: Venetia and Glace and Angora
 AMOUNT: Col. 1
 1 Strd. Black Venetia - 1/2 lbs.
 1 Strd. Black Glace - 1 Cone
 Col. 2
 1 Strd. Grey Venetia - 3/4 lb.
 1 Strd. Grey Glace - 1 Cone
 COLOR 3 - Angora 5 Balls
 TENSION: St. st. 0.2
 Ribbing - See Instructions.
 GAUGE: St. st. 10 sts. 16 rows = 2"

Knit the Sweater on any BULKY machine. Use INTARSIA METHOD or SHORT ROW METHOD for the Design. Instructions are given for the Ribbing using either the Bulky Ribber or Standard Ribber.

NOTE: For Color 1 or Color 2, ALWAYS use one strand of Venetia and 1 strand of Glace together.

BACK: Bulky Machine T 0.2

St. st. With W.Y. cast on 104 (110) sts. after several rows end with 1 row Ravel Cord to the right. Change to Col. 2, Counter 0. Continue St. st.
 After R 78 (82), SHAPE ARMHOLE: ON EACH SIDE, bind off 3 (4) sts. 1x, 3 sts. 1x, 2 sts. 1x, then 1 st. 5x. After R 130 (136), change to Col. 1. After R 136 (144) bind off the center 38 (40) sts., put the Ndl. on the left into Holding Position and complete the right side first.
 *SHAPE SHOULDER AND NECK AT THE SAME TIME: ON NECK EDGE, bind off 1 st. 2x, and for SHOULDER, bind off 6 sts. 3x (6 sts. 2x, 7 sts. 1x). Bring the Ndl. on the left into W.P. turn Row Counter back to 130 (136) and complete the left half. Follow the instructions from *.

NECK AND FRONT BAND: Make 1, Col. 1. Tension 6/6 I

K1, P1 Rib. Cast on 15 sts. Knit 366 (380) rows. Transfer Rib sts. to MB. Bind off.

BANDS: PLEASE NOTE:

Instructions are given for bands to be made on the BULKY Ribber and also instructions for Standard machine Ribber.

STANDARD MACHINE: Col. 1 Tension 5/5 I

BACK WAIST BAND

K1, P1 Rib: Cast on 163 (171) sts. Knit 36 rows. Transfer Rib sts. to MB. With wrong side facing, hang lower edge of BACK onto these Ndl. Picking up cross thread between sts. to fill in missing sts. Bind off.

FRONT WAIST BAND:

Work same as BACK band except hang both pieces of front then bind off.

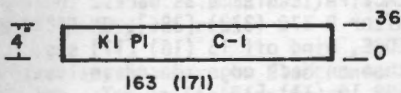

SLEEVE CUFF: Col. 1 T 6/6 I

K1, P1 Rib. Cast on 59 (65) sts. Knit to R 36. Trans. Rib sts. to MB. With wrong side facing, pick up the lower edge of sleeve, decreasing evenly across. Bind off.

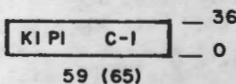
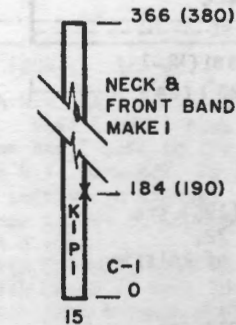

FRONT: Make 1, reverse 1.

St. st. with W.Y. cast on 104 (110) sts. After several rows end with 1 row Ravel Cord to the right. Change to Col. 2. Counter 0. Knit 9 rows. ON THE LEFT (right for second half) bind off 13(14) sts. NECK EDGE, decrease 2 sts. EOR 12x, 1 st. every 3rd row 36 (39)x BUT AT THE SAME TIME, after R 72 (76), begin the INTARSIA DESIGN FOLLOWING THE CHART.

After R 78 (82) on armhole edge Bind off 3 (4) sts. 1x, then 3 sts. 1x, 2sts. 1x, 1 st. 5x. After R 104 (110) Work Intarsia Design with Col. 1
 After R 136 (144) SHAPE SHOULDER same as back.

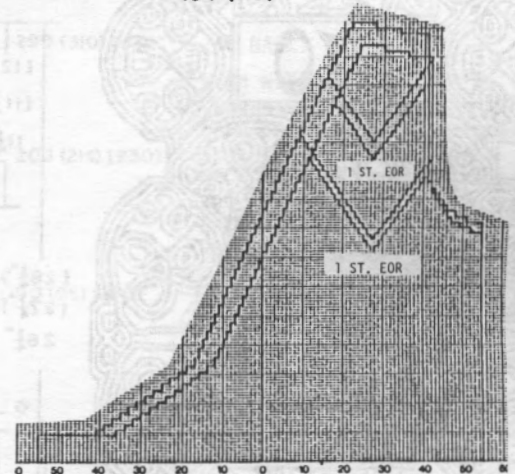
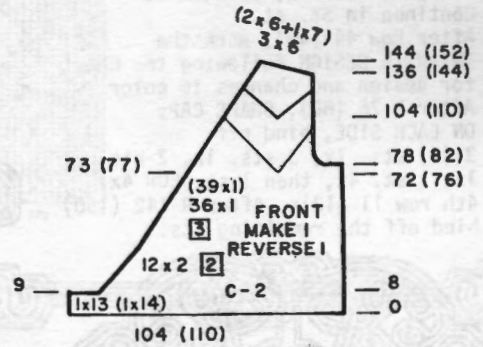

BULKY MACHINE BACK WAIST BAND Col.1 Ten 0/0 II.

FNR. Cast on 20 sts. and knit 220 rows or for as long as you need. Transfer Rib sts. to MB. Bind off.

FRONT WAISTBAND Same as BACK. Except Hang both pieces of Front and BO.

NECK AND FRONT BAND: Same Color and Tension as Waistband.

FNR: Cast on 6 Sts. and knit approx. 310 Rows. (Or to desired Length) Transfer Rib Sts. to MB. and BO.

SLEEVE BAND; Same color and Tension as Waistband.

FNR: Cast on 20 sts. Knit 44 Rows. Transfer to MB. Bind off.

CONTINUED



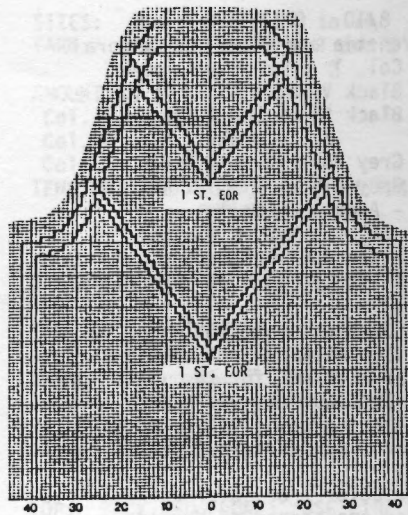
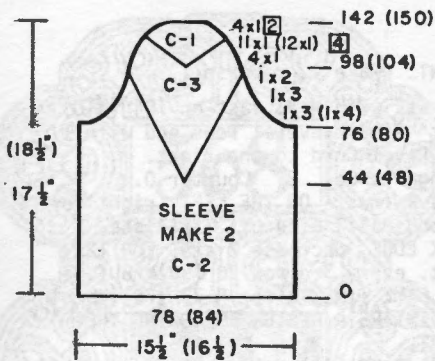

SHOULDER PAD: (Puff in Sleeve)
STANDARD MACHINE - Col. 1

Cast on 24 sts. Knit 40 rows St. st.
Bind off. Make a tube, stuff and
close ends.

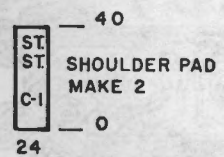

FINISHING:

See General Instructions.
Sew bands in place (See Picture).
Insert pads inside at shoulder
and sew in place.

SLEEVES:

W.Y. Cast on
78(84) Sts. Same as
back and front, ending with Ravel
Cord Row to the right.
Change to Col. 2, Counter 0.
Continue in St. st.
After Row 44 (48), Work the
INTARSIA DESIGN following the Chart
for design and changes in color.
After R 76 (80), SHAPE CAP:
ON EACH SIDE, bind off
3 (4) sts. 1x, 3 sts. 1x, 2 sts.
1x, 1 st. 4x, then 1 st. EOR 4x.
4th row 11 (12)x After R 142 (150)
bind off the remaining sts.

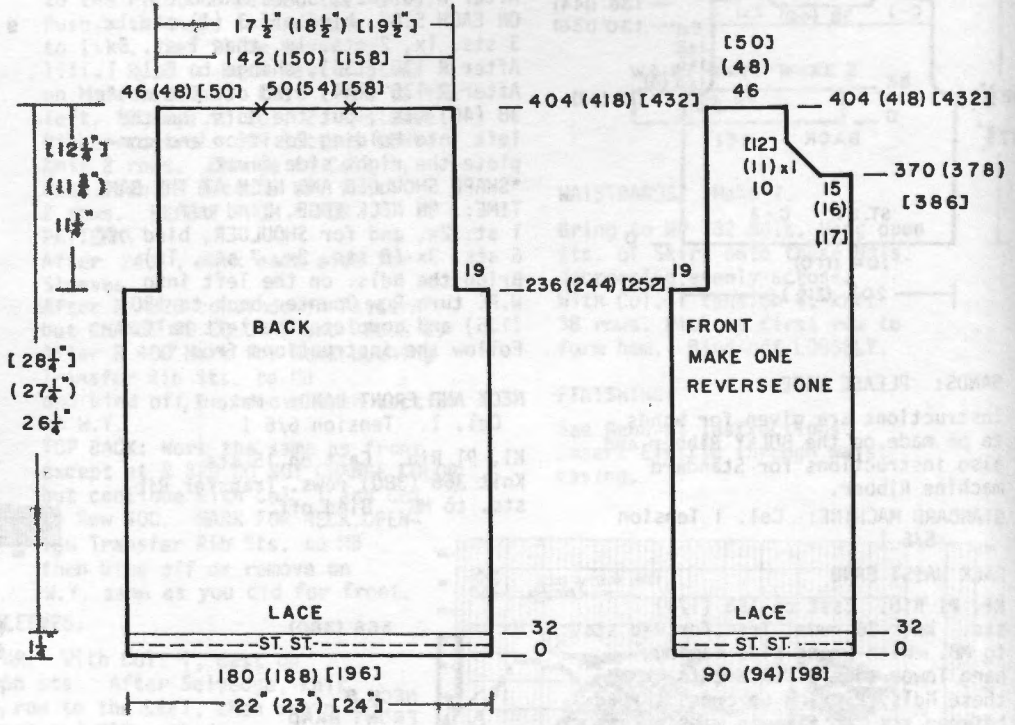
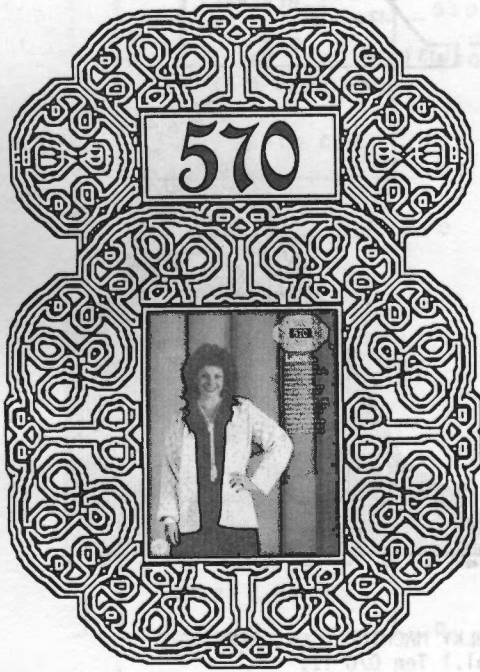

WOMENS LARGE SIZE JACKET

SIZES: 20/22 40/42 [44/46]
YARN: Venetia
AMOUNT: 1 3/4 2 2-1/4 lbs.
TENSION: Lace 4 - Rib. 2/2 II
GAUGE: 16 sts. 29 rows = 2"

Make on any Electronic Machine with
Lace Carriage and Ribber.
Pat. No. 154 in 930 Pat. Book.

BACK:

Cast on 180 (188) [196] sts.
Work St. st. to R 32.
Pick up first row of knitting
to form Hem.
Knit 2 rows.
CONTINUE IN LACE PATTERN.
After R 236 (244) [252] SHAPE
ARMHOLE: ON EACH SIDE, bind off
19 sts. Continue Lace Pat. to
R 404 (418) [432].
Mark each side with W.Y. for
Neck opening then bind off
each section separately or
remove onto W.Y.

FRONT: Make 1, reverse 1.

Cast on 90 (94) [98] sts. and work
same as Back. After hanging hem,
knit 2 rows then continue in
LACE PATTERN same as back.
After R 370 (378) [386], ON NECK
EDGE, bind off 15 (16) [17] sts.
then on Neck edge, decrease 1 st.
EOR 10 (11) [12]x.
After R 404 (418) [432], bind off
or remove onto W.Y.



SLEEVES:

Cast on 184 (192) [200] sts.
Knit 2 rows then continue in
LACE PATTERN. After R 34, ON EACH SIDE,
decrease 1 st. every 7th row 38
(39) [40]x.
After R 304 (312) [320] remove onto
contrast W.Y.

SLEEVE CUFFS: T 2/2 II

K1, P1 Rib. Cast on 79(83)[87] Sts.
Knit 40 rows. Transfer Rib sts.
to MB. With wrong side facing,
hang open sts. of sleeve onto these
Ndls. decreasing evenly across.
Bind off.

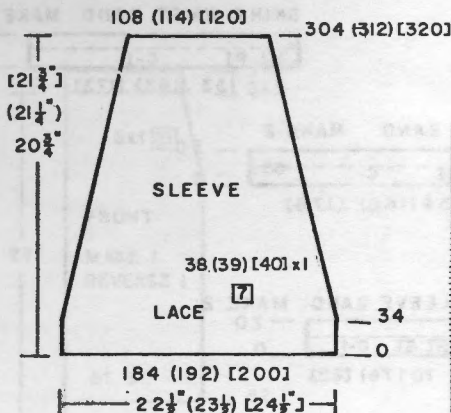
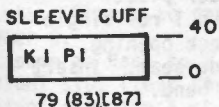

NECK BAND

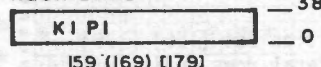

NECKBAND: T 2/2 II

Close shoulder first.
K1, P1 Rib. Cast on 159(169)
[179] sts. Knit 38 rows. Trans-
fer Rib sts. to MB. Pick up
first row of knitting to
form hem. With wrong side facing,
Hang neck edge onto these Ndls.
Bind off.

FINISHING:

See General Instructions.

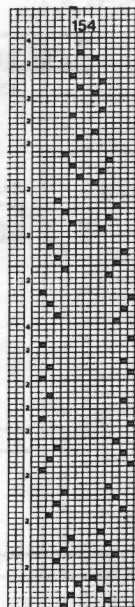

FRONT BANDS: Make 2 St. st.

Bring 164 (170) [176] Ndls.
to WP. With wrong side facing,
hang front edge onto these Ndls.
Knit 32 rows. Pick up first
row of knitting to form hem.
Bind off LOOSELY.
REPEAT FOR OTHER SIDE.

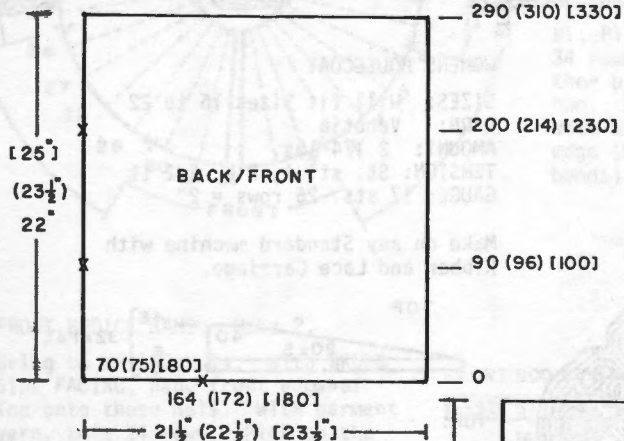
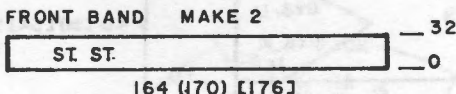

TOP BACK: St. st.
With W.Y. cast on same as front.
Change to Col. 1 and knit 4 rows
then begin Pattern Stripes
same as back. Mark for
NECK OPENING same as front
and complete in the same way
EXCEPT END WITH 6 Rows
Remove onto W.Y.

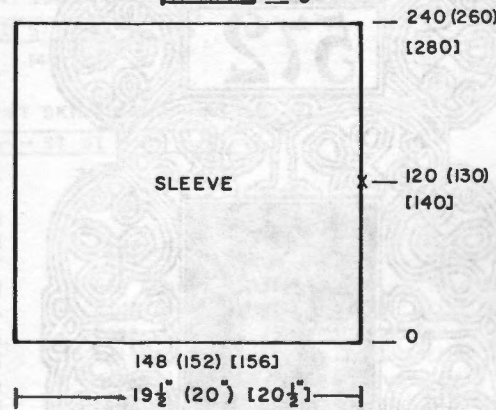
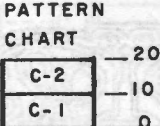

WOMENS SKIRT AND TOP
SIZES: 8/10 (12/14) [16]
YARN: Col. 1 = Venetia
Col. 2 = Capriccio
AMOUNT:
Col. 1 1 1/2 1 3/4 2 lbs.
Col. 2 6 7 7 balls
TENSION: St. st. 4.2 Rib. 2/2 II
GAUGE: 15 sts. 26 rows = 2"

Make on any Standard or Electronic
machine. Top is Stockinette st.
with stripes and is knitted
sideways.
Small amount of ribbing on Waist
Band for Skirt.

TOP FRONT: St. st.
With W.Y. cast on 164 (172) [180]
sts. Knit several rows ending with
1 row Ravel Cord to the right.
With W.Y. mark Ndl. 70 (75) [80]
for setting in sleeve.
Change to Col 1, Counter at 0.
Knit 6 rows.
* With Color 2, knit 10 rows.
With Color 1, knit 10 rows.
REPEAT FROM * THROUGHOUT.
After R 90 (96) [100] mark
side edge for NECK OPENING.
After R 200 (214) [230] mark for
NECK OPENING.
Continue in Pattern to Row
290 (310) [330] ending with
4 rows
Mark Ndl. 70 (75) [80] with
W.Y. same as you did in the
beginning for sleeve opening.
Remove onto W.Y.

SLEEVES: St. st. Col. 1.
With W.Y. cast on 148 (152) [156]
sts. Knit several rows ending
with 1 row Ravel Cord to the right.
Change to Col. 1. Counter 0.
*With Col. 1, knit 10 rows.
With Col. 2, knit 10 rows.
REPEAT FROM * THROUGHOUT.
After R 120 (130) [140] Mark each
side for center of sleeve,
Continue in color stripes.
After R 240 (260) [280] remove
onto W.Y.

Continued



WAIST BAND FOR TOP - St. st.
Make 2.

With W.Y. cast on 154 (166) [178] sts. Knit several rows ending with 1 row Ravel Cord to the right. Change to Col 1. Counter 0. Knit 30 rows. Pick up the first row to form hem. With WRONG SIDE FACING, hang the lower edge of FRONT/BACK onto these Ndls. Bind off.

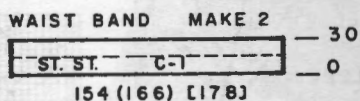

SLEEVE BANDS: St. st. Col. 1.

With W.Y. cast on 70 (76) [82] sts. same as Waist Band. Change to Col. 1. Counter 0. Knit 20 Rows. Pick up first knitted row to form hem. With WRONG SIDE FACING, hang lower sleeve edge onto these Ndls. Bind off.

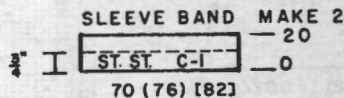

SKIRT: St. st. with SHORT ROWS. Col. 1.

With W.Y. cast on 184 (192) (200) sts. Knit several rows ending with 1 row Ravel Cord to the right. Change to Col. 1. Counter 0. Knit 6 rows. Carr. on right. *WORK SHORT ROWS.

Bring ALL NEEDLES TO HP. Push back into WP 11 Ndls. (See Chart).

Knit 2 rows. (Be sure to ALWAYS WRAP INSIDE NDLS. to prevent holes). Push back to WP 6 sts. on every other row 8x.

Bring to HP 6 St. EOR 8x. All Ndls. in WP.

Knit 6 Rows.

REPEAT FROM * 48 (51) [54]x

NOTE: End with knitting 4 rows over all Ndls. (This plus the 6 rows in beginning will make up one full Pattern).

Remove onto W.Y.

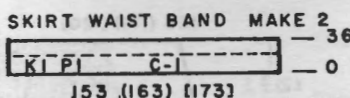
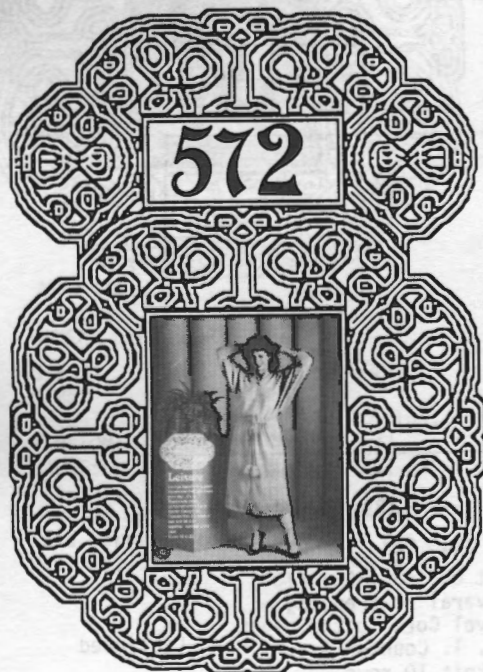
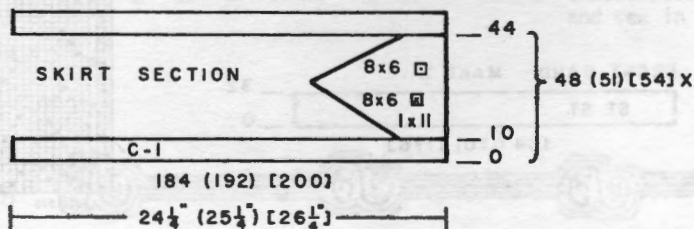

SKIRT WAIST BAND: Make 2, T 2/2 II.

K1, P1 Rib. Cast on 153 (163) [173] sts. WITH TENSION 2/2 II Knit 2 rows circular. Change to regular K1, P1 and knit 36 rows. Transfer rib sts. to MB. Pick up first row of ribbing to form hem. With WRONG SIDE FACING, hang 1/2 of Skirt waist. Bind off. Make second band the same.

FINISHING:

TOP: Using center markers as guide, join sleeve to body. Close side seams. Use approx. 3" to form shoulder pleat. With color 1, work 1 row single crochet around neck opening. SKIRT: Weave side seam. Insert elastic in waist band. Block pieces from wrong side.

WOMENS HOUSECOAT

SIZES: Will fit Sizes 16 to 22

YARN: Venetia

AMOUNT: 2 1/4 lbs.

TENSION: St. st. 4, Rib. 2/2 II

GAUGE: 17 sts. 26 rows = 2"

Make on any Standard machine with Ribber and Lace Carriage.

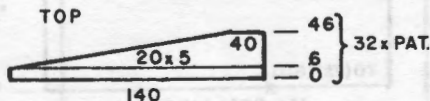

TOP:

With W.Y. cast on 140 sts. Knit several rows ending with 1 row Ravel Cord to the right. Change to garment yarn. Counter 0. Knit 4 rows.

*WORK SHORT ROWS.

ON OPPOSITE SIDE OF CARR, bring to HP 5 sts. 20x. (ALWAYS BE SURE TO WRAP INSIDE NDL. TO PREVENT HOLES).

40 sts. remain. Knit 6 rows over all Ndls.

REPEAT FROM * 32x IN ALL ending with 2 rows over all sts.

Remove on W.Y.

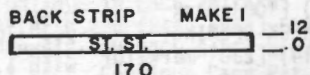

MAKE BACK STRIP NEXT.

With W.Y. cast on 170 sts. same as you did before. Change to garment yarn. Counter 0. Knit 12 rows. Remove on W.Y.

SKIRT BACK:

With W.Y. cast on 180 sts. same as before. Change to garment yarn. Counter 0.

Knit 24 rows. Pick up first row to form hem. Knit 2 rows then CONTINUE IN LACE PATTERN.

After R 62, change to St. st. Knit to R 260.

ON EACH SIDE, dec. 1 st. every 10th row 5x. After R 368, with WRONG SIDE FACING, hang open sts. of one side of BACK STRIP onto these Ndls. Knit 12 rows. Hang other side of BACK STRIP onto same Ndls. Knit 1 row over all Ndls. (This is Casing for the belt). Remove on W.Y.

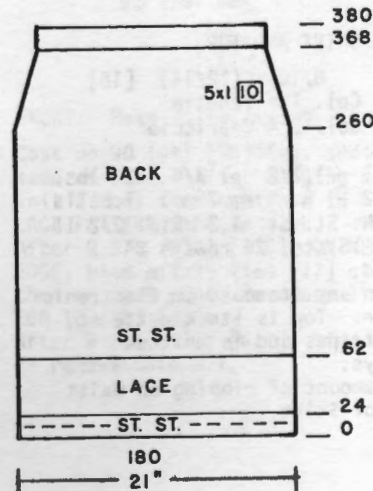

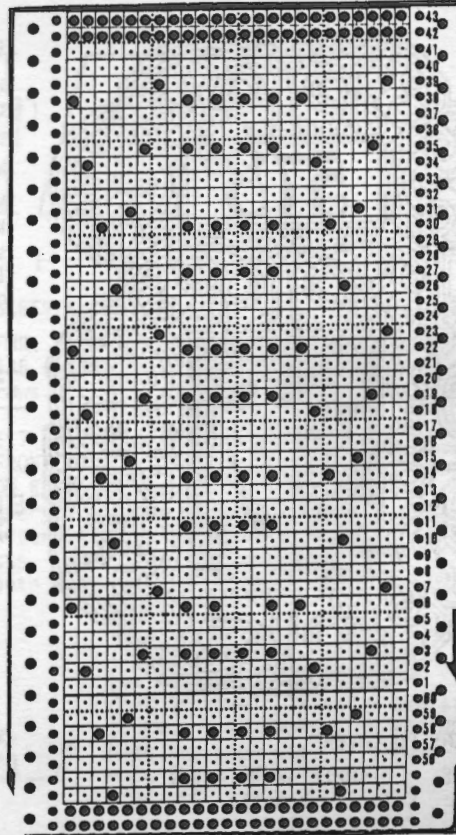
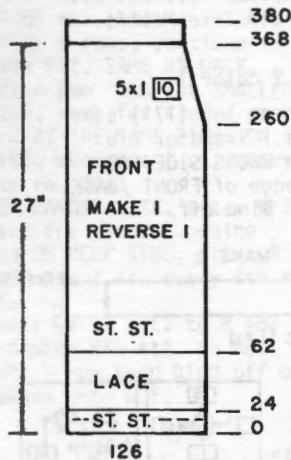
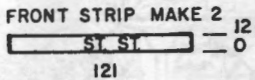

MAKE FRONT STRIP NEXT.- Make 2.
 With W.Y. cast on 121 sts. same as before. Change to garment yarn. Counter 0.
 Knit 12 rows. Remove on W.Y.

SKIRT FRONT: Make 1, reverse 1.
 With W.Y. cast on same as before. 126 sts. Change to garment yarn. Counter 0.
 Knit same as Back to R 260.
ON RIGHT SIDE (left for second section) decrease 1 st. every 10th row 5x.
 After R 368, with **WRONG SIDE FACING**, hang **FRONT STRIP** same as Back. Knit 12 rows.
 After R 380, hang hem. Knit 1 row over all Ndl's. Remove on W.Y.

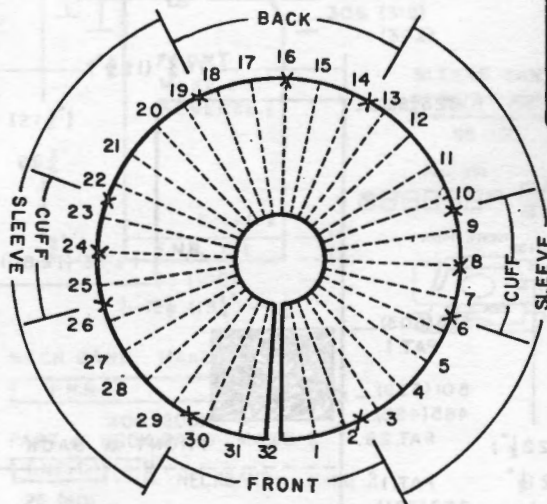

NECKBAND: Make 1 T 2/2 II
 K1, P1 Rib. Cast on 150 sts. Knit 34 rows. Transfer Rib sts. to MB then pick up first row to form hem. Knit 1 row over all sts. With **WRONG SIDE FACING**, hang neck edge (be sure to include front bands) onto these Ndl's. Bind off.

Follow Chart for Marks.
NOTE: You will see that the TOP is a CIRCLE, forming "Wedges" after each 46 rows of Pattern. In joining the pieces together, we will refer to these as Patterns and these refer to the bottom edge or wide part of the "Wedge".

Join Top to Skirt section in the following manner:
 Bring to WP 85 Ndl's. With **RIGHT SIDE FACING**, hang open sts. of 1 **SKIRT FRONT SECTION** onto these Ndl's. decreasing evenly across. Next, with **WRONG SIDE FACING**, hang 2 1/2 Patterns of TOP onto these same Ndl's. spacing evenly across. Bind off LOOSELY.
REPEAT THIS FOR OTHER FRONT SKIRT SECTION.

Join **BACK SKIRT SECTION**. Bring to WP 170 Ndl's. Hang open sts. Skirt section onto these Ndl's. same as front sections. Hang Patterns 13 1/2 through 18 1/2 (SEE CHART) onto these same Ndl's. Bind off LOOSELY. You have 11 Patterns on each side to form sleeves and of these Patterns, 3 on each side are used for the Cuffs. PLEASE SEE CHART.

SLEEVE CUFF: T 2/2 II
 K1, P1 Rib. Cast on 70 sts. Knit 20 rows. ON EACH SIDE, increase 1 st. every 3rd row 15x.
 After R 70, transfer Rib sts. to MB.
 With **WRONG SIDE FACING**, hang the 3 Patterns for Cuff onto these Ndl's. (See Chart). Bind off LOOSELY.
REPEAT FOR SECOND CUFF.

FRONT BODICE BAND: Make 2.
 Bring to WP 140 Ndl's. With **WRONG SIDE FACING**, hang front edge of Top onto these Ndl's. With garment yarn, knit 24 rows. Pick up the first row of knitting to form hem. Bind off.
REPEAT FOR OTHER SIDE.

FRONT SKIRT BANDS: Make 2.
 Bring to WP 200 Ndl's. With **WRONG SIDE FACING**, Hang front Skirt edge onto these Ndl's. With garment yarn, knit 24 rows. Hang hem and bind off.

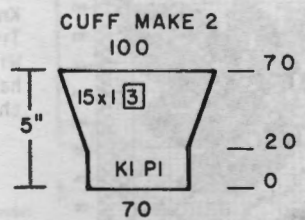
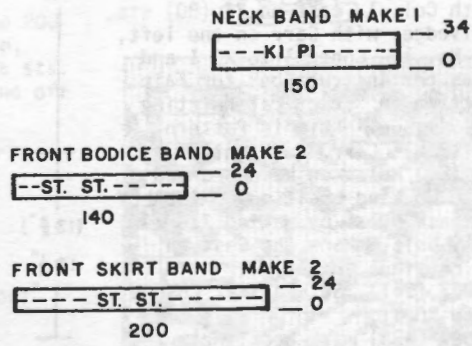

FINISHING:
 See General Instructions. Close side seams. Make Cord for Waist. Cast on 6 sts. Set machine for knitting a Cord (see Instruction Manual). Knit for as long as you need to go around waist and tie. See Picture. Make Tassels. (optional). Wind yarn around 6" Cardboard approx. 60 times. Tie one end and cut other end. Wrap yarn around top to form Tassel. Attach to ends of cord.

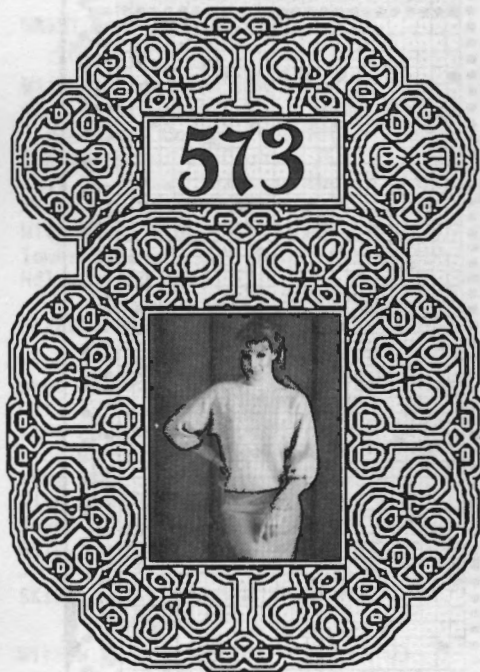

BACK:

Work the back the same as front but omit the single Fair Isle Motifs.

WAISTBAND: Make 2 color 1.

K1, P1 Rib: Cast on 165 (171) sts. Knit 40 (44) rows. Transfer Rib sts. to MB. With **WRONG SIDE FACING**, hang lower edge of **FRONT /BACK** onto these Ndl's. Bind off.

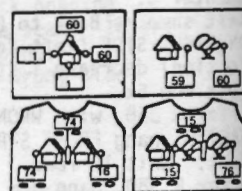
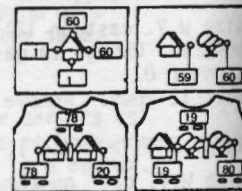
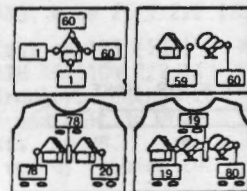
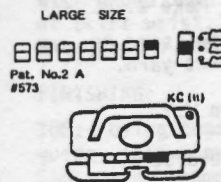
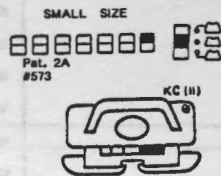
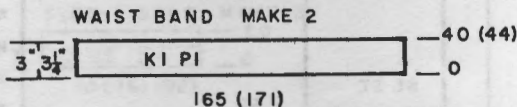

WOMENS PULLOVER

SIZES: 10/12 (14/16)

YARN: Col. 1 = Venetia
Col. 2 = Glace

AMOUNT:

Col. 1 1 lb. all sizes
Col. 2 1 Cone all sizes

TENSION: FNR 3.1/3.1 Rib. 0.2/0.2 I

GAUGE: 16 sts. 34 rows = 2"

Make on any Electronic machine with 900 Ribber and Color Changer. Full Needle Fair Isle and Single Motif Fair Isle.

FRONT: Use Color Changer

FNR: With Col. 1, cast on 76 (80) sts. After selvedge, with Carr on the left, Set Pat. No. 1. Control to KC I and proceed as per instructions for Fair Isle knitting in "Practical Knitting Hints" this issue. Knit in Pattern to R 230 (238) Carr. on Right. Bring 76 (80) Ndl's. on Main Bed and Ribber to Working position. **MANUALLY** cast on these Ndl's. by making ZIG ZAG over empty Ndl's. Hang the Cast on Comb and continue in Pat. 1. After R 243 (261) Set Pat. 2, Change KC Knob to KC II. After R 327 (335) mark neckline with W.Y. After R 363 (381) change to Pat. 1. After R 414 (432) mark center of garment with W.Y. Continue in Pattern to R 465 (483). Set Pat. 2 and continue in Fair Isle Motif. After R 501 (529) again mark for Neck opening. After R 585 (603) change to Pat 1. After R 598 (626) **ON THE RIGHT SIDE, TRANSFER 76 (80) sts. to MB** then bind off these sts. Continue in Pat. to R 825 (861). Cancel Pattern. Transfer Rib sts. to MB. Knit 3 rows. After R 828 (864), bind off.

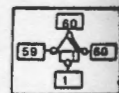
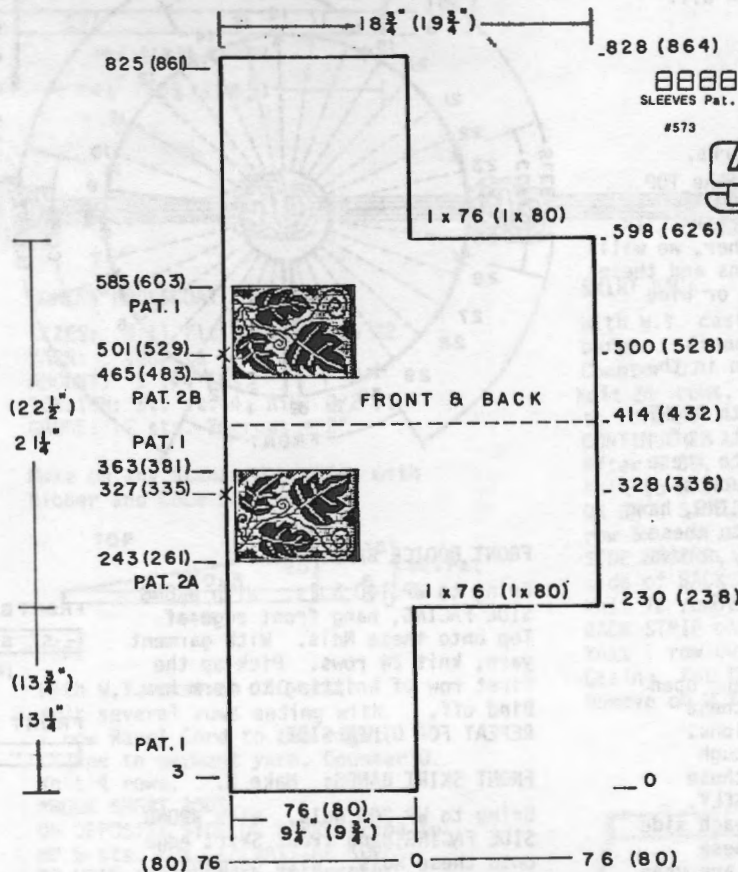

CLOSE BOTH SHOULDER SEAMS.

SLEEVE BANDS: Col. 1

K1, P1 Rib: Cast on 81 (87) sts. Knit 70 (74) rows. Transfer Rib sts. to MB. With **WRONG SIDE FACING**, hang lower edge of Sleeve onto these Ndl's. Bind off.

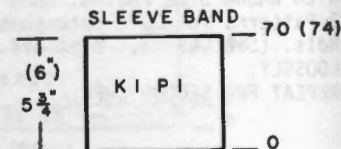

FINISHING:

See General Instructions.

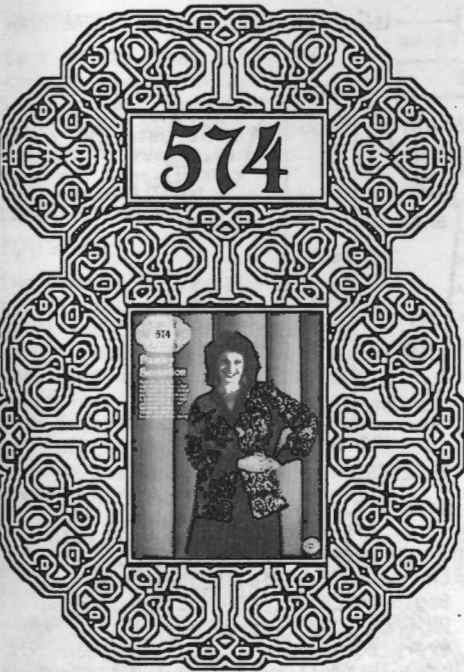

FRONT: Make 1, Reverse 1.
 FNR: With Col. 1, cast on 95 (100) sts. same as Back. After 9 rows, continue in Fair Isle Pat. SAME AS BACK. After Row 306 for SMALLER SIZE, mark for sleeve opening and AT THE SAME TIME, ON NECK SIDE, decrease 1 st. every 4th row 34x.
 FOR LARGER SIZE, after R 302 mark for sleeve opening and ON NECK SIDE, after R 318, decrease 1 st. every 4th row 36x.
 Continue in Pat. to R 452 (470). Transfer Rib sts. to MB. Knit 1 row then bind off or remove onto W.Y.

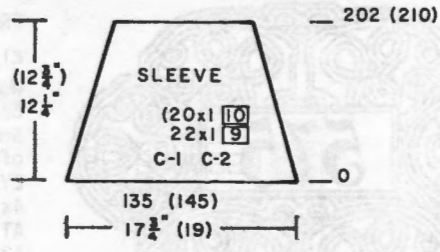

SLEEVES:
 FNR: With Col. 1, cast on 135 (145) sts. After Selvedge rows,
 SET FAIR ISLE PATTERN SAME AS BACK/FRONT.
 ON EACH SIDE, decrease 1 st. every 9 (10) rows 22 (20)x. After R 202 (210), transfer Rib sts. to MB. Knit 1 row. Remove onto W.Y.

WOMENS JACKET
 SIZES: 18/20 (22/24)
 YARN: Venetia = Col. 1
 Mami Rex = Col. 2
 AMOUNT:
 Col. 1 1 1/2 lbs. both sizes.
 Col. 2 6 8 Spools
 TENSION 4/4 for Pat.
 5/5 II for Bands
 GAUGE: 15 sts. 32.5 rows = 2"

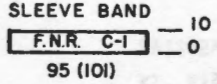
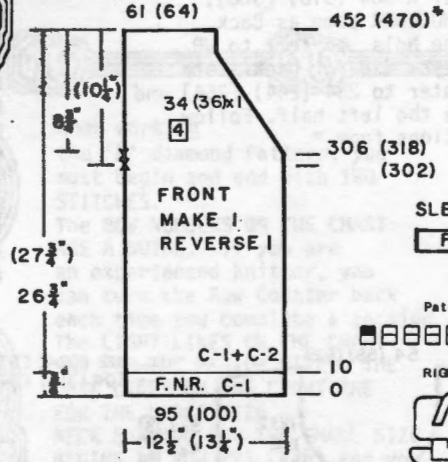

SLEEVE BANDS:
 FNR: With col. 1, cast on 95 (101) sts. After Selvedge; put Counter to 0. Knit 10 rows. Transfer Rib sts. to MB. With WRONG SIDE FACING, hang the open sts. of sleeve onto these Ndl's. Bind off.

Make on any Electronic machine with 900 Ribber recommended. Use Ribber Color Changer.

NOTE: For Fair Isle Design use 1 STRAND VENETIA and 2 STRANDS MAMI REX.
 NOTE: When using No. 5 Button UP (Reflections) BE SURE and enter the 1st and last row of Pattern on Mylar. Then enter 1st and last st. of Pat. on Mylar. (Regular Programming). After Ready Light press CE. Enter the last row of Pat. on Mylar Sheet.

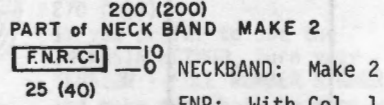
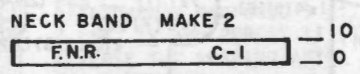

NECKBAND: Make 2
 FNR: With Col. 1, cast on 200 (200) sts. After selvedge, knit 10 rows. Transfer Rib sts. to MB, knit 1 row then bind off or remove onto W.Y.

ONCE YOU HAVE COMPLETED THE 70 Rows BE SURE TO TO RE-PHROGRAM AGAIN, for each Additional portion of Pattern.

NECKBAND: Make 2
 FNR: Col.1, cast on 25 (40) Sts. After Selvedge Knit 10 Rows. Transfer Rib Sts. to MB, Knit 1 Row Bind off or remove on W.Y.

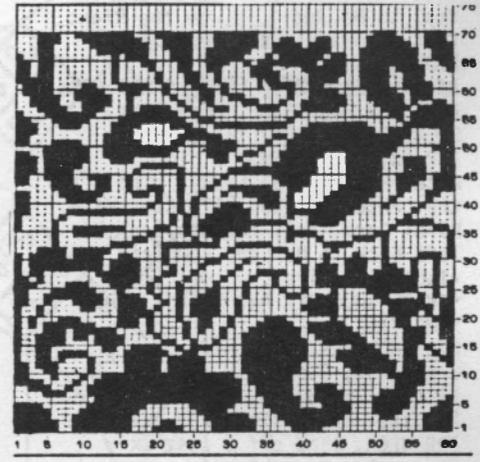
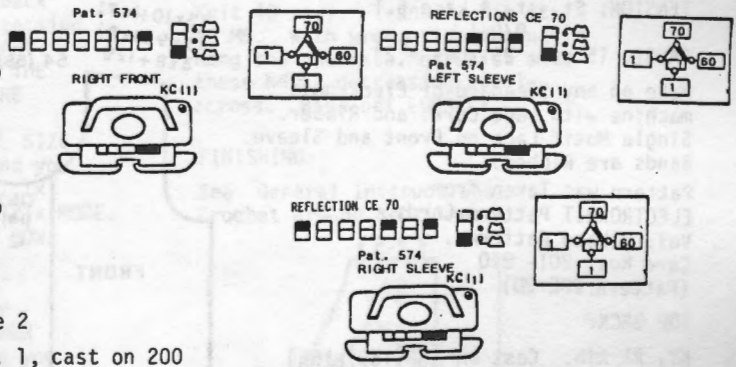

BACK:
 FNR: With Col. 1, cast on 95 (100) sts. Complete Selvedge then knit 9 rows. Carr. on LEFT. REFER TO PRACTICAL KNITTING HINTS THIS ISSUE for setting machine for Fair Isle Design with NO FLOATS on back. (Double Knit). Follow instructions and knit to R 306 (302). Mark each side with W.Y. for setting in sleeves. Continue in Pat. After R 452 (452), mark neck opening with W.Y. Transfer Rib sts. to MB, Knit 1 row then bind off or remove onto W.Y. each section separately.

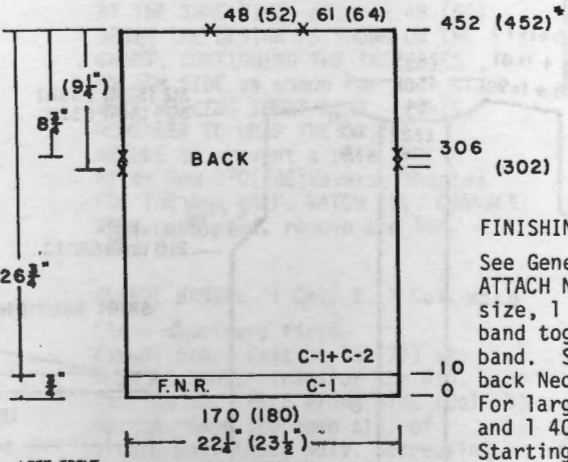

FINISHING:
 See General Instructions. ATTACH NECK BANDS: For small size, 1 200 st. and 1 25 st. band together to form one 225 st. band. Starting at Center back Neck, join strip to inside. For larger size, join 1 200 st. and 1 40 st. band together. Starting at Center back, join strip to inside with the 40 st. section on the lower front edge.

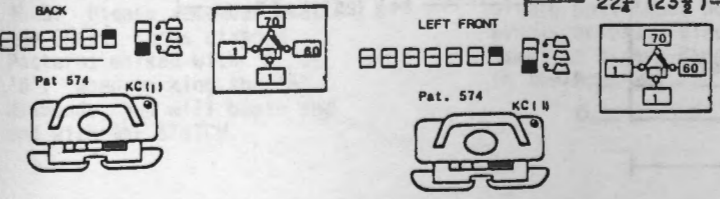

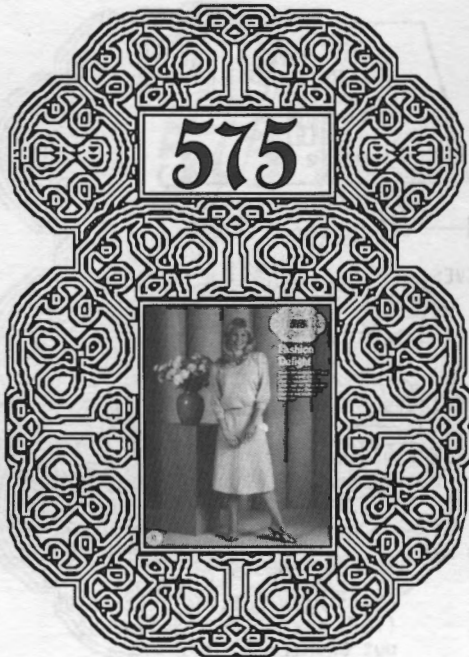

WOMENS TWO PIECE DRESS

SIZES: 10/12 (14/16) [18/20]
 YARN: Venetia
 AMOUNT: 2 2 1/4 2 1/2 lbs.
 TENSION: St. st. & Lace 5.1
 Rib. 0/0 I
 GAUGE: 15 sts. 25 rows = 2"

Make on any Standard or Electronic machine with Lace Carr. and Ribber. Single Motif Lace on Front and Sleeve. Bands are Ribbed.

Pattern was Taken from ELECTROKNIT Pattern Cards Vol. 2 Lace Patterns. Card Nos. 201- 210 (Pattern 202 3D)

TOP BACK:

K1, P1 Rib. Cast on 149(159)[169] sts. Knit 40 rows. Transfer Rib sts. to MB. Add 1 St. on the Right. Knit 2 rows St. st. then begin ISOLATED LACE PAT.

After R 210 (216) [222] SHAPE ARM-HOLE: ON EACH SIDE, dec. 1 st. EVERY ROW 9 (10) [11]x, 1 st.

EOR 6x, After R 304 (316) [328], bind off the center 24 (28) [32] sts. With Ravel Cord, knit the sts. on the left back to NWP and complete the right side first.

*SHAPE SHOULDER AND NECK AT THE SAME TIME.

FOR SHOULDER, bind off 8 sts. 3x, 9 sts. 1x

(9 sts. 3x, 8 sts. 1x) [10 sts. 3x, 7 sts. 1x]

FOR NECK, bind off 6 sts. 2x 2 sts. 1x, 1 st. 1x.

Gently pull on Ravel Cord to bring the Ndls on the left to W.P. Be sure they are in the hooks of Ndls.

Turn the Counter back to 304 (316) [328] and complete the left half. Follow instructions from *.

FRONT:

K1/P1 Cast on 159(169)[179] Sts.

Work the front the same as the back to R 210 (216) [222].

SHAPE ARMHOLE: ON EACH SIDE, bind off 6 (7) [8] sts. 1x, 1 st.

EVERY ROW 7x, 1 st. every 2nd row 4x, 1 st. every 3rd row 3x, BUT

AT THE SAME TIME, after R 234 (244) [254], bind off the center 12 (14) [16] sts. With

Ravel Cord knit the sts. on the left back to NWP as you did for back. NOTE ROW NUMBER FOR

LACE PATTERN. Complete the right side first.

*ON NECK EDGE, BIND OFF 4 (5) [6] sts. then bind off 3 sts. 1x,

2 sts. 1x, 2 sts. 12x. and after R 304 (316) [328],

SHAPE SHOULDER same as Back. Bring the Ndls. on left to WP

same as you did for back. Turn Row Counter to 234 (244) [254] and

complete the left half. Follow instructions from *

15 1/2 (16 1/2) [17 1/2]

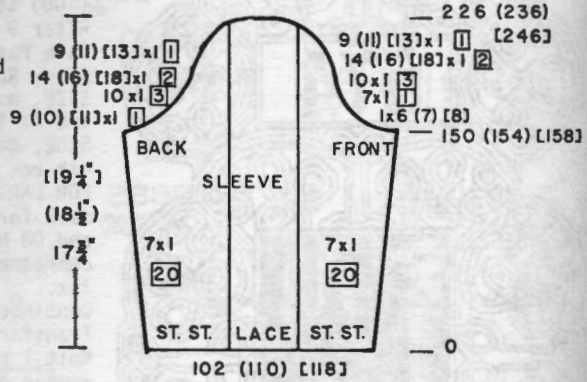

SLEEVES:

With W.Y. cast on 102 (110) [118] sts. After several rows, end with 1 row Ravel Cord to the right. Change to Venetia, Counter 0. Begin ISOLATED LACE PATTERN. ON EACH SIDE, increase 1 st. every 20th row 7x. After R 150(154)[158] SHAPE SLEEVE CAP: FOLLOW THE CHART in Your Size for the Decreases. (Different on each side) After Row 226(236)[246] Bind off the remaining Sts.

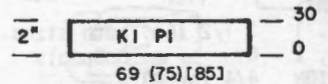
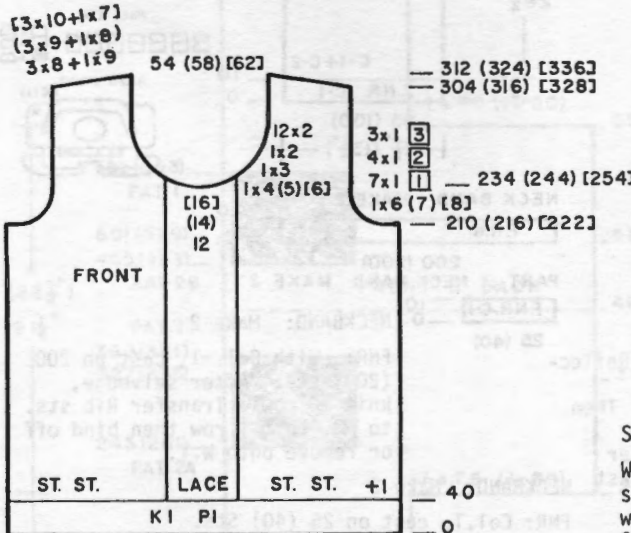

SLEEVE CUFFS:

K1, P1 Rib: Cast on 70 (76) [84] sts. and knit 30 rows. Transfer Rib sts. to MB. With wrong side facing, hang open sts. of sleeve onto these Ndls. decreasing evenly across. Bind off.

SKIRT:

With W.Y. cast on 185 (190) [195] sts. After several rows, end with 1 row Ravel Cord to the right. Change to Garment yarn, Counter 0. Knit 6 rows.

*WORK SHORT ROWS.

ON OPPOSITE SIDE OF CARR. bring to HP 10 sts. knit 2 rows. ALWAYS WRAP INSIDE NDL. TO PREVENT A HOLE. ON EVERY 2nd ROW, bring to HP

20 sts. 5x, 30 sts. 2x. Bring all Ndls. to WP and knit 14 rows.

REPEAT FROM * 27 (29) [31]x MORE. ending with 7 rows over all Ndls. Remove on W.Y.

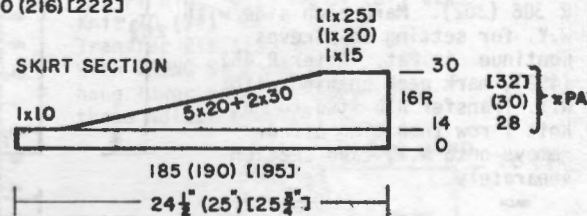
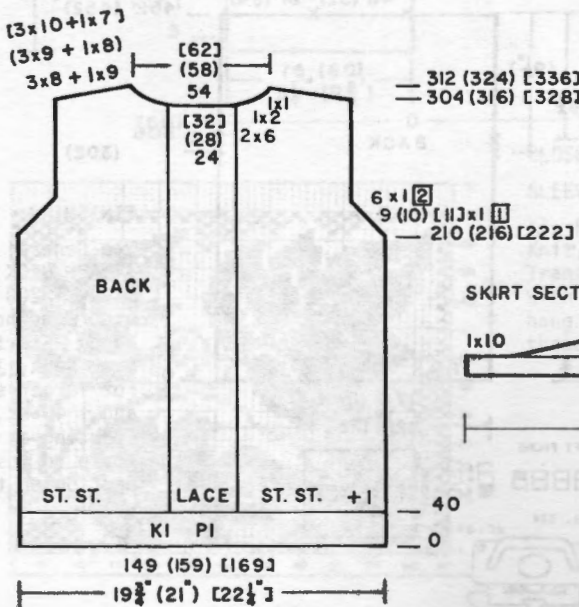

WAISTBAND: Make 2. St. st.
 Cast on 140 (148) [156] sts.
 Knit 32 rows. Pick up first row
 to form hem. Hang half of
 Skirt waist onto these Ndl's.
 decreasing evenly across.
 Bind off loosely.
 REPEAT FOR 2nd HALF OF WAIST.

WAIST BAND MAKE 2
 ST. ST. 32
 0
 140 (148) [156]

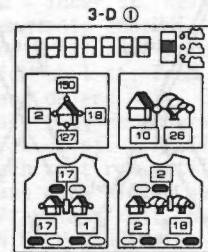
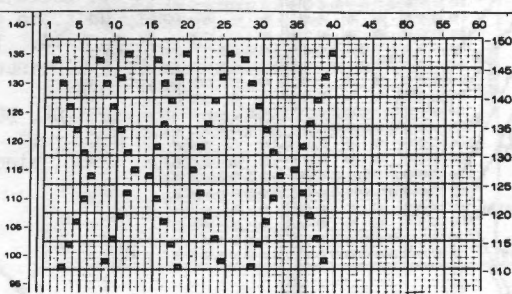

FINISHING:
 See General Instructions.
 Lightly steam open edges of
 Skirt and then weave together.
 Work 1 row single crochet around
 neck opening then work Scallops
 as follows: *Ch 1, skip 4 sts.
 Work 6 double crochets in next
 st. REPEAT FROM * AROUND.
 Also do one row of Scallops
 around Skirt Bottom.

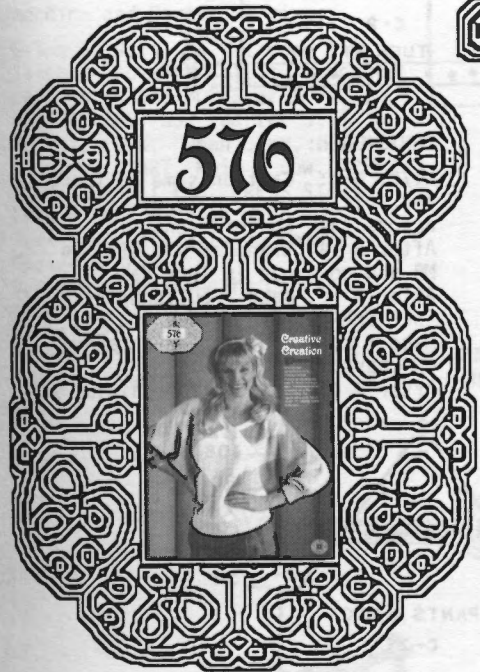

When working
 the 'B' diamond Pattern, you
 must begin and end with TWO
 STITCHES.
 The ROW NUMBERS ON THE CHART
 ARE A GUIDE. If you are
 an experienced knitter, you
 can turn the Row Counter back
 each time you complete a section.
 The LIGHT LINES ON THE CHART
 ARE FOR THE MEDIUM SIZE. THE
 DARK LINES ON THE CHART ARE
 FOR THE LARGE SIZE.
 NECK SHAPING FOR THE SMALL SIZE
 BEGINS AT ROW 223 (235) and you
 alternately decrease 1 st. 1x,
 2 sts. 1x and REPEAT 11 (12)x MORE.
 REVERSE THE SHAPING AFTER ROW
 270 (286)
 If you prefer to use the
 INTARSIA METHOD, Turn your
 TENSION 1 FULL NUMBER HIGHER
 and make swatch to be sure you
 get the stitch and row gauge.

WAIST BAND MAKE 2
 2 1/4 1 KI PI C-1 40
 0
 139 (149)

WAISTBAND: Col. 1 - Make 2.
 K1, P1 Rib: Cast on 139 (149) sts.
 Knit 40 rows. Transfer Rib sts.
 to MB. With wrong side facing,
 hang the open sts. of waist onto
 these Ndl's. decreasing evenly
 across. Bind off LOOSELY.

FINISHING:
 See General Instructions.
 Crochet around Neckline.

WOMENS SWEATER
 SIZES: Medium (Large)
 YARN: Roma
 Col. 1 4 ounces all sizes
 Col. 2 3 " " "
 Col. 3 3 " " "
 Col. 4 1 " " "
 Col. 5 3 " " "
 Col. 6 2 " " "
 TENSION: St. st. 4, Rib 1/0.2 II
 GAUGE: 14 St. 22 1/2 R = 2"

FRONT/BACK: Two sections the same.
 With W.Y. cast on 67 (71) sts.
 After several rows, end with 1
 row Ravel Cord to the right.
 Change to Color 3. Counter 0.
 ON THE LEFT, INCREASE 1 st.
 every 7th row 7x (every 9th
 row 1x, every 7th row 5x).
 AT THE SAME TIME, after R 48 (50)
 BEGIN THE DESIGN AS SHOWN ON THE
 CHART, CONTINUING THE INCREASES
 ON ARM SIDE as shown for your size.
 WHEN WORKING SHORT ROWS, ALWAYS
 REMEMBER TO WRAP THE INSIDE
 NEEDLE to prevent a hole.
 After Row 270(286)Reverse Shaping
 FOR THE 2nd HALF. WATCH COL. CHANGES.
 When completed, remove the Sts.
 onto W.Y.

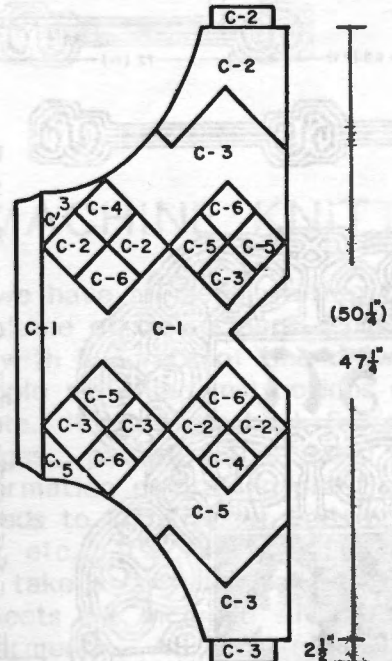

Make on any Standard Machine with
 Ribber. Stockinette stitch with
 diamond designs made with Short
 Row knitting or you can use
 Intarsia method.
 Bands are K1, P1 Ribbing.

FOR EXPERIENCED KNITTERS.
 IMPORTANT: - When working Short
 Rows, ALWAYS WORK THE DECREASE
 SHORT ROWS FIRST ACROSS THE
 NEEDLE BED, then GO BACK AND
 FILL IN WITH THE INCREASE SHORT
 ROWS. Please remember that
 the Chart shows diamond
 Patterns marked with 'A' or
 'B'. When working the 'A'
 diamonds, you will begin and
 end with ONE STITCH.

SLEEVE BANDS: 1 Col. 3, 1 Col. 2
 Close shoulders first.
 K1, P1 Rib: Cast on 73 (77) sts.
 Knit 40 rows. Transfer the Rib.
 sts. to MB. With wrong side (Col. 3)
 facing, hang the open sts. of
 sleeve onto these Ndl's. decreasing
 evenly across. Bind off loosely.
 Make 2nd Sleeve Band with Col. 2
 in the same way.

SLEEVE BANDS 40
 2 1/4 1 KI PI 0
 73 (77) CONTINUED



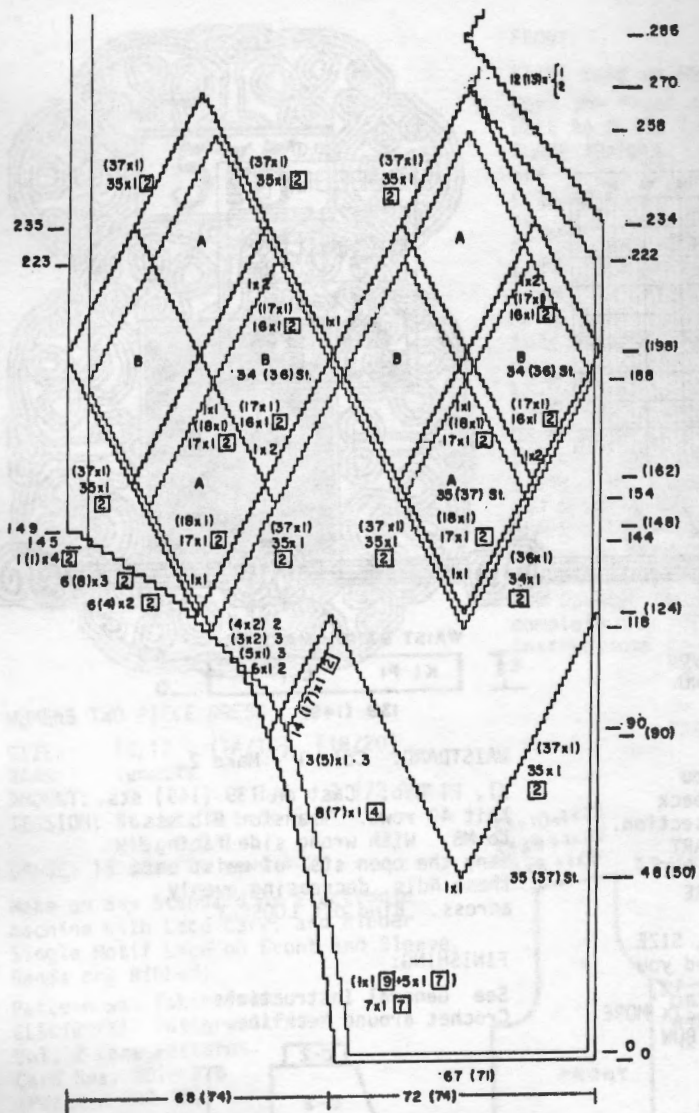

PANTS FRONT:

K1, P1 Rib. With color 2, cast on 69 sts. Knit 6 rows, then make eyelets across. Transfer every 10th st. to adjacent Needle. Leave empty Ndl's. in work. Knit to R 14. Trans. Rib' sts. to MB. Continue in TUCK PAT. Knit to R 54. ON EACH SIDE, BO 5 sts. 1x. then dec. 1 st. EOR 20x. After R 96, bind off remaining sts.

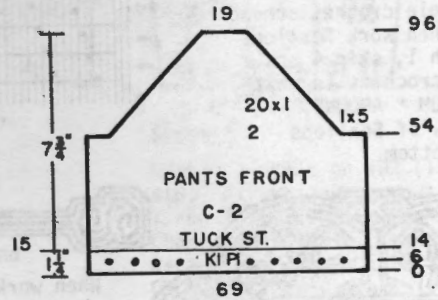

PANTS BACK:

K1/P1 Rib: Cast on same as front and knit 6 rows. Make eyelets across same as for front. After R 14, transfer Rib sts. to MB and continue in Tuck Pat. After R 91, make 2 buttonholes. (SEE CHART). Knit to R 108 and make 1 more buttonhole as shown on Chart. After R 112, bind off remaining sts.

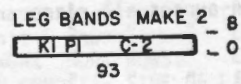
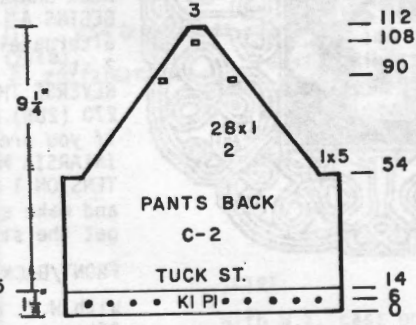

BABY ENSEMBLE

SIZES: 3 to 6 Months
YARN: Amore
AMOUNT:
 Col. 1 2 Balls
 Col. 2 1 Ball
TENSION: 8 - Rib. 3.1/3.1 I
GAUGE: 11 sts. 21 rows = 2"

Make on any Standard or Electronic machine with Ribber. Pullover, Pants, Bonnet are a Tuck St. Bands are Ribbed. Booties are Garter St. using GARTER CARRIAGE and Lace using KH 930 machine. The Booties can be made in Stockinette stitch with DOUBLE EYELET Punch Card for Lace.

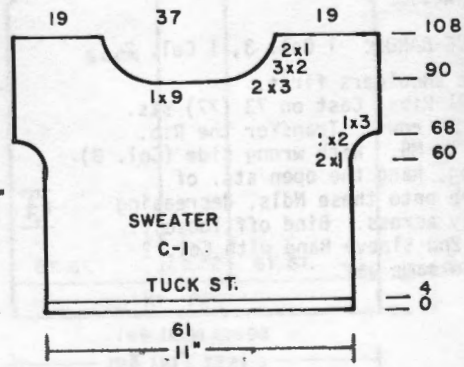

LEG BANDS: Make 2. Close 1 side.

K1, P1 Rib. With Col. 2, cast on 93 sts. Knit 8 rows. Transfer Rib sts. to MB. With WRONG SIDE FACING, hang, hang leg edge onto these Ndl's. Bind off.

SWEATER: FRONT/BACK the same.

With W.Y. cast on 61 sts. Knit several rows ending with 1 row Ravel Cord to the right. Change to Col. 1. Counter 0. With Latch Tool, cast on using the crochet method. Knit 1 row to left then set Tuck st. Pat. (If using Punch Card, set on STOP for 4 rows to form a small scallop edge. Continue in Tuck Pat. to R 60. ON EACH SIDE, increase 1 st. 2x, 2 sts. 1x, 3 sts. 1x. After R 90, bind off center 9 sts. Put the sts. on left into HP and complete right side first.



*ON NECK EDGE, BO 3 sts. 2x,
2 sts. 3x, 1 st. 2x.
Bind off the remaining 19 sts.
Bring the Ndls. on left to WP.
Turn Counter back to 90 and
complete the left half.
Follow instructions from *.

BONNET:

Cast on 82 St. same as
for Front/Back. After Ravel Cord
row, put Counter to 0. Change to
Col. 1 and set for Tuck stitch
Pat.
After R 12, make eyelets across.
Transfer every 8th st. to adjacent
Ndls. Leave empty Ndls. in work.
Continue in Pat. to R 78.
Bind off or remove on W.Y.

BOOTIES: T 8 for both 930
machine and Garter Carriage.

Bring 60 Ndls. to WP. Open all
latches and with Col. 1, crochet
cast on in the HOOKS of Ndls.
PROGRAM PAT. 537 (Garter St.)
Knit 12 rows. When Carr. reaches
0, press START, knit 1 row. PRESS
START, knit 1 row, PRESS START,
knit 8 rows. Break yarn.
Turn CompuKnit off and remove
Garter Carriage.
Replace with Standard Carriage.
ON EACH SIDE, remove 15 sts. on
waste yarn, then remove 9 sts.
on each side onto separate W.Y.
12 sts. remain.

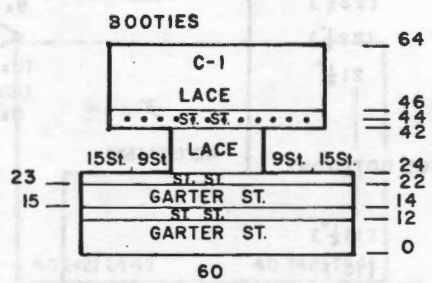
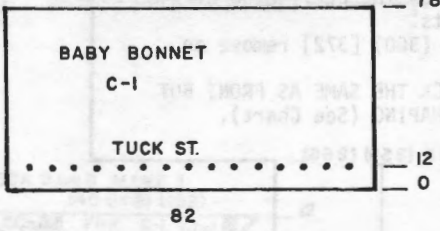
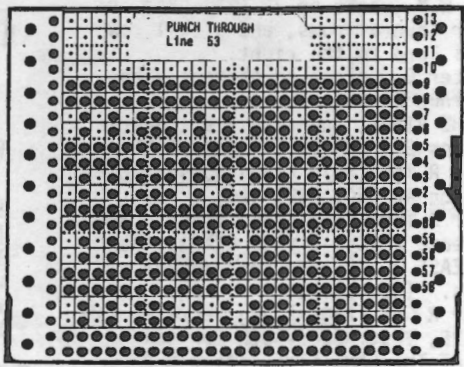

Knit 2 rows then PROGRAM PAT.104
and work LACE PAT. BUT AT THE SAME
TIME, ON OPPOSITE side of Carr.
BEFORE working the knit rows, pick
up 1 inner st. held on W.Y. and
hang onto end Nd1. (2 sts. on
end Nd1.) Knit across to left,
pick up 1 st. from right W.Y. and
hang on end Nd1. Continue in
Lace Pat, remembering to ALWAYS
pick up st. OPPOSITE CARR. before
each knit row until all 9 sts.
have been picked up on each side.
After last knit row, break ya .
ON EACH SIDE, pick up the 15 sts.
from W.Y. - 42 sts. Attach Yarn
and knit 2 rows. Make EYELETS
ACROSS. Transfer every 5th st. to
6th Nd1. 6 eyelets on each side of 0.
Leave empty Ndls. in work. Knit
2 rows Put Counter to 0, PRESS
START then continue in Lace Pat.
to R 18. Bind off LOOSELY.

FINISHING FOR BOOTIES

Sew back seam. Gather heel
edge for 1/2" and gather Toe edge
for 1" then sew across foot. With
Col. 2, work 1 row reverse single
crochet around top of bootie. Make
Cord over 2 Ndls. T 8 or make
twisted cord to pull through
eyelets and tie in bow.
OPTIONAL: Make 4 flowers as
follows: Ch 3, single crochet
in first chain.
*Ch 3, 2 double crochets in same
place as first sc. Single crochet
in same space. REPEAT FROM *
until 4 petals have been made.
Attach flowers to ends of cord.

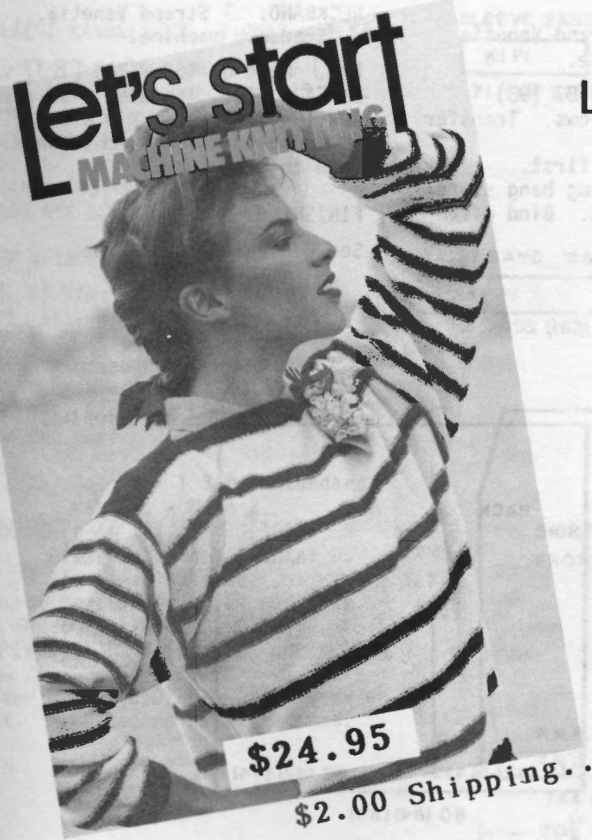

LET'S START MACHINE KNITTING....

This is the book we have all been waiting for..
A step by step volume of instructions... pro-
fusely illustrated with hundreds of line drawings,
caricatures of people mouthing instructions and
humorous comments.. It's a large book 8-3/4 x
11-3/4" and 158 pages... packed full of good easy
to understand information embracing practically
everything one needs to know about knitting,
blocking, finishing, etc... It's so complete it even
tells you when to take a coffee break! Six full
size Knitleader sheets are included with instruct-
ions for twelve garments....All illustrated in full
color...

It's the best practical machine knitting instruct-
ion book yet and it's excellent for all Japanese
made knitting machines.

Order from your local dealer or direct from
KNITTING at 1128 Crenshaw Blvd., Los
Angeles , California 90019.



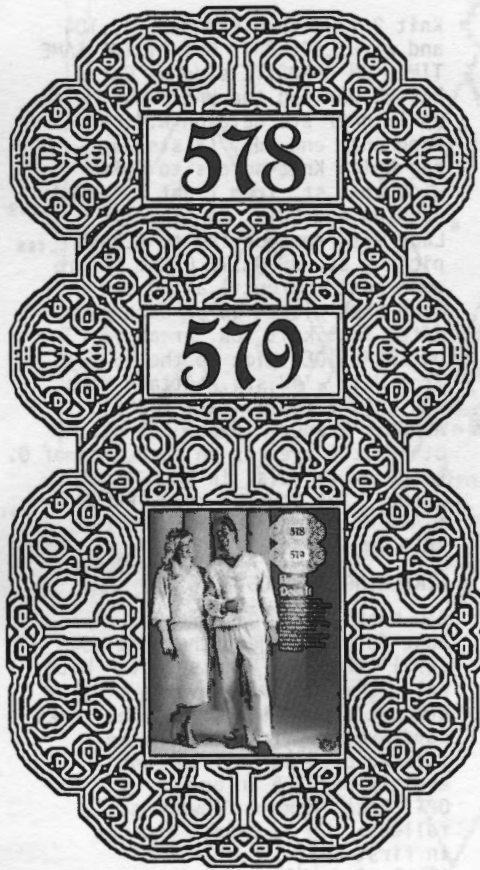

578

579



MANS SWEATER 578

SIZES: 36/38 (40/42) [44/46]
 YARN: Pebble = Col. 1
 Venetia = Col. 2
 AMOUNT:
 Col. 1 2 2-1/2 3 Cones
 Col. 2 1 Lb. All Sizes
 TENSION: St. st. 5.2 - Rib 1.1/1.1 II
 FNR 6/6I (Ribbing on Standard machine.)
 GAUGE: 7 1/2 sts. 13 Rows = 2"

Make Body of Sweater on BULKY machine.
 Knit Ribbing on Standard machine.
 Knitted SIDEWAYS ON THE MACHINE
 USING 1 strand Pebble and 1 strand Venetia, Purl Side is Right Side.

SLEEVE BANDS 42
 KI PI 0
 87 (93) [99]

579

WOMENS SKIRT AND TOP 579

SIZES: 10/12 (14/16) [18]
 YARN: Pearlite = Col. 1
 Pebble = Col. 2
 AMOUNT:
 Col. 1 2 lbs. all sizes.
 Col. 2 1 1/2 1 3/4 2 lbs.
 TENSION: 4 St. st. Rib 0/0 II
 GAUGE: Top: 7 1/2 sts. 12 1/2 rows = 2"
 Skirt: 14 sts. 18 Rows = 2"
 Rib: 0/0 II

The body of Top was knitted on Bulky machine. Cuffs and waistband on Standard machine with Ribber in Full Needle Rib (FNR). Purl side is right side.

FRONT:

With W.Y., cast on 20 (22) [24] sts. After several rows, end with 1 row Ravel Cord to the right. Counter 0. Change to garment yarn. Continue in St. st.
 ON THE RIGHT, increase 1 st. every 5th row 22x BUT AT THE SAME TIME after R 105 (107) [109], ON THE LEFT cast on 48 (50) [52] sts.
 After R 156 (160) [164] SHAPE V NECK. Decrease 3 sts. 9 (10) [11]x, then INCREASE 3 sts. the same number of times. (See Chart)
 After R 238 (250) [262] decrease for SLEEVE, 1 st. every 5th row 22x BUT AT THE SAME TIME, after R 245 (255) [265] ON THE LEFT, bind off 48 (50) [52] sts.
 After R 348 (360) [372] remove on W.Y.
 WORK THE BACK THE SAME AS FRONT BUT OMIT NECK SHAPING (See Chart).

WAIST BAND MAKE 2
 KI PI 0
 179 (189) [199]

WAIST BANDS: Make 2 - 1 strand Venetia - Standard Machine.
 K1, P1 Rib: Cast on 179 (189) [199] sts. Knit 42 rows. Transfer Rib sts. to MB. With wrong side facing, hang lower edge of FRONT/BACK onto these Ndl's. Bind off.

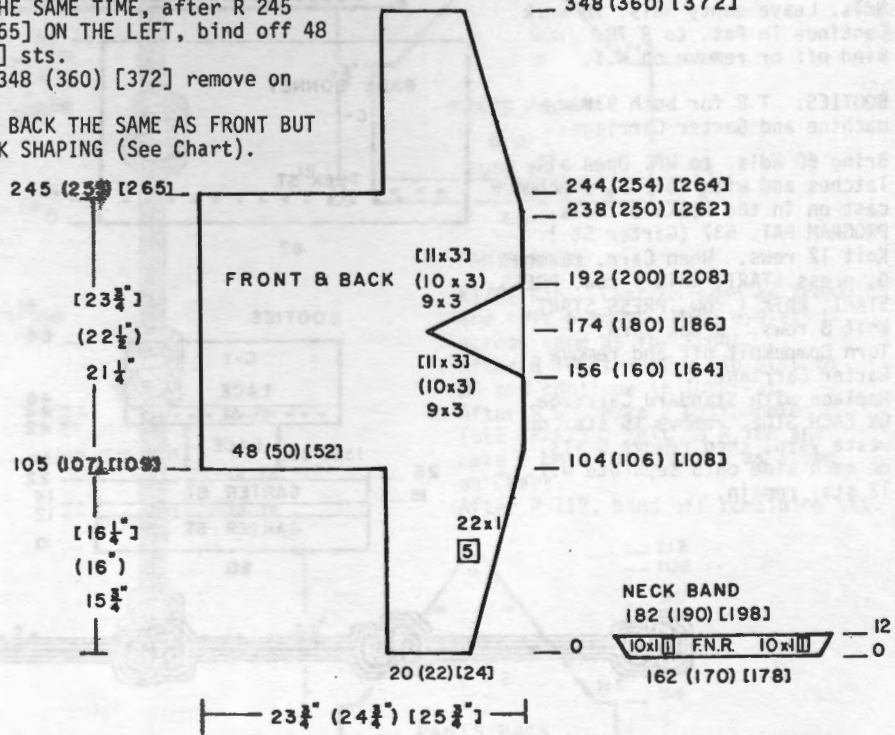

SLEEVE BANDS: 1 strand Venetia Standard Machine.
 K1, P1 Rib. Cast on 87 (93) [99] sts. Knit 42 rows. Transfer Rib sts. to MB. Join shoulder seams first. With WRONG SIDE facing hang sleeve edge onto these Ndl's. Bind off.

NECKBAND: 1 Strand Venetia. Standard machine.
 FNR. Cast on 162 (170) [178] sts. ON EACH SIDE, increase 1 st. EVERY ROW 10x. Transfer Rib sts. to MB and bind off or remove on W.Y. Join to Neck Edge.
 FINISHING:
 See General Instructions.

TOP BACK: Knitted sideways. on Bulky machine.
 With W.Y. cast on 80 (84) [88] sts. After several rows end with 1 row Ravel Cord to the right. Change to garment yarn, Counter 0. USE 1 STRAND OF PEARLITE, 1 STRAND OF PEBBLE.
 With W.Y. mark center st. (See Chart). Continue in St. st. After R 46 (48) [50], mark right side with W.Y. for neck opening. After R 86 (92) [98] again mark for neck opening. After R 132 (140) [148] mark center st. then remove onto W.Y.

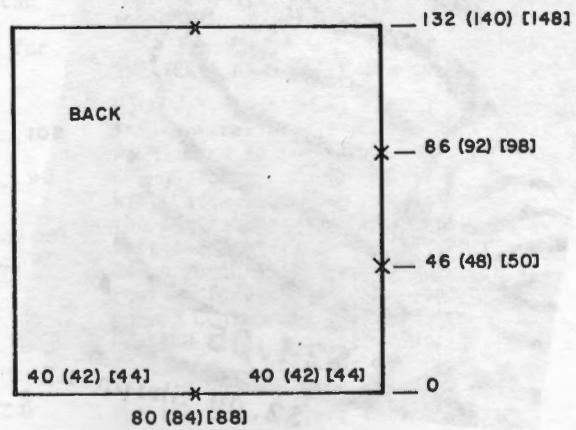

TOP FRONT:

Work the front the same as back to R 46 (48) [50]. SHAPE V neck. ON NECK EDGE, dec. 3 sts. EOR 10x (2 sts. 1x, 3 sts. 10x) [2 sts. 2x, 3 sts. 10x] YOU CAN USE SHORT ROWS FOR THE NECK SHAPING, BUT YOU MUST WORK THE SHORT ROWS FROM THE LEFT SIDE. WHEN THE DECREASES AND INCREASES ARE COMPLETED, WITH W.Y. KNIT AT LEAST 12 ROWS, THEN DROP THE NECK STS. OFF THE MACHINE. Later, YOU CAN CUT THROUGH CENTER OF W.Y. CAREFULLY, THEN FINISH THE NECK EDGE. After R 66 (70) [74], ON NECK EDGE, increase EOR 3 sts. 10x (2 sts. 2x, 3 sts. 10x) [2 sts. 3x, 3 sts. 10x]. Knit to R 132 (140) [148]. With W.Y. Mark for sleeve then remove onto W.Y.

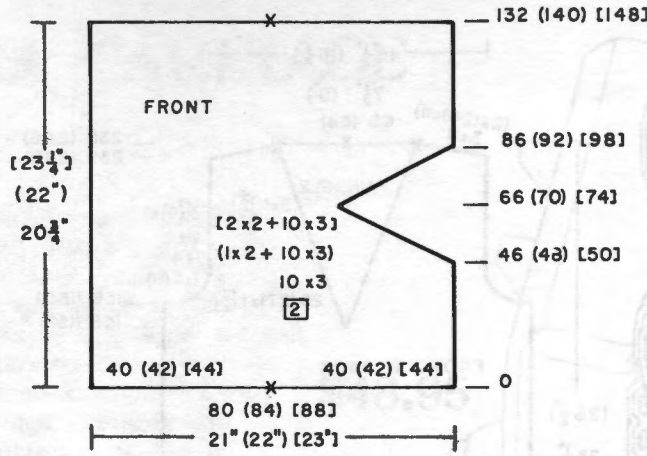

NECKBAND: CLOSE 1 SHOULDER.

FNR: STANDARD RIBBER. With Col. 1 - 1 strand only. CO 120 (126) [132] sts. After Selvedge, T 3/3 II Counter 0. ON EACH SIDE, increase 1 st. EVERY ROW 10x. After R 12, transfer Rib sts. to MB. WITH KNIT SIDE FACING, pick up sts. around neck and hang onto these Ndl's. Bind off LOOSELY.

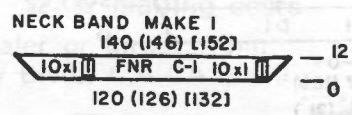

SLEEVES: CLOSE 2nd SHOULDER.

Bring to WP, 80 (84) [88] Ndl's. WITH PURL SIDE FACING, and using W.Y. markers as guide, hang sleeve edge of Back/Front onto these Ndl's. With garment yarn, knit 94 (100) 106 rows. Remove on W.Y. Knit 2nd sleeve in same manner.

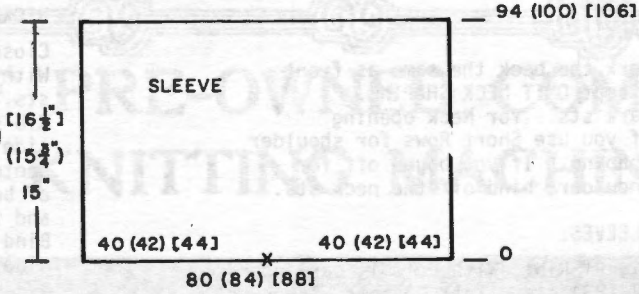

SLEEVE BANDS: COL. 1 ONLY - 1 Strd.

K1/P1 Rib: Cast on 71 (75) [79] sts. After Selvedge, knit 46 rows. Transfer rib sts. to MB. With KNIT SIDE FACING, hang open sts. of sleeve onto these Ndl's. decreasing evenly across. Bind off LOOSELY.

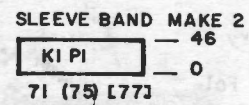

TOP WAISTBANDS: Col. 1 -

K1, P1 Rib: Cast on 155(163) 171 sts. After Selvedge, knit 50 rows. Transfer Rib sts. to MB. Hang lower edge of Front/Back onto these Ndl's with KNIT SIDE FACING. Bind off LOOSELY. Repeat for 2nd half.

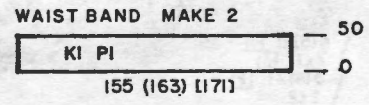

SKIRT: Col. 1 - 1 Strd. Standard Ribber. - Make 2.

FNR: Cast on 144 (150) [156] sts. After selvedge, Counter 0. T 3/3 II. Knit 12 rows. Change tension to 2/1.1 and knit in FNR to R 170 (180) [190]. ON EACH SIDE, dec. 1 st. every 10th row 7x. After R 240 (250) [260]. Remove on W.Y. Make second half the same.

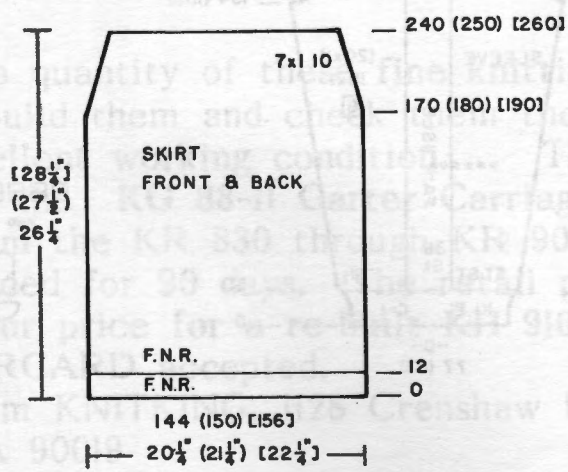

COMPLETE GARMENT DIAGRAM

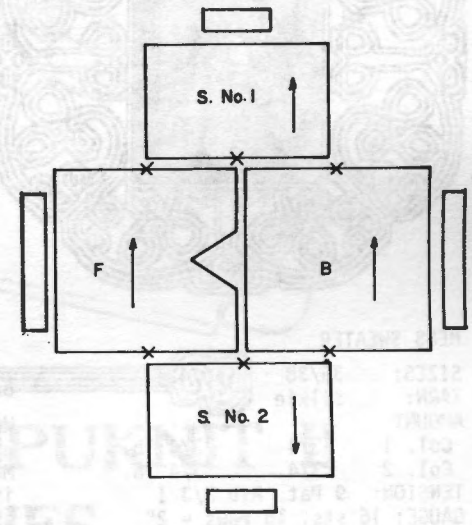

SKIRT WAISTBANDS: Col. 1 - 1 Strd.

Bring to WP 120 (126) [132] Ndl's. With wrong side facing, hang the open sts. of Skirt Onto these Ndl's. With Tension 3, knit 36 rows St. st. Pick up the first row to form hem. Bind off loosely. REPEAT for 2nd half.



FINISHING:

See General Instructions. Insert elastic through casing on Waistband of skirt.



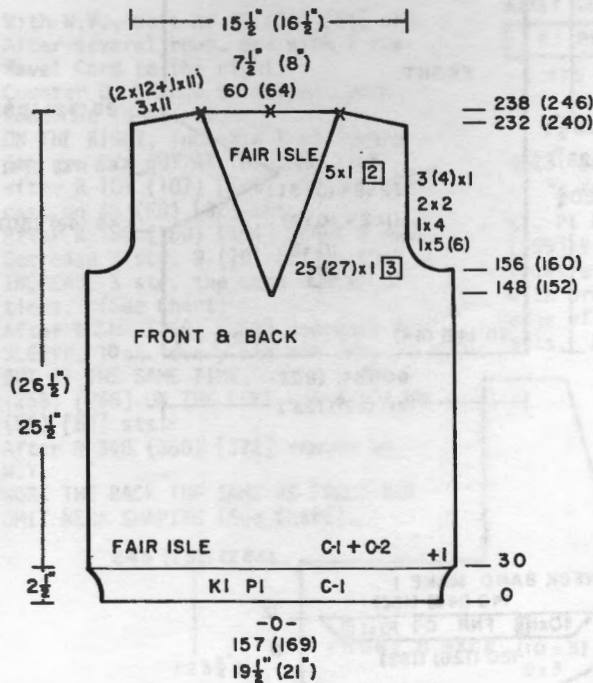
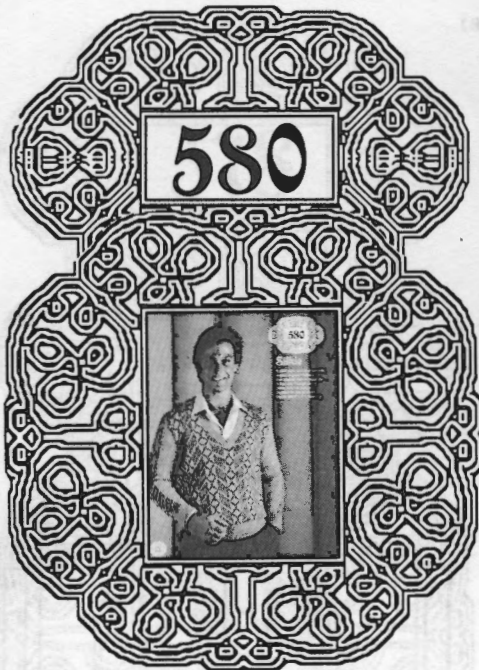

MENS SWEATER

SIZES: 36/38 (40/42)
 YARN: Silkie
 AMOUNT
 Col. 1 3/4 3/4 lb.
 Col. 2 3/4 3/4 lb.
 TENSION: 9 Pat. Rib 3/3 I
 GAUGE: 16 sts. 16 rows = 2"

Make on any Electronic machine.
 A Fair Isle Design with Isolated
 Pattern on Sleeves. Bands are
 K1, P1 Ribbing.

FRONT:

K1, P1 Rib: With Col. 1, cast on
 157 (169) [sts. Knit 30 rows.
 Transfer Rib sts. to MB and add
 1 st. on the right side. Knit
 1 row to the left then Set Pat.
 Knit 1 row to the right to select
 Ndl's. Continue in Fair Isle Pat.
 After R 148 (152), Divide in center
 for V Neck shaping.

Place sts. on the left to Non
 Working position (use Ravel Cord
 and knit the sts. back to A po-
 sition and complete the right
 side first. NOTE PATTERN ROW.

*ON NECK EDGE, decrease 1 st. every
 3rd row 25 (27)x then 1 st. EOR 5x.
 AT THE SAME TIME, after R 156 (160)
 SHAPE ARMHOLE: Bind off 5 (6) sts.
 1x, 4 sts. 1x, 2 sts. 2x, 1 st.
 3 (4)x. After R 232 (240), SHAPE
 SHOULDER: Bind off 11 sts. 3x
 (12 sts. 2x, 11 sts. 1x).
 Carefully bring sts. on left to
 W.P. Turn Row Counter back to
 148 (152) and complete the
 left half. Follow instructions
 from *.

BACK:

Work the back the same as front
 except OMIT NECK SHAPING.
 Mark sts. for Neck opening
 if you use Short Rows for shoulder
 shaping. If you bound off for
 shoulder, bind off the neck sts.

SLEEVES:

K1, P1 Rib: With Col. 1, cast on
 77 (83) sts. Knit 30 rows. Trans-
 fer the rib sts. to MB. Add 1 st.
 on the right side.
 Knit 1 row to the left.
 Set Pattern. PLEASE NOTE: Pat-
 tern is in center of sleeve ONLY.
 Follow Chart for Programming.
 ON EACH SIDE, inc. 1 st. every
 6th row 18 (20)x.
 After R 154 (158) SHAPE CAP. Fol-
 low Chart for your size.
 After R 214 (223), bind off
 remaining sts.

NECKBANDS: Make 2.

Close Shoulders. K1, P1 Rib:
 With Col. 1, cast on 145 (149)
 sts. Knit 12 rows. Transfer
 Rib sts. to MB. With wrong
 side-facing, beginning at
 center back neck. Hang 1/2
 of back of neck onto 30 (32) Ndl's.
 and the balance to the tip of V.
 Bind off. Repeat for other
 side.

FINISHING:

See General Instructions.

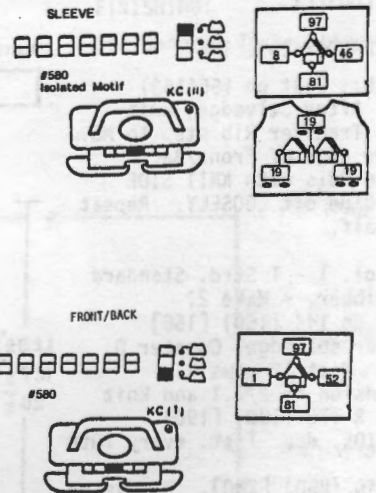
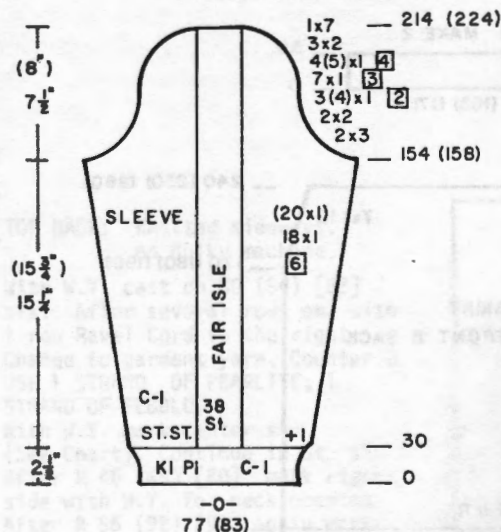
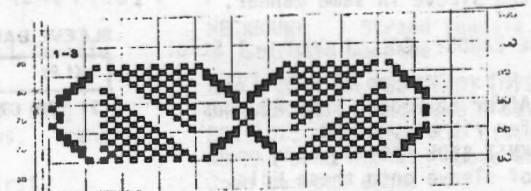

INTARSIA CARRIAGE KA 2600

The new KA 2600 INTARSIA CARRIAGE is made only for the KH 260 Punch Card Bulky Knitter. With it, you can knit large pictures, argyle designs or random blocks of different textures in as many colors as you wish without strands of yarn (floats) carried over the purl side of your knitting. When knitting Intarsia designs, the Intarsia Carriage replaces the main carriage of your knitter. It has a tension control dial to match the dial on your machine and it comes complete with a detailed instruction manual in English, Spanish, German, French and Italian.

\$48.95

\$2.00 mailing costs

Order from your local dealer or direct from:
KNITKING, 1128 Crenshaw Blvd., L.A. CA 90019

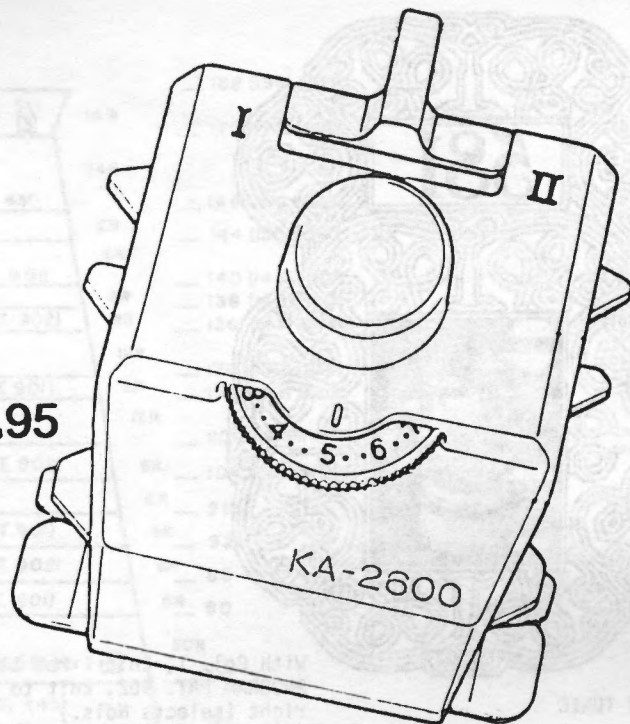

SALE OF PRE-OWNED COMPUKNIT II (KH 910) KNITTING MACHINES

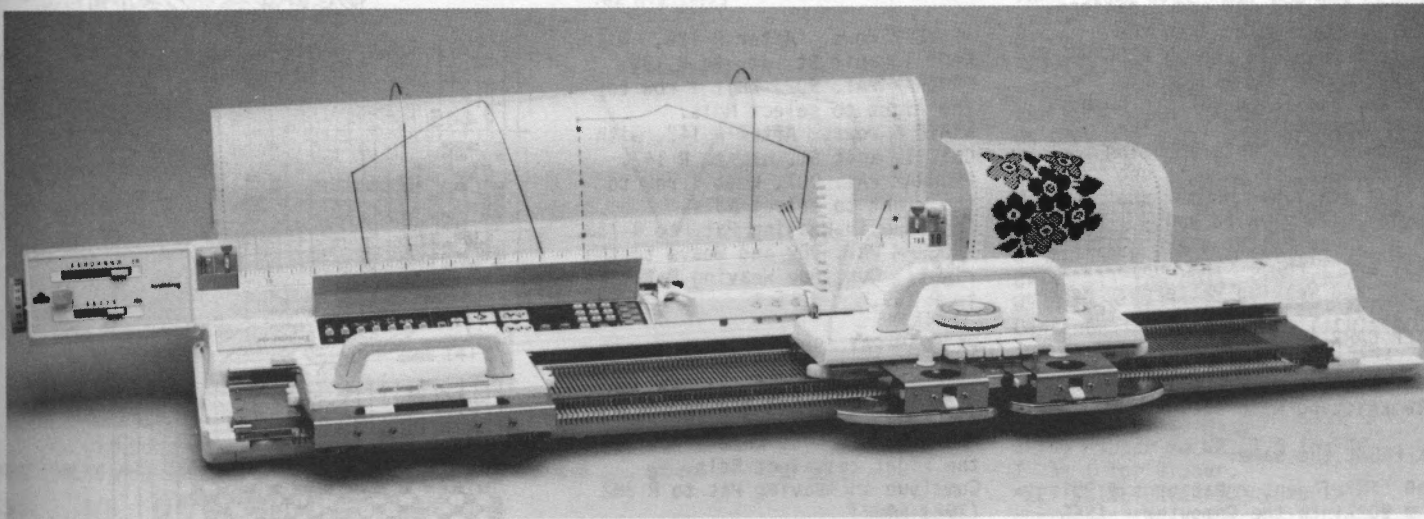

We have taken a quantity of these fine knitting machines in trade.. We re-build them and check them thoroughly to see that they are in excellent working condition..... The KH 910 accepts the KG 88 and the KG 88-II Garter Carriages... and Ribbing Attachments from the KR 830 through KR 900. All re-built machines are guaranteed for 90 days. The retail price of the KH 910 is \$999.95.... Our price for a re-built KH 910 is ONLY \$499.95.. VISA or MASTERCARD accepted.

Order direct from KNITKING, 1128 Crenshaw Boulevard,
Los Angeles, CA 90019

The Knitleader is not included in the price.



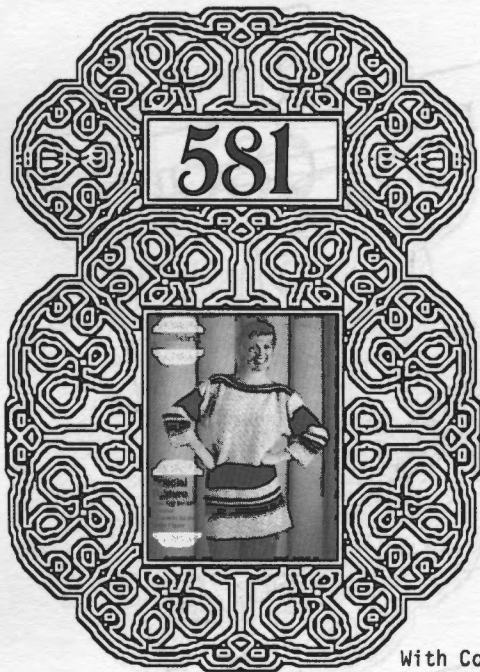

581



WOMENS TUNIC

SIZES: 10/12 (14/16)[18]

YARN: Glace = Col. 1
Aplacana = Col. 2

AMOUNT:

Col. 1 1 Cone all sizes.
Col. 2 4 4 4 Balls

TENSION: Weaving T 5, Rib. Col. 1
T 4, Col. 2 T 4.2

GAUGE: 13 sts. 22 rows = 2"

With Col. 1, knit 1 row to the left.
PROGRAM PAT. 902, knit to the right (selects Ndl.s.)
Weave 2 rows. After R 116, with Col. 1, work St. st. to R 121.
PROGRAM PAT. 901, knit 1 row to the right to select Ndl.s.

Made on the KH 930 machine using Patterns 431 and 445 and 2 patterns which you must enter into the Computer. We tell you to PROGRAM 901 or Program 902 (these are the first two available Pattern numbers in the computer). If you have patterns already entered using these numbers, be sure to use the NEXT available number the Computer will give to you. Each of these Patterns are 3 sts. and 1 row. The Tunic is St. st. and Weaving Patterns. Neck-band is K1, P1 Ribbing using the GARTER CARRIAGE.

NOTE: Use Col. 2 for all Weaving while knitting with Col. 1.

BACK/FRONT the same.

USING 'INPUT' enter Patterns # 901 and # 902 into the Computer (SEE INSTRUCTIONS ABOVE).
With Col. 1 'e' cast on 140 (154) [162] sts. With T 4, knit St. st. After R 59, Carr. on LEFT.
PROGRAM PAT. 431. Knit 1 row to the right to select Ndl.s.
Activate Weaving Brushes and continue in Weaving Pattern. Knit 48 rows.
After R 108, STOP PATTERN.
With Col. 1, knit 1 row to the left.
PROGRAM PAT. 901, knit 1 row to the right (selects Ndl.s.)
Weave 2 rows.. STOP PAT.

WEAVE 2 rows. After R 124, With Col. 1, knit St. st. to R 135.
PROGRAM PAT. 902, knit 1 row to the right to select Ndl.s.
WEAVE 6 rows. After R 142, with Col. 1, knit St. st. to R 147.
PROGRAM PAT. 901, knit 1 row to the right to select Ndl.s.
Continue in Weaving Pat. to R 153.
PROGRAM PAT. 902 and Weave to the right. Continue Weaving Pat. to R 159.

PROGRAM PAT. 901, Weave 1 row to the right. Continue Weaving Pat. After R 166, continue in St. st. with Col. 1 to R 209 (219) [229]
PROGRAM PAT. 445, knit 1 row to the right to select Ndl.s.
Continue in Weaving Pat to R 382 (392) [402].
Continue in St. st. with Col. 1 to R 394 (404) [414].
Replace Standard Carr. with GARTER CARRIAGE. T 4.2. With Col. 2, knit 4 rows. Change to Col. 1 T 4. Knit 4 rows. After R 402 (412) [422] with Col. 2, knit 2 rows. With Col. 1, knit 4 rows. After R 408 (418) [428], with W.Y. mark for Neck opening. Bind off or remove on W.Y.

BACK & FRONT MAKE 2

36 (38) [40] 74 (78) [82]

KI PI	C-1	(PAT. 532)	4R	408 (418) [428]
KI PI	C-2	"	2R	404 (414) [424]
KI PI	C-1	"	4R	402 (412) [422]
KI PI	C-2	"	4R	398 (408) [418]
KI PI	C-2	"	4R	394 (404) [414]
ST. ST.	C-1		12R	382 (392) [402]
WEAVING	C-1 C-2	(PAT. 445)		210 (220) [230]
ST. ST.	C-1			166
WEAVING	C-1 C-2	(PAT. 901)	6R	160
WEAVING	C-1 C-2	(PAT. 902)	6R	154
WEAVING	C-1 C-2	(PAT. 901)	6R	148
ST. ST.	C-1		6R	142
WEAVING	C-1 C-2	(PAT. 902)	6R	136
ST. ST.	C-1		12R	124
WEAVING	C-1 C-2	(PAT. 901)	2R	122
ST. ST.			6R	116
WEAVING	C-1 C-2	(PAT. 902)	2R	114
ST. ST.	C-1		2R	112
WEAVING	C-1 C-2	(PAT. 901)	2R	110
ST. ST.	C-1		2R	108
WEAVING	C-1 C-2	(PAT. 431)	46R	60
ST. ST.	C-1	(HEM)		0

[32"]
[31"]
30"

146 (154) [162]

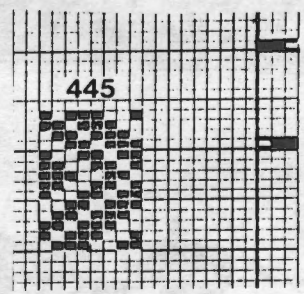
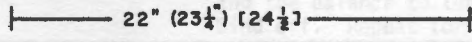

901 - 3 Sts. 1 Row

902 - 3 Sts. 1 Row

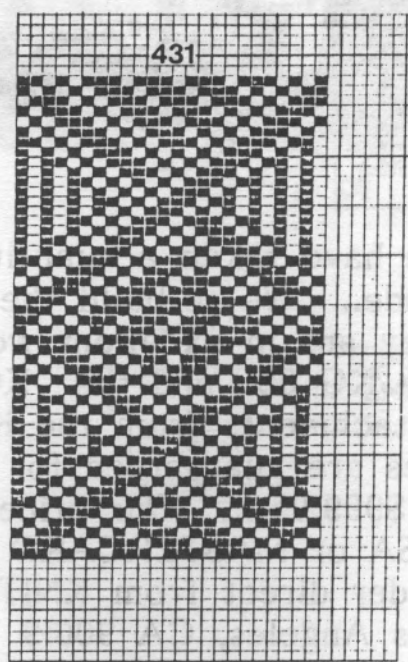

37

SLEEVES:

With W.Y. cast on 160 (168) [176] sts. After several rows, end with Carr. on the LEFT. PROGRAM PAT. 445 and with Ravel Cord, knit 1 row to the right to select Ndls. Continue Weaving Pattern to R 30 BUT AT THE SAME TIME, ON EACH SIDE, Decrease 1 st. every 4th row 40 (42) [44]x continuing to FOLLOW CHART for changes in Patterns and using the same methods as the Front/Back. Knit to R 170 (176) [182].
With Col. 1 only, T 4, continue St. st. and ON EACH SIDE, increase 1 st. every 3rd. row 5x. After R 188 (194) [200] bind off.

FINISHING:

Fold the first 60 rows on Front/Back sections to the inside and stitch into place.
Fold Sleeve cuff to inside and stitch into place.
Balance see General Instructions.

SLEEVE MAKE 2

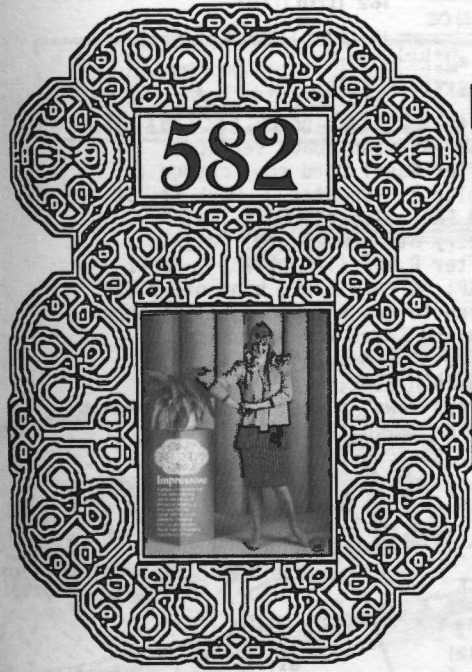
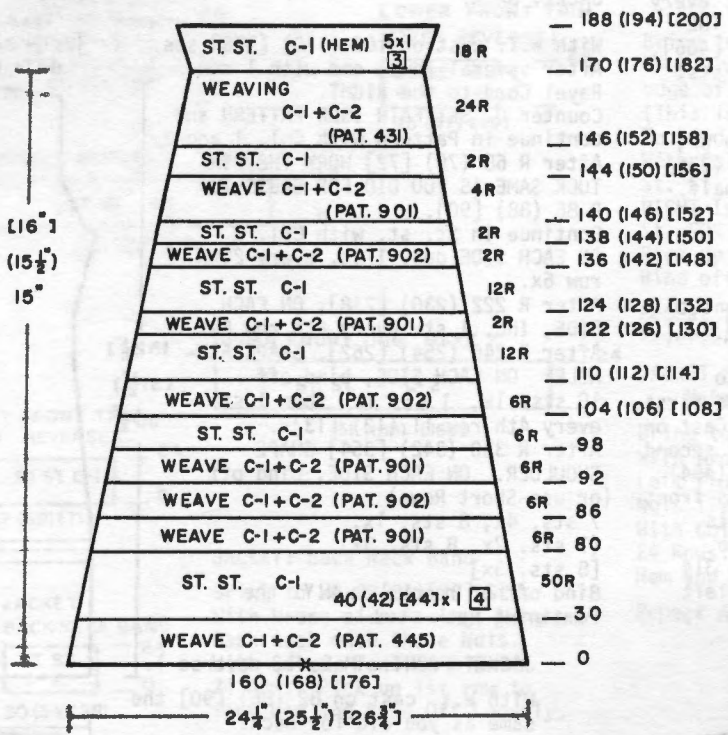

WOMENS DRESS AND JACKET
SIZES: 6/8 (10/12) [14/16]
YARN: Venetia
AMOUNT:
Col. 1 1 1/4 1 1/2 1 3/4 lbs.
Col. 2 1 1/2 1 3/4 2 lbs.
TENSION: St. st. 5
GAUGE: 17 sts. 22 Rows = 2"
14 Inch Zipper for Dress.

Make on any Standard Punch Card or Electronic machine with Ribber. Stockinette stitch with a Fair Isle Design. Only 1 row is punched or marked on Mylar sheet. Leave Card on STOP (Lock) for Fair Isle Design Border.

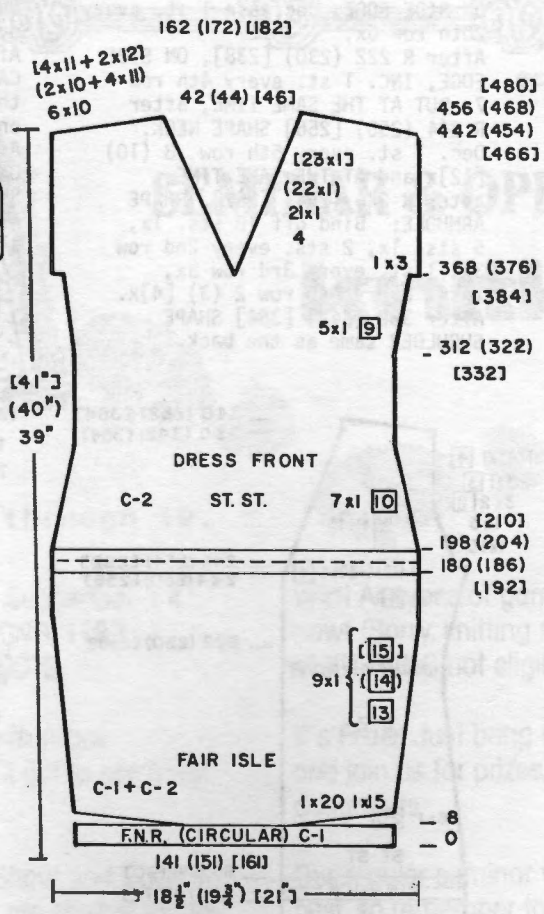

DRESS FRONT:

FNR: With Col. 1, T 4.0/3.1 I, cast on 140 (150) [160] sts. Knit 9 rows Circular. Transfer Rib sts. to MB. SET PATTERN and knit 1 row to the right. Continue in Fair Isle Pat. and WORK SHORT ROWS:
ON OPPOSITE SIDE OF CARR. bring to HP 15 Ndls. before knitting the next 2 rows. ON OPPOSITE SIDE OF CARR. bring 20 Ndls. to HP before knitting the next 2 rows. BE SURE TO ALWAYS WRAP INSIDE NDL. to prevent a hole. Bring all the Ndls. OPP. CARR. to WP before knitting the next 2 rows. Continue in Pattern. ON EACH SIDE, increase 1 st. every 13th (14th) [15th] row 9x.
After R 180 (186) [192], cancel Fair Isle Pattern.
Bring Ribber to WP. T 5 for MB T 3 I for Ribber.
SET SLIDE LEVER to H. Bring corresponding ribber Ndls. to WP. Set Controls for CIRCULAR KNITTING (same as selvage). Knit 8 rows circular. Move SLIDE LEVER to P. Transfer Rib sts. to MB. Knit 1 row. REPEAT FROM * TO * 1x MORE.
Change to Col. 2 and continue in St. st. ON EACH SIDE, decrease 1 st. every 10th row 7x.
After R 312 (327) [332], ON EACH SIDE, Inc. 1 st. every 9th row 5x. After R 368 (376) [384], ON EACH SIDE, cast on 3 sts. (See Chart). DIVIDE IN CENTER for 'V' Neck. Put Ndls. on the left into HP and complete right side first.

CONTINUED



*ON NECK EDGE, decrease 1 st. every 4th row 21 (22) [23]x AND AT THE SAME TIME, after R 442 (454) [466], SHAPE SHOULDER. Bind off 10 sts. 6x (10 sts. 2x, 11 sts. 4x) [11 sts. 4x, 12 sts. 2x]. Bring the Ndl's on the left to WP, turn Row Counter back to 368 (376) [384] and complete the left half. Follow instructions from *

DRESS BACK:

Work the back the same as front to R 314 (326) [338]. DIVIDE IN THE CENTER FOR NECK OPENING. Put the Ndl's. on the left into HP and complete the right side first. *Knit to R 368 (376) [384]. Cast on 3 sts. on the right (left for second half) then continue to R 442 (454) [466]. SHAPE SHOULDER same as front then bind off the remaining sts. Bring the Ndl's. on the left to WP. Turn Row Counter back to 314 (326) [338] and complete the left half. Follow instructions from *.

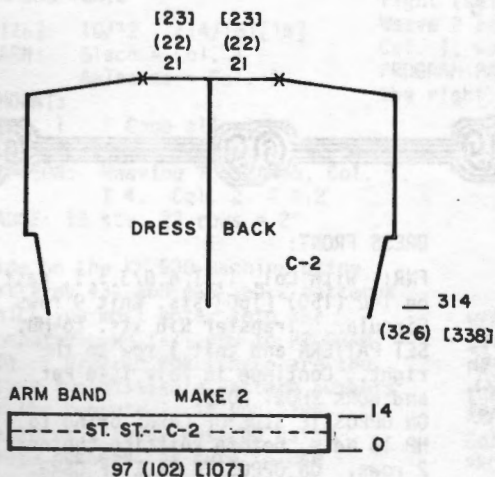

DRESS ARM BANDS: Close Shoulders.

St. st. With Col. 2, cast on 97 (102) [107] sts. Use T 6. Knit 14 rows. Pick up first row to form hem. With wrong side facing, pick up sts. along arm edge, then bind off.

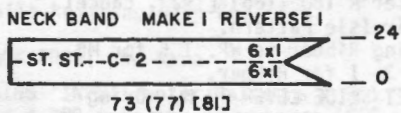

DRESS NECKBANDS: Make 1, reverse 1.

St. st. With color 2, cast on 73 (77) [81] sts. ON THE RIGHT (left for second section) On EOR, decrease 1 st. 6x, then Increase 1 st. EOR 6x. After R 24, pick up the first row to form hem. With WRONG SIDE FACING, pick up sts. from neckline making sure the straight edge is at back opening and point at front V. Distribute neck sts. EVENLY. Bind off. Make second band the same with reverse shaping and finish in the same way.

FINISHING:

See General Instructions.

JACKET BACK:

With W.Y. cast on 162 (170) [178] sts. After several rows, end with 1 row Ravel Cord to the RIGHT. Counter 0. SET FAIR ISLE PATTERN and continue in Pattern with Col. 1 and 2. After R 68 (70) [72] WORK THE PIN TUCK SAME AS YOU DID FOR DRESS TO R 86 (88) [90]. Continue in St. st. with Col. 2. ON EACH SIDE dec. 1 st. every 20th row 6x. After R 222 (230) [238], ON EACH SIDE, INC. 1 st. every 4th row 6x. After R 246 (254) [262], SHAPE ARM-HOLE: ON EACH SIDE, bind off 10 sts. 1x, 1 St. 3x, then 1 st. every 4th row 11 (12) [13]x. After R 330 (342) [354] SHAPE SHOULDER. ON EACH SIDE, bind off (or use Short Rows) 7 sts. 4x, 8 sts. 1x. (7 sts. 2x, 8 sts. 3x) [8 sts. 5x] Bind off or remove on W.Y. the remaining neck sts.

JACKET FRONT: Make 1, reverse 1.

With W.Y. cast on 82 (86) [90] the same as you did for back. After Ravel Cord row, Continue in Fair Isle Pattern with Col. 1 and 2 same as back. After R 68 (70) [72] work the PIN TUCK same as before. After R 86 (88) [90], continue in St. st. with Col. 2. ON SIDE EDGE, decrease 1 st. every 20th row 6x. After R 222 (230) [238], ON SIDE EDGE, INC. 1 st. every 4th row 7x BUT AT THE SAME TIME, after R 244 (250) [256] SHAPE NECK. Dec. 1 st. every 5th row 8 (10) [12]x and AT THE SAME TIME, after R 246 (254) [262], SHAPE ARMHOLE: Bind off 10 sts. 1x, 5 sts. 1x, 2 sts. every 2nd row 3x, 1 st. every 3rd row 3x, 1 st. every 4th row 2 (3) [4]x. After 330 (342) [354] SHAPE SHOULDER same as the back.

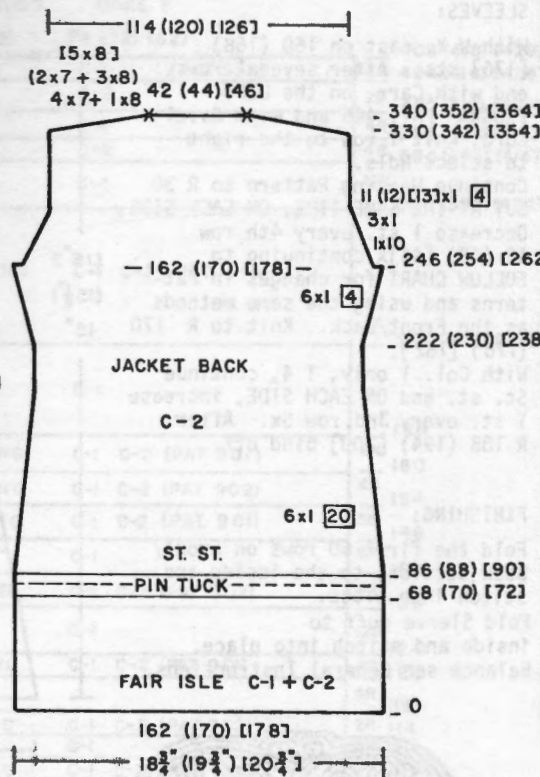
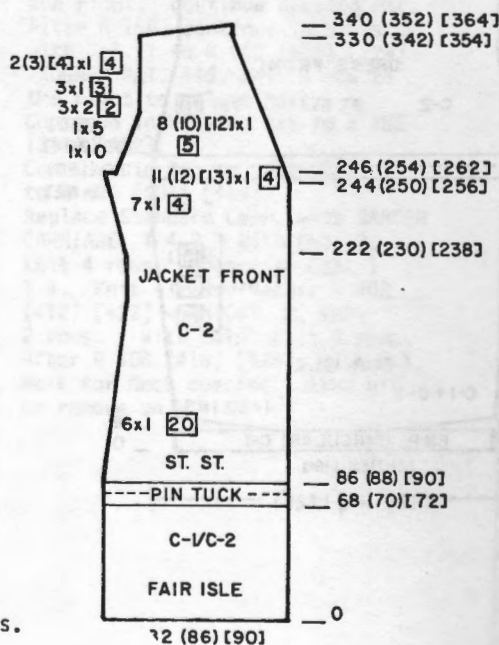

JACKET SLEEVES:

With W.Y. cast on 66 (72) [78] sts. same as front/back sections. After Ravel Cord row, change to Color 1. Counter 0. Work St. st. ON EACH SIDE increase 1 st. every 8th row 19 (20) [21]x. After R 162 (170) [178], SHAPE CAP: ON EACH SIDE, bind off 9 sts. then follow the decreases as shown on the Chart for your size. After R 242 (254) [266], ON EACH SIDE, bind off or use Short rows, 5 sts. 2x. After R 246 (258) [270], bind off all sts.

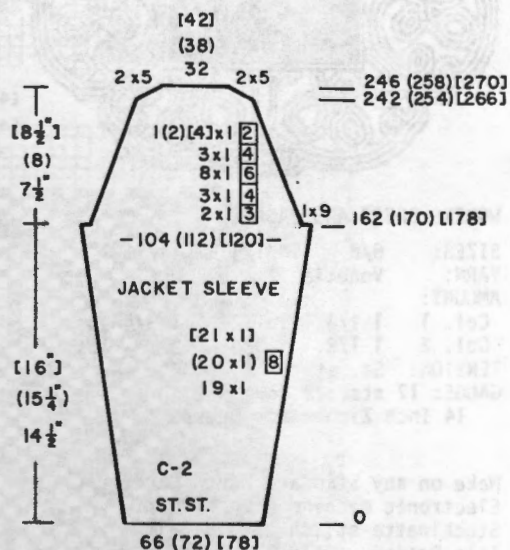

JACKET CUFF: Tension 6 St.st. Col.1

Bring to WP 50 (54)[58] Ndls.
Hang open Sts. of Sleeve Edge onto these Ndls. Decreasing evenly across. Knit 24 Rows. Pick up 1st row to form hem and Bind off Loosely.

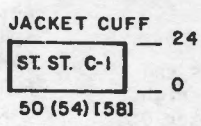

LOWER FRONT TRIM MAKE 1 REVERSE 1



JACKET FRONT: Lower Front Trim Make 1 Rev. 1

Bring to WP 45(47)[49] Ndls. With Wrong side facing Hang lower edge of Left Front onto these Ndls. (This is from the top of the Pin Tuck to the bottom.) With Col.1 Tension 6 Continue in St. St. BUT AT THE SAME TIME ON THE RIGHT Inc. 1 St. EOR 6x, Then Dec. 1 St. EOR 6x. Pick up 1st Row to Form Hem and Bind off Loosely.

JACKET BACK: Lower Trim Make 1

Bring to WP 133(137)[141] Ndls. Hang open Sts. of lower Back onto these Ndls. Dec. Evenly Across. With Col.1 Tension 6 Knit 24 Rows. Pick up 1st. Row to form hem and Bind off. Loosely.

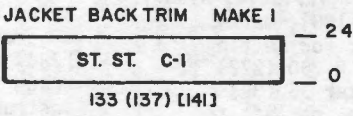

JACKET FRONT Trim: Make 1 Rev. 1

For Left Front: Wrong Side Facing

Bring to WP 67(69)[71] Ndls. Hang Open Sts. of Left Front Lower Edge onto these Ndls. Decreasing evenly across. With Col.1 Tension 6. ON Left side Inc. 1 St. EOR 6x. Then Dec. 1 St. EOR 6x. After Row 24 Pick up 1st. Row to Form Hem. Bind off Loosely. Reverse FOR RIGHT SIDE.

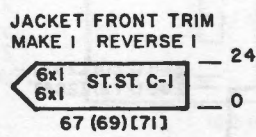

UPPER FRONT TRIM MAKE 2

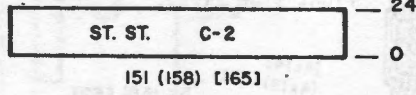

Repeat for Right Front except. Reverse Shapings.

JACKET FRONT: Upper Front Trim Make 2.

Bring to WP 151(158)[165]. WITH Wrong side facing Hang Left Front Edge. onto These Ndls. (From Pin Tuck to Shoulder Seam) With Col.2, Tension 6 Knit 24 Rows. Pick up 1st row to form Hem and Bind off Loosely. Repeat for Right Front.

JACKET: Back Neck Band

Bring to WP 30(34)[38] Sts. With Wrong side Facing. Hang Back neck onto these Ndls. With Col.2, Tension 6 Knit 24 Rows. Pick up 1st row to form Hem and Bind Off Loosely.

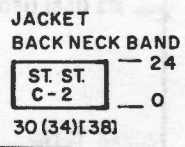

FINISHING:
See General Instructions.



SEMINAR & OPEN HOUSE 1987

knitking

September 14 through 19.

Join us! Our open house runs from September 14 through 19 and will be held at KNITKING, 1128 Crenshaw Blvd, Los Angeles, Calif. 90019.

Win! All types of garments are eligible, so start knitting now! (Sorry, knitting machine dealers and employees of KNITKING not eligible)

Come and meet our experts along with many acknowledged guest authorities. You'll get to see great new products too!

It's Free! Just bring yourself and some friends and join us for prizes, events, and free coffee and doughnuts.

Enjoy! You'll love our daily Fashion Show and Contest! Daily winners will receive prizes and are eligible for the finals and a GRAND PRIZE at the close of the seminar.

Our regular seminar visitors will tell you ours is the best, so remember to come and meet us here at

KNITKING

September 14 through 19.





TOP BACK: Lace. T 4.1

With W.Y., cast on 150 (162) [174] sts. After several rows end with 1 row Ravel Cord to the right. Change to garment yarn. Counter 0. Knit 2 rows then begin LACE PATTERN. (Use 2 Rows St. St. as usual) After R 152 (156) [160], mark each side with W.Y. for setting in sleeves. After R 260 (272) [284] bind off center 35 (39) [43] sts. Place sts. on left to out of work position (knit the sts. back to 'A' position with Ravel Cord). Complete the right side first.

NOTE ROW NUMBER OF LACE PATTERN. *SHAPE SHOULDER AND NECK AT THE SAME TIME. FOR NECK, bind off 5 sts. 1x, 3 sts. 1x, 1 st. 1x. FOR SHOULDER, bind off 12 (13)[14] sts. 4x. Bring the Ndl. on left back to WP, turn Counter back to 260 (272) [284] and complete the left half. WATCH PATTERN. Follow the instructions from *.

WOMENS TWO PIECE DRESS

SIZES: 12/14 (16/18) [20/22]
 YARN: Venetia
 AMOUNT: 2 2 1/4 2 1/2 lbs.
 TENSION: 4.1 Rib Tension 0/0 I
 GAUGE: 13 1/2 sts. 24 rows = 2"

Make on Punch Card or Electronic machine with Lace Carriage for the Top and Skirt. Cables are 2 over 2 on the Top. Skirt is a combination of Lace, St. st. and Short Rows.

SKIRT: T 4.1

With W.Y. cast on 160 (166) [172] sts. After several rows end with 1 row Ravel Cord to the right. Change to Garment Yarn. Counter 0. *Knit 6 Begin Lace Pattern. (NOTE: After Transferring Sts. with Lace Carriage Knit 4 Rows St. st. instead of the usual 2) After R 18 Knit 6 Rows. WORK SHORT ROWS: ON OPPOSITE SIDE OF CARR. bring to HP 20 sts. 7x (20 sts. 4x, 22 sts. 3x) [21 Sts. 2x, 22 Sts. 5x]. ALWAYS WRAP INSIDE ND. to prevent hole. After R 38. WORK SHORT ROW INCREASES, bringing the Ndl. back to WP in reverse order (See Chart). After R 52 continue St. st. Knit 6 rows. After R 58 Begin Lace Pattern. After R 70 Cancel Lace Pat. Knit 6 rows St. st. After R 76 ONE SECTION IS COMPLETED. REPEAT from beginning * for a total of 9 (10) [11] sections. Remove on W.Y.

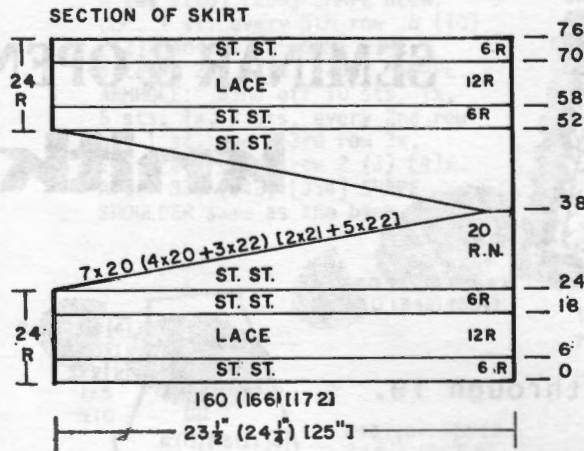
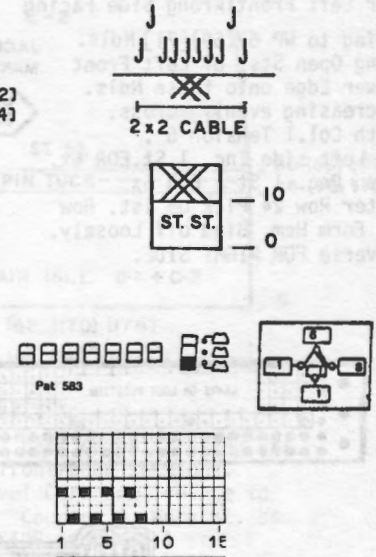
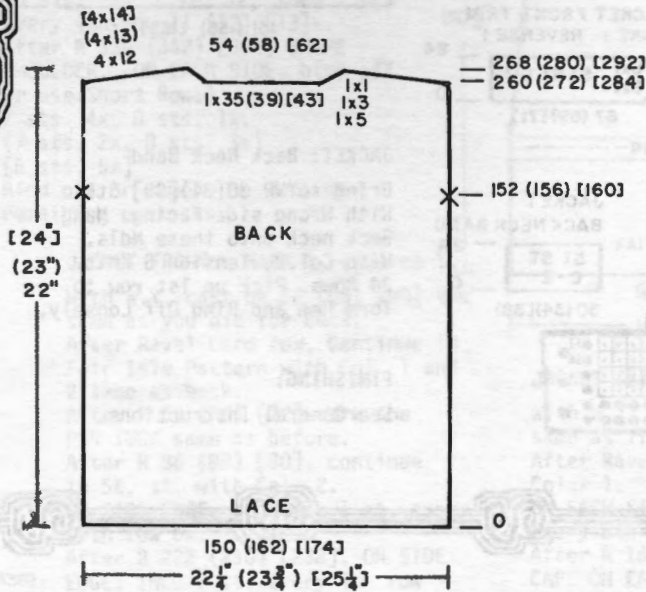

SLEEVES: W.Y. Cast Same as Before. Change to Garment Yarn and Knit 2 Rows. Transfer Sts. on Ndl. 4, Each side of 0 and Continue in same manner as Front Making Cables Every 10 Rows. AT THE SAME time Inc. 1 St. Every 10th Row 14x (1 St. Every 10 Rows 16x) [1 St. Every 9th Row 18x]. After Row 36 Begin Second Rows of Cable Same as Front. After Row 164-(170) [176]. Mark Center with W.Y. and Bind off or Remove on W.Y.

SKIRT WAISTBAND: Bring 122 (130) [138] Ndl. to WP. With WRONG SIDE FACING, hang 1/2 of skirt waist onto these Ndl. decreasing evenly across. Knit 32 rows. Pick up first row to form hem and bind off LOOSELY. REPEAT FOR 2nd HALF OF SKIRT.

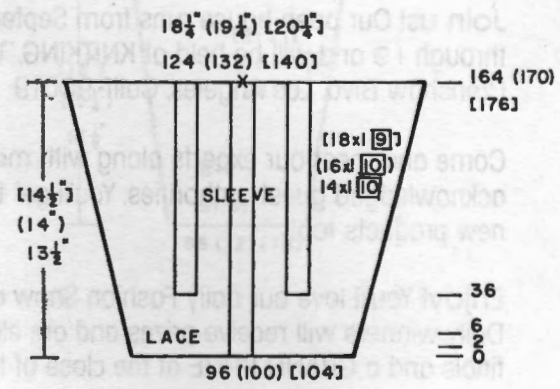
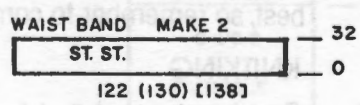

TOP FRONT: Lace and Cables T 4.1
 W.Y. cast on same as back. 150
 (162) [174] sts. After Ravel Cord
 row, change to garment yarn.
 Counter 0.
 Knit 2 rows. SET NDLS. FOR FIRST
 CABLE STRIP. See Chart and you
 will see Ndl. 4 each side of 0
 is in out of work position (A
 position). The Cables are made
 over 4 sts. 1 & 2 to left of 0 and
 1 & 2 to right of 0.
 NOTE: As you are using the Lace
 Carriage to transfer sts, you must
 remember that EVERY TIME THE LACE
 CARRIAGE BRINGS THE NDLS. WITHIN
 THESE 10 sts. to D (selecting)
 position, MANUALLY PUSH THEM BACK
 TO B POSITION. The 10 sts. are
 Pat. Sts. and they MUST ALWAYS
 BE KNITTED IN ST. ST. THROUGHOUT.
 Set Lace Pattern and continue
 in Lace Pattern, pushing the
 specified Ndls back as instructed
 above.

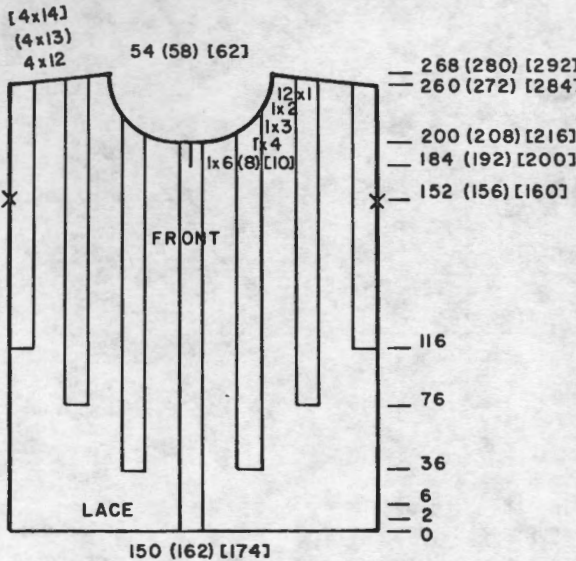

Continue in Pattern and MAKE CABLES
 EVERY 10 ROWS.
 After Row 36 Begin 2nd Cable Strips.
 ON EACH SIDE OF -0- Transfer St.
 21(23)[25] and St. 28(30)[32] to
 Neighboring Ndl. and place the empty
 Ndls. to Non Working Position.
 Continue in Pattern.
 After Row 76 Transfer St. 45(49)
 [53] and Sts. 52(56)[60] On each
 Side to the Neighboring Ndls. and
 put The Empty Ndls. to Out of Work
 Position.
 Continue in Pattern.
 After Row 116 Place Sts. 69(75)[81]
 ON EACH SIDE OF -0- to Neighboring
 Ndl. and place the empty Ndls. to Out
 of Work Position
 *Continue in Pattern.
 After Row 152(156)[160] Place W.Y.
 Markers on each side for Sleeve.
 After Row 184(192)[200] Divide in
 Center. Place Sts. on Left to Non
 Working Position and Finish the Right
 Side First.
 After Row 200(208)[216] ON NECK
 EDGE BO 6(8)[10] Sts.
 4 Sts. 1x, 3 Sts. 1x, 2 Sts. 1x, 1 St.
 12x. AT THE SAME TIME AFTER
 Row 260(272)[284] SHAPE SHOULDER
 Same as Back.
 BRING Ndls. on the Left back to WP
 Turn Counter Back to 184(192)[200]
 and Complete the Same as Right Side.

After R 6, MAKE CABLE.
 Knit 2 rows. If you bring the
 Cable Ndls(after making cables)
 to E position, they will knit
 easier and are less apt to drop
 sts.

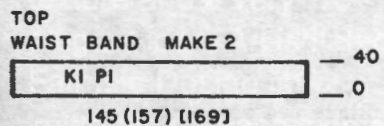

WAIST BANDS: Make 2 T O/O I
 K1/P1 Cast on 145(157)[169]
 Knit 40 Rows. Transfer Rib Sts.
 to MB. With Wrong side facing
 Hang open Sts. of Back/Front
 onto these Ndls. Decreasing evenly,
 across.
 Bind off.

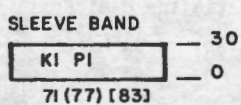

SLEEVE BANDS: T O/O I
 K1/P1 Cast on 71(77)[83] Sts.
 Knit 30 Rows.
 Transfer Rib Sts. to MB .
 Hang open Sts. of Sleeve Edge
 onto these Ndls. Decreasing
 Evenly across.
 Bind Off.

FINISHING:
 See General Instructions.
 Weave side seams of Skirt together.
 Thread Elastic through top and Close.
 Crochet around Skirt Bottom.
 (Use Crochet Trim Pat. 548 Vol.20
 No.4)
 Use Same Crochet Trim for Neck Edge.
 (Only Single Crochet for edge of Slit)
 Make Cord (Approx 24" Long) and
 Thread through Top Edge . See
 Photo.



IT'S READY NOW!

KNITKING MAGAZINE BOUND VOLUME 20

- HARD BOARD COVER
- COMPLETE INSTRUCTIONS
- WILL HOLD ANOTHER COMPLETE VOLUME



Price: \$24.95
 Shipping Costs - \$3.25





Knitking News



VOLUME 21, No. 1

PRACTICAL KNITTING HINTS

KNITTING FAIR ISLE DESIGNS WITH NO FLOATS ON BACK

Attach KRC 900 Ribber to machine.
 Set up KRC 830 Color Changer.
 Use Fine Needle Bar. Insert the Bar behind the gate pegs of the knitter so that it slips slightly underneath the needle bed.
 Thread colors through Color Changer. (Our Patterns in this issue will use only two colors, but some Patterns can use up to 4 colors).
 Thread Color 2 in Button # 2 in Color Changer Arm, Color 1 will be in Button # 1 later).
 Bring desired Ndl. on Main Bed to Working Position. (Remember this is FULL NEEDLE RIBBING (FNR) and you will use every needle on BOTH BEDS)
 Set Ribber to H and bring nedls. to working position. The Ribber stitches for our technique must be an EVEN NUMBER. On the Ribber itself, you will see Red Dashes (--). One side of the Ribber Ndl. must be directly below this dash mark. When the needle moves, it actually crosses it. The Ribber needle on the opposite must not be under one of these dashes. If this is confusing check Page 38 of the 850/900 Ribber Manual.
 You now have the needles set for Full Needle Rib. (FNR). With Col. 1 (Main color) cast on in the usual manner. Hang Cast on Comb and knit the selvedge or complete instructions for a particular pattern. In either case, ALWAYS end up with Carriage on the LEFT SIDE (if Electronic machine, be sure you are past the Sensor.)
 Set Pattern - (Punch Card or Mylar Sheet). Set KC I, PUSH UP BOTH PR BUTTONS on the Ribber Carriage, knit 1 row to the RIGHT. Push in BOTH PART BUTTONS on the Main machine Carriage and LEAVE THEM PUSHED IN THROUGHOUT.
 ON RIBBER CARRIAGE, push in KR Change Knob (L & R) and turn to "lili" Mark.
 MOVE SLIDE LEVER AT BOTTOM OF RIB. CARR. TO "lili" Mark.
 Knit 1 row to the Left.
 Change to Color 2, PUSH BOTH PR BUTTONS DOWN, knit 2 rows.
 Change to Color 1, PUSH BOTH PR BUTTONS UP, knit 2 rows.
 Continue knitting - 2 rows Col. 1 Buttons UP
 2 rows Col. 2 Buttons DOWN for Pattern.

NOTE: On the ELECTRONIC Machines, the KRC LEVER or BUTTONS will be activated.
 ON PUNCH CARD Machines, there are no additional buttons to press, however PUNCH CARD USED MUST BE ONE THAT IS SPECIFICALLY PUNCHED FOR MULTI-COLOR RIB. (Punch cards are included with the KRC 830 Color Changer).

No. 562 - Yarn: ROMA
 SIZES: Small Medium Large
 Price: \$24.00 27.00 27.00
 Shipping: 2.50 2.50 2.50

No. 563 - Yarn: Extra
 Sizes: 10/12 (14/16)
 Price: \$26.40 28.60
 Shipping: 1.85 2.50

No. 564 - Yarn: Venetia & Mami Rex(soft)
 SIZES: 8/10 (12/14) [16]
 Price: \$66.18 66.18 66.18
 Shipping: 4.50 4.50 4.50

No. 565 - Yarn: Glace and Rainbow Mami Rex
 SIZES: 18/20 22/24
 Price: \$61.68 61.68
 Shipping: 4.50 4.50

No. 566A - Yarn (Jacket) Papillon
 SIZES: 10/12 (14/16) [18]
 Price: \$78.00 91.00 104.00
 Shipping: 3.00 3.00 4.00

No. 566B - Yarn: Venetia
 SIZES: 10/12 (14/16) [18]
 Price: \$15.84 17.82 21.78
 Shipping: 2.50 2.50 2.50

No. 567 - Yarn: Venetia
 SIZES: 8/10 (12/14) [16]
 Price: \$31.58 31.68 35.64
 Shipping: 3.50 3.50 3.50

No. 568 - Yarn: Venetia & Soft Mami Rex
 SIZES: From 8 to 14
 Price: \$64.39 64.39 64.39
 Shipping: 4.50 4.50 4.50

No. 569 - Yarn: Venetia
 SIZES: 8/10 (12/14)
 Price: \$78.98 78.98
 Shipping: 5.00 5.00

No. 570 - Yarn: Venetia
 SIZES: 20/22 (40/42) [44]
 Price: \$27.72 31.68 35.64
 Shipping: 3.50 4.00 4.50

No. 571 - Yarn: Venetia And Capriccio
 SIZES: 8/10 (12/14) [16]
 Price: \$39.66 46.27 50.23
 Shipping: 3.50 4.00 4.50

No. 572 - Yarn: Venetia
 SIZES: Will Fit 16 to 22
 Price: \$35.64
 Shipping: 3.50

No. 573 - Yarn: Glace and Venetia
 SIZES: 10/12 (14/16)
 Price: \$31.68 31.68
 Shipping: 4.50 4.50

No. 574 - Yarn: Venetia and Mami Rex(Soft)
 SIZES: 18/20 (22/24)
 Price: \$58.26 69.76
 Shipping: 4.50 4.50

No. 575 - Yarn: Venetia
 SIZES: 10/12 (14/16) [18/20]
 Price: \$31.60 35.64 39.60
 Shipping: 3.50 3.50 4.50

No. 576 - Yarn: Roma
 SIZES: Medium Large
 Price: \$12.00 12.00
 Shipping: 2.50 2.50

No. 577 - Yarn: Amore
 SIZES: 3 to 6 Months
 Price: \$7.17
 Shipping: 1.85

No. 578 - Yarn: Pebble and Venetia
 SIZES: 38/38 (40/42) [44/46]
 Price: \$54.24 63.84 73.44
 Shipping: 4.50 5.00 5.50

No. 579 - Yarn: Pebble and Pearlite
 SIZES: 10/12 (14/16) [18]
 Price: \$54.40 59.20 64.00
 Shipping: 4.50 5.00 5.50

No. 580 - Yarn: Silkie
 SIZES: 36/38 (40/42)
 Price: \$18.10 18.10
 Shipping: 2.50 2.50

No. 581 - Yarn: Glace and Alpacana
 SIZES: 10/12 (14/16) [18]
 Price: \$26.24 26.24 26.24
 Shipping: 3.00 3.00 3.00

No. 582 - Yarn: Venetia
 SIZES: 6/8 (10/12) [14/16]
 Price: \$43.56 51.48 59.40
 Shipping: 4.50 4.50 4.50

No. 583 - Yarn: Venetia
 SIZES: 12/14 (16/18) [20/22]
 Price: \$31.68 35.64 39.60
 Shipping: 3.50 4.00 4.50





573

Seasonless

Knit this simple but elegant Pullover sideways on your machine in a double rib. Venetia and our new Glace are blended together to form a slinky texture and a very elegant look. An isolated Fair Isle Design is knitted in on each side of shoulder. Use your Electronic machine. Bands are full needle Ribbing. Sizes 10 to 16.

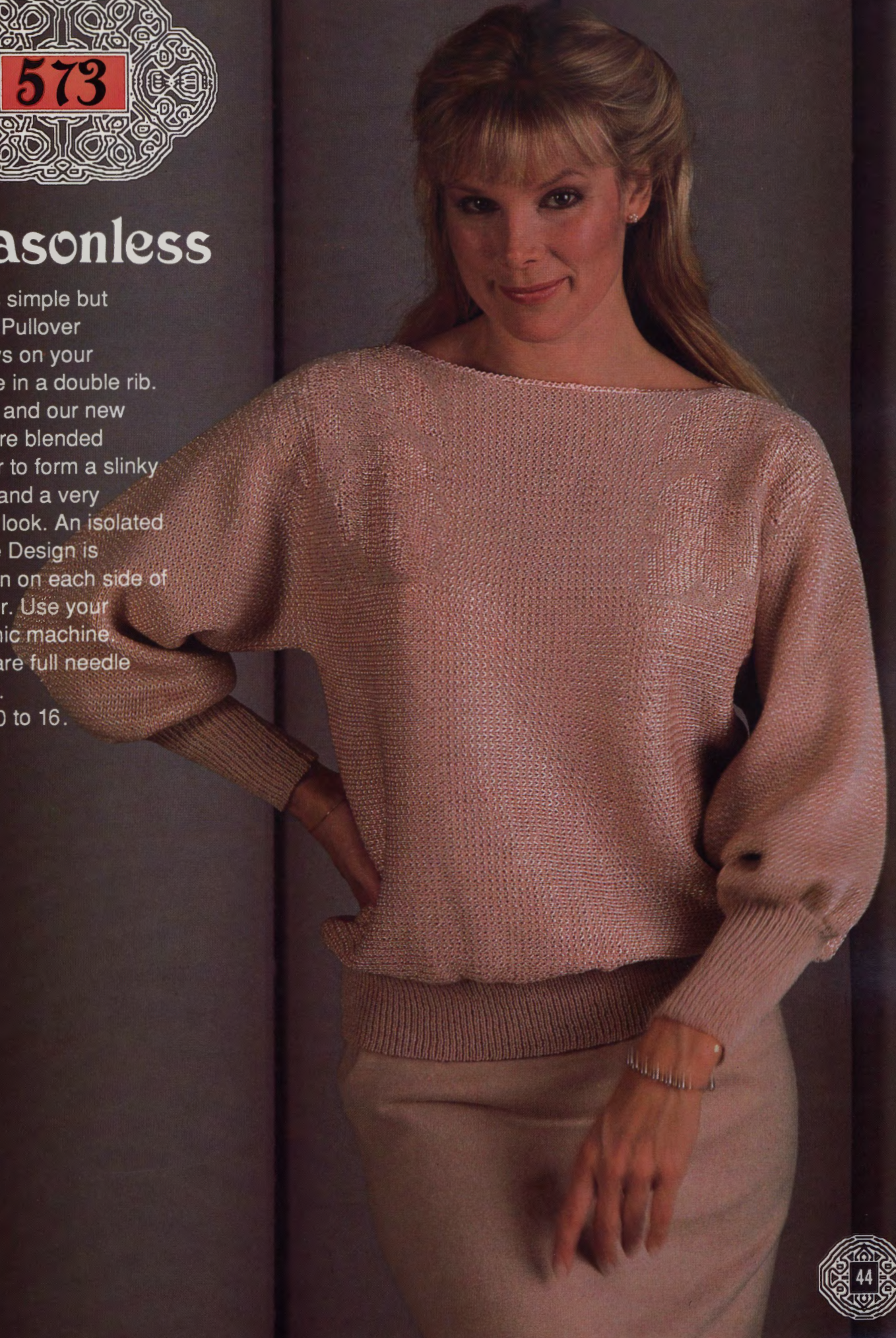



Vibrant!

Color sparkles and gleams in this easy to knit Jacket that goes over a long sleeve Sweater. Knit it with our new Papillon yarn.





Intarsia

Practice your skills with a simple Intarsia Design for a big fashion scoop that is currently the rage in sweater knitting. It's quickly knitted on a Bulky machine with outstanding results. Use our Glacé with Venetia and Angora. The bands are ribbed.

Sizes 8 to 14.





572

Leisure

Lounge happily in a great Housecoat that can make your day...It's in Stockinette stitch combined with a Lace Border Design. Big Tassles trim the ends of belt and tie it all together. Venetia is the yarn.
Sizes 16 to 22.





Paisley Sensation

Show off a Jacket with a large and lovely Paisley Fair Isle Design. You can knit it on any Electronic machine and to prevent floats on the back you need a KR 850 or KR 900 Ribber. The yarn is Venetia and Mami Rex Bands are full needle ribbing.





Silkie

A new yarn, soft and smooth, makes a great Pullover for that special man in your life.

A Fair Isle Design using Silkie and the design is isolated on the sleeves.

Bands are K1, P1, Ribbing.





Bulky Does It

A perfect duo- Matching Pullovers, one for her, one for him and both are knitted on any Bulky machine with our new Pebble yarn. Knit the bands in 1X1 Ribbing on any standard machine with Ribber.

FOR HER- A matching Skirt to knit on any standard machine with Ribber using Pearlite yarn.



570

Lace...

has a place in your wardrobe and this lovely Jacket will please everyone. Big is beautiful- so sizes are from 20 to 46. It was knitted on the COMPUKNIT III (KH 930) but you can knit it on any standard Punch card machine with Lace Carriage using a Lace Design of your choice. The yarn is Venetia.



51



563

Young and Handsome

He's wearing a newly styled Sweater that is knitted in a Tuck Stitch. Take note of the different neckline with "V" outlined in a ribbed band. The same ribbing is used to accent the shoulders. Ribbing is used for waistband, neck and sleeve cuffs. The yarn is Extra. Sizes 10 to 16.



KNITKING KH 891 WITH KG 89 ELECTRIC CARRIAGE

Feed in a pattern stitch card. Set the row counter to a specific number of rows, then push the start button and you can leave to watch T.V. or cook the dinner, read a book, etc., while your knitter knits merrily along. When it has knitted the preset number of rows, it will switch itself off. If it runs out of yarn, it will switch itself off. The KG 89 Electric Carriage will knit an unlimited variety of fancy Garter Stitch designs in addition to standard ribs.

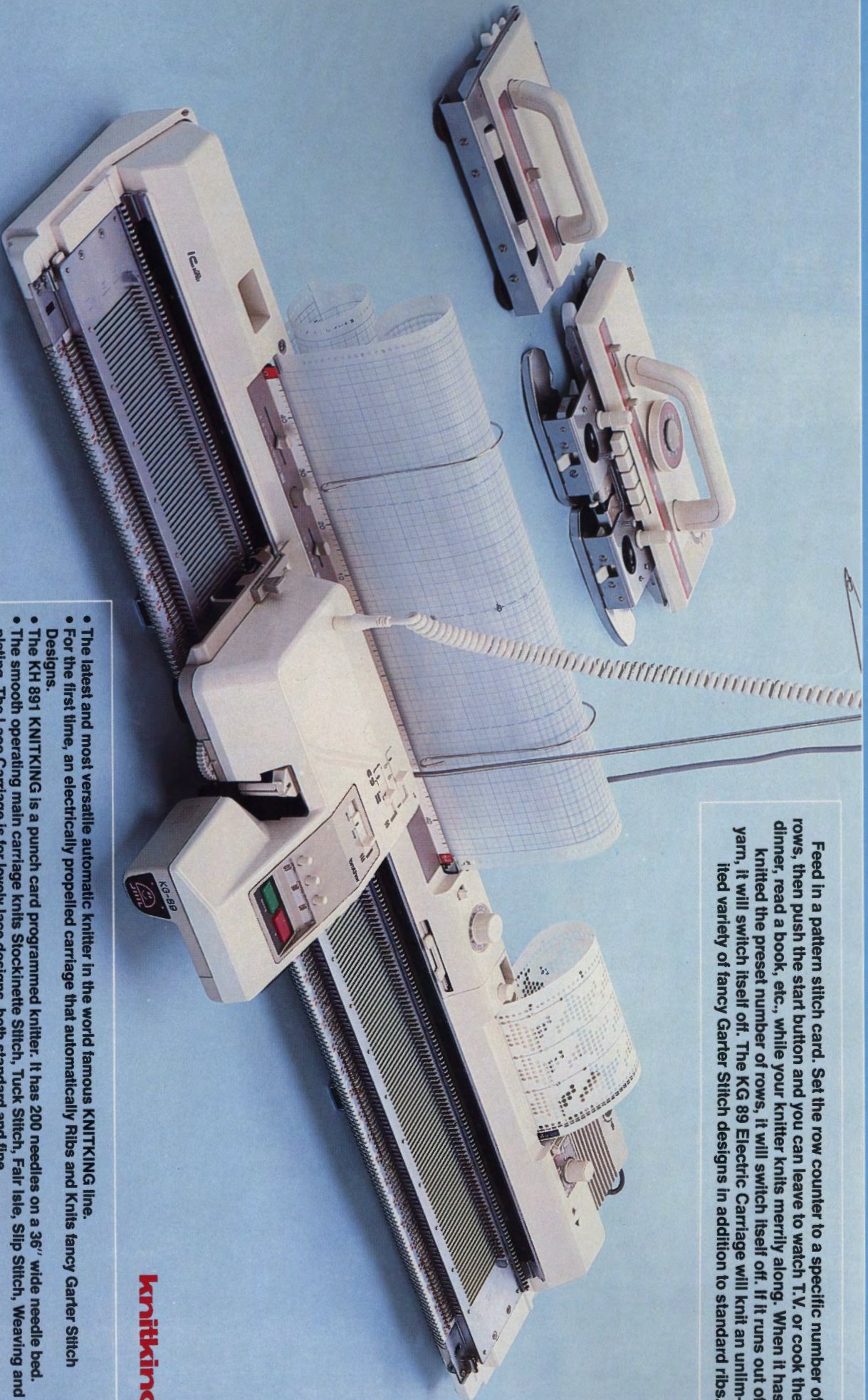

knitking

- The latest and most versatile automatic knitter in the world famous KNITKING line.
- For the first time, an electrically propelled carriage that automatically Knits and Knits fancy Garter Stitch Designs.
- The KH 891 KNITKING is a punch card programmed knitter. It has 200 needles on a 36" wide needle bed.
- The smooth operating main carriage Knits Stockinette Stitch, Tuck Stitch, Fair Isle, Slip Stitch, Weaving and plating. The Lace Carriage is for lovely lace designs, both standard and fine.
- 20 Pre-Punched Pattern Cards for all types of pattern knitting are included with every machine. The built-in Knitleader Charting accessory tells you on a row by row basis when to increase and when to decrease. Simplifies the knitting of garments to accurate size.
- A complete kit of Tools, spare needles, cabling tools, lubricating oil and two, step by step Instruction Manuals with over 400 illustrations are included and there is a one year warranty on parts and service.

Order from your local dealer or direct from **KNITKING**—1128 Crenshaw Blvd.
Los Angeles, CA 90019



577

Precious

Knit your precious bundle of joy this darling outfit... A Pullover is in two sections, only the panties fit over diapers and button with 3 large buttons. A cute peaked Hat and Booties complete the set. It's a Tuck stitch Pattern with Ribbed bands. Use our Amore or any 3-ply Baby yarn. Sizes 3 to 6 months.

rec'd 2-10-87

FOR UNLIMITED VERSATILITY

The Sensational
COMPUKNIT III

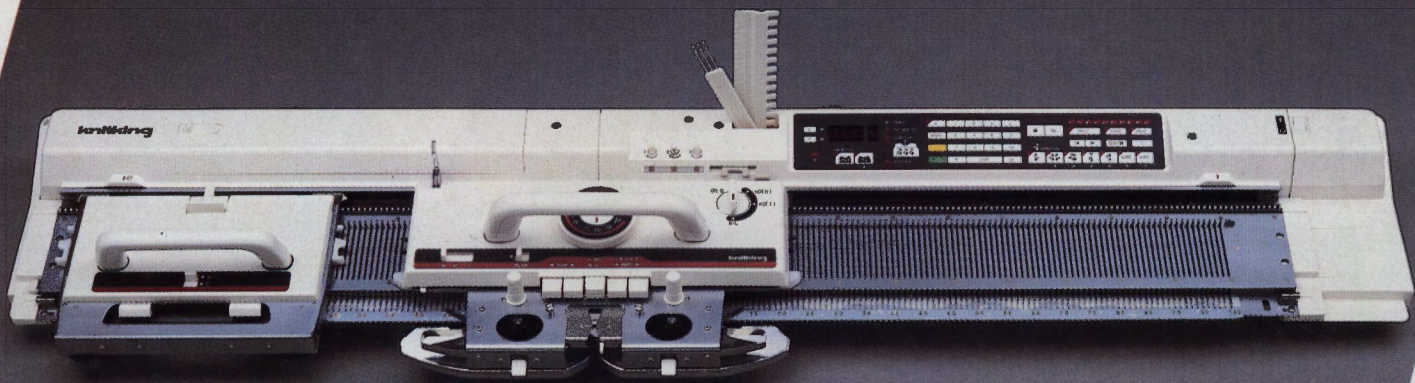

COMPUKNIT III with Lace Carriage and regular Knitting Carriage. Both carriages are standard with the purchase of a COMPUKNIT III. The Lace Carriage knits true Transfer Lace. It automatically knits beautiful yarn-over designs in any combination up to the full 200 needle width of the knitter. It also knits Fine Lace. The Computer permits isolation of Lace designs anywhere you wish in a garment.

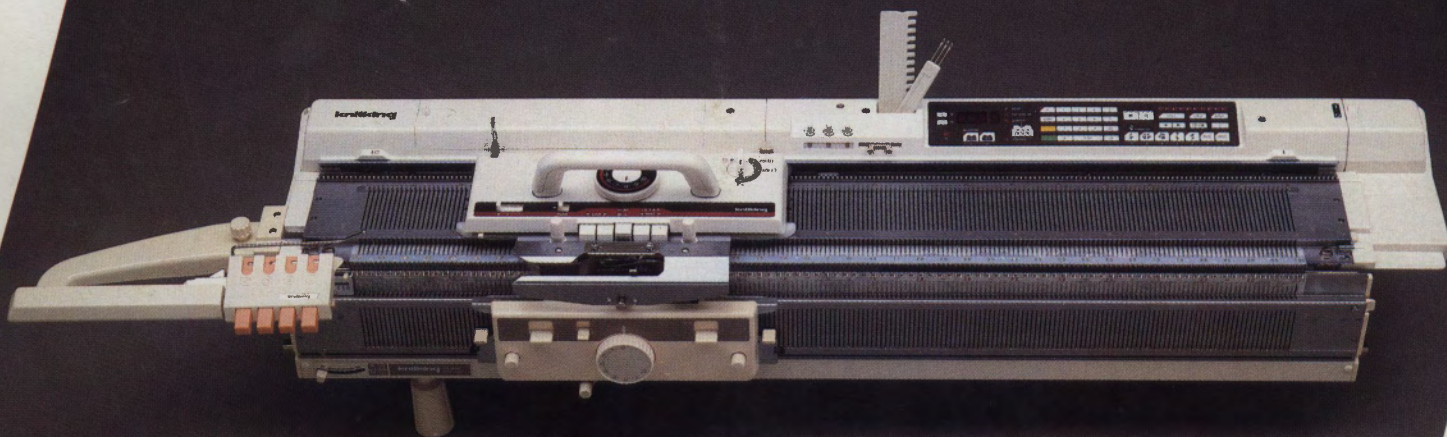

The COMPUKNIT III is illustrated with the KR 900 Ribbing Attachment and the KRC 830 Color Changer (both optional accessories). The Ribbing Attachment knits any combination of knit and purl ribs, racking designs, cable stitches, tubular knitting, etc. Add the KRC 830 Automatic Color Changer and you can knit up to four colors in one row in double knit jacquard. You can also introduce yarns of various textures into a garment. The KHC 820 Color Changer (not shown) operates on the basic machine for the knitting of multi-color designs in Stockinette Stitch.

Order from your local Dealer or direct from **KNITTING CORPORATION**, 1128 Crenshaw Blvd., Los Angeles, California 90019. Tel: 213-938-2077.