



New
Beginnings. . .
Simple elegance.
Beautiful fashions.
Exquisite yarns.
Continued quality.



652

TAKE A BOW

in this ultra feminine dress with isolated Lace Patterning, gathered skirt sections, puffy sleeves and soft pleats each side of bodice and on lower skirt. You will love its soft drape and fit. Knit it on Electronic Machine with bands in Full Needle Ribbing Venetia in sizes 4 to 14.



653

CHARISMATIC

A superb two piece dress that can be worn anytime, anyplace. It is easy to knit on a Standard or Electronic Machine with Ribber. The center panel of the top is knitted separately, then sewn in place. Bands are 1x1 Ribbing. Full Needle Ribbing replaces hem on skirt edge. Venetia is the yarn. Sizes are 10 to 16.

Table of Contents

KNITKING MAGAZINE - VOLUME 22 NO. 1

0000 GENERAL INSTRUCTIONS	10
651 WOMENS DRESS	11
652 WOMENS DRESS WITH LACE INSET	12
653 WOMENS SKIRT AND TOP	13
654 WOMENS ANGORA PULLOVER	15
655 WOMENS CHANEL SUIT	15
656 WOMENS 2 PC. OUTFIT WITH FLOWERS	17
657 WOMENS 2 PC. OUTFIT WITH SNAKESKIN TRIM	19
658 WOMENS DRESS	21
659 WOMENS SWEATER, DICKEY AND SKIRT	22
660 WOMENS CROSSOVER SWEATER	24
661 WOMENS HANDKERCHIEF DRESS	25
662 WOMENS SKIRT AND BLOUSE	26
663 WOMENS PULLOVER	27
664 MENS SWEATER	28
665 WOMENS COTTON PULLOVER	29
666 TEENAGE BULKY OUTFIT	31
667 MENS SWEATER	32
668 CHILDS PULLOVER	33
669 MENS SWEATER	34
670 COLLARS	36
0000 KNITKING NEWS	37

Cover

651

NEW BEGINNINGS

As we enter into our 22nd year, KNITKING MAGAZINE will continue to provide our subscribers with the best in machine knitting, the tops in fashion design and beautiful yarns for every garment. Our COVER MODEL dress is an example of simple elegance. Knit it with Roma and Mami Rex on any Standard or Electronic Machine with Ribbing Attachment.
Sizes 8 to 14.



Editorial

Once again at the beginning of a new year, we thank all of our subscribers and KNITKING customers for their loyal support and for helping to make the preceding year (1987) a record sales year.

The rapid devaluation of the U.S. dollar made it a rough year for most companies that depend upon imported products for their livelihood and KNITKING was no exception. The aim of devaluation is, of course, to encourage consumers to purchase U.S.-made products. Unfortunately, there are no home knitting machines made in the U.S.A. and the consumer has no alternative but to pay increased prices. We did however keep increases to an absolute minimum and stockpiled whenever we were notified of pending price increases. Consequently we were able to maintain prices that were much lower than the competition. At the time this editorial is being written, one U.S. dollar buys 123.55 Yen. In February 1985, one dollar was worth 263.00 Yen. This should really mean a doubling of price but our suppliers also have endeavored to keep price increases to a minimum. They have notified us that there will be an increase starting January 1988. We are well-stocked on all machines, at current prices, so . . . if you are considering buying a new machine or trading in your present one, we urge you to save money by ordering as soon as possible.

Our record sales volume in 1987 would have been even higher had our prediction regarding the availability of the Electric Drive Unit and the KCIII Computer for the COMPUKNIT III come true. Unfortunately, the Underwriters Laboratory again dragged its feet and we are still awaiting their approval. It is difficult to understand how it takes over eight months to approve a comparatively uncomplicated machine such as the Electric Drive Unit. Our suppliers will not market it without the Underwriters seal of approval so we are at their mercy. Approval cannot be long now in coming both for the Drive Unit and the Computer, and you can bet we will not waste any more time in the marketing of these and other new products in 1988.

We introduced in 1987 the new KK 93 knitter, undoubtedly the finest and most versatile punch card programmed knitter on the market. We introduced the remarkable and efficient LECTROLINK linking machine and the low-priced CALCUKNIT computer for charting any shape or style of knitted garment easily and with great precision. We also introduced the SIMPLE SEVEN beginner's knitting machine complete with a Video cassette instruction course, and we started producing floppy disks programmed with the pattern stitches for garments in each issue of KNITKING MAGAZINE.

We look forward to 1988 with great enthusiasm. We anticipate that it will be another record sales year, we expect to introduce many new products and we look forward to receiving letters from our readers with their likes and dislikes outlined. This is your magazine and it is our aim to make it just the way you like it.

Publisher: KNITKING CORPORATION, 1128 Crenshaw Blvd., Los Angeles, CA 90019. Telephone: (213) 938-2079. Published quarterly.
Subscriptions: USA-\$18.00 annually, single copies \$5.00. \$21.00 -all other countries. The entire contents of KNITKING MAGAZINE are copyrighted and must not be reproduced in any shape or form without the express permission, in writing, of the publisher.
©COPYRIGHT 1988 KNITKING CORPORATION



654

IRRESISTIBLY SOFT

Angora sleeves compliment Ice Cream and Mirage More for an enchanting pullover. The bodice is knitted in Tuck Stitch on the Electronic Machine with the sleeves knitted on the Bulky. Rib the bands. Sizes 8 to 14.



655

COPY CAT

Reminders of a Ship Officers' Jacket, you can compete for attention on any spring cruise. A Garter Carriage does all the work for you. It's double breasted and complete with gold stripes and buttons. Make it on any Standard or Electronic Machine with Garter Carriage. The yarn is Venetia and the sizes are 8 to 14.



656

SUBTLE COLORING

provides a soft and delightful look on a two piece dress. The center front has a Fair Isle design using Venetia. Side panels are Angora with cable twists for texture. The skirt and sleeves are a lace design. Knitted on the Electronic Machine with Ribber. Cuffs and neck band are 1x1 Ribbing. Sizes 10/12 (14).



657

DISCOVER

the world of applique for trimming this lovely pullover. A matching slim skirt makes a perfect ensemble. Knit the top sideways in Stockinette Stitch using Venetia and Glace for Plating. The trim is snakeskin appliqued in place with embroidered stems. (we tell you how). Bands are ribbed. Sizes 8 to 16.



658

A MASTERPIECE

is an eye catching dress in two colors. It's simple to knit with a band of Fair Isle below the hipline. Isolate another design down the front section. Knit it with our Pearlyte and glittery Mami Rex for that special sparkle. Make it on your Electronic Machine. The skirt is Full Needle Ribbing. Sizes 8 to 14.



659

MODERN ARTISTRY

Step out in a two piece dress with a jungle motif on yoke and sleeves and bordered with stripes. A separate dickey is included to make a striped high neck collar. Remove the dickey for a cooler look. You'll use your Ribber with Electronic Machine for no floats on the back of yoke design. Venetia is the yarn, sizes are 6 to 14.

General Instructions

THE PRINTED INSTRUCTIONS

Follow the printed instructions or use them in combination with the Charts. When there is any question in the instructions, you have the Charts to show you how the section will look.

Be sure to READ AHEAD so that you KNOW what to do for the size you are knitting. In the shapings, where the number of stitches are the same but the number of times different, you might find shapings like this...3 sts. 1 (2) [3]x - so that for the first size you will bind off 3 sts. 1x, 2nd size 3 sts. 2x, 3rd size 3 sts. 3x. Sometimes the ROWS will be different for each size-so you must watch out for different row numbers.

Shoulder and neck shapings for the back section of a garment usually are shaped at the same time-so ALWAYS WATCH for the words, AT THE SAME TIME.

HOLDING STITCHES ON THE LEFT SIDE WHILE SHAPING THE RIGHT SIDE

There are different ways to hold stitches on one side while completing the other side. Usually, we tell you to bind off the center sts. for neck and put the left side into holding position while completing the right side. The easiest way, and really the best for beginners, is to take a piece of RAVEL CORD and hand knit the center neck stitches, pulling them back against the needle bed of machine to the "A" or out of work position. The stitches remain in the HOOKS of the needles so you are really only knitting them HALF WAY. With another color of Ravel Cord, knit the remaining sts. on the left side in the SAME WAY.

It is important to protect these held stitches in some way-so you can either hang a REVERSING BAR so that the EYES of the bar go BETWEEN the Gate Pegs on the machine and that the UPPER TIPS of bar only show above the needle bed, OR the simplest way is to use a piece of 1" masking tape and GENTLY place it beneath the knitting-right below the Gate Pegs. DO NOT press the tape, only enough pressure to hold it in place. This will prevent the Carriage (or Slide) from marking the held section.

It is VERY IMPORTANT that you mark the PATTERN ROW where you divide for the split for NECK (or SHOULDER) shaping. If you are using a PUNCH CARD, mark the card-if you are using an ELECTRONIC machine, mark the design window. Also take note of the Row number for the division. When you are ready to work the left section, bring the HELD stitches back to "B" (working) position by pulling each end of the Ravel Cord GENTLY and ripping it off. Be sure to align all needles straight in the "B" or knitting position.

Now you are ready to REFER TO YOUR OWN INSTRUCTION MANUAL for your machine to set the controls to begin knitting the left half. The neck stitches can be bound off after completing the right side, or you can leave them in hold until each side is finished. Bind off or remove them onto contrast waste yarn ready to be picked up for knitting a neckband or for other finishing.

FULL FASHION DECREASING OR INCREASING

For stockinette stitch, use the Full Fashion method for decreasing or increasing (except for regular cap shaping on sleeves where you decrease the edge stitch).

TO DECREASE: Hang the 3rd stitch onto the 2nd stitch, then move the end stitches in to fill the empty needle.

TO INCREASE: Move the 2nd end stitches 1 needle outward, then pick up the 3rd stitch from the row below and hang it onto empty needle.

PATTERN SYMBOLS

() Symbol for 2nd size.

[] Symbol for 3rd size.

There are up to 3 sizes given for Patterns in KNITKING MAGAZINE. For example, the Charts and printed instructions will show the cast on as - 124, first size, (132), second size, [140] third size.

Needles in holding position.

Needles back into working position

Needle not used-in out of work position

3x1 The number in the box is the number of Rows between shapings. The

3x1 above the box gives the sts., and the number of times to make the decreases (or increases). For example: 3x1 over the box with 4 means- At the given Row number, *decrease 1 st., knit 4 rows* and REPEAT from * to * 2 times more for a total of 3 times in all. All decreasing (or increasing) WITHOUT ROW NUMBER IN BOX must be made on EVERY 2ND ROW.

THE SAMPLE SWATCH

Before you knit any garment, you must knit a sample swatch using the yarn you have chosen for your garment. If you do not get the correct Stitch and Row Gauge as given for a Pattern in KNITKING MAGAZINE, try different tensions. If you are using the specified yarn, you should be able to get the correct gauge using a smaller or larger tension. If you are using a different yarn, you may have to make several swatches, but the gauge is very important.

To make a sample swatch, Cast on 60 stitches with waste yarn and knit 6 rows. Mark the tension number for your sample swatch by making holes (you can do this with a Lace Carriage or by hand), 4 transfers for Tension 4, 6 transfers for Tension 6, etc. Knit 6 more rows.

Change to garment yarn and set Counter at 0. Knit 30 rows (in Stockinette stitch or Pattern stitch, according to the garment). With Contrast waste yarn, knit the 10th stitch FROM EACH SIDE by hand. Knit 30 rows. Change to waste yarn and knit 12 rows. Remove the sts. from the machine by pushing the Carriage (or Slide) across without yarn.

Pull and stretch the sample swatch both lengthwise and diagonally from corner to corner, then lengthwise again. Gently block the swatch (KNITKING PRESSING CLOTHS are great for this), or you can allow the sample to rest several hours or even over night so that the stitches can return to their basic form.

THE KNITKING STITCH/ROW GAUGE and STITCH/ROW CALCULATOR can be used to find the NUMBER OF STITCHES or ROWS TO 1". After knitting a sample swatch place the STITCH/ROW GAUGE horizontally with the START LINE on the INSIDE of LEFT stitch mark on sample. Keep it straight then read the number on the Gauge directly below the inside RIGHT mark on Gauge. This will give you the STITCH GAUGE TO 1". For instance, if the number is 8, then you have 8 stitches to 1". To find the ROWS TO 1", measure from the first row of garment yarn, VERTICALLY to the last row. Read the NUMBER from the LOWER EDGE of GAUGE, same as you did for stitches and if the number should be 14, you have 14 rows to 1".

12 Rows		12 Rows
60 Rows	10 • 40 STS • 10 ↑ ↑ Mark Mark	30 Rows 30 Rows
12 Rows	○○○○ tension holes contrast yarn	6 Rows 6 Rows
60 STS		

THE STITCH/ROW CALCULATOR will now give you the number of sts. or rows needed for a specific measurement. Line the ARROW to the number 8 (8 sts. to 1"). Should you need 20 inches of stitches, find the number 20 below and right above the 20 the Calculator shows 160 sts. It works the same way for rows using the Row Gauge.

FINISHING

Gently block all sections-For PULLOVERS, JACKETS, and DRESSES: Join the front to back at shoulders and sides. Sew sleeves together and set in. Hem lower edge and sleeve edges if needed. For a double neckband or armhole band, sew 1 edge to inside and 1 to the outside of neck or armhole. For a single ribbed band, sew 1 edge to the outside of neck or armhole edge. For a cardigan or jacket with buttonholes, finish buttonholes and sew on buttons.

PANTS: Join front to back at sides. Sew inside leg seams, then join to center front and back. Make hem at waistline and inset elastic. Hem lower edge of pant legs.

ABBREVIATIONS

BO	Bind Off	L.C.	Lace Carriage
Carr.	Carriage	MB	Main Bed
CO	Cast on	Ndis.	Needles
Col.	Color	Pat.	Pattern
Dec.	Decrease	P	Purl
EON	Every Other Needle	RB	Ribber Bed
FNR	Full Needle Rib	R	Row
G.C.	Garter Carriage	St.	Stitch
G.S.	Garter Stitch	St. st.	Stockinette Stitch
HP	Holding Position	Strnd	Strand
Inc.	Increase	T	Tension
I.C.	Intarsia Carriage	W.Y.	Waste Yarn
K	Knit	WP	Working Position



WOMENS DRESS

YARN:

Col. 1: Roma
Col. 2: Mami Rex
SIZES: 8/10 (12/14)
AMOUNT:

Col. 1: 26 27 oz.
Col. 2: 4 4 spools
KIT PRICE: \$59.00 61.00
TENSION: T 4.1, Rib: 1.1/1.1 II
FNR: 2.1/2.1 I
GAUGE: 16.5 sts. 23 rows = 2"

Make on any Standard or Electronic Machine with Ribber.

DRESS SKIRT:

Make 2.
FNR: With Col.1, Cast on 156 (164) sts. Knit 14 Rows. Transfer Rib sts. to MB and continue in St. st. After R 250 (256), remove on contrast W.Y.

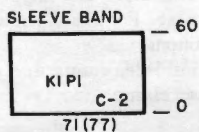

WAIST BAND:

KI/PI Rib: With 2 strands Col. 2 together, Cast on 157 (165) sts. After selvedge, change to T 1.1/1.1 II, and knit 70 rows. Transfer rib sts. to MB and double 1 end st. With Wrong side facing, hang open sts. of skirt onto these ndls.

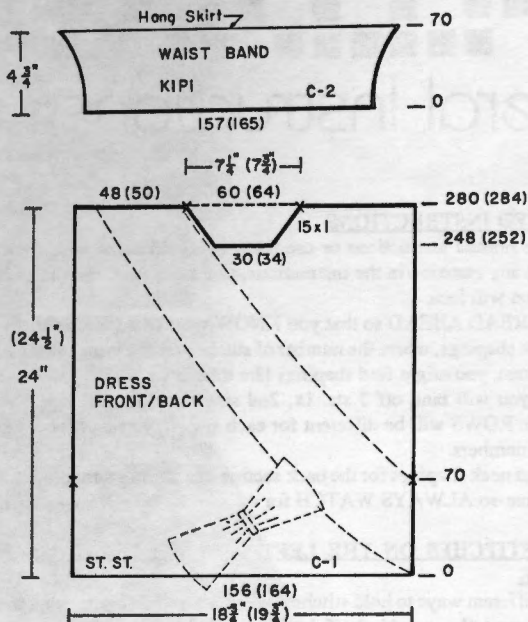

BODICE:

Set Counter to 0. Change to Col. 1 and in St. st. knit 70 rows. ON EACH SIDE, mark with W.Y. for sleeve. After R 248 (252), shape neck. BO the center 30 (34) sts. Place remaining sts. on the left into HP and complete the right side first. *On neck edge, decrease 1 st. EOR 15x. After R 280 (284), BO or remove on contrast W.Y. Turn Counter back to 248 (252). Bring ndls. on the left back into WP and knit the left half following instructions from *.

BACK:

Same as front but omit neck shaping. After R 280 (284), mark neck opening with W.Y. and BO or remove on W.Y.

SLEEVES:

Make 2, reverse 2.
LEFT SECTION: *Bring 140 (144) ndls. to WP. With wrong side facing, using W.Y. marker as a guide, hang the sleeve opening onto these ndls. (from W.Y. marker to shoulder). With Col. 1, continue in St. st. ON THE UNDERARM SIDE, BO 2 sts. 20x, 1 st. every 4 rows 30x. After R 170 (176) remove on contrast W.Y.* Follow * to * for right section.

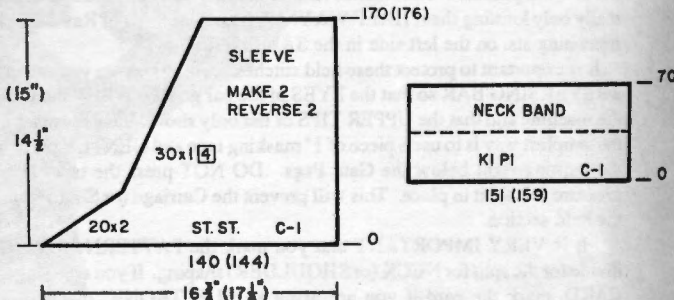

SLEEVE BANDS:

Join 2 sleeve sections to make one full sleeve.
KI/PI Rib: With 2 strands of Col. 2, Cast on 71 (77) sts. After selvedge, knit 60 rows. Transfer rib sts. to MB. With wrong side facing, hang open sts. of sleeve onto these ndls., decreasing evenly across and BO.

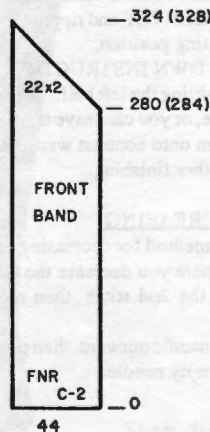

NECK BAND:

KI/PI Rib: With 2 strands of Col. 2, Cast on 151 (159) sts. Knit 70 rows. Transfer rib sts. to MB. Pick up first row to form hem. Knit 1 row and remove on W.Y.

FRONT BAND:

FNR: With 2 strands of Col. 2, Cast on 44 Sts. Knit 280 (284) rows. On right side, BO 2 sts. EOR 22x. End with row 324(328).

BOW:

FNR: With 2 strands of Col. 2, Cast on 44 sts. Knit 260 rows. Transfer rib sts. to MB and BO.

BOW TRIM:

FNR: With 2 strands of Col. 2, Cast on 6 sts. Knit 30 rows. Transfer rib sts. to MB and BO.

FINISHING:

See General Instructions. Weave Neck Band to Neck opening. On each side of front band, crochet 1 row of single crochet with 2 strands of Col. 2. Sew front band to Front (See chart for placement).

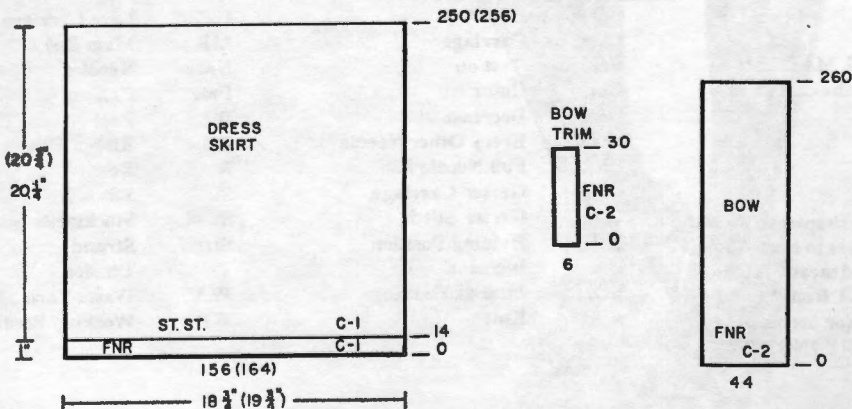



WOMENS DRESS WITH LACE INSET

YARN: Venetia
SIZES: 4/6 (8/10) [12/14]
AMOUNT: 31 32 33 oz.
KIT PRICE:
 \$48.00 50.00 52.00
TENSION: St. st. 5, FNR 6/6 II
GAUGE: 15 sts. 24 rows = 2"

Make on any Electronic machine, or substitute any suitable punch card lace pattern. The diamonds are isolated lace. Body of dress is St. st. Bands are FNR.

SKIRT:
 Make 4. FNR: Cast on 144 (150) [156] sts. Knit 14 rows. Transfer rib sts. to MB and continue in St. st. After R 59, change to T10, and knit 1 row to the right. Change to T5 and knit 30 rows. Hang row, knit at T10 to form sideways pleat. Continue in St. st. After row 302 (310) [318], remove on contrast W.Y. Join 2 panels together to make front. Repeat for back.

FRONT:
 W.Y. Cast on 172 (180) [188] sts. After several rows, end with 1 row Ravel Cord to the right. Counter 0. With W.Y., mark sts. for pleat (See Chart). Change to garment yarn and knit 10 rows. ON EACH SIDE, decrease 1 st. every 6th row 10x. After R 74, ON EACH SIDE, increase 1 st. every 8th row 10x. AT THE SAME TIME, after R 104 (112) [120], begin hand transfer to frame design. After R 114 (122) [130], set lace patterns. READ IMPORTANT NOTE IN BOLD TYPE BEFORE PROCEEDING TO MANUALLY ISOLATE THE DESIGN.

NOTE: SPECIAL LACE INSTRUCTIONS

Front and sleeve design are the same. The diamond design is outlined with HAND TRANSFERS for the edge eyelets. Follow the drawing for these hand transfers. Always leave empty ndls. in work after transfers for eyelets.

The first transfer for point: Transfer the center ndl. to the right. Knit 2 rows. Transfer the next 2, right to right, left to left; knit 2 rows and repeat again. Continue in this way following the outline drawing BUT AT THE SAME TIME, when center is reached (59 sts) begin decreases for the second half of diamond. MAKE OUTLINE TRANSFERS FIRST, then program and set lace pattern.

IMPORTANT NOTE: PUSH BACK TO B POSITION ALL SELECTED NDLS. THAT ARE OUT-SIDE THE HAND TRANSFERS ON EACH SIDE, BEFORE USING LACE CARRIAGE TO MAKE THE CENTER LACE DESIGN.

Knit 2 rows. Make the hand transfers, then use lace carriage to select the ndls. and continue in pattern. After R 160 (164) [168], shape armhole. ON EACH SIDE, BO 4 (5) [6] sts. 1x, 4 sts. 1x, 3 sts. 1x, 2 sts. 1x, 1 st. 5 (6) [7]x. After R 228 (236) [244], BO the center 38 (40) [42] sts. Place the ndls. on the left into HP and complete the right side first. *On Neck edge, BO 1 st. EOR 7 (8) [9]x. After R 260 (268) [276], mark sts. with W.Y. for pleat (same as bottom) and BO or remove on W.Y. Bring ndls. on the left back to WP. Turn counter back to R 228 (236) [244], and complete the same as right side following instructions from *.

MAKE PLEATS NEXT: Starting at Neck edge, count 11 sts. over. This is the fold line. Using a total of 21 sts., fold and sew pleat in place (See Chart).

BACK:
 Same as front, but omit lace and Neck shaping. After R 260 (268) [276], place markers for Neck opening 42 sts. in from each side. BO or remove each section on W.Y.

JOIN SKIRT TO FRONT/BACK AS FOLLOWS:
 Bring 130 (138) [146] ndls. to WP. With RIGHT SIDE facing, hang open sts. of front onto these ndls. With WRONG SIDE facing, hang open sts. of skirt onto these same ndls. decreasing evenly across. BO.

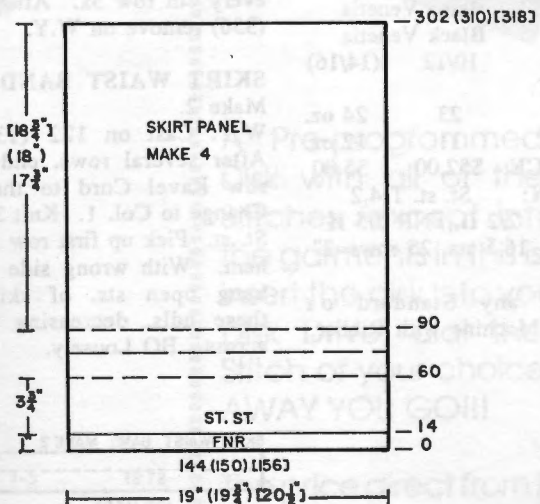
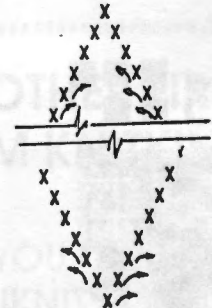
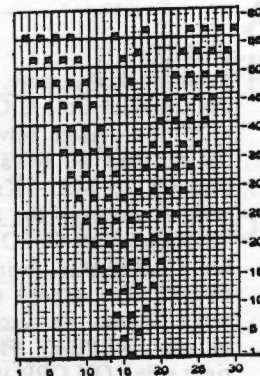
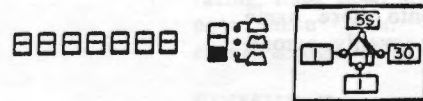
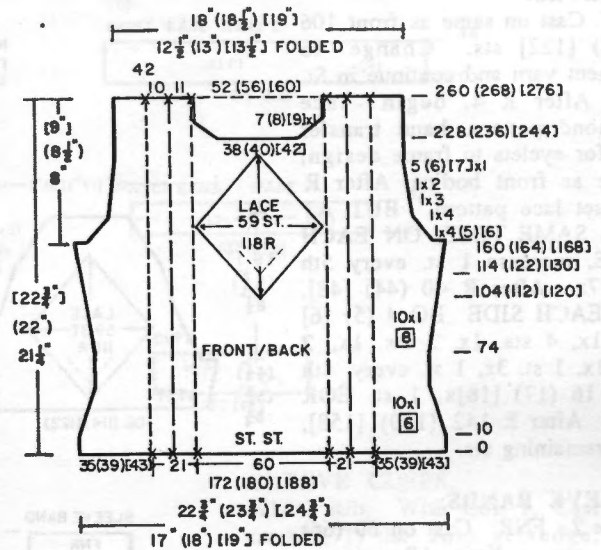

SLEEVES:

W.Y. Cast on same as front 106 (114) [122] sts. Change to garment yarn and continue in St. st. After R 4, begin lace diamond pattern, hand transfer sts. for eyelets to frame design, same as front bodice. After R 14, set lace pattern. **BUT AT THE SAME TIME, ON EACH SIDE, increase 1 st. every 5th row 7x. After R 40 (44) [48], ON EACH SIDE BO 4 (5) [6] sts. 1x, 4 sts. 1x, 3 sts. 1x, 2 sts. 1x, 1 st. 3x, 1 st. every 4th row 16 (17) [18]x, 1 st. EOR 12x. After R 142 (150) [158], BO remaining sts.**

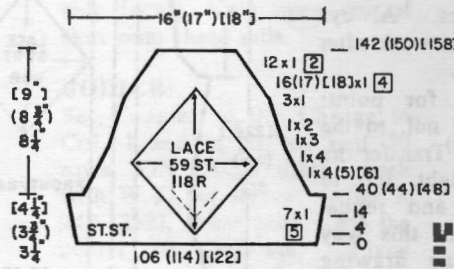
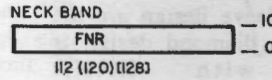

SLEEVE BANDS:

Make 2. FNR: Cast on 60 (66) [72] sts. Knit 10 rows. Transfer rib sts. to MB. With **WRONG SIDE** facing, hang open sts. of sleeve onto these same ndls. decreasing evenly across. BO Loosely.



NECK BAND:

Make 1. FNR: Cast on 112 (120) [128] sts. Knit 10 rows. Transfer rib sts. to MB. Knit 1 row over all sts. and remove on W.Y.

FINISHING:

See General Instructions. Gather top of sleeve to form puff and set in. Weave Neck Band to Neck Opening.

OPTIONAL: Make shoulder pads and sew in place.

653



WOMENS SKIRT AND TOP

YARN:

- Col. 1: Beige Venetia
- Col. 2: Black Venetia
- SIZES:** 10/12 (14/16)
- AMOUNT:**
- Col. 1: 23 24 oz.
- Col. 2: 11 12 oz.
- KIT PRICE:** \$52.00 55.00
- TENSION:** St. st. T 4.2
- K1/P1 Rib:** 2/2 II, FNR 5/5 II
- GAUGE:** 16.5 sts. 25 rows=2"

Make on any Standard or Electronic Machine with Ribber.

SKIRT:

Front/Back the same.
FNR: With Col. 1, Cast on 164 (173) sts. After selvedge, at T 5/5 II, knit 20 rows. Transfer Rib sts. to MB. Knit 2 rows and set carriage for Short Row Knitting. *ON OPPOSITE SIDE OF CARRIAGE, bring 40 ndls. to HP. Knit across (be sure to wrap inside ndl. to prevent holes). REPEAT FROM * for right side. ON OPPOSITE SIDE OF CARRIAGE PUSH BACK to WP 20 sts. 2x on each side. Continue in St. st. ON EACH SIDE, increase 1 st. every 14th row 10x. After R 304 (316), ON EACH SIDE, decrease 1 st. every 8th row 5x. After R 344 (356) remove on W.Y.

SKIRT WAIST BAND:

Make 2.
W.Y. Cast on 122 (130) sts. After several rows, end with 1 row Ravel Cord to the right. Change to Col. 1. Knit 30 rows St. st. Pick up first row to form hem. With wrong side facing, hang open sts. of skirt onto these ndls. decreasing evenly across. BO Loosely.

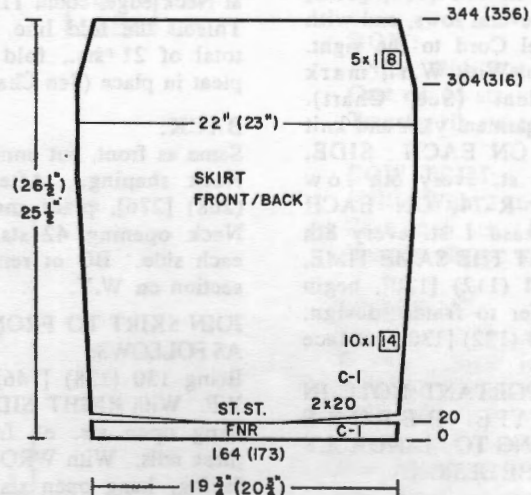
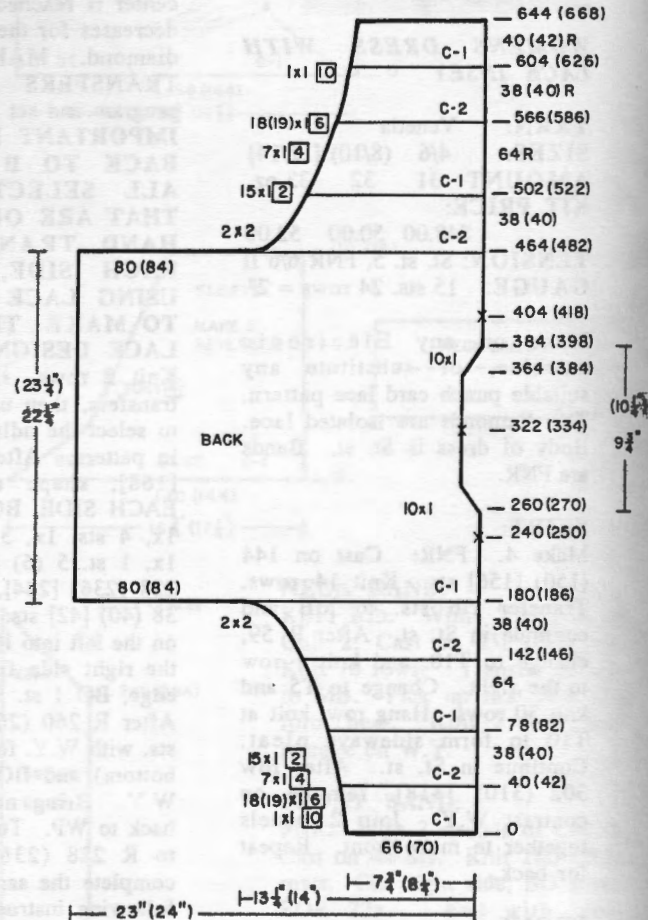
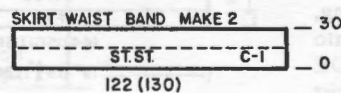

TOP BACK:

Starting at ndl. 100 to the right of 0, W.Y. Cast on 66 (70) sts to the left. After several rows, end with 1 row Ravel Cord to the right. Change to Col. 1, and continue in St. st. **ON THE LEFT SIDE**, increase 1 st. every 10th row 1x, 1 st. every 6th row 18 (19)x, 1 st. every 4th row 7x, 1 st. EOR 15x, 2 sts. 2x. **BUT AT THE SAME TIME**, after R 40 (42), change to Col. 2. After R 78 (82), change to Col. 1. After R 142 (146), change to Col. 2. After R 180 (186), change to Col. 1. **ON THE LEFT SIDE**, after R 180 (186), Cast on 80 (84) sts (Refer to KNITKING NEWS this issue on how to cast on large numbers of sts.). After R 240 (250), mark shoulders with W.Y. (this is where you join the front panel). After R 260 (270), on Neck edge BO 1 st. EOR 10x. After R 322 (334), with W.Y. Mark each side for center of garment. Continue in St. st. After R 364 (384), Cast on 1 st. EOR 10x. After R 404 (418), Mark right side with W.Y. After R 464 (482), **ON THE LEFT**, BO 80 (84) sts. Change to Col. 2. On the left BO 2 sts. EOR 2x, 1 st. EOR 15x, 1 st. every 4th row 7x, 1 st. every 6th row 18 (19)x, 1 st. every 10th row 1x. **BUT AT THE SAME TIME**, after R 502 (522) change to Col. 1. After R 566 (586), change to Col. 2. After R 604 (626), change to Col. 1. After R 644 (668) remove remaining sts. on W.Y.

FRONT SIDE PANELS:

Make 1, reverse 1. Same as back to R 240 (250). Starting at Neck edge, BO 14 sts. 9x, 13 sts. 5x (14 sts. 10x, 15 sts. 4x). End at R 268 (278).

FRONT CENTER PANEL:

W.Y. Cast on 68 (72) sts. After several rows, end with 1 row Ravel Cord to the right. Change to Col. 2, and continue in St. st. **ON EACH SIDE**, increase 1 st. every 13th row 13x, 1 st. every 14th row 8x. After R 276 (288), BO the center 26 (30) sts. Place remaining sts. on the left to HP, and complete right side first. *On Neck edge, BO 7 sts. EOR 4x. After R 286 (298), BO remaining sts. Bring ndls. on the left into WP. Turn counter back to 276 (288) and knit left half following instructions from *. **JOIN LEFT AND RIGHT PANELS TO FRONT CENTER PANEL.**

TOP WAIST BANDS:

Make 2. K1/P1 Rib: With Col. 1, Cast on 155 (165) sts. After selvedge, change to T 2/2 II and knit 44 rows. Transfer Rib sts. to MB. With wrong side facing, hang Front/Back onto these ndls. and BO Loosely. **JOIN ONE SHOULDER.** Use W.Y. markers for placement of Front center panel.

NECK BAND:

Make 1. K1/P1 Rib: With Col. 1, Cast on 167 (173) sts. After selvedge, knit 32 rows. Transfer Rib sts. to MB. Pick up first row knit to form hem. Knit 1 row over ndls. in WP. With **WRONG** side facing, hang neck opening onto these ndls. and BO Loosely. **CLOSE 2 N D SHOULDER.**

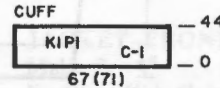
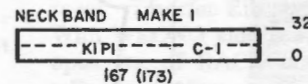
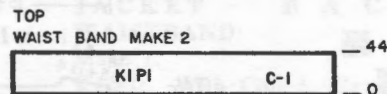

SLEEVE CUFFS:

K1/P1 Rib: With Col. 1, Cast on 67 (71) sts. After selvedge, knit 44 rows. Transfer Rib sts. to MB. With **WRONG** side facing, hang open sts. of sleeve onto these ndls. decreasing evenly across. BO Loosely.

FINISHING:

See General Instructions.

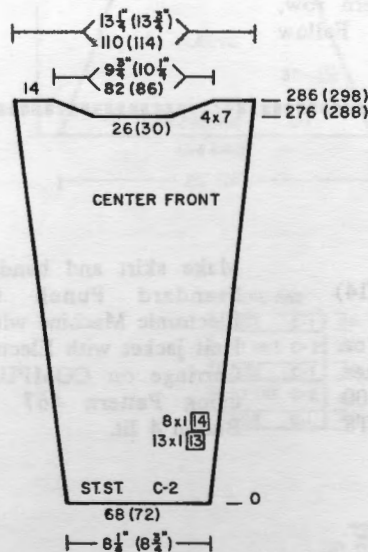
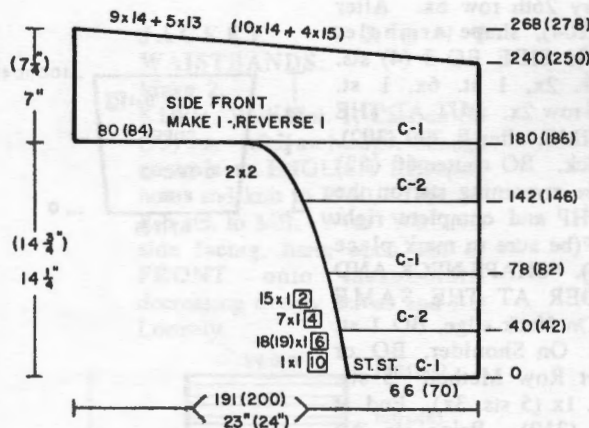

ANOTHER FIRST FROM KNITKING!

IF YOU OWN A COMPUKNIT III (KH 930), THIS IS FOR YOU!!

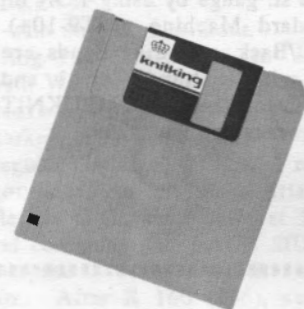

A Pre-programmed Floppy Disk with all of the Pattern Stitches (except intarsia) for the garments in this issue. Just insert the disk into your Floppy Disk Drive, dial the Pattern Stitch of your choice and . . . **AWAY YOU GO!!!**

The price direct from KNITKING is \$9.95 plus \$.50 shipping.

654 ■■■

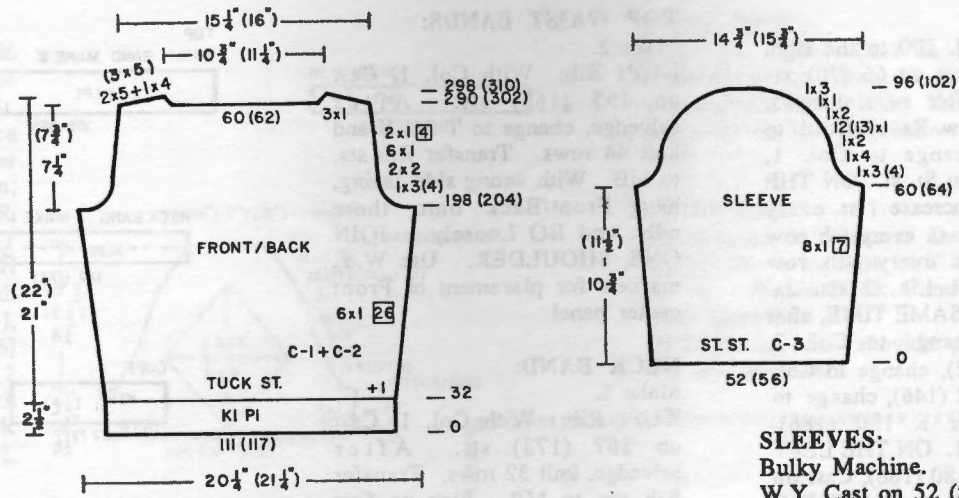

WOMENS ANGORA PULLOVER

YARN:
 Col. 1: Ice Cream
 Col. 2: Mirage More
 Col. 3: Angora
SIZES: 8/10 (12/14)
AMOUNT:
 Col. 1: 20 22 oz.
 Col. 2: 1 spool for all sizes
 Col. 3: 8 balls for all sizes
KIT PRICE: \$100.00 104.00
TENSION: Tuck St. T9
 St. st (Angora) T4 Rib 2/2 I
GAUGE:
 Tuck st. 12 sts. 25 rows = 2"
 St. st. (Ang.) 9 sts. 11 rows = 2"

FRONT/BACK:
 K1, P1: With Col. 1 & 2 together Cast on 111 (117) sts. After selvedge, knit 32 rows. Transfer Rib sts. to MB. Add 1 st. on the right. Knit 1 row to the left. Set Pattern and knit to the right to select ndls. Set carriage for Tuck st. and continue. **BUT AT THE SAME TIME, ON EACH SIDE, increase 1 st. every 26th row 6x.** After R 198 (204), shape armhole. **ON EACH SIDE BO 3 (4) sts. 1x, 2 sts. 2x, 1 st. 6x, 1 st. every 4th row 2x. BUT AT THE SAME TIME, after R 290 (302), shape Neck. BO center 60 (62) sts. Place remaining sts. on the left into HP and complete right side first (be sure to mark place in pattern). *SHAPE NECK AND SHOULDER AT THE SAME TIME. On Neck edge, BO 1 st. EOR 3x. On Shoulder, BO or use Short Row Method 5 sts. 2x, 4 sts. 1x (5 sts. 3x). End at row 298 (310). Bring sts. on the left into WP. Turn Counter back to 290 (302). Be sure to be on the correct Pattern row, and complete left half. Follow instructions from *.**

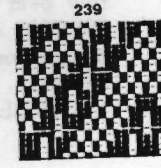

SLEEVES:
 Bulky Machine.
 W.Y. Cast on 52 (56) sts. After several rows, end with 1 row Ravel Cord to the right. Change to Col. 3 and continue in St. st. **ON EACH SIDE, increase 1 st. every 7th row 8x.** After R 60 (64), **ON EACH SIDE, shape sleeve cap BO 3 (4) sts. 1x, 4 sts. 1x, 2 sts. 1x, 1 st. 12 (13)x, 2 sts. 1x, 1 st. 1x, 3 sts. 1x.** After R 96 (102), BO the remaining sts.

SLEEVE CUFFS:
 Standard Machine.
 K1, P1: With Col. 1 & Col. 2 together, Cast on 67 (73) sts. **ON EACH SIDE, increase 1 st. every 10th row 9x.** Knit 100 (104) rows.. Transfer Rib sts. to MB. With wrong side facing, hang open sts. on Angora sleeve onto these ndls. decreasing evenly across. BO Loosely.

FINISHING:
 See General Instructions. Join shoulder seams. Set in sleeves. With 1 strand Col. 1 & Col. 2 together, crochet 1 row around neck opening. With 1 strand Angora, Crochet 2 rows around neck opening.

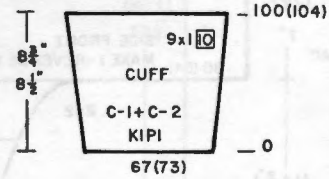

655 ■■■



WOMENS CHANEL SUIT

YARN:
 Col. 1: Venetia
 Col. 2: Isabella
SIZES: 8/10 (12/14)
AMOUNT:
 Col. 1: 50 52 oz.
 Col. 2: 2 balls all sizes
KIT PRICE: \$79.00 82.00
TENSION: St. st T4, G.C. T8 English Rib & FNR 5/5 II
GAUGE:
 St. st. 16 sts. 26 rows = 2"
 Elec.G.C. 13 sts. 24 rows = 2"
NOTIONS: 6 lg. buttons (2 cm.)
 2 smaller buttons for shoulder (1-1/2 cm.)
NOTE: Make Jacket with 2 strands of Color 1 together throughout entire garment.

Make skirt and bands on any Standard Punch Card or Electronic Machine with Ribber. Knit jacket with Electric Garter Carriage on COMPUKNIT III using Pattern 467 variation Button 4 lit.

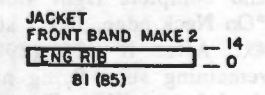
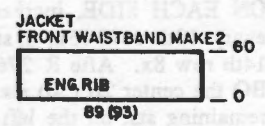

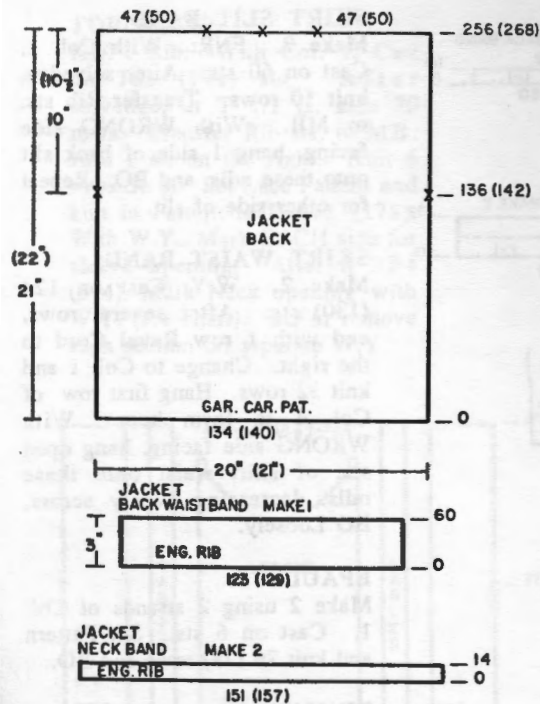

JACKET BACK:

W.Y. Cast on 134 (140) sts. After several rows, end with 1 row Ravel Cord to the right. Set Pattern and attach Electric G.C. At T8, knit in Pattern. After R 136 (142), mark each side with W.Y. for sleeve opening. After R 256 (268), mark center and shoulder with W.Y. See Chart. BO or remove on W.Y.

JACKET RIGHT FRONT:

Reverse left front and omit stripes.

W.Y. Cast on 100 (103) sts. same as back. Set Pattern and with G.C. knit to R 96 (100). Mark edge (see chart) with W.Y. and begin Neck shaping. BO 1 st. 1x, 1 st. every 4th row 2x, 1 st. 6x, 2 sts. 1x, 2 sts. 5x, 1 st. 4x, 2 sts. 2x, 1 st. 10x, 1 st. every 4th row 9x, 1 st. every 6th row 3x, 1 st. every 8th row 2x. BUT AT THE SAME TIME,

after R 136 (142), mark side edge with W.Y. for sleeve opening. After R 194 (206), begin gold stripes. In St. st. knit 4 rows with Col. 1. Set Pattern and with Col. 2, (2 strands together) knit 8 rows. Repeat sequence 1 more time. End stripes with 4 rows St. st. SEE CHART. Continue in Pattern. After R 256 (268), BO or remove on W.Y.

NOTE: FOR ALL BANDS THAT ARE ENGLISH RIB:

For the bands, the ENGLISH RIB (sometimes called half Fishermans Rib) Ribber controls are all set to NORMAL. On the MB, push in the LEFT tuck button ONLY. The Ribber needles will knit every row. The MB needles will TUCK going from right to left, and knit from left to right. This places the English Rib on the side FACING YOU so that when you transfer the Ribber sts., you can immediately hang the garment section onto the machine and BO.

JACKET FRONT WAISTBANDS:

Make 2. K1/P1: With Col. 1, Cast on 89 (93) sts. After selvedge, change controls to ENGLISH RIB (see note) and knit to R 60. Transfer Rib sts. to MB. With WRONG side facing, hang open sts. of FRONT onto these ndls. decreasing evenly across and BO Loosely.

JACKET B A C K WAISTBAND:

Make 1. K1/P1: With Col. 1, Cast on 123 (129) sts. After selvedge, change controls to ENGLISH RIB, as before, and knit 60 rows. Transfer Rib sts. to MB. With WRONG side facing, hang open sts. of BACK onto these ndls. decreasing evenly across. BO Loosely.

JACKET FRONT BANDS:

Make 2. K1/P1: With Col. 1, Cast on 81 (85) sts. After selvedge, change to ENGLISH RIB setting, as before, and knit 14 rows. Transfer Rib sts. to MB. With WRONG SIDE FACING, hang Front edge onto these ndls. Be sure to include Waist Band and up to R 95 (99) on Front (See X on chart). BO Loosely. Repeat for other lower front band.

JACKET NECK BANDS:

Make 2. CLOSE BOTH SHOULDERS FIRST. K1/P1: With Col. 1 Cast on 151 (157) sts. After selvedge, change to English Rib setting, as before, and knit 14 rows. Transfer Rib sts. to MB. With WRONG side facing, hang Neck edge onto these ndls (Between X on FRONT and X in center of BACK Neck Edge. See Chart).

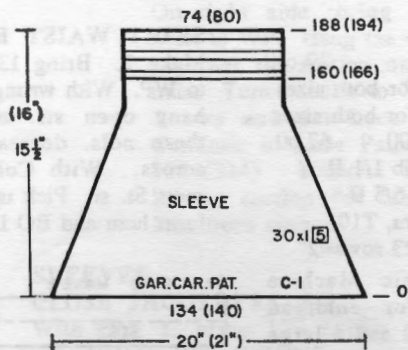

SLEEVES:

1 with stripes, 1 without. Bring 134 (140) ndls. to WP. With WRONG side facing, hang sleeve opening (between W.Y. markers onto these ndls). With Regular Carriage, T9, knit 1 row from left to right. Attach Electric G.C., set Pattern at T8, and continue. ON EACH SIDE, decrease 1 st. every 5th row 30x. After R 160 (166), stop Pattern and knit 4 rows St. st. Set Pattern and knit 8 rows with Col. 2 (2 strands together). Repeat 1 more time then end with 4 rows St. st. Remove on W.Y.

STRIPE PAT

ST. ST.	C-1	4R
G. ST. PAT.	C-2	8R
ST. ST.	C-1	4R
G. ST. PAT.	C-2	8R
ST. ST.	C-1	4R

} 28R

SLEEVE CUFFS :

K1/P1: With Col. 1, Cast on 57 (61) sts. After selvedge, change to ENGLISH RIB setting, as before, and knit 50 rows. Transfer Rib sts. to MB. With WRONG side facing, hang open sts. of sleeve onto these ndls. decreasing evenly across. BO Loosely.

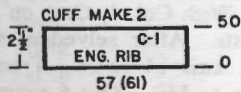
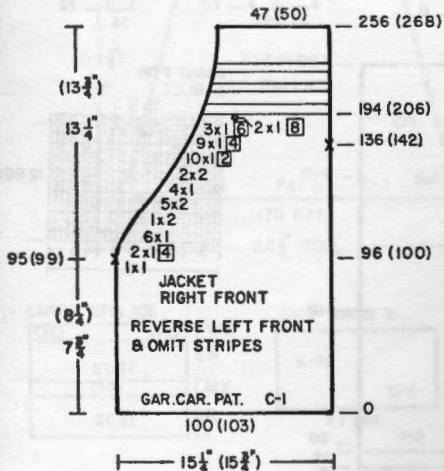

SKIRT FRONT:

Use 1 strand Col. 1, Regular Carriage.

FNR: Cast on 146 (154) sts. At T 5/5 II, knit 10 rows. Transfer Rib sts. to MB. At T4, St. st. knit 2 rows. With carriage on right start Short Rows. On side OPPOSITE carriage bring to HP 13 ndls. 3x on each side. Be sure to wrap inside ndl. to prevent holes. On each side, increase 1 st. 8x every 25 rows. ON EACH SIDE, decrease 1 st. every 10th row 8x. After R 368 (380), BO or remove on W.Y.

SKIRT BACK:

To the right of 0, Cast on 73 (77) sts. With FNR at T 5/5 II, knit 10 rows. Transfer Rib sts. to MB. At T4, in St. st knit 2 rows. On the right side do Short Rows, 13 sts. 3x. *Continue to R 100 same as front (Remember to increase 1 st. every 25th row 8x). Remove on W.Y. Cast on to the left of 0, 73 (77) sts and complete the left half following instructions from *. DO NOT REMOVE ON W.Y. Bring ndls. to WP on the right of 0, and rehang open sts. on the right side. Continue in St. st. to row 278 (286) remembering increases on each side. After R 278 (286), ON EACH SIDE, decrease 1 st. every 10 rows 8x. After R 368 (380) remove on W.Y.

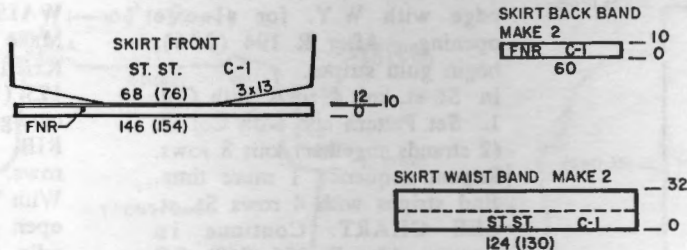

PUNCH THRU ROW 37 THEN PUNCH 2 ROWS OF HOLES FOR CONNECTING CARD.

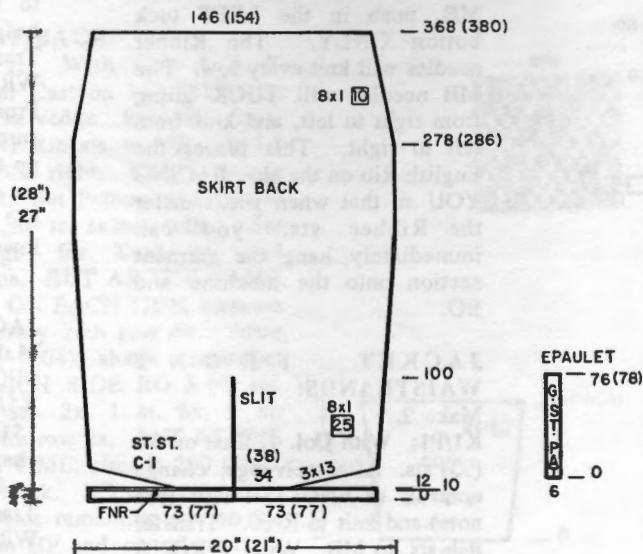
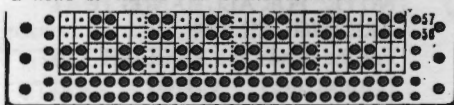

SKIRT SLIT BAND:

Make 2. FNR: With Col. 1, Cast on 60 sts. After selvedge, knit 10 rows. Transfer Rib sts. to MB. With WRONG side facing, hang 1 side of back slit onto these ndls. and BO. Repeat for other side of slit.

SKIRT WAIST BAND:

Make 2. W.Y. Cast on 124 (130) sts. After several rows, end with 1 row Ravel Cord to the right. Change to Col. 1 and knit 32 rows. Hang first row of Col. 1 to form hem. With WRONG side facing, hang open sts. of skirt waist onto these ndls. decreasing evenly across. BO Loosely.

EPAULETS:

Make 2 using 2 strands of Col. 1. Cast on 6 sts. Set Pattern and knit 76 (78) rows and BO.

FINISHING:

See General Instructions. Attach buttons. Sew epaulets to shoulder and add buttons (See picture).

656



WOMENS TWO PIECE OUTFIT WITH FLOWERS

YARN:

- Col. 1: Beige Venetia
 - Col. 2: Pink Venetia
 - Col. 3: Angora
- SIZES:** 10/12 (14)

AMOUNT:

- Col. 1: 27 29 oz.
 - Col. 2: 2 oz. for both sizes
 - Col. 3: 3 balls for both sizes
- KIT PRICE:** \$64.00 67.00
- TENSION:** T5, Rib 1/1 II
FNR, 5/5 II
Angora, T10+

GAUGE: 15 sts. 23 rows=2"

Make on Electronic Machine with Ribber. For enlarged drawing, send \$1.00 and a large SASE.

SPECIAL INSTRUCTIONS FOR LACE PATTERN:

Set Pattern. *Operate Lace Carriage 6x. End with Carriage on the left, and all ndls. in WP at positions 'B'. Knit in St. st. with Regular Carriage 6 rows*. Repeat from * to * for Pattern.

SKIRT:

Make 2.
FNR: With Col. 1, Cast on 160 (168) sts. After selvedge, at T 5/5 II, knit 14 rows. Transfer Rib sts. to MB. Knit 6 rows St. st. Set Lace Pattern and continue in Pattern. After R 320 (330), remove on W.Y.

SKIRT WAIST BANDS:

Make 2. Bring 130 (136) ndls. to WP. With wrong side facing, hang open sts. of skirt onto these ndls. decreasing evenly across. With Col. 1, knit 32 rows St. st. Pick up first row to form hem and BO Loosely.

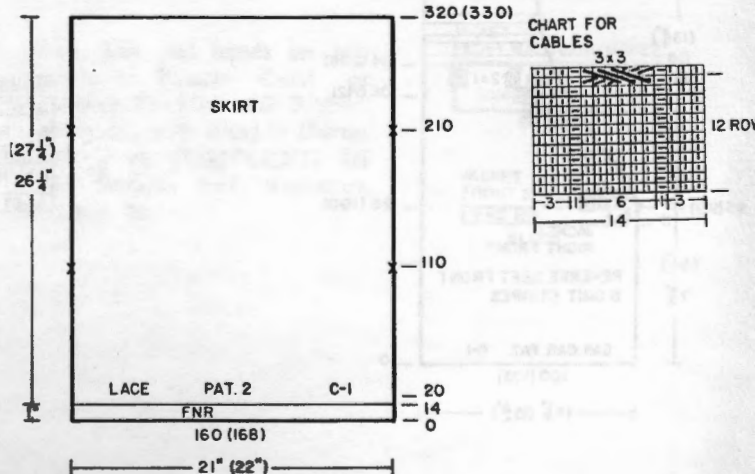
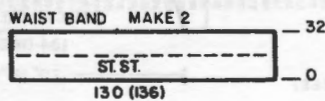

TOP BACK:

K1/P1 Rib: With Col. 1, Cast on 163 (171) sts. After selvedge, at T 1/1 II, knit 70 rows. Transfer Rib sts. to MB. Add 1 st. on the right. Knit 6 rows St. st. Set Lace Pattern and knit in Pattern to R 172 (178). With W.Y., Mark EACH side for sleeve opening. After R 304 (314), Mark Neck opening with W.Y. (see chart). BO or remove each section on separate W.Y.

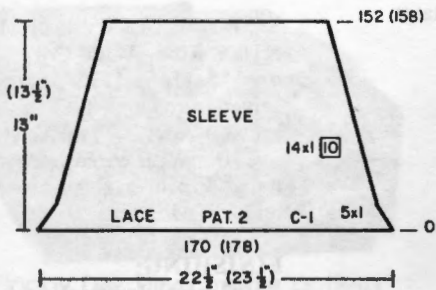
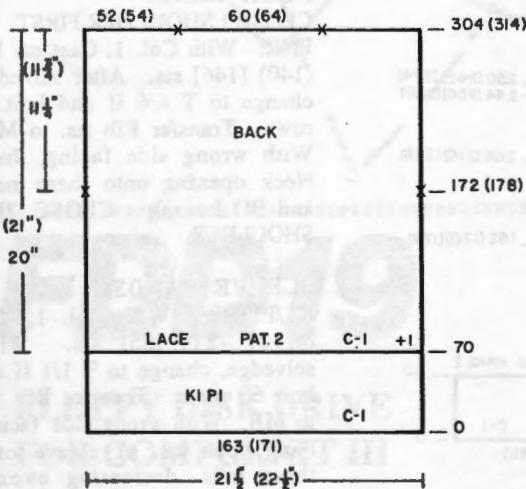
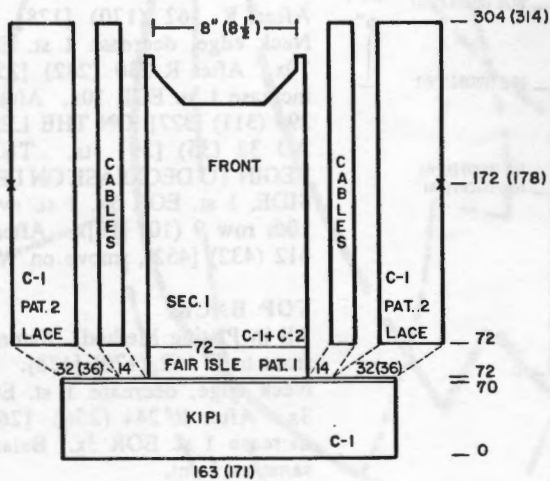
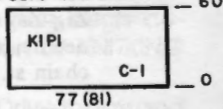

CHART FOR LACE

OO	OO	LACE
ST.ST.	6R	LACE
OO	OO	LACE
ST.ST.	6R	LACE

CUFF MAKE 2



TOP FRONT:

K1/P1 Rib: With Col. 1, Cast on 163 (171) sts. After selvedge, knit 70 rows. Transfer Rib sts. to MB and add 1 st. on the right. Knit 2 rows St. st. With W.Y., Mark ndls. so you can easily see where the different sections fit at the ribbing (See Chart). Remove the outside 32 (36) sts. on W.Y. Then remove the inner 14 sts. on W.Y. Leave the center 72 sts. in WP. Set row counter at 72. Knit 1 row to the left, over the 72 sts. Set Fair Isle Pattern and knit 1 row to the right to select ndls. Add Col. 2 and continue in Pattern. After R 270 (280), BO the center 40 (42) sts. Place remaining sts. on the left into HP and complete right side first. *On neck edge, decrease 1 st. EOR 10 (11)x. After R 304 (314), remove remaining sts. on W.Y. Turn counter back to 270 (280). Place sts. on the left into WP and knit left half following instructions from *. On one side of section just completed, bring 14 ndls. to WP. Hang the 14 sts. held on W.Y. onto these ndls. Set row counter at 72. With Col. 3, at T 10+, knit 12 rows. Drop the st. on each side of the center 6 sts. Make 3 over 3 Cable over the center 6 sts. Latch up the dropped st. and rehang onto ndl. Knit 12 rows and repeat (See Chart). After R 232 (238), remove on W.Y. Repeat for other side. Make side panels: On right side, bring 32 (36) ndls. to WP. Hang the open sts. of lower rib section onto these ndls. Turn counter to 72. Knit 4 rows and Set Lace Pattern. Continue in Lace Pattern to R 304 (314). Remove on W.Y. Repeat section for other side. Join front seams.

SLEEVES:

CLOSE SHOULDERS FIRST. With Col. 1, bring 170 (178) ndls. to WP. With WRONG side facing, hang sleeve opening onto these ndls (between W.Y. markers). Knit 6 rows St. st. Set Lace Pattern and continue in Pattern. **BUT AT THE SAME TIME,** on each side, decrease 1 st. EOR 5x, 1 st. every 10th row 14x. After R 152 (158), remove remaining sts. on W.Y.

SLEEVE CUFFS :

K1/P1 Rib: With Col. 1, Cast on 77 (81) sts. Knit 60 rows. Transfer Rib sts. to MB. Hang open sts. of sleeve onto these ndls. decreasing evenly across. BO Loosely.

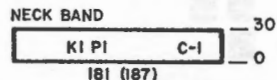

NECK BAND:

K1/P1 Rib: With Col. 1, Cast on 181 (187) sts. Knit 30 rows. Transfer Rib sts. to MB. Knit 1 row across and remove on W.Y.

FINISHING:

See General Instructions. Join neck band to neck opening. Start on center of Back so seam is center back.

PAT. 1

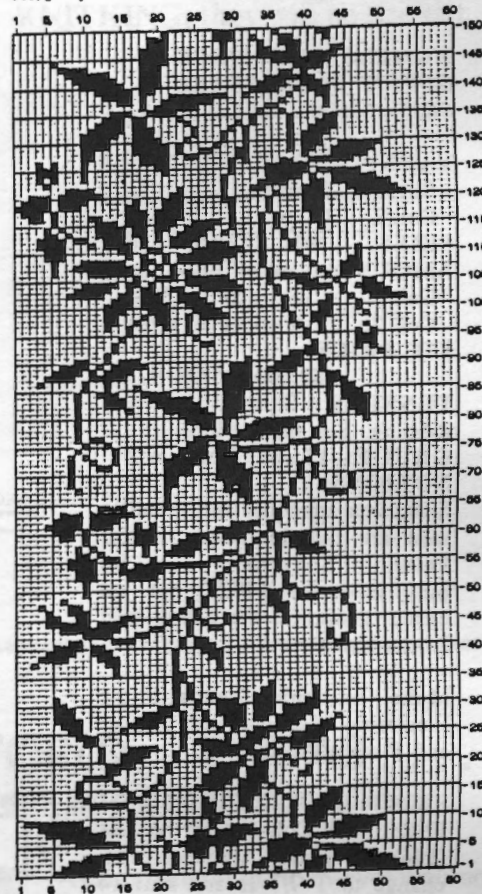

PAT. 1

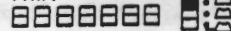

LACE PATTERN PAT. 2



PAT. 2



657



**WOMENS TWO PIECE
OUTFIT WITH SNAKE-
SKIN TRIM**

YARN:

Col. 1: Venetia
Col. 2: Glace

SIZES: 8/10 (12/14) [16]

AMOUNT:

Col. 1: 28 29 30 oz.
Col. 2: 2 cones all sizes

KIT PRICE:

\$95.00 96.00 97.00

TENSION: St. st T 10

Ribbing, See instructions

GAUGE: 13 sts. 18 rows = 2"

NOTIONS:

Snakeskin appliques and metallic trim are not included in Kit Price. Snakeskin can be purchased for \$40.00 but we cannot guarantee the colors will be the same.

Make on any Standard or Electronic Machine with Ribber and Plating Attachment.

SKIRT:

FNR: With Col. 1, Cast on 138 (146) [154] sts. After selvedge, change to T 7/7 II and knit 14 rows. Transfer Rib sts. to MB. Set Main Carriage for Plating (add attachment) and with 1 strand of Col. 2 in Main Feeder, and 1 strand of Col. 1 in Plating Feeder, continue in Plating Method to R 234 (244) [254]. Remove on contrast W.Y.

SKIRT WAIST BAND:

Bring 124 (132) [140] ndls. to WP. With Purl side facing, hang open sts. of skirt onto these ndls. decreasing evenly across. With 1 strand Col. 1, T5, knit 36 rows. Pick up first row to form hem and BO Loosely.

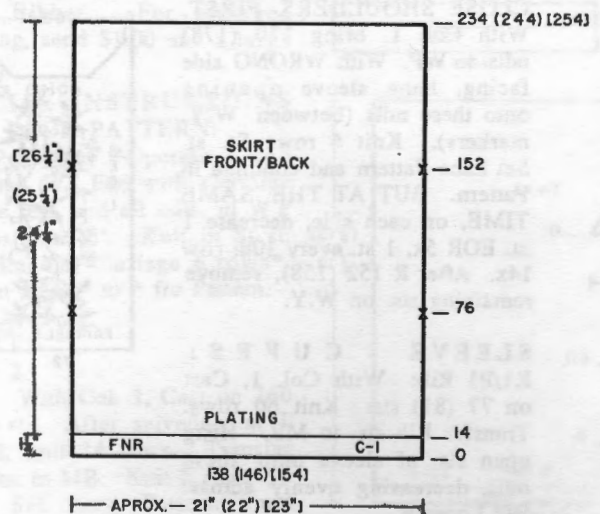
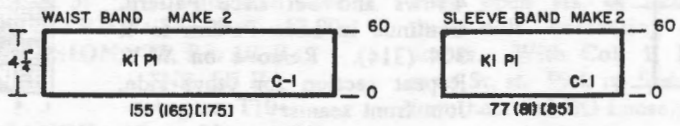
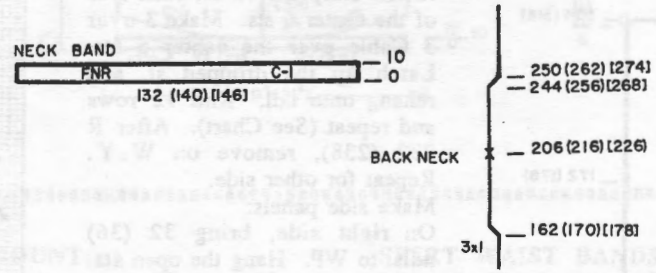
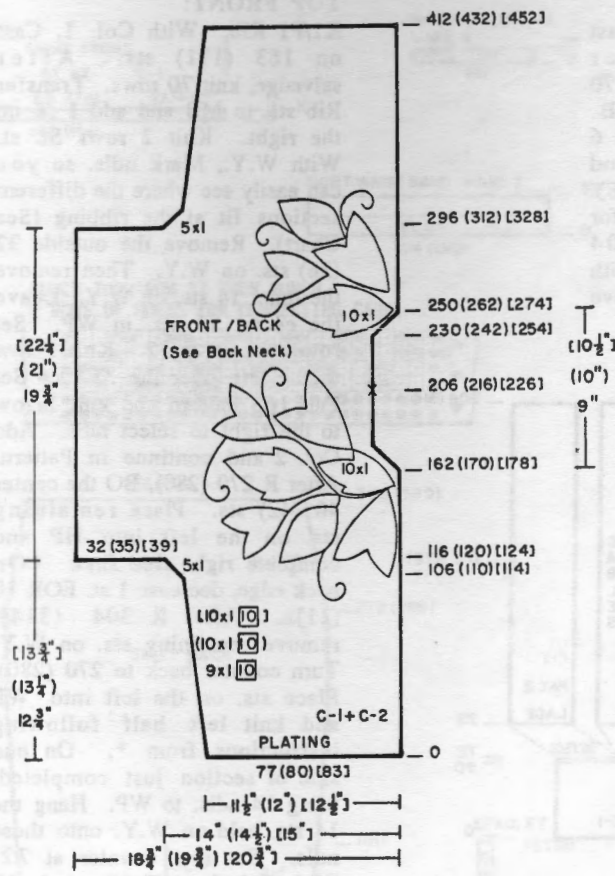
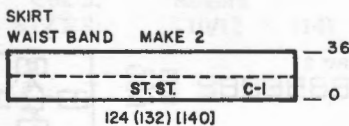

TOP FRONT:

To the right of 0, W.Y. Cast on 77 (80) [83] sts. After several rows, end with 1 row Ravel Cord to the right. Change to Plating Method with Col. 1 and Col. 2. On the left, increase 1 st. every 10th row 9 (10) [10]x. After R 106 (110) [114], on the left, increase 1 st. EOR 5x. After R 116 (120) [124], ON THE LEFT Cast on 32 (35) [39] sts (Refer to KNITTING NEWS this issue on how to cast on large number of sts).

After R 162 (170) [178], on Neck edge, decrease 1 st. EOR 10x. After R 230 (242) [254], increase 1 st. EOR 10x. After R 295 (311) [327], ON THE LEFT, BO 32 (35) [39] sts. THEN BEGIN TO DECREASE ON LEFT SIDE, 1 st. EOR 5x, 1 st. every 10th row 9 (10) [10]x. After R 412 (432) [452], remove on W.Y.

TOP BACK:

All in Plating Method. Same as front to R 162 (170) [178]. On Neck edge, decrease 1 st. EOR 3x. After R 244 (256) [268], increase 1 st. EOR 3x. Balance same as front.

NECK BAND:

CLOSE 1 SHOULDER FIRST. FNR: With Col. 1, Cast on 134 (140) [146] sts. After selvedge, change to T 6/6 II and knit 10 rows. Transfer Rib sts. to MB. With wrong side facing, hang Neck opening onto these ndls. and BO Loosely. CLOSE 2ND SHOULDER.

SLEEVE BANDS:

K1/P1 Rib: With Col. 1, Cast on 77 (81) [85] sts. After selvedge, change to T 1/1 II and knit 60 rows. Transfer Rib sts. to MB. With wrong side facing, hang open sts. of sleeve onto these ndls. decreasing evenly across. BO Loosely.

TOP WAIST BANDS:

K1/P1 Rib: With Col. 1, Cast on 155 (165) [175] sts. After selvedge, change to T 1/1 II and knit 60 rows. Transfer Rib sts. to MB. With wrong side facing, hang Front/Back onto these ndls. BO Loosely.

FINISHING:

See General Instructions. Place, then sew appliques with a sewing machine using a small Zig-Zag stitch. With tapestry needle and glitter yarn, work a chain st. for stems (See picture).

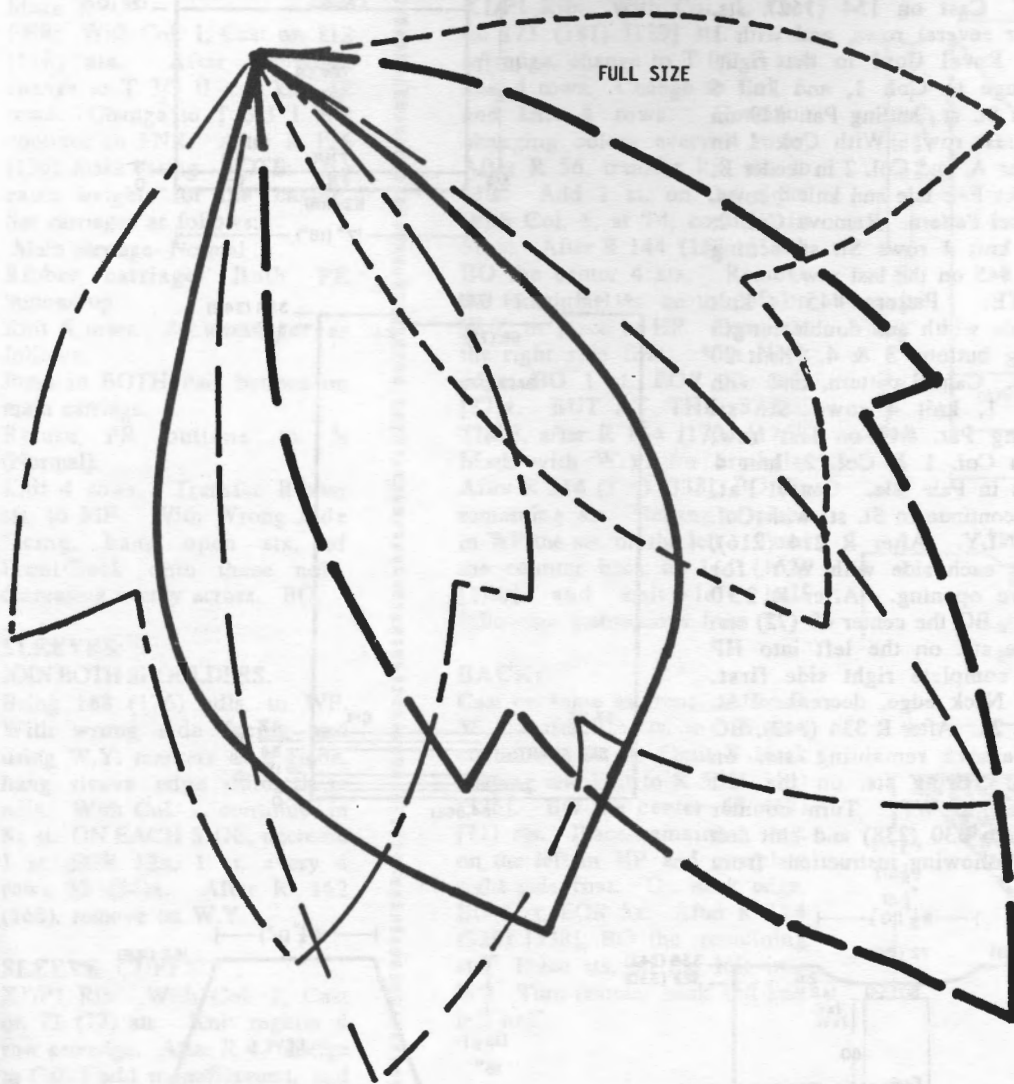

Snakeskin applique (superimposed to save space). If you cut your own snakeskin, cut the shapes as shown. If you order the skins from **KNITKING**, they will be pre-cut.

- 3 of
- 1 of
- 2 of
- 3 of
- 2 of

FDD19

**FLOPPY DISK DRIVE
FOR COMPUKNIT III**



The Floppy Disk Drive makes pattern work unbelievably easy. There are many programmed Disks available, including one for pattern stitch designs from each edition of **KNITKING MAGAZINE**.

Invest in a Floppy Disk Drive today and start your own pattern stitch Disk collection.

STITCH WORLD EXTRAS Pattern Stitch Book and Programmed Disk



A complete new and marvelous (very contemporary) assortment of 63 Pattern Stitches for the COMPUKNIT III. Fair Isle, Single Motifs, Thread Lace, Regular and Fine Lace, Skip Stitch, Tuck Stitch, and Garter Stitch. Up to 200 stitches wide. Pattern number 667 in this issue is one of the excellent pattern stitch designs illustrated in the Book and programmed onto the Disk.

• • • •

Order from your local **KNITKING DEALER** or direct from **KNITKING** at 1128 Crenshaw Blvd., Los Angeles, CA 90019.



WOMENS DRESS

YARN:

Col. 1: Pearlyte
Col. 2: Isabella

SIZES: 8/10 (12/14)

AMOUNT:

Col. 1: 22 24 oz.
Col. 2: 3 balls all sizes

KIT PRICE: \$38.00 40.00

TENSION: St. st & Fair Isle T4

Rib: FNR for skirt 3/3 I
Hem 3/3 II

GAUGE:

St. st. Fair Isle & bodice-15 sts.
21.5 rows = 2"

FNR for dress skirt-13 sts. 19.5
rows = 2"

NOTIONS: 1/4" elastic for
skirt casing

Make on any Electronic Machine
with Ribber. **COMPUKNIT III**
owners use Pat. #22, #45, #49
from book. Pat. 22 is a Single
Motif up the center.

CHART

FAIR ISLE P 49 C-1+C-2	4R	42
ST ST C-1	4R	38
PAT. 45 DBL. W & L.		
	20R	
FAIR ISLE C-1+C-2	14	
ST ST C-1	4R	10
FAIR ISLE P 49 C-1+C-2	4R	6
ST ST C-1	6R	0

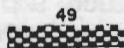

49



45

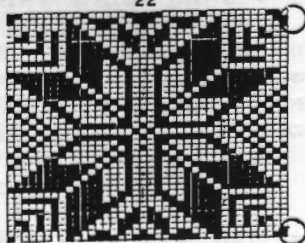

PUSH BACK CIRCLED NEEDLES

BACK:

W.Y. Cast on 154 (162) sts.
After several rows, end with 1
row Ravel Cord to the right.
Change to Col. 1, and knit 6
rows St. st., setting Pat. #49 on
the last row. With Col. 1 in
feeder A, and Col. 2 in feeder B,
set for Fair Isle and knit 4 rows.
Cancel Pattern. Remove Col. 2,
and knit 4 rows St. st. setting
Pat. #45 on the last row.

NOTE: Pattern #45 is knit
double width and double length
using buttons 3 & 4. Knit 20
rows. Cancel pattern, and with
Col. 1, knit 4 rows St. st.
setting Pat. #49 on last row.
With Col. 1 & Col. 2, knit 4
rows in Fair Isle. Cancel Pat.
and continue in St. st. with Col.
1 ONLY. After R 214 (216),
mark each side with W.Y. for
sleeve opening. After R 330
(338), BO the center 68 (72) sts.
Place sts. on the left into HP
and complete right side first.
*On Neck edge, decrease 1 st.
EOR 2x. After R 334 (342), BO
or remove remaining sts. on
W.Y. Bring sts. on the left
back into WP. Turn counter
back to 330 (338) and knit left
half following instructions from
*.

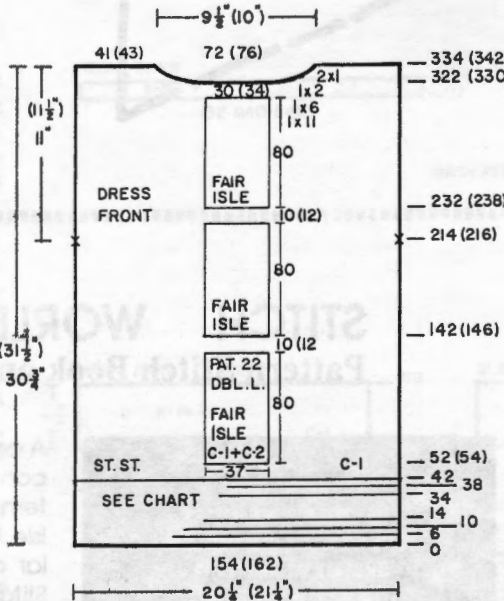
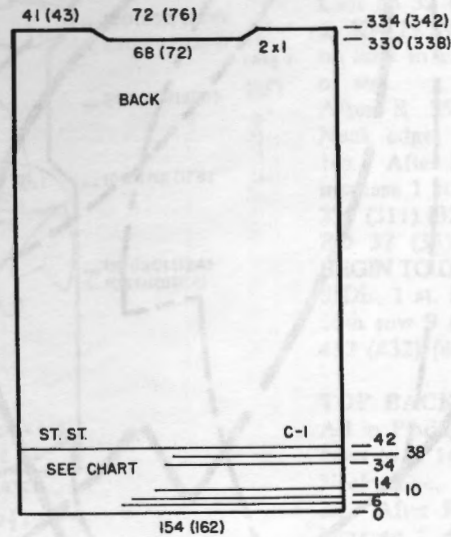
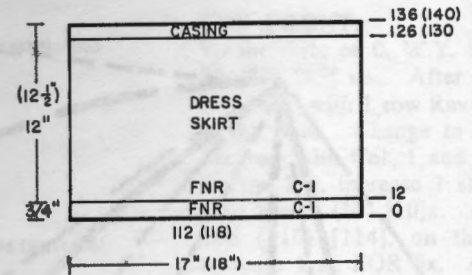

FRONT:

W.Y. Cast on 154 (162) sts. and
knit same as back to R 51 (53).
With carriage on the left, set
Single Motif Pattern in double
length. CompuKnit III owners
use Pat. 22, 1 motif in the first
motif, Selector 2, KC 2. With a
marking pen, mark the needle
bed. Mark ndl. #18 to the left
of 0, and ndl. # 19 to the right
of 0 (NOTE: Ndl. selected on
the right hand side that are
beyond ndl. #19 must be
MANUALLY pushed back to 'B'
postion). With Col. 1 and Col.
2, knit 80 rows. Cancel pattern.

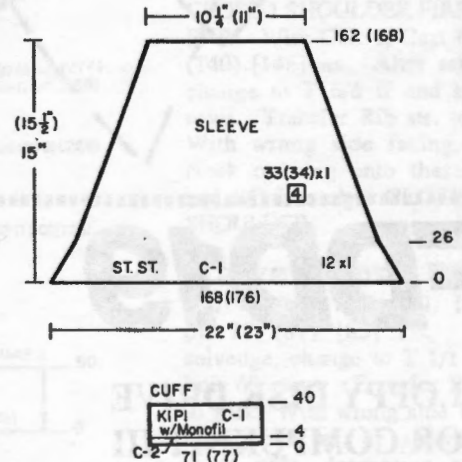

With Col. 1, knit 9 (11) rows
St. st. Set Pat. same as before
and knit 80 rows. BUT AT THE
SAME TIME, AFTER R 214
(216) mark for sleeve opening.
Cancel Pat., knit 9 (11) rows St.
st. Set Pat. and again knit 80
rows Fair Isle. Knit to R 322
(330). BO the center 30 (34)
sts. Place ndls. on the left into
HP and complete the right side
first. *On Neck edge, BO 11
sts. 1x, 6 sts. 1x, 2 sts. 1x, 1
st. EOR 2x. After R 334 (342),
BO or remove the remaining sts.
on W.Y. Bring sts. on the left
back into WP. Turn counter
back to 322 (330) and knit left
half following instructions from
*.

SKIRT:

Make 2.
 FNR: With Col. 1, Cast on 112 (118) sts. After selvedge, change to T 3/3 II and knit 12 rows. Change to T 3/3 I and continue in FNR. After R 126 (130), make casing. NOTE: Use extra weights for the casing. Set carriages as follows:

Main carriage- Normal
 Ribber carriage- Both PR buttons up
 Knit 6 rows. Set carriages as follows:
 Press in BOTH Part buttons on main carriage.
 Return PR buttons to N (Normal).

Knit 4 rows. Transfer Ribber sts. to MB. With Wrong side facing, hang open sts. of Front/Back onto these ndls. decreasing evenly across. BO.

SLEEVES:

JOIN BOTH SHOULDERS.

Bring 168 (176) ndls. to WP. With wrong side facing and using W.Y. markers as a guide, hang sleeve edge onto these ndls. With Col. 1, continue in St. st. ON EACH SIDE, decrease 1 st. EOR 12x, 1 st. every 4 rows 33 (34)x. After R 162 (168), remove on W.Y.

SLEEVE CUFFS:

K1/P1 Rib: With Col. 2, Cast on 71 (77) sts. Knit regular 4 row selvedge. After R 4, change to Col. 1 add monofilament, and at T 0/0 II knit to R 40. With wrong side facing, hang open sts. of sleeve onto these ndls. decreasing evenly across. BO.

FINISHING:

See General Instructions. With Col. 2, crochet 1 row single crochet around neck opening.

FRONT:

K1/P1 Rib: With Col. 1, Cast on 173 (181) [189] sts. After selvedge, change to T 0/0 II and knit 4 rows. Change to Col. 2, and knit 4 rows. Continue changing colors every 4 rows. After R 56, transfer Rib sts. to MB. Add 1 st. on the right. With Col. 1, at T4, continue in St. st. After R 144 (152) [160], BO the center 4 sts. Remove the remaining sts. on the left on W.Y. or place in HP. Complete the right side first. *On Neck edge, BO 1 st. EOR 81 (84) [87]x. BUT AT THE SAME TIME, after R 164 (170) [176], Mark with W.Y. for armhole. After R 314 (326) [338], BO the remaining sts. Rehang or place in WP the sts. on the left. Turn the counter back to 144 (152) [160] and knit left half following instructions from *.

BACK:

Cast on same as front. After R 56, transfer Rib sts. to MB and continue in St. st. Omit V Neck shaping and knit to R 302 (314) [326]. BO the center 63 (67) [71] sts. Place remaining sts. on the left in HP and complete right side first. On neck edge, BO 1 st. EOR 5x. After R 314 (326) [338], BO the remaining sts. Place sts. on the left into WP. Turn counter back and knit left half.

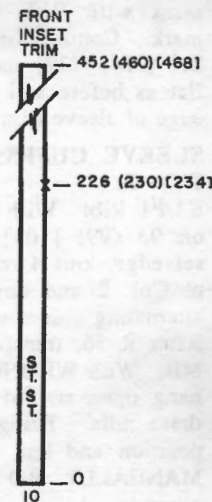
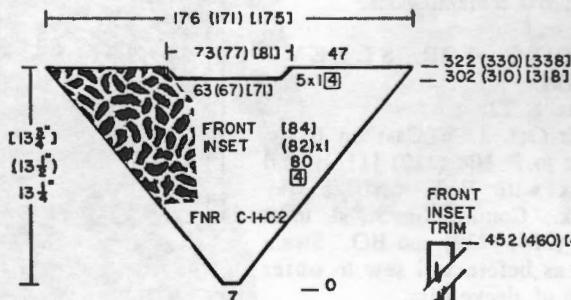
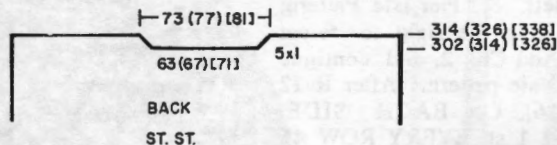
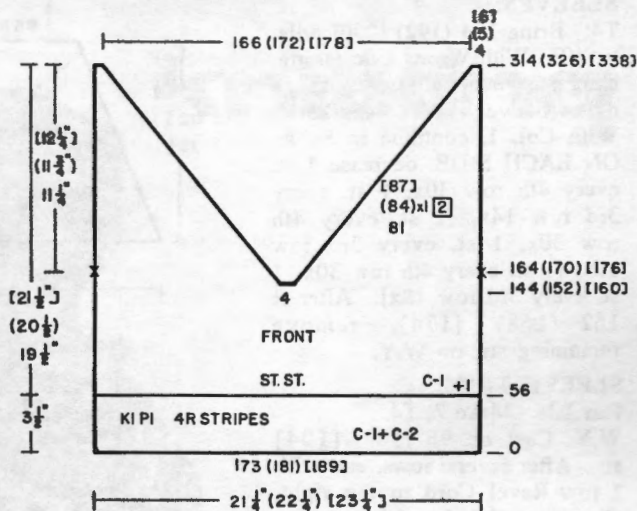

FRONT INSET:

Make 1, T 5/5 lili. Set machine for "Standard Method of knitting Fair Isle Designs with no floats on Back" (See KNITKING NEWS this issue for technique).

FNR: With Col. 1, Cast on 7 sts. After selvedge, set Fair Isle pattern alternating Col. 1 and Col. 2 for Pattern. BUT AT THE SAME TIME, on each side increase 1 st. every 4th row 80 (82) [84]x. After R 302 (310) [318], transfer the center 63 (67) [71] sts. to the MB and BO. MARK YOUR PLACE IN THE PATTERN OR USE M KEY (Be sure to place both MB and Ribber Carriage to HP). Bring the remaining ndls. on the right into HP and complete the left side first. *On Neck edge, BO 1 st. every 4th row 5x. After R 322 (330) [338], BO the remaining sts. Place the ndls. on the right back into the hooks of the ndls. Turn counter back to 302 (310) [318]. Return to place in pattern and select the ndls. Knit the right side to match the left following instructions from *.

FRONT INSET TRIM: MAKE 1, T3.

With Col. 2, 'e' cast on 10 sts. Knit 226 (230) [234] rows. Mark with a piece of W.Y. (this will be the center of the V). Continue in St. st. After 452 (460) [468], BO. Steam inset flat. Bring 120 (124) [128] ndls. to WP. With RIGHT side facing, hang side edge of FRONT INSET onto these ndls. With WRONG side facing, hang 1/2 front inset trim onto these ndls. Pick up lower edge to form trim. At T 10+ knit 1 row. BO Loosely. Sew Front Inset to Front. Join Both Shoulders.

WOMENS SWEATER, DICKIE AND SKIRT

YARN: Venetia
 SIZES: 6/8 (10/12) [14]
 AMOUNT:
 Col. 1: 24 26 28 oz.
 Col. 2: 13 15 17 oz.
 KIT PRICE:
 \$55.00 60.00 65.00
 TENSION: St. st. T4
 FNR, 5/5 lili
 GAUGE: St. st.
 16 sts. 26 rows = 2"
 FNR, 16 sts. 48 rows = 2"

Make on any Electronic Machine with 900 Ribber and Ribber Color Changer.

659



SLEEVES:

T4: Bring 184 (192) [200] ndls. to WP. With Wrong side facing, hang sleeve opening onto these ndls. (between W.Y. markers). With Col. 1, continue in St. st. ON EACH SIDE, decrease 1 st. every 4th row 30x, 1 st. every 3rd row 14x, (1 st. every 4th row 30x, 1 st. every 3rd row 16x) [1 st. every 4th row 30x, 1 st. every 3rd row 18x]. After R 162 (168) [174], remove remaining sts. on W.Y.

SLEEVE TRIM:

Fair Isle. Make 2, T4. W.Y. Cast on 96 (100) [104] sts. After several rows, end with 1 row Ravel Cord to the right. Change to Col. 1 and knit 1 row to the left. Set Fair Isle Pattern, and knit to the right to select ndls. Add Col. 2, and continue in Fair Isle pattern. After R 12 (14) [16], ON EACH SIDE, decrease 1 st. EVERY ROW 45 (47) [49]x. After R 58 (62) [66], BO remaining sts.

EDGING FOR SLEEVE TRIM:

Make 1, T3. With Col. 1, 'e' Cast on 6 sts. Knit to R 108 (112) [116], and mark with W.Y. for 1/2 way mark. Continue in St. st. to R 216 (224) [232] and BO. Steam flat as before and sew to outer edge of sleeve trim.

SLEEVE CUFFS:

T 0/0 II. K1/P1 Rib: With Col. 1, Cast on 95 (99) [103] sts. After selvedge, knit 4 rows. Change to Col. 2 and continue Rib, alternating colors every 4 rows. After R 56, transfer Rib sts. to MB. With WRONG side facing, hang open sts. of sleeve onto these ndls. Bring ndls. to 'E' position and knit 1 row across MANUALLY. BO Loosely.

SKIRT:

T4: W.Y. Cast on 158 (166) [174] sts. After several rows, end with 1 row Ravel Cord to the right. Change to Col. 1, and at T6, knit 1 row to the left. Change to T 2.2, and knit to R 14. Change to Col. 2 and knit 4 rows. Change to Col. 1 and knit 4 rows. Pick up first row to form hem. Change to T4, and continue in stripe pattern, alternating colors every 4 rows. AFTER R 90, continue in St. st. with Col. 1. After R 260 (266) [272], ON EACH SIDE, decrease 1 st. every 10 rows 8 (9) [10]x, After R 348 (360) [372], change to T 10 and knit 1 row to the left. Change to T3, and continue to R 380 (392) [404]. Pick up loose row to form hem and BO Loosely.

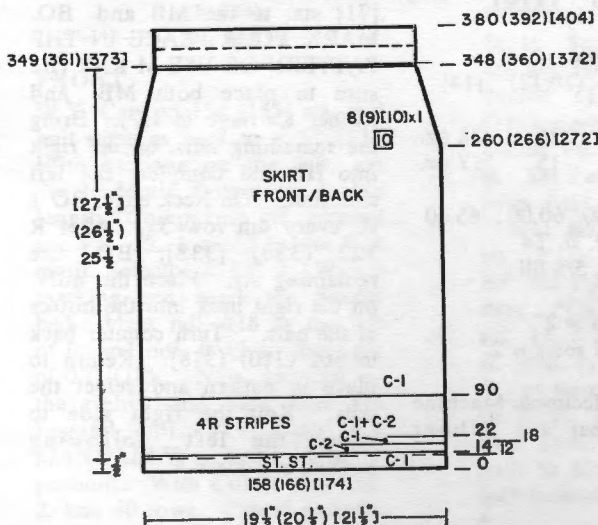
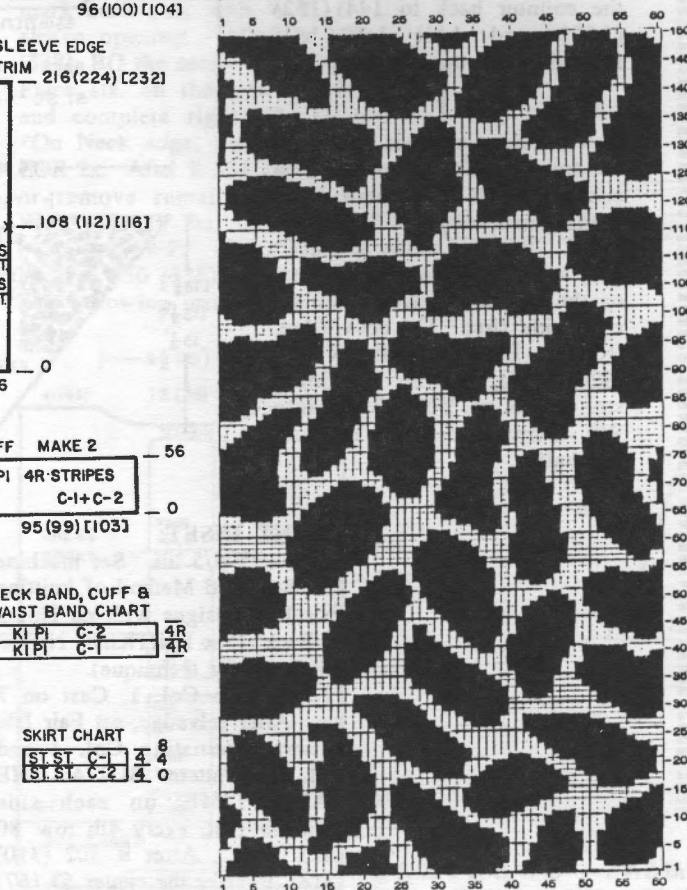
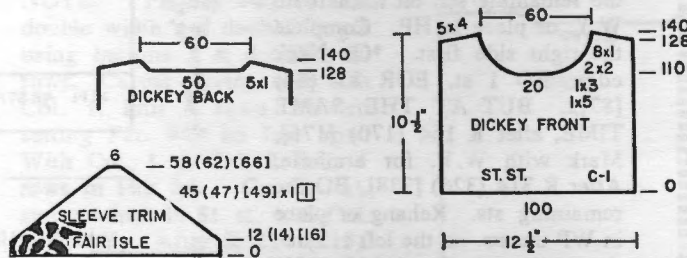
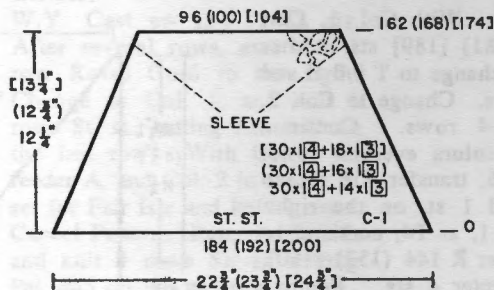

DICKEY FRONT:

T4: With Col. 1, 'e' Cast on 100 sts. Knit in St. st. to R 110. BO the center 20 sts. and place the remaining sts. on the left into HP completing the right side first. *On Neck edge, BO 5 sts. 1x, 3 sts. 1x, 2 sts. 2x, 1 st. 8x. BUT AT THE SAME TIME, after R 128, shape shoulder. BO or use Short Row Method 4 sts. 5x. Bring sts. on the left back into WP. Turn counter back to R 110 and knit left half following instructions from *.

DICKEY BACK:

T4: Same as front to R 128. BO the center 50 sts. and place the remaining sts. on the left into HP. *On Neck edge, decrease 1 st. EOR 5x. BUT AT THE SAME TIME, shape shoulders same as the front. Bring sts. on the left back into WP. Turn counter back to 128, and knit left half following instructions from *.

DICKEY NECKBAND:

CLOSE ONE SHOULDER FIRST. K1/P1 Rib: With Col. 1, Cast on 161 sts. After selvedge, change to T 1/1 II and knit 4 rows. Change to Col. 2 and knit 4 rows. Continue in stripes alternating colors every 4 rows. After R 120, transfer Rib sts. to MB. With wrong side facing, hang neck opening onto these ndls. and BO Loosely.

FINISHING:

See General Instructions. With Col. 2, crochet 1 row single crochet then 1 row, of reverse single crochet around neckline.

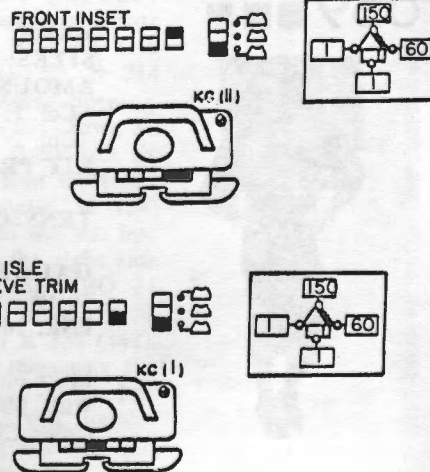
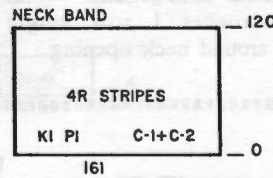

COMPUKKNIT II

knitking

*The Ultimate
Knitting Machine*

*With the amazing
Compuknit III, it is
possible to knit and
wear this lovely outfit
(retail value \$850.00)
in one day, and all it
will cost you is \$66.00.*



knitking

- FDD 19 (at right) is a Micro Disk Drive that plugs directly into the back of a COMPUKNIT III. Each disk is 3.5 inches and has a total of 40 tracks. Each track accommodates 13,600 stitches. The FDD 19 is used for transferring your own pattern stitch designs onto a disk for recall any time you need them. Additionally, pre-programmed disks, holding many beautiful contemporary designs, can be obtained from your local KNITKING dealer or direct from KNITKING.



COMPUKNIT III

INCREDIBLE VERSATILITY PLUS SIMPLICITY OF OPERATION . . .

The 555 designs
KC III. You can p
to suit your own
transfer it to your
tremendously to

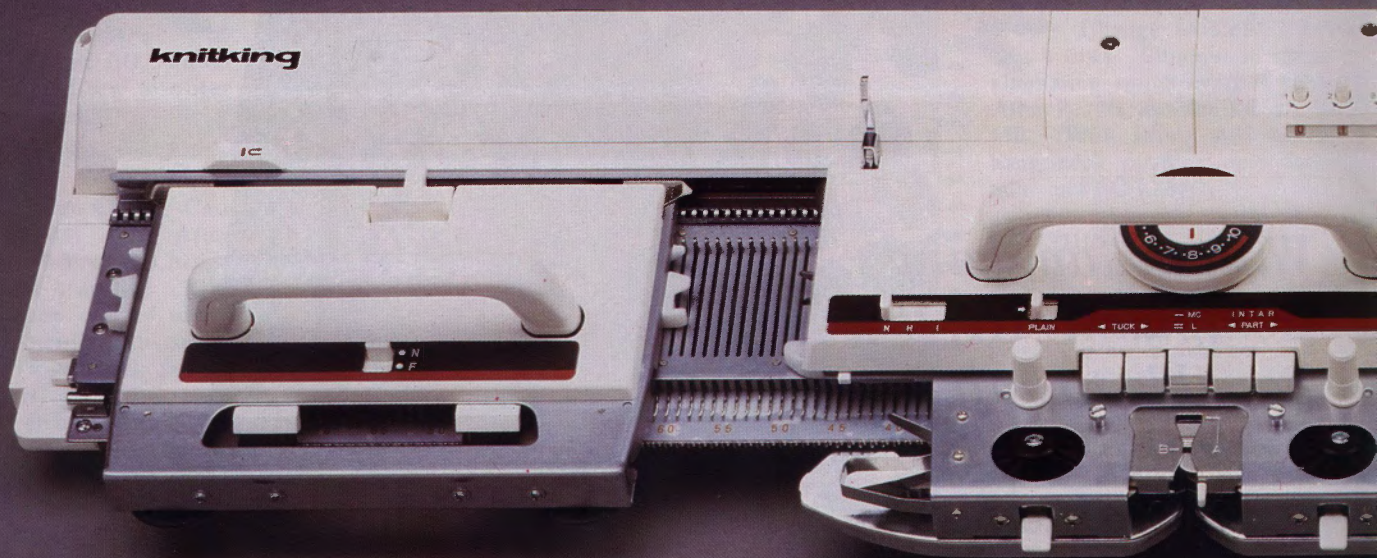

- COMPUKNIT III is shown with Lace Carriage and Main Knitting Carriage. Both carriages are standard with the COMPUKNIT III. The Lace Carriage knits beautiful yarn-over designs, in any pattern combinations, up to the full 200 needle width of the machine. It also (with the flick of a switch) knits Fine Lace and combinations of Regular and Fine Lace. The Computer has 120 lovely Lace designs programmed into it and you can add additional designs.
- The COMPUKNIT III programming panel is shown at the upper right hand side of the machine and the COMPUKNIT III has a total of 555 Pattern Stitch designs permanently programmed into its Computer. A Stitch Pattern Book comes with the machine and it illustrates, in full color, every one of the 555 Pattern Stitches. If, for example, you wish to knit Pattern Stitch 419, you simply push buttons 4-1-9 on the Control Panel. No Mylar Sheets or Punch Cards are necessary with the COMPUKNIT III. You can electronically widen, lengthen, create a mirror image, or reverse-horizontally and vertically-any pattern stitch design. You can also switch the background and foreground colors of Jacquard designs, and you can program a single motif up to 200 stitches wide or isolate a pattern design anywhere you wish on a garment.



- The KC III (illustrated at right below the T.V. screen) is another optional accessory designed specifically for use with the COMPUKNIT III. It is a small masterpiece of computer engineering and is remarkably easy to use. You plug its cord into your color television set and draw your own original designs, in the colors of your choice, on the T.V. screen. The designs transfer directly to your COMPUKNIT III for reproducing in your garment. You can also record your designs in a FDD 19 for permanent retention and recall into your machine whenever needed.

...mmed into the COMPUKNIT III are also programmed into the
 ...them onto your T.V. screen and modify (or combine) them
 ...nd needs. You can also isolate any section of a design and
 ...The KC III is exclusive to the COMPUKNIT III and it adds
 ...atility.

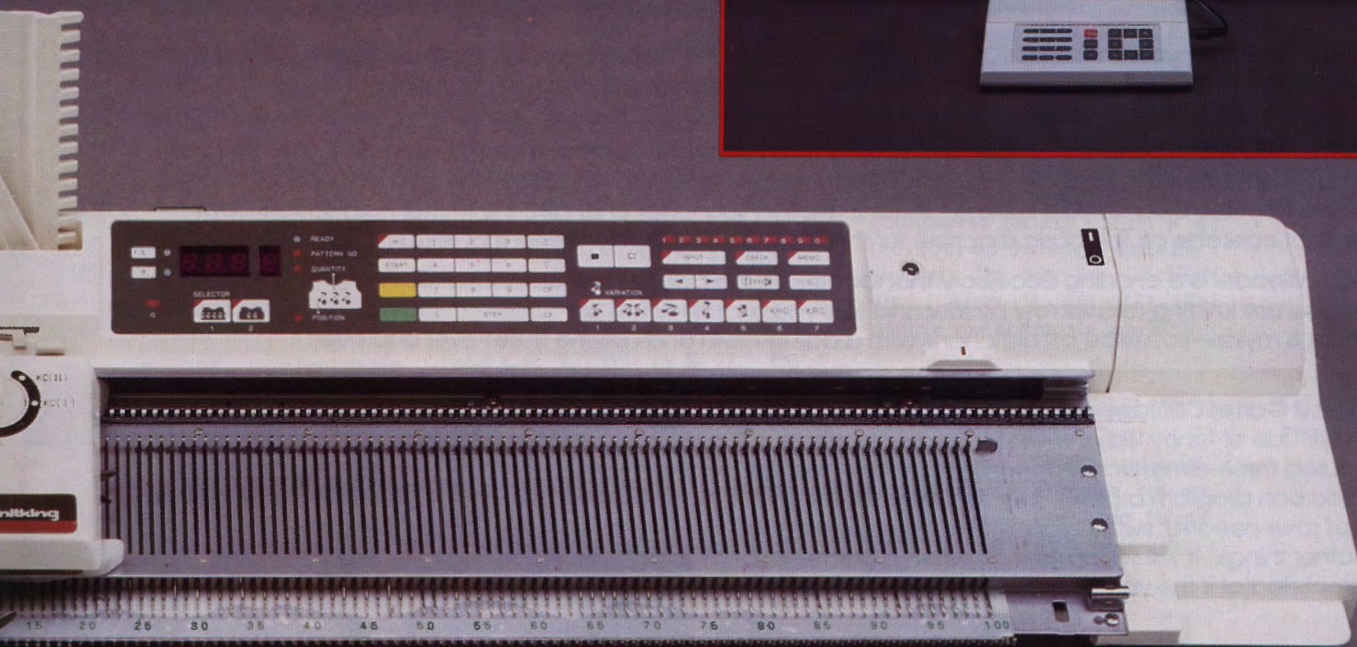

- The COMPUKNIT III knits Punch (Thread) Lace with the main carriage and there are 27 gorgeous Thread Lace patterns programmed into its Computer. The COMPUKNIT III also has hundreds of Fairisle and Jacquard patterns, plus multi-color patterns for children's garments, and multi-color Skip Stitch designs, Weaving designs (yes, it weaves too), Tuck Stitch designs, Garter Stitch designs, all ready and available just by pushing the pattern number of your choice.

- The COMPUKNIT III has a Memory Unit built-in and you can program your own original designs directly into it. The Computer gives you a new number for each of your own designs and you can recall them at any time by pushing the allocated number. The Computer has a memory capacity for your own designs of 13,600 stitches. If you program in a design that is 20 stitches wide and 20 rows long, you use up 400 stitches of memory, or less than 3% of the total memory storage. When your Computer is full, you can delete any of the designs and replace them with new ones or transfer them, for storage, to a Floppy Disk Drive (optional and pictured at the top of this page).

- Intarsia knitting (the reproduction of large pictures in many colors) needs an additional carriage on most machines. That capability is also built into the COMPUKNIT III.

FOR UNLIMITED VERSATILITY

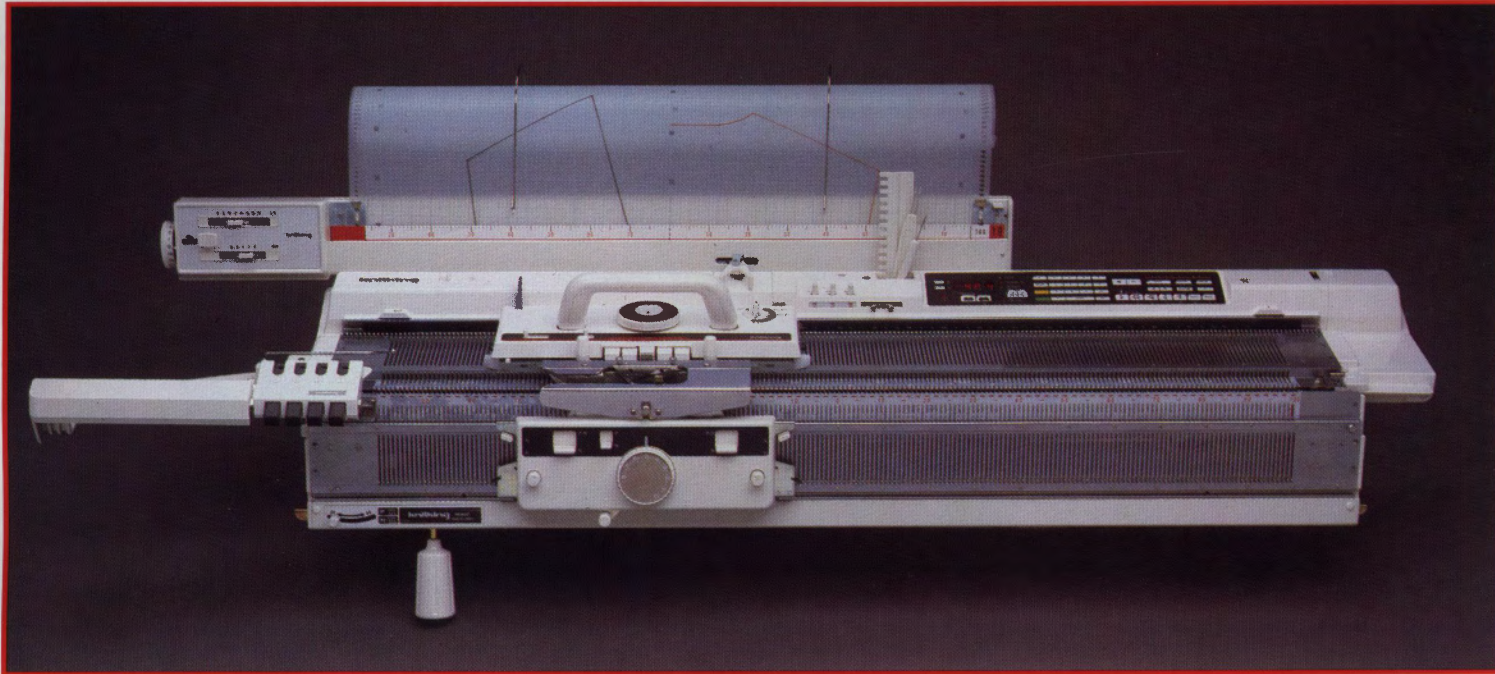

The Compuknit III is shown with the RK 900 Ribbing Attachment, the Ribber Color Changer and the KL 16 Knitleader (all three are optional). The Ribbing Attachment knits any combination of knit and purl rib stitches: 1x1, 2x2, 3x2, etc. It does racking (zig zag) designs, cable stitches, tubular knitting and much, much more.

Add a Ribber Push Button Color Changer and you can knit up to four colors in a design automatically; you can even knit up to four colors in one row. You can introduce various textures of yarn into a garment and eliminate the floats (loops) from the back of your knitting. There is another four color changer, the Knitter Push Button Color Changer, that operates on the basic machine for the knitting of multi-color designs or textures in stockinette stitch.

The KL 16 Knitleader is a charting accessory that locates on the back of the Compuknit III. A full size chart of the garment you are knitting rotates row by row and tells you exactly when and where to increase and decrease. The chart sheet is mylar--you wipe off old charts with a damp cloth and use the sheet over and over.

The Compuknit III Garter Carriage electronically casts on, binds off and knits a multitude of fancy Rib and Garter Stitch patterns--beautiful textured three-dimensional designs impossible to knit any other way. You can program a design in your Compuknit III, set the number of rows needed, switch your garter carriage on and leave to do other things. It will switch itself off when a garment section is completed or if the yarn runs out or breaks.

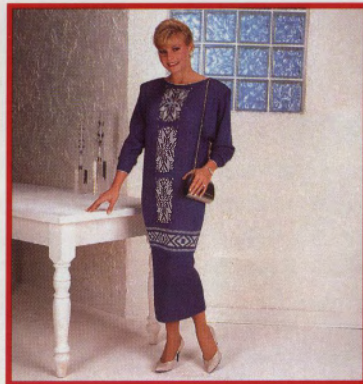
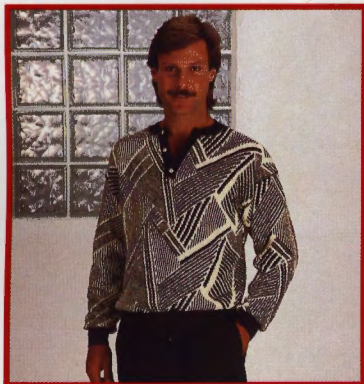

Another exclusive service Knitking provides for its customers is beautiful, full color, quarterly Knitking Magazine. All of its garments are designed and made in our own Knitking Studio. The two garments shown above and the lovely outfit on the front of this brochure are from Knitking Magazine. Knitking is a full service company, and is the oldest and most respected name in the knitting machine industry.

Order from your local Dealer or direct from:
KNITKING CORPORATION 1128 Crenshaw Blvd.
Los Angeles, CA 90019 Telephone: (213) 938-2077



WOMENS CROSSOVER SWEATER

YARN:

- Col. 1: Pearlyte
- Col. 2: Glace
- Col. 3: Venetia
- Col. 4: Angora
- Col. 5: Angora

SIZES: Sm. (Med) [Large]

AMOUNT:

- Col. 1: 16 oz. all sizes
- Col. 2: 1 cone all sizes
- Col. 3: 2 oz. for all sizes
- Col. 4: 1 Ball all sizes
- Col. 5: 1 Ball all sizes

KIT PRICE: \$65.00

TENSION: Plating T8,

Rib: 4.1/4.1 II

GAUGE: 14.5 sts. 19 rows = 2"

Make on any Electronic machine. COMPUKNIT III owners use Pat. 459 from book. Standard Punch Card machine owners may substitute any suitable weaving pattern for the few rows in the sleeves. Main body of sweater is Plating .

BACK:

K1/Pl Rib: With 1 strand Col. 2 & Col. 3 together, Cast on 135 (143) [151] sts. After selvedge, knit 50 rows. Transfer rib sts. to MB and add 1 st. on right. Set carriage for Plating. With Col. 1 in Main Feeder and Col. 2 in Plating Feeder, continue in plating pattern. ON EACH SIDE, increase 1 st. every 18 rows 5x. After R 144 (150) [156], on each side shape armhole. BO 3 sts. EOR 7x. After R 224 (234) [244], shape neck and shoulder at the same time. BO the center 70(74)[78] sts. Place sts. on the left into HP and complete right side first. *On Neck edge, BO 1 st. EOR 2x. On shoulder, BO or use Short Row Method 7 sts. 1x, 8 sts. 1x, (8 sts. 1x, 9 sts. 1x)[9 sts. 1x, 10 sts. 1x]. Bring ndls. on the left back into WP. Turn counter back to 224 (234) [244] and knit the left half following instructions from *.

FRONT:

Make 1, reverse 1.

NOTE: Use Full Fashion Method for decreases on front sections. Move 4th st. to 3rd st., then move end sts. in to fill empty ndl.

W.Y. Cast on 136 (144) [152] sts. After several rows, end with 1 row Ravel Cord to the right. Set for Plating, and with Col. 1 and Col. 2, knit to R 22. On neck edge, BO 1 st. EOR 51x, 1 st. every row 54x (1 st. EOR 55x, 1 st. every row 56x) [1 st. EOR 59x, 1 st. every row 58x]. BUT AT SAME TIME, ON SIDE EDGE, increase 1 st every 18 rows 5x. After R 95 (101) [107] shape armhole, BO 3 st. EOR 7x. After R 174 (184) [194], shape shoulder. BO or use Short Row Method 7 sts. 1x, 8 sts. 1x, (8 sts. 1x, 9 sts. 1x) [9 sts. 1x, 10 sts. 1 x].

SLEEVES:

Make 1, Reverse 1.

W.Y. Cast on 74 (78) [82] sts. After several rows, end with 1 row Ravel Cord to the right. Set for Plating, and with Col. 1 and Col. 2 continue. On the one edge, increase 1 st. EOR 10x, 1 st. every 3rd row 2x. After R 68 (72) [76] remove on W.Y. Turn knitting over. Bring 86 (90) [94] sts. onto these ndls. Place carriage on the left side past the sensor. Set program for weaving. With BOTH part buttons pressed in and no yarn in feeder, turn to KC I and move carriage from left to right to select ndls. Turn counter to 0.

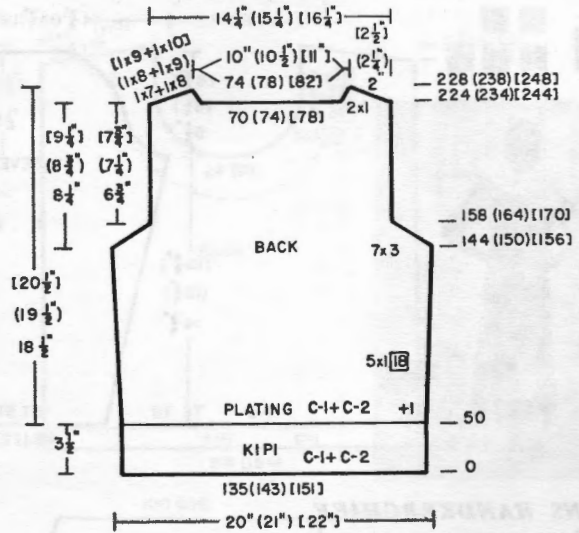

Place Col. 3 in feeder A, and with Col. 4 weave yarn in pattern. After R 10, with Col. 3, knit 6 rows. Add Col. 5 and weave yarn, knit 10 rows. With Col. 3, knit 6 rows St. st. Follow chart through to R 74 and remove on W.Y. Bring 86 (90) [94] ndls. to WP. Reverse section just completed and hang open sts. onto these ndls. Set carriage for plating, turn counter to 0, and with Col. 1 and Col. 2, continue in plating. After R 42 (46) [50] on the edge, decrease 1 st. every 3rd. row 2x, 1 st. EOR 10x. After R 68 (72) [76] remove remaining sts. on W.Y.

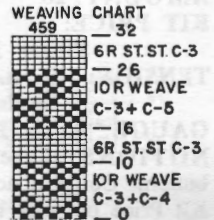

SLEEVE CUFFS:

K1/Pl Rib: With 1 Strand Col. 2 & Col. 3 together, Cast on 73 (79) [85] sts. After selvedge, knit 24 rows. Transfer rib sts. to MB. With Purl side facing, hang sleeve edge onto these ndls. BO Loosely.

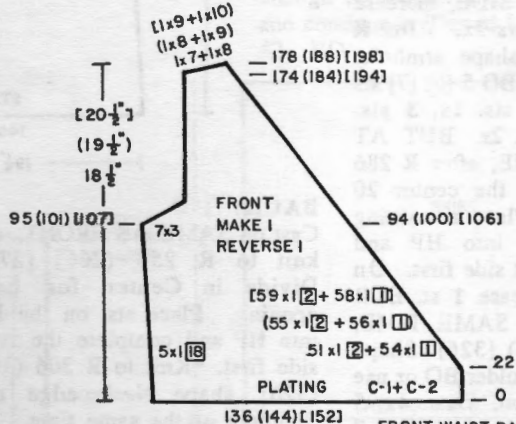
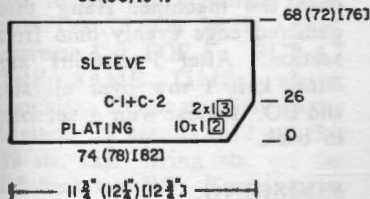
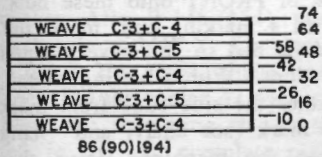
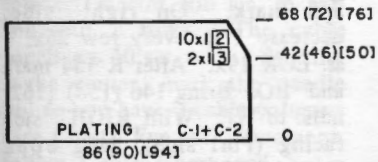
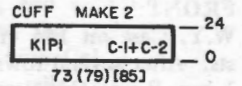

FRONT WAISTBAND:

K1/Pl Rib: With Col. 2 & Col. 3, Cast on 135 (143) [151] sts. After selvedge, knit 50 rows. Transfer rib sts. to MB. With Purl side facing, hang open sts. of left section of Top onto these ndls. Next, hang open sts. of right section onto these ndls. At T 10, knit 1 row over all ndls. BO crochet method.

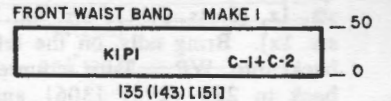

FINISHING:

See General Instructions. Slip stitch crochet across back neck opening.

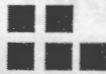

WOMENS HANDKERCHIEF DRESS

YARN: Pearlyte
SIZES: 8/10 (12/14) [16]
AMOUNT: 26 27 28 oz.
KIT PRICE:

\$36.00 37.00 38.00

TENSION: St. st. T4
 Bands T2.2

GAUGE: 15 sts. 22 rows=2"
NOTIONS: Lace collar and 1 button. Collar is not included in Kit Price but can be purchased for \$27.50.

Make on any Standard or Electronic Machine. Stockinette Stitch is used throughout. THE PURL SIDE IS THE RIGHT SIDE.

FRONT:

W.Y. Cast on 146 (154) [162] sts. After several rows, end with 1 row Ravel Cord to the right. Change to garment yarn and continue in St. st. ON EACH SIDE, decrease 1 st. every 20 rows 7x. After row 148 (150) [152], ON EACH SIDE, increase 1 st. every 12 rows 7x. After R 232 (238) [244], shape armhole. ON EACH SIDE, BO 5 (6) [7] sts 1x, 5 sts. 1x, 4 sts. 1x, 3 sts. 1x, 2 sts. 1x, 1 st. 2x. BUT AT THE SAME TIME, after R 286 (296) [306], BO the center 20 (24) [28] sts. Place remaining sts. on the left into HP and complete the right side first. On Neck edge, decrease 1 st. EOR 13x and AT THE SAME TIME, after R 306 (316) [326] Shape Shoulder. On shoulder BO or use Short Row method, 6 sts. 4x, 5 sts. 1x, (6 sts. 5x) [6 sts. 4x, 7 sts. 1x]. Bring ndls. on the left back into WP. Turn counter back to 286 (296) [306] and complete the same as the right side reversing shaping.

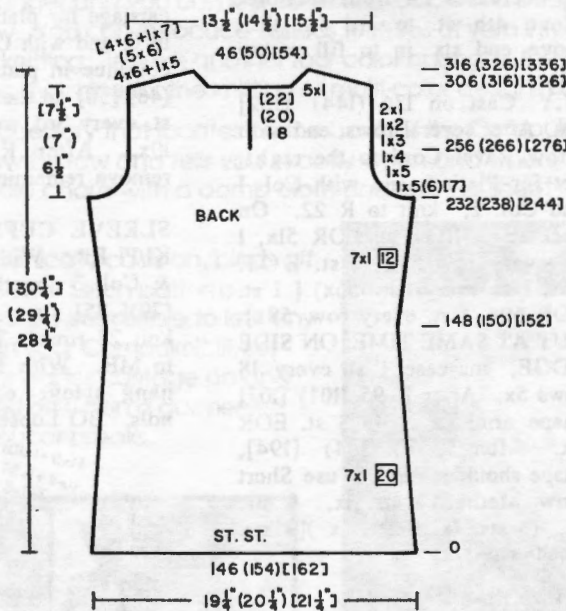
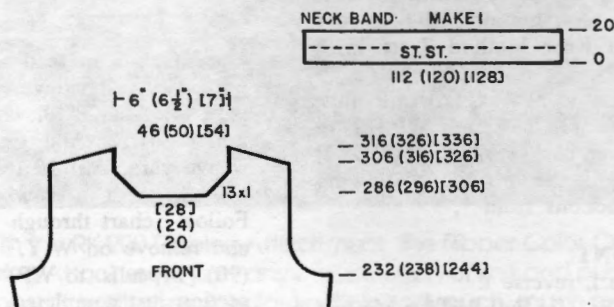
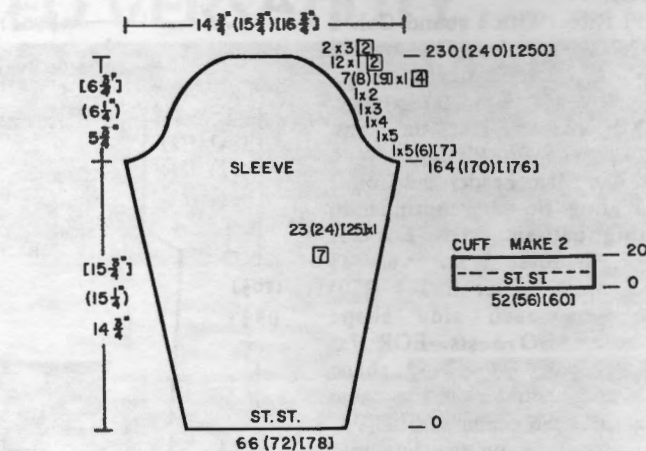

BACK:

Cast on SAME AS FRONT, and knit to R 256 (266) [276]. Divide in Center for back opening. Place sts. on the left into HP and complete the right side first. *Knit to R 306 (316) [326], shape Neck edge and Shoulder at the same time. On Neck edge, BO 18 (20) [22] sts, then decrease 1 st. EOR 5x. Shape shoulder same as front. After R 316 (326) [336], bring ndls. on the left back into WP. Turn Counter back to 256 (266) [276] and complete the left half. Follow instructions from *.

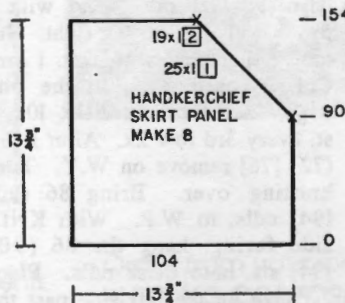

SLEEVES:

W.Y. Cast on 66 (72) [78] sts. After several rows, end with 1 row Ravel Cord to the right. Change to garment yarn and continue in St. st. ON EACH SIDE, increase 1 st. every 7th row 23 (24) [25]x. After R 164 (170) [176], on each side, BO 5 (6) [7] sts 1x, 5 sts. 1x, 4 sts. 1x, 3 sts. 1x, 2 sts. 1x, 1 st. every 4 rows 7 (8) [9]x, 1 st. EOR 12x, 3 sts. EOR 2x. After R 230 (240) [250], BO remaining sts.

SLEEVE CUFFS:

W.Y. Cast on 52 (56) [60] sts. After several rows, end with 1 row Ravel Cord to the right. Change to garment yarn and at T 2.2, knit 20 rows. Pick up first row to from hem. With KNIT side facing, hang open sts. of sleeve onto these ndls. decreasing evenly across. BO.

NECK BAND:

CLOSE BOTH SHOULDERS FIRST.

W.Y. Cast on 112 (120) [128] sts. After several rows, end with 1 row Ravel Cord to the right. Change to garment yarn, and at T 2.2 knit 20 rows. Pick up first row to form hem, and knit 1 row across all sts. With KNIT side facing, and starting at END st. on the right, hang Neck edge (from back slit to center front) onto these ndls. and BO Loosely. Hang the balance of the Neck opening onto the ndls. to the left of center. BO Loosely.

SKIRT PANELS:

Make 8. With garment yarn, "e" Cast on 104 sts. At T4, knit 90 rows and mark. On right side, decrease 1 st. every row 25x, 1 st. EOR 19x. After R 154 mark and BO. Bring 146 (154) [162] ndls. to WP. With RIGHT side facing (Purl side), hang open sts. of FRONT onto these ndls. With a marking pen, mark the needle bed so you have 4 equal sections. With a basting thread, gather the side edge from mark to mark (see chart) and hang onto the machine. Hang this gathered edge evenly onto first section. After 3 sections are done, knit 1 row over all sts. and BO. Repeat with 4 sections in back.

FINISHING:

See General Instructions. Set in sleeve, gathering for puffiness, and join side seams. Crochet 1 row around back neck slit. Crochet loop for back button. Attach optional collar.



WOMENS SKIRT AND BLOUSE

YARN:
 Col. 1: Starlite
 Col. 2: Sewing Thread
SIZES: 16/18 (20/22)
AMOUNT:
 Col. 1: 26 28 oz.
 Col. 2: 4 spools for both
KIT PRICE: \$42.00 44.00
TENSION: Thread Lace and
 St. st, T7 FNR, 3/3 I
GAUGE: 12.5 sts. 21 rows = 2"

Made on the KK 93 Machine but can also be made on the COMPUKNIT III, or any Machine than can knit Thread Lace. Skirt Hem is FNR. Front has rows of cables. Ruffle on back bodice is in Thread Lace. Regular lace trims the back collar ruffle.

FRONT:
 FNR: With Col. 1, Cast on 148 (154) sts. After selvedge, change to T 3/3 I, and knit 14 rows. Transfer Rib sts. to MB and knit 2 rows. The cable panels are 10 sts. wide. Starting at the center, mark the needle bed so you have 7 cable columns (See Chart). For ndl. placement, follow Cable Chart and begin cables. After R 148 (154), mark each side with W.Y. for sleeve. After R 258 (268), shape neck line. BO the center 42 (46) sts. Place the remaining sts. on the left in HP and complete right side first. *On Neck edge, decrease 1 st. EOR 5x. BUT AT THE SAME TIME, shape shoulder. BO or use Short Row Method 12 sts. 4x, (12 sts. 3x, 13 sts. 1x). Bring sts. on the left back into WP. Turn counter back to 258 (268) and knit left half following instructions from *.

BACK:
 FNR: With Col. 1, Cast on 148 (154) sts. After selvedge, change to T 3/3 I and knit 14 rows. Transfer Rib sts. to MB and knit in St. st. After R 148 (154), mark each side with W.Y. for sleeve. After R 194 (200), shape back neckline. BO the center 24 (28) sts. Place the sts. on the left into HP, and complete the right side first. *On Neck edge, BO 1 st. every 3 rows 6x, 1 st. every 4 rows 3x, 1 st. every 8 rows 4x, 1 st. every 10th row 1x. After R 262 (272), shape shoulder same as front. Bring ndls. on the left back into WP. Turn counter back to 194 (200). Return to correct row in pattern. Select ndls. and knit left half following instructions from *.

SLEEVES:
CLOSE BOTH SHOULDERS.
 Bring 146 (152) ndls. to WP. With wrong side facing and using W.Y. markers as a guide, hang the sleeve edge onto these ndls. Pull ndls. to 'E' position and starting at the left side, 'e' Cast on with Col. 1 to the right. Knit 1 row to the left. Set Thread Lace pattern. On each side, decrease 1 st. every 4 rows 23 (24)x. After R 96 (100), remove on W.Y.

SLEEVE CUFFS:
 Bring 56 (62) ndls. to WP, and hang open sts. of sleeve edge onto these ndls. decreasing evenly across. Knit 2 rows. Mark ndl. bed for 3 cable strips. See Chart for needle placement. Knit to R 40. End cables and knit 1 row very loose. Knit 11 rows St. st. with regular tension. After R 52, pick up first row knit in St. st. and form hem. BO Loosely.

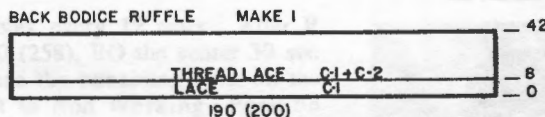
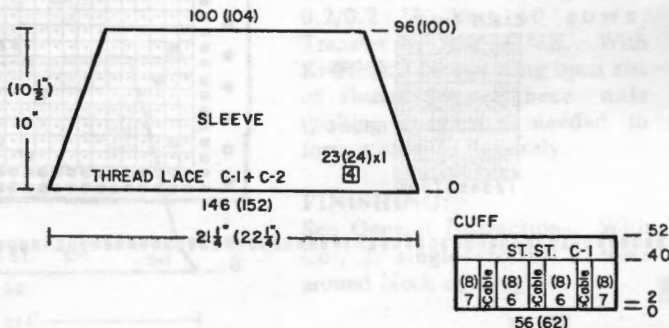
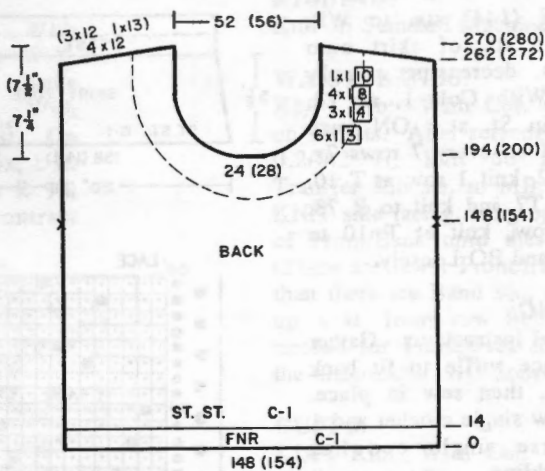

BACK BODICE RUFFLE:
 W.Y. Cast on 190 (200) sts. After several rows, end with 1 row Ravel Cord to the right. From left to right, with Col. 1, 'e' Cast on over these ndls. Knit 2 rows. Set Lace pattern and knit 8 rows (Remember-only rows knit with regular carriage count as rows). After R 8, change to Thread Lace pattern and continue in Thread Lace to R 42. BO.

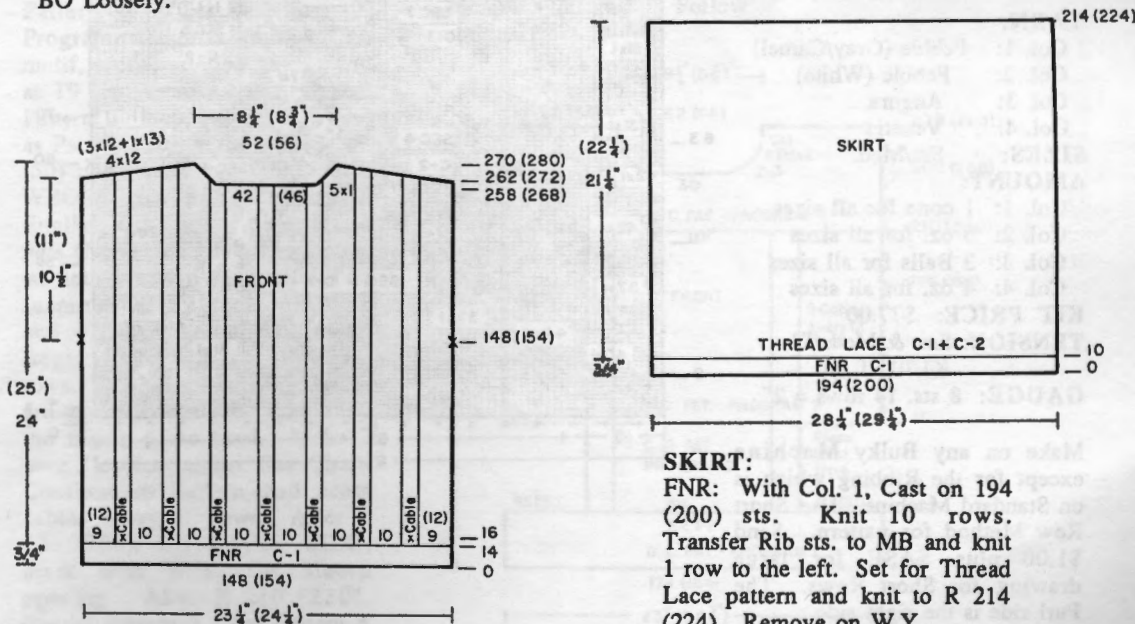

SKIRT:
 FNR: With Col. 1, Cast on 194 (200) sts. Knit 10 rows. Transfer Rib sts. to MB and knit 1 row to the left. Set for Thread Lace pattern and knit to R 214 (224). Remove on W.Y.

SKIRT YOKE :
 Bring 138 (144) sts. to WP.
 Hang open sts. of skirt onto
 these ndls. decreasing evenly
 across. With Col. 1, at T7,
 continue in St. st. ON each
 side, BO 1 st. every 7 rows 7x.
 After R 52, knit 1 row at T 10.
 Return to T7 and knit to R 78.
 Pick up row, knit at T 10 to
 form hem and BO Loosely.

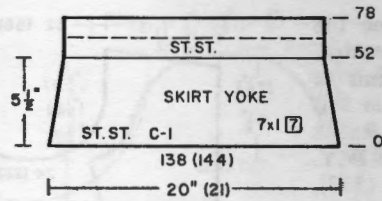

FINISHING:

See General Instructions. Gather Thread Lace ruffle to fit back neck edge, then sew in place. Work 1 row single crochet and 1 row reverse single crochet around neckline.

CABLE CHART

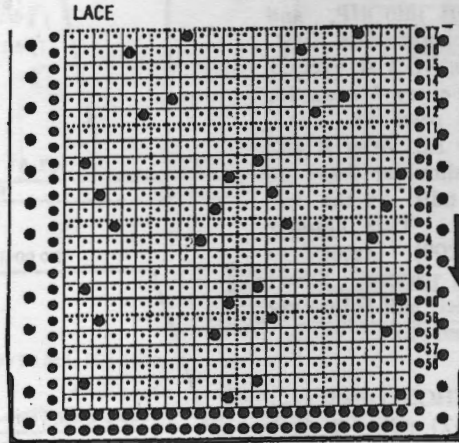
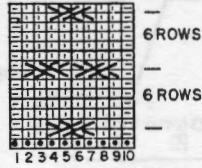

THREAD LACE

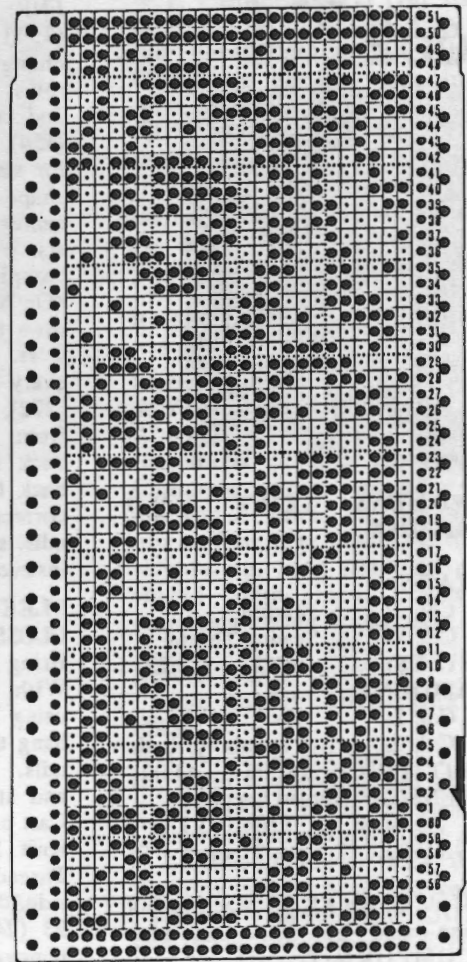

663



WOMENS PULLOVER

YARN:

- Col. 1: Pebble (Grey/Camel)
 - Col. 2: Pebble (White)
 - Col. 3: Angora
 - Col. 4: Venetia
- SIZES:** Sm/Med.

AMOUNT:

- Col. 1: 1 cone for all sizes
- Col. 2: 5 oz. for all sizes
- Col. 3: 3 Balls for all sizes
- Col. 4: 4 oz. for all sizes

KIT PRICE: \$77.00

TENSION: Sm. & Med. T3
 K1/P1, T 0/0

GAUGE: 8 sts. 14 rows = 2"

Make on any Bulky Machine except for the Ribbing which is on Standard Machine. Use Short Row Method for pattern. Send \$1.00 plus SASE for large drawing for Short Rows. The Purl side is the right side.

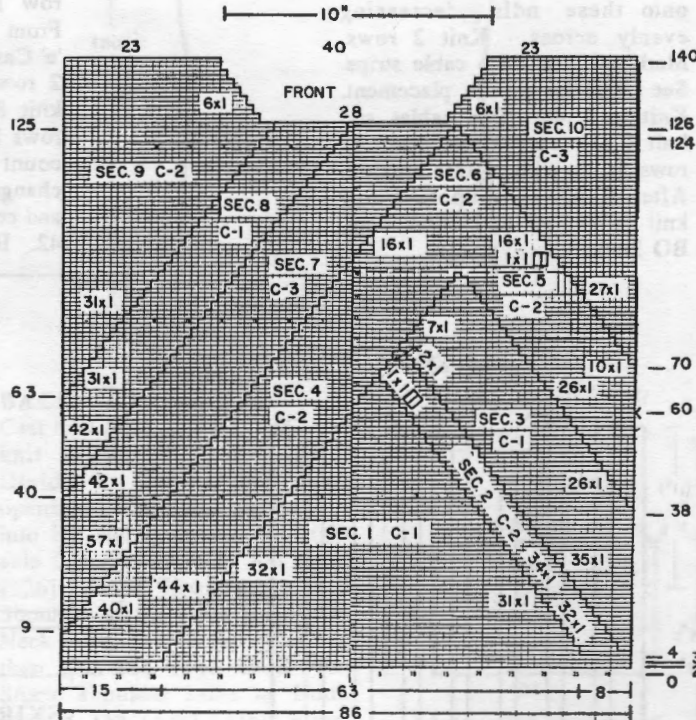

FRONT:

All in Short Row Method.
NOTE: Always do the decrease Short Rows first, then increase Short rows.
 W.Y. Cast on 86 sts. After several rows, end with 1 row Ravel Cord to the right. Change to Col. 1, and knit 2 rows.
 Section 1: Begin Short Rows on the left (opposite carriage). Bring to HP for Holding and knit 1 row to the left. On the right side, bring to HP (E position) 8 ndls. ON LEFT SIDE, bring 1 ndl. to HP EOR 32x. ON RIGHT SIDE, bring 1 ndl. to HP EOR 31x. Complete the sections as shown on the Chart in NUMERICAL ORDER. After R 60, Mark each side with W.Y. for sleeves. After R 126, Shape neck. BO the center 28 sts. and on each side of the neckline, BO 1 st. EOR 6x. After R 140, BO the remaining sts.

BACK:

W.Y. Cast on 86 sts. After several rows, end with 1 row Ravel Cord to the right. Change to Col. 1, and continue in St. st. After R 60, Mark each side with for sleeve opening. After R 140, mark with W.Y. for neck opening. BO or remove each section on contrast W.Y.

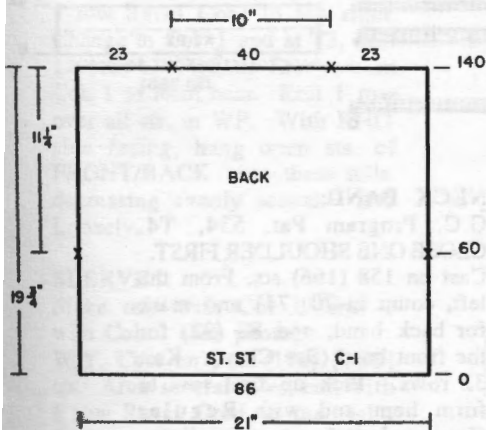

SLEEVES:

Bring to WP 92 ndls. With KNIT side facing, using W.Y. markers as a guide, hang sleeve opening onto these ndls. With Col. 1, continue in St. st. On each side BO 1 st. EOR 5x, 1 st. every 10 rows 8x. After R 92, remove the sts. on contrast W.Y.

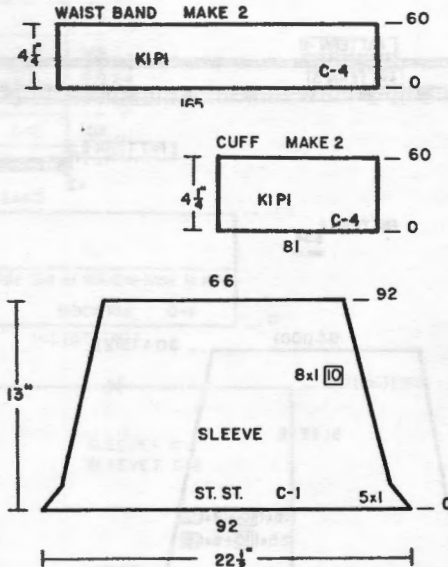

RIBBING:

Knit on Standard Machine.

WAIST BANDS:

K1/P1 Rib: With Col. 4, Cast on 165 sts. After selvedge, at T 0.2/0.2 II, knit 60 rows. Transfer Rib sts. to MB. With KNIT side facing, hang open sts. of Front/Back onto these ndls (There are fewer Front/Back sts. than there are Band sts., so pick up a st. from row below as needed for Front/Back to fill in the difference). BO Loosely.

CUFFS:

K1/P1 Rib: With Col. 4, Cast on 81 sts. After selvedge, at T 0.2/0.2 II, knit 60 rows. Transfer Rib sts. to MB. With KNIT side facing, hang open sts. of sleeve onto these ndls (pulling up yarn as needed to form a st.). BO Loosely.

FINISHING:

See General Instructions. With Col. 2, single crochet 2 rows around Neck opening.

664



MANS SWEATER

YARN: Roma
SIZES: 44/46 (48)
AMOUNT: 38 42 oz.
KIT PRICE: \$50.00 55.00
TENSION: Front-T9

Back-See Instructions
GAUGE: G.C. Pattern
 15 sts. 19.5 rows = 2"
 English Rib-15 sts. 34 rows=2"
NOTE: Entire garment is made using 2 strands of Roma throughout.

Make on COMPUKNIT III using Ribber for English Rib. K2/P2 Rib for Bands are knitted with the Electric Garter Carriage (G.C.). Patterns 2,3,4 have to be INPUT into computer.

ENGLISH RIB INSETS:

K1/P1: Cast on 47 (52) sts. After selvedge, at T 5/5 II, change to English Rib setting and knit 96 rows. Transfer Rib sts. to MB and remove on W.Y. Set aside.

FRONT:

Make with Garter Carriage except for Rib Insets.
 K2/P2: Cast on 174 (184) sts. Set Pattern 1 (534 in Book) and at T4, knit 40 rows. Remove the outside 45 (50) sts. on W.Y. leaving only the center 84 sts. in work. Cancel Pattern 1. Set Pattern 2 (Use Selector 2. Program 2 motifs in the first motif, press variation key 2) and at T9 knit to row 100. Cancel Pattern 2. Set Pattern 3 (same as Pat. 2). Bring the outside 45 (50) ndls. back into WP. With **WRONG SIDE FACING**, hang the English Rib Insets onto these ndls (Note- you have 2 extra sts. so leave 1 on each side for seaming- 45(50) ndls. in work and 47(52) sts. on the Inset). Begin Pattern 3 and knit 12 rows. **MAKE CABLES**. Cables are made over 6 sts., but only the inside 4 are used. Make 2 over 2 cables across. See Chart. Continue in Pattern and cross cables every 12 rows. After R 176 (180), **ON EACH SIDE**, mark with W.Y. for sleeve opening. After R 210 (220), Cancel Pattern 3. Set Pattern 4 (Same as Pat. 2&3). Cross

cables every 12 rows. After R 250 (258), BO the center 30 sts. Place the remaining ndls. on the left to Non Working Position (Note- you must either remove them on W.Y. or knit them manually back to A position. Since we are using the G.C., the ndls. cannot be brought to HP). Note pattern row number. *On Neck edge, BO 3 sts. 2x, 2 sts. 2(3)x, 1 st. 6x. After R 278 (288), BO or remove remaining sts. on W.Y. Bring sts. on the left back into WP. Set to correct pattern row number. Turn counter back to 250 (258) and complete left half. Follow instructions from *.

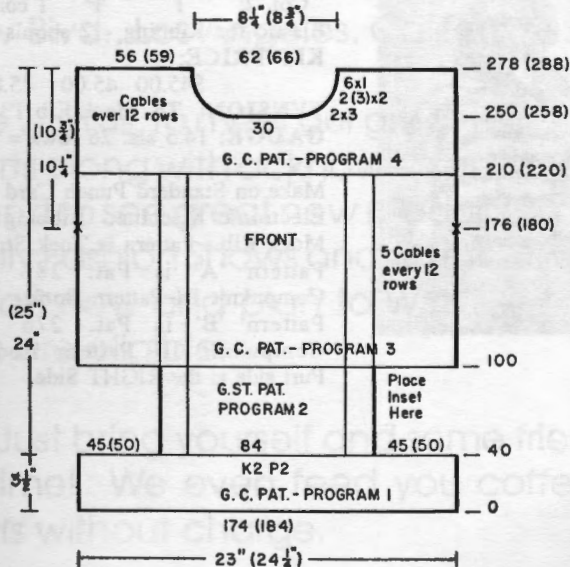
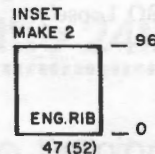

BACK:

Use Regular Carriage. Make a tension swatch to see if stitch gauge is the same as the Front. Ours was not so we knitted the Back at T8.1.

K2/P2: Cast on 174 (184) sts. same as front. Program Pat. 534 and knit 40 rows. Remove G.C. and change to Regular Carriage. Knit in St. st. to R 268 (278). BO the center 54 (58) sts. Place remaining ndls. on the left into HP and complete right side first. *On Neck edge, BO 2 sts. every 4th row 2x. After R 278 (288), BO or remove remaining sts. on W.Y. Bring ndls. on the left back into WP. Turn counter back to 268 (278), and complete left half. Follow instructions from *.

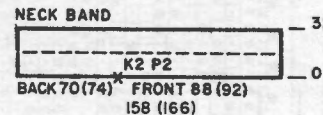
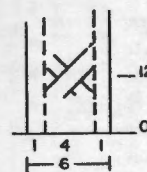
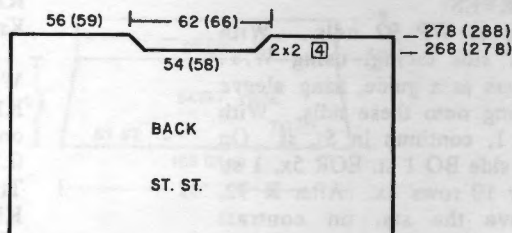

SLEEVES:

English Rib with Ribber. K1/P1: Cast on 157 (165) sts. After selvedge, change Ribber setting to English Rib and at T 5/5 II continue. ON EACH SIDE, decrease 1 st. every 10 rows 25x, 1 st. every 9 rows 6x (1 st. every 10 rows 15x, 1 st. every 9 rows 18x). After R 304 (312), transfer Rib sts. to MB and remove on W.Y.

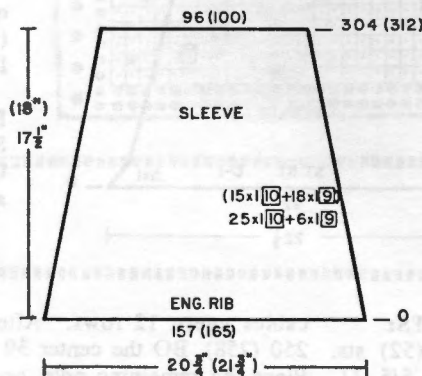

SLEEVE CUFFS:

G.C. Program Pat. 534. Cast on 64 (68) sts. At T4, knit 32 rows. With wrong side facing, hang open sts. of sleeve onto these ndls. decreasing evenly across. BO Loosely.

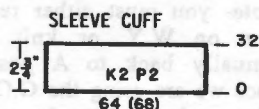

NECK BAND:

G.C. Program Pat. 534, T4. CLOSE ONE SHOULDER FIRST. Cast on 158 (166) sts. From the left, count in 70 (74) and mark for back band, and 88 (92) for the front band (See Chart). Knit 32 rows. Pick up first row to form hem and with Regular Carriage knit 1 row over all sts. With wrong side facing, hang Neck edge onto these ndls. using W.Y. markers as a guide. BO Loosely.

FINISHING:

See General Instructions. Join sleeves to Armhole opening. Join English Rib Insets to body. Close side seams.

665



WOMENS COTTON PULLOVER

YARN: Kotton
SIZES: 6/8 (10/12) [14]
AMOUNT:
 Col. 1: 1 1 1 cone
 Col. 2: 1 1 1 cone
 Elastic for Ribbing - 2 spools
KIT PRICE:
 \$45.00 45.00 45.00
TENSION: T6, Mock Rib T3
GAUGE: 14.5 sts. 26 rows = 2"

Make on Standard Punch Card or Electronic Machine. Ribbing is Mock Rib. Pattern is Tuck St. Pattern 'A' is Pat. 282 in Compuknit III Pattern Book. Pattern 'B' is Pat. 276 in Compuknit III Pattern Book. Purl side is the RIGHT Side.

FRONT/BACK:

The same. W.Y. Cast on 160 (168) [176] sts. After several rows, end with 1 row Ravel Cord to the right. Change to Col. 2, and knit 10 rows St. st. setting Tuck Pat. 'A' on last row. Change to Col. 1, and knit 14 rows. Cancel Tuck Pat. and knit 2 rows St. st., setting Pat. 'B' on 2nd row. Change to Col. 2 and knit 14 rows. Cancel Tuck Pat. 'B' and with Col. 1, knit 10 rows St. st. setting Tuck Pat. 'A' on last row. Change to Col. 2 and knit 14 rows. Cancel Tuck Pattern 'A', and with Col. 1 knit 10 rows St. st., setting Pat. 'B' on last row. Change to Col. 2 and knit 14 rows. Cancel Pat. 'B' and knit 2 rows St. st. setting Pat. 'A' on last row. Change to Col. 1 and knit 14 rows. Cancel Pat. 'A'. Change to Col. 2 and knit 10 rows St. st. setting Pat. 'B' on last row. Change to Col. 1 and knit 14 rows. Repeat pattern (See Chart).

NOTE: Mark for sleeve opening after R 120 (126) [132]. After R 254 (266) [278], BO the center 54 (58) [62] sts. Place the sts. on the left into HP and complete the right side first. If you are in a Tuck st. pattern, mark your place so you can return to it. *On Neck edge, decrease 1 st. EOR 3x. After R 262 (274) [286], BO or remove on W.Y. Bring sts. on the left into WP. Turn counter back to 254 (266) [278]. If you are in pattern, return to the correct place in pattern and knit left half following instructions from *.



WAIST BAND:

MOCK RIB, make 2. Use 1 strand Col. 1 and 1 strand thin elastic together for ribbing. Bring 145 (153) [161] ndls. to WP. With ndl. pusher, push every other ndl. back to 'A' (out of work) position. This is the needle arrangement for Mock Rib (every other ndl. in WP). W.Y. Cast on 145 (153) [161] sts. After several rows, end with 1 row Ravel Cord to the right. Change to Col. 1 and at T3, knit 120 rows. Pick up first row in Col. 1 to form hem. Knit 1 row over all sts. in WP. With KNIT side facing, hang open sts. of FRONT/BACK onto these ndls. decreasing evenly across. BO Loosely.

SLEEVES:

Make one with Col. 1 and 1 with Col. 2 (See photo). W.Y. Cast on 160 (170) [180] sts. After several rows, end with 1 row Ravel Cord to the right. Change to Col. 1 or Col. 2, and knit 1 row to the left. Set Tuck Pat. 'A' and continue in pattern to row 14. Cancel Tuck Pat. 'A' and continue in St. st. With Col. 1 or Col. 2, knit to R 150 (156) [162]. Remove on W.Y.

ST. & COLOR CHART		128
TUCK 'B'	C-1	14R 114
ST. ST.	C-2	10R 104
TUCK 'A'	C-1	14R 90
ST. ST.	C-2	2R 88
TUCK 'B'	C-2	14R 74
ST. ST.	C-1	10R 64
TUCK 'A'	C-2	14R 50
ST. ST.	C-1	10R 40
TUCK 'B'	C-2	14R 26
ST. ST.	C-1	2R 24
TUCK 'A'	C-1	14R 10
ST. ST.	C-2	10R 0

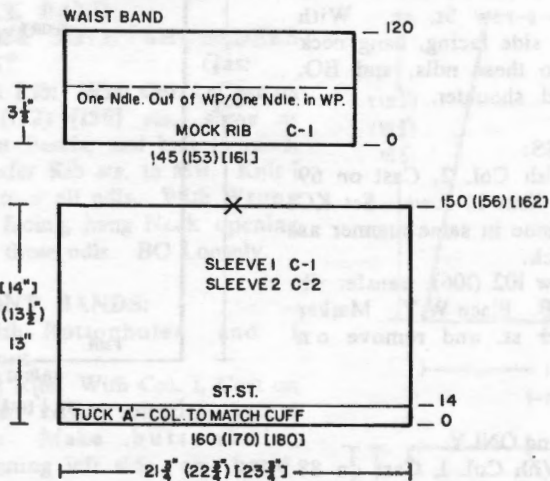
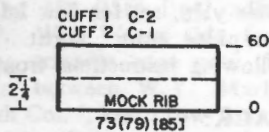

SLEEVE CUFFS:

Make one with Col. 1 and one with Col. 2. Use 1 strand garment yarn and 1 strand elastic together for Mock Rib. Using same needle arrangement as Waist Band, W.Y. Cast on 73 (79) [85] sts. After several rows, end with 1 row Ravel Cord to the right. Change to Col. 1 or Col. 2, plus elastic and knit 60 rows. Pick up first row to form hem, and with knit side facing, hang open sts. of sleeve (Cuff edge) onto these ndls. decreasing evenly across. BO Loosely.

FINISHING:

See General Instructions. **CLOSE BOTH SHOULDERS.** Bring 160 (170) [180] ndls. to WP. With PURL side facing, hang armhole onto these ndls. between W.Y. markers. With KNIT side facing, hang open sts. of sleeve onto these ndls. BO Loosely. Single crochet 1 row around neck opening.

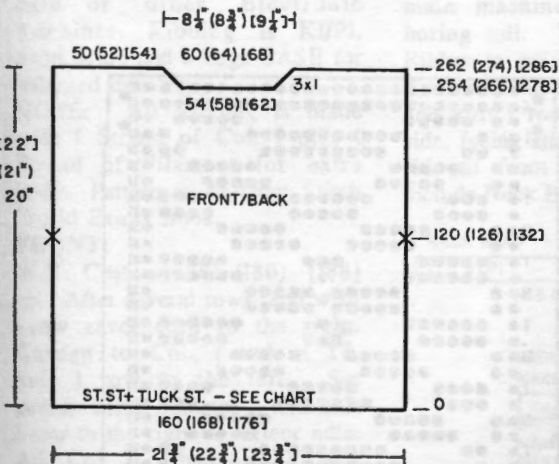

PAT. A PUNCH THRU ROW 33 THEN PUNCH 2 ROWS OF HOLES FOR CONNECTING CARD.

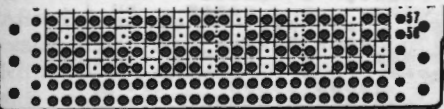

PAT. B PUNCH THRU ROW 41 THEN PUNCH 2 ROWS OF HOLES FOR CONNECTING CARD.

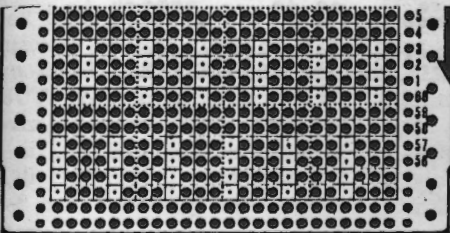

RESERVE THESE DATES . . .

September 19th through the 24th

That's when the Annual Knitkng Seminar and Open House happens . . . It's Exciting, Educational and Great Fun. It's the biggest event of the year at Knitkng and is held at our premises: 1128 Crenshaw Blvd., Los Angeles, California 90019.

Plan to be with us, to meet our great team of knitting experts along with acknowledged great authorities and to see great new products . . . There will be daily Fashion Shows and Contests with big prizes. Start now and plan to Win! All types of garments are eligible.

It's FREE! Just bring yourself and some friends for a good time! We even feed you coffee and doughnuts without charge.

666



TEEN SCENE

TEENAGE BULKY OUTFIT

YARN: Amore
SIZES: 5/7 (9/11)
AMOUNT:
 Col. 1: 9 10 balls
 Col. 2: 7 8 balls
 Col. 3: 2 2 balls
 Col. 4: 4 4 balls
KIT PRICE: \$68.00 73.00
TENSION: FNR T 4/4 I
 Hem 0/0 II.
GAUGE: 8 Sts. 17 Rows. = 2"

Make on Bulky Punch Card Machine with Ribber and Color Changer. Fair Isle Pattern has no floats. Punch Card is #46 from basic KRC package. The top is knit with 2 Strands of Amore together, throughout.

FRONT:

Set Ribber and Color Changer. FNR: With Col. 2, Cast on 76 (80) sts. At T 0/0 II, knit 11 rows. With carriage on the left, set KC and knit 1 row to right to select ndls. Activate Card. Push in Both Part Buttons and set all Ribber controls at normal. Knit 1 row from right to left. Change to Color indicated on Punch Card and knit 2 rows. Continue following color changes on Card for Fair Isle Pattern. After R 100 (104), mark EACH side for sleeve opening. After R 159 (165), transfer the center 11 (14) sts. to the MB and BO. On the right, manually knit sts. on MB and on Ribber back to 'A' position and complete the left side first. Mark pattern row number. *On neck edge, BO 3 sts. 1x, 1 st. every 4th row 4x. After R 182 (190), transfer Rib sts. to MB. Cancel Pat. and remove on W.Y. Bring sts. on the right into WP. Turn Counter back to 159 (165). Return to marked line on Punch Card. Push in BOTH Part Buttons, NO yarn. Take carriage across from right to left

to select ndls. Pick up correct color yarn, set for Fair Isle and complete the right half following instructions from *.

BACK:

Same as Front, but omit neck shaping. After R 182 (190), Mark neck opening with W.Y. and BO or remove each section on separate W.Y.

NECK BAND:

Make 1, Close 1 shoulder. FNR: With Col. 2, Cast on 74 (80) sts. After selvedge, knit 10 rows. Transfer rib sts. to MB and knit 1 row St. st. With WRONG side facing, hang neck edge onto these ndls. and BO. Close 2nd. shoulder.

SLEEVES:

FNR: With Col. 2, Cast on 69 (74) sts. Knit 11 rows. Set KC and continue in same manner as Front/Back. After Row 102 (106), transfer rib sts. to MB. Place W.Y. Marker on center st. and remove on W.Y.

SKIRT:

Use 1 strand ONLY. FNR: With Col. 1, Cast on 88 (94) sts. Set T -0/-0 II and continue in FNR. After R 264 (270), on each side BO 1 st. every 10th row 6x. After R 324 (336), transfer Rib sts. to MB. IMPORTANT: Knit 1 row by hand to avoid breaking yarn. Change to Regular Carriage and at T 0, knit 30 rows. Pick up first row of St. st. to form Hem. BO.

FINISHING:

See General Instructions. Attach sleeves and close side and sleeve seams.

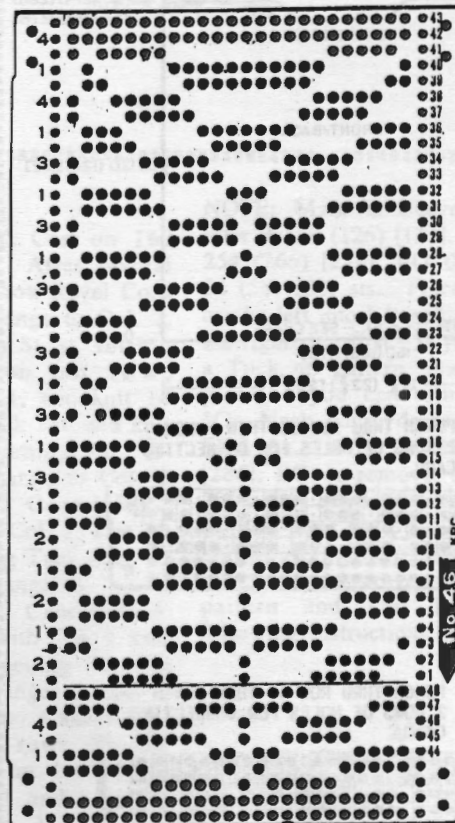
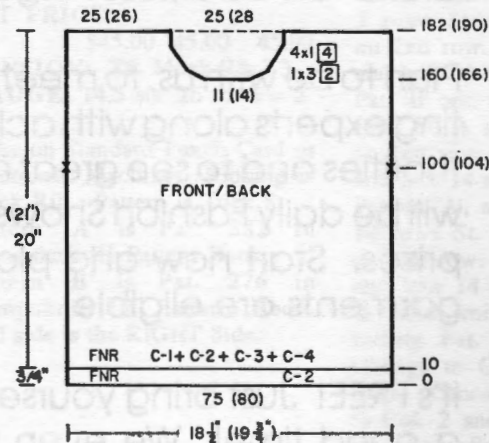
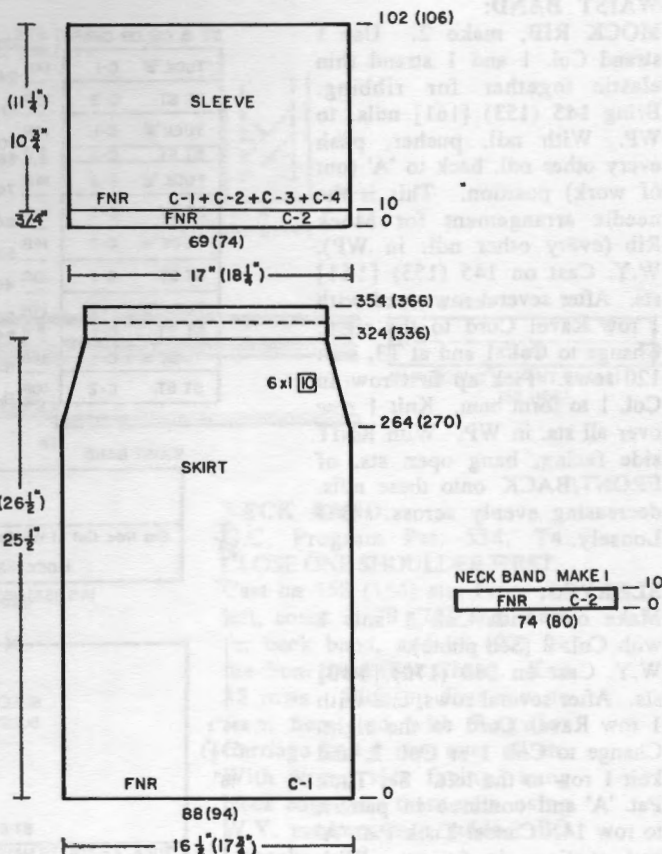

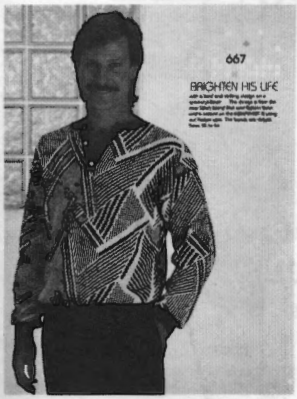

MANS SWEATER

YARN: Kotton
SIZES: 38/40 (42/44) [46]
AMOUNT:
 Col. 1: 16 17 18 oz.
 Col. 2: 9 10 11 oz.
KIT PRICE:
 \$35.00 37.00 39.00
TENSION: Fair Isle T9
 Rib: 1.2/1.2 II
GAUGE: 16 Sts. 17 Rows = 2"
NOTIONS: 3 small buttons.

Make on COMPUKNIT III. Pattern is too large for punch card or other Electronic machines. Ribbing is K1/Pl. Send \$1.00 and a large SASE for enlarged drawing.
NOTE: All Ribbing is made with 1 Strand of Col. 1 plus 1 Strand of Filament for extra body. Pattern is #2 from Stitch World Extras Book.

FRONT:
 W.Y. Cast on 172 (180) [188] sts. After several rows, end with 1 row ravel cord to the right. Change to Col. 1 and at T8, knit 1 row to the left. Set pattern using Selector 1, and knit 1 row to the right to select ndls. Add Col. 2. Change to T9 and continue in Fair Isle Pattern.
 After R 116 (120) [124], mark each side with W.Y. for sleeve. After R 120 (128) [136], BO the center 10 sts. Place ndls. on the left to HP and complete the right side first (Press 'M' for automatic). *Knit to R 166 (174) [182]. On Neck edge, BO 5(6)[7] sts. 1x, 5 sts. 2x, 2 sts. 2x, 1 st. 7(8)[9]x. After R 194 (202) [210], BO or remove remaining sts. on W.Y. Bring ndls. on the left back into WP. Return to place in Pattern (Press 'M' and go across with BOTH PART BUTTONS pressed in and no yarn, to select ndls.). Set for Fair Isle, turn counter back to 120 (128) [136], and knit the left half following instructions from *.

BACK:
 Same as Front, but omit all shaping. After R 194 (202) [210], Mark Neck opening with W.Y. and BO or remove each section on separate W.Y.

WAIST BANDS:
 K1/Pl: With Col. 1, Cast on 151 (159) [167] sts. At T 1.2/1.2 II, knit 42 rows. Transfer Rib sts. to MB. With WRONG side facing, hang open sts. of Front/Back onto these ndls. decreasing evenly across. BO Loosely.

NECK BAND:
 CLOSE BOTH SHOULDERS FIRST.
 K1/Pl Rib: With Col. 1, Cast on 148 (152) [156] sts., same as Waist Bands, and knit 16 rows. Transfer Rib sts. to MB. Knit 1 row over all ndls. With Wrong side facing, hang Neck opening onto these ndls. BO Loosely.

FRONT BANDS:
 1 with Buttonholes and 1 without.
 K1/Pl Rib: With Col. 1, Cast on 59 sts. After selvedge, knit 8 rows. Make buttonhole, beginning left side on band, transfer st. 6, 30, 54 on the main machine to the neighboring ndl. Transfer 1 st. on Ribber to neighboring ndl. Knit 8 rows. Transfer Rib Sts. to MB and knit 1 row. With wrong side, facing attach 1 band to each side of front Slit (Be sure to include Neck Band). BO.

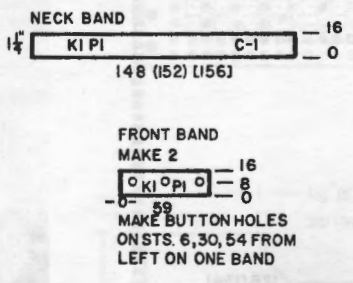

SLEEVES:
 Bring 148 (156) [164] ndls. to WP. With Wrong side facing, hang armhole edge onto these ndls. between W.Y. Markers. With Col. 1, knit 1 row from left to right. Remove yarn and place carriage on the left. Set Fair Isle pattern and with no yarn and BOTH part buttons in, move from left to right to select ndls. Set Counter at 0, and continue in Fair Isle pattern. On each side, decrease 1 st. every 5th row 31 (32) [33]x. After R 158 (162) [166], remove on contrast W.Y.

SLEEVE CUFFS:
 K1/Pl Rib: With Col. 1, Cast on 61 (65) [69] sts. same as before. Knit 40 rows. Transfer rib sts. to MB, and with Wrong side facing hang open sts. of sleeve edge onto these ndls. BO Loosely.

FINISHING:
 See General Instructions.

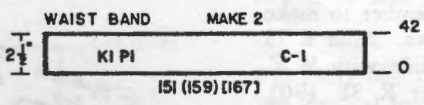
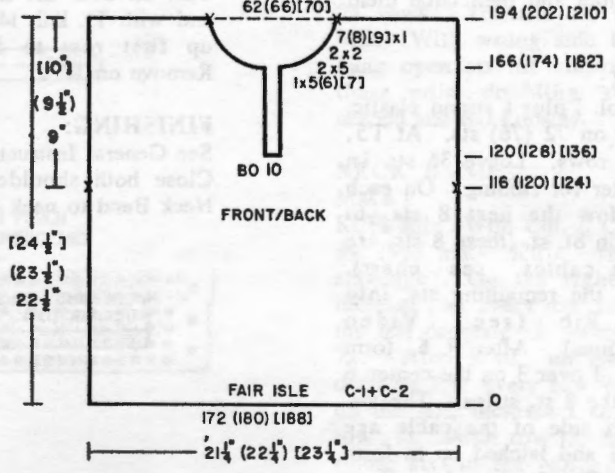
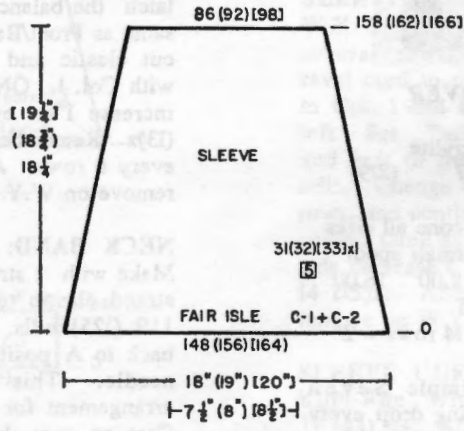
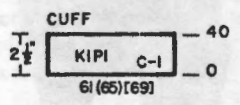

2(3-901) FROM 'STITCH WORLD EXTRAS' PATTERN BOOK/DISK

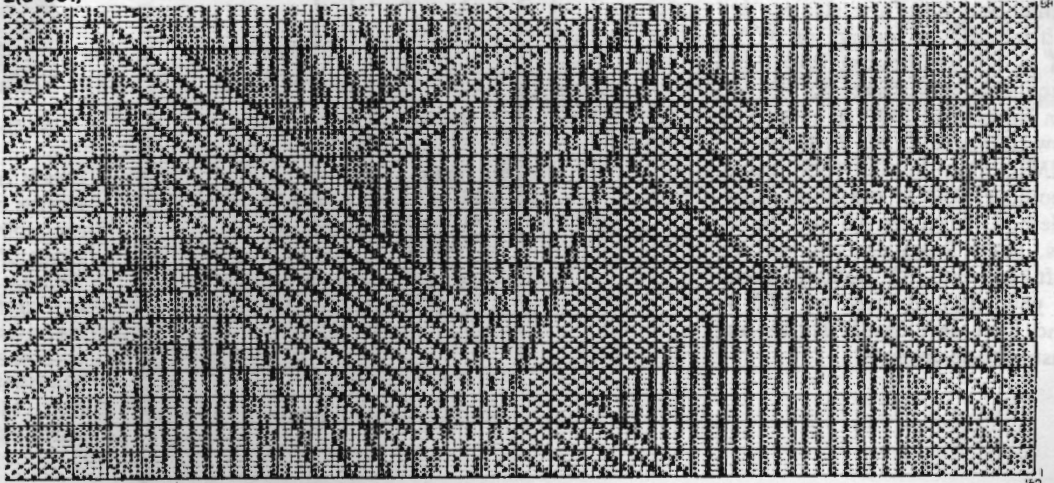

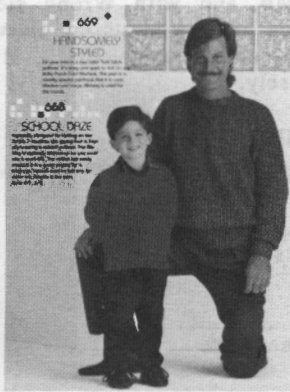

CHILDS PULLOVER

YARN: Acrylite
SIZES: 6/7 (8/9)
AMOUNT:

Col. 1: 1 cone all sizes
Elastic for rib: 1 small spool
KIT PRICE: \$18.00 18.00
TENSION: T 5
GAUGE: 9 sts. 14 rows = 2"

Make on the Simple Seven Machine. For ribbing drop every other stitch and then latch them up.

FRONT:

With Col. 1 plus 1 strand elastic, -e- cast on 72 (76) sts. At T5, knit 24 rows. Leave 36 sts. in the center for ribbing. On each side allow the next 8 sts. to remain in St. st. (these 8 sts. are for the cables, see chart). Reform the remaining sts. into K1/P1 Rib (see Video Instructions). After R 6, form cables - 3 over 3 on the center 6 sts. of the 8 st. strips. The sts. on each side of the cable are dropped and latched up to form knit sts. Cut elastic and continue with Col. 1. Remember to make cables every 6 rows. After R 78 (82), mark each side with W.Y. for sleeve. After R 88 (90), shape V neck. Divide in the center and place the sts. on the left into HP or remove on W.Y. (if in HP set bottom levers on each side of carriage to H). * On Neck edge, BO 1 st. every 3rd row 12(13)x. BUT AT THE SAME TIME, after R 122 (128) shape shoulder. BO or use Short Row Method, 8 sts. 3x (8 sts. 2x, 9 sts. 1x). Bring the sts on the left back into WP (rehang them if you removed them on W.Y.), and knit left half following instructions from *.

BACK:

Same as front to R 122(128). BO the center 18 (20) sts. Place the sts. on the left into HP and complete the right side first. Shape neck and shoulder. AT THE SAME TIME, on Neck edge, BO 1 st. EOR 3x. On shoulder, BO or use Short Row Method 8 sts. 3x (8 sts. 2x, 9 sts. 1x).

SLEEVES:

With Col. 1 plus 1 strand of elastic -e- Cast on 34 (36) sts. Knit 24 rows. Leave the 8 sts. in the center for the cables and latch the balance into K1/P1 rib, same as Front/Back. After R 24, cut elastic and continue only with Col. 1. ON EACH SIDE, increase 1 st. every 6 rows 12 (13)x. Remember to make cables every 6 rows. After R 100 (104) remove on W.Y.

NECK BAND:

Make with 1 strand Col. 1, and 1 strand elastic together. Bring 119 (125) ndls. to WP. Push back to A position every other needle. This is the needle arrangement for Mock Rib. -e- Cast on over the ndls. in WP. and with T1, knit 14 rows. Pick up first row to form hem. Remove on W.Y.

FINISHING:

See General Instructions. Close both shoulders and sew Neck Band to neck opening.

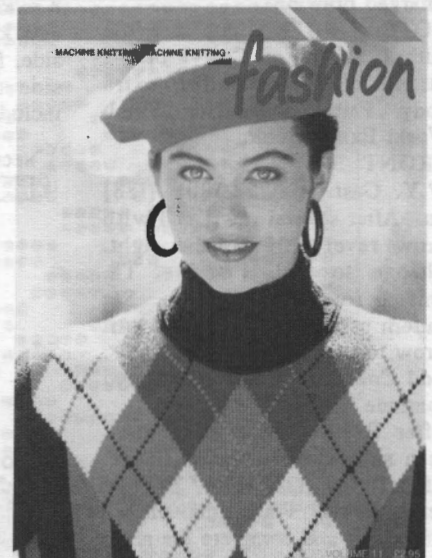
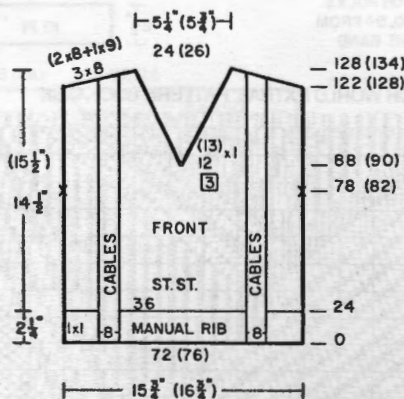
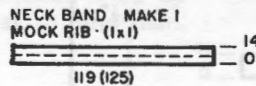
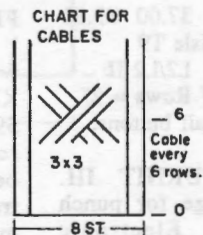
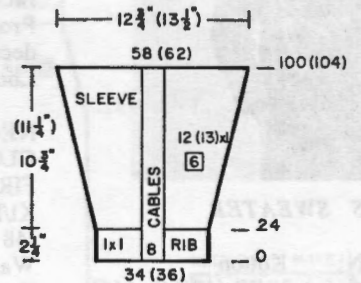
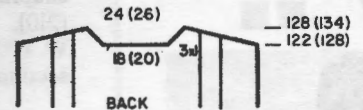

MACHINE KNITTING FASHION - VOLUME II

Here's a chance to see what our European friends are knitting. A great machine knitting magazine in full color, has patterns (34) for all types of machines from simple 8 stitch Genie through Punch Card to Electronics. Expert advice for beginners, special techniques with printed instructions plus schematics. All in multiple sizes. There is an excellent selection of garments for Women, Men, Children and Babies. Many new Punch Card Designs are included as well as pages of Electronic designs.

Price: \$6.95 Postpaid

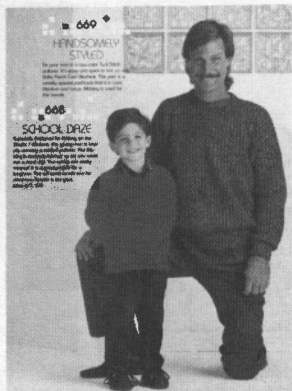

MANS SWEATER

YARN: Novelty Yarn
SIZES: Medium (Large)
AMOUNT:
 Col. 1: Black 20 22 oz.
 Col. 2: Red 14 16 oz.
 Monofil: 1 spool
KIT PRICE: \$40.00 42.00
TENSION: Tuck Pattern T4,
 Rib 0/0 II
GAUGE: 6.5 sts. 18 rows = 2"

Make on Bulky Punch Card machine with Ribber. Pattern is a two color Tuck Stitch Pattern.

NOTE:

Col. 1: Use 2 strands together throughout
 Col. 2: Use 3 strands together throughout
 Ribbing: 2 strands of Col. 1 and 1 strand Monofil.

FRONT:

K1/P1 Rib: With Col. 1, Cast on 78 (82) sts. After selvedge, knit 26 rows. Transfer Rib sts. to MB and with Col. 1, knit 1 row to the left. Set Tuck Stitch pattern and with carriage on KC, knit 1 row to the right to select ndls. Set Carriage for Tuck Stitch (See KNITTING NEWS this issue). *Change to Col. 2 and knit 2 rows. Change to Col. 1 and knit 2 rows*. Repeat from * to * for pattern. After R 148 (150), mark each side with W.Y. for sleeve opening. After R 220 (228) shape neck. BO the center 14 (16) sts. Place sts. on the left into HP and complete right side first. Mark place in pattern on punch card. *On Neck edge, BO 1 st. EOR 5 x, 1 st. every 6 rows 2x. After R 246 (254), BO or remove remaining sts. on W.Y. Bring sts. on the left back into W.P. Turn counter back to 220 (228). Turn to correct line on Punch card. Select ndls. and knit the left half following instructions from *.

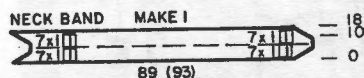
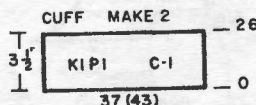
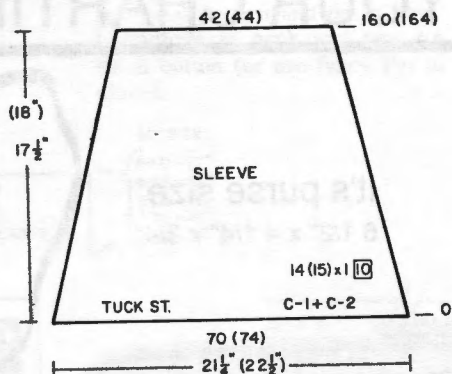
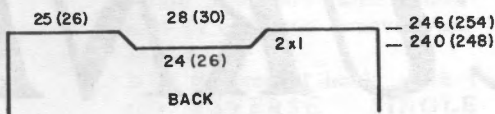

PUNCH THRU ROW 33 THEN PUNCH 2 ROWS OF HOLES FOR CONNECTING CARD.

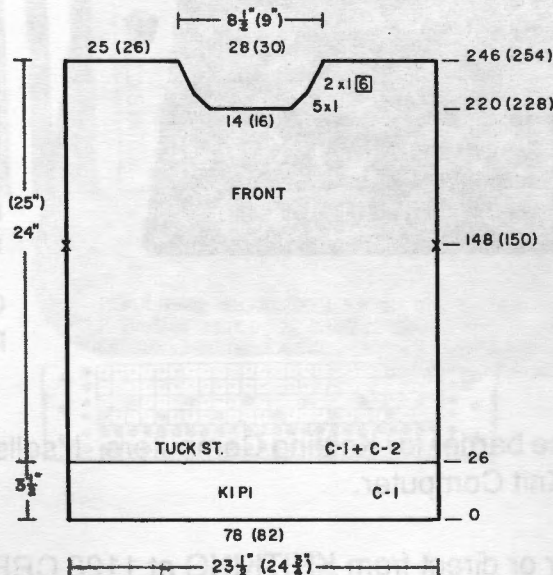
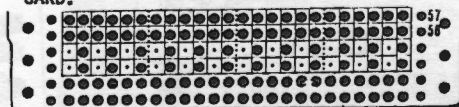

BACK:

Same as front to row 240 (248). BO the center 24 (26) sts. Place the sts. on the left into HP and complete the right side first. Mark place in pattern on punch card. *On Neck edge, BO 1 st. EOR 2x. After R 246 (254), BO or remove the remaining sts. on W.Y. Bring sts. on the left back into WP. Turn counter back to 240 (248), and set correct line on punch card. Complete left half following instructions from *.

SLEEVES:

W.Y. Cast on 70 (74) sts. After several rows, end with 1 row ravel cord to the right. Change to Col. 1 and knit 1 row to the left. Set Tuck Stitch Pattern and knit to the right to select ndls. Change to Col. 2, knit 2 rows, and continue in tuck stitch pattern same as before. On each side decrease 1 st. every 10 rows 14 (15)x. After R 160 (164), remove on W.Y.

SLEEVE CUFFS:

K1/P1 Rib: With Col. 1, Cast on 37 (43) sts. After selvedge, knit 26 rows. Transfer rib sts. to MB. With wrong side facing hang open sts. of sleeve onto these ndls. doubling sts. as needed and BO Loosely.

NECK BAND:

Make 1.
 K1/P1 Rib: With Col. 1, Cast on 89 (93) sts. Knit regular selvedge. On the right side increase 1 st. every row 7x. On the left decrease 1 every row 7x. After R 10, on the right decrease 1 st. every row 7x, and on the left, increase 1 st. every row 7x. After row 18, transfer ribber sts. to the MB. Knit 1 row over sts. and remove on W.Y.

FINISHING:

See General Instructions. Close both shoulders. Sew or weave neck band to neck opening. NOTE: Be sure to have fold over on the neck band exactly in the front (See picture).

CALCUKNIT

by **knit**king

IT SOLVES ALL YOUR CHARTING PROBLEMS

It's purse size
6 1/2" x 4 1/4" x 3/4"

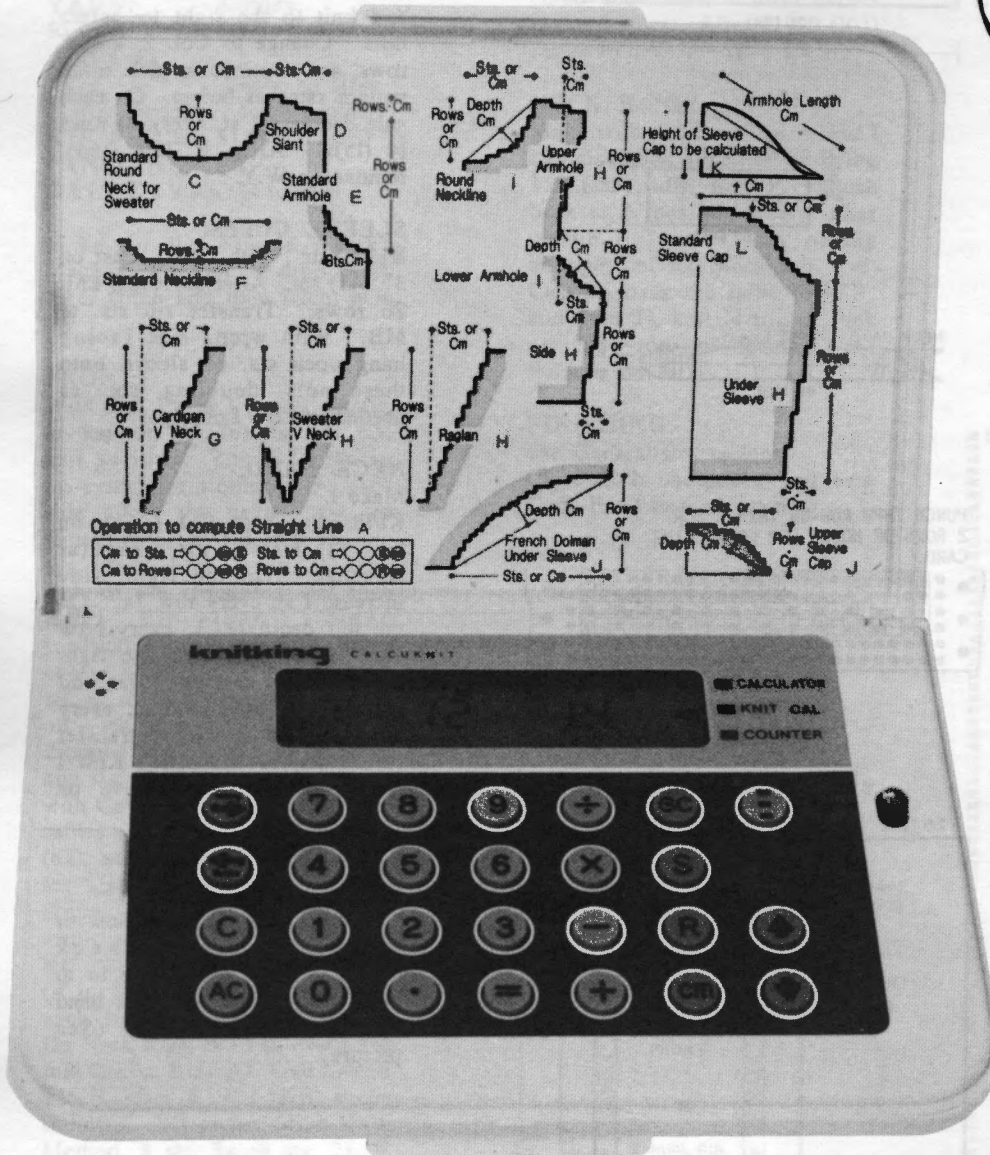

CALCUKNIT takes the time, the tedium, the guesswork and the inaccuracies out of charting both machine and hand knits . . . CALCUKNIT is simple to operate and always accurate.

To chart garments you first make a sample swatch and obtain a correct stitch and row gauge. You then feed them both into the CALCUKNIT . . . Follow by feeding in the garment section measurements . . . The CALCUKNIT then converts your measurements to actual stitches and rows . . . The next step is to feed the garment section by letter (H, for example, is a raglan shape or a V neck). Follow this with the width, in stitches, and the length, in rows, and the CALCUKNIT will give you exact instructions, where to increase, decrease, etc. for your shapings.

CALCUKNIT has three functional settings . . . In the Calculator setting it functions as a standard calculator . . . In the Knit Calculator setting it computes all of your charting . . . In the Counter setting it has a beep alarm: Press a button with each row you knit and the beeper sounds off when you reach the programmed number of rows.

CALCUKNIT operates on two long-life, replaceable lithium batteries.

CALCUKNIT breaks the price barrier for Knitting Computers. It sells for one quarter of the price of our previous low-priced Knit Computer.

Order from your local dealer or direct from KNITTING at 1128 CRENSHAW BLVD., LOS ANGELES, CA 90019. You can order by telephone. Just call 213-938-2077. VISA, MasterCard and American Express are accepted.

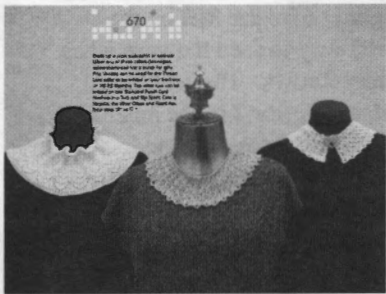

FINISHING:

Steam press into semi circle - hide all ends and remove waste knitting.

With #3 crochet hook, work 1 row REVERSE SINGLE CROCHET (chain 1 between) around outside edge of collar (Not neckline). Insert ribbon through first row of holes made by eyelet pattern and tie in bow. buttonhole at neck and sew on small button (or use fancy Pin to close).

LACY COLLARS

YARN:

- Col. 1: Glace
- Col. 2: Metallic

SIZES: any size neck

AMOUNT:

- Col. 1: 2 oz.
- Col. 2: sm. amount

KIT PRICE: \$6.00

TENSION: T6

A Skip and Tuck Pattern

NOTE: This can also be made with plain Venetia (See Photo).

INSTRUCTIONS:

The following pattern is knit with needles out of work. If you are not using an Electronic machine you must turn the carriage upside down and cancel the end needle selection mechanism (See your manual if any questions). See needle arrangement and set needles accordingly (Refer to KNITTING NEWS this issue on selecting needles for a pattern that has needles out of work).

W.Y. Cast on over the 16 needles in working position. After several rows, change to 1 strand Col. 1, and 1 strand Col. 2 together and 'e' cast on over the waste knitting. Knit 2 rows setting pattern on the 2nd row. *Push in BOTH part buttons and knit 6 rows. Push in BOTH Tuck buttons and knit 6 rows. Repeat from * for pattern.

Knit 296 rows for 13" neck length.

- Knit 332 " " 14" " "
- Knit 368 " " 15" " "
- Knit 404 " " 16" " "
- Knit 440 " " 17" " "

NOTE: Be sure to use plenty of weights, and use your left hand to hold the loop on the right as you knit. Pull down gently to form the attractive loop.

FINISHING:

Steam press and shape neck to size by spreading loop edges out and the neck edge in to form semi circle. Remove waste knitting and single crochet at short ends. Make small loop for

COLLARS

COLLAR WITH RIBBON

YARN:

- Col. 1: Fine Venetia
- Col. 2: Sewing thread

SIZES: any size Neck

AMOUNT:

- Col. 1: 2 - 3 oz.
- Col. 2: 1 spool

KIT PRICE: \$5.50

TENSION: See instructions

GAUGE: Not important

NOTIONS: 1/4" Ribbon about 1 yd.

Make on any Standard Punch Card or Electronic Machine with thread lace capacity.

INSTRUCTIONS:

With W.Y., Cast on 194 sts. After knitting at least 2" of waste knitting, end with 1 row Ravel Cord to the right. Change to Col. 1, and cast on over the waste knitting as follows:

Bring every 2nd needle to 'E' position. LEAVE LONG END OF YARN hanging on the left, then 'e' cast on over the needles in 'E' position and insert yarn in feeder. Push back these needles part way and bring the empty needles to 'E' position and with long strand of yarn 'e' cast on over these needles. Hang a clip on end of yarn. BE SURE TO HAVE WEIGHTS ALL ACROSS THE KNITTING.

At T 9, with Col. 1 and Pat. 1, knit 1 row to the left. Set Thread lace pattern and knit to the right to select ndls. Add thread and set carriage for thread lace. Continue in pattern as follows:

- 10 rows Tension 9
- 10 rows Tension 7
- 8 rows Tension 5
- 8 rows Tension 4

Change to EYELET PATTERN. Set counter to 0. At T 5 knit 2 rows, then begin eyelet lace with Pat. 2. After row 16, BO.

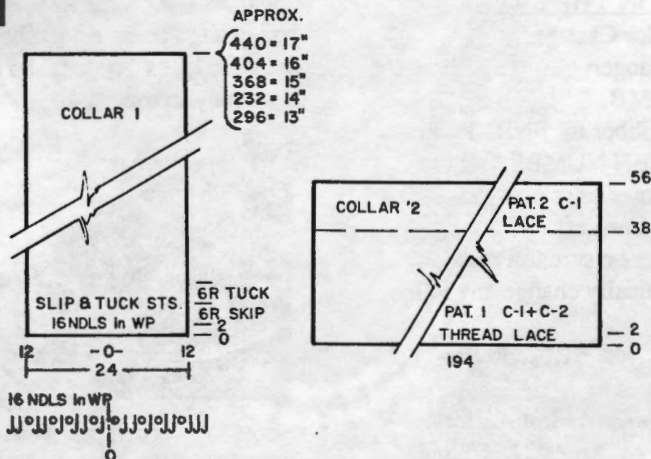

PUNCH THRU ROW 41 THEN PUNCH 2 ROWS OF HOLES FOR CONNECTING CARD.

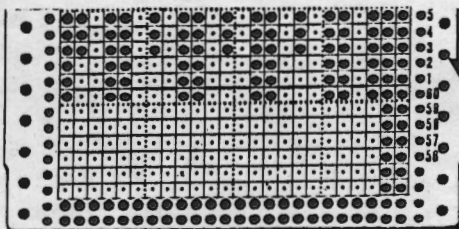

PUNCH THRU ROW 33 THEN PUNCH 2 ROWS OF HOLES FOR CONNECTING CARD.

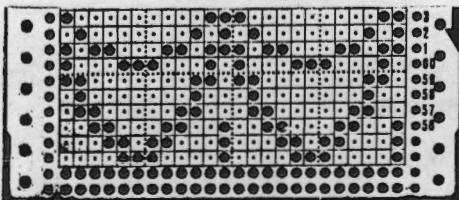

PUNCH THRU ROW 33 THEN PUNCH 2 ROWS OF HOLES FOR CONNECTING CARD.

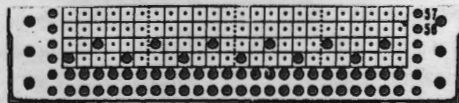

Knitking News

STANDARD METHOD OF KNITTING FAIR ISLE DESIGNS WITH NO FLOATS ON THE BACK

1. Set up the Ribber and KRC Color Changer.
2. Thread yarns into the Color Changer.
3. Attach the fine Knitting Bar to MB.
4. Arrange the ndls. on MB and Ribber for FNR. Pitch at H. Ribber ndls. must be EVEN NUMBER.
5. With Main color, knit several rows or as many as required. End with carriage on Far Left.

NOTE: On the Electronic Machines be sure to Press KRC BUTTON. This will automatically change any Fair Isle Pattern to Double Knit.

For 24 stitch Punch Card Machines, use KRC 830 Pre-Punched Cards.

To convert from regular Fair Isle cards to Multi-Color Rib, see KNITTING Machine Manual pages 21, 22, and 23.

6. Set or Program your Pattern. Set the Change Knob to KC II for Electronic Machines, and KC for regular Punch Card Machines. For regular Punch Card Machine, set both end needle selection cam to non-working position.
7. With Main Color in Feeder A, move carriage to the right to select the ndls. For Standard Machines set the card lock lever to the mark to activate card.
8. Set the Ribber Carriage and MB Carriage as shown below.

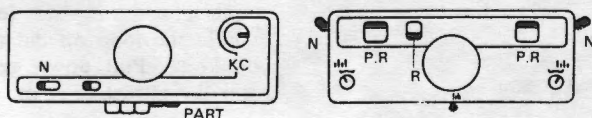

9. Move the Carriage to the left until you hear a 'click'. Push the Color Changer Button for desired color.
10. Knit 2 rows.
11. Continue in Pattern changing color every 2 rows.

HOW TO ADD A LARGE AMOUNT OF STITCHES TO THE EDGE OF A SECTION

With a separate strand of garment yarn, 'e' Cast on the required number of sts. and bring these new sts. to HP on each row until you can hang weights onto these sts. OR on a swatch you can use a Cast on strip (sometimes called a Cast on rag), that has the same amount of sts. (or more) and hang it onto the required needles, then 'e' Cast on directly over the strip and hang weights.

TWO COLOR BULKY TUCK STITCH PATTERNS

Since there is no color changer yet for the MB on the Bulky Machine, here is a good way to feed the yarn when you need to change color every 2 rows. Thread Color 1 through antenna on the right, and Color 2 in the antenna on the left. Then, for example, knit 2 rows Color 1. Remove yarn from feeder and hook it on the right side (there are grooves on each side of the underside of the machine). Insert Color 2, and knit 2 rows. Remove Color 2 and hook it on the left side (in the groove). Each time you change color, remember to hook the yarn on the right or left sides as needed, and in this way yarns are kept free and ready to use.

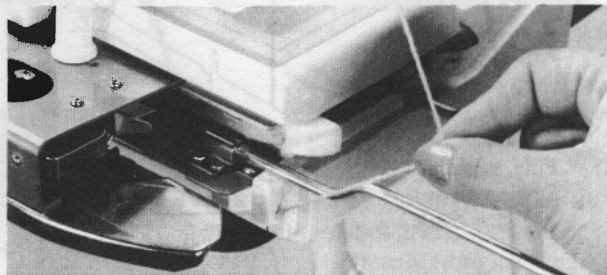

Hook the yarn taken from the YARN FEEDER "A" on the edge of the machine to hold it.

SELECTING NEEDLES FOR A PATTERN THAT HAS NEEDLES OUT OF WORK

When a pattern has needles out of work, it is easy to select the needles before you cast on any stitches. Bring the required amount of needles to WP (do not have any empty needles at this time). HAVE REGULAR CARRIAGE ON THE LEFT SIDE. Set KC and without yarn, move carriage to the right. Set carriage to hold needles. Bring the selected needles to HP. Move carriage to the left, and if needles are selected, bring these needles to HP. Continue to move carriage right, then left until no more needles are selected and until one pattern is completed. All the needles that are now left in WP should be pushed back to 'A' out of work, and the needles that are in holding, returned to working 'B' position ready for cast on. Be sure to turn off the selecting mechanism under the carriage when you are working with needles out of work. For the Electronic Machines just use KC II.

NECK SHAPING WHEN WORKING IN LACE PATTERN

Always complete Lace transfers and knit 2 rows St. st. before shaping. Mark row on card or pattern. With Ravel Cord, manually knit sts. on the left back to 'A' position and BO the center neck sts. Complete the right side first. When right side is completed and off the machine, bring the sts. on the left back into WP. Be sure the sts. are in the hooks of the needles. Line them up in 'B' (working position). Return to mark or row in pattern and set pattern. Move the Lace Carriage left to right and continue in pattern.



660

FASHION FINESSE

Begin with a gorgeous sweater that has a flattering surplice front. It's knitted with Venetia and Glace for Plating. The sleeves combine the Plating with panels in a Weaving design using Angora. Sizes Small, Medium and Large.



661

ENCHANTMENT

Dance your way into his heart in a colorful dress made for a night out. Different length panels form a petal-like floating lower skirt section. It is very easy to knit and is worn on the purl side. Purchase a lace collar or knit one from this issue. You can knit it on any Standard or Electronic Machine. Sizes 8 to 16.



662

PARTY PERFECT

Thread Lace for the skirt and sleeves and Stockinette Stitch with cables for the bodice section make up into a pretty two piece dress anyone would be delighted to wear. We knitted it on the new KK 93 Machine with Thread Lace capability. The yarn is Starlite and spools of matching thread. Sizes 16 to 22.



663

ULTIMATE PERFECTION

Get Busy short rowing on any Bulky Machine for a designer's delightful sweater using our famous Pebble and Angora yarns, then rib the bands with Venetia on a Standard Machine with Ribber.





664

EASY KNITTING

means a Garter Carriage with Electronic Machine for perfect results on a man's pullover. Tiny cables are an added interest. A Standard Ribber is used for the English Rib sleeves. Knit it with Roma in sizes 44 to 48.



665

MIX AND MATCH

color stripes on a Tuck Stitch pullover that is worn on the purl side. Colors are reversed on the sleeves and you can knit it on any Standard Punch Card or Electronic Machine. Our lovely Kotton is the yarn and sizes are 6 to 14.





666

TEEN SCENE

You can impress any teenage girl with a fantastic Fair Isle pullover and Full Needle Ribbed skirt. It's gay and colorful and if you knit the Fair Isle design using your ribber technique, there will be no floats on the back. Make it on the KH 260 Punch Card Bulky using wash and wear Amore. Sizes 5/7, 9/11.

669

HANDSOMELY STYLED

For your man is a two color Tuck Stitch pullover. It's easy and quick to knit on any Bulky Punch Card Machine. The yarn is a novelty special purchase. Knit it in sizes Medium and Large. Ribbing is used for the bands.

668

SCHOOL DAZE

Especially designed for knitting on the Simple 7 Machine, this young man is happily wearing a cabled pullover. The Ribbing is manually latched up (or you could use a mock rib). The cables are easily crossed. It is a great project for a beginner. You will want to knit one for sister too. Acrylite is the yarn. Sizes 6/7, 8/9.



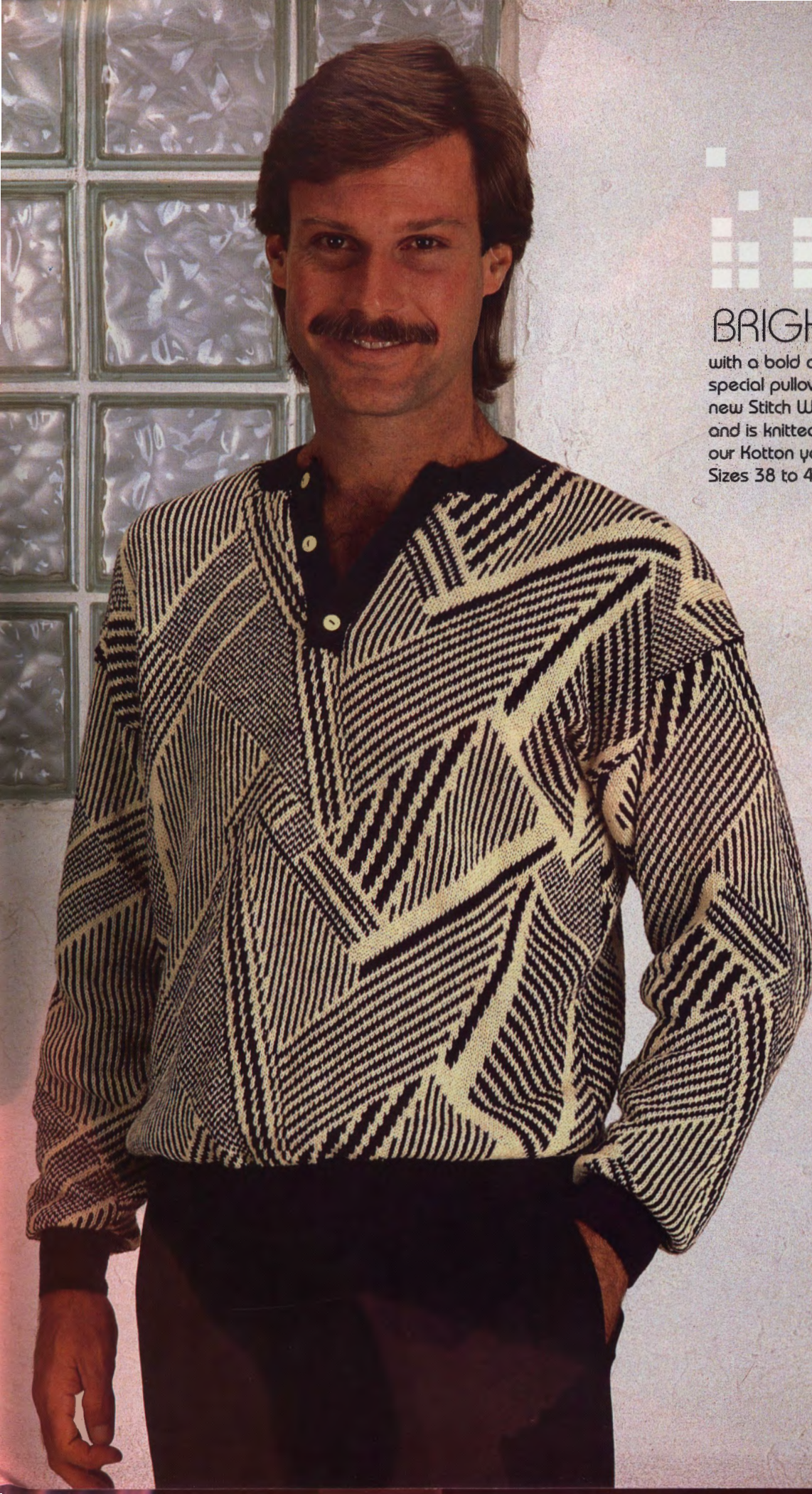

667

BRIGHTEN HIS LIFE

with a bold and striking design on a special pullover. . . The design is from the new *Stitch World Disk and Pattern Book* and is knitted on the *COMPUKNIT III* using our *Kotton yarn*. The bands are ribbed. Sizes 38 to 46.

Dress up a plain sweatshirt or sweater. Wear any of these collars (teenagers adore them) and knit a bunch for gifts. Fine Venetia can be used for the Thread lace collar to be knitted on your Electronic or HK 93 Machine. The other two can be knitted on any Standard Punch Card Machine in a Turk and Slip Stitch. One is Venetia, the other Glace and Mami Flex. Neck sizes 13" to 17"

