

A decorative border made of a chain-link pattern surrounds the text. It starts at the top left, goes right, then down the right side, then diagonally from the top right to the bottom left, then left along the bottom, and finally up the left side.

INSTRUCTION BOOK

FOR

AUTOMATIC LINKER

(pages 1-18)

LIBRO DE INSTRUCCIONES

DE LA

ENCADENADORA AUTOMATICA

(páginas 19-34)

CONTENTS

Precautions	2	Joining two fabrics.	13
Names of parts and their function	2	I. Stitches to stitches.	14
Practice (casting off stitches of last row)	3	II. Stitches to side edge.	15
Check points	8	III. Side edge to side edge	16
If the Linker has jammed	11	How a stitch is linked.	17

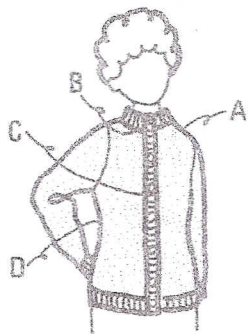

Automatic Linker, in combination with the Knitter, performs the following:

1. To cast off stitches on the last row
2. To join knitted pieces
 - a) Front shoulder to back shoulder "A"
 - b) Neck band to neck edge "B"
 - c) Border to front "C"
 - d) Front and back side seams "D"

Important:

The Automatic Linker, **SC-1**, is exclusive to Models **321** through **328**, and Model **500**.

SC-3 is for Model **360** and **260**.

SC-7 is for Model **MK-70**.

Precautions:

- * Before using the Automatic Linker.....
 - Read this Instruction Book very carefully, otherwise you may damage the Linker irreparably.
 - Remove all the detachable accessories from the needle bed if they were in use.
(Edge Pins (model SK-360/260), Point Cams, Yarn Separators and Close Knit Bar.)

NAMES OF PARTS AND THEIR FUNCTION

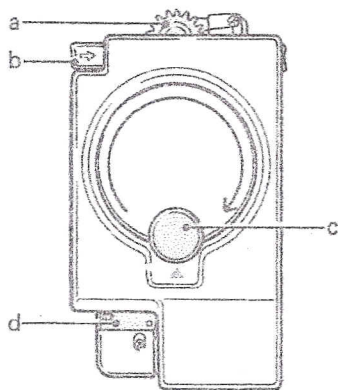

- a. Connection Gear
This gear meshes into the Rack of the needle bed, and will advance the Automatic Linker as the Crank Handle is turned.
- b. Slide Button
White button at the left end, and Red button at the right end. Push in the White Button before setting the Linker on the needle bed.
Push in the Red Button to enable the Connection Gear to mesh into the Rack of the needle bed.
- c. Crank Handle
One complete turn of the Crank Handle in the direction indicated by the arrow mark will link one stitch with the adjacent stitch.
- d. Fabric Holder
The fabric must enter into the passageway of the Fabric Holder for linking.

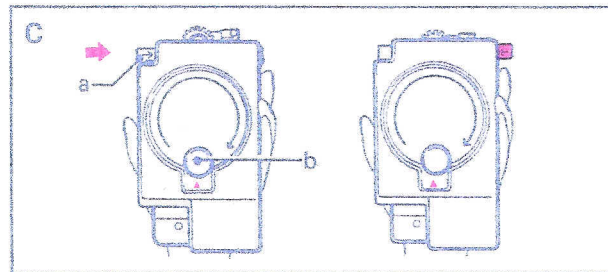
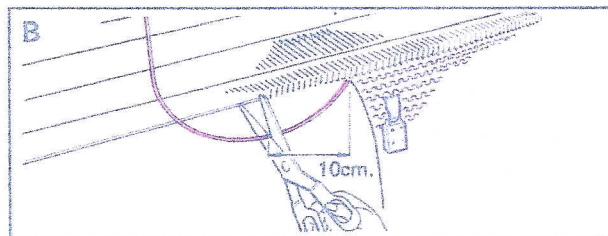
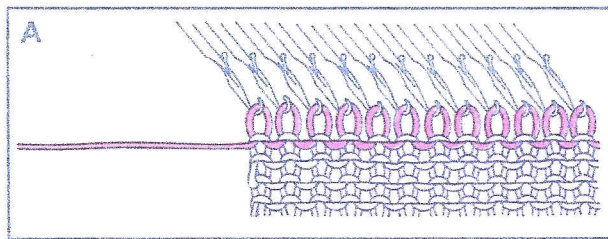

PRACTICE

(Casting off stitches on the last row)

- (1) Knit 1 row from right to left with Stitch Dial 10, so stitches become easy to cast off. (Fig.A) (If thick yarn is used for the main knitting, knit the joining rows using a medium yarn.)
- (2) Cut the yarn leaving a length of approx. 10cm. from the edge of the fabric. (Fig. B)
- (3) Setting the Linker on the needle bed.
 - ① Press in the white end of the Slide Button "a", the Crank Handle "b" must be set at the "▲" mark. (Fig. C)

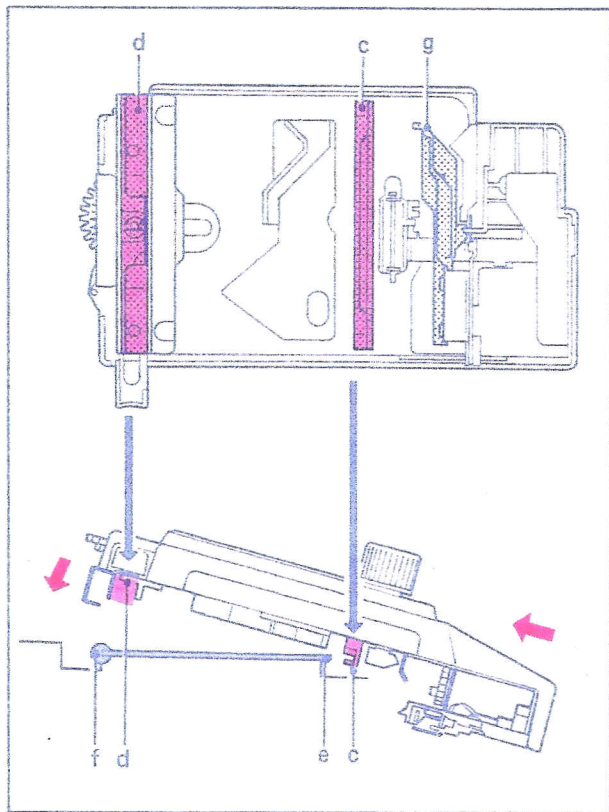

② Set the Linker at the right side of the fabric.
(Fig. D)

* Engage the Slider "c" with the Front Rail "e".

* Slant Back the Linker to fit the Carriage Guide "d" on the Rail Bar "f", while pushing it backward.

③ Try sliding the Linker on the needle bed to ensure that it moves freely and is set correctly.

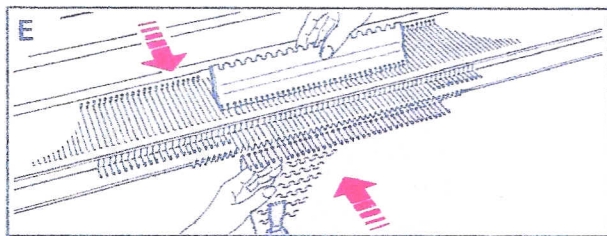

- (4) Push all the knitting needles to holding position using the Needle Pusher. (Fig. E)

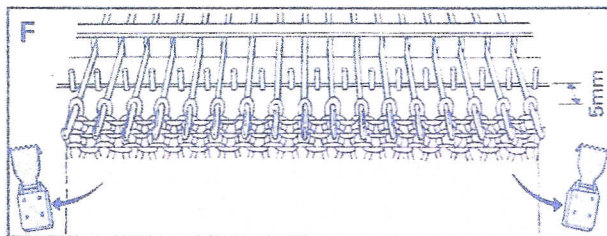

- (5) Ease the fabric approx. 5mm away from the Sinker Posts and remove comb and/or weights if these have been used for the main knitting. (Fig. F)

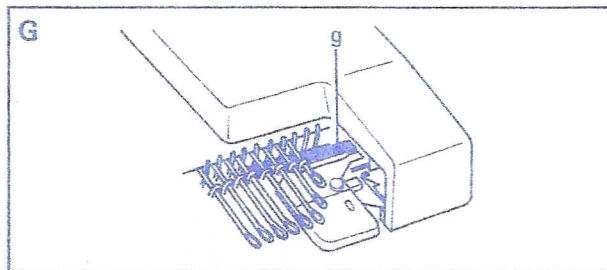

- (6) Move the Linker to the right edge of the fabric till the SC Arm "g" comes behind the first 4 stitches. (Fig. G)

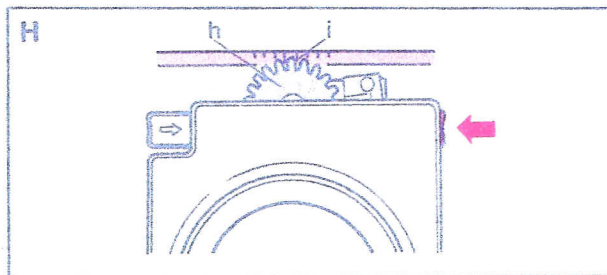

- (7) By pushing in the red end of the Slide Button, the Connection Gear "h" will mesh into the Rack "i" of the needle bed, (Fig. H) if the Gear meshes with the Rack improperly, incorrect linking of stitches will be resulted.

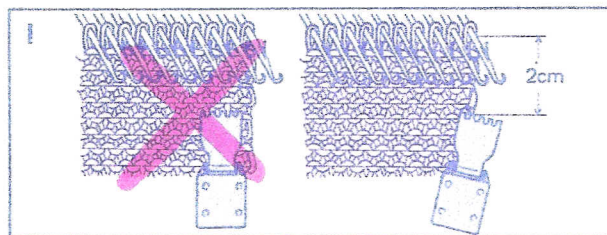

- (8) Hook the two end claws of the Claw Weight on the two end stitches of the fabric, 2cm. below the needles. (Fig. I)

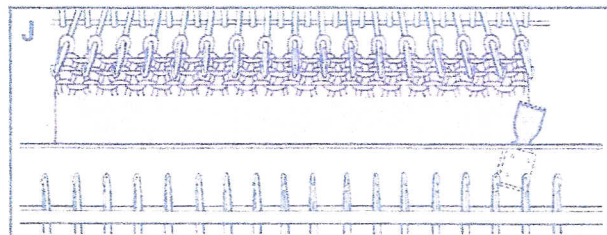

- * If the knitting has been done with the Ribber attached, let the fabric hang down between the knitter and the Ribber. (Fig. J)

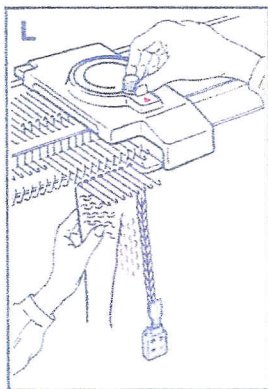
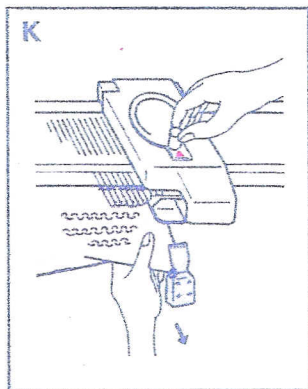

(9) For the first 5–6 stitches, hold the knitting down lightly so that the end of the fabric is pulled slightly to the right. (Fig. K)

(10) Turn the Crank Handle very slowly watching the linking of the stitches. Refer to page 17, 18 for the correct linking procedure.

(11) For the last 5–6 stitches, hold the knitting to offset the weight of the fabric. (Fig. L)
Guide the yarn end through the end stitch and fasten off. (Fig. M)

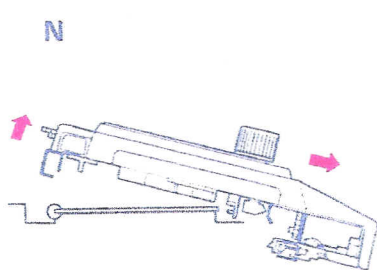
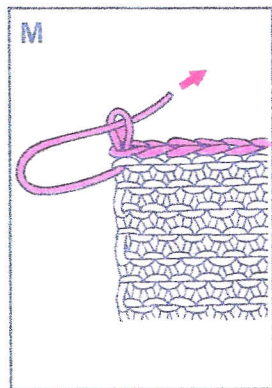

(12) Push in the white end of the Slide Button and remove the Automatic Linker from the needle bed. (Fig. N)

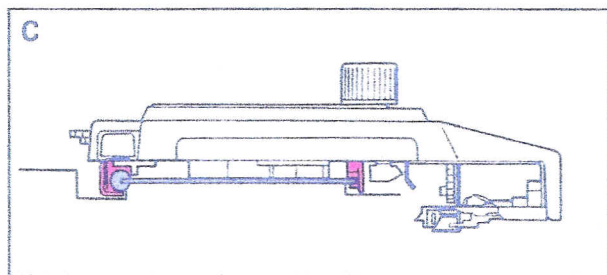
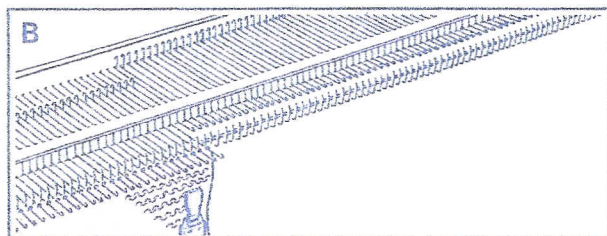
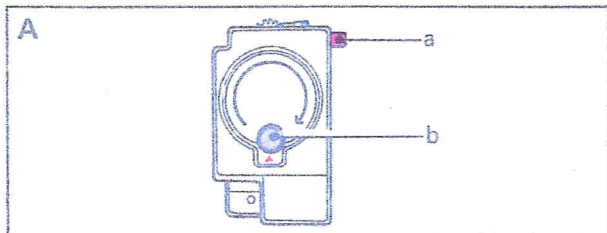

CHECK POINTS

(1) If it is difficult to mount the Linker, or to slide it on the needle bed.

- * Is the Red end of the Slide Button out? (Fig. A)
- * Is the Crank Handle set at the "▲" mark? (Fig. A)
- * Are the non working needles correctly aligned in A position? (Fig. B)
- * Did you mount the Linker at the right side of the fabric?

Try sliding the Linker after mounting it on the needle bed.

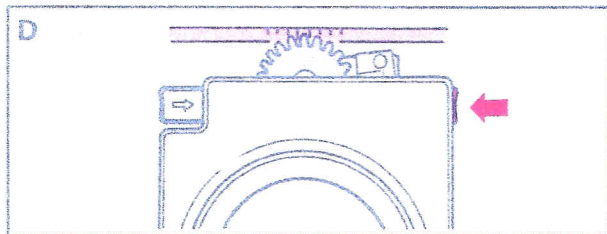

(2) If the Crank Knob is hard to turn.....

* Is the Connection Gear meshed into the Rack correctly? (Fig. D)

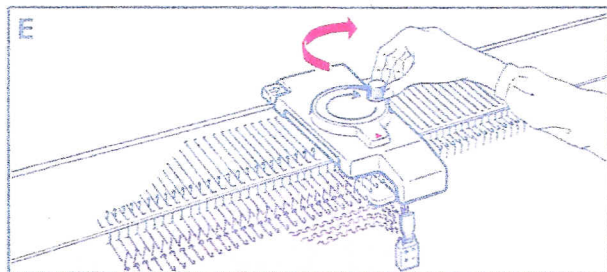

* Is the Crank Knob being turned in the correct direction? (Fig. E)

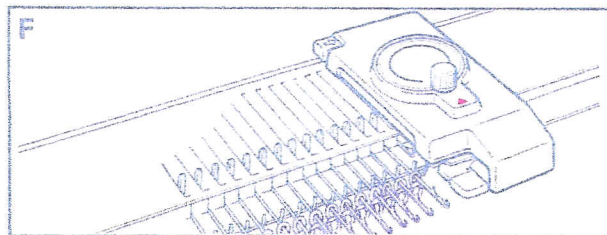

* Are the needles aligned correctly in D position? (Fig. F)

* Has the correct Stitch Dial setting been used to knit the cast off or joining rows?

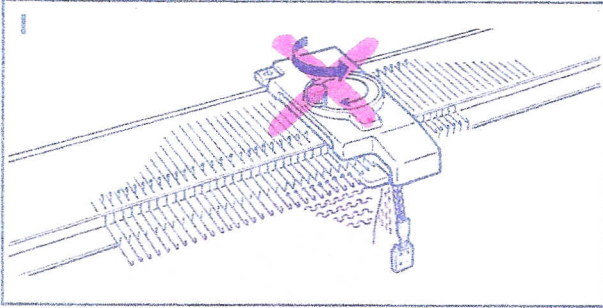
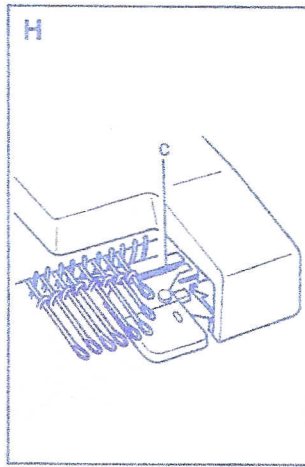
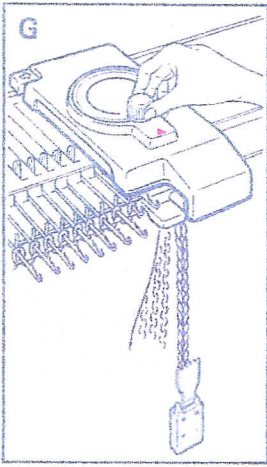

(3) If the stitches drop or overlap.

- * Is the Claw Weight correctly attached on the edge of the fabric? (Fig. G)
- * Check and ensure that the weight is hanging free.
- * Check if the linking stitches are caught at the entrance "c" of the Linker. (Fig. H)

- * It is important to achieve a smooth even rhythm, pressing down slightly as the Crank Handle is turned.

DO NOT TURN THE CRANK HANDLE IN THE ANTI CLOCKWISE DIRECTION. (Fig. I)

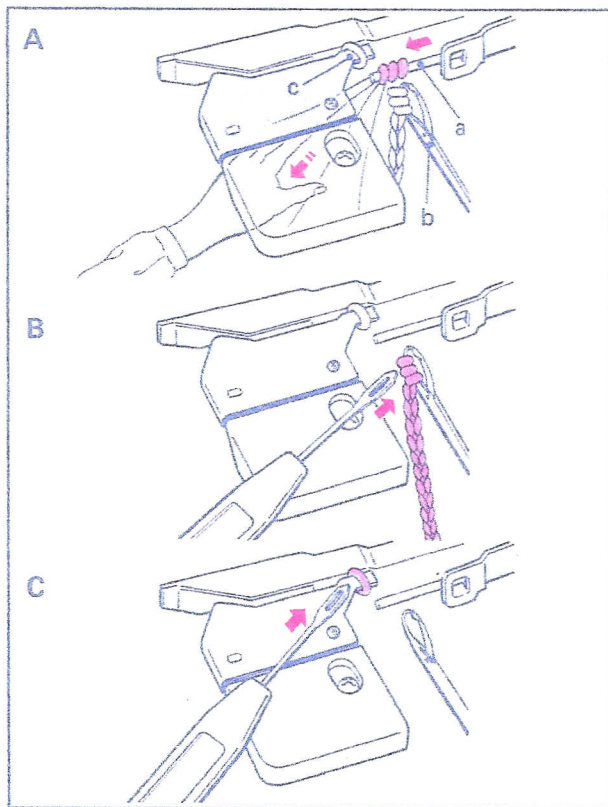

IF THE LINKER HAS JAMMED



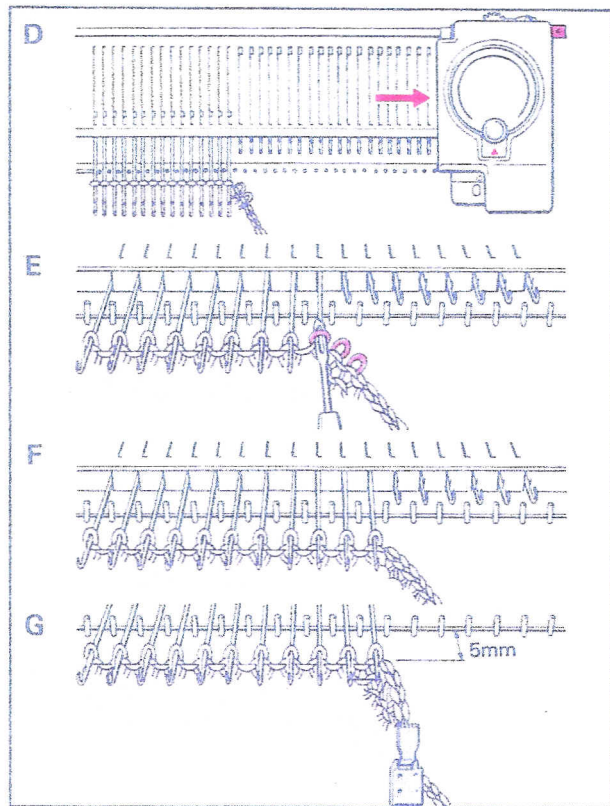

- * Remove the Claw Weight, then free the Linker from the jamming in the following manner.
- (1) Carefully pulling the fabric to left, remove the built-up stitches from the Guide Pin "a" in the Linker. (Fig. A)
 - If it is difficult to remove the stitches, turn the Crank Handle in the forward direction toward the "▲" mark slowly, watching those stitches, while carefully pulling the fabric to the left.
 - (2) Remove the stitches from the Transfer Needle "b". (Fig. B)
 - (3) Remove the stitches from the Fabric Holder "c" carefully. (Fig. C)



- (4) Reset the Crank Handle to the "▲" mark.
- (5) Push in the white end of the Slide Button, and slide it to the right side of the needle bed. (Fig. D)
- (6) Pick up each unraveled stitches on the top edge, and hook them back to the original needle. (Fig. E)
- (7) Align the needles holding stitches in D position, and empty needles in A position. (Fig. F)
- (8) Ease the fabric approx. 5mm away from the Sinker Posts.
Hang the Claw Weight on the linked edge about 5cm. below the Sinker Posts. (Fig. G)
- (9) Continue linking off the remaining stitches.

JOINING TWO FABRICS

When knitting the joining rows of two fabrics the carriage must be operated as indicated in the table below. The Cam lever is at STOCKINET and both Russell Levers are at II.

Joining Rows Type of yarn used in main knitting	1st row	2nd row	3rd row
Thick yarn		 Medium or light yarn	 Medium or light yarn
Medium yarn Light yarn Thin yarn	 S.D. at garment tension		

(S.D. means Stitch Dial)

- If the fabric is knitted with thick yarn, use medium or light yarn to knit the joining rows of the two fabrics as indicated in the table.
- When using a knobby yarn such as boucle, replace it with a smooth yarn.

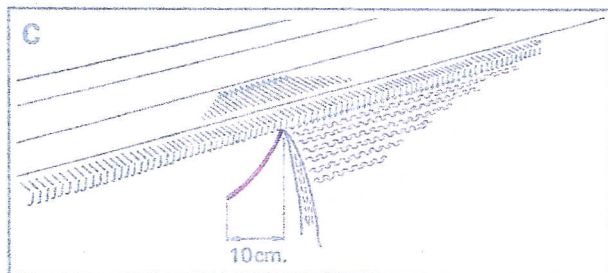
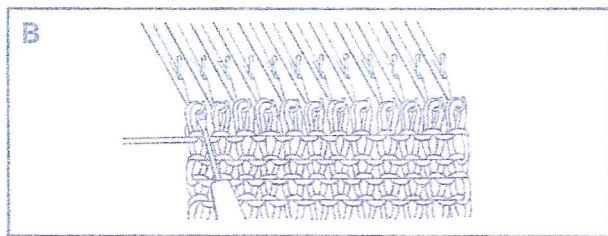
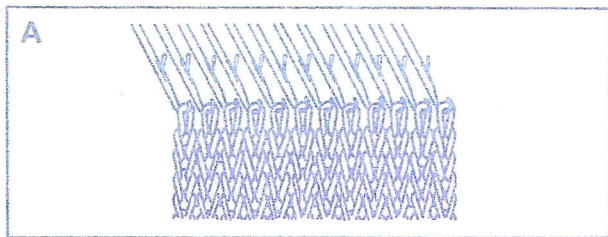

I. Stitches to Stitches

- (1) With the right side of the fabric facing pick up and replace the stitches in main yarn onto the empty needles. (Fig. A)
- (2) With the wrong side of the fabric facing pick up and replace the stitches in main yarn onto the corresponding needles. (Fig. B)
- (3) Push the needles to D position.
- (4) Referring to page 13, for Stitch Dial setting, knit 2–3 rows finishing at left side. Cut off the yarn leaving a 10cm length. (Fig. C)
- (5) Referring to "PRACTICE" (3)–(12), link off the stitches.

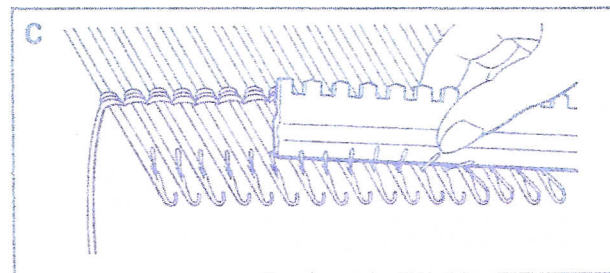
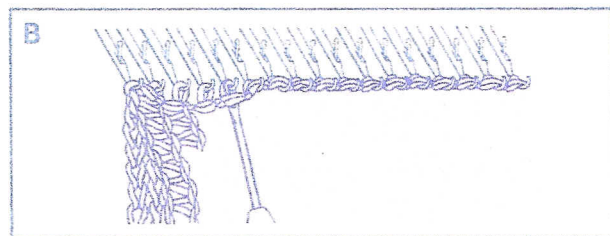
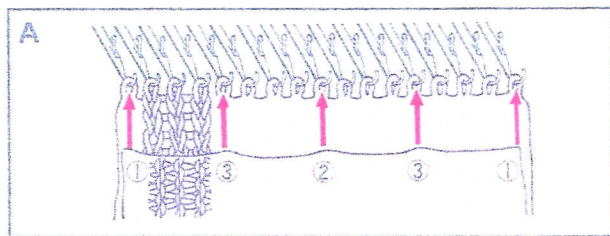

II. Stitches to Side Edge

- (1) With the right side of the fabric facing pick up and replace the stitches onto the needles. (Fig. A)
- (2) With the wrong side of the work facing pick up and replace the stitches of the side edge as indicated in Fig. A, then fill the remaining needles with stitches picked up evenly along the edge. (Fig. B)
- (3) Push the needles to D position, and close their latches using the Needle Pusher. (Fig. C)
- (4) Referring to page 13, for Stitch Dial setting, knit 2–3 rows finishing at left side. Cut off the yarn leaving a 10cm length.
- (5) Referring to "PRACTICE" (3)–(12), link off the stitches.

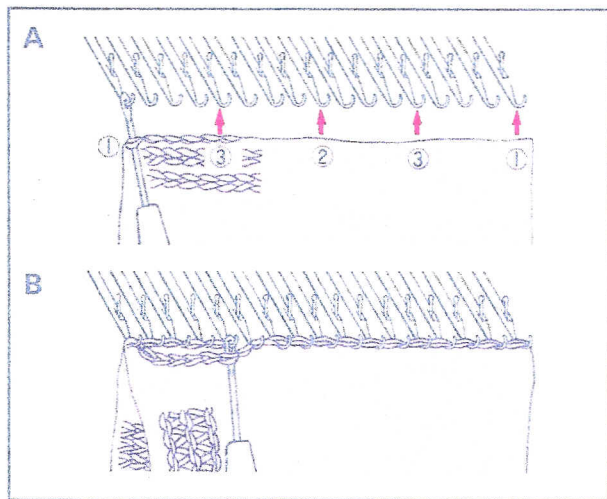

III. Side Edge to Side Edge

- (1) Following the rules on Page 15 and with the right side of the fabric facing pick up and replace the loops evenly along the edge. (Fig. A)
- (2) With the wrong side of the fabric facing pick up and replace the same number of loops onto the corresponding needles. (Fig. B)
- (3) Push the needles to D position, and close their latches using the Needle Pusher.
- (4) Referring to page 13, for Stitch Dial Setting, knit 2-3 rows finishing at left side. Cut off the yarn leaving a 10cm length.
- (5) Referring to "PRACTICE" (3)-(12), link off the stitches.

To ensure natural elasticity in the joined side edge, pick up the number of stitches as specified below:

The recommended number of stitches to be picked up from the side edge is about 27(23) stitches per 10cm.

EXAMPLE

If garment measurement is 35cm, then
 $35\text{cm.} \times 2.7(2.3) \text{ stitches} = 94.5(80.5) \text{ stitches.}$
 $2.7 (2.3) = \text{stitches per 1cm. to be picked up.}$

* Number in bracket refers to the Mod. MK-70.

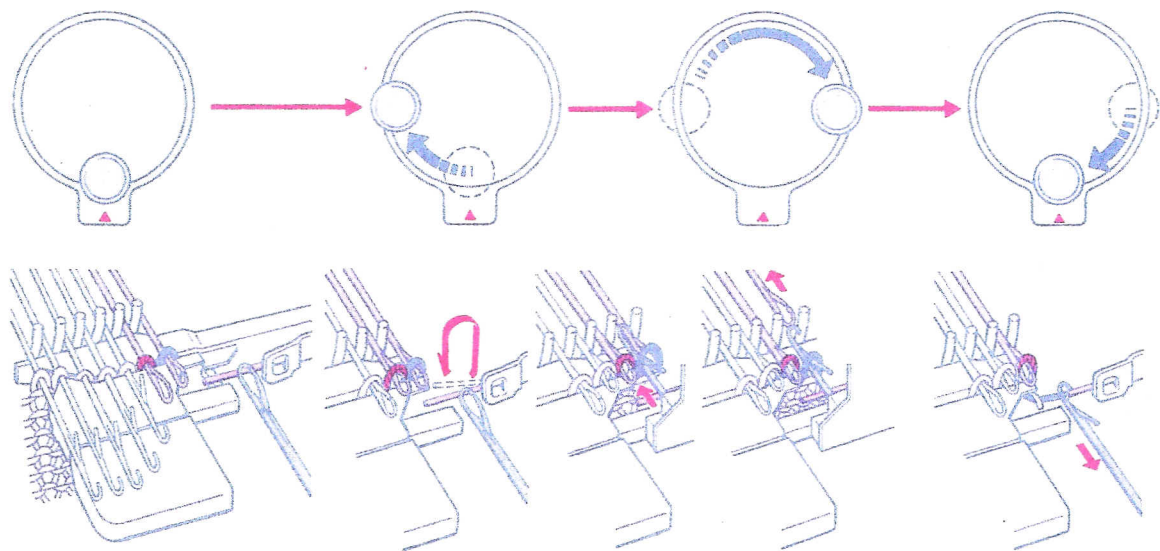

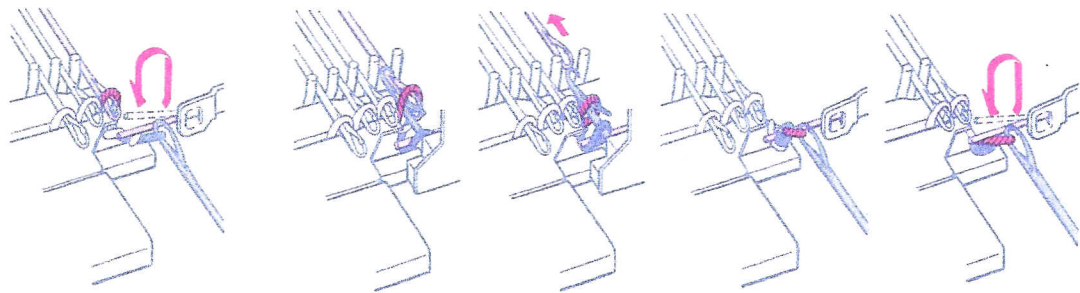
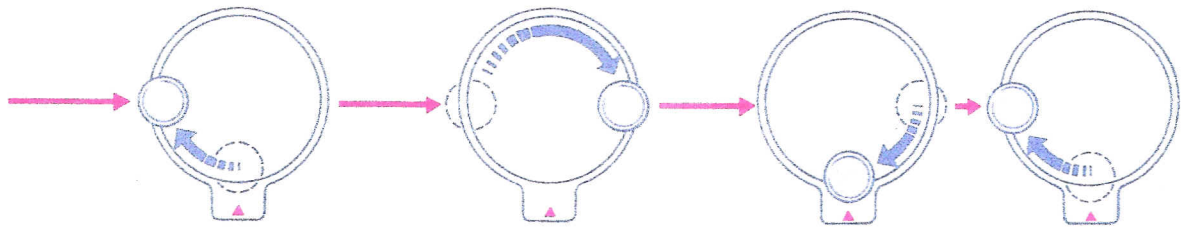

CUSTOMER'S CHECK SHEET

— for successful linking —

In addition to the Instruction Book, the important points for using the Automatic Linker are set forth below to help you achieve perfect linking on the first try.

1. Knit the cast off or joining row in the biggest stitch size, and cut the yarn leaving 10cm. at the left side of the fabric.

2. Push the knitting needles to "D" position.

Slide the fabric toward you about 5mm. from the Sinker Posts so as the top stitches easily go into the Automatic Linker.

3. Hang two claws of the Weight over two end stitches, at the position about 2cm. below the top edge.

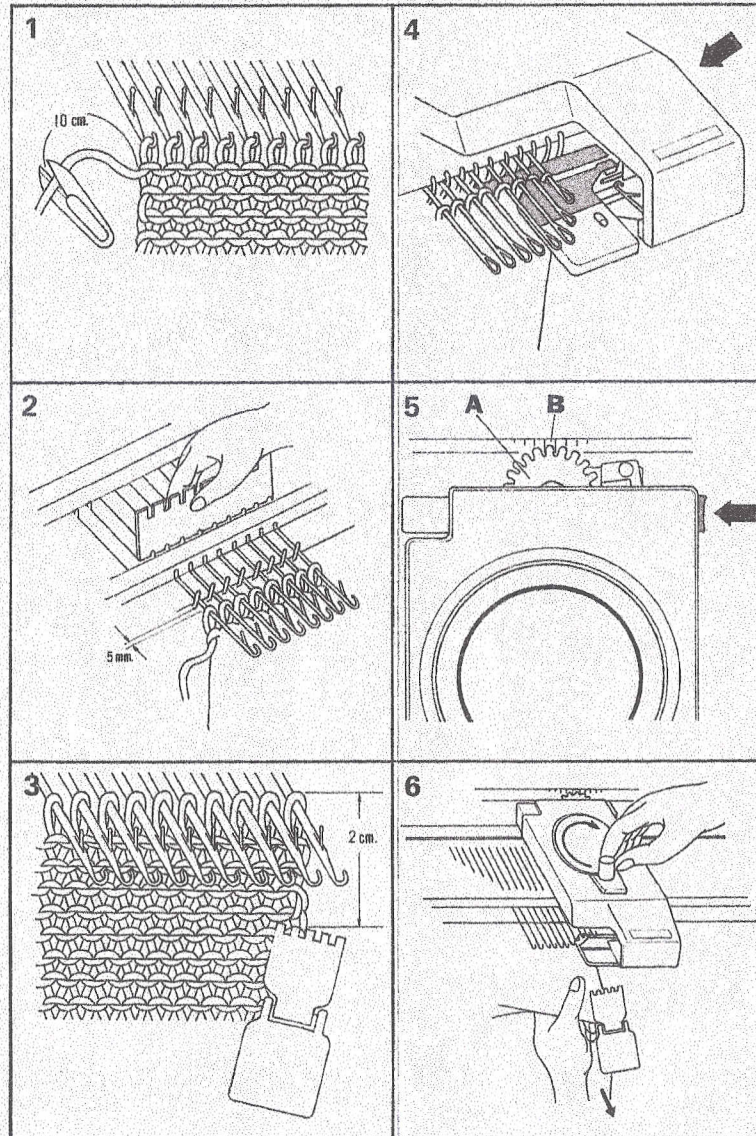

4. Set the Linker on the Needle Bed and bring it near to the right side of the fabric till first four stitches engage with the Linker.

5. Press in the Red Slide Button, and make sure that the Gear (A) meshes with the Rack (B) perfectly.

6. For the first five to six stitches, lend your hand's aid to the fabric to pull its right edge toward right a little till the linking commences, while turning the Crank Knob.

Turn the Crank Knob smoothly in a constant and slow speed.

For the last five to six stitches, hold the fabric to reduce its weight, since the weight makes the linking stitches bigger.

IF THE AUTOMATIC LINKER HAPPENED TO JAM, CAREFULLY DISENGAGE IT FROM THE NEEDLES AND YARNS WITHOUT APPLYING MUCH FORCE.