

This revolutionary attachment is used with both the Knitting Machine and Ribbing Attachment and eliminates the floating of yarn on the back side of the fabric.

CONTENTS

* Nomenclature of Parts.....	1
1. Setting up the Automatic Yarn Changer.....	2
* Correct use of the Ribber Arm for the YC-1	4
2. Basic Knitting	5
* Correct Method for Changing Yarns	10
3. Pattern Knitting	11
* How to Make and Check a Punch Card.....	11
* Recommended Stitch Dial Numbers for Yarn Thicknesses to be knitted in Double Jacquard	12
* How to follow the Operation Table	13
1 Double Jacquard	14
2 Point Knitting in Double Jacquard.....	17
* In the Case of using One Point Cams.....	18
* In the Case of using Magic Cams	19
4. Maintenance and Service	21
* In the Case that the YC-1 Cannot be Removed from the machine because of the Needle Retainer.....	21
* If a Mistake is made while Knitting.....	22
* If you wish to knit in Double Rib wanting the same effect as Double Jacquard	23
* If the Pattern is Improperly Knitted.....	23
* When knitting with the Main Machine Only	24
* The Method for Placing Yarns in the Auxiliary Yarn Feeder of the YC-1 Arm.....	24

Este dispositivo revolucionario se usa con la Máquina Principal y la Máquina Auxiliar juntos y puede eliminar el flotamiento del hilo en el reverso del tejido.

CONTENIDO

* Nomenclatura de Partes.....	1
1. Cómo Instalar el Cambiador Automático de Hilo.....	2
* Use Correctamente el Brazo de la Auxiliar para el Cambiador YC-1	4
2. Tejido Básico.....	5
* Método Correcto para Cambiar Hilos	10
3. Tejido de Diseños	11
* Cómo Perforar diseño en una Tarjeta y Comprobarlo.....	11
* Números Recomendables de los Discos de Tensión según el grueso de hilo que se teje en Puntos de Jacquard Doble.....	12
* Cómo Interpretar la Tabla de Operaciones	13
1 Jacquard Doble.....	14
2 Diseño Individual en Puntos de Jacquard Doble.....	17
* En el Caso de Usar las Levas de Diseño Individual.....	18
* En el Caso de Usar las Levas Mágicas	19
4. Mantenimiento y Servicio.....	21
* En el Caso de que el YC-1 no se pueda Sacar de la Máquina, detenido con el Retén de Agujas	21
* Cómo Corregir cuando se equivocó al tejer.....	22
* Si usted quiere tejer en Resorte Doble dando el mismo efecto como el tejido en Jacquard Doble	23
* Si se teje el Diseño en Punto Jacquard Doble Incorrectamente.....	23
* Cuando teja sólo con la Máquina Principal	24
* El Método de enhebrar un Hilo por entre el Alimentador Auxiliar del Brazo para el YC-1.....	24

NOMENCLATURE OF PARTS:

NOMENCLATURA DE PARTES:

**AUTOMATIC YARN CHANGER (YC-1)
CAMBIADOR AUTOMATICO DE HILO (YC-1)**

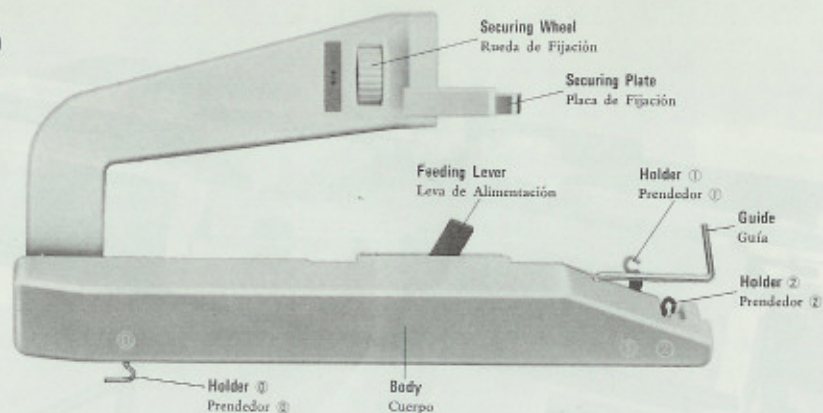

**ARM:
BRAZO**

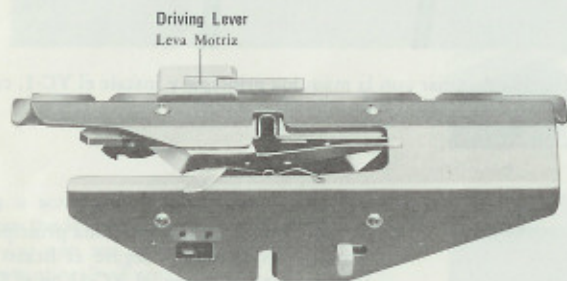

**NEEDLE GUIDE
GUIA DE AGUJAS**

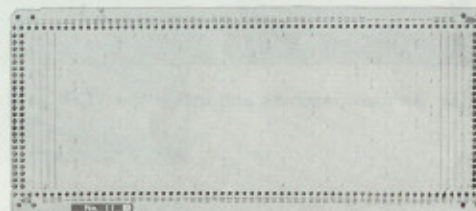
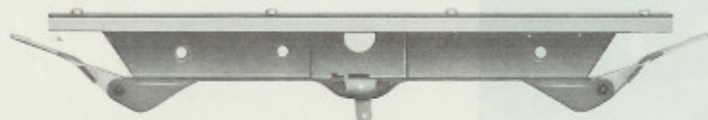

**PUNCH CARDS
TARJETAS PERFORADAS**

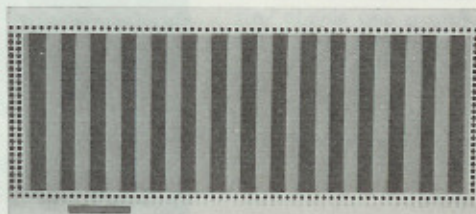

**CHECK CARD
TARJETA DE PRUEBA**

1. SETTING UP THE AUTOMATIC YARN CHANGER

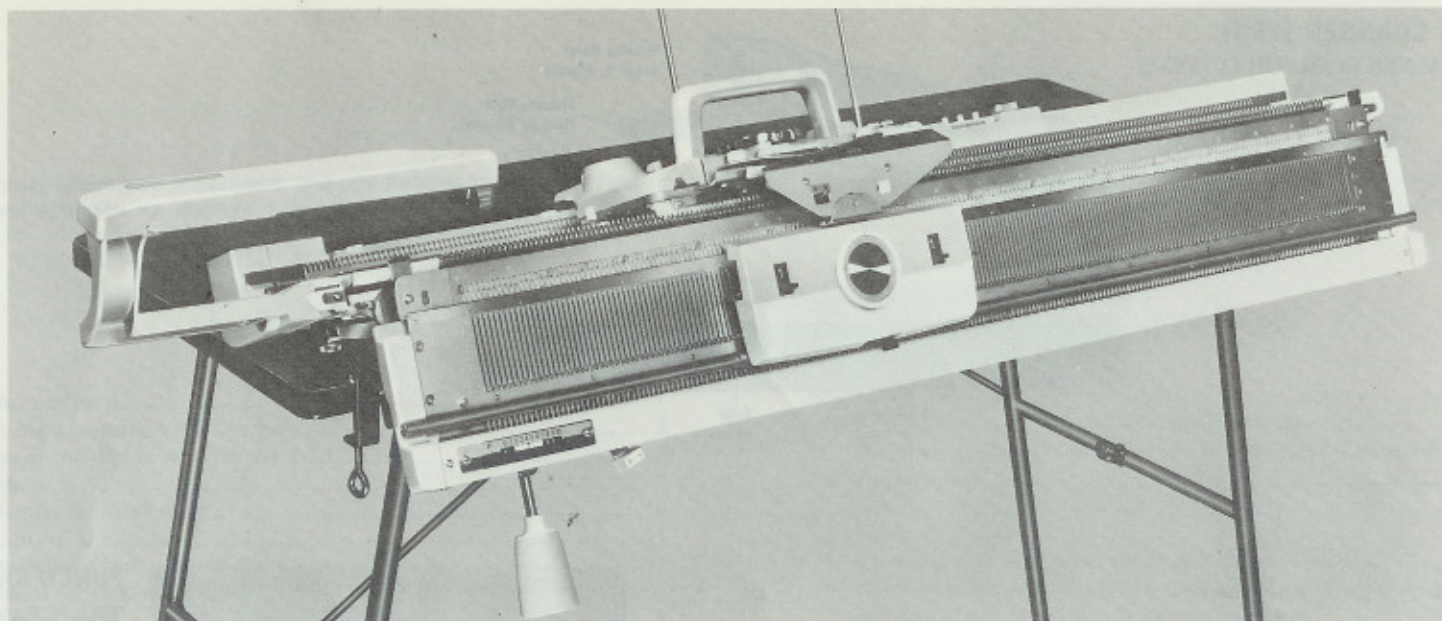

Couple the Ribbing Attachment to the main machine and install the YC-1, as above, so as knitting is ready to begin.

1. After securing the main machine and the Ribbing Attachment to the table, secure the Ribber Arm (for use with the YC-1) to the main machine Carriage. The Driving Lever on the Arm should still be in an inactive position. (The YC-1 Ribber Arm is also able to knit all other kinds of ribbed stitch patterns, even if the YC-1 is not being used with the machine.)

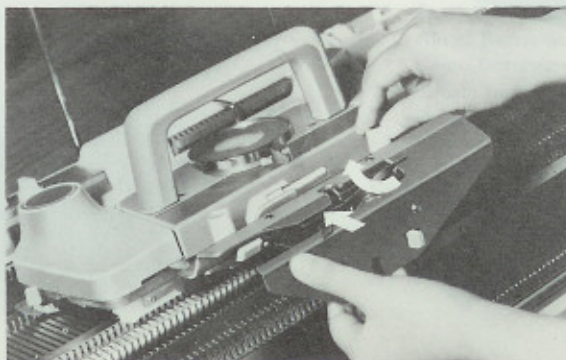

1. COMO INSTALAR EL CAMBIADOR AUTOMATICO DE HILO

Acople la Máquina Auxiliar con la máquina principal y instale el YC-1, como se muestra arriba, para hacer preparaciones de comenzar a tejer.

1. Después de asegurar la máquina principal y la Máquina Auxiliar en la mesa, asegure el Brazo de la Auxiliar (Hecho para usar con el YC-1) en el Carro de la Máquina Principal. La Leva Motriz del Brazo aún debe estar en la posición inactiva. (El Brazo YC-1 de la Auxiliar también puede tejer cualquier de los otros tipos de tejido en puntos elásticos (resorte), aunque el YC-1 no se está usando con la máquina.)

2. Change the Needle Guide, on the back side of the Ribber Carriage, to the Needle Guide that must be used when knitting with the YC-1. Remove the screws securing the Needle Guide, as shown in the photograph opposite, and place the YC-1 Needle Guide in position, afterwards replacing the screws and securing them. (There is no need to replace the original Needle Guide as the YC-1 Needle Guide can be used for ordinary ribbed stitch patterns.)

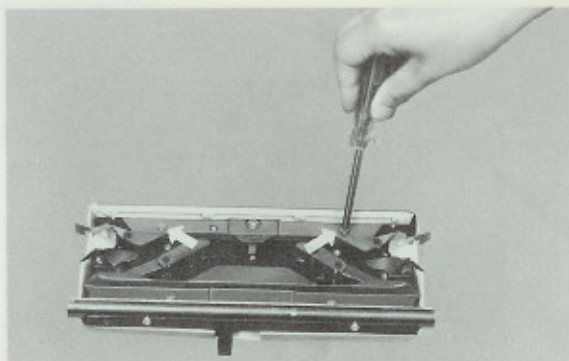

3. Connect the Ribber Carriage to the Arm by fitting the Link Pin into the slot on the Carriage Arm.

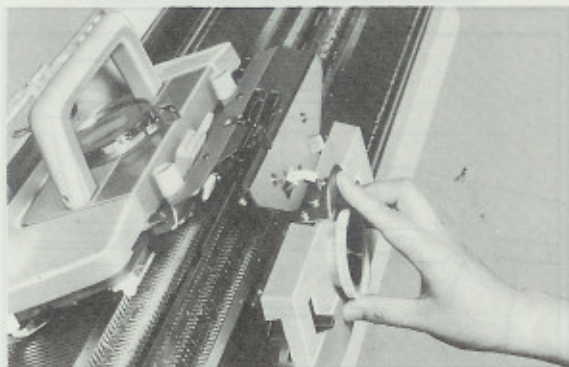

4. Push, using a screw driver or a pencil, the Needle Retainer from the left side of the main machine needle bed, until you can see the right end of the Needle Retainer protruding 2-3 cms.

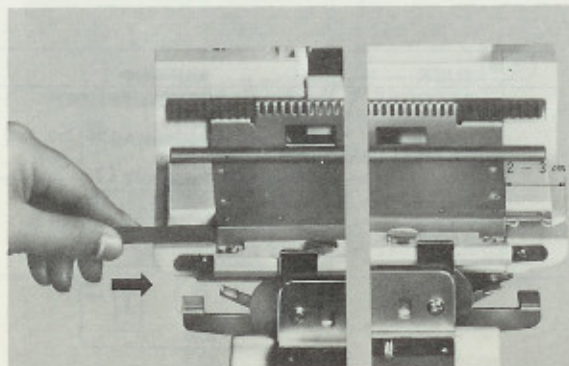

2. Cambie la Guía de Agujas, en el lado revés del Carro de la Auxiliar con la que se debe usar al tejer con el YC-1. Saque los tornillos asegurando la Guía de Agujas como se muestra en la foto y coloque la Guía de Agujas YC-1 en posición, luego reponga los tornillos y asegúrelos. (No hay necesidad de recolocar la Guía de Agujas Original por lo que la Guía de Agujas YC-1 se puede usar para los tejidos en puntos elásticos ordinarios.)

3. Ponga en contacto el Carro de la Auxiliar con el Brazo, colocando el Pasador de Unión en el orificio destinado al efecto que hay en el Brazo del Carro.

4. Empuje, usando un destornillador o un lápiz, el Retén de Agujas del lado izquierdo de la cama de agujas de la máquina principal, hasta que se pueda ver el extremo derecho del Retén de Agujas saliendo afuera a 2-3 cms.

- Loosen the Securing Wheel of the YC-1 in the direction shown in the photograph opposite, until it stops. (As the Securing Wheel is loosened the Securing Plate moves forward.)

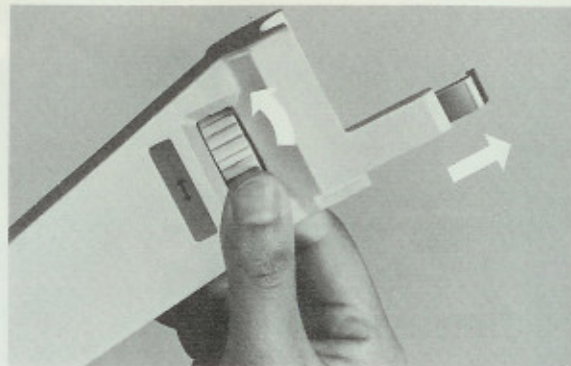

- Afloje la Rueda de Fijación del YC-1 como indica la dirección de la flecha en la foto, hasta que se pare. (Mientras la Rueda de Fijación se afloja, la Placa de Fijación sale para adelante.)

- Insert the Securing Plate into the Guide Hole of the Needle Retainer and turn the Securing Wheel in the arrowed direction, shown in the right diagram until the Securing Plate is firmly installed. Be sure that the edge of the YC-1 is firmly set against the side cover of the casement. (The Needle Retainer should remain as it is while fastening and after the Securing Plate has been firmly installed.)

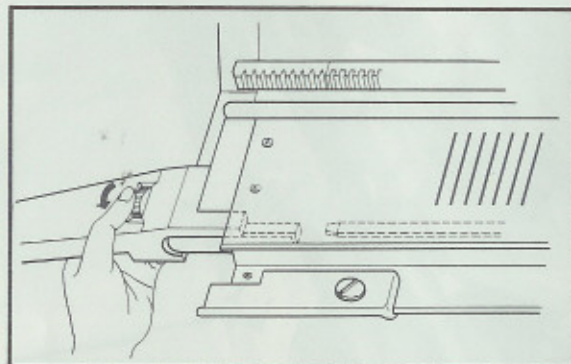

- Inserte la Placa de Fijación en el Canal de Guía para el Retén de Agujas y gire la Rueda de Fijación en la dirección de la flecha en el diagrama, hasta que la Placa de Fijación se instale firmemente. Asegúrese de que el borde del YC-1 sea justamente colocado sin ningún espacio contra la cara de la cubierta lateral del estuche. (El Retén de Agujas debe quedarse a 2-3 cms fuera de la cama mientras asegurando la Rueda y después de que la Placa de Fijación se haya instalado con firmeza.)

Correct Use of the Ribber Arm for the YC-1

When using the Ribber Arm for the YC-1 and a mistake occurs during the course of knitting, which is related to the Arm, then damage will be made to the needles.

- The Cam Lever, of the main machine Carriage, must be positioned correctly at either Stockinet, Slip or Tuck depending on the pattern being knitted. DO NOT set it to knit-in or Punch Lace.
- The Needle Guide, on the back of the Ribber Carriage, must be replaced with the Needle Guide for use with the YC-1.



Use correctamente el Brazo de la Auxiliar para el Cambiador YC-1.

Al usar el Brazo de la Auxiliar para el YC-1, si ocurre un error durante el proceso de tejer, el cual se relaciona con el Brazo, serán dañadas las agujas.

- La Palanca de Leva del Carro de la máquina principal se debe posicionar correctamente en jersey, deslizar o recoger según el tipo de diseño que se vaya a tejer. NO LA COLOQUE en Entretejido o Punch Lace.
- La Guía de Agujas, en el reverso del Carro de la Auxiliar, se debe reemplazar con la Guía de Agujas hecha para usar con el YC-1.

2. BASIC KNITTING

After the setting of the YC-1 is completed, knitting can begin using four yarns in a Double Rib hooped pattern. (The following is an example of knitting in Double Rib using four different coloured yarns.)

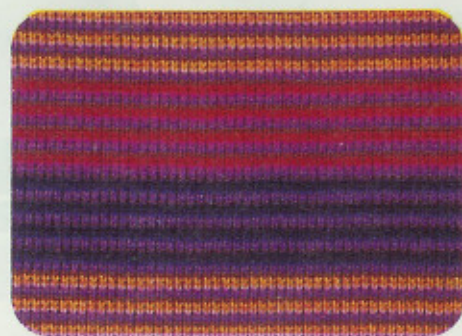

1. Insert the Close Knit Bar between the main machine Sinker Posts and the front edge of the needle bed. (Refer to "How to Use Close Knit Bar" in the Ribbing Attachment Instruction Book.) Set the Pile Levers to the Up position, the Half-Pitch Lever to H and the Swing Indicator to 5. Using the Needle Pusher, push the same number of needles on both the main machine and the ribber to B position.

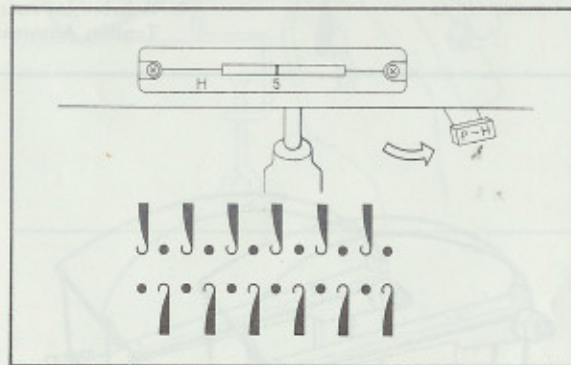

2. Set both Carriages as illustrated on the right and the L Knob to S. (Note: Disregard the above instruction concerning the L Knob if your knitting machine does not have an L Knob installed.)

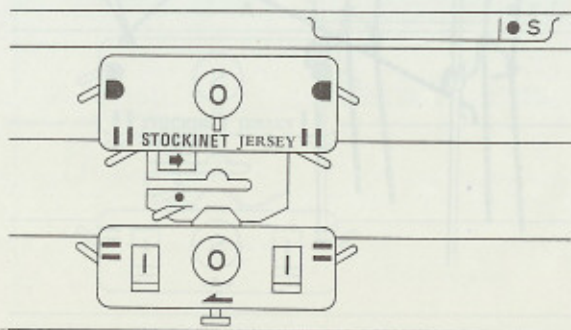

2. TEJIDO BASICO

Después que haya completado la instalación del YC-1, puede comenzar a tejer usando cuatro hilos en un diseño rayado de punto Resorte Doble. (La muestra es un ejemplo de tejido en punto de Resorte Doble usando cuatro hilos de colores diferentes.)

1. Inserte la Barra de Enmallada Apretada entre los Postes de la máquina principal y el borde fronterero de la cama de agujas. (Refiérase a "Cómo colocar la barra de enmallada apretada" en el Libro de Instrucciones de la Máquina Auxiliar.) Ajuste la Palanca de Afelpado en la Posición arriba, la Palanca de Medio Paso en H y el Indicador de Oscilación en 5. Usando el Selector de Agujas, empuje el mismo número de agujas en ambos lados de la máquina principal y la auxiliar a la posición B.

2. Ajuste ambos carros como se muestra en el diagrama izquierdo, y la Perilla L en S. (Nota: Desdeñe esta instrucción con respecto a la Perilla L, si su máquina de tejer no tiene la Perilla L.)

NOTE:
The second Auto-Tension Unit is not applied with the YC-1 but is an optional purchase.

3. With the Driving Lever on the Ribber Arm in an inactive position, align the needles in B position by moving the Carriage several times across the needle bed, ending with it on the right side.

- * When the Driving Lever should be in an active position, raise it with your finger. (In Operation Table, ↑ indicates active position.)
- * When you must rest the Driving Lever, slightly pull it upwards with your fingers and then lay it downwards. (In Operation Table, ➡ indicates inactive position.)

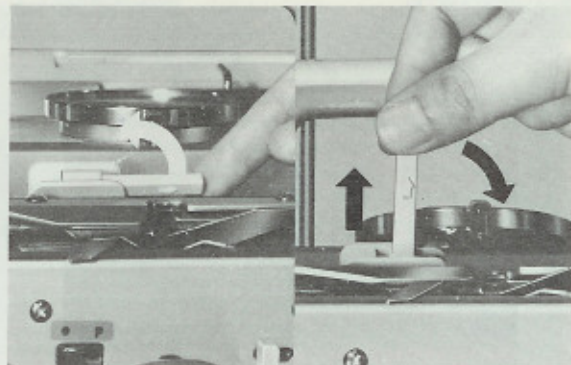

3. Manteniendo la Leva Motriz del Brazo de la Auxiliar en la posición inactiva, alinee las agujas en la posición B pasando el Carro unas veces sobre la cama de agujas, dejándolo ultimamente en el lado derecho.

- * Cuando la Leva Motriz debe estar en la posición activa, levántela con el dedo. (En la Tabla de Operaciones, ↑ indica la posición activa.)
- * Cuando usted tiene que descansar la Leva Motriz, halela ligeramente hacia arriba con el dedo y luego inclínela hacia abajo. (En la Tabla de Operaciones, ➡ indica la posición de descanso.)

4. Thread four different coloured yarns through the two Auto-Tension Units.

4. Enhebre los cuatro hilos de colores diferentes por entre los dos Conjuntos de Tensión Automática.

After threading the respective yarns correctly, take note of the following in order to knit smoothly:—

- * The yarns are lettered A, B, C and D colours respectively from left to right.
- * Colour A should be rested in the Yarn Clip of the left Yarn Rod and colours B, C and D should be tied together as illustrated on the right.
- * When you use only two yarns, use the letters A and B to identify them.
- * The Tension Dials should be increased by one number compared with the numbers used for knitting with the main machine only. (Example: Main Machine only; Tension Dial 4. When using the YC-1; Tension Dial 5.)

NOTE:

The second Auto-Tension Unit is not supplied with the YC-1 but is an optional purchase.

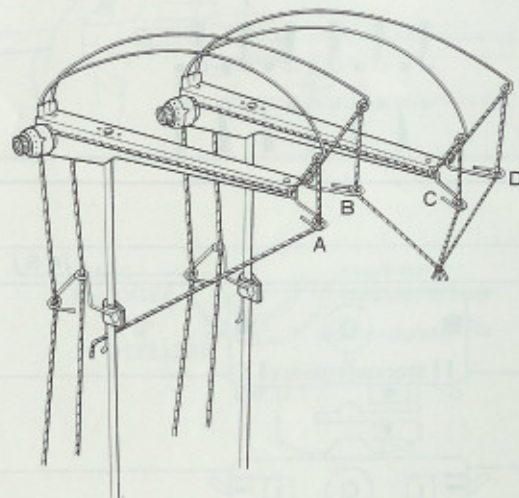

Después de enhebrar los hilos respectivos correctamente, tome nota del siguiente para tejer suavemente:—

- * Los hilos son marcados con letras de A, B, C y D respectivamente del izquierdo al derecho.
- * Color A se debe descansar en el Retensor de hilo de la Varilla y colores B, C y D se deben amarrar juntos como son ilustrados en la izquierda.
- * Cuando usted usa sólo dos colores, use las letras A y B para identificarlos.
- * El Disco de Tensión se debe aumentar en un número con relación al número que se usa al tejer sólo en la máquina principal. (Ejemplo: Sólo Máquina Principal; Disco de Tensión 4. Al usar el YC-1; Disco de Tensión 5.)

NOTA:

La segunda Tensión Automática no está incluido en el YC-1 sin embargo se puede comprar como accesorio adicional.

- To thread the yarn, release the Ribber Carriage, pull it slightly towards you and move it to the left side of the needle bed. The Cam Lever on the main machine Carriage should be turned to Slip. Next, bring colour A from the Yarn Clip, make a loop at the free end of the yarn and move it to above the Yarn Feeder. From underneath, extend the Hook Tool through the Yarn Feeder. Catch the yarn loop with the Hook Tool and pull the yarn down through the Yarn Feeder.
- Holding the yarn in your hand, move the Carriage from right to left across the needle bed. (Note: The yarn will not be knitted.)
- Re-connect the Ribber Carriage to the Arm and re-set the Cam Lever of the main machine to Stockinet. Still holding the yarn in your hand, knit one row from left to right, afterwards you can release the yarn.
- Cast-on in the same manner as that instructed in the Ribbing Attachment Instruction Book, finishing with the Carriage on the left side of the needle bed.

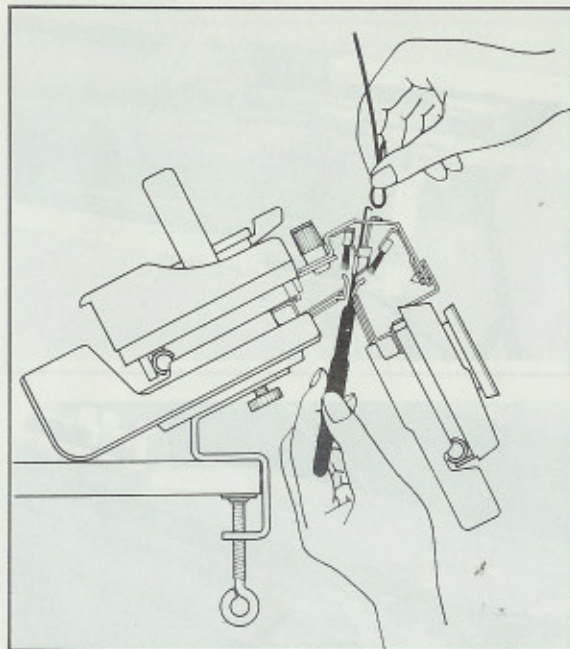

- Para enhebrar el hilo, desuna el Carro de la máquina auxiliar, inclínelo ligeramente hacia usted y muévalo en el lado izquierdo de la cama de agujas. La Palanca de Leva del Carro de la máquina principal se debe girar a Deslizar. Luego, saque el color A del Retensor de Hilo, haga un lacito con el cabo libre del hilo y déjelo caer sobre el Alimentador. Desde abajo, extienda el Enganchador de Puntos por entre el Alimentador. Agarre el lacito del hilo con el Enganchador y halelo hacia abajo por entre el Alimentador.
- Sujetando el hilo con su mano, mueva el Carro de la derecha y a la izquierda en la cama. (Nota: el hilo no se tejerá.)
- Vuelva a unir el Carro de la auxiliar con el Brazo y reajuste la Palanca de Leva de la máquina principal en Jersey. Siga sujetando el hilo con su mano, teja una carrera de la izquierda a la derecha, luego usted puede dejar el cabo de hilo.
- Enmalle en la misma manera como se ha instruido en "Remate de Puntos Acanalados" en el Libro de Instrucciones de la Máquina Auxiliar, colocando ultimamente el Carro en el lado izquierdo de la cama de agujas.

- Set both Carriages as shown in the diagram on the right and knit one row from left to right. Afterwards raise the Driving Lever to an active position (↑ mark).

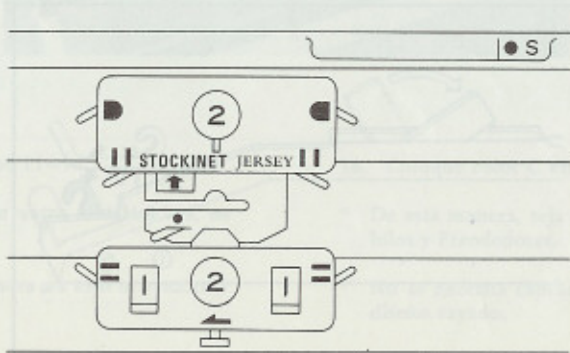

- Ajuste los controles reguladores de ambos carros como se muestra en el diagrama, y teja una carrera de la izquierda a la derecha. Después, levante la Leva Motriz hacia la posición activa (marca de ↑).

10. Bring the three resting yarns, B, C and D to the left side of the working needles and from underneath, extend the Hook Tool between the Sinker Posts of both needle beds. Catch the three tied yarns above the knot and pull them down between both needle beds. Afterwards, tie the yarns end around a Ribber Weight.

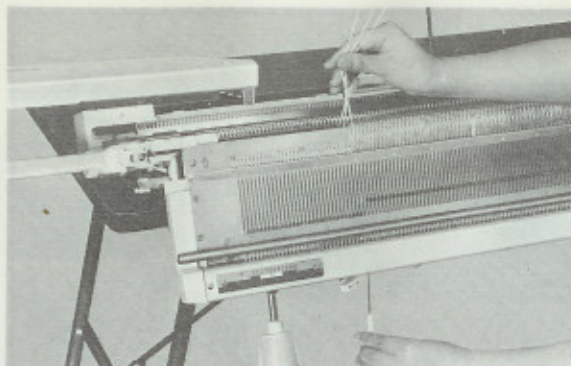

11. Take hold of yarns C and D with your hand, pull them slightly towards you and move them around to and place them into Holder ① of the YC-1.

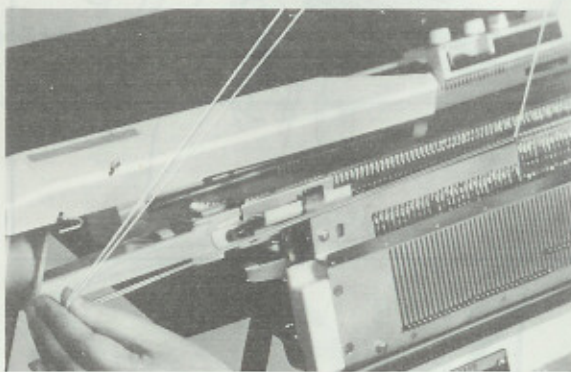

12. Arrange the Holder ① so that it is in a forward position, as shown in the diagram opposite, by pushing the Feeding Lever. (If the Holder ① is already in a forward position, this instruction may be ignored.)

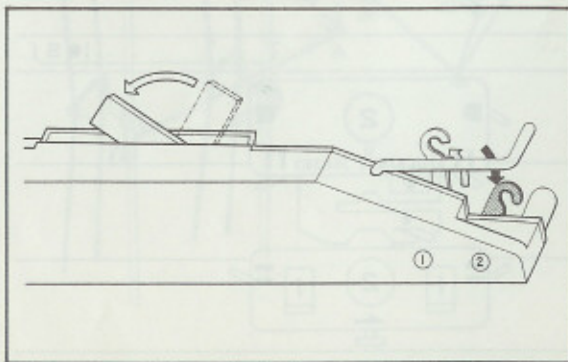

10. Lleve los tres hilos anudados, B, C y D hacia el lado izquierdo de las agujas que están trabajando y desde abajo, extienda el Enganchador de Puntos entre los postes de ambas camas de agujas. Agarre el nudo de los hilos y tire de él hacia abajo a través del espacio entre los dos postes. Luego, amárrelos alrededor de una pesa de la auxiliar.

11. Tome los hilos C y D con su mano, halelos ligeramente hacia usted y colóquelos en el Prendedor ① del YC-1.

12. Arregle el Prendedor ① de modo que se coloque en la posición exterior como se muestra en el diagrama, empujando la Leva de Alimentación. (Si el Prendedor ① ya está siendo puesto en la posición exterior, esta instrucción se puede ignorar.) El Prendedor ② (de color negro) estará en la posición interior.

13. Take colour B to the left side and place it into the hook of Holder ②.

14. Move the Carriage to the left side of the needle bed until you hear a clicking sound, made by the Feeding Lever, and see the yarns changing in Holders ① and ②. Continue knitting in this way, the required number of rows and then move the Carriage to the right side of the needle bed. (Colour A and B are knitted alternately every two rows.)

* For the first row only, hold colour B with your hand to remove the yarn slack.

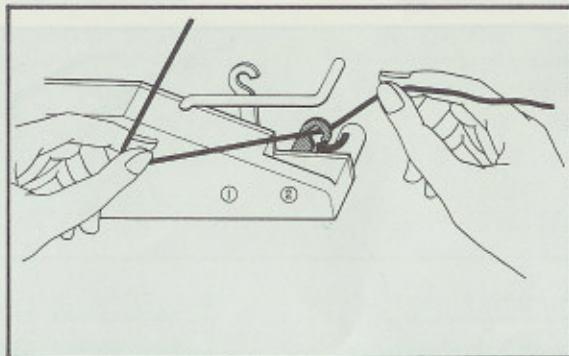

13. Lleve color B hacia el lado izquierdo y colóquelo en el gancho del Prendedor ②.

14. Mueva el Carro hacia el lado izquierdo de la cama de agujas hasta que usted oiga un sonido de "click" que será hecho por la Leva de Alimentación, y pueda ver que los hilos se cambiarán en los Prendedores ① y ②. Continúe tejiendo en esta manera el número requerido de carreras y entonces mueva el Carro hacia la derecha sobre la cama de agujas. (Color A y B se tejen alternativamente cada dos carreras.)

* Solamente para la primera carrera, sostenga el hilo de color B con su mano para quitar la flojedad de hilo.

15. When exchanging colour C for either A or B, remove all yarns from Holders ①, ② and ③.

* In the case of exchanging colour B for colour C remove all yarns from the Holders. As colour A is in the Yarn Feeder, move the Carriage to the right side of the needle bed.

* In the case of exchanging colour A for colour C, remove all yarns from the Holders. As colour B is in the Yarn Feeder, move the Carriage to the right side of the needle bed.

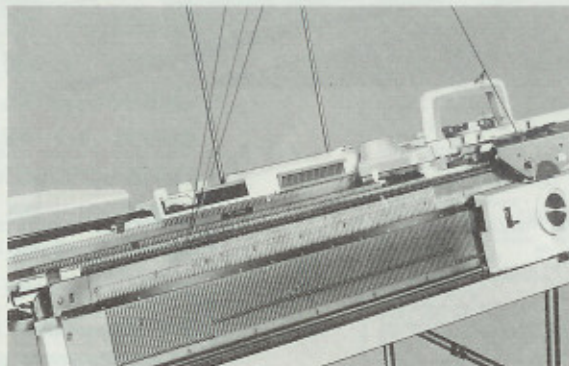

15. Para cambiar color C con color A ó B, quite todos los hilos de los Prendedores ①, ② y ③.

* En el caso de cambiar color B con color C, mueva el carro hacia la derecha cuando el color A esté en el Alimentador, y quite los hilos desde los Prendedores respectivos.

* En el caso de cambiar color A con color C, mueva el carro hacia la derecha de la cama de agujas cuando el color B esté en el Alimentador, y quite los hilos desde los Prendedores respectivos.

16. Place colour C into Holder ②, following the procedure of 11–14.

* Knit the Double Rib hooped pattern making use of the yarns and Holders, as mentioned above.

* There is no need to change yarns manually when two colours are knit in a hooped pattern.

16. Coloque color C en el Prendedor ②, siguiendo el procedimiento de 11–14.

* De esta manera, teja el diseño rayado en Punto Resorte Doble haciendo uso de los hilos y Prendedores.

* No se necesita cambiar hilos manualmente cuando se tejen sólo dos colores en un diseño rayado.

Correct Method for Changing Yarns

Método Correcto para Cambiar Hilos

Please note the following:—

- * When exchanging automatically changed yarns with the rested yarns, the Carriage must be on the right side of the needle bed.
- * When changing yarns, remove all yarns from the Holders.
- * The yarns to be placed in Holder ① must be on top of the other yarns to prevent entanglement while knitting. (The yarns placed in Holder ② are rested yarns.)
- * The yarn to be placed in Holder ① is the yarn on the left, which is automatically changed by Carriage movement.
- * The yarn to be placed in Holder ② is the yarn on the right side which, too, is automatically changed by Carriage movement.
- * For the first row of knitting only, after manually changing the yarns, yarn slack must be eliminated by holding the yarn with your hand.

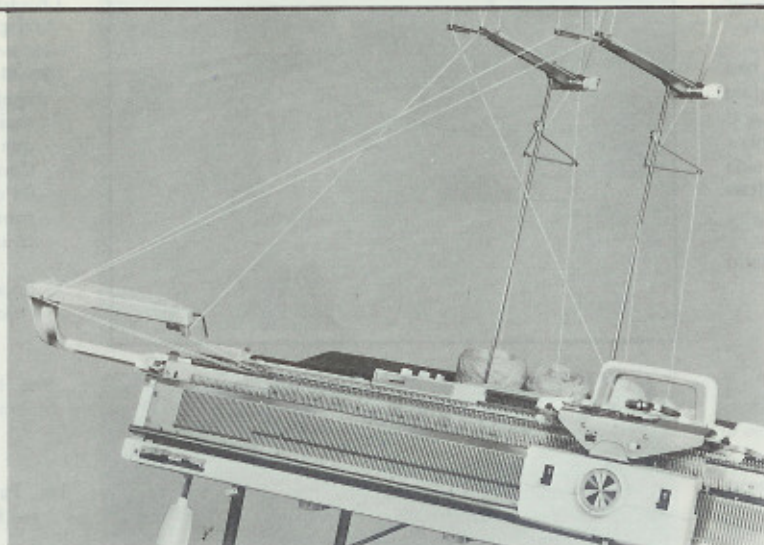

Por favor anote el siguiente:—

- * Al cambiar hilos que ahora se están tejiendo cambiando automáticamente, con los que están en descanso, el Carro se debe colocar en el lado derecho de la cama de agujas.
- * Al cambiar hilos, primero quite todos los hilos de los Prendedores.
- * Los hilos que se deben colocar en el Prendedor ① tienen que ser puestos de tal manera que se posicionen encima de los otros para evitar enredo de hilos mientras teje. (Los hilos colocados en el Prendedor ② son hilos en descanso.)
- * El hilo que se debe colocar en el Prendedor ① es el hilo izquierdo de los dos hilos que van a trabajar cambiando automáticamente por el movimiento del Carro.
- * El hilo que se debe colocar en el Prendedor ② es el hilo derecho, el cual también se cambia automáticamente por el movimiento del carro.
- * Solamente en la primera carrera de tejido, después que haya cambiado los hilos manualmente, elimine la flojedad de hilo tirando de él ligeramente hacia arriba con su mano.

3. PATTERN KNITTING

In addition to Punch Pile Ribbing and Drive Lace, which are possible by using the Ribber's Punch Cards, you are also able to knit Double Jacquard and Point Knitting in Double Jacquard using the YC-1.

How to Make and Check a Punch Card

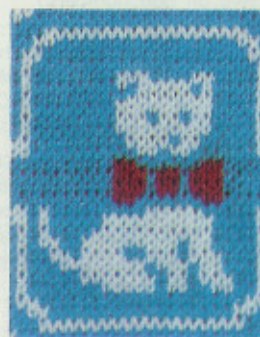
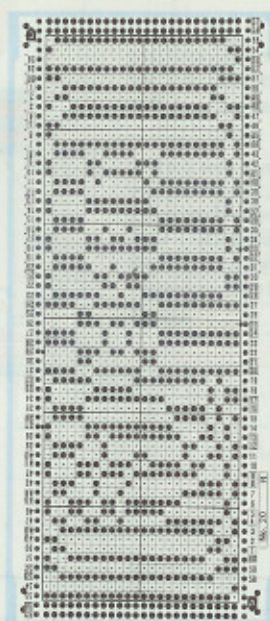
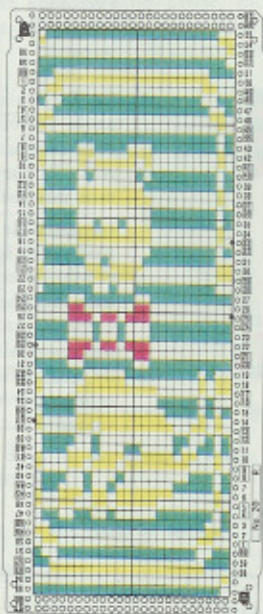
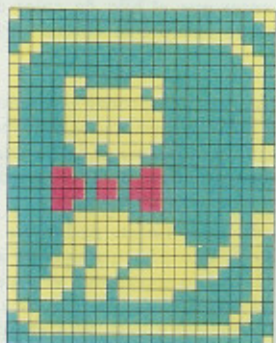

* The Punch Card that is to knit a Double Jacquard pattern is differently punched than other cards. A pattern must be drawn on graph paper to fill 30 rows. (This is because the main yarn and a second yarn are knitted every-other row, making a pattern 60 rows in length.) The Punch Card must be punched to enable the main and the secondary yarns to be knitted every-other row, therefore making 60 rows for the pattern.

* Draw the pattern on squared graph paper. You are recommended to use the 3 mm. squared graph paper.

* When you use the Knit Contour with the Ribbing Attachemnt, take a tension gauge on the BACK of the fabric.

* When making a Punch Card, please follow the above pictured directions.

3. TEJIDO DE DISENOS

Además de Puntos Afelpados y Encalados, los cuales son logrados usando las Tarjetas Perforadas pertenecientes a la Auxiliar, usted también puede tejer Puntos de Jacquard Doble y Motivo Individual en Puntos de Jacquard Doble usando el YC-1.

Cómo Perforar diseño en una Tarjeta y Comprobarlo

* La Tarjeta Perforada para tejer un diseño en Puntos de Jacquard Doble se perfora diferente que otras. Dibuje un diseño en un papel cuadrículado hasta llenar 30 carreras. (Esto es porque el hilo principal y el de color contraste son tejidos en cada dos carreras.) La Tarjeta se debe perforar de tal manera que se puedan tejer el hilo principal y de contraste alternativamente en cada dos carreras, por lo tanto se perforan 60 carreras en la Tarjeta para realizar un diseño de 30 cuadrículas de largo en el papel.

* Dibuje el diseño en un papel cuadrículado. Es recomendable usar papel cuadrículado de 3 mm.

* Cuando usted usa el Knit Contorno (Knit Radar) con la Máquina Auxiliar, cuente el Calibre de tejido en el REVERSO del tejido.

* Al perforar una tarjeta, por favor siga las flechas en el diagrama de arriba.

- * The indicated row numbers, on the Punch Card, that will knit Double Jacquard must be divided into rectangles on the Punch Card. (See the diagrams on the right.)

The rectangled numbers mean that the rows are knitted by the main yarn.

The numbers not rectangled will be knitted by another yarn.

- * The place for changing yarn is marked with a dot. In the case of automatically changing yarns, using the YC-1, the yarn must be changed one row before the newly changed yarn is to be knitted. The dot mark must be drawn on the Punch Card one row before the different coloured yarn is to be knitted. (The dot mark is always drawn on odd numbers.)

- * The Check Card is used to check the pattern on the Punch Card and to find any wrongly punched hole. To check the Punch Card lay the Punch Card on top of the Check Card, making sure that the sides and bottom edges fit exactly.

The orange coloured part on the Check Card shows the part to be knitted by the main yarn and the blue colour, the secondary yarn. The pattern on the graph paper has been doubled to make two rows, one for the main yarn and one for the secondary yarn alternately. The Punch Card has a width of 24 holes which covers both the rows to be knitted by the main yarn and the secondary yarn alternately.

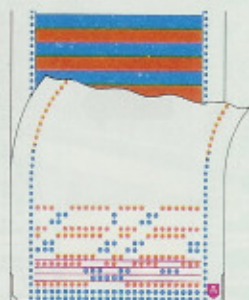
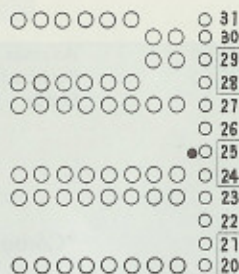

- * Los números de carreras se marcan con rectángulos en cada dos carreras.

Los números en rectángulos indican que las carreras se tejen por el hilo principal.

Los números sin rectángulos se tejerán por el hilo de color diferente.

- * La parte donde se cambian hilos manualmente es marcada con un punto en la Tarjeta Perforada. En el caso de cambiar hilos automáticamente usando el YC-1, el hilo se debe cambiar manualmente en una carrera antes que el hilo cambiado nuevamente debe tejer. Es decir, la marca de un punto se debe colocar en la Tarjeta Perforada en una carrera antes que el hilo de color diferente se tejerá. (La marca de un punto siempre se coloca en un número impar.)

- * La Tarjeta de Prueba se usa para comprobar el diseño perforado en la Tarjeta y para hallar orificios perforados equivocadamente. Para comprobar la Tarjeta Perforada, ponga la Tarjeta Perforada sobre la Tarjeta de Prueba asegurándose de que los lados y extremos inferiores se coincidan exactamente.

La parte de color anaranjado en la Tarjeta de Prueba le indica la parte que se debe tejer por el hilo principal y la de azul es para el hilo de color diferente. El diseño trazado en el papel cuadrulado se copia doblando el largo en la Tarjeta para hacer dos carreras, una para el hilo principal y otra para el hilo de color diferente alternativamente. La Tarjeta Perforada tiene un ancho de 24 orificios perforados que cubre ambas carreras que serán tejidas por el hilo principal y el hilo de color diferente alternativamente.

Recommended Stitch Dial Numbers for Yarn Thicknesses to be knitted in Double Jacquard

- * The bound-off Cast-on is made in the same way as that for Double Rib Knitting.

- * Set the Stitch Dial Number exactly the same for Double Jacquard as for Point Knitting.

Carriage Carro	Yarn Hilo	Thin Yarn Hilo Fino	Light Yarn Hilo Liviano
	Ribber M. Auxiliar		2-3
Main Machine M. Principal		2-3	3-5

Números Recomendables de los Discos de Tensión según el grueso de hilo que se teje en Puntos de Jacquard Doble

- * El ribete rematado es hecho en la misma manera como para hacer el ribete de Tejido en Resorte Doble.

- * Ajuste el número del Disco de Tensión exactamente en el mismo número para Jacquard Doble como para Motivo Individual.

How to follow the Operation Table

The operation is divided into two sections, Order ① and Order ②. Order ① is a preparatory step for memorizing the pattern on the memory bank. Actual pattern knitting begins from Order ②.

The Card Memory Numbers. The □, ○ marks indicate that the MAIN YARN is knitted and no mark, the secondary yarn.

These columns indicate the yarns to be placed in the YC-1 Holders. (The letters within the circle correspond to the yarns that should be placed in the Yarn Feeder.)

The Driving Lever, on the Ribber Arm, should be positioned according to this column.

OR- DER	CARD MEM.	YC-1			MAIN MACHINE			RIBBER			DIR.
		HOL. ①	HOL. ②	HOL. ③	CAM LEV.	SIDE LEV.	STP. KNB	SET LEV.	DRV. LEV.		
Bound-off Cast-on											≡ 4
①	1	Ⓐ	Ⓑ		STOCK	▲▲●	①①	→	→	→	
②	1				SLIP	▼	▲	↑	←	←	
	2	Ⓐ	Ⓑ			▼	▲		→	→	
	3					▼	▲		←	←	
	4	Ⓐ	Ⓑ			▼	▲		→	→	
	↓								≡ *	Repeat order ②	

Direction of Carriage and No. of rows.

For use when more than 3 yarns are knitted. Place the indicated yarn in the Holder ③.

* Unless otherwise specified in the operation table, set the parts as follows:—

Main Machine:

Russel Levers II (both)
L. Knob S

Ribber:

Pick Knob ▲
Russel Levers ≡ (both)
Swing Indicator 5
Half-Pitch Lever H
Pile Levers Up (both)
Aux. Yarn Feeder Lever ... ●
Close Knit Bar in use

Cómo Interpretar la Tabla de Operaciones

La Tabla de Operaciones esta dividida en dos secciones: la línea ① y la línea ②. La línea ① es para el comienzo de tejer con ribete rematado y el paso preparatorio para grabar el diseño en la Tarjeta en los Tambores de memoria. El tejido de diseño comienza a partir de la línea ②.

Los Números de Memoria de la Tarjeta. Las marcas □, ○ indican que el hilo principal se teje y, sin marcas, el hilo de color contrastante.

Estas columnas indican los hilos para colocar en los tres Prendedores YC-1 respectivamente. (Las letras en el círculo corresponden a los hilos que se enhebrarán en el Alimentador.)

*P.
LTR. = PALANCAS LATERALES
*PER.
PDA. = PERILLA PARADA

La Leva Motriz del Brazo de la Auxiliar se debe posicionar conforme a esta columna.

OR- DEN	MEM. TARJ	YC-1 PRENDEDORES			M. PRINCIPAL			M. AUXILIAR		DIR.	
		①	②	③	P. DE LEVA	* P. LTR.	* PER. PDA.	P. DE AJUSTE	LEVA MOTRIZ		
Enmallar con ribete rematado											≡ 4
①	1	Ⓐ	Ⓑ		JER.	▲▲●	①①	→	→	→	
②	1				DESLI.	▼	▲	↑	←	←	
	2	Ⓐ	Ⓑ			▼	▲		→	→	
	3					▼	▲		←	←	
	4	Ⓐ	Ⓑ			▼	▲		→	→	
	↓								≡ *	Repita la línea ②.	

Dirección del Carro y Número de Carreas.

Use cuando se tejen más de 3 hilos. Coloque el hilo indicado en el Prendedor ③.

* Si no están especificados en la tabla de operaciones, ajuste cada parte como sigue:—

Máquina Principal

Levas Russel II (ambas)
Perilla L S

Máquina Auxiliar

Palanca de Recogido ▲
Levas Russel ≡ (ambas)
Indicador de Oscilación 5
Palanca de Medio Paso H
Palanca de Afelpado arriba
(ambas)

Leva del Alimentador
Auxiliar ●
Barra de Enmallada
Apretada en uso

1 DOUBLE JACQUARD.

This type of knitting is the same as knit-in (but without the floating of yarn on the back side of the fabric) using more than two yarns, each knitting two rows alternately. The front side of the fabric which faces the main machine, is knitted in a Slip Stitch and the back of the fabric, facing the ribber, is knitted in rib stitch.

* Use two different coloured light yarns.

Recommended Stitch Dial numbers:—

Main Machine — 4
Ribber — 4

OR- DER	CARD MEM.	YC-1			MAIN MACHINE			RIBBER		DIR.
		HOL. ①	HOL. ②	HOL. ③	CAM LEV.	SIDE LEV.	STP. KNB.	SET LEV.	DRV. LEV.	
Bound-off Cast-on										≡ 4
①	(1)	(A)	B		STOCK	▲▲●	①①	→	—	
②	(1)	*	*		SLIP	*	▲	*	↑	—
	2	A	(B)		*	*	*	*	—	
	3	*	*		*	*	*	*	—	
	(4)	(A)	B		*	*	*	*	—	
	↓								≡*	

(1) Thread colour A into the Yarn Feeder, and make the bound-off cast-on for Double Rib knitting. (Refer to Ribbing Attachment Instruction Book.)

(2) Insert Punch Card No. 11R, in the A direction, into the Centre Panel Unit.

(3) Set the Carriage and Stop Knob etc. according to Order ① of the operation table and knit one row, with colour A, from left to right. (This one row of rib knitting memorizes the pattern in the memory bank.)

(4) Place colour B into the YC-1 Holder ② and wind the end of the yarn to a Ribber Weight.

(5) Set the Carriage according to Order ② of the operation table and continue to knit.

NO. 11R—A DOUBLE JACQUARD (1) JACQUARD DOBLE (1)



A = Pink
Rosa
B = Mauve
Malva

1 Pat. = 24 sts., 56 rows.
1 Diseño = 24 pts., 56 cras.

1 JACQUARD DOBLE.

Este tipo de tejido es el mismo que Entretejido, (pero sin flotar el hilo en el reverso del tejido) usando más de dos hilos, se teje cambiando hilos en cada dos carreras alternativamente. La cara del tejido que se afronta con la máquina principal, es tejido en Punto Deslizado y el lado revés del tejido, afrontándose con la auxiliar, es tejido en punto resorte (elástico).

* Use dos hilos livianos de colores diferentes.

Números recomendables de Discos de Tensión:—

Máquina Principal — 4
Auxiliar — 4

OR- DEN	MEM. TARJ.	YC-1 PRENDEDORES			M. PRINCIPAL			M. AUXILIAR		DIR.
		①	②	③	P. DE LEVA	P. LTR.	PER. PDA.	P. DE AJUSTE	LEVA MOTRIZ	
Enmallar con ribete rematado										≡ 4
①	(1)	(A)	B		JER.	▲▲●	①①	→	—	
②	(1)	*	*		DESLI.	*	▲	*	↑	—
	2	A	(B)		*	*	*	*	—	
	3	*	*		*	*	*	*	—	
	(4)	(A)	B		*	*	*	*	—	
	↓								≡*	

(1) Enhebre color A en el Alimentador, y teja 4 carreras para hacer enmallada con ribete rematado siguiendo el mismo procedimiento para el "Comienzo" de Tejido en Resorte Doble. (Refiérase a "COMIENZO (ENMALLADA) Y REMATE" en el Libro de Instrucciones de la Máquina Auxiliar.)

(2) Inserte la Tarjeta Perforada No. 11R dentro del tablero de diseños con la marca A apuntando hacia la parte inferior del lado derecho.

(3) Ajuste las Palancas y la Perilla de Parada etc. de los carros de acuerdo con la línea ① de la tabla de operaciones y teja una carrera, con color A, desde la izquierda a la derecha. (En esta carrera primera tejida en punto resorte, se graba el diseño en el Tambor de memoria.)

(4) Coloque color B en el Prendedor ② del YC-1 y enrolle el cabo del hilo alrededor de una Pesa de la Auxiliar.

(5) Ajuste los controles reguladores de los carros de acuerdo con la línea ② de la tabla de operaciones y continúe tejiendo.

* The following patterns are knitted in the same manner.

* Los diseños siguientes se tejen en la misma forma.

NO. 12R-A DOUBLE JACQUARD (2)
JACQUARD DOBLE (2)

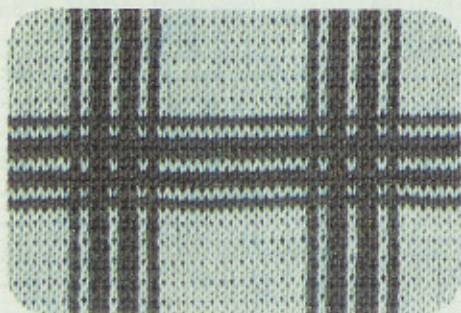

A = Light Green
Verde Claro
1 Pat. = 24 sts., 60 rows.
1 Diseño = 24 pts., 60 cras.
B = Dark Green
Verde Oscuro

NO. 13R-A DOUBLE JACQUARD (3)
JACQUARD DOBLE (3)



A = Mustard
Mostaza
1 Pat. = 24 sts., 20 rows.
1 Diseño = 24 pts., 20 cras.
B = Red
Rojo

NO. 14R-A DOUBLE JACQUARD (4)
JACQUARD DOBLE (4)



A = Dark Green
Verde Oscuro
1 Pat. = 24 sts., 60 rows.
1 Diseño = 24 pts., 60 cras.
B = Yellow
Amarillo

NO. 15R-A DOUBLE JACQUARD (5)
JACQUARD DOBLE (5)

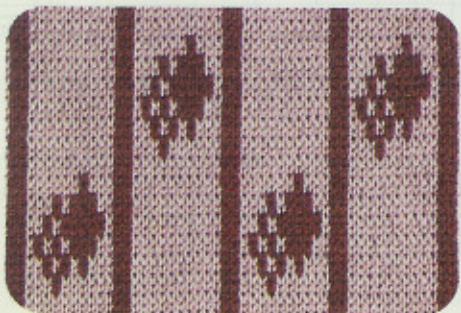

A = Light Brown
Castaño Claro
1 Pat. = 24 sts., 60 rows.
1 Diseño = 24 pts., 60 cras.
B = Dark Brown
Castaño Oscuro

NO. 16R-A DOUBLE JACQUARD (6)
JACQUARD DOBLE (6)



A = Beige
Beige
1 Pat. = 24 sts., 60 rows.
1 Diseño = 24 pts., 60 cras.
B = Brown
Castaño

NO. 17R-A DOUBLE JACQUARD (7)
JACQUARD DOBLE (7)



A = Grey
Gris
1 Pat. = 24 sts., 56 rows.
1 Diseño = 24 pts., 56 cras.
B = Navy Blue
Azul Marino

DOUBLE JACQUARD.

JACQUARD TRIPLE.

DOUBLE JACQUARD (8)
JACQUARD DOBLE (8)

NO. 18R-A



A = Blue
Azul
B = White
Blanco
C = Red
Rojo
D = Yellow
Amarillo

1 Pat. = 24 sts., 60 rows.
1 Diseño = 24 pts., 60 cras.

OR- DER	CARD MEM.	YC-1			MAIN MACHINE			RIBBER		DIR.	
		HOL. ①	HOL. ②	HOL. ③	CAM LEV.	SIDE LEV.	STP KNB	SET LEV.	DRV. LEV.		
①		Bound-off		Cast-on						4	
		①	②	③	STOCK	▲▲●	①①	→			
②		①	"	"	SLIP	"▲"	"	↑			
		Colours A and B are knitted alternately every two rows.									2
		①②	③	④	"	"	"	"	"		
		①	"	"	"	"	"	"	"		
		Colours A and C are knitted alternately every two rows.									8
		②③	④	⑤	"	"	"	"	"		
		②④	⑤	⑥	"	"	"	"	"		
		Colours A and B are knitted alternately every two rows.									24
		④⑤	⑥	⑦	"	"	"	"	"		
		④⑥	⑦	⑧	"	"	"	"	"		
		Colours A and D are knitted alternately every two rows.									8
		⑤⑧	⑦	⑧	"	"	"	"	"		
		⑤⑦	⑧	⑨	"	"	"	"	"		
		Colours A and B are knitted alternately every two rows.									8
		⑥⑨	⑧	⑨	"	"	"	"	"		
		⑥⑧	⑨	⑩	"	"	"	"	"		
		Colours A and B are knitted alternately every two rows.									8
		⑦⑩	⑨	⑩	"	"	"	"	"		
		⑦⑨	⑩	⑪	"	"	"	"	"		
		Colours A and B are knitted alternately every two rows.									8
		⑧⑪	⑩	⑪	"	"	"	"	"		
		⑧⑩	⑪	⑫	"	"	"	"	"		
		Colours A and B are knitted alternately every two rows.									8
		⑨⑫	⑪	⑫	"	"	"	"	"		
		⑨⑪	⑫	⑬	"	"	"	"	"		
		Colours A and B are knitted alternately every two rows.									8
		⑩⑬	⑫	⑬	"	"	"	"	"		
		⑩⑫	⑬	⑭	"	"	"	"	"		
		Colours A and B are knitted alternately every two rows.									8
		⑪⑭	⑬	⑭	"	"	"	"	"		
		⑪⑫	⑭	⑮	"	"	"	"	"		
		Colours A and B are knitted alternately every two rows.									8
		⑫⑮	⑭	⑮	"	"	"	"	"		
		⑫⑫	⑮	⑯	"	"	"	"	"		
		Colours A and B are knitted alternately every two rows.									8
		⑬⑯	⑮	⑯	"	"	"	"	"		
		⑬⑫	⑯	⑰	"	"	"	"	"		
		Colours A and B are knitted alternately every two rows.									8
		⑭⑰	⑮	⑰	"	"	"	"	"		
		⑭⑫	⑰	⑱	"	"	"	"	"		
		Colours A and B are knitted alternately every two rows.									8
		⑮⑱	⑮	⑱	"	"	"	"	"		
		⑮⑫	⑱	⑲	"	"	"	"	"		
		Colours A and B are knitted alternately every two rows.									8
		⑯⑲	⑮	⑲	"	"	"	"	"		
		⑯⑫	⑲	⑳	"	"	"	"	"		
		Colours A and B are knitted alternately every two rows.									8
		⑰⑳	⑮	⑲	"	"	"	"	"		
		⑰⑫	⑲	㉑	"	"	"	"	"		
		Colours A and B are knitted alternately every two rows.									8
		⑱㉑	⑮	⑲	"	"	"	"	"		
		⑱⑫	⑲	㉒	"	"	"	"	"		
		Colours A and B are knitted alternately every two rows.									8
		⑲㉒	⑮	⑲	"	"	"	"	"		
		⑲⑫	⑲	㉓	"	"	"	"	"		
		Colours A and B are knitted alternately every two rows.									8
		⑳㉓	⑮	⑲	"	"	"	"	"		
		⑳⑫	⑲	㉔	"	"	"	"	"		
		Colours A and B are knitted alternately every two rows.									8
		㉑㉔	⑮	⑲	"	"	"	"	"		
		㉑⑫	⑲	㉕	"	"	"	"	"		
		Colours A and B are knitted alternately every two rows.									8
		㉒㉕	⑮	⑲	"	"	"	"	"		
		㉒⑫	⑲	㉖	"	"	"	"	"		
		Colours A and B are knitted alternately every two rows.									8
		㉓㉖	⑮	⑲	"	"	"	"	"		
		㉓⑫	⑲	㉗	"	"	"	"	"		
		Colours A and B are knitted alternately every two rows.									8
		㉔㉗	⑮	⑲	"	"	"	"	"		
		㉔⑫	⑲	㉘	"	"	"	"	"		
		Colours A and B are knitted alternately every two rows.									8
		㉕㉘	⑮	⑲	"	"	"	"	"		
		㉕⑫	⑲	㉙	"	"	"	"	"		
		Colours A and B are knitted alternately every two rows.									8
		㉖㉙	⑮	⑲	"	"	"	"	"		
		㉖⑫	⑲	㉚	"	"	"	"	"		
		Colours A and B are knitted alternately every two rows.									8
		㉗㉚	⑮	⑲	"	"	"	"	"		
		㉗⑫	⑲	㉛	"	"	"	"	"		
		Colours A and B are knitted alternately every two rows.									8
		㉘㉛	⑮	⑲	"	"	"	"	"		
		㉘⑫	⑲	㉜	"	"	"	"	"		
		Colours A and B are knitted alternately every two rows.									8
		㉙㉜	⑮	⑲	"	"	"	"	"		
		㉙⑫	⑲	㉝	"	"	"	"	"		
		Colours A and B are knitted alternately every two rows.									8
		㉚㉝	⑮	⑲	"	"	"	"	"		
		㉚⑫	⑲	㉞	"	"	"	"	"		
		Colours A and B are knitted alternately every two rows.									8
		㉛㉞	⑮	⑲	"	"	"	"	"		
		㉛⑫	⑲	㉟	"	"	"	"	"		
		Colours A and B are knitted alternately every two rows.									8
		㉜㉟	⑮	⑲	"	"	"	"	"		
		㉜⑫	⑲	㊱	"	"	"	"	"		
		Colours A and B are knitted alternately every two rows.									8
		㉝㊱	⑮	⑲	"	"	"	"	"		
		㉝⑫	⑲	㊲	"	"	"	"	"		
		Colours A and B are knitted alternately every two rows.									8
		㉞㊲	⑮	⑲	"	"	"	"	"		
		㉞⑫	⑲	㊳	"	"	"	"	"		
		Colours A and B are knitted alternately every two rows.									8
		㉟㊳	⑮	⑲	"	"	"	"	"		
		㉟⑫	⑲	㊴	"	"	"	"	"		
		Colours A and B are knitted alternately every two rows.									8
		㊱㊴	⑮	⑲	"	"	"	"	"		
		㊱⑫	⑲	㊵	"	"	"	"	"		
		Colours A and B are knitted alternately every two rows.									8
		㊲㊵	⑮	⑲	"	"	"	"	"		
		㊲⑫	⑲	㊶	"	"	"	"	"		
		Colours A and B are knitted alternately every two rows.									8
		㊳㊶	⑮	⑲	"	"	"	"	"		
		㊳⑫	⑲	㊷	"	"	"	"	"		
		Colours A and B are knitted alternately every two rows.									8
		㊴㊷	⑮	⑲	"	"	"	"	"		
		㊴⑫	⑲	㊸	"	"	"	"	"		
		Colours A and B are knitted alternately every two rows.									8
		㊵㊸	⑮	⑲	"	"	"	"	"		
		㊵⑫	⑲	㊹	"	"	"	"	"		
		Colours A and B are knitted alternately every two rows.									8
		㊶㊹	⑮	⑲	"	"	"	"	"		
		㊶⑫	⑲	㊺	"	"	"	"	"		
		Colours A and B are knitted alternately every two rows.									8
		㊷㊺	⑮	⑲	"	"	"	"	"		
		㊷⑫	⑲	㊻	"	"	"	"	"		
		Colours A and B are knitted alternately every two rows.									8
		㊸㊻	⑮	⑲	"	"	"	"	"		
		㊸⑫	⑲	㊼	"	"	"	"	"		
		Colours A and B are knitted alternately every two rows.									8
		㊹㊼	⑮	⑲	"	"	"	"	"		
		㊹⑫	⑲	㊽	"	"	"	"	"		
		Colours A and B are knitted alternately every two rows.									8
		㊺㊽	⑮	⑲	"	"	"	"	"		
		㊺⑫	⑲	㊾	"	"	"	"	"		
		Colours A and B are knitted alternately every two rows.									8
		㊻㊾	⑮	⑲	"	"	"	"	"		
		㊻⑫	⑲	㊿	"	"	"	"	"		
		Colours A and B are knitted alternately every two rows.									8
		㊼㊿	⑮	⑲	"	"	"	"	"		
		㊼⑫	⑲	⓪	"	"	"	"	"		
		Colours A and B are knitted alternately every two rows.									8
		㊽⓪	⑮	⑲	"	"	"	"	"		
		㊽⑫	⑲	Ⓛ	"	"	"	"	"		
		Colours A and B are knitted alternately every two rows.									8
		㊾Ⓛ	⑮	⑲	"	"	"	"	"		
		㊾⑫	⑲	Ⓜ	"	"	"	"	"		
		Colours A and B are knitted alternately every two rows.									8
		㊿Ⓜ	⑮	⑲	"	"	"	"	"		
		㊿⑫	⑲	Ⓨ	"	"	"	"	"		
		Colours A and B are knitted alternately every two rows.									8
		ⓁⓎ	⑮	⑲	"	"	"	"	"		
		Ⓛ⑫	⑲	Ⓩ	"	"	"	"	"		
		Colours A and B are knitted alternately every two rows.									8
		ⓍⓏ	⑮	⑲	"	"	"	"	"		
		Ⓧ⑫	⑲	ⓐ	"	"	"	"	"		
		Colours A and B are knitted alternately every two rows.									8
		Ⓨⓐ	⑮	⑲	"	"	"	"	"		
		Ⓨ⑫	⑲	ⓑ	"	"	"	"	"		
		Colours A and B are knitted alternately every two rows.									8
		Ⓩⓑ	⑮	⑲	"	"	"	"	"		
		Ⓩ⑫	⑲	ⓓ	"	"	"	"	"		
		Colours A and B are knitted alternately every two rows.									8
		Ⓛⓓ	⑮	⑲	"	"	"	"	"		
		Ⓛ⑫	⑲	ⓔ	"	"	"	"	"		
		Colours A and B are knitted alternately every two rows.									8
		Ⓧⓔ	⑮	⑲	"	"	"	"	"		
		Ⓧ⑫	⑲	ⓕ	"	"	"	"	"		
		Colours A and B are knitted alternately every two rows.									8
		Ⓨⓕ	⑮	⑲	"	"	"	"	"		
		Ⓨ⑫	⑲	ⓖ	"	"	"	"	"		
		Colours A and B are knitted alternately every two rows.									8

NO. 20R-A

DOUBLE JACQUARD (9)
JACQUARD DOBLE (9)

A = Light Blue
Azul Claro
B = White
Blanco
C = Red
Rojo

1 Pat. = 24 sts., 60 rows.
1 Diseño = 24 pts., 60 cras.

OR- DER	CARD MEM.	YC-1			MAIN MACHINE			RIBBER		DIR.
		HOL. ①	HOL. ②	HOL. ③	CAM LEV.	SIDE LEV.	STP. KNB.	SET LEV.	DRV. LEV.	
①		Bound-off Cast-on								4
	①	A	B	C	STOCK	▲▲●	①①	→	—	
②	①	"	"	"	SLIP	"	▲	"	↑	
		Colours A and B are knitted alternately every two rows.								24
	②④	A	B	C	"	"	"	"	"	
	②⑤	"	C	B	"	"	"	"	"	
		Colours A and C are knitted alternately every two rows.								8
	③②	A	C	B	"	"	"	"	"	
	③③	"	B	C	"	"	"	"	"	
		Colours A and B are knitted alternately every two rows.								28
	⑥①	A	B	C	"	"	"	"	"	
	↓								*	

OR- DEN	MEM. TARJ.	YC-1 PRENEDORES			M. PRINCIPAL		M. AUXILIAR			DIR.
		①	②	③	P. DE LEVA	P. LTR.	PER. PDA	P. DE AJUSTE	LEVA MOTRIZ	
①		Enmallar con ribete rematado								4
	①	A	B	C	JER.	▲▲●	①①	→	—	
②	①	"	"	"	DESLI.	"	▲	"	↑	
		Colores A y B se tejen alternadamente cada dos carreras.								24
	②④	A	B	C	"	"	"	"	"	
	②⑤	"	C	B	"	"	"	"	"	
		Colores A y C se tejen alternadamente cada dos carreras.								8
	③②	A	C	B	"	"	"	"	"	
	③③	"	B	C	"	"	"	"	"	
		Colores A y B se tejen alternadamente cada dos carreras.								28
	⑥①	A	B	C	"	"	"	"	"	
	↓								*	

2 POINT KNITTING IN DOUBLE JACQUARD.

Point Knitting in Double Jacquard can be knit in any position on the fabric desired.

2 DISEÑO INDIVIDUAL EN PUNTOS DE JACQUARD DOBLE.

Diseño Individual en Puntos de Jacquard Doble se puede tejer en cualquier posición en una prenda que usted va a tejer.

In the Case of using One-Point Cams

- * Prepare the following accessories:—
 One-Point Cam — 1 pc. each right & left
 Plate Cam — 1 pc.

- * In this example use four different coloured light yarns.

Recommended Stitch Dial numbers:—
 Main Machine — 4
 Ribber — 4

OR- DER	CARD MEM.	YC-1			MAIN MACHINE			RIBBER		DIR.
		HOL. ①	HOL. ②	HOL. ③	CAM LEV.	SIDE LEV.	STP. KNB.	SET LEV.	DRV. LEV.	
Bound-off Cast-on										
①	(1)	(A)	B	C,D	STOCK	▲▲●	①①	→		4
②	(1)	"	"	"	SLIP	"	▲	↑		8
	}	Colours A and B are knitted alternately every two rows.								
	(8)	(A)	B	C,D	"	"	"	"	"	8
	(9)	"	C	B,D	"	"	"	"	"	24
	}	Colours A and C are knitted alternately every two rows.								
	(32)	(A)	C	B,D	"	"	"	"	"	4
	(33)	"	B	C,D	"	"	"	"	"	4
	}	Colours A and B are knitted alternately every two rows.								
	(36)	(A)	B	C,D	"	"	"	"	"	2
	(37)	"	D	B,C	"	"	"	"	"	10
	(38)	A	(D)	B,C	"	"	"	"	"	2
	(39)	B	"	A,C	"	"	"	"	"	10
	}	Colours B and D are knitted alternately every two rows.								
	(48)	(B)	D	A,C	"	"	"	"	"	10
	(49)	"	C	A,D	"	"	"	"	"	10
	}	Colours B and C are knitted alternately every two rows.								
	(58)	B	(C)	A,D	"	"	"	"	"	2
	(59)	A	"	B,D	"	"	"	"	"	2
	(60)	(A)	C	B,D	"	"	"	"	"	2

En el Caso de usar las Levas de Diseño Individual

- * Prepare los accesorios siguientes:—
 Leva de Diseño Individual
 1 pieza en cada lado, derecha e izquierda.
 Limitador
 1 pieza

- * En esta muestra de tejido, use cuatro hilos de peso liviano de colores diferentes.

Números Recomendables de Discos de Tensión:—
 Máquina Principal — 4
 Auxiliar — 4

POINT KNITTING (1)
 DISEÑO INDIVIDUAL (1)

NO. 19R-A



A = Blue
 Azul
 B = Orange
 Anaranjado
 C = White
 Blanco
 D = Green
 Verde

1 Pat. = 24 sts., 60 rows.
 1 Diseño = 24 pts., 60 cras.

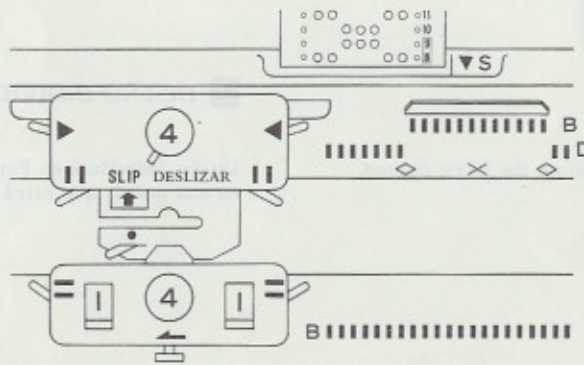

OR- DEN	MEM. TARJ.	YC-1 PRENEADORES			M. PRINCIPAL		M. AUXILIAR			DIR.
		①	②	③	P. DE LEVA	P. LTR.	PER. PDA.	P. DE AJUSTE	LEVA MOTRIZ	
Enmallar con ribete rematado										
①	(1)	(A)	B	C,D	JER.	▲▲●	①①	→		4
②	(1)	"	"	"	DESLI	"	▲	↑		8
	}	Colores A y B se tejen alternadamente cada dos carteras.								
	(8)	(A)	B	C,D	"	"	"	"	"	20
	(9)	"	C	B,D	"	"	"	"	"	4
	}	Colores A y C se tejen alternadamente cada dos carteras.								
	(32)	(A)	C	B,D	"	"	"	"	"	4
	(33)	"	B	C,D	"	"	"	"	"	2
	}	Colores A y B se tejen alternadamente cada dos carteras.								
	(36)	(A)	B	C,D	"	"	"	"	"	10
	(37)	"	D	B,C	"	"	"	"	"	2
	(38)	A	(D)	B,C	"	"	"	"	"	10
	(39)	B	"	A,C	"	"	"	"	"	10
	}	Colores B y D se tejen alternadamente cada dos carteras.								
	(48)	(B)	D	A,C	"	"	"	"	"	10
	(49)	"	C	A,D	"	"	"	"	"	10
	}	Colores B y C se tejen alternadamente cada dos carteras.								
	(58)	B	(C)	A,D	"	"	"	"	"	2
	(59)	A	"	B,D	"	"	"	"	"	2
	(60)	(A)	C	B,D	"	"	"	"	"	2

- (1) Thread colour A into the Yarn Feeder, and make the bound-off cast-on for double rib knitting.
- (2) Insert Punch Card No. 19R, in the A direction, into the Centre Panel Unit.
- (3) Set the Carriage and Stop Knob etc. according to Order ① of the operation table and knit one row with colour A from left to right.
- (4) Install the One-Point Cams to both sides of the main machine Carriage.
- (5) Place the Plate Cams on the needle bed in the position you desire. (The Plate Cam must be positioned behind the needle butts and between two ◊ marks on the needle bed.) (Refer to Main Machine Instruction Book.)
- (6) Set the Carriage and Stop Knob etc. according to Order ② of the operation table. The Card Memory Numbers inside the ◊, ◻ marks indicate that the needles to the outside of the Plate Cam should be pushed to D position (use the needle pusher). (For two rows the needles outside the Plate Cam should be in D position and for the following two rows in B position alternately.)

In the Case of using Magic Cams

- * Prepare the following accessories:—
 - Magic Cam — 1 pc. each right and left
 - Point Cam — 1 pc. each right and left
- * In this example use four different coloured light yarns.

Recommended Stitch Dial numbers:—
 Main Machine — 4
 Ribber — 4

NO. 19R—A



A = Blue B = Orange 1 Pat. = 24 sts., 60 rows.
 Azul Anaranjado 1 Diseño = 24 pts., 60 cras.
 C = White D = Green
 Blanco Verde

POINT KNITTING (2)
 DISEÑO INDIVIDUAL (2)

- (1) Enhebre color A en el Alimentador, y teja 4 carreras para hacer enmallada con ribete rematado siguiendo el mismo procedimiento para el "Comienzo" de Tejido en Resorte Doble en el Libro de Instrucciones de la Auxiliar.
- (2) Inserte la Tarjeta Perforada No. 19R dentro del tablero de diseños con la marca A apuntando hacia la parte inferior del lado derecho.
- (3) Ajuste las Palancas y la Perilla de Parada etc. de los carros de acuerdo con la línea ① de la tabla de operaciones y teja una carrera con color A desde la izquierda a la derecha.
- (4) Instale las Levas de Diseño Individual en ambos lados laterales del Carro de la máquina principal.
- (5) Coloque el Limitador sobre la cama de agujas en la posición donde usted quiera poner un Diseño Individual. (El Limitador deberá colocarse detrás de los toques de las agujas y entre las dos marcas de ◊ en la cama de agujas.) (Refiérase al Libro de Instrucciones de la Máquina Principal.)
- (6) Ajuste las Palancas y la Perilla de Parada etc. de los carros de acuerdo con la línea ② de la tabla de operaciones.
 Los Números de Memoria de la Tarjeta marcados con ◊ y ◻ indican que las agujas exteriores del alcance de Limitador deberán empujarse a la posición D (Use el selector de agujas). Es decir, para las dos carreras en ◊ y ◻, las agujas que no son cubiertas por el Limitador deberán sacarse en la posición D y para las dos carreras proximas, las agujas se dejan en la posición B alternativamente.

En el Caso de usar las Levas Mágicas

- * Prepare los accesorios siguientes:—
 - Leva Mágica
1 pieza en cada lado, derecha e izquierda.
 - Leva Limitador de Diseños
1 pieza en cada lado, derecha e izquierda.
- * En esta muestra de tejido, use cuatro hilos de peso liviano y de colores diferentes.
 Números recomendables de Discos de Tensión:—
 Máquina Principal — 4
 Auxiliar — 4

OR- DER	CARD MEM.	YC-1			MAIN MACHINE			RIBBER		DIR.
		HOL. ①	HOL. ②	HOL. ③	CAM LEV.	SIDE LEV.	STP. KNB.	SET LEV.	DRV. LEV.	
①		Bound-off Cast-on								14
	1	A	B	C,D	STOCK	▲▲●	①①	→		
②	1	*	*	*	SLIP	*	▲	*	↑	
	Colours A and B are knitted alternately every two rows.									
	8	A	B	C,D	*	*	*	*	*	
	9	*	C	B,D	*	*	*	*	*	
Colours A and C are knitted alternately every two rows.										
	18	A	C	B,D	*	*	*	*	*	
③	19	*	C	B,D	*	*	*	*	*	
	Colours A and C are knitted alternately every two rows.									
	32	A	C	B,D	*	*	*	*	*	
	33	*	B	C,D	*	*	*	*	*	
	Colours A and B are knitted alternately every two rows.									
	36	A	B	C,D	*	*	*	*	*	
	37	*	D	B,C	*	*	*	*	*	
	38	A	D	B,C	*	*	*	*	*	
	39	B	*	A,C	*	*	*	*	*	
	Colours B and D are knitted alternately every two rows.									
48	B	D	A,C	*	*	*	*	*		
49	*	C	A,D	*	*	*	*	*		
Colours B and C are knitted alternately every two rows.										
58	B	C	A,D	*	*	*	*	*		
59	A	*	B,D	*	*	*	*	*		
60	A	C	B,D	*	*	*	*	*		

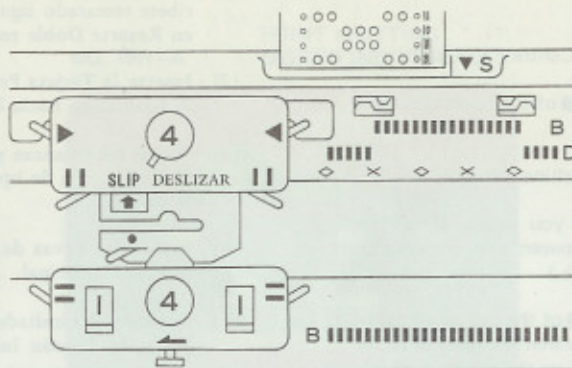

OR- DEN	MEM. TARJ.	YC-1 PRENEDORES			M. PRINCIPAL			M. AUXILIAR		DIR.
		①	②	③	P. DE LEVA	P. LTR.	PER. PDA.	P. DE AJUSTE	LEVA MOTRIZ	
①		Enmallar con ribete rematado								14
	1	A	B	C,D	JER.	▲▲●	①①	→		
②	1	*	*	*	DESLI.	*	▲	*	↑	
	Colores A y B se tejen alternadamente cada dos carreras.									
	8	A	B	C,D	*	*	*	*	*	
	9	*	C	B,D	*	*	*	*	*	
Colores A y C se tejen alternadamente cada dos carreras.										
	18	A	C	B,D	*	*	*	*	*	
③	19	*	C	B,D	*	*	*	*	*	
	Colores A y C se tejen alternadamente cada dos carreras.									
	32	A	C	B,D	*	*	*	*	*	
	33	*	B	C,D	*	*	*	*	*	
	Colores A y B se tejen alternadamente cada dos carreras.									
	36	A	B	C,D	*	*	*	*	*	
	37	*	D	B,C	*	*	*	*	*	
	38	A	D	B,C	*	*	*	*	*	
	39	B	*	A,C	*	*	*	*	*	
	Colores B y D se tejen alternadamente cada dos carreras.									
48	B	D	A,C	*	*	*	*	*		
49	*	C	A,D	*	*	*	*	*		
Colores B y C se tejen alternadamente cada dos carreras.										
58	B	C	A,D	*	*	*	*	*		
59	A	*	B,D	*	*	*	*	*		
60	A	C	B,D	*	*	*	*	*		

- Thread colour A into the Yarn Feeder, and make the bound-off cast-on for double rib knitting. Insert Punch Card No. 19R, in the A direction, into the Centre Panel Unit.
- Set the Carriage and Stop Knob according to Order ① of the operation table and knit one row with colour A, from left to right.
- Install the Magic Cams to both sides of the main machine Carriage.

- Enhebre color A en el Alimentador, y teja 4 carreras para hacer enmalla con ribete rematado siguiendo el mismo procedimiento para el "Comienzo" de Tejido en Punto Resorte Doble. Inserte la Tarjeta Perforada No. 19R dentro del tablero de diseños con la marca A apuntando hacia la parte inferior del lado derecho.
- Ajuste las Palancas y la Perilla de Parada etc. de los carros de acuerdo con la línea ① de la tabla de operaciones y teja una carrera con color A, de la izquierda a la derecha.
- Instale las Levas Mágicas en ambos lados del Carro de la máquina principal.

- (4) Place the Point Cams on the needle bed, in the place you desire, behind the needle butts. In this example, we knit the Point pattern covering a width of 48 stitches (3 ◊ marks). Set the Point Cams to the two outside ◊ marks.
 - (5) Set the Carriage and Stop Knob according to Order ② of the operation table and knit up to Card Memory Number 18 of the Punch Card.
 - (6) From Order ③ of the operation table move the left Point Cam 12 needles to the right (to the X mark on the needle bed) and continue to knit.
- * In the case of using the Point Cams, the needles to the outside of the cams should be brought to D position using the needle pusher. (Refer to page 19, (6))

- (4) Coloque las Levas Limitadores de Diseños en la cama de agujas, donde usted quiera poner diseños, detrás de los topes de agujas. En esta muestra de tejido, es tejido un diseño que cubre una anchura de 48 puntos (3 marcas de ◊). Coloque una Leva Limitador de Diseños en cada marca de ◊ en los extremos.
 - (5) Ajuste las Palancas y la Perilla de Parada etc. de los carros de acuerdo con la línea ② de la tabla de operaciones y teja hasta Número 18 de Memoria de la Tarjeta.
 - (6) Desde la línea ③ de la tabla de operaciones, mueva la Leva Limitador Izquierda 12 agujas hacia la derecha (hasta la marca de X en la cama de agujas) y continúe tejiendo.
- * En el caso de usar las Levas Limitadores de Diseños, las agujas exteriores de las Levas se deben sacar a la posición D usando el selector de agujas. (Refiérase a la página 19, (6))

4. MAINTENANCE AND SERVICE

4. MANTENIMIENTO Y SERVICIO

In the Case that the YC-1 Cannot be Removed from the Machine because of the Needle Retainer

1. Pull out the Needle Retainer, with the Hook Tool, about 2-3 cms.
2. Unwind the Securing Wheel until it stops and remove the YC-1 from the machine.

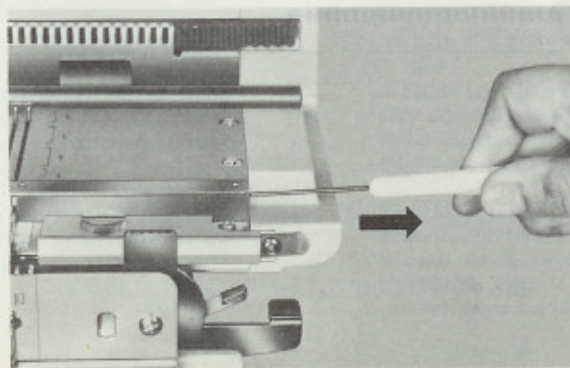

En el Caso de que el YC-1 no Se Pueda Sacar de la Máquina, detenido con el Retén de Agujas

1. Tire del Retén de Agujas para afuera con el Enganchador de Puntos, como 2-3 cms.
2. Afloje la Rueda de Fijación hasta que se pare y saque el YC-1 de la máquina.

If a Mistake is made while knitting

1. Disconnect the Ribber Carriage and move it to the left side of the needle bed. Remove the Arm from the main machine Carriage, turn the Cam Lever to Slip, set the Side Levers to the **■** mark and then move the Carriage to the right side of the needle bed.
2. Unravel the required number of rows. If the yarn is on the opposite side of the YC-1, unravel one more row. (The yarn must always be on the side of the YC-1 after unravelling has finished.) The needles should remain in B position.
3. Return the Punch Card and the Row Counter back the same number of rows that have been unravelled.
4. Place the yarns in the respective Holders as indicated in the operation table of the particular pattern.
5. Set the main machine Carriage and the Stop Knob according to the diagram on the right and then move the Carriage to the left side to re-memorize the pattern.
6. Set the Stop Knob to the **▼** mark, the Driving Lever to the **↑** mark and both Carriages to their original settings. Replace the Ribber Arm to the main machine Carriage and connect the Ribber Carriage to the Arm. Continue to knit.

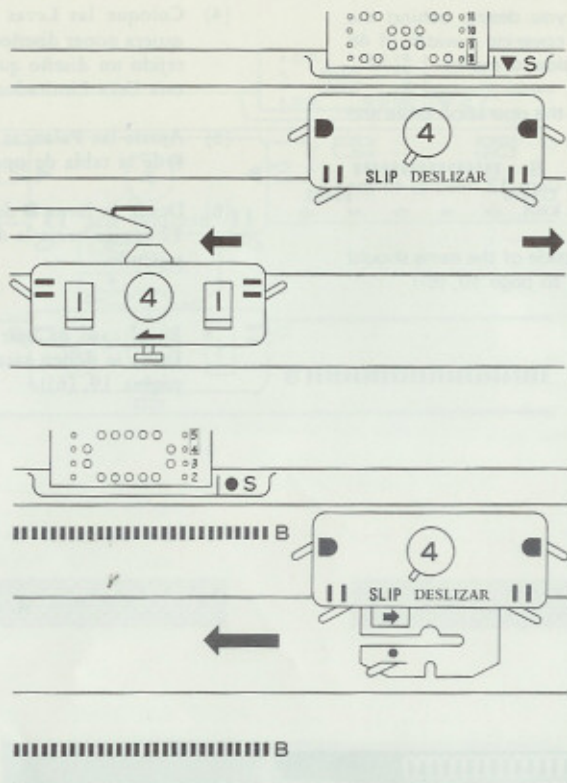

Cómo corregir cuando se equivocó al tejer

1. Desuna el Carro de la Auxiliar y llevalo hacia el lado izquierdo de la cama de agujas. Saque el Brazo fuera del Carro de la máquina principal, gradúe la Palanca de Leva en DESLIZAR, ajuste las Palancas Laterales en marca **■**, y entonces mueva el Carro hacia el lado derecho de la cama de agujas.
2. Deshile el número necesario de carreras hasta donde se equivocó al tejer. Si el hilo está ahora en el lado opuesto al que está el YC-1, deshile una carrera más. (El hilo debe estar siempre en el lado del YC-1 después que haya deshilado.) Alinee las agujas en posición B.
3. Retorne la Tarjeta Perforada y el Contador de Carreras por el número de carreras que se ha desbaratado.
4. Coloque los hilos en los Prendedores respectivos conforme a la tabla de operaciones para el diseño que está haciendo.
5. Gradúe cada parte de controles reguladores del Carro de la máquina principal y la Perilla de Parada de acuerdo con el diagrama en la izquierda y mueva el Carro hacia el lado izquierdo para re-grabar el diseño.
6. Ajuste la Perilla de Parada en la marca **▼**, la Leva Motriz en la marca **↑** y devuelva cada parte de controles en ambos carros a las posiciones originales.

If you wish to knit in Double Rib wanting the same effect as Double Jacquard

OR- DER	YC-1			MAIN MACHINE			RIBBER		DIR.
	HOL. ①	HOL. ②	HOL. ③	CAM LEV.	SIDE LEV.	STP. KNB.	SET LEV.	DRV. LEV.	
1	A	B		STOCK	▲▲●	●	①①	↑	←
2	A	B		SLIP	"	"	"	"	←
3	A	B		"	"	"	"	"	←
4	A	B		STOCK	"	"	"	"	→
↓									⇄

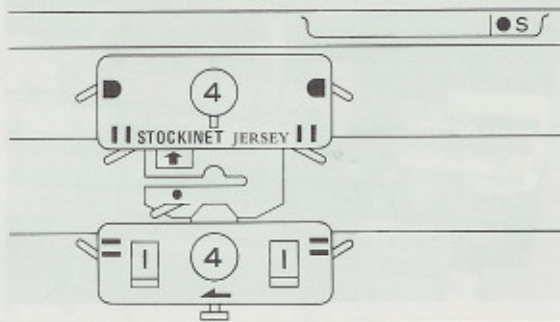

Si usted quiere tejer en Resorte Doble dando el mismo efecto como el tejido en Jacquard Doble

OR- DEN	YC-1 PRENEDORES			M. PRINCIPAL		M. AUXILIAR		DIR.
	①	②	③	P. DE LEVA	P. LTR. PDA.	P. DE AJUSTE	LEVA MOTRIZ	
1	A	B		JER.	▲▲●	●	①①	↑
2	A	B		DESLI.	"	"	"	"
3	A	B		"	"	"	"	"
4	A	B		JER.	"	"	"	"
↓								⇄

* If you knit in Double Jacquard in combination with Double Rib, the fabric effect is different.

1. If you wish to knit the above, set the Cam Lever of the main machine Carriage to Stockinet and Slip respectively as shown in the operation table above.

If the pattern is Improperly Knitted

- * In order to knit Double Jacquard you must closely follow the Punch Card to realize where to change the yarn. If you fail to change the yarns, at the indicated marks on the Punch Card, the pattern will not be formed and a stripe pattern is knitted.
- * Turn the Punch Card so as the Card Memory Number (T) appears above the ▲ mark on the Centre Panel, and move the Carriage across the needle bed to memorize the pattern. DO NOT fail to knit the first row from right to left. Follow the Punch Card carefully so as to knit a complete Double Jacquard pattern.

* Si usted teja en Jacquard Doble en combinación con Resorte Doble, los grosores de estos dos tipos de tejidos son diferentes.

1. Para tejer Punto Resorte Doble sin Tarjeta seguidamente después de tejer punto Jacquard Doble sin diferencia de grosor, gradue ambos Carros como se indica en el diagrama.
2. Ajuste la Palanca de Leva de la máquina principal en JERSEY y DESLIZAR respectivamente como se indica en la tabla de operaciones.

Si se teje el diseño en Punto Jacquard Doble incorrectamente

- * A fin de tejer Jacquard Doble, usted debe seguir la Tarjeta Perforada exactamente, para saber donde debe cambiar el hilo. Si usted cometa un error al cambiar hilos en las carreras marcadas por los puntos en la Tarjeta Perforada, no podrá lograr el diseño que desea sino tejerá sólo un diseño rayado.
- * Retorne la Tarjeta Perforada hasta que aparezca el Numero (T) de Memoria de la Tarjeta Perforada sobre la marca ▲ del tablero de diseños, y pase el Carro sobre la cama de agujas de la derecha a la izquierda para grabar el diseño. NO DEJE USTED de tejer la primera carrera desde la derecha a la izquierda. Siga la Tarjeta Perforada cuidadosamente para tejer un diseño completo en Jacquard Doble.

When Knitting with the Main Machine Only

When knitting with the main machine only, the YC-1 must be removed from the machine.

- * Lower, with the aid of the Drop Levers, the ribber to its lowest position and change the Ribber Arm for that of the main machine.

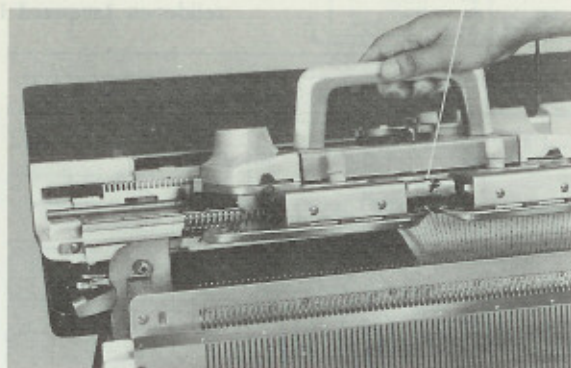

The Method for Placing Yarns in the Auxiliary Yarn Feeder of the YC-1 Arm

1. Draw the ground yarn (woolnylon yarn) from the Auto-Tension and pass it under the Auxiliary Yarn Feeder Bar at the left portion of the Arm, bringing the yarn towards the centre.
 2. Feed the yarn into the Auxiliary Yarn Feeder.
 3. Bring the yarn end up under the Auxiliary Yarn Feeder Yarn Guide.
 4. Wind the yarn end around a Ribber Weight which is hanging from the Cast-on Comb.
- * You cannot make pile knitting when the YC-1 is installed on the machine. When you use the Auxiliary Yarn Feeder, you must remove the YC-1 from the machine.

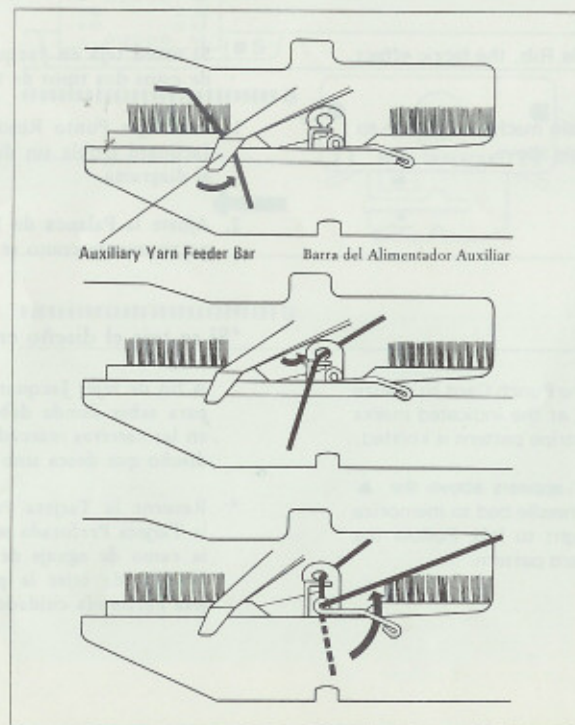

Cuando Teja sólo con la Máquina Principal

Cuando teja sólo con la máquina principal, el YC-1 se debe sacar fuera de la máquina.

- * Baje la auxiliar hasta la posición más inferior empujando las Palancas de Descenso dos veces hacia abajo, y reemplace el Brazo de la auxiliar con el de la máquina principal.

El Método de Enhebrar un Hilo por entre el Alimentador Auxiliar del Brazo para el YC-1

1. Tire del hilo de base (Nylon flexible) a través del Tensor Automático y páselo debajo de la Barra del Alimentador Auxiliar en la porción izquierda del Brazo, introduciendo el cabo del hilo hacia el centro.
 2. Alimente del hilo al Alimentador Auxiliar.
 3. Introduzca el hilo, pasándolo por debajo del Alambre de Guía, hacia el orificio central.
 4. Amarre el cabo extremo del hilo alrededor de una Pesa que está colgada del Peine de Enmallada.
- * No se puede tejer Puntos Afelpados cuando el YC-1 está instalado en la máquina. Cuando usa el Alimentador Auxiliar, usted debe sacar el YC-1 fuera de la máquina.

AUTOMATIC YARN CHANGER MODEL YC-2

We thank you for purchasing this new Automatic Yarn Changer which is indispensable to you as an Accessory.

The Needle Guide and Ribber Arm for use with the Yarn Changer have now been made a part of the Ribbing Attachment Model SRP-20, so there is now no need for changing the mentioned parts as stated in this Instruction Book on pages 2 and 3 (Nos. 1 and 2.)

You can use the remainder of this Instruction Book as no change has been made in the knitting operation when the Yarn Changer is in use.

CAMBIADOR AUTOMATICO DE HILO MODELO YC-2

Le agradecemos por su compra de este nuevo Cambiador Automático de Hilo del cual estamos seguro que le servirá muy útil al tejer como accesorio indispensable.

La Guía de Agujas y el Brazo de la Máquina Auxiliar hechos para el uso en ambos casos de tejer con ó sin el Cambiador Automático de Hilo, ya están instalados en la Máquina Auxiliar Modelo SRP-20. Por lo tanto, no se necesita cambiar las partes mencionadas como indica el Libro de Instrucciones en la página 2 y 3 (Párrafos 1 y 2).

A partir del párrafo 3 en la página 3, usted puede seguir el Libro de Instrucciones.