

**Winter
Wonderland
of Knits**

*Everyday Basics
to Nighttime
Elegance*

**Coordinated
Couples**

*Standard and
Bulky His 'n Hers*

**Holiday
Baby**

*Adorable Clothes
in Seasonal
Shades*



285



286



Table of Contents

Knitkng Magazine — Volume 28, Number 3

••• General Instructions.....	13
284 Defining Style.....	15
285 All The Trimmings.....	17
286 Going in Style.....	18
287 Scene Stealer.....	19
288 Two's Company.....	21
289 Two's Company.....	22
290 Free Spirit.....	23
291 Sleek Chic.....	24
292 Formal Setting.....	25
293 All Tucked In.....	27
294 For Those Who Think Young.....	28
295 Split Decision.....	29
296 Split Decision.....	30
297 Lady in Red.....	32
298 Just My Type.....	33
299 Life's a Breeze.....	34
300 Elements of Style.....	35
301 A Fresh Perspective.....	36
302 Make Waves.....	37
303 Little Big Man.....	37
304 Small Wonder.....	38

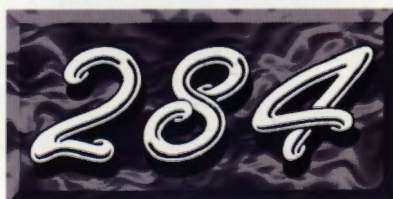

Publisher: KNITKING CORPORATION, 141 Hopmeadow St.,
 Simsbury, CT 06089. Telephone: (203) 651-2929. Published quarterly.
 Subscriptions: USA-\$24.00 annually; single copies \$7.95. \$29.00-all other
 countries. The entire contents of KNITKING MAGAZINE are copyrighted and
 must not be reproduced in any shape or form without the
 express permission, in writing, of the publisher.
 © COPYRIGHT 1994 KNITKING CORPORATION

Photography by : LARRY BARTHOLOMEW

Editorial

Dear Readers,

Welcome to our holiday issue. Does that sound as unbelievable to you as it does to me? It seems like just yesterday we were packing for the Knitkng move from Los Angeles to Simsbury, but here we are all settled in our new facility and having a grand time.

We are featuring many terrific seasonal favorites in this issue. Knitkng can take you from casual fun (in our Bulky Short Row pullover with decorative cord trim for today's look - Pattern 285) to perfect party elegance with our cover pants suit with pleated pants and lovely tailored long jacket. Or paint the town in a sleek full-length dress (with just the proper coverage provided by the matching lace vest) designed to flatter your figure (Pattern 292). Add the dramatic full-length ribbed coat loaded with "attitude" (Pattern 291) and turn heads at your favorite holiday party.

In addition to clothes for you, we've got a great selection of garments to make for gifts. Family members will be delighted with our bulky and standard matching his and hers wear (Patterns 288/289 and 295/296). And we haven't forgotten the little ones either! Baby your special little ones with the perfect dress or romper and matching cardigan. They're not only pretty, but easy to knit. And don't forget to knit up an afghan (Pattern 293) or two for a real heirloom gift item.

We hope you'll find just the right patterns for your special needs in this issue. And stay tuned for exciting changes coming in Knitkng Magazine. We're hard at work planning major enhancements which will incorporate many of the suggestions and requests we've received from you into fun new features and articles to make Knitkng Magazine the ultimate machine knitting magazine for news, fashion, teaching tips and more.

Have fun knitting,

Suzanne Steer

287



288

289



290



297



292



293

294



Now You Can Knit Your Garments in the Wink of an Eye and the Tap of a Foot!

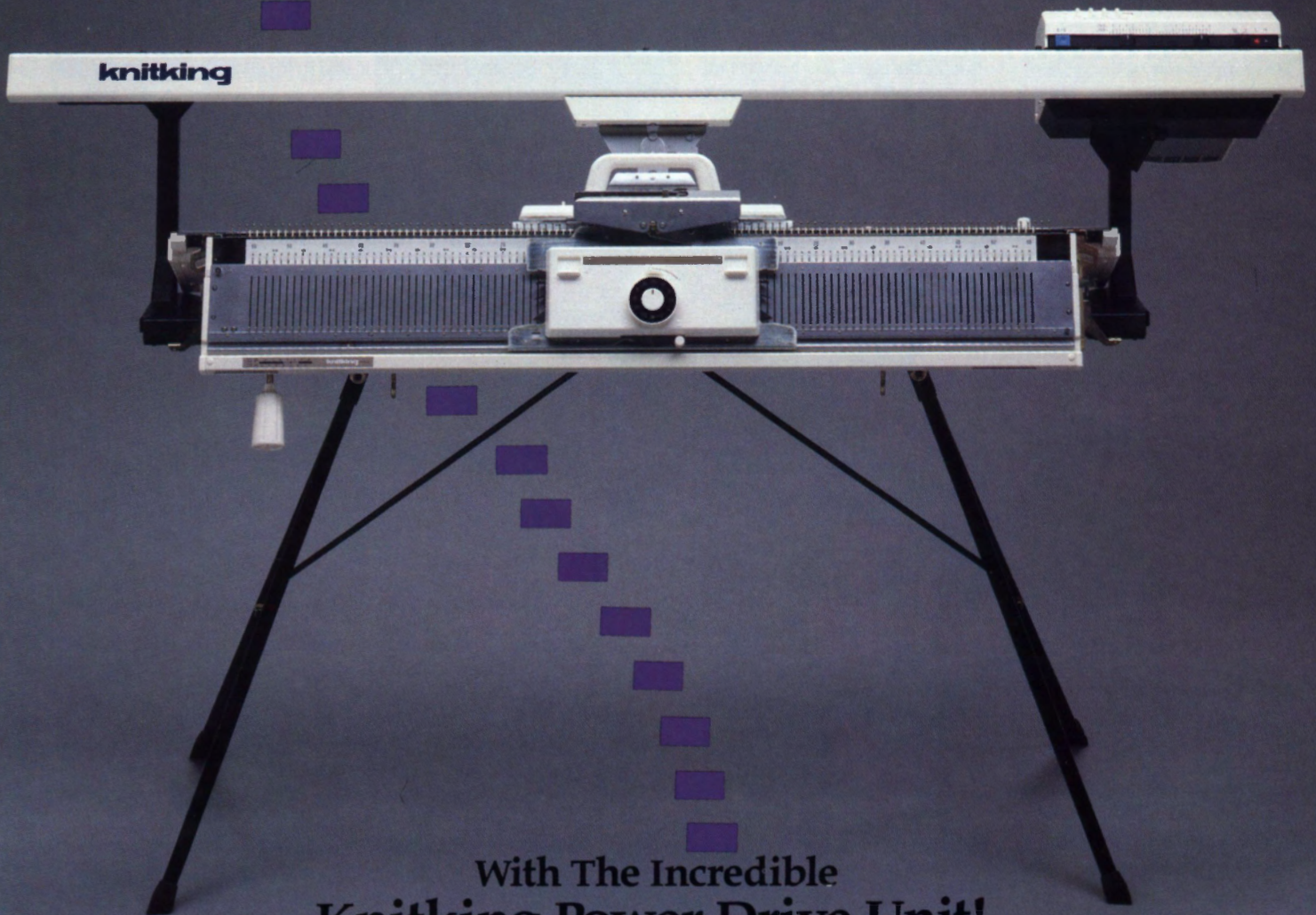

With The Incredible Knitking Power Drive Unit!

It attaches to the carriage of your Knitking knitting machine and, with the push of a button or tap of the foot pedal, automatically moves the carriage back and forth across the knitting bed!

knitking

Where Savings And Value
Are Always In Fashion

The Unequaled Features of the KNITKING POWER DRIVE UNIT Will Help Make the Ease and Speed of Garment Creation More Incredible Than Ever!

Operates at two speeds to best accommodate your stitch type, and the weight and

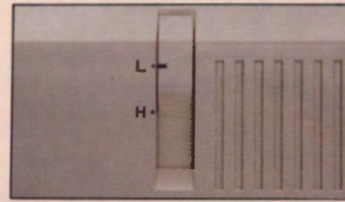

tension of your yarn.

Turn on the motor by the press of a button or the tap of an optional foot



pedal, for continuous or one-row-at-a-time knitting.

Easily control the distance left and right that the carriage



will travel.

It turns itself off automatically

Set the row counter for the number of rows



you want to knit and the PDU will shut off automatically when the preset row number is complete.

Yarn Tension Unit with special

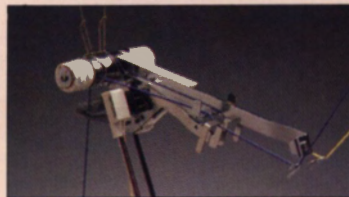

sensors shut off the Unit automatically if the yarn runs out, breaks, or if a knot is detected.

It's complete and versatile

The Knitking Power Drive Unit comes complete with

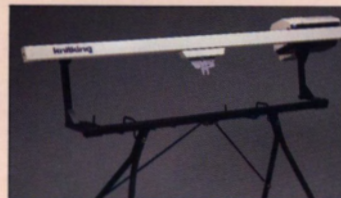

a sturdy, custom designed table-stand.

It can be used with both standard bed and bulky knitting machines



... with no additional parts or attachments!

knitking

General Instructions

THE SAMPLE SWATCH

It is imperative that you knit a sample swatch for every garment. Although you may be using the identical yarn and machine model as the pattern suggests, many variables such as dye lot difference, speed of knitting and just machine to machine differences can all cause a variance in the gauge achieved. Knitting Magazine publishes the tension and gauge for each garment shown. We strongly urge you to knit a swatch representing three tensions - the recommended tension, and .1 or .2 higher and lower. These different tensions can be knitted in one piece with waste yarn separating the sections. This will eliminate unnecessary rethreading while allowing you to obtain the gauge published in the magazine.

To make a sample swatch on standard gauge machines cast on 60 stitches with waste yarn. Knit approximately 6 rows. *Mark the tension number for your swatch by making holes. For example 4 eyelet holes for Tension 4, 6 eyelet holes for Tension 6. Knit 6 more rows.

Change to garment yarn and reset row counter to 0. Knit 30 rows (in Pattern stitch). With contrast yarn, mark the 10th stitch FROM EACH SIDE by hand. Knit 30 Rows. Change to waste yarn and knit 6 rows. Change tension up or down for second section and repeat from *. Make third section with another tension. Remove on 12 Rows of

waste yarn. Remove the sts. from the machine by pushing the Carriage across without yarn.

Pull and stretch the swatch both lengthwise and diagonally from corner to corner. Gently block the swatch. Treat the swatch as you would the finished garment before measuring the gauge. For example, if you plan to wash this garment and dry it in the dryer, you should do so, measuring before and after to see the difference.

Measure between the stitches marked and the beginning and ending rows for the inches/cms. knitted. Divide the total number of stitches/rows by the inches measured to calculate sts. and rows per inch.

For Bulky knitters, make swatch with 30 Sts. and 30 Rows. If so desired, or for large pattern repeats, we suggest a wider and longer swatch to provide more accurate gauges.

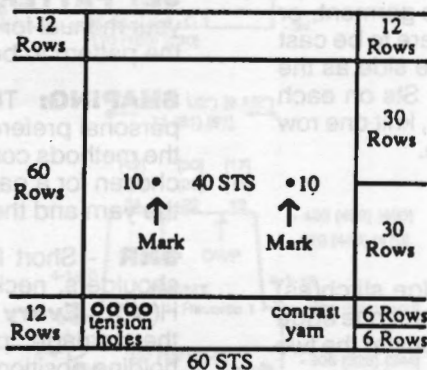

BUTTONHOLES

The following methods of buttonholes are the general manner in which small and large buttonholes are created.

Small Buttonholes in Ribbing

Make small eyelet style buttonholes by following chart below.



Large Buttonholes in FNR

Vertical buttonholes are made by knitting each side separately (partial or short-row knitting). Knit the right side first, end with yarn on left. Without breaking yarn, knit left side. The strand of yarn inside the buttonhole can be picked up every other row when knitting the left side, but this is not necessary for a small buttonhole.

SHORT ROWS

Method One

With carriage on opposite side start placing appropriate number of ndls in HP. Knit across and wrap the inside needle. Again, place appropriate number of ndls in HP on opposite side from carriage, knit across and repeat wrapping. The wrapping will eliminate any holes in the knitting. Release HOLD button and continue knitting.

Method Two - Automatic Wrap

Example follows for shoulder short rows. This method can be used for other Short Rowing as well. For example if pattern says to Short Row at shoulder every other row 7 sts, 1 x and 6 sts. 1 x . . . With carriage on opposite side put 6 sts in HP, knit 1 row across and put one additional needle in HP. Opposite carriage place 6 ndls in HP. Knit 1 row across and bring one extra needle to HP. Repeat until shortrowing is completed.

HEMS

Two methods of knitting hems are described below. Variations on these instructions will allow you to knit plain hems, picot edge hems and more.

Method One

With waste yarn cast on the required number of stitches and knit about 10-12 rows ending with the carriage on the left. Knit 1 Row to the right with Ravel Cord. Change to garment yarn and knit 1 Row to the left at garment body tension. (i.e. Skirt at Tension 4, 1st row at T 4). Turn tension down approximately 2 full tension numbers lower (tighter) and knit to mid point. (i.e. Row 14 of a 28-row hem). Change tension to 1 full point lower than garment body and knit remainder of hem rows. Pick up the stitches from the first row of garment yarn - shown between the stitches of Ravel Cord. Hem is now completed. Proceed with pattern as per chart and instructions. Remove waste yarn and

Ravel Cord when you have completed section.

Method Two

Bring required number of needles to "B" (working) position. Attach cast-on comb. Beginning with the 2nd needle on the LEFT, bring every other needle to "D" or "E" position. Push in both Part buttons. Knit 1 Row to the left. Release the part buttons and drop the cast-on comb. (DO NOT REMOVE cast on comb from work). Knit required number of rows for hem. Attach weights to the back of work close to the cast-on comb (about 1/4" above the comb). Beginning with the 1st needle on the LEFT, bring every other needle to "D" position. Carefully LIFT the cast-on comb and hang loops onto the needles in "D" position. Turn the comb back away from you and make sure the needles are through the loops. Pull the needles out to "E" position and remove the cast-on comb.

General Instructions

AT THE SAME TIME - Two functions are to be performed at the same time, such as shaping the neck and shoulder. Be sure to read both instructions before proceeding.

BO - Bind Off. To take off more than 1 St. at a time. When two or more stitches are to be bound off (or cast on) the carriage and yarn must be on the same side as the bind off. If the instruction is, "At R 100 BO 6 Sts on each side.", on the carriage side BO six stitches, knit one row and then bind off six stitches on the other side. See DECR and FF DECR.

BOLT - Slip Stitch **B**ind **O**ff with a **L**atch **T**ool. Knit one row to the left at a tension at least five numbers higher (looser) than the garment tension. Bring all needles to holding position ("E") and then, pick up the first stitch on a latch tool allowing it to slip behind the latch, then pick up the next stitch and pull it through the stitch already on the latch hook, thus creating a slip stitch. If you cannot set the tension at least five full tension numbers higher, knit a row loosely manually.

C - Color

CO - Cast on stitches for knitting. (**CHECK INSTRUCTION MANUALS TO MAKE SURE DIFFERENT METHODS ARE SHOWN**) In our instructions, CO is used either for a finished edge at the beginning of the garment, or to add edge stitch(es). If two or more stitches are to be cast on the carriage and yarn must be on the same side as the cast on. If the instruction is, "At R 100 CO 6 Sts on each side.", on the carriage side cast on six stitches, knit one row and then cast on six stitches on the other side.

COL - Carriage on left

COR - Carriage on right

DECR - Use the transfer tool to move the edge stitch(es) inward to the next needle. Usually used to transfer one edge stitch to the next needle, but may be used to transfer the two edge stitches to the next two needles.

EON - Every other needle

EOR - Every other row

EOS - Every other stitch

FF DECR - Used to make an even edge for seaming and decorative seams for raglans. If one stitch is to be decreased, use a two-prong transfer tool to move the two edge stitches inward one needle. If two stitches are to be decreased, use a three-prong transfer tool to move the three edge stitches in two needles. If three stitches are to be decreased, use two two-prong transfer tools and move the edge stitches in four needles. See DECR, BO and SHAPING.

FF INCR - To increase one stitch move the two edge stitches outward one needle, then fill the empty needle by picking up a bar from the row below and hanging it on the empty needle.

FNR - Full Needle Rib

G.C. - Garter Carriage

HP - Holding position or "E" position.

INCR - Increase. Usually used for "full-fashion" shaping, see FF Incr., or in conjunction with short row shaping. A simple incr can be made by pulling additional needle on side of carriage out to "E" position and knit across.

MB - Main Bed

MC - Main Color

Ndls - Needles

NWP - Non-working position or position "A"

R(s) - Row(s)

RB - Ribber Bed

RC - Row Counter.

RC 0 - Set RC to zero.

SET PATTERN - Follow the step-by-step instructions in your manual for setting the pattern and carriage controls for the pattern to be knit, e.g., Fairisle, tuck, single motif, etc.

SHAPING: The method used for shaping is a matter of personal preference. In our definitions we have described the methods commonly in use at Knitking. Which method is chosen for a particular pattern depends upon the garment, the yarn and the personal preference of the designer.

SHR - Short Row or Partial Knitting. Used for shaping shoulders, necklines, darts, gores, etc. Set carriage on H(old). **Every other row SHR:** On the opposite side of the carriage, place the specified number of stitches in holding position, knit across, wrap the inner needle or use an "automatic wrap". After all specified stitches have been placed in HP change the carriage setting to N (knit) to return the needles to WP. **Every row SHR:** On the side being shaped, place one stitch in HP every row. It is recommended you refer to your manual or an instruction book for detailed instructions about how to short row.

St(s) - Stitch(es)

St. St. - Stockinette stitch.

T - Tension.

WP - Working Position or "B" position.

WY - Waste yarn.

YM - Yarn marker. To place a yarn marker, use a short piece of contrasting yarn and loop it over the needle specified or the end needle of the row specified.

SEAMING GARMENTS

Any number of popular methods are suggested. We encourage you to experiment with any and all. If a garment in *Knitking Magazine* requires special seaming information it will be provided in the individual pattern instruction. Otherwise, methods include: linking on the knitting machine, Knitking's Lectrolink, the electric linker, crochet slip stitch, tapestry needles with back stitch sewing by hand. Bar to bar weaving for seamless appearance and seaming on a sewing machine.



DEFINING STYLE

YARN: Venetia and Glace Plus

SIZES:

6/8 (10/12) [14]

AMOUNT: Same all sizes

C 1: Venetia - Black - 2 cones (cones approx 1-1/2 lb. each)

C 2: Glace Plus - White 4 oz.

KIT: \$90.00

TENSION:

Pants: T 4; Jacket: T 4.1

GAUGE:

Pants: 9.7 Sts., 13 Rs. = 1"

Jacket: 8.9 Sts., 12.7 Rs. = 1"

NOTIONS: 1 - 1 1/4" button for jacket and elastic for waistband.

TECHNIQUE: St. St.

Make on any Standard Machine.

PANTS BACK: Make 1, Reverse 1.

With WY CO 76 (82) [88] sts. After several rows end with 1 row Ravel Cord to the right. RC 0. T 4. C 1. Knit in St. St. while incr. on each side every 15 Rs. 1 St. 20x (every 14 Rs. 1 St. 14x and every 16 Rs. 1 St. 8x) [every 14 Rs. 1 St. 20x and every 15 Rs. 1 St. 4x]. At R 306 (326) [344] BO 8 Sts. on right side, then decr. every 8 Rs. 1 St. 16x. AT THE SAME TIME at R 366 (392) [416] on left side decr. every 4 Rs. 1 St. 16x. At R 430 (456) [480] SHR EOR 8 Sts. 5x. At R 440 (466) [490] remove sts. on WY.

PANTS FRONT: Make 1, Reverse 1.

Knit front same as back to R 306 (326) [344]. On left side BO EOR 8 Sts. 1x, 6 Sts. 1x and 5 Sts. 1x, then decr. every 4 Rs. 1 St. 10x. AT THE SAME TIME at R 370 (394) [420] BO 4 Sts. on right side for pocket trim and decr. every 4 Rs. 1 St. 12x. At R 420 (446) [470] place 2 ndls. to OWP following chart. At R 430 (456) [480] remove sts. on WY.

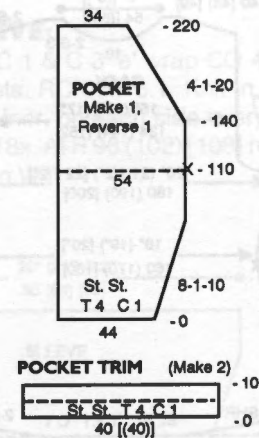
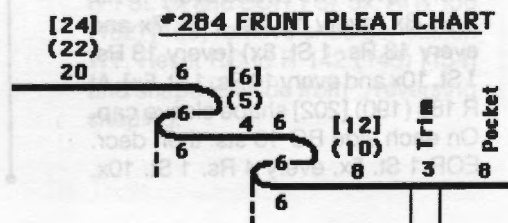
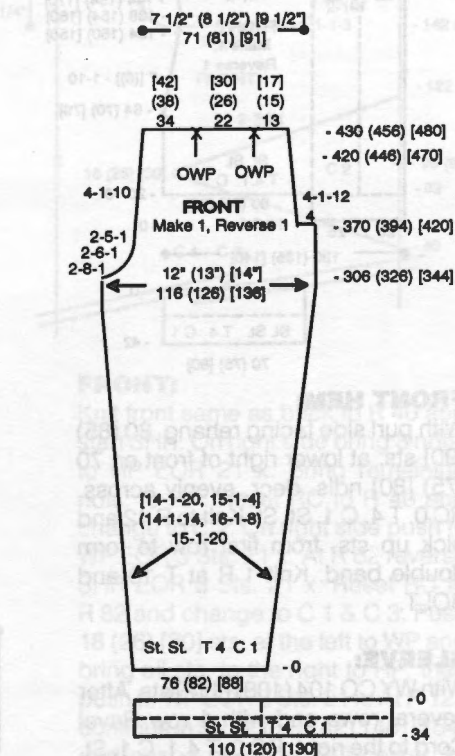
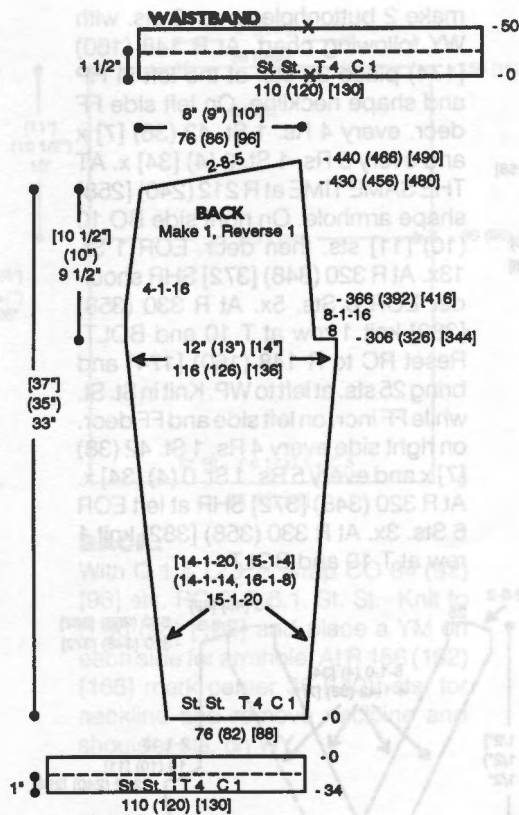

PANTS HEM:

With purl side facing rehang lower edge of 1 front and 1 back on 110 (120) [130] ndls. RC 0. T 4. C 1. St. St. Knit to R 34 and pick up sts. from first row to form double hem. Knit 1 row at T 10 and BOLT.

POCKET TRIM: Make 2.

With purl side facing rehang front pocket opening on 40 [(40)] ndls. RC 0. T 4. C 1. St. St. Knit to R 10 and pick up sts. from first row to form double band. Knit 1 row at T 10 and BOLT.

POCKET: Make 1, Reverse 1.

With WY CO 44 Sts. After several rows end with 1 row Ravel Cord to the right. RC 0. T 4. C 1. Knit in St. St. while incr. on right side every 8 Rs. 1 St. 10x. At R 110 place a YM on right side. At R 140 decr. on right every 4 Rs. 1 St. 20x. At R 220 remove sts. on WY.

WAISTBAND:

Front: Bring 110 (120) [130] ndls. to WP. With purl side facing rehang upper edge of front on these ndls. starting at the right of -0- following pleat chart. Leave 10 ndls. at the right empty. With knit side facing rehang upper edge of pocket on these same ndls. from right to left. Rehang bottom of pocket from right to left (incl. 10 empty ndls.). Rehang left front and pocket in the same manner starting at the left of -0-. RC 0. T 4. C 1. St. St. Knit to R 50 and pick up sts. from first row to form double band. Knit 1 row at T 10 and BOLT.

Back: Bring 110 (120) [130] ndls. to WP. With purl side facing rehang upper edge of backs on these ndls. decr. evenly across. Knit same as front.

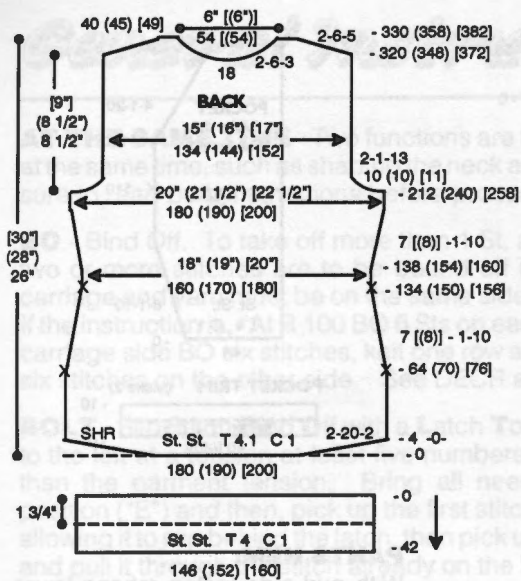

JACKET BACK:

With WY CO 180 (190) [200] sts. After several rows end with 1 row Ravel Cord to the right. RC 0. T 4.1. C 1. St. St. SHR on each side EOR 20 Sts. 2x. At R 64 (70) [76] decr. on each side every 7 [(8)] Rs. 1 St. 10x. At R 134 (150) [156] place a YM on each side. At R 138 (154) [160] incr. on each side every 7 [(8)] Rs. 1 St. 10x. At R 212 (240) [258] shape armhole. On each side BO 10 (10) [11] sts. then decr. EOR 1 St. 13x. At R 320 (348) [372] shape neckline. BO center 18 sts. Place all sts. to the left in HP. *On neckline edge SHR EOR 6 Sts. 3x. AT THE SAME TIME SHR shoulder EOR 6 Sts. 5x. At R 330 (358) [382] BO shoulder sts. Reset RC to R 320 (348) [372] and shape left neckline and shoulder from *, reversing shapings.

BACK HEM:

With purl side facing rehang lower edge of back on 146 (152) [160] ndls. decr. evenly across. RC 0. T 4. C 1. St. St. Knit to R 42 and pick up sts. from first row to form double band. Knit 1 row at T 10 and BOLT.

JACKET FRONT: Make 1, Reverse 1.

With WY CO 130 (135) [140] sts. After several rows end with 1 row Ravel Cord to the right. Place 80 (85) [90] sts. to the right in HP. RC 0. T 4.1. C 1. St. St. Mark center with a YM. Knit to R 20 and place a YM on left side. Bring ndls. at right to WP. RC 0. St. St. At R 64 (70) [76] decr. on right side every 7 [(8)] Rs. 1 St. 10x. At R 134 (150) [156] place a YM on right side. At R 138 (154) [160] incr. on right side every 7 [(8)] Rs. 1 St. 10x. AT THE SAME TIME at R 144 (154) [170]

make 2 buttonholes over 8 sts. with WY following chart. At R 148 (160) [174] place 25 sts. at the left in HP and shape neckline. On left side FF decr. every 4 Rs. 1 St. 42 (38) [7] x and every 5 Rs. 1 St. 0 (4) [34] x. AT THE SAME TIME at R 212 (240) [258] shape armhole. On right side BO 10 (10) [11] sts. then decr. EOR 1 St. 13x. At R 320 (348) [372] SHR shoulder EOR 6 Sts. 5x. At R 330 (358) [382] knit 1 row at T 10 and BOLT. Reset RC to R 148 (160) [174] and bring 25 sts. at left to WP. Knit in St. St. while FF incr. on left side and FF decr. on right side every 4 Rs. 1 St. 42 (38) [7] x and every 5 Rs. 1 St. 0 (4) [34] x. At R 320 (348) [372] SHR at left EOR 6 Sts. 3x. At R 330 (358) [382] knit 1 row at T 10 and BOLT.

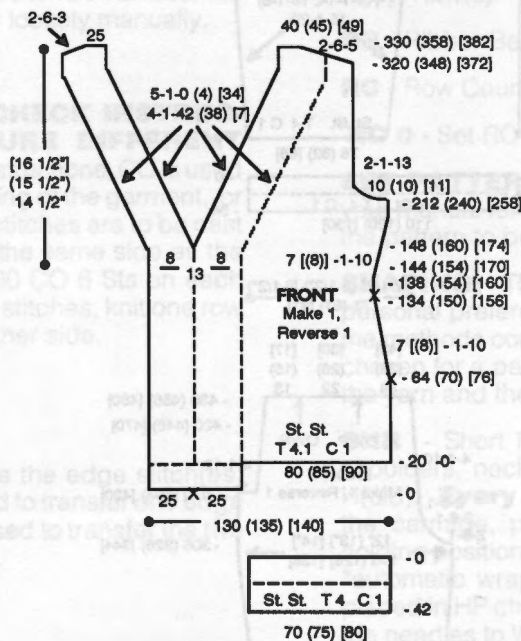

FRONT HEM:

With purl side facing rehang 80 (85) [90] sts. at lower right of front on 70 (75) [80] ndls. decr. evenly across. RC 0. T 4. C 1. St. St. Knit to R 42 and pick up sts. from first row to form double band. Knit 1 R at T 10 and BOLT.

SLEEVE:

With WY CO 104 (108) [112] sts. After several rows end with 1 row Ravel Cord to the right. RC 0. T 4.1. C 1. St. St. SHR on each side EOR 10 Sts. 2x. Shape sleeve by incr. on each side every 12 Rs. 1 St. 7x and every 13 Rs. 1 St. 8x (every 12 Rs. 1 St. 7x and every 13 Rs. 1 St. 8x) [every 13 Rs. 1 St. 10x and every 14 Rs. 1 St. 5x]. At R 188 (190) [202] shape sleeve cap. On each side BO 10 sts. then decr. EOR 1 St. 5x, every 4 Rs. 1 St. 10x,

EOR 1 St. 7x and SHR EOR 2 Sts. 13x. At R 278 (280) [292] knit 1 row at T 5 and BOLT.

CUFF:

With purl side facing rehang lower edge of sleeve on 70 (70) [76] ndls. RC 0. T 4. C 2. St. St. Knit to R 8 and change to C 1. Knit to R 42 and pick up sts. from first row to form double band. Knit 1 row at T 10 and BOLT.

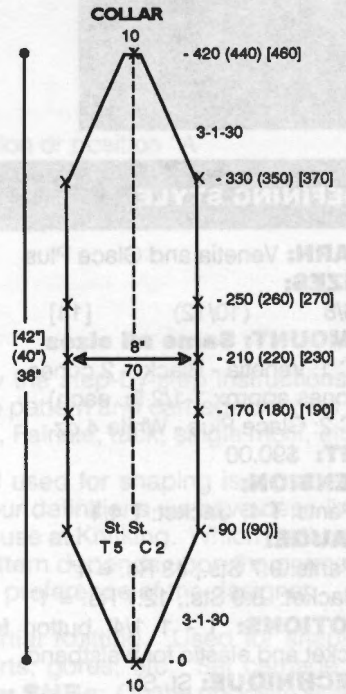

COLLAR:

With WY CO 10 sts. After several rows end with 1 row Ravel Cord to the right. RC 0. T 5. C 2. Mark center with a YM. Knit in St. St. while incr. on each side every 3 Rs. 1 St. 30x. At R 90 [(90)] place a YM on each side. At R 170 (180) [190] place a YM on each side for neckline. At R 210 (220) [230] place a YM on each side for center of neckline. At R 250 (260) [270] place

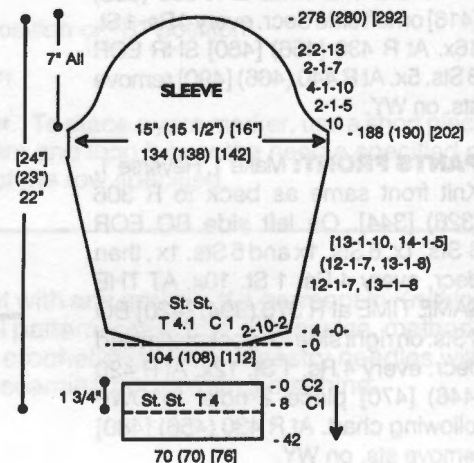

a YM on each side for neckline. At R 330 (350) [370] place a YM on each side and start decr. every 3 Rs. 1 St. 30x. At R 420 (440) [460] mark center and remove sts. on WY.

FINISHING:

Pants: Close pocket seams. Close all remaining seams.

Jacket: Attach collar to neckline between markers and down front inserting between lining and front neckline. Turn lining to inside and whip stitch in place. Close shoulder seams and attach sleeves. Close all remaining seams.

285



ALL THE TRIMMINGS

YARN: Mirage and Rayon Nubs
SIZES:

Small (Medium) [Large]
AMOUNT: Same all Sizes
C 1: Mirage - Wedgewood
2 Cones (approx. 1 lb. cones)
C 2: Mirage - Navy 8 oz.
C 3: Rayon Nubs - Mulbry/Navy
1 Cone

KIT: \$68.00
TENSION: Body: T 6.1
GAUGE: 4 Sts., 6 Rs. = 1"
TECHNIQUE: Short Row
NOTIONS: 2 — 1-1/4" buttons for decorative trim

Make on any Bulky Machine.

Note: Use C 1 and C 3 together throughout.

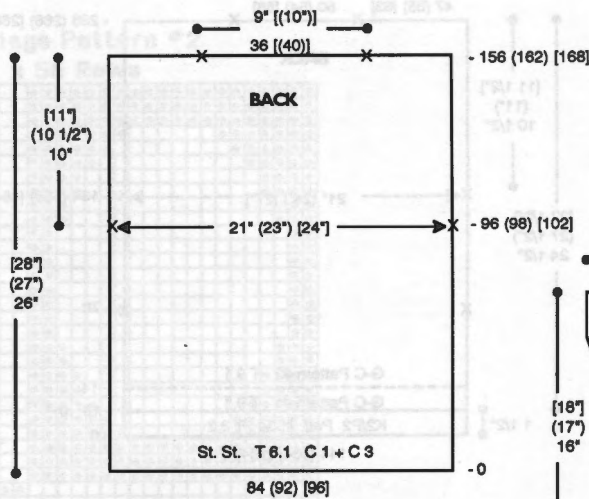

BACK:

With C 1 & C 3 'e' wrap CO 84 (92) [96] sts. RC 0. T 6.1. St. St. Knit to R 96 (98) [102] and place a YM on each side for armhole. At R 156 (162) [168] mark center 36 [(40)] sts. for neckline and remove neckline and shoulder sts. on WY.

SLEEVE:

With C 1 & C 3 'e' wrap CO 44 (48) [52] sts. RC 0. T 6.1. Knit in St. St. while incr. on each side every 5 Rs. 1 St. 18x. At R 96 (102) [108] remove sts. on WY.

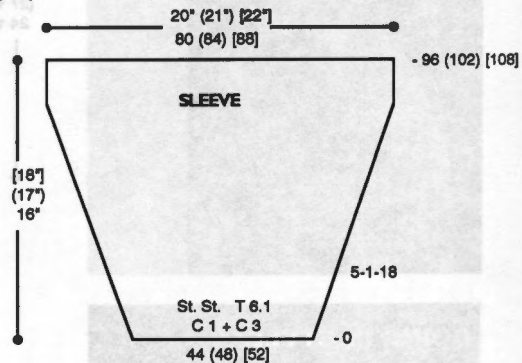

CORD:

With C 2 'e' wrap CO 3 sts. RC 0. T 3. St. St. Knit until cord measures 200".

CORD
(Not to Scale)

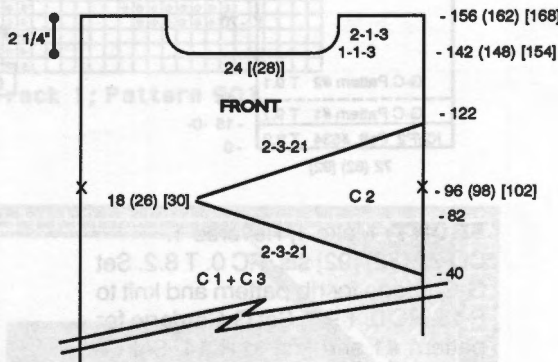
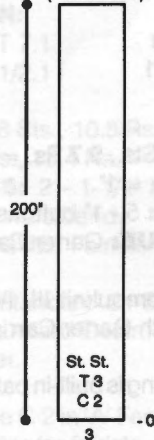

FRONT:

Knit front same as back to R 40 and start SHR. On right side bring 3 ndls. to HP EOR 21 x. Bring remaining ndls. to HP. Reset RC to R 40 and change to C 2. On right side push to WP EOR 3 Sts. 21 x. At R 82 reverse SHR EOR 3 Sts. 21 x. Reset RC to R 82 and change to C 1 & C 3. Push 18 (26) [30] sts. at the left to WP and bring all sts. to the right to HP, then push to WP EOR 3 Sts. 21 x. At R 122 continue in St. St. to R 142 (148) [154] and shape neckline. BO center 24 [(28)] sts. and place all sts. to the left in HP. *On neckline edge decr. every R 1 St. 3x and EOR 1 St. 3x. At R 156 (162) [168] remove shoulder sts. on WY. Reset RC to R 142 (148) [154] and shape left side from *, reversing shaping.

FINISHING:

Close shoulder seams and attach sleeves. Close all remaining seams. Weave cord around neckline, bottom of sleeve and bottom of sweater following diagram.

CORD TRIM

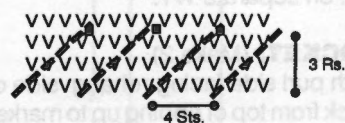

286

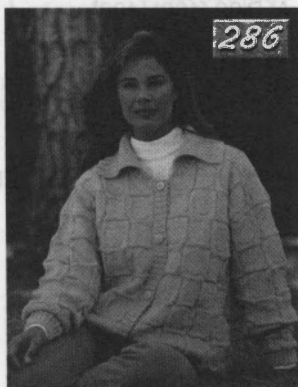

GOING IN STYLE

YARN: Alpine - Light Blue

SIZES:

Small (Medium) [Large]

AMOUNT: Same all sizes

3 Cones (approx 1-3/4 lb total)

KIT: Color of Your Choice

\$68.00

TENSION:

Body: T 9.1

Rib: T 8.2

GAUGE:

Body: 6.8 Sts., 9.7 Rs. = 1"

Rib: 10 Rs. = 1"

NOTIONS: 5 - 1" buttons.

TECHNIQUE: Garter Carriage

Make on Compuknit III, IV or V/Vcx Machine with Garter Carriage.

Note: Ribbing is built-in pattern #534.

BACK:

CO 144 (164) [184] sts. RC 0. T 8.2. Set G-Carriage for rib pattern and knit to R 15. RC 0. T 9.1. Set G-Carriage for pattern #1 and knit to R 14. Set G-Carriage for pattern #2. At R 70 place a YM on each side for pocket placement. At R 134 (156) [154] place a YM on each side for armhole. At R 238 (266) [266] mark center 50 (54) [58] sts. for neckline and remove neckline and shoulder sts. on separate WY.

POCKET: (Make 2)

With purl side facing rehang side of back from top of ribbing up to marker on 60 ndls. RC 0. T 8.2. St. St. K-Carr. Knit to R 64, knitting last row at T 10 and BOLT.

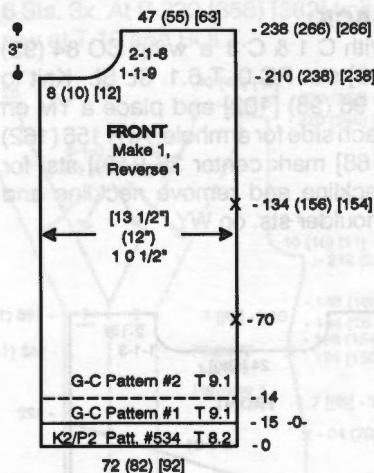
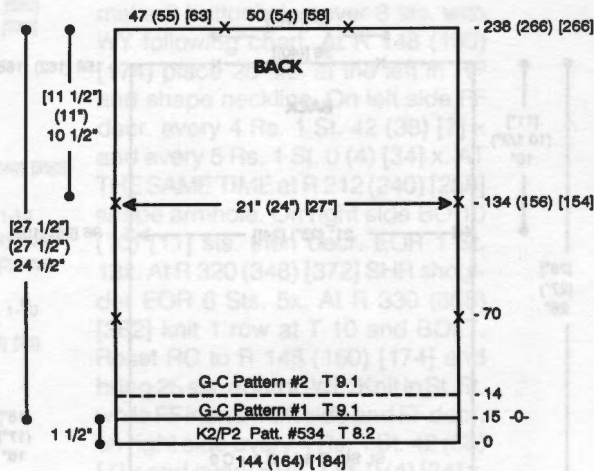
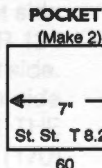

FRONT: Make 1, Reverse 1.

CO 72 (82) [92] sts. RC 0. T 8.2. Set G-Carriage for rib pattern and knit to R 15. RC 0. T 9.1. Set G-Carriage for pattern #1 and knit to R 14. Set G-Carriage for pattern #2. At R 70 place a YM on right side for pocket placement. At R 134 (156) [154] place a YM on right side for armhole. At R 210 (238) [238] shape neckline. On left side BO 8 (10) [12] sts. then decr. every R 1 St. 9x and EOR 1 St. 8x. At R 238 (266) [266] remove shoulder sts. on WY.

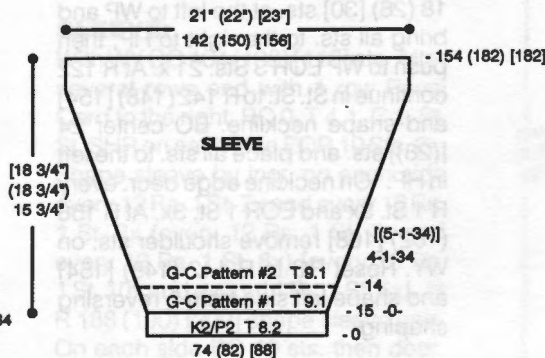

SLEEVE:

CO 74 (82) [88] sts. RC 0. T 8.2. Set G-Carriage for rib pattern and knit to R 15. RC 0. T 9.1. Set G-Carriage for pattern #1. Shape sleeve by incr. on each side every 4 Rs. 1 St. 34x [(every 5 Rs. 1 St. 34x)]. AT THE SAME TIME at R 14 set G-Carriage for pattern #2. At R 154 (182) [182] knit 1 row at T 10 and BOLT.

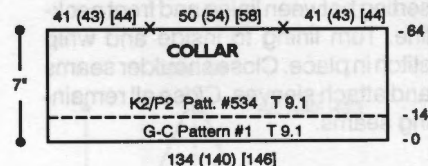

COLLAR:

Close shoulder seams first. CO 134 (140) [146] sts. RC 0. T 9.1. Set G-Carriage for pattern #1 and knit to R 14. Set G-Carriage for rib pattern and knit to R 64. With purl side facing rehang neckline on these ndls. following chart. Knit 1 row with K-Carriage at T 10 and BOLT.

FRONT PLACKET
Make 1 w/buttonholes, 1 w/o buttonholes

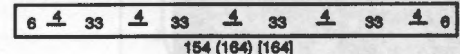

FRONT PLACKET: Make 1 w/buttonholes, 1 w/o buttonholes.

With purl side facing rehang right front on 154 (164) [164] ndls. RC 0. T 8.2. Set G-Carriage for rib pattern and knit to R 14 making buttonholes over 4 sts. with WY at R 7 following chart. Knit 1 row at T 10 and BOLT.

FINISHING:

Attach sleeves and attach pockets to front. Close all remaining seams. Finish buttonholes with a crochet hook.

#286 G-Carriage Pattern #1
24 Sts. x 14 Rows

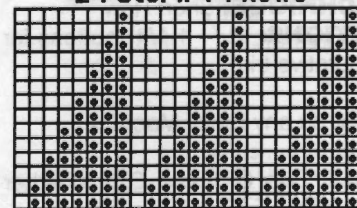

KK Mag Disk: Track 1;
Pattern 901

#286 6-Carriage Pattern #2
40 Sts. x 56 Rows

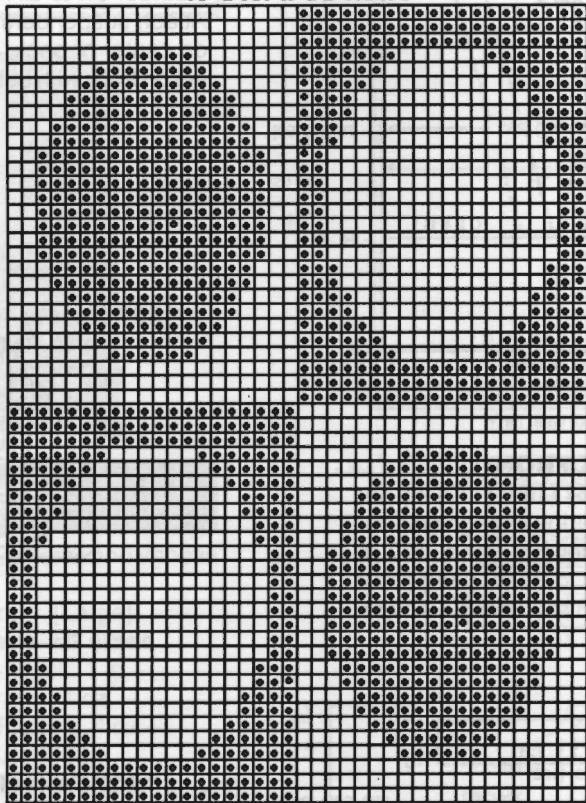

KK Mag Disk: Track 1; Pattern 901

287



SCENE STEALER

YARN: Venetia and Roma

SIZES:

6/8 (10/12) [14]

AMOUNT: Same all sizes

C 1: Venetia - Navy 2 lbs.

C 2: Roma - Lavender 1 lb.

TENSION:

Fairisle: T 7.1

Rib: T 2.1/2.1 I

GAUGE:

Fairisle: 8 Sts., 10.5 Rs. = 1"

Rib: 8 Sts., 13.4 Rs. = 1"

NOTIONS: 2 - 1-1/4" buttons and elastic for waistband.

TECHNIQUE: Fairisle

Make on Standard 24-Stitch Punch Card or Standard Electronic Machine with Ribber.

Note: Use C 2 in 'A' Feeder and C 1 in 'B' Feeder for fairisle.

SUSPENDERS: Make 2.

With C 1 CO 24 sts. for FNR. After selvedge arrange ndls. for rib pattern following chart. RC 0. T 2.1/2.1 I. Knit to R 500 and transfer RB sts. to MB. Knit 1 row at T 10 and BOLT.

SUSPENDERS Make 2
(Not to Scale) - 500

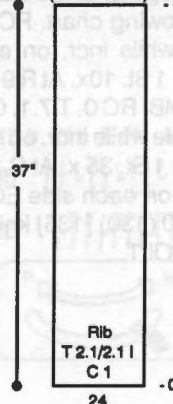

Floppy Disk Drive



The **Floppy Disk Drive** makes pattern work unbelievably easy. There are many programmed disks available from a variety of designers. In fact, several of the unique creations found on the pages of this magazine are available on disk. (Compuknit V, Compuknit/Bulky or Compuknit/ST owners will also need the KC/PPD optional accessory to transfer patterns).

Invest in a **Floppy Disk Drive** today... and start your own Design Collection tomorrow! — **ONLY \$379.95**

Direct Connection to Compuknit Vex



BACK:

With C 1 CO 168 (176) [184] sts. for FNR. After selvedge arrange ndls. for rib pattern following chart. RC 0. T 2.1/2.1 I. Knit to R 94 and transfer RB sts. to MB. RC 0. T 7.1. C 2 & C 1. Fairisle. Knit to R 78 (86) [90] and place a YM on each side for armhole. At R 180 (190) [200] mark center 64 [(72)] sts. for neckline. Remove neckline and shoulder sts. on separate WY.

FRONT:

Knit front same as back to R 148 (158) [168]. Shape neckline. Place center 28 [(36)] sts. in HP and all sts. to the left. Note pattern row. *On neckline edge SHR EOR 1 St. 8x and every R 1 St. 10x. At R 180 (190) [200] remove shoulder sts. on WY. Reset RC to R 148 (158) [168]. Reset pattern to row noted above and shape left side from *, reversing shaping. Remove neckline sts. on WY.

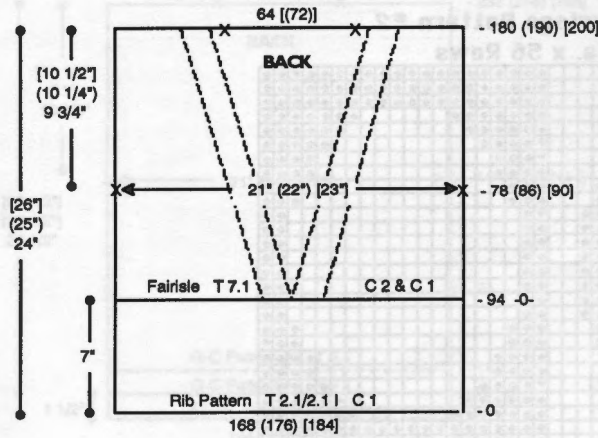

SKIRT BACK/FRONT:

With C 1 CO 154 (162) [170] sts. for FNR. After selvedge arrange ndls. for rib pattern following chart. RC 0. T 2.1/2.1 I. Knit to R 288 (298) [308] and transfer RB sts. to MB. Remove sts. on WY.

FINISHING:

Close remaining shoulder and attach sleeves. Close all remaining seams. Attach suspenders at top of ribbing on center of back. Attach suspenders on front with buttons (see photo).

***287 Needle Arrangement Rib Pattern**

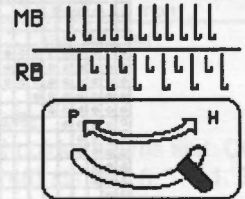

***287 Fairisle Pattern 24 Sts. x 60 Rows**

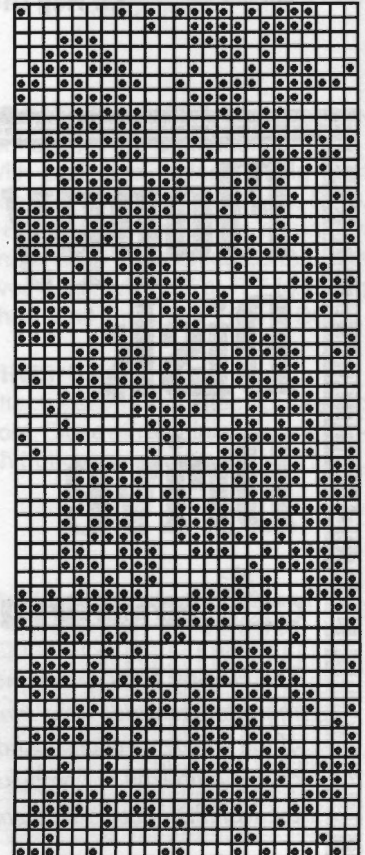

KK Mag Disk: Track 2; Pattern 90

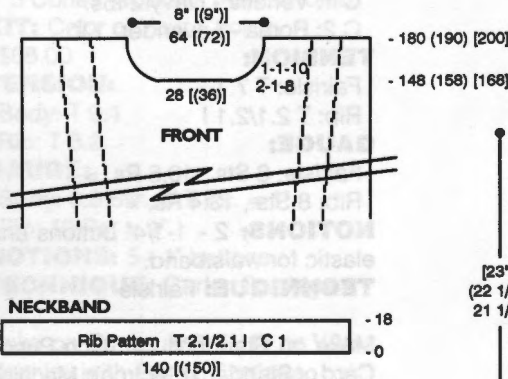

NECKBAND:

Close one shoulder. With C 1 CO 140 [(150)] sts. for FNR. After selvedge arrange ndls. for rib pattern following chart. RC 0. T 2.1/2.1 I. Knit to R 18 and transfer RB sts. to MB. With purl side facing rehang neckline on these ndls. Knit 1 row at T 10 and BOLT.

SLEEVE:

With C 1 CO 64 (72) [76] sts. for FNR. After selvedge arrange ndls. for rib pattern following chart. RC 0. T 2.1/2.1 I. Rib while incr. on each side every 8 Rs. 1 St. 10x. At R 94 transfer RB sts. to MB. RC 0. T 7.1. C 2 & C 1. Knit in fairisle while incr. on each side every 3 Rs. 1 St. 35 x. At R 110 (120) [126] SHR on each side EOR 2 Sts. 5x. At R 120 (130) [136] knit 1 row at T 10 and BOLT.

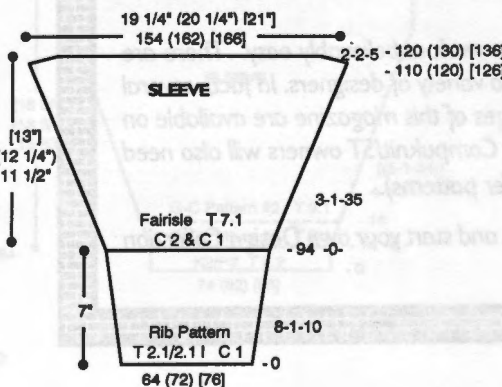

288



TWO'S COMPANY

YARN: Woolana, Roma and Venetia

SIZES:

Small (Medium) [Large]

AMOUNT: Same all sizes

C 1: Woolana - Black 1 lb.

C 2: Roma - Brown 4 oz.

C 3: Venetia - Paprika 4 oz.

C 4: Roma - Rust 4 oz.

C 5: Venetia - Toast 4 oz.

TENSION:

Body: T 6.1

Rib: T 3/3.1 I

GAUGE:

Body: 8.5 Sts., 9.9 Rows = 1"

Rib: 12 Rows = 1"

TECHNIQUE: Fairisle

Make on Standard 24-Stitch Punch Card or Standard Electronic Machine with Ribber.

BACK:

With C 1 CO 140 (146) [152] sts. for 2x1 Rib following ndl. chart. After selvedge RC 0. T 3/3.1 I. Knit to R 22 and remove sts. on WY. Bring 178 (188) [196] ndls. to WP. Rehang ribbing on these ndls. decr. evenly across. RC 0. T 6.1. Knit in fairisle following color chart. At R 168 (168) [174] place a YM on each side for armhole. At R 268 (272) [280] mark center 72 (76) [80] sts. for neckline. Remove neckline and shoulder sts. on separate WY.

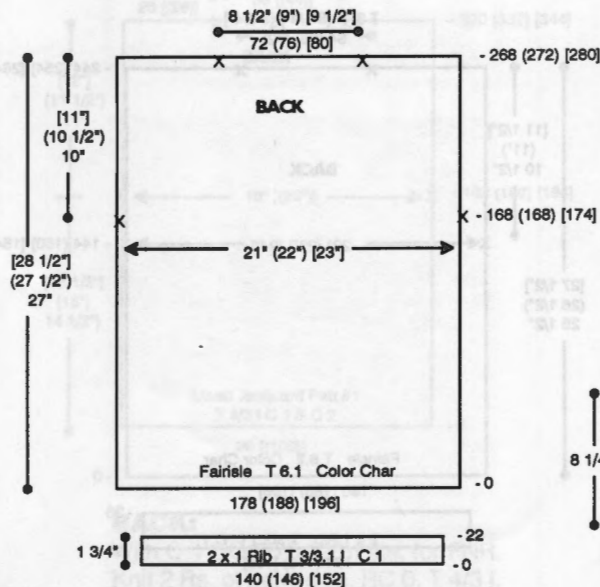

COLOR CHART

# Rows	MC	CC
8	1	5
8	1	4
8	1	3
8	1	2

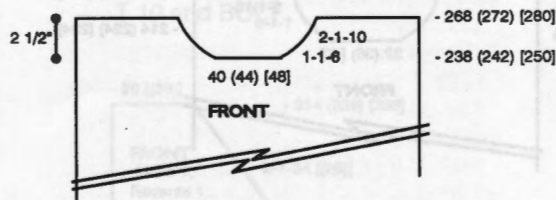

FRONT:

Knit front same as back to R 238 (242) [250]. Shape neckline. Place center 40 (44) [48] sts. in HP and all sts. to the left. Note pattern row. *On neckline edge decr. every R 1 St. 6x and EOR 1 St. 10x. At R 268 (272) [280] remove shoulder sts. on WY. Reset RC to R 238 (242) [250]. Reset pattern to row noted above and shape left side from *, reversing shapings. Remove neckline sts. on WY.

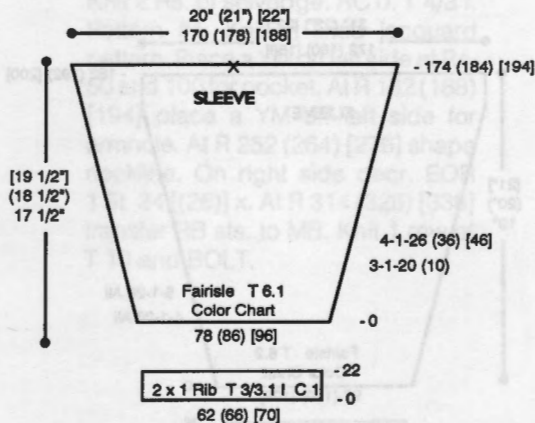

SLEEVE:

With C 1 CO 62 (66) [70] sts. for 2x1 Rib following ndl. chart. After selvedge RC 0. T 3/3.1 I. Knit to R 22 and remove sts. on WY. Bring 78 (86) [96] ndls. to WP. Rehang ribbing on these ndls. decr. evenly across. RC 0. T 6.1. Knit in fairisle following color chart while incr. on each side every 3 Rs. 1 St. 20 (10) x and every 4 Rs. 1 St. 26 (36) [46] x. At R 174 (184) [194] mark center and BO.

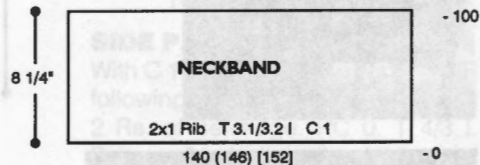

NECKBAND:

With C 1 CO 140 (146) [152] sts. for 2x1 Rib following ndl. chart. After selvedge RC 0. T 3.1/3.2 I. Knit to R 100 and remove sts. on WY.

FINISHING:

Close one shoulder and attach neckband. Close remaining shoulder and attach sleeves. Close all remaining seams.

***288/*299 Fairisle Pattern 24 Sts. x 32 Rows**

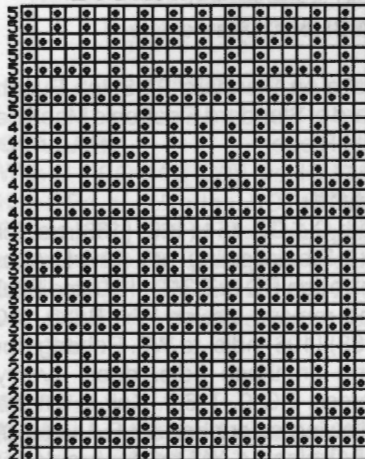

KK Mag Disk: Track 3; Pattern 901

***288/*289 Rib Ndl. Arrangement**

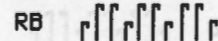

289



TWO'S COMPANY

YARN: Woolana, Roma and Venetia
SIZES:

Small (Medium) [Large]

AMOUNT: Same all sizes

- C 1: Woolana - Black 1 lb.
- C 2: Roma - Light Blue 4oz.
- C 3: Roma - Wedgewood 4 oz.
- C 4: Venetia - Royal 4 oz.
- C 5: Roma - Navy 4 oz.

TENSION:

- Body: T 6.2
- Rib: T 3/3.1 I

GAUGE:

- Body: 8.2 Sts., 9.6 Rows = 1"
- Rib: 12 Rows = 1"

TECHNIQUE: Fairisle

Make on Standard 24-Stitch Punch Card or Standard Electronic Machine with Ribber.

BACK:

With C 1 CO 154 (160) [166] sts. for 2x1 Rib following ndl. chart. After selvedge RC 0. T 3/3.1 I. Knit to R 36 and remove sts. on WY. Bring 180 (188) [196] ndls. to WP. Rehang ribbing on these ndls. decr. evenly across. RC 0. T 6.2. Knit in fairisle following color chart. At R 144 (150) [154] place a YM on each side for armhole. At R 244 (254) [264] mark center 64 (68) [72] sts. for neckline. Remove neckline and shoulder sts. on separate WY.

289 Rib Ndl. Arrangement

MB

RB

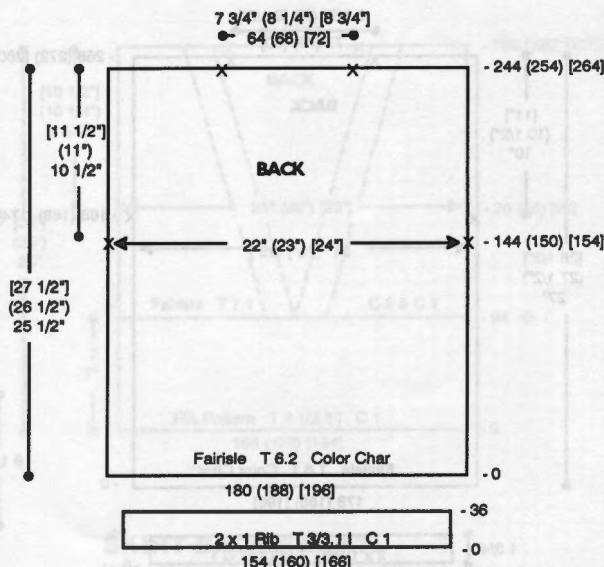

COLOR CHART

# Rows	MC	CC	Repeat
8	1	5	↑ Repeat
8	1	4	
8	1	3	
8	1	2	

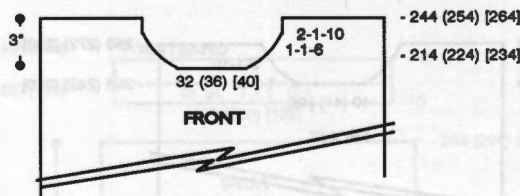

FRONT:

Knit front same as back to R 214 (224) [234]. Shape neckline. Place center 32 (36) [40] sts. in HP and all sts. to the left. Note pattern row. *On neckline edge decr. every R 1 St. 6x and EOR 1 St. 10x. At R 244 (254) [264] remove shoulder sts. on WY. Reset RC to R 214 (224) [234]. Reset pattern to row noted above and shape left side from *, reversing shapings. Remove neckline sts. on WY.

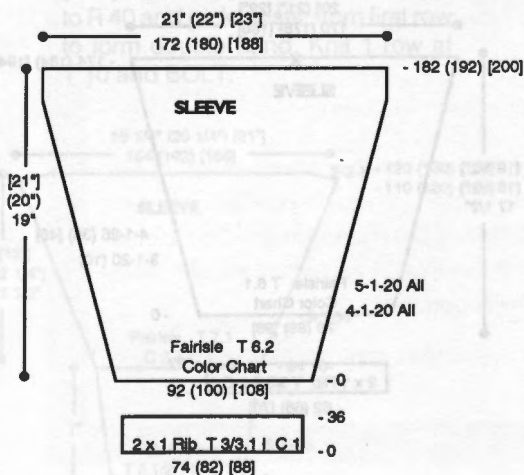

SLEEVE:

With C 1 CO 74 (82) [88] sts. for 2x1 Rib following ndl. chart. After selvedge RC 0. T 3/3.1 I. Knit to R 36 and remove sts. on WY. Bring 92 (100) [108] ndls. to WP. Rehang ribbing on these ndls. decr. evenly across. RC 0. T 6.2. Knit in fairisle following color chart while incr. on each side every 4 Rs. 1 St. 20x and every 5 Rs. 1 St. 20x for all sizes. At R 182 (192) [200] BO.

NECKBAND

2x1 Rib T 3/3.1 C 1	-20
154 (160) [166]	-0

NECKBAND:

With C 1 CO 154 (160) [166] sts. for 2x1 Rib following ndl. chart. After selvedge RC 0. T 3/3.1 I. Knit to R 20 and remove sts. on WY.

FINISHING:

Close one shoulder and attach neckband. Close remaining shoulder and attach sleeves. Close all remaining seams.

Make Life Easier ... Let a Knitleader Work for YOU!



With a KL 16 Knitleader, you can create a full-size chart of the garment you are knitting. And, as you knit, the chart rotates, telling you, on a row-by-row basis, exactly when and where to increase and decrease stitches for perfect garment shaping every time. Use it with any Knitting Standard or Bulky Gauge machines—it will even fit on the Power Drive Unit.



See your local Knitting Dealer or contact Knitting to order.

290



FREE SPIRIT

YARN: Woolana - Use 2 strands throughout

SIZES: Small (Medium) [Large]
AMOUNT: Same all sizes

C 1: Black - 1 lb. (1 cone)
 C 2: Petrol - 1 lb. (1 cone)

KIT: Color of Your Choice
 \$60.00

TENSION: FNR: T 4/3 I

GAUGE: FNR: 5 Sts., 12.5 Rs. = 1"

NOTIONS: 26" [(28")] sport zipper
TECHNIQUE: FNR with Color Changer

Make on Compuknit/Bulky Machine with Ribber and Ribber Color Changer.

Note: Use KRC key. Make sure 'Left' end ndl. selector is ON. Use knitting bar and end stitch supporter. Use 2 strands throughout.

LINED JACQUARD PATTERN:

1. Select Pattern from left to right with C 1. COR. Depress both part buttons - RB buttons up "PR" both sides. Knit 1 R.
2. Memo Window #2. Change to C 2. RB buttons to "N" position both sides. Knit 2 Rs.
3. Memo Window #1. Change to C 1. RB buttons up to "PR" both sides. Knit 2 Rs.
4. Repeat steps 2 & 3.

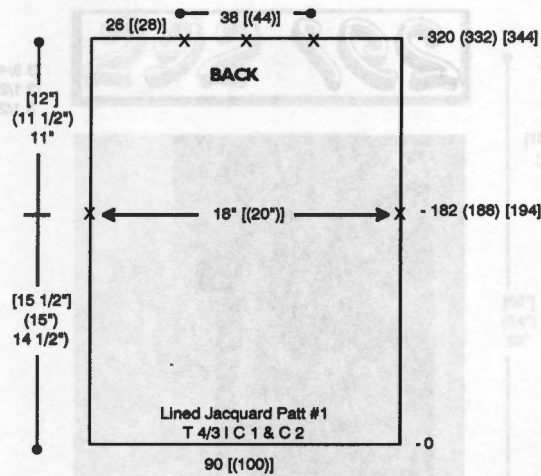

BACK:

With C 1 CO 90 [(100)] sts. for FNR. Knit 2 Rs. of selvedge. RC 0. T 4/3 I. Pattern #1. Knit in lined jacquard pattern. At R 182 (188) [194] place a YM on each side for armhole. At R 320 (332) [344] mark center and center 38 [(44)] sts. for neckline. Transfer RB sts. to MB. Knit 1 row at T 10 and BOLT.

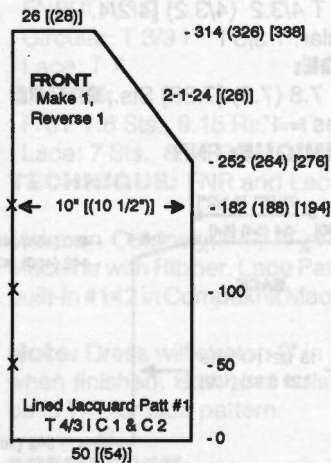

FRONT:

Make 1, Reverse 1. With C 1 CO 50 [(54)] sts. for FNR. Knit 2 Rs. of selvedge. RC 0. T 4/3 I. Pattern #1. Knit in lined jacquard pattern. Place a YM on left side at Rs. 50 and 100 for pocket. At R 182 (188) [194] place a YM on left side for armhole. At R 252 (264) [276] shape neckline. On right side decr. EOR 1 St. 24 [(26)] x. At R 314 (326) [338] transfer RB sts. to MB. Knit 1 row at T 10 and BOLT.

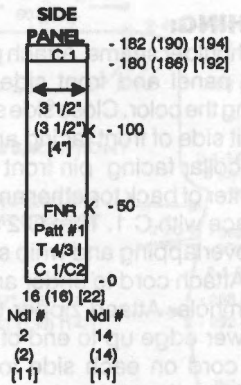

SIDE PANEL: Make 1, Reverse 1. With C 1 CO 16 (16) [22] sts. for FNR following ndl. numbers on chart. Knit 2 Rs. of selvedge. RC 0. T 4/3 I. Pattern #1. Knit in lined jacquard pattern. Place a YM on right side at Rs. 50 and 100 for pocket. At R 180 (186) [192] transfer RB sts. to MB. With C 1 knit 2 Rs., knitting last row at T 8 and BOLT.

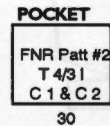

POCKET:

Make 2. With C 1 CO 30 sts. for FNR. Knit 2 Rs. of selvedge. RC 0. T 4/3 I. Pattern #2. Knit in lined jacquard pattern to R 60. Remove each side on separate WY.

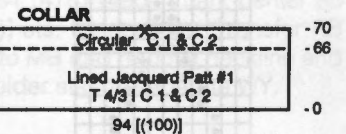

COLLAR:

With C 1 CO 94 [(100)] sts. for FNR. Knit 2 Rs. of selvedge. RC 0. T 4/3 I. Pattern #1. Knit in lined jacquard pattern to R 66. Change to circular knitting. Knit 2 Rs. with C 1 and 2 Rs. with C 2. Remove each side on separate WY.

CORD:

Under Arm/Side Armhole: With C 1 'e' wrap CO 7 Sts. T 3. St. St. Knit 2 pieces 56" long and 2 pieces 3 1/2" long.

Front Placket: With C 1 'e' wrap CO 6 Sts. T 3. St. St. Knit 2 pieces 28" (28") [30"] long.

Lower Edge: With C 1 'e' wrap CO 8 Sts. T 3. St. St. Knit 1 piece 60" long

FINISHING:

Close shoulder seams. Attach pocket to side panel and front side seam matching the color. Close side seams. With knit side of front facing and purl side of collar facing pin front edges and center of back together and whip st in place with C 1. Turn C 2 side to inside overlapping and whip stitch in place. Attach cord to under arm and side armhole. Attach zipper to front from lower edge up to end of collar. Attach cord on each side to cover zipper. Attach cord to lower edge. When attaching cord begin with CO edge so you can unravel unused end or rehang and make longer if necessary.

291



SLEEK CHIC

YARN: GlacePlus - Black

SIZES:

6/8 (10/12) [14]

AMOUNT: Same all sizes

3 Cones (approx. 4-1/2 lb.)

KIT: Color of your Choice

\$115.00

TENSION:

FNR: T 4/3.2 (4/3.2) [4.2/4.1] |

Circular: T 3/3 |

GAUGE:

FNR: 7.8 (7.8) [7.35] Sts., 9.15 Rs.

all sizes = 1"

TECHNIQUE: FNR

***290 Jacquard Pattern**
12 Sts. x 24 Rows

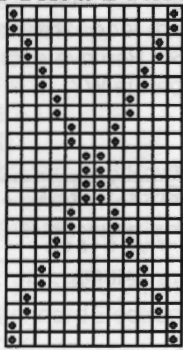

KK Mag Disk:
Track 4
Pattern 901

***290 Pocket Pattern**
1 St. x 1 Row

KK Mag Disk:
Track 4
Pattern 902

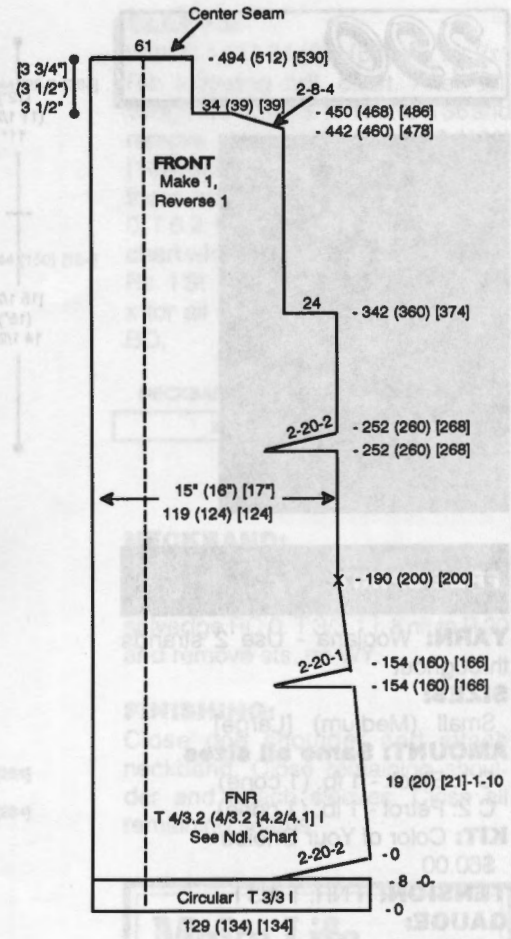

Make on any Standard Machine with Ribber.

Note: Coat will stretch 1" to 1-1/2" in length when finished.

BACK:

CO 190 (200) [200] sts. at T 0/0 | for circular knitting. After selvedge RC 0. T 3/3 |. Knit to R 8 and arrange ndls. for pattern following chart. RC 0. T 4/3.2 (4/3.2) [4.2/4.1] |. SHR on each side EOR 20 Sts. 2x. RC 0. Decr. on each side every 19 (20) [21] Rs. 1 St. 10x. At R 154 (160) [166] turn RC OFF and SHR on each side EOR 20 Sts. 1x. Turn RC ON and continue to R 190 (200) [200] and place a YM on each side. At R 252 (260) [268] turn RC OFF and SHR on each side EOR 20 Sts. 2x. Turn RC ON and continue to R 342 (360) [374] and shape armhole. On each side BO 24 sts. At R 442 (460) [478] SHR shoulders EOR 8 Sts. 4x. At R 450 (468) [486] mark center 54 (54) [54] sts. for neckline and remove neckline and shoulder sts. on separate WY.

FRONT: Make 1, Reverse 1.

CO 129 (134) [134] sts. at T 0/0 | for circular knitting. After selvedge RC 0. T 3/3 |. Knit to R 8 and arrange ndls.

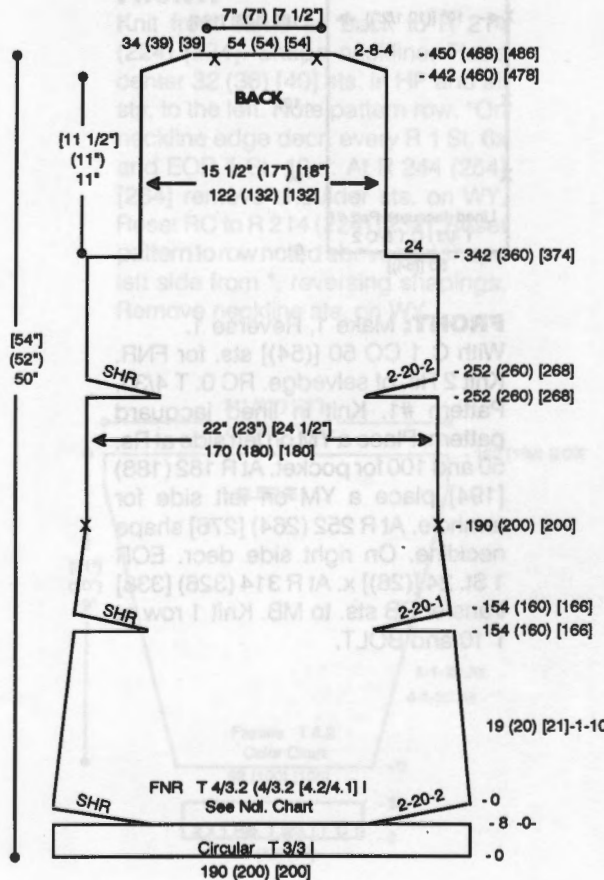

292



for pattern following chart. RC 0. T 4/3.2 (4/3.2) [4.2/4.1] l. SHR on right side EOR 20 Sts. 2x. RC 0. Decr. on right side every 19 (20) [21] Rs. 1 St. 10x. At R 154 (160) [166] turn RC OFF and SHR on right side EOR 20 Sts. 1x. Turn RC ON and continue to R 190 (200) [200] and place a YM on right side. At R 252 (260) [268] turn RC OFF and SHR on right side EOR 20 Sts. 2x. Turn RC ON and continue to R 342 (360) [374] and shape armhole. On right side BO 24 sts. At R 442 (460) [478] SHR shoulder EOR 8 Sts. 4x. At R 450 (468) [486] BO 34 (39) [39] sts. at right. Continue to R 494 (512) [530] and remove sts. on WY.

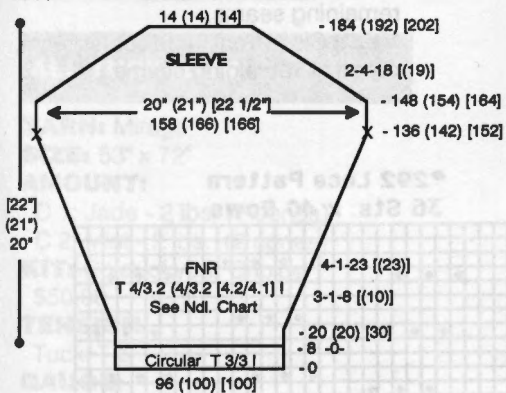

SLEEVE:

CO 96 (100) [100] sts. at T 0/0 l for circular knitting. After selvedge RC 0. T 3/3 l Knit to R 8 and arrange ndls. for pattern following chart. RC 0. T 4/3.2 (4/3.2) [4.2/4.1] l. Knit to R 20 (20) [30] and start incr. on each side every 3 Rs. 1 St. 8 [(10)] x and every 4 Rs. 1 St. 23 [(23)] x. At R 136 (142) [152] place a YM on each side. At R 148 (154) [164] shape sleeve cap. On each side SHR EOR 4 Sts. 18 [(19)] x. At R 184 (192) [202] transfer RB sts. to MB. Knit 1 row at T 5 and BOLT.

FINISHING:

Join center seam of neckband and attach neckband to back neckline. Close shoulder seams. Fold neckband and front edge to inside and whip stitch in place. Attach sleeves and close all remaining seams.

#291

Needle Arrangement

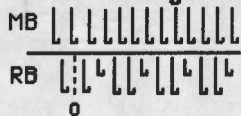

FORMAL SETTING

YARN: GlacePlus-Dk. Champagne
SIZES: 6/8 (10/12) [14]

AMOUNT: Same all sizes
3 Cones (approx. 4-1/2 lb.)

KIT: Color of your Choice
\$115.00

TENSION:
FNR: T 4/3.2 l
Circular: T 3/3 l
Lace: T 7

GAUGE:
FNR: 7.8 Sts., 9.15 Rs. = 1"
Lace: 7 Sts., 8.76 Rs. = 1"
TECHNIQUE: FNR and Lace

Make on Compuknit III, IV or V/Vcx Machine with Ribber. Lace Pattern is built-in #142 in Compuknit Machines.

Note: Dress will stretch 2" in length when finished. Both end ndls. must be in WP for lace pattern.

DRESS BACK:

CO 127 (135) [143] sts. at T 0/0 l for circular knitting. After selvedge RC 0. T 3/3 l. Knit to R 8 and arrange ndls. for pattern following chart. RC 0. T 4/3.2 l. SHR on each side EOR 20 Sts. 1x. At R 10 (16) [22] start incr. on each side every 16 Rs. 1 St. 10x. At R 170 (176) [182] place a YM on each side for aid in seaming. At R 230 (240) [250] start decr. on each side every 8 Rs. 1 St. 8x. At R 292 (304) [316] place a YM on each side for waist. At R 298 (310) [322] start incr. on each side every 8 Rs. 1 St. 8x. At R 362 (374) [386] turn RC OFF and SHR on each side EOR 20 Sts. 1x. Turn RC ON and continue to R 368 (380) [392] and shape armhole. On each side BO 6 (6) [8] Sts. then decr.

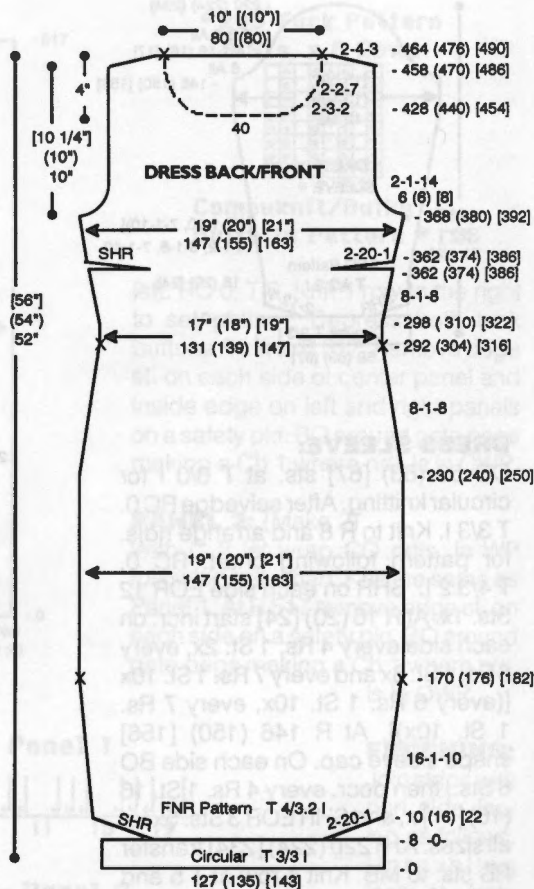

EOR 1 St. 14x. At R 458 (470) [486] SHR shoulders EOR 4 Sts. 3x. At R 464 (476) [490] mark center 80 [(80)] sts. for neckline. Transfer RB sts. to MB and remove neckline and shoulder sts. on separate WY.

DRESS FRONT:

Knit front same as back to R 428 (440) [454] and shape neckline. BO center 40 sts. and place all sts. to the left in HP. *On neckline edge SHR EOR 3 Sts. 2x and 2 Sts. 7x. At R 458 (470) [486] SHR shoulder EOR 4 Sts. 3x. At R 464 (476) [490] transfer RB sts. to MB and remove shoulder sts. on WY. Reset RC to R 428 (440) [454] and shape left side from *, reversing shapings. Remove neckline sts. on WY.

DRESS NECKBAND

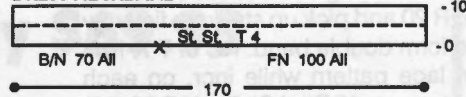

DRESS NECKBAND:

Close one shoulder. With purl side facing rehang neckline on 170 ndls. following chart. RC 0. T 4. St. St. Knit to R 10 and pick up sts. from first row to form double band. Knit 1 row at T 10 and BOLT.

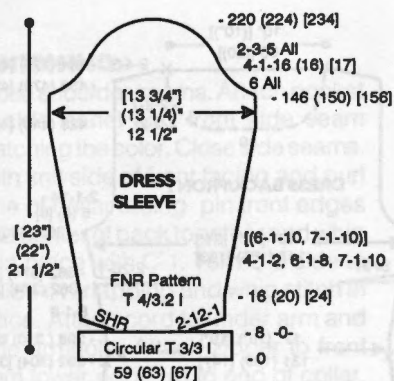

DRESS SLEEVE:

CO 59 (63) [67] sts. at T 0/0 I for circular knitting. After selvedge RC 0. T 3/3 I. Knit to R 8 and arrange ndls. for pattern following chart. RC 0. T 4/3.2 I. SHR on each side EOR 12 Sts. 1x. At R 16 (20) [24] start incr. on each side every 4 Rs. 1 St. 2x, every 6 Rs. 1 St. 8x and every 7 Rs. 1 St. 10x [(every 6 Rs. 1 St. 10x, every 7 Rs. 1 St. 10x)]. At R 146 (150) [156] shape sleeve cap. On each side BO 6 Sts., then decr. every 4 Rs. 1 St. 16 (16) [17] x, and SHR EOR 3 Sts. 5x for all sizes. At R 220 (224) [234] transfer RB sts. to MB. Knit 1 row at T 5 and BOLT.

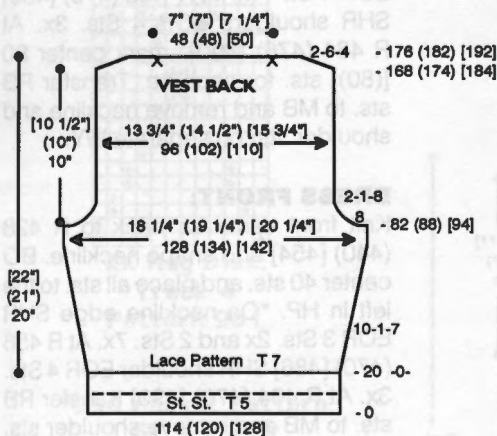

VEST BACK:

With WY CO 114 (120) [128] sts. After several rows end with 1 row Ravel Cord to the right. RC 0. T 5. St. St. Knit to R 20 and pick up sts. from first row to form double band. RC 0. T 7. Knit in lace pattern while incr. on each side every 10 Rs. 1 St. 7x. At R 82 (88) [94] shape armhole. On each side BO 8 Sts. then decr. EOR 1 St. 8x. At R 168 (174) [184] SHR shoulders EOR 6 Sts. 4x. At R 176 (182) [192] mark center 48 (48) [50] sts. for neckline and remove neckline and shoulder sts. on separate WY.

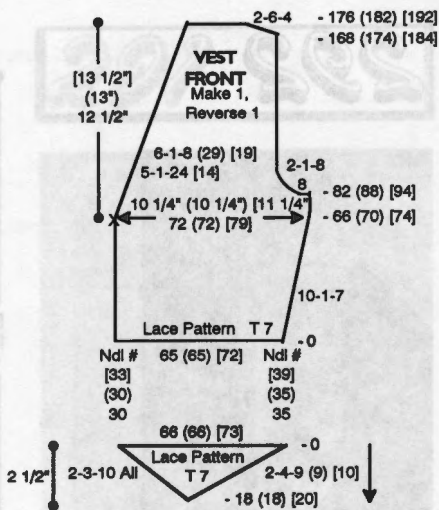

VEST FRONT: Make 1, Reverse 1.

With WY CO 65 (65) [72] sts. following chart for ndl. #. After several rows end with 1 row Ravel Cord to the left. RC 0. T 7. Knit in lace pattern while incr. on right side every 10 Rs. 1 St. 7x. AT THE SAME TIME at R 66 (70) [74] shape front opening. On left side decr. every 5 Rs. 1 St. 24 [14] x and every 6 Rs. 1 St. 8 (29) [19] x. AT THE SAME TIME at R 82 (88) [98] shape armhole. On right side BO 8 Sts. then decr. EOR 1 St. 8x. At R 168 (174) [184] SHR shoulder EOR 6 Sts. 4x. At R 176 (182) [192] remove shoulder sts. on WY. With purl side facing rehang lower edge of front on 66 (66) [73] ndls. starting at ndl. # 30 (30) [33] to the left of -0-. RC 0. T 7.

Knit 1 row with K-Carriage. Select Upside Down and Reverse Variation Keys. Knit in lace pattern while decr. on left side EOR 3 Sts. 10 x manually knitting sts. to 'A' position on Ravel Cord. AT THE SAME TIME on right side decr. EOR 4 Sts. 9 (9) [10] x manually knitting sts. to 'A' position on Ravel Cord. At R 18 (18) [20] remove all sts. on WY.

VEST BOTTOM HEM:

With purl side facing rehang lower edge of front on 60 (60) [68] ndls. RC 0. T 5. St. St. Knit to R 20 and pick up sts. from first row to form double band. Knit 1 row at T 10 and BOLT.

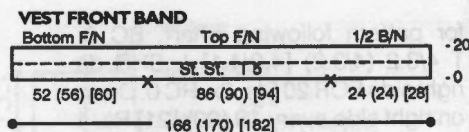

VEST FRONT BAND: Make 2.

Close shoulder seams. With purl side facing rehang front edge and half of back neckline on 166 (170) [182] ndls. following chart for placement. RC 0. T 5. St. St. Knit to R 20 and pick up sts. from first row to form double band. Knit 1 row at T 10 and BOLT.

FINISHING:

Dress: Close remaining shoulder seam Attach sleeves and close all remaining seams.

Vest: Close front band center seam. Close all remaining seams.

#292 Lace Pattern 36 Sts. x 40 Rows

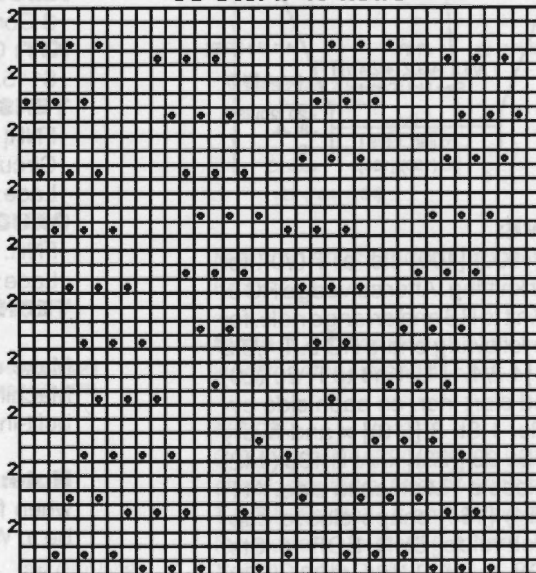

Compuknit III, IV, V/Vcx Built-in Pattern #142

#292 Needle Arrangement

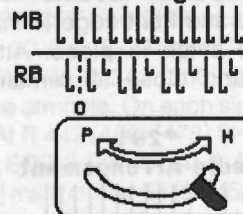

293



ALL TUCKED IN

YARN: Mirage

SIZE: 53" x 72"

AMOUNT:

C 1: Jade - 2 lbs. (2 cones)

C 2: Mint - 2 lbs. (2 cones)

KIT: Color of your Choice

\$50.00

TENSION:

Tuck: T 6

GAUGE:

Tuck: 4.3 Sts., 7.2 Rs. = 1"

TECHNIQUE: Tuck

Make on Compuknit/Bulky or Punch Card Bulky Machine.

Note: Tuck is Built-in Pattern #125 in Compuknit/Bulky Book. Do **NOT** block panels until they have been joined.

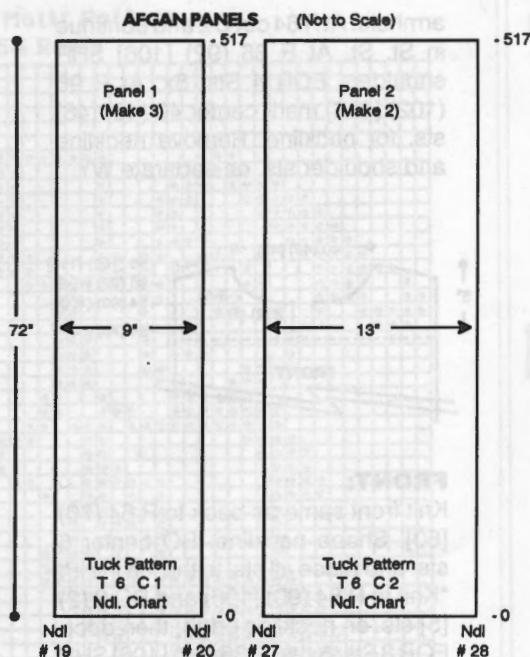

#293 Needles Arrangement - Panel 1

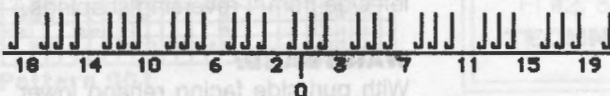

#293 Needle Arrangement - Panel 2

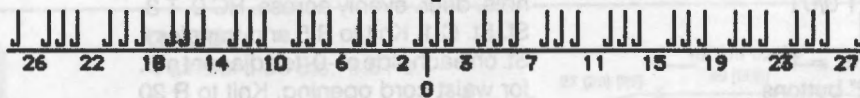

PANEL 1: (Make 3)

With C 1 'e' wrap CO ndls. in WP following ndl. chart. Knit 1 row to the

#293 Tuck Pattern 8 Sts. x 8 Rows

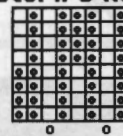

Compuknit/Bulky Built-in Pattern #125

left. RC 0. T 6. Knit 1 row to the right to set pattern. Depress both tuck buttons. Knit to R 517. Remove edge st. on each side of center panel and inside edge on left and right panels on a safety pin. BO around gate pegs making a Ch 1 where ndl. is in OWP.

PANEL 2: (Make 2)

With C 2 'e' wrap CO ndls. in WP following ndl. chart. Knit the same as Panel 1. At R 517 remove edge st. on each side on a safety pin. BO around gate pegs making a Ch 1 where ndl. is in OWP.

FINISHING:

Join strips with purl side facing as follows. Unraveling loop st. from top, pull 3 loops from one panel through 3 loops of the other panel

with latch tool. Unraveling as you go, continue until strips are joined. Make 4" fringe and attach along each end of afghan.

The KK 3 Knitting Machine Stand has been specially-designed to accommodate either a Standard gauge or a Bulky gauge knitting machine. Its construction provides both a strong and stable support, with rubber feet to eliminate sliding. Table clamp guides are positioned to align properly with Knitking or Brother machines (standard or bulky), and rear-facing shelf standards allow you to use your case cover as a convenient shelf. A Great Value!!

Only \$69.95

STAND STRONG

Call your local Knitking Dealer, or contact Knitking at 800-962-6446





FOR THOSE WHO THINK YOUNG

YARN: Mirage

SIZES:

6/7 (8/10) [12/14]

AMOUNT:

C 1: Raspberry
1 cone [(2 cones)]
(cones approx. 1 lb. each)

C 2: White - 2 oz. all sizes

TENSION:

Body: T 3.1; Rib: T 0/0 I

GAUGE:

Body: 5 Sts., 6.4 Rs. = 1"

NOTIONS: 2 - 1/2" buttons

TECHNIQUE: Single Motif Fairisle

Make on Compuknit/Bulky Machine with Ribber.

armhole. At R 64 cut C 2 and continue in St. St. At R 86 (92) [106] SHR shoulders EOR 4 Sts. 5x. At R 96 (102) [116] mark center 40 (40) [46] sts. for neckline. Remove neckline and shoulder sts. on separate WY.

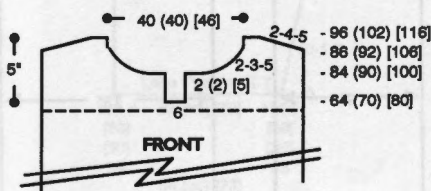

FRONT:

Knit front same as back to R 64 (70) [80]. Shape neckline. BO center 6 sts. and place all sts. to the left in HP. *Knit to R 84 (90) [100] and BO 2 (2) [5] sts. on neckline edge, then decr. EOR 3 Sts. 5x. At R 86 (92) [106] SHR shoulder EOR 4 Sts. 5x. At R 96 (102) [116] remove shoulder sts. on WY. Reset RC to R 64 (70) [80] and shape left side from *, reversing shapings.

WAISTBAND:

With purl side facing rehang lower edge of back/front on 66 (70) [80] ndls. decr. evenly across. RC 0. T 3. St. St. C 1. Knit to R 5 and transfer 1 St. on each side of -0- to adjacent ndl. for waist cord opening. Knit to R 20 and pick up sts. from first row to form double band. Knit 1 row at T 10 and BOLT.

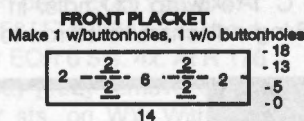

FRONT PLACKET: Make 1 w/buttonholes, 1 w/o buttonholes.

With purl side facing rehang right side of front opening on 14 ndls. RC 0. T 3. St. St. C 1. Knit to R 18 making buttonholes over 2 sts. at R 5 and R 13 following chart. Pick up sts. from first row to form double band. Knit 1 row at T 10 and BOLT.

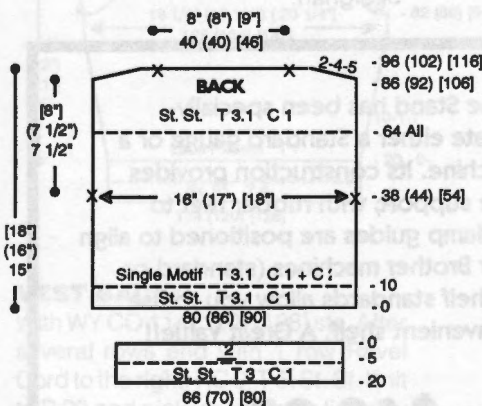

BACK:

With WY CO 80 (86) [90] sts. After several rows end with 1 row Ravel Cord to the right. RC 0. T 3.1. C 1. St. St. Knit to R 10 and start single motif pattern with C 1 and C 2. At R 38 (44) [54] place a YM on each side for

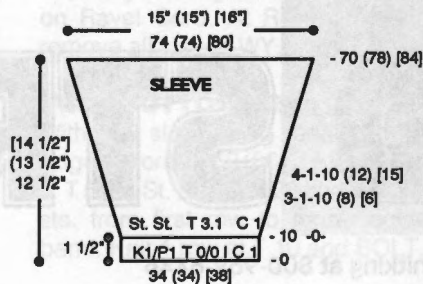

SLEEVE:

With C 1 CO 34 (34) [38] sts. for K1/P1 rib. After selvedge RC 0. T 0/0 I. Knit to 10 and transfer RB sts. to MB. RC 0. T 3.1. Knit in St. St. while incr. on each side every 3 Rs. 1 St. 10 (8) [6] x and every 4 Rs. 1 St. 10 (12) [15] x. At R 70 (78) [84] BO sts.

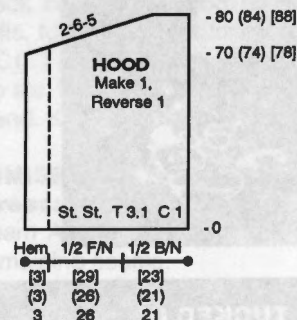

HOOD: Make 1, Reverse 1.

Close shoulder seams. With purl side facing rehang front placket, 1/2 front neck and 1/2 back neck on 50 (50) [55] ndls. following chart. RC 0. T 3.1. St. St. C 1. Knit to R 70 (74) [78] and SHR on left side EOR 6 Sts. 5x. At R 80 (84) [88] knit 1 row at T 10 and BOLT.

CORD:

With 2 strands of C 1 make Ch 1 cords for waist and neck either manually or with crochet hook.

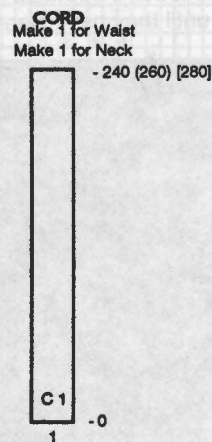

FINISHING:

Attach sleeves. Close center seam on hood and close all remaining seams. Turn 3 st. hem on hood to inside and whip st. in place. Put cord through waistband and hood hem.

***294 Fairisle Motif Pattern**
60 Sts. x 54 Rows

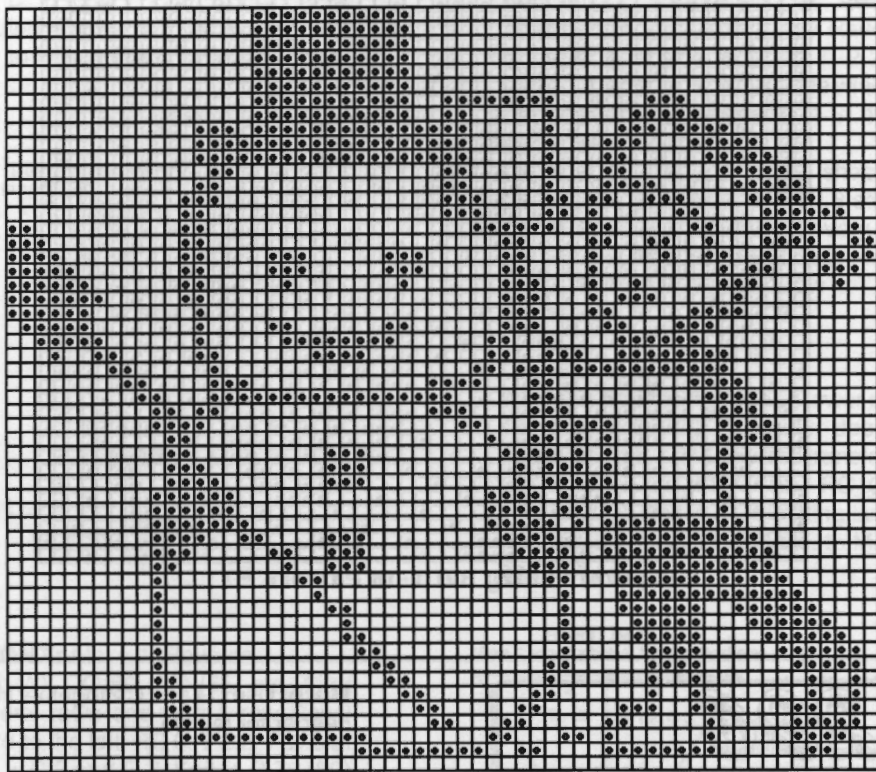

KK Mag Disk: Track 5; Pattern 901

knitting Correction
magazine

The following information was inadvertently left out of the last issue (Volume 28, Issue 2). Accept our apologies and please place this information in your copy.

Volume 28, Issue 2
Pattern #278 — Page 38

TWO PIECE OR NOT TWO PIECE

YARN: Woolana and Softon
SIZES:

6/8 (10/12) [14]

AMOUNT: Same all sizes

C 1: Woolana - Navy - 1 lb.

C 2: Softon - Khaki - 2 lbs.

KIT: Color of your Choice

\$68.00

TENSION:

Fairisle: T 6

GAUGE:

Fl #1: 8.5 Sts., 10.5 Rs. = 1"

Fl #2: 8.5 Sts., 11 Rs. = 1"

TECHNIQUE: Fairisle

295



SPLIT DECISION

YARN: Venetia and Alpine

SIZES:

Small (Medium) [Large]

AMOUNT: Same all sizes

C 1: Venetia - Chocolate 1/2 lb.

C 2: Venetia - Charcoal 1/2 lb.

C 3: Alpine - Black 1-3/4 lb.

(2 Cones)

C4: Knit-in elastic - Black - 1 spool

TENSION:

Fairisle: T 2.1; Rib: -0/-0 l

GAUGE:

Fairisle: 4.58 Sts., 6.9 Rs.
= 1"

TECHNIQUE: Fairisle

Make on Compuknit/Bulky with ribber. Pattern is built-in #11 in Compuknit/Bulky.

Note: Use C1 and C2 together in 'A' Feeder for fairisle.

BACK:

With C3 & C4 CO 96 (100) [106] sts. for K2/P2 rib. After selvedge RC 0. T -0/-0. Knit to R30 cut C4 and transfer RB sts. to MB. RC 0. T 2.1. Fairisle. C1 + C2

and C3. Incr. 2 sts. on each side. Knit to R 78 (82) [88] and place a YM on each side for armhole. At R 154 (162) [168] SHR shoulders EOR 6 Sts. 4x. At R 162 (170) [176] mark center 46 [(48)] sts. for neckline and remove neckline and shoulder sts. on separate WY.

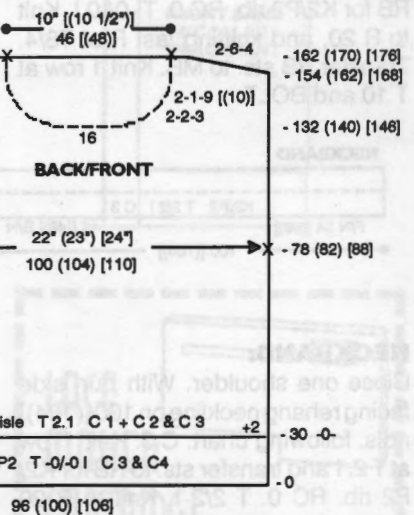

96 (100) [106]

FRONT:

Knit front same as back to R 132 (140) [146]. Shape neckline. Place center 16 sts. in HP and all sts. to the left. Note pattern row. *On neckline edge SHR EOR 2 Sts. 3x and 1 St. 9 [(10)] x. At R 154 (162) [168] SHR shoulder EOR 6 Sts. 4x. At R 162 (170) [176] remove shoulder sts. on WY. Reset RC to R 132 (140) [146] and pattern to row noted above. Shape left side from *, reversing shapings. Remove neckline sts. on WY.

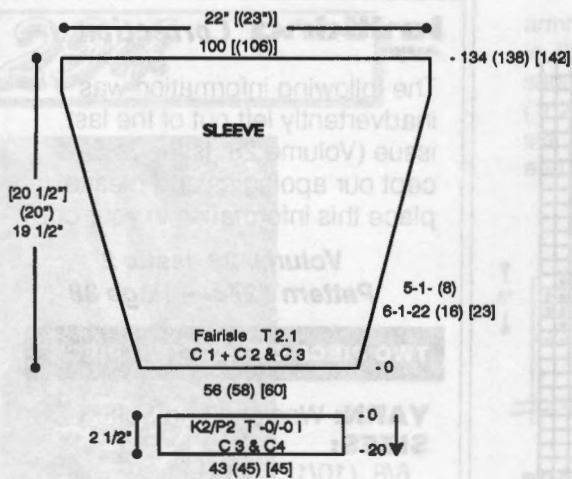

SLEEVE:

With WY CO 56 (58) [60] sts. After several rows end with 1 row Ravel Cord to the left. RC 0. T 2.1. C 1 + C 2 and C 3. Knit in fairisle while incr. on each side every 6 Rs. 1 St. 22 (16) [23] x and every 5 Rs. 1 St. (8) x. At R 134 (138) [142] knit 1 row at T 10 and BOLT.

CUFF:

With purl side facing rehang lower edge of sleeve on 43 (45) [45] ndls. decr. evenly across. C 3 and C4. Knit 1 row at T 2.1 and transfer sts. to RB for K2/P2 rib. RC 0. T -0/-0.1. Knit to R 20, and knitting last R at T8/4. Transfer RB sts. to MB. Knit 1 row at T 10 and BOLT.

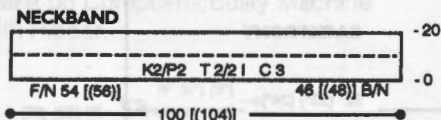

NECKBAND:

Close one shoulder. With purl side facing rehang neckline on 100 [(104)] ndls. following chart. C 3. Knit 1 row at T 2.1 and transfer sts. to RB for K2/P2 rib. RC 0. T 2/2.1. Knit to R 20 knitting last row at T 8/4. Transfer RB sts. to MB and BOLT.

FINISHING:

Close remaining shoulder seam and attach sleeves. Close all remaining seams. Fold neckband in half to inside and whip stitch in place. Apply gentle steam to ribbed waistband and cuffs to shrink knit-in elastic in place.

#295/296 Fairisle Pattern
53 Sts. x 40 Rows

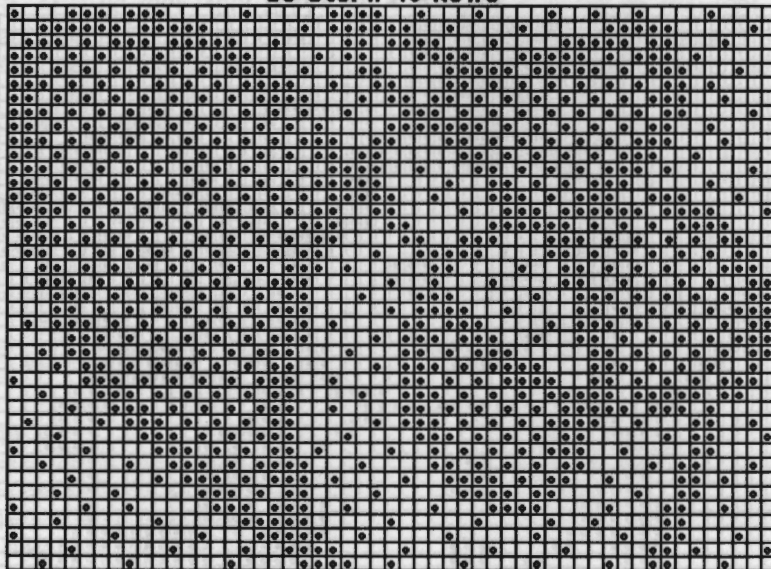

Compuknit Bulky Built-in Pattern #11

296



SPLIT DECISION

YARN: Venetia and Alpine

SIZES:

6/8 (10/12) [14]

AMOUNT: Same all sizes

C 1: Venetia - Taupe Tweed 1/2 lb.

C 2: Venetia - Charcoal 1/2 lb.

C 3: Alpine - Black -2 cones (approx. 1-3/4 lb.)

TENSION:

Body: T 2.2

GAUGE:

Body: 4.78 Sts., 7.27 Rs. = 1"

NOTIONS: 5 - 1" buttons

TECHNIQUE: Fairisle

Make on Compuknit/Bulky with Ribber. Pattern is built-in #11 in Compuknit/Bulky.

Note: Use C 1 and C 2 together in 'A' Feeder for fairisle.

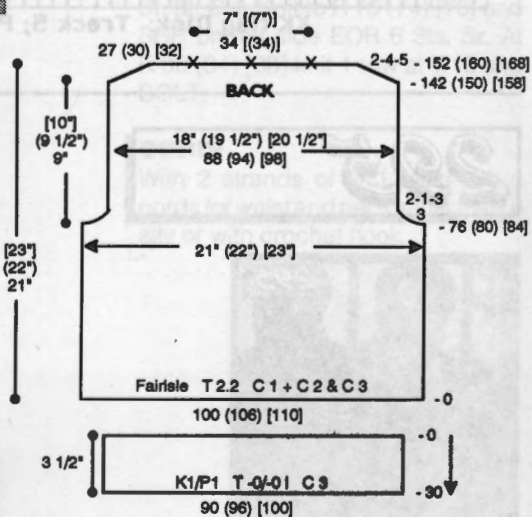

BACK:

With WY CO 100 (106) [110] sts. After several rows end with 1 row Ravel Cord to the left. RC 0. T 2.2. Fairisle. C 1 + C 2 and C 3. Knit to R 76 (80) [84] and shape armhole. On each side BO 3 sts., then decr. EOR 1 St. 3x. At R 142 (150) [158] SHR shoulders EOR 4 Sts. 5x. At R 152 (160) [168] mark center 34 [(34)] sts. for neckline and center of neckline. Remove neckline and shoulder sts. on separate WY.

BACK WAISTBAND:

With purl side facing rehang lower edge of back on 90 (96) [100] ndls. decr. evenly across. Knit 1 row and

transfer EOS to RB for K1/P1 rib. RC 0. T -0/-0 I. C 3. Knit to R 30 knitting last row at T 5/4. Transfer RB sts. to MB and BOLT.

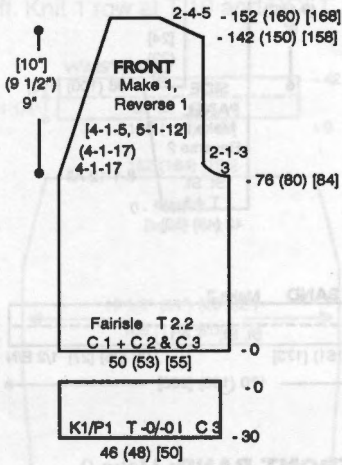

FRONT: Make 1, Reverse 1. With WY CO 50 (53) [55] sts. After several rows end with 1 row Ravel Cord to the left. RC 0. T 2.2. Fairisle. C 1 + C 2 and C 3. Knit to R 76 (80) [84] and shape armhole. On right side BO 3 sts., then decr. EOR 1 St. 3x. AT THE SAME TIME shape neckline. On left side decr. every 4 Rs. 1 St. 17x (every 4 Rs. 1 St. 17x) [every 4 Rs. 1 St. 5x and every 5 Rs. 1 St. 12x]. At R 142 (150) [158] SHR shoulder EOR 4 Sts. 5x. At R 152 (160) [168] remove shoulder sts. on WY.

FRONT WAISTBAND: With purl side facing rehang lower edge of front on 46 (48) [50] ndls. decr. evenly across. Knit 1 row and transfer EOS to RB for K1/P1 rib. RC 0. T -0/-0 I. C 3. Knit to R 30 knitting last row at T 5/4. Transfer RB sts. to MB and BOLT.

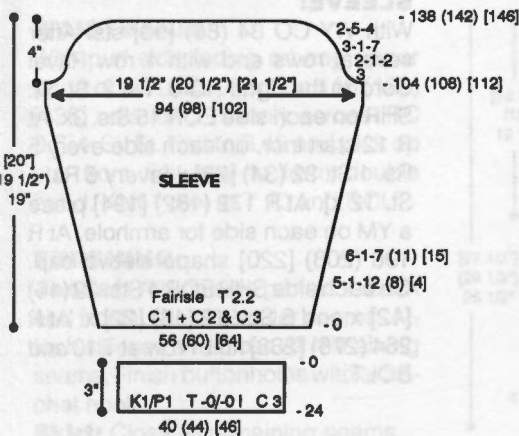

SLEEVE: With WY CO 56 (60) [64] sts. After several rows end with 1 row Ravel Cord to the left. RC 0. T 2.2. C 1 + C 2 and C 3. Knit in fairisle while incr. on each side every 5 Rs. 1 St. 12 (8) [4] x and every 6 Rs. 1 St. 7 (11) [15] x. AT R 104 (108) [112] shape sleeve cap. On each side BO 3 sts. then decr. EOR 1 St. 2x and every 3 Rs. 1 St. 7x, then SHR EOR 5 Sts. 4x. At R 138 (142) [146] knit 1 row at T 5 and BOLT.

CUFF: With purl side facing rehang lower of sleeve on 40 (44) [46] ndls. decr. evenly across. Knit 1 row and transfer EOS to RB for K1/P1 rib. RC 0. T -0/-0 I. C 3. Knit to R 24 knitting last row at T 5/4. Transfer RB sts. to MB and BOLT.

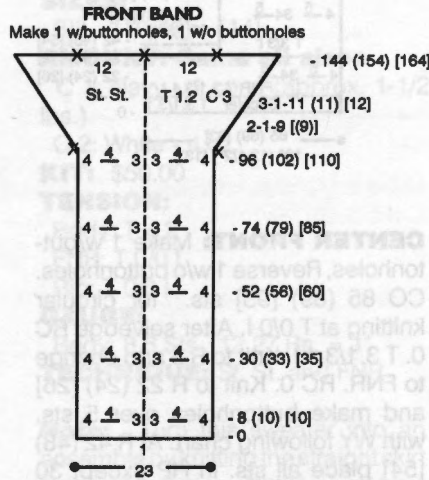

FRONT BAND: Make 1 w/buttonholes, 1 w/o buttonholes. With C 3 'e' wrap CO 23 sts. RC 0. T 1.2. C 3. Knit in St. St. making buttonholes over 4 sts. with WY at Rs. 8 (10) [10], Rs. 30 (33) [35], Rs. 52 (56) [60], Rs. 74 (79) [85] and Rs. 96 (102) [110] following chart. AT THE SAME TIME unravel center st. just before you make buttonholes and latch up every other bar with latch tool. Place a YM on each side and incr. EOR 1 St. 9 ([9]) x and every 3 Rs. 1 St. 11 (11) [12] x. At R 144 (154) [164] mark center 25 sts. with YM. Mark center st. and remove sts. on WY.

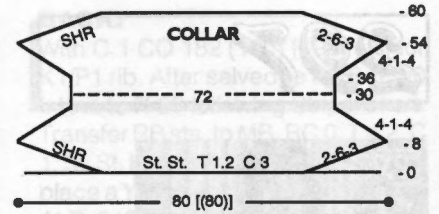

COLLAR: with C 3 'e' wrap CO 80 ([80]) sts. RC 0. T 1.2. St. St. Knit 1 row and start SHR on each side EOR 6 Sts. 3x. At R 8 decr. on each side every 4 Rs. 1 St. 4x. At R 36 incr. on each side every 4 Rs. 1 St. 4x. At R 54 SHR on each side EOR 6 Sts. 3x. At R 60 knit 1 row at T 8 and BOLT.

FINISHING: Close shoulder seams and attach collar following chart. Attach sleeves. Attach front bands and finish buttonholes with a crochet hook. Close all remaining seams.

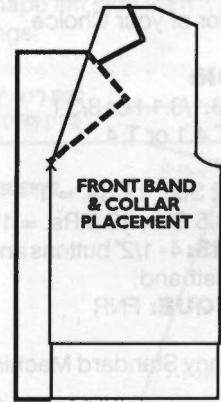

LACE MAKER CARTRIDGE

There's nothing more beautiful than the delicate appeal of Lace. And, with this new cartridge, you can use it (with your KC Pattern Design Computer) to create Lace and Fine Lace Patterns. The KC will automatically convert the "transfer symbols" you entered into a "data pattern" for easy communication into your Compuknit V or ST knitting machine.

Regularly priced at \$129.95, this exciting, new accessory is **SALE** priced at \$119.95.



LADY IN RED

YARN: Venetia - Red

SIZES:

6/8 (10/12) [14]

AMOUNT: Same all sizes

2 cones (approx. 3 lbs.)

KIT: Color of your Choice

\$80.00

TENSION:

FNR: T 3.1/3.1 I or 3/3 I

St. St.: T 4.1 or T 4

GAUGE:

FNR: 7.2 Sts., 12 Rs. = 1"

St. St.: 8.5 Sts., 12.5 Rs. = 1"

NOTIONS: 4- 1/2" buttons and elastic for waistband.

TECHNIQUE: FNR

Make on any Standard Machine with Ribber.

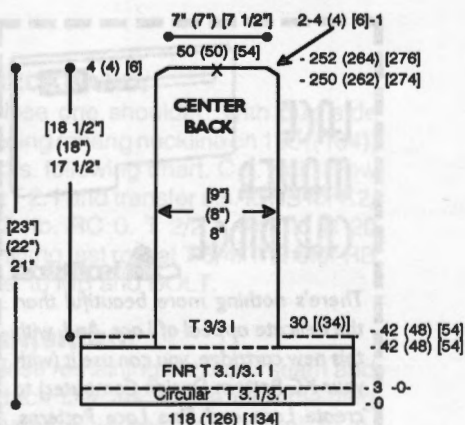

CENTER BACK:

CO 118 (126) [134] sts. for circular knitting at T 0/0 I. After selvedge RC 0. T 3.1/3.1 I. Knit to R 3 and change to FNR. RC 0. Knit to R 42 (48) [54]. Place all sts. in HP except 30 [(34)] on the right. Turn RC OFF. Push Cam Levers on KR Carriage to PR posi-

tion. Knit 4 Rs. Push Cam Levers to N position and knit 1 row. Transfer RB sts. to MB and remove sts. on WY. Push left 30 [(34)] ndls. to WP and knit same as right side. Push center 58 (58) [66] ndls. to WP and continue in FNR. At R 250 (262) [274] SHR shoulders EOR 4(4)[6] Sts. 1x. At R 252 (264) [276] transfer RB sts. to MB and mark center with a YM. Remove neckline and shoulder sts. on separate WY.

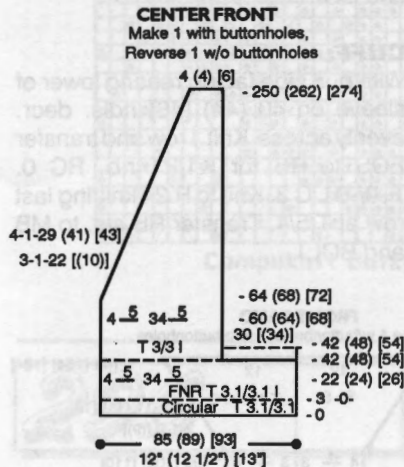

CENTER FRONT: Make 1 w/buttonholes, Reverse 1 w/o buttonholes. CO 85 (89) [93] sts. for circular knitting at T 0/0 I. After selvedge RC 0. T 3.1/3.1 I. Knit to R 3 and change to FNR. RC 0. Knit to R 22 (24) [26] and make buttonholes over 5 sts. with WY following chart. At R 42 (48) [54] place all sts. in HP except 30 [(34)] on the right. Turn RC OFF. Push Cam Levers on KR Carriage to PR position. Knit 4 Rs. Push Cam Levers to N position and knit 1 row. Transfer RB sts. to MB and remove sts. on WY. Bring remaining ndls. to WP and continue in FNR. At R 60 (64) [68] make buttonholes over 5 sts. with WY following chart. At R 64 (68) [72] shape front neckline. On left side FF decr. with a 3 prong tool every 3 Rs. 1 St. 22 [(10)] x and every 4 Rs. 1 St. 29 (41) [43] x. At R 250 (262) [274] transfer RB sts. to MB and remove sts. on WY.

SIDE PANELS: Make 2, Reverse 2. With WY CO 42 (46) [50] sts. After several rows end with 1 row Ravel Cord to the right. RC 0. T 4.1. Knit in St. St. while incr. on right side every 8 Rs. 1 St. 12 x for all sizes. At R 98 (100) [102] shape armhole. On right side BO 20 (22) [24] sts. Knit to R 210 (216) [222] and SHR shoulder EOR 6 [(7)] Sts. 5x. At R 220 (226) [232] remove shoulder sts. on WY.

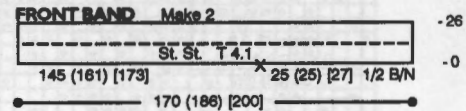
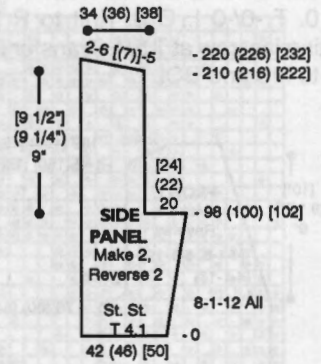

FRONT BAND: Make 2.

With purl side facing rehang 1/2 of back neckline and front edge on 170 (186) [200] ndls. following chart. RC 0. T 4.1. St. St. Knit to R 26 and pick up sts. from first row to form double band. Knit 1 row at T 10 and BOLT.

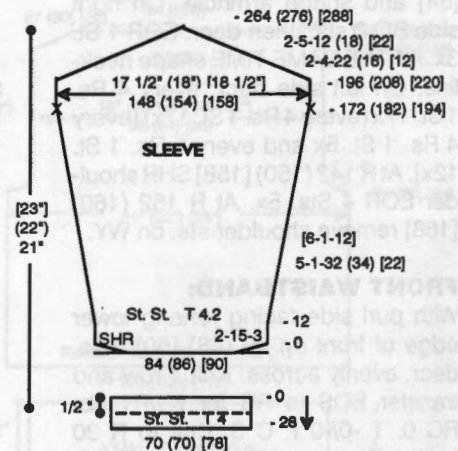

SLEEVE:

With WY CO 84 (86) [90] sts. After several rows end with 1 row Ravel Cord to the right. RC 0. T 4.2. St. St. SHR on each side EOR 15 Sts. 3x. At R 12 start incr. on each side every 5 Rs. 1 St. 32 (34) [22] x [every 6 Rs. 1 St. 12 x]. At R 172 (182) [194] place a YM on each side for armhole. At R 196 (208) [220] shape sleeve cap. On each side SHR EOR 4 Sts. 22 (16) [12] x and 5 Sts. 12 (18) [22] x. At R 264 (276) [288] knit 1 row at T 10 and BOLT.

298



JUST MY TYPE

YARN: Venetia

SIZES:

6/8 (10/12) [14]

AMOUNT: Same all sizes

C 1: Navy - 1 cone (approx. 1-1/2 lbs.)

C 2: White - 4 oz.

KIT: \$50.00

TENSION:

Body: T 4.2

FNR: T 0/0 I

Rib: T 0/0 I

GAUGE:

Body: 8.6 Sts., 12.27 Rs. = 1"

TECHNIQUE: St. St. and FNR

Note: Turn this sweater into an ensemble by knitting the straight skirt featured in Pattern #297 in matching color. Make on any Standard Machine with Ribber.

CUFF:

With purl side facing rehang lower edge of sleeve on 70 (70) [78] ndls. RC 0. T 4. St. St. Knit to R 28 and pick up sts. from first row to form double cuff. Knit 1 row at T 10 and BOLT.

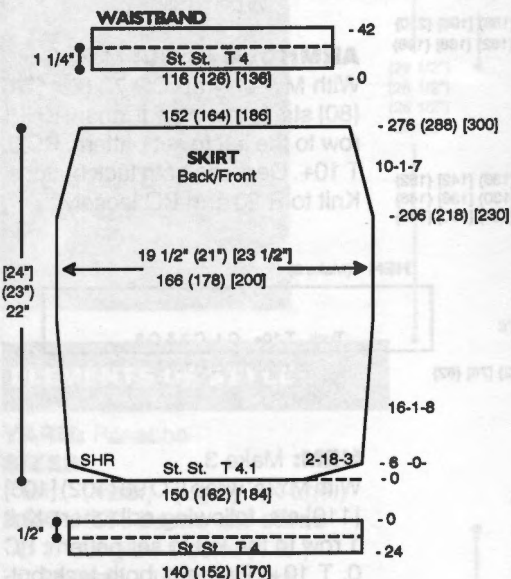

SKIRT BACK/FRONT:

With WY CO 150 (162) [184] sts. After several rows end with 1 row Ravel Cord to the right. RC 0. T 4.1. St. St. SHR shape on each side EOR 18 Sts. 3x. RC 0. Knit while incr. on each side every 16 Rs. 1 St. 8x. At R 206 (218) [230] decr. on each side every 10 Rs. 1 St. 7x. At R 276 (288) [300] remove sts. on WY.

HEM:

With purl side facing rehang lower edge of skirt back/front on 140 (152) [170] ndls. decr. evenly across. RC 0. T 4. St. St. Knit to R 24 and pick up sts. from first row to form double hem. Knit 1 row at T 10 and BOLT.

WAISTBAND:

With purl side facing rehang upper edge of skirt back/front on 116 (126) [136] ndls. decr. evenly across. RC 0. T 4. St. St. Knit to R 42 and pick up sts. from first row to form double band. Knit 1 row at T 10 and BOLT.

FINISHING:

Jacket: Attach side panels to back and fronts. Close shoulder seams. Attach sleeves and close all remaining seams. Finish buttonholes with a crochet hook.

Skirt: Close all remaining seams.

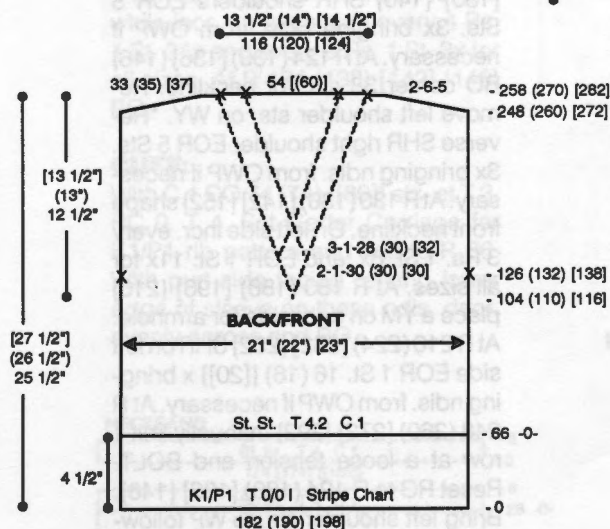

STRIPE CHART	
# Rows	Color
4	2
6	1

Repeat ↑

BACK:

With C 1 CO 182 (190) [198] sts. for K1/P1 rib. After selvedge RC 0. T 0/0 I. Knit to R 66 following Stripe Chart. Transfer RB sts. to MB. RC 0. T 4.2. C 1. St. St. Knit to R 126 (132) [138] and place a YM on each side for armhole. At R 248 (260) [272] SHR shoulders EOR 6 Sts. 5x. At R 258 (270) [282] mark center 116 (120) [124] sts. for neckband and center 54 [(60) sts. for neckline. Remove shoulder and neckline sts. on separate WY.

FRONT:

Knit front same as back to R 104 (110) [116] and shape neckline. Place all sts. to the left of -0- in HP. *On neckline edge decr. EOR 1 St. 30 [(30)] x and every 3 Rs. 1 St. 28 (30) [32] x. AT THE SAME TIME at R 126 (132) [138] place a YM on right side for armhole. At R 248 (260) [272] SHR shoulder EOR 6 Sts. 5x. At R 258 (270) [282] remove shoulder sts. on WY. Reset RC to R 104 (110) [116] and shape left side from *, reversing shapings.

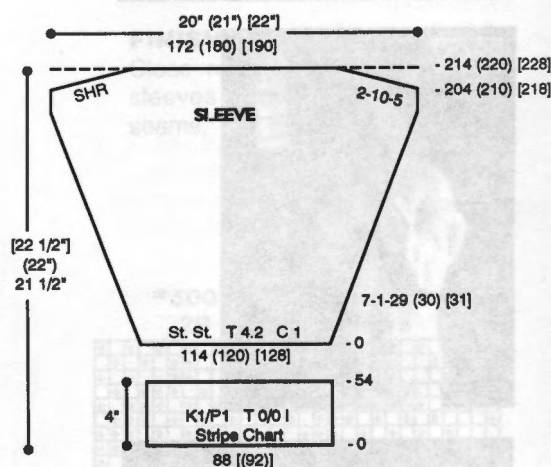

SLEEVE:

With WY CO 114 (120) [128] sts. After several rows end with 1 row Ravel Cord to the right. RC 0. T 4.2. C 1. Knit in St. St. while incr. on each side every 7 Rs. 1 St. 29 (30) [31] x. At R 204 (210) [218] SHR EOR 10 Sts. 5x. At R 214 (220) [228] knit 1 row at T 10 and BOLT.

CUFF:

With C 1 CO 88 [(92)] sts. for K1/P1 Rib. After selvedge RC 0. T 0/0 I. Knit to R 54 following Stripe Chart. Transfer RB sts. to MB. With purl side facing rehang lower edge of sleeve on these ndls. decr. evenly across. Knit 1 row at T 10 and BOLT.

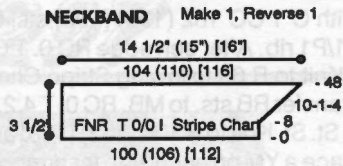

FRONT NECKBAND: Make 1, Reverse 1.

With C 1 CO 100 (106) [112] sts. for FNR. After selvedge RC 0. T 0/0 I. Stripe Chart. Knit to R 8 and start incr. on right side every 10 Rs. 1 St. 4x. At R 48 transfer RB sts. to MB and remove sts. on WY.

FINISHING:

Close shoulder seams and attach neckband to neckline overlapping from right to left at base of V. Attach sleeves and close all remaining seams. With 2 strands of C 1 single crochet 1 row across back neckline.

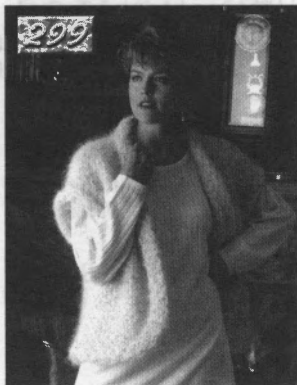

LIFE'S A BREEZE

YARN: Caprinae and Rayon Nubs
SIZES:

6/8 (10/12) [14/16] {X-Lge}

AMOUNT:

- C 1: Caprinae - Cream
1 lb (1 lb) [(1-1/2 lb)]
- C 2: Rayon Nubs - Rainbow
3 (3) [4] [6] oz.
- C 3: Rayon Nubs - Salt/Pepper
3 (3) [4] [6] oz.

TENSION:

Tuck: T 10+

GAUGE:

Tuck: 3.84 Sts., 5.2 Rs. = 1"

TECHNIQUE: Tuck

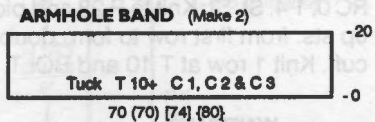
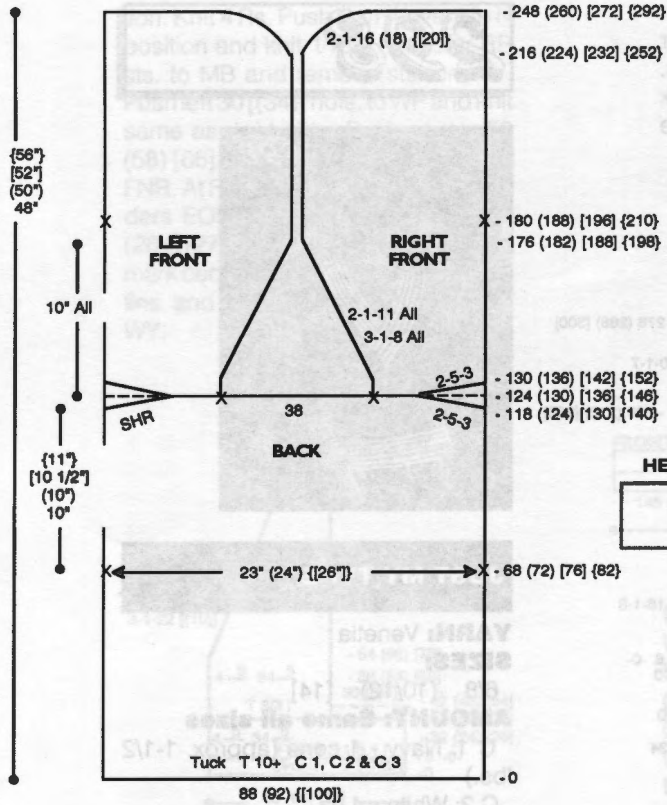

ARMHOLE BAND: Make 2
With MY 'e' wrap CO 70 (70) [74] [80] sts. following ndl. chart. Knit 1 row to the left to set pattern. RC 0. T 10+. Depress both tuck buttons. Knit to R 20 and BO loosely.

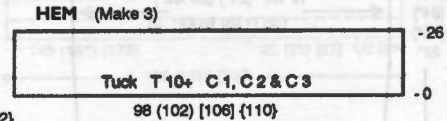

HEM: Make 3.
With MY 'e' wrap CO 98 (102) [106] [110] sts. following ndl. chart. Knit 1 row to the left to set pattern. RC 0. T 10+. Depress both tuck buttons. Knit to R 26 and BO loosely.

Make on Compuknit/Bulky or Punch Card Bulky Machine. Tuck Pattern is built-in #126 in Compuknit/Bulky.

Note: Count all ndls. including OWP. Use C 1, C 2 and C 3 together as MY throughout. Vest is worn on purl side.

BACK/FRONT:

With MY 'e' wrap CO 88 (92) [100] sts. following ndl. chart. Knit 1 row to the left to set pattern. RC 0. T 10+. Depress both tuck buttons. Knit to R 68 (72) [76] [82] and place a YM on each side for armhole. At R 118 (124) [130] [140] SHR shoulders EOR 5 Sts. 3x bringing ndls. from OWP if necessary. At R 124 (130) [136] [146] BO center 38 sts. for neckline. Remove left shoulder sts. on WY. *Reverse SHR right shoulder EOR 5 Sts. 3x bringing ndls. from OWP if necessary. At R 130 (136) [142] [152] shape front neckline. On left side incr. every 3 Rs. 1 St. 8x and EOR 1 St. 11x for all sizes. At R 180 (188) [196] [210] place a YM on right side for armhole. At R 216 (224) [232] [252] SHR on left side EOR 1 St. 16 (18) [20] x bringing ndls. from OWP if necessary. At R 248 (260) [272] [292] manually knit 1 row at a loose tension and BOLT. Reset RC to R 124 (130) [136] [146]. Bring left shoulder sts. to WP following ndl. chart and knit left front same as right front from *, reversing shapings.

FINISHING:
Attach armhole band to armhole. Turn to inside and whip stitch in place very loosely. Close side seam and attach hem down front, around bottom and up front. Turn to inside and whip stitch in place very loosely.

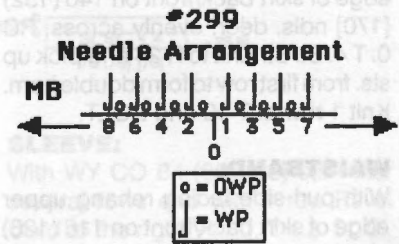

#299 Tuck Pattern
4 Sts. x 6 Rows

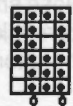

Compuknit/Bulky
Built-in Pattern #126

300

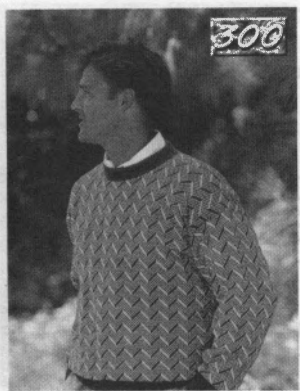

ELEMENTS OF STYLE

YARN: Panache
SIZES:
 Sm. (Med.) [Lge.] {X-Lge.}
AMOUNT: Same all sizes
 C 1: Jungle - 1 cone (1 lb.)
 C 2: Khaki - 1 cone (1 lb.)
KIT: Color of your Choice
 \$32.50
TENSION:
 Fairisle: T 9.1
 Rib: T 3
GAUGE:
 Fairisle: 7.6 Sts., 7.9 Rs. = 1"
TECHNIQUE: Fairisle

Make on Compuknit III, IV or V/Cx Machine with Garter Carriage.

Note: Ribbing is built-in pattern #532.

BACK/FRONT:
 With WY CO 168 (176) [182] {198} sts. After several rows end with 1 row Ravel Cord to the right. RC 0. T 9.1. C 1. Knit 1 row to set pattern. Knit in fairisle to R 92 (104) [114] {124} and place a YM on each side for armhole. At R 174 (186) [200] {210} mark center 62 (62) {[68]} sts. for neckline and remove neckline and shoulder sts. on separate WY.

WAISTBAND:
 With C 1 CO 148 (156) [162] {178} sts. at T 3. RC 0. T 4. Set Garter Carriage for K1/P1 rib pattern and knit to R 36. With purl side facing rehang lower edge of back/front on these ndls. decr. evenly across and BO.

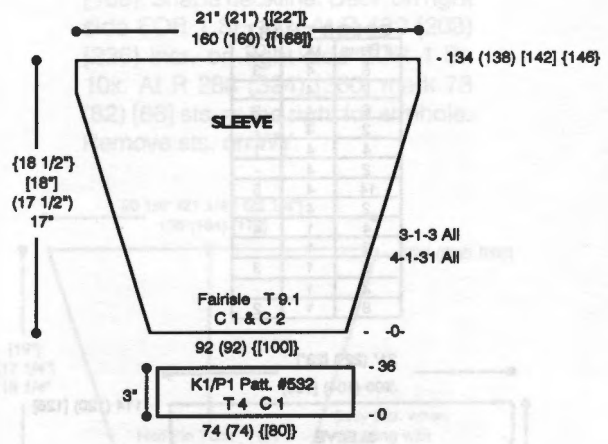
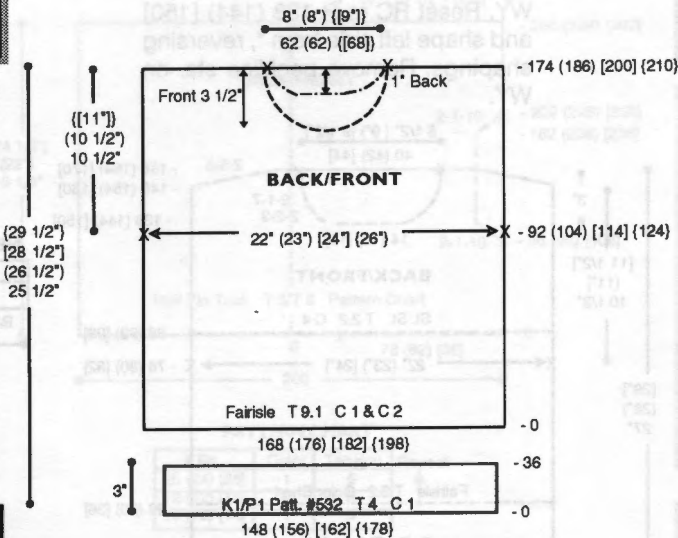

SLEEVE:
 With WY CO 92 (92) {[100]} sts. After several rows end with 1 row Ravel Cord to the right. RC 0. T 9.1. C 1. Knit 1 row to set pattern. Knit in fairisle while incr. on each side every 4 Rs. 1 St. 31x and every 3 Rs. 1 St. 3x for all sizes. At R 134 (138) [142] {146} BO.

CUFF:
 With C 1 CO 74 (74) {[80]} sts. at T 3. RC 0. T 4. Set Garter Carriage for K1/P1 rib pattern and knit to R 36. With purl side facing rehang lower edge of sleeve on these ndls. decr. evenly across and BO.

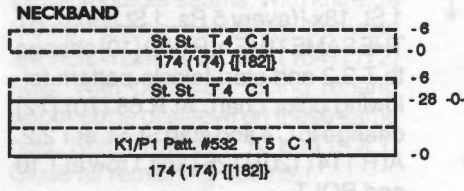

CUT & SEW NECKBAND:

Close one shoulder. Make a template of neckline. We made ours 8" (8") {[9"}] wide and 3 1/2" deep for the front and 1" deep for the back. Trace on front and back with tailor's chalk. Stitch along line with sewing machine or serger. With C 1 CO 174 (174) {[182]} sts. at T 3. RC 0. T 5. Set Garter Carriage for K1/P1 rib pattern and knit to R 28 and pick up sts. from first row to form double band. Change to K-Carriage. Knit 1 row at T 8 with C1 and Ravel Cord. RC 0. T 4. St. St. C 1. Knit to R 6 and remove sts. on WY. Turn neckband around and rehang Ravel Cord row. RC 0. T 4. St. St. C 1. Knit to R 6 and remove sts. on WY. (Ravel Cord will have to be cut out.) With knit side facing rehang neckline on 174 (174) {[182]} ndls. and pull ndls. to HP. With purl side facing rehang neckband on these ndls. Make sure latches are closed and manually knit sts. through. Put these ndls. in 'D' position and rehang remaining side of neckband. Pull all ndls. to 'E' position and crochet BO.

FINISHING:
 Close remaining shoulder. Attach sleeves and close all remaining seams.

*300 Fairisle Pattern 28 Sts. x 30 Rows

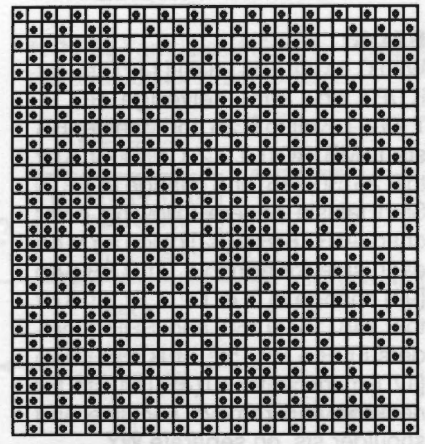

KK Mag Disk: Track 6; Pattern 901

301

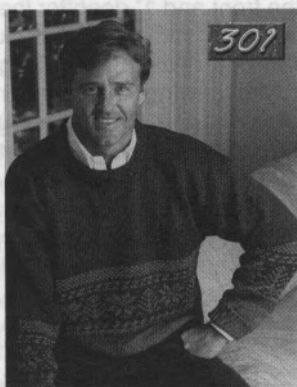

A FRESH PERSPECTIVE

YARN: Alpine

SIZES:

Small (Medium) [Large]

AMOUNT: Same all sizes

C 1: Charcoal - 1 lb.

C 2: Grape - 2 oz.

C 3: Burgundy - 2 oz.

C 4: Navy - 1 lb.

C 5: Bronze - 2 oz.

TENSION:

Fairisle: T 3.2

St. St.: T 2.2

Rib: T -0/-0 I or 0.2/0.2 I

GAUGE:

Fairisle: 4.67 Sts., 6.67 Rs. = 1"

TECHNIQUE: Fairisle

Make on Compuknit/Bulky or Punch Card Bulky Machine with Ribber.

BACK:

With C 1 CO 104 (108) [112] sts. for K1/P1 rib. After selvedge RC 0. T -0/-0 I. Knit to R 26 and transfer RB sts. to MB. RC 0. T 2.2. C 1. St. St. Knit to R 26 (30) [36] and change to T 3.2. Start fairisle pattern following color chart. At R 78 (80) [82] place a YM on each side for armhole. At R 88 (92) [98] change to C 4. T 2.2. St. St. Knit to R 148 (154) [160] and SHR shoulders EOR 5 Sts. 5x. At R 158 (164) [170] mark center 40 (42) [44] sts. for neckline and remove neckline and shoulder sts. on separate WY.

FRONT:

Knit front same as back to R 138 (144) [150] and shape neckline. Place center 14 (16) [18] sts. in HP and all sts. to the left. *On neckline edge SHR EOR 2 Sts. 3x and 1 St. 7x. AT THE SAME TIME at R 148 (154) [160] SHR shoulder EOR 5 Sts. 5x. At R 158

(164) [170] remove shoulder sts. on WY. Reset RC to R 138 (144) [150] and shape left side from *, reversing shapings. Remove neckline sts. on WY.

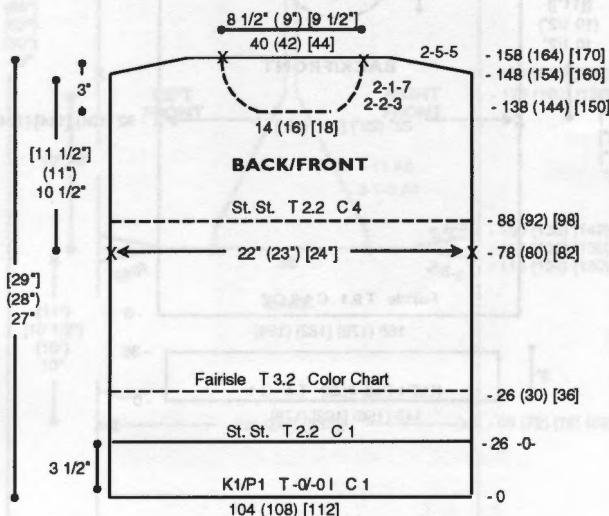

COLOR CHART

# Rows	MC	CC
8	4	3
2	4	-
6	4	2
2	4	-
4	4	1
2	4	-
14	4	5
2	4	-
4	1	4
2	1	-
6	1	3
2	1	-
8	1	2

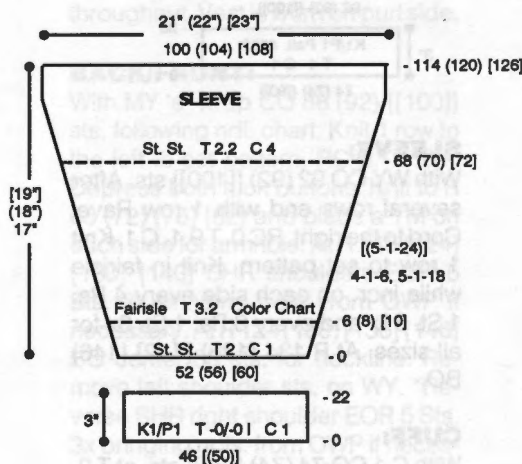

SLEEVE:

With WY CO 52 (56) [60] sts. After several rows end with 1 row Ravel Cord to the right. RC 0. T 2. C 1. Knit in St. St. while incr. on each side every 4 Rs. 1 St. 6x and every 5 Rs. 1 St. 18x [(every 5 Rs. 1 St. 24x)]. AT THE SAME TIME at R 6 (8) [10] change to T 3.2 and start fairisle pattern following color chart. At R 68 (70) [72] change to C 4 and start St. St. at T 2.2. At R 114 (120) [126] knit 1 row at T 10 and BOLT.

CUFF:

With C 1 CO 46 [(50)] sts. for K1/P1 rib. After selvedge RC 0. T -0/-0 I. Knit to R 22 and transfer RB sts. to MB. With purl side facing rehang lower edge of sleeve on these ndls. dec. evenly across. Knit 1 row at T 10 and BOLT.

NECKBAND

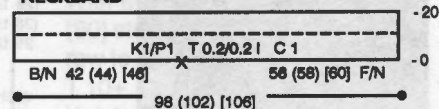

NECKBAND:

Close one shoulder. With purl side facing rehang neckline on 98 (102) [106] ndls. Knit 1 row at T 2 and transfer EOS to RB for K1/P1 Rib. RC 0. T 0.2/0.2 I. C 1. Knit to R 20 knitting last row at T 5/3. Transfer RB sts. to MB and BOLT.

FINISHING:

Close remaining shoulder. Attach sleeves and close all remaining seams. Turn neckband to inside and whip stitch in place.

*301 Fairisle Pattern 24 Sts. x 62 Rows

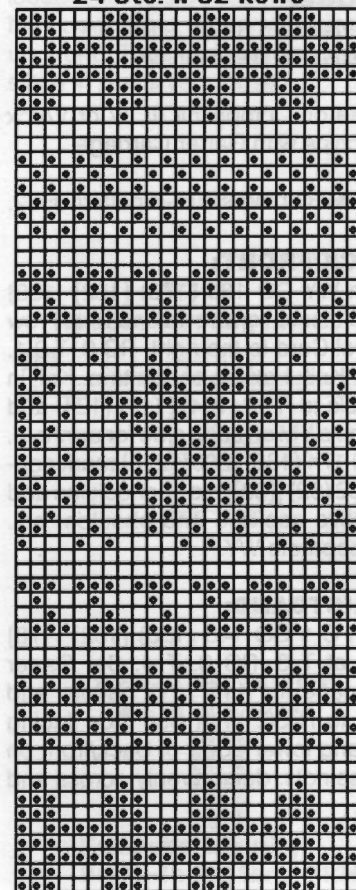

KK Mag Disk: Track 7; Pattern 901

302

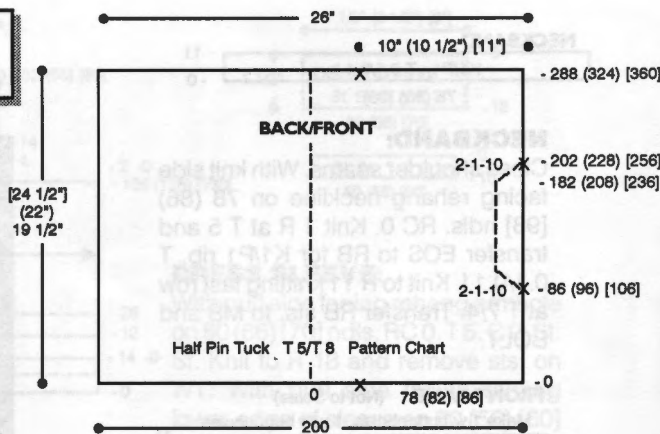
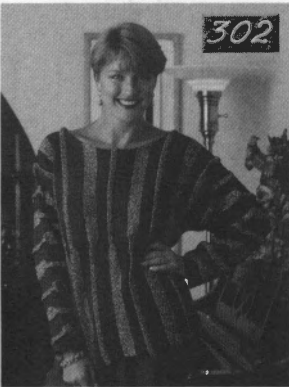

PATTERN CHART

# Rs.	Color	Tension	Repeat
20 (24) [28]	1	5	↑
12 (12) [12]	2	8	
10 (12) [14]	1	5	

FRONT:

Knit front same as back to R 86 (96) [106]. Shape neckline. Dec. on right side EOR 1 St. 10x. At R 182 (208) [236] incr. on right side EOR 1 St. 10x. At R 288 (324) [360] mark 78 (82) [86] sts. at the right for armhole. Remove sts. on WY.

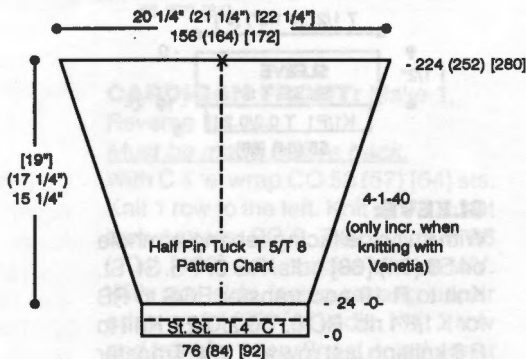

SLEEVE:

With WY CO 76 (84) [92] sts. After several rows end with 1 row Ravel Cord to the right. RC 0. T 4. St. St. C 1. Knit to R 24 and pick up sts. from first row to form double hem. RC 0. T 5. Knit in Half Pin Tuck following Pattern Chart while incr. on each side every 4 Rs. 1 St. 40x increasing only when knitting with Venetia. At R 224 (252) [280] mark center with YM and remove sts. on WY.

FINISHING:

Close shoulder seams. With knit side facing rehang back/front between armhole markers on 156 (164) [172] ndls. With purl side facing rehang upper edge of sleeve on these same ndls. Knit 1 row at T 10 and BOLT. Close all remaining seams.

303



LITTLE BIG MAN

YARN: Panache - Kelly

SIZES:

6 (12) [18] Mos.

AMOUNT:

1 Cone

KIT: Color of your Choice

\$16.25

TENSION:

St. St.: T 5

Tuck: T 6

Rib: T 0.1/0.1 or T 0.2/0.2 I

GAUGE:

St. St.: 7.8 Sts., 11.7 Rs. = 1"

Tuck: 6.7 Sts., 16 Rs. = 1"

NOTIONS: 5 - 1/2" buttons.

TECHNIQUE: Tuck

Make on Standard 24-Stitch Punch Card or Standard Electronic Machine with Ribber.

NOTE: Yarn is sufficient for Rompers and Jacket in same color.

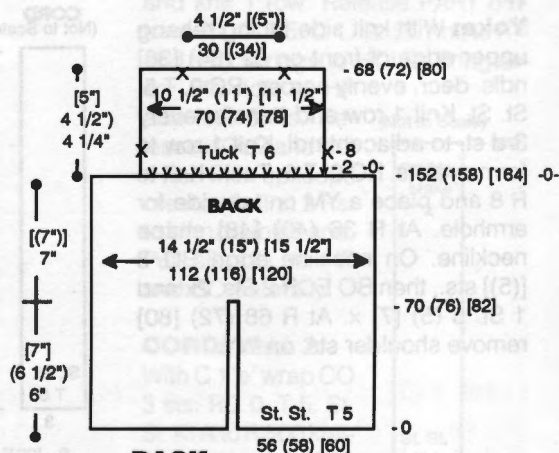

BACK:

Left Leg: With WY CO 56 (58) [60] sts. to the left of -0-. After several rows end with 1 row Ravel Cord to the right. RC 0. T 5. St. St. Knit to R 70 (76) [82] and remove sts. on WY.

MAKE WAVES

YARN: Venetia and Night Music

SIZES:

Small (Medium) [Large]

AMOUNT:

C 1: Venetia - Navy

1 lb. all sizes

C 2: Night Music - Black/Silver

8 (8) [9] balls

TENSION:

Venetia: T 5

Night Music: T 8

GAUGE:

7.7 Sts., 14.7 Rs. = 1"

TECHNIQUE: Half Pin Tuck

Make on any Standard Machine.

Half Pin Tuck Pattern:

1. Knit 10 (12) [14] Rs. with C 1.
2. Change to C 2 and knit 12 [(12)] Rs. Pick up sts. to the right of -0- from first row.
3. Knit 20 (24) [28] Rs. with C 1.
4. Change to C 2 and knit 12 [(12)] Rs. Pick up sts. to the left of -0- from first row.
5. Knit 20 (24) [28] Rs. with C 1.
6. Repeat steps 2 through 5 to the end.

BACK:

With WY CO 200 sts. After several rows end with 1 row Ravel Cord to the right. RC 0. T 5. Mark 78 (82) [86] sts. at the right for armhole. Knit in Half Pin Tuck following Pattern Chart. At R 86 (96) [106] place a YM on right side for neckline. Knit to R 202 (228) [256] and place a YM on right side for neckline. Knit to R 288 (324) [360] and mark 78 (82) [86] sts. at the right for armhole. Remove sts. on WY.

Right Leg: With WY CO 56 (58) [60] sts. to the right of -0-. Knit same as left leg to R 70 (76) [82]. Bring 56 (58) [60] ndls. to the left of -0- to WP. With purl side facing rehang left leg on these ndls. Knit to R 152 (158) [164] and remove sts. on WY.

Yoke:

With knit side facing rehang upper edge of back on 70 (74) [78] ndls. decr. evenly across. RC 0. T 5. St. St. Knit 1 row and transfer every 3rd st. to adjacent ndl. Knit 1 row to form eyelets. RC 0. T 6. Tuck. Knit to R 8 and place a YM on each side for armhole. At R 68 (72) [80] mark center 30 [(34)] sts. for neckline and remove neckline and shoulder sts. on separate WY.

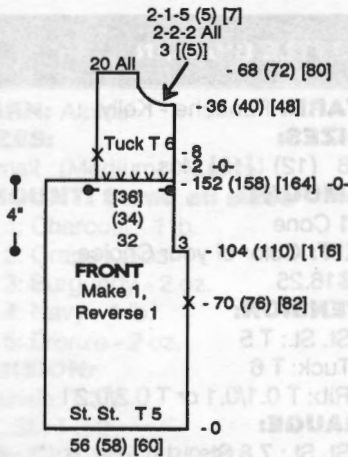

FRONT: Make 1, Reverse 1.

Leg: With WY CO 56 (58) [60] sts. to the left of -0-. After several rows end with 1 row Ravel Cord to the right. RC 0. T 5. St. St. Knit to R 70 (76) [82] and place a YM on right side for leg. At R 104 (110) [116] BO 3 sts. on the right side for front opening. Knit to R 152 (158) [164] and remove sts. on WY.

Yoke: With knit side facing rehang upper edge of front on 32 (34) [36] ndls. decr. evenly across. RC 0. T 5. St. St. Knit 1 row and transfer every 3rd st. to adjacent ndl. Knit 1 row to form eyelets. RC 0. T 6. Tuck. Knit to R 8 and place a YM on left side for armhole. At R 36 (40) [48] shape neckline. On neckline edge BO 3 [(5)] sts., then BO EOR 2 Sts. 2x and 1 St. 5 (5) [7] x. At R 68 (72) [80] remove shoulder sts. on WY.

NECKBAND

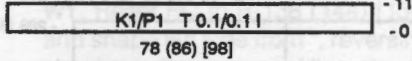

NECKBAND:

Close shoulder seams. With knit side facing rehang neckline on 78 (86) [98] ndls. RC 0. Knit 1 R at T 5 and transfer EOS to RB for K1/P1 rib. T 0.1/0.1 l. Knit to R 11 knitting last row at T 7/4. Transfer RB sts. to MB and BOLT.

FRONT BAND (Not to Scale)

Make 1 w/buttonholes, 1 w/o buttonholes

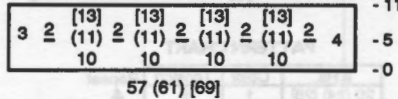

FRONT BAND: Make 1 with buttonholes, 1 without.

Rehang right front opening on 57 (61) [69] ndls. RC 0. Knit 1 R at T 5 and transfer EOS to RB for K1/P1 rib. T 0.2/0.2 l. Knit to R 5 and make buttonholes over 2 sts. following chart. Knit to R 11 knitting last row at T 7/4. Transfer RB sts. to MB and BOLT.

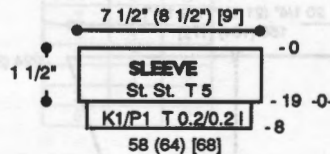

SLEEVE:

With knit side facing rehang armhole on 58 (64) [68] ndls. RC 0. T 5. St. St. Knit to R 19 and transfer EOS to RB for K1/P1 rib. RC 0. T 0.2/0.2 l. Knit to R 8 knitting last row at T 7/4. Transfer RB sts. to MB and BOLT.

CORD (Not to Scale)

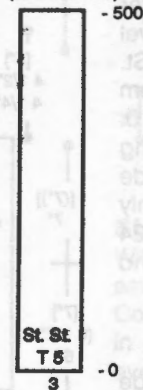

CORD:

'e' wrap CO 3 sts. RC 0. T 5. St. St. Knit to R 500 knitting last row at T 10 and BOLT.

FINISHING:

Close all remaining seams.

#303 Tuck Pattern 24 Sts. x 12 Rows

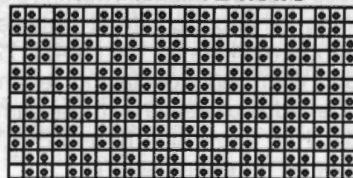

KK Mag Disk: Track 8; Pattern 901

304



SMALL WONDER

YARN: Panache

SIZES:

6 (12) [18] Mos.

AMOUNT:

C 1: Red - 1 Cone (1 lb)

C 2: White - 1 Cone (1 lb)

KIT: Color of your Choice

\$32.50

TENSION:

St. St.: T 5

Fairisle: T 6

Tuck: T 6

GAUGE:

St. St.: 7.8 Sts., 12.3 Rs. = 1"

Fairisle: 7.7 Sts., 8.7 Rs. = 1"

Tuck: 6.7 Sts., 16.0 Rs. = 1"

NOTIONS: 3 - 1/2" buttons.

TECHNIQUE: Fairisle and Tuck

Make on Compuknit III, IV or V/cx Machine.

DRESS BACK:

With WY CO 142 (156) [170] sts. After several rows end with 1 row Ravel Cord to the right. RC 0. T 4. C 2. St. St. Knit to R 14 and pick up sts. from first row to form double hem. RC 0. T 5. C 2. St. St. Knit to R 12 and add C 1 in 'B' Feeder. Change to T 6. Knit in fairisle to R 26 and cut C 1. Change to T 5 and knit in St. St. to R 106 (118) [130]. Remove sts. on WY. With purl side facing rehang upper edge of skirt on 82 (86) [90] ndls. decr. evenly across. RC 0. T 5. C 2. St. St. Knit 1 R and transfer every 3rd st. to adjacent ndl. Knit 1 row to form eyelets. RC 0. Knit to R 4 and place a YM on each side for armhole. At R 14 remove all sts. to the left of -0- on WY. Continue in St. St. to R 52 (56) [60]. Mark left 18 [(20)] sts. for neckline and remove neckline and shoulder sts. on separate WY. Rehang sts. to

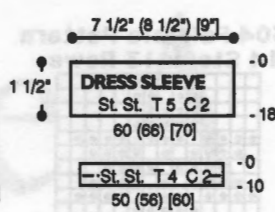
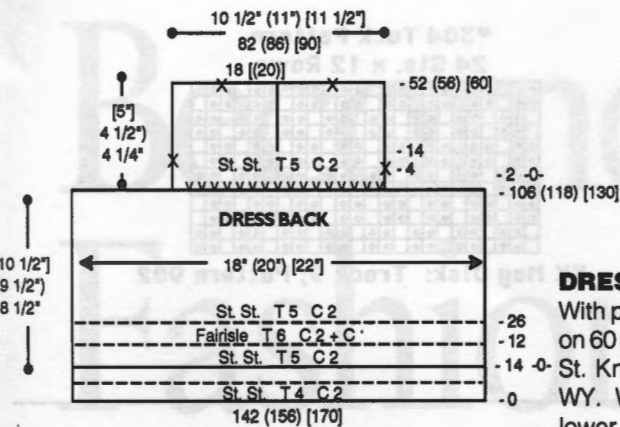

DRESS SLEEVE:

With purl side facing rehang armhole on 60 (66) [70] ndls. RC 0. T 5. C 2. St. St. Knit to R 18 and remove sts. on WY. With purl side facing rehang lower edge of sleeve on 50 (56) [60] ndls. decr. evenly across. RC 0. T 4. C 2. St. St. Knit to R 10 and pick up sts. from first row to form double band. Knit 1 row at T 10 and BOLT.

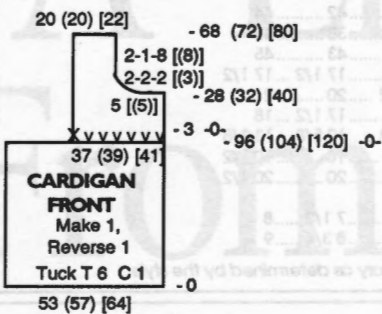
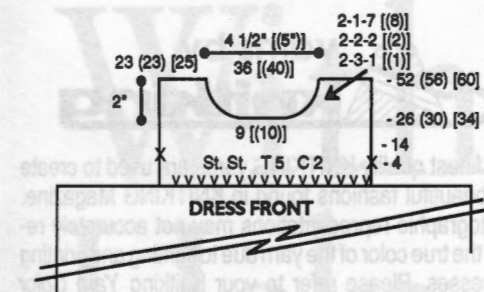

CARDIGAN FRONT: Make 1, Reverse 1.

Must be made before back.

With C 1 'e' wrap CO 53 (57) [64] sts. Knit 1 row to the left. Knit 1 row to set tuck pattern. RC 0. T 6. Knit to R 96 (104) [120] and remove sts. on WY. With purl side facing rehang upper edge on 37 (39) [41] ndls. Knit 1 row and transfer every 3rd st. to adjacent ndl. Knit 1 row to form eyelets. Knit 1 row to set tuck pattern. RC 0. T 6. Place a YM on left side for armhole. Knit to R 28 (32) [40] and shape neckline. On neckline edge BO 5 [(5)] sts., then decr. EOR 2 Sts. 2 [(3)] x and EOR 1 St. 8 [(8)] x. At R 68 (72) [80] remove shoulder sts. on WY.

CARDIGAN BACK:

With C 1 'e' wrap CO 106 (114) [128] sts. Knit 1 row to the left. Knit 1 row to set tuck pattern. RC 0. T 6. Knit to R 96 (104) [120] and remove sts. on WY. With purl side facing rehang upper edge on 74 (78) [82] ndls. Knit 1 row and transfer every 3rd st. to adjacent ndl. Knit 1 row to form eyelets. Knit 1 row to set tuck pattern. RC 0. T 6. Place a YM on each side for armhole. Knit to R 68 (72) [80]. With knit side facing rehang front pieces on shoulder sts. and BO.

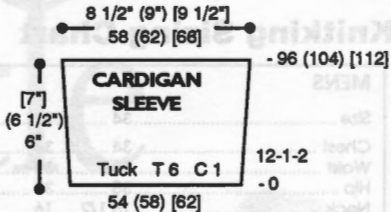

CARDIGAN SLEEVE:

With C 1 'e' wrap CO 54 (58) [62] sts. Knit 1 row to the left. Knit 1 row to set tuck pattern. RC 0. T 6. Knit while incr. on each side every 12 Rs. 1 St. 2x. At R 96 (104) [112] rehang armhole on these ndls. with knit side facing. Knit 1 row at T 10 and BOLT.

CARDIGAN NECKBAND (Not to Scale)

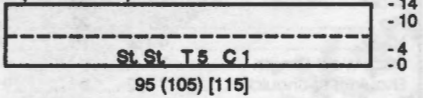

CARDIGAN NECKBAND:

With knit side facing rehang neckline on 95 (105) [115] ndls. Depress both PART buttons. Bring EON to HP and knit 1 row. Bring opposite EON to HP and knit 1 row. Release PART buttons. RC 0. T 5. C 1. St. St. Knit to R 4 and set carriage to HOLD. Bring every 5th ndl. to HP and knit 6 Rs. Release HOLD and knit 4 Rs. Pick up loops created in first 2 Rs. to form double band. Pull all ndls. to HP and BO carefully.

CORD: Make 2.

With C 1 'e' wrap CO 3 sts. RC 0. T 5. St. St. Knit to R 500 knitting last row at T 10 and BOLT. Make second cord with C 2.

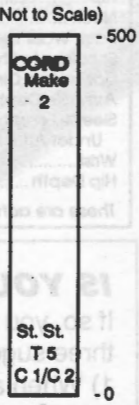

the left of -0- and reset RC to R 14. Knit the same as right side marking right side for neckline.

DRESS FRONT:

Knit front same as back to Yoke R 14. Continue in St. St. to R 26 (30) [34] and shape neckline. Place center 8 [(10)] sts. in HP and all sts. to the left. *On neckline edge SHR EOR 3 Sts. 1 [(1)] x, 2 Sts. 2 [(2)] x and 1 St. 7 [(8)] x. At R 52 (56) [60] remove shoulder sts. on WY. Reset RC to R 26 (30) [34] and shape left side from *, reversing shapings. Remove neckline sts. on WY.

DRESS NECKBAND

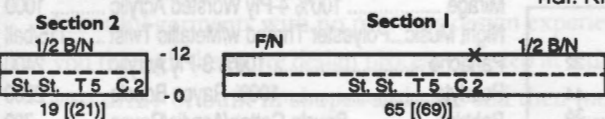

DRESS NECKBAND:

Section 1: Close one shoulder. With purl side facing rehang front and half of back neckline on 65 [(69)] ndls. Depress both PART buttons. Bring EON to HP and knit 1 row. Bring opposite EON to HP and knit 1 row. Release PART buttons. RC 0. T 5. C 2. St. St. Knit to R 12 and pick up loops from first two rows to form double band and BO.

Section 2: Close remaining shoulder. With purl side facing rehang half of back neckline on 19 [(21)] ndls. and knit same as Section 1.

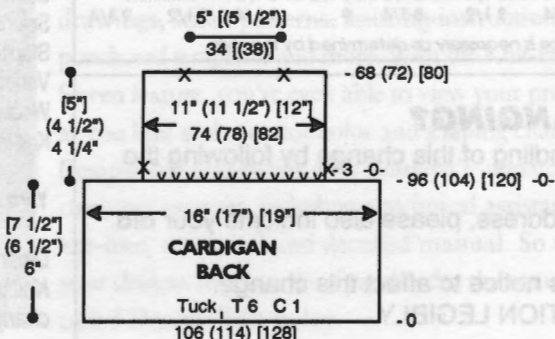

FINISHING:

Dress: Close all remaining seams. With purl side facing Single Crochet around back neck opening making a loop for buttonhole on right side.

Cardigan: Close all remaining seams. SC 2 Rs. along front edges, making 2 buttonhole loops between neckband and eyelets on one side.

#304 Fairisle Pattern
14 Sts. x 13 Rows

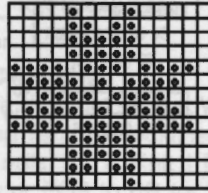

KK Mag Disk: Track 9;
Pattern 901

#304 Tuck Pattern
24 Sts. x 12 Rows

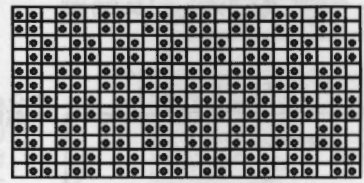

KK Mag Disk: Track 9; Pattern 902

Knitknit Sizing Chart

MENS										
Size	34	36	38	40	42	44				
Chest	34	36	38	40	42	44				
Waist	30	32	34	36	38	40				
Hip	36	37	39	41	43	45				
Neck	15 1/2	16	16 1/2	17	17 1/2	17 1/2				
Back Waist Length	18	18 1/2	19	19 1/2	20	21				
Shoulder to Shoulder	15 1/2	16	16 1/2	17	17 1/2	18				
Upper Arm Circumference	9 5/8	10 3/8	11 1/8	11 7/8	12 5/8	13 3/8				
Armhole Depth	8	8 1/2	9	9 1/2	10	10 1/2				
Sleeve Length	19	19 1/2	19 1/2	20	20	20 1/2				
Under Arm										
Wrist	6 1/2	7	7	7	7 1/2	8				
Hip Depth	8 3/8	8 1/2	8 5/8	8 3/4	8 3/4	9				

These are actual body sizes. Proper ease allowance is necessary as determined by the style.

CHILDREN										
Size	12 mo	2 yr	4	6	8	10	12	14		
Chest	19	21	23	25	27	28	30	32		
Waist	19	20	21	22	23	24	25	26 1/2		
Hip	20	22	24	26	28	30	32	34		
Neck	9 1/4	10	10 3/4	11 1/2	12 1/8	12 5/8	13 1/8	13 5/8		
Back Waist Length	7	8 1/2	9 1/2	10 1/2	12	12 3/4	13 1/2	14 1/4		
Shoulder to Shoulder	7 1/2	8 1/2	9 1/2	10	11	11 1/2	12	12 1/4		
Upper Arm Circumference	7	7 1/2	8	8 1/2	9	9 1/2	10	10 1/2		
Armhole Depth	3 1/2	4	4 1/2	5 1/4	6	6 1/2	6 3/4	7		
Sleeve Length	6	6 1/2	10	11 1/2	13	14 1/2	15 1/2	16 1/2		
Under Arm										
Wrist	5	5 1/4	5 1/2	5 1/2	5 3/4	5 3/4	6	6		
Hip Depth	5	5 1/4	5 1/2	5 1/2	5 3/4	6 1/4	6 3/4	7		

These are actual body sizes. Proper ease allowance is necessary as determined by the style.

WOMENS										
Size	6	8	10	12	14	16	18	20	22	
Bust	30 1/2	31 1/2	32 1/2	34	36	38	40	42	44	
Waist	22	23	24	25 1/2	27	29	31	34	36	
Hip	32 1/2	33 1/2	34 1/2	36	38	40	42	44	46	
Neck	13 1/8	13 3/8	13 5/8	14	14 3/8	14 3/4	15 1/4	15 3/4	16 1/4	
Back Waist Length	15 1/2	15 3/4	16	16 1/4	16 1/2	16 3/4	17	17 1/4	17 1/2	
Shoulder to Shoulder	13 1/2	13 1/2	14	14 1/2	15	15 1/2	16	16 1/2	17	
Upper Arm Circumference	9 3/4	9 3/4	10 1/4	10 1/2	11	11 1/2	12	13	13 1/2	
Armhole Depth	7	7	7 1/2	7 1/2	7 1/2	8	8	8 1/4	8 1/4	
Sleeve Length	16 1/2	16 1/2	17 1/2	17 1/2	17 1/2	18	18	18 1/2	18 1/2	
Under Arm										
Wrist	6	6	6 1/4	6 1/4	6 1/2	6 1/2	6 1/2	7	7	
Hip Depth	7 3/4	8	8 1/4	8 1/2	8 3/4	9	9 1/4	9 1/2	9 3/4	

These are actual body sizes. Proper ease allowance is necessary as determined by the style.

IS YOUR ADDRESS CHANGING?
If so, you can insure the proper handling of this change by following the three suggestions below:
1) When advising us of your new address, please also indicate your old address.
2) Please provide us with six weeks notice to affect this change.
3) PLEASE PRINT ALL INFORMATION LEGIBLY.



The finest quality KNITKNIT yarns are used to create the beautiful fashions found in KNITKNIT Magazine. Photographic representations may not accurately reflect the true color of the yarn due to lighting and printing processes. Please refer to your Knitknit Yarn Color Book for actual colors. Kit prices are located with the instructions for each garment. Each yarn comes in a wide selection of colors. The different types of yarns have been selected to allow for blending, mixing, and contrasting—both color and texture.

Yarn Color Book is available through KNITKNIT or an authorized Knitknit dealer. Content and approximate yardage of each yarn is shown below.

	Yds./Pound
Alpine	100% Wool 1600
Angora	100% Rabbit Hair (10 gr. ball) .. 33 yds./ball
Acrylite	2/12 Acrylic 2400
Caprinae	78% Mohair/13% Wool/9% Nylon 980
Glace Plus	100% Slinky Bright Rayon 1650
Lumiyarn	Thin Metallic Yarn (50 gr. cone) .. 1200/cone
Mini Pebble	100% Rayon Slub Filler Yarn 3350
Mirage	100% 4-Ply Worsted Acrylic 1000
Night Music	Polyester Thread w/Metallic Twist 115/ball
Panache	100% 3-Ply Acrylic 2400
Pearlyte	100% Rayon Boucle 2200
Pebble	Boucle Cotton/Acrylic/Rayon 700
Primo	100% Mercerized Cotton 2500
Rayon Nubs	100% Rayon Nub Filler Yarn 5500
Roma	80% Acrilan/20% Antron 2600
Rubane	(50 gr ball) 100% Polyamid 1/8" ribbon 82/ball
Softon	100% Soft Cotton 2000
Sorbet	54% Cotton/46% Rayon 2200
Splendor	3-Ply High Bulk Acrylic 2200
Starlite	Acrylic w/Metallic Thread 2400
Venetia	70% Wool/30% Rayon 2400
Woolana	100% 2/12 Merino Wool 3000
Knit-in Elastic	79% Nylon/21% Elastic ... 430/spool

Yarn Color Book: \$25.00 + Shipping and Handling

Order your Knitknit kits in the color of your choice from Knitknit color cards. Kit and yarn prices subject to change without notice.

Become A Great Fashion Designer With A Little Help From A Square.

DesignaKnit 5...the most popular computer-aided knitwear design program in the USA.

With DesignaKnit 5, machine knitters at every skill level can create beautiful garments with no previous design experience. DesignaKnit takes you through the entire design process one step at a time. You can work with a vast array of built in shapes and sizes and then modify them to fit your exact needs. With the Professional Version, you can even create original shapes. By designing on the screen, you can develop your own stitch patterns from the most popular stitches and experiment with thousands of color combinations. You can even

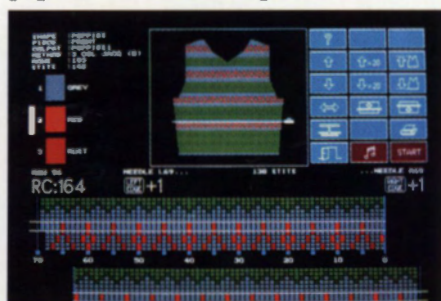

**PRICES START
AS LOW AS \$259.95**

import original or scanned graphics right into your design. When ready, you can print out scaled drawings, stitch patterns, knitting instructions, punchcard templates and more. With the Knit-From-Screen feature, you're even able to view your progress as you knit and monitor color and shaping changes. DesignaKnit also comes with Knitking's unmatched customer support, including a technical assistance hot-line, a tutorial and detailed manual. So take your designs to a new level, and order the square called DesignaKnit today.



LIMITED TIME OFFER: CALL 800-962-6446 TODAY AND GET A FREE DEMO DISK

DesignaKnit works with virtually all electronic and punchcard machines...Knitking, Singer, Brother, Studio, Passap (Cable links optional).

295



296



297



298



299



300



307



302



303

304



Dual Gauge Knitter

Two Knitting Machines for the Price of One

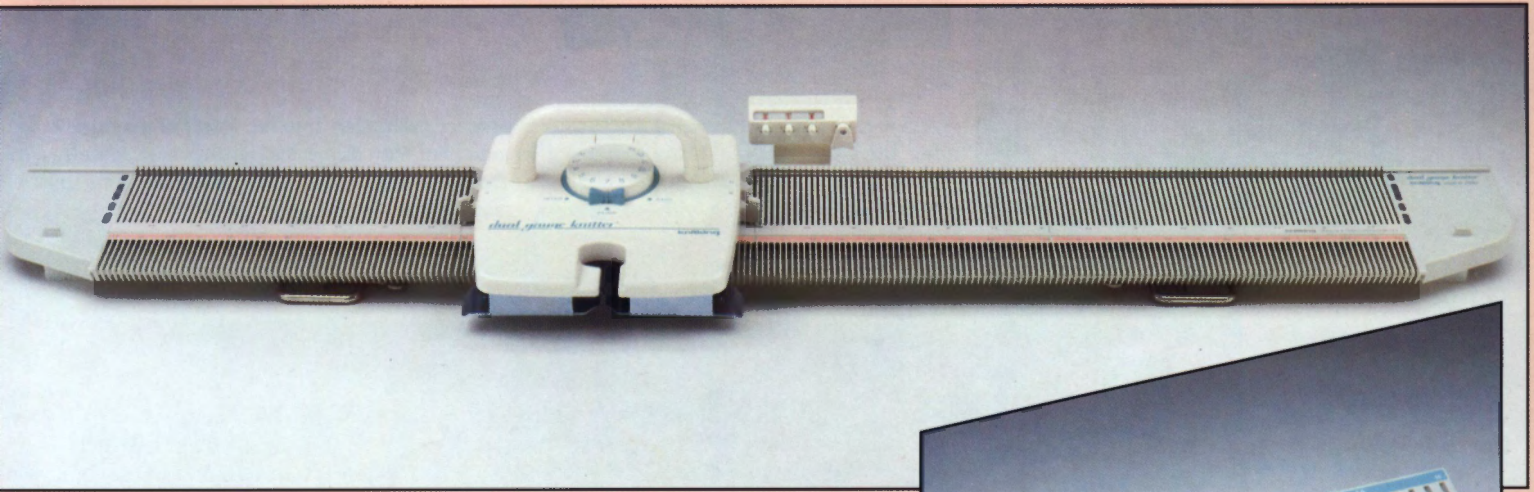

Think of it...one knitting machine that takes the place of two!

As its name implies, this unique knitter offers you the choice between using it as a **Standard Bed knitting machine (4.5 mm gauge with 220 needles)** or as a **Bulky knitting machine (9.0 mm gauge with 110 needles)**. These two industry-standard gauges are necessary to knit the full range of available yarns... Because of its gauge convertibility, **The Dual Gauge Knitter is the one machine that will handle them all!**

Pattern capabilities include Stockinette, Skip, Tuck, Holding, Lace, Cabling... **and built-in Intarsia and Plating!!** Fully portable at only 13 lbs., the **Dual Gauge Knitter** also comes complete with Row Counter, Table Clamps, Tools and **Instructional VHS Videotape and Manual.**

The experienced machine knitter will appreciate the wonderful possibilities of Intarsia knitting and Plating on **both** Standard and Bulky beds at a surprisingly **low cost**. The hand knitter or beginning knitter will appreciate the ability to **quickly knit the full range of yarns** on one **easy-to-use** machine—the economical **Dual Gauge Knitter!**

The unique features of the **Dual Gauge Knitter** make it **two** truly remarkable knitting machines... **in one!**

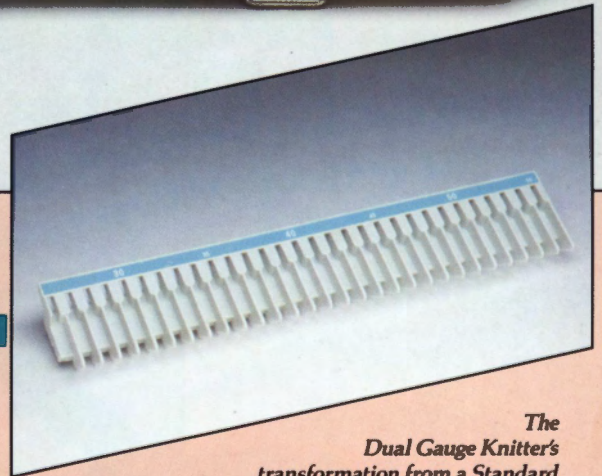

The Dual Gauge Knitter's transformation from a Standard Bed machine to a Bulky machine (or vice-versa), is easily accomplished by removing one set of lightweight, color-coded needle plates... and simply replacing them with the other set!

knitking

Where Savings And Value
Are Always In Fashion

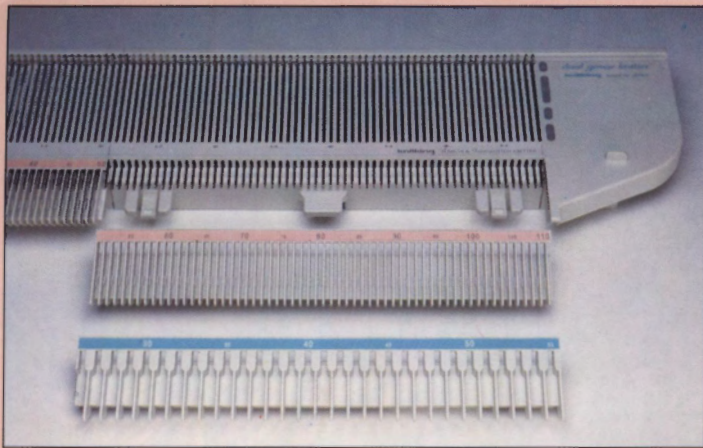

DUAL GAUGE

Just slide out one set of four, lightweight needle plates and replace them with the alternate set of color-coded plates to transform the **Dual Gauge Knitter** from a Standard bed machine (with 220 needles at a 4.5 mm gauge) to a Bulky one (with 110 needles at a 9.0 mm gauge)—the Bulky needle plates prevent every other needle from entering into the knitting position. It's that simple!



TENSION DIAL

Designed for the hand knitter who wants to proceed cautiously into the world of machine knitting, the **Dual Gauge Knitter** features a Tension Dial with numerical settings that actually correspond to hand knitting needle numbers—a tension setting of "10" will provide the same knitting tension as hand knitting with #10 needles, creating that supple hand-knit look!



RANGE OF YARNS

With the **Dual Gauge Knitter**, the full range of yarns becomes available for your knitting—from fine thread and sport-weight Wools and Cottons, to boucles, chunkies, Mohair, Angora, Alpaca, worsted weight, specialty heavy-weight yarns and everything in between!



INTARSIA DESIGNS

Built-in Intarsia capability extends your artistic freedom to create any Free-Form Design without concern for number of yarn colors. Even the hard-to-create Picture-In-Picture designs are a snap on the **Dual Gauge Knitter**.

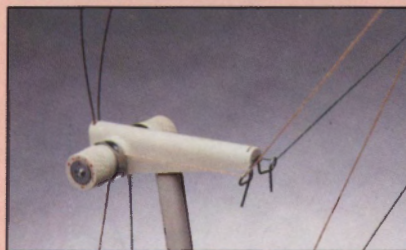

DUAL YARN TENSION

Twin Overhead Yarn Feeders are included—no need to stop and re-thread a different yarn when your knitting calls for a different color or texture!



VIDEO INSTRUCTION

Comes complete with a fully-illustrated Instruction Manual, and a VHS Videotape with visual instructions for machine knitting your first three garments.

knitking