



Golden 
Summer
Days 

*bring a special showing of
KNITKING knits. Each is
up to the minute in
Fashion Design and ready
for you to show off your
expertise.*

 6·9·3

Ever Fresh

cotton is used to knit a super pretty Pullover in an easy Tuck Stitch Pattern. Knit it on the Punch Card bulky and the results are terrific. The yarn is Primo (mercerized cotton) for easy wash and wear.



6·9·4

**Rainbow
Bright** 

colors for a bulky knit Cardigan that is knitted in stockinette stitch on any Bulky Machine with Ribber. The waistband and cuffs are ribbed with a special Cable Design. Keep it handy for those cooler days or nights. Knit it with our Acrylite yarn.





KNITKING MAGAZINE - VOLUME 22 NO. 3

0000 GENERAL INSTRUCTIONS	12
692 WOMENS THREAD LACE DRESS	13
693 WOMENS BULKY PULLOVER	15
694 WOMENS BULKY CARDIGAN	16
695 WOMENS 2 PC. LEISURE SUIT	17
696 LADIES BEACH COVER-UP	19
697 WOMENS SIMPLE 7 TUCK TOP	20
698 WOMENS TOP AND PLEATED SKIRT	21
699 WOMENS INTARSIA DRESS	23
700 WOMENS TOP AND SKIRT	25
701 STRAPLESS STARLITE DRESS	27
702 WOMENS TUCK STITCH TOP	28
703 WOMENS 2 PC. LACE DRESS	29
704 WOMENS TOP AND SKIRT	31
705 WOMENS 3 PC. ENSEMBLE	32
706 LADIES INTARSIA TOP	34
707 MENS KOTTON PULLOVER	35
708 MENS SHAWL COLLAR PULLOVER	37
709 GIRLS SKIRT AND TOP	38
710 CHILDS HEART PULLOVER AND PANTS	39
711 BABY QUILT AND PILLOW	41
0000 KNITKING NEWS	43

6-9-2 Summer Lace



falls in ruffled tiers on the skirt of a beautiful two-piece Dress. The lace Tunic is perfect with a soft round neckline and gently puffed sleeves. Knit it in a Thread Lace pattern with our Pearlite and sewing thread. You need a standard Punch Card or Electronic machine with Thread Lace capability.



What a wonderful time to be a machine knitter! The versatility and ease of use of today's knitting machines makes this an extraordinarily opportune time to be involved in this craft. The wide variety of KNITKING knitting machines enable you to create a multitude of textures and patterns almost effortlessly. Techniques such as tuck, skip, fair isle, weaving, intarsia, thread lace and combinations of these are capabilities of KNITKING knitters. The technology available on KNITKING knitters covers the spectrum. It ranges from the manual operation of the Simple Seven, to the patterning capabilities of the punch card machines, and on to the highly advanced and easy-to-use computerized technology found in the Compuknit III.

Combine the basic techniques your main bed offers with a compatible machine accessory item such as the Garter Carriage, Ribber, Intarsia Carriage (when needed), Four-Color Changer, etc., and you have increased the patterns and textures you can create manifold. Your creativity is virtually infinite.

Our current issue of Knitking Magazine demonstrates many of the outstanding looks and textures you can create with your main bed and accessory. Put a Ribber to work with your Main Bed machine and you can fashion a lovely texture such as the one found on our Women's Pullover on Page 28. Use the Ribber for double knitting (even in a solid color), and get a fabulous designer weight fabric perfect for jackets, skirts and even a garment accessory item such as the detachable collar found with our two-piece ensemble on Page 21.

The Garter Carriage added to the Compuknit III for our dramatic men's pullover on Page 37 enables you to use a heavier-than-usual yarn on the standard needle machine, thus achieving a unique look and feel. The Garter Carriage even knits while you're away—who else but a machine knitter can say they knitted a sweater while playing golf?



With a little imagination, your Calcuknit, and a pattern from KNITKING Magazine you can create your own fashion statement. Chart a new neckline, shorten or lengthen a garment, change a fitted shoulder to a raglan.

At KNITKING we work very hard to combine for you the best and latest in knitting machine products and fashion. So take advantage of this wonderful time in machine knitting history and let your imagination be your guide.

Suzanne Ste...





 6·9·5 
Coordinates

A year round favorite is beautifully fitted slacks with a unique Pullover. The back and front are in a different color and the sleeves divide the colors in the center with a very special cable twist. The bands are K1, P1 ribbing. Knit it on any Standard or Electronic machine with Ribber.



6·9·6

Sunny Charm

Lace and Cables form the Pattern for a pool side (or beach) cover-up. You might even like to wear it as a summer evening wrap. You can knit it on any Standard Punch Card or Electronic machine. Our cool Kotton is the yarn.

6·9·7

A Medley of Colors



blend together in Tuck and Eyelet Designs for an easy to knit Pullover that is knitted on the SIMPLE SEVEN machine. A great project for beginners to learn some new techniques. Bulky Venetia is the yarn.

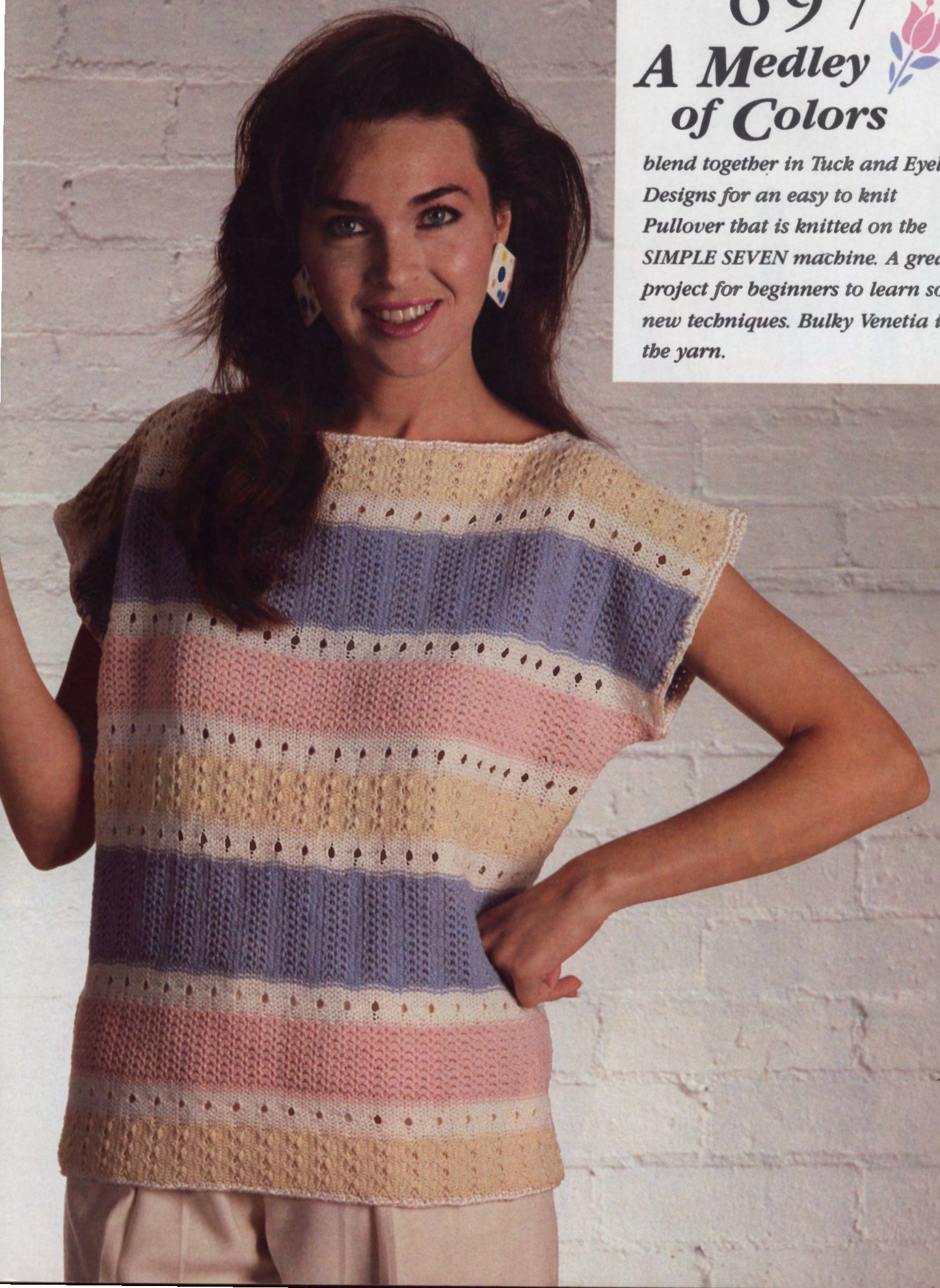



6·9·8
 **Timeless
Dressing**

Soft pleats on a slim stockinette stitch Skirt combine with a lovely Fair Isle Top. Perfect coordinates to wear any time, any place. The top has full sleeves gathered onto ribbed bands and the cool, cool Collar is detachable. Knit it on any standard or Electronic machine with our Venetia yarn.



6·9·9

Intarsia 

is still a fashion delight and this lovely Dress with its interesting Intarsia Design will catch every eye. Soft gathers at the waistline are covered with matching Belt. Knit it with Venetia on any Standard or Electronic machine.



7·0·0 
***Fashion
Excitement***

Here's two favorite colors combined in a soft and flattering two-piece outfit. The Blouse has a cowl neckline that drapes softly. The high fashion skirt has pleats and a distinctive knitted Belt. The Blouse is made with Pearlyte, the Skirt with Venetia.



7·0·1
***Ruffled Evening
Glamour***

For that special night out, you'll love wearing this exciting Dress. The Ruffles on lower edge of skirt section swing as you dance, the neckline bares pretty shoulders. Knit it with our sparkling Starlite on Standard Machine.



7·0·2

Summer Pretty



Combine a Tuck stitch with a Rib design and the result is an exceptionally pretty Pullover. It's knitted on the Punch Card Bulky with Ribbing Attachment. Knit the Garter Stitch bands on a standard machine with Garter Carriage. Our Primo yarn is the perfect choice.

General Instructions



THE PRINTED INSTRUCTIONS

Follow the printed instructions or use them in combination with the Charts. When there is any question in the instructions, you have the Charts to show you how the section will look.

Be sure to READ AHEAD so that you KNOW what to do for the size you are knitting. In the shapings, where the number of stitches are the same but the number of times different, you might find shapings like this...3 sts. 1 (2) [3]x - so that for the first size you will bind off 3 sts. 1x, 2nd size 3 sts. 2x, 3rd size 3 sts. 3x. Sometimes the ROWS will be different for each size-so you must watch out for different row numbers.

Shoulder and neck shapings for the back section of a garment usually are shaped at the same time-so ALWAYS WATCH for the words, AT THE SAME TIME.

HOLDING STITCHES ON THE LEFT SIDE WHILE SHAPING THE RIGHT SIDE

There are different ways to hold stitches on one side while completing the other side. Usually, we tell you to bind off the center sts. for neck and put the left side into holding position while completing the right side. The easiest way, and really the best for beginners, is to take a piece of RAVEL CORD and hand knit the center neck stitches, pulling them back against the needle bed of machine to the "A" or out of work position. The stitches remain in the HOOKS of the needles so you are really only knitting them HALF WAY. With another color of Ravel Cord, knit the remaining sts. on the left side in the SAME WAY.

It is important to protect these held stitches in some way-so you can either hang a REVERSING BAR so that the EYES of the bar go BETWEEN the Gate Pegs on the machine and that the UPPER TIPS of bar only show above the needle bed, OR the simplest way is to use a piece of 1" masking tape and GENTLY place it beneath the knitting-right below the Gate Pegs. DO NOT press the tape, only enough pressure to hold it in place. This will prevent the Carriage (or Slide) from marking the held section.

It is VERY IMPORTANT that you mark the PATTERN ROW where you divide for the split for NECK (or SHOULDER) shaping. If you are using a PUNCH CARD, mark the card-if you are using an ELECTRONIC machine, mark the design window. Also take note of the Row number for the division. When you are ready to work the left section, bring the HELD stitches back to "B" (working) position by pulling each end of the Ravel Cord GENTLY and ripping it off. Be sure to align all needles straight in the "B" or knitting position.

Now you are ready to REFER TO YOUR OWN INSTRUCTION MANUAL for your machine to set the controls to begin knitting the left half. The neck stitches can be bound off after completing the right side, or you can leave them in hold until each side is finished. Bind off or remove them onto contrast waste yarn ready to be picked up for knitting a neckband or for other finishing.

FULL FASHION DECREASING OR INCREASING

For stockinette stitch, use the Full Fashion method for decreasing or increasing (except for regular cap shaping on sleeves where you decrease the edge stitch). TO DECREASE: Hang the 3rd stitch onto the 2nd stitch, then move the end stitches in to fill the empty needle.

TO INCREASE: Move the 2nd end stitches 1 needle outward, then pick up the 3rd stitch from the row below and hang it onto empty needle.

PATTERN SYMBOLS

() Symbol for 2nd size.

[] Symbol for 3rd size.

There are up to 3 sizes given for Patterns in KNITTING MAGAZINE. For example, the Charts and printed instructions will show the cast on as - 124, first size, (132), second size, [140] third size.

☐ Needles in holding position.

☒ Needles back into working position

☑ Needle not used-in out of work position

3x1 The number in the box is the number of Rows between shapings. The

☒ 3x1 above the box gives the sts., and the number of times to make the decreases (or increases). For example: 3x1 over the box with 4 means- At the given Row number, *decrease 1 st., knit 4 rows* and REPEAT from * to * 2 times more for a total of 3 times in all. All decreasing (or increasing) WITHOUT ROW NUMBER IN BOX must be made on EVERY 2ND ROW.

THE SAMPLE SWATCH

Before you knit any garment, you must knit a sample swatch using the yarn you have chosen for your garment. If you do not get the correct Stitch and Row Gauge as given for a Pattern in KNITTING MAGAZINE, try different tensions. If you are using the specified yarn, you should be able to get the correct gauge using a smaller or larger tension. If you are using a different yarn, you may have to make several swatches, but the gauge is very important.

To make a sample swatch, Cast on 60 stitches with waste yarn and knit 6 rows. Mark the tension number for your sample swatch by making holes (you can do this with a Lace Carriage or by hand), 4 transfers for Tension 4, 6 transfers for Tension 6, etc. Knit 6 more rows.

Change to garment yarn and set Counter at 0. Knit 30 rows (in Stockinette stitch or Pattern stitch, according to the garment). With Contrast waste yarn, knit the 10th stitch FROM EACH SIDE by hand. Knit 30 rows. Change to waste yarn and knit 12 rows. Remove the sts. from the machine by pushing the Carriage (or Slide) across without yarn.

Pull and stretch the sample swatch both lengthwise and diagonally from corner to corner, then lengthwise again. Gently block the swatch (KNITTING PRESSING CLOTHS are great for this), or you can allow the sample to rest several hours or even over night so that the stitches can return to their basic form.

THE KNITTING STITCH/ROW GAUGE and STITCH/ROW CALCULATOR can be used to find the NUMBER OF STITCHES or ROWS TO 1". After knitting a sample swatch place the STITCH/ROW GAUGE horizontally with the

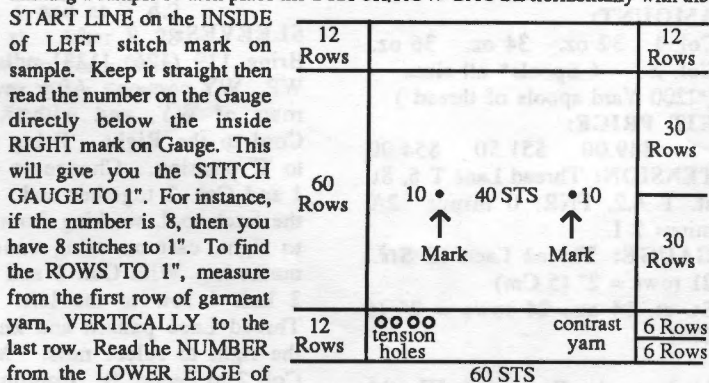

START LINE on the INSIDE of LEFT stitch mark on sample. Keep it straight then read the number on the Gauge directly below the inside RIGHT mark on Gauge. This will give you the STITCH GAUGE TO 1". For instance, if the number is 8, then you have 8 stitches to 1". To find the ROWS TO 1", measure from the first row of garment yarn, VERTICALLY to the last row. Read the NUMBER from the LOWER EDGE of

GAUGE, same as you did for stitches and if the number should be 14, you have 14 rows to 1".

THE STITCH/ROW CALCULATOR will now give you the number of sts. or rows needed for a specific measurement. Line the ARROW to the number 8 (8 sts. to 1"). Should you need 20 inches of stitches, find the number 20 below and right above the 20 the Calculator shows 160 sts. It works the same way for rows using the Row Gauge.

FINISHING

Gently block all sections-For PULLOVERS, JACKETS, and DRESSES: Join the front to back at shoulders and sides. Sew sleeves together and set in. Hem lower edge and sleeve edges if needed. For a double neckband or armhole band, sew 1 edge to inside and 1 to the outside of neck or armhole. For a single ribbed band, sew 1 edge to the outside of neck or armhole edge. For a cardigan or jacket with buttonholes, finish buttonholes and sew on buttons.

PANTS: Join front to back at sides. Sew inside leg seams, then join to center front and back. Make hem at waistline and inset elastic. Hem lower edge of pant legs.

ABBREVIATIONS

BO	Bind Off	L.C.	Lace Carriage
Carr.	Carriage	MB	Main Bed
CO	Cast on	Ndls.	Needles
Col.	Color	Pat.	Pattern
Dec.	Decrease	P	Purl
EON	Every Other Needle	RB	Ribber Bed
FNR	Full Needle Rib	R	Row
G.C.	Garter Carriage	St.	Stitch
G.S.	Garter Stitch	St. st.	Stockinette Stitch
HP	Holding Position	Strnd	Strand
Inc.	Increase	T	Tension
I.C.	Intarsia Carriage	W.Y.	Waste Yarn
K	Knit	WP	Working Position

6·9·2



WOMENS THREAD LACE DRESS

YARN: Col. 1 Pearlyte
Col. 2 Sewing Thread
SIZES: 4/6 (8/10) [12/14]
AMOUNT:
Col. 1 32 oz. 34 oz. 36 oz.
Col. 2 4 Spools* all sizes
(*1200 Yard spools of thread)
KIT PRICE:
\$49.00 \$51.50 \$54.00
TENSION: Thread Lace T 6, St. st. T 4.2, FNR: 0 minus 2/0 minus 2 I.
GAUGE: Thread Lace 13 Sts., 21 rows = 2" (5 Cm)
St. st. 14 sts. 24 rows = 2" (5 Cm)

Made on the Compuknit III with Ribber Use Pat. 401 from Compuknit III (930) Pattern Book. Punch card machine owners with Thread Lace capability may substitute any suitable thread lace card.

TOP BACK: Make 1.
W.Y. cast on 125 (132) [139] sts. After several rows, end with 1 row Ravel Cord to the right. Change to Col. 1 and Col. 2 together and knit 1 row to the left. Set Thread Lace pattern and knit to the right to select ndls. Remove C2 from Feeder A and place in Feeder B and continue in pattern. After R 166 (170) [174] shape armhole. On each side BO 3 sts. 2 x, 2 sts. 1 st. 2 (3) [4] x, 1 st. every 4 rows 3 x. After R 252 (262) [272] shape back neck opening. BO the center 45 (48) [51] sts. Mark place in pattern. Place remaining sts. on the left into HP and complete the right side first. *On neck edge dec. 1 st. EOR 4 x. After R 260 (270) [280] cancel pattern. BO or remove remaining sts. on W.Y.

Bring sts. on the left back into WP. Turn counter back to 252 (262) [272]. Return to correct place in pattern, select needles, and complete to match the right side. Follow Instructions from *.

TOP FRONT: Make 1.
Same as back to R246 (256) [266], Shape front neck opening. BO the center 39 (42) [45] sts, same as for top back. Mark place in pattern. Place remaining sts. on the left into HP and complete the right side first. *On the neck edge dec. 1 st. EOR 7 x. After R 260 (270) [280] cancel pattern. BO or remove on W.Y. Bring sts. on the left back into WP. Turn counter back to R 246 (256) [266]. Return to correct place in pattern select needles and complete to match the right side.

SLEEVES:
Bring 119 (126) [133] ndls. to WP. WY cast on. After several rows of WY, end with Ravel Cord to the Right. Bring ndls to 'E' position. Change to Col. 1 and Col. 2 together and with the latch tool, working from left to right, cast on using crochet method. With Col. 1 and Col. 2 knit 1 row to the left. Set Thread Lace pattern and knit to the right to select ndls. Move Col. 2 to Feeder B. Continue in thread lace pattern. After R 30 (34) [38] shape sleeve cap. On each side BO 3 sts. 2 x, 2 sts. 1 (2)[3] x, 1 st. EOR 5 x, 1 st. every 4 rows 10 (11) [12] x, 1 st. EOR 8 x, 2 sts. 2 x, 3 sts. 1 x. After R 108 (118) [128] BO the remaining sts.

BLOUSE HEM: Make 2.
W.Y. cast on 107 (114) [121] sts. After Ravel Cord row change to Col. 1 and knit 14 rows st. st. Pick up first row to form hem. With wrong side facing hang open sts. of Blouse onto these ndls. decreasing evenly across. BO .

NECK BAND: Make 1.
Close one shoulder first.
FNR: With Col. 1 cast on 114 (120) [126] sts. After selvedge knit 8 rows. Transfer ribber sts. to MB . With wrong side facing hang neck opening onto these ndls. and BO.

SKIRT: Make 8 sections first.
SKIRT RUFFLE: Make 8, 4 for lower skirt and 4 for middle skirt. Bring 127 (134) [141] ndls. to W.P. WY cast on. After several rows of WY, end with Ravel Cord. Bring needles to 'E' position. Change to Col. 1 and Col. 2. Using crochet method, cast on over these ndls. from left to right. Knit 1 row to the left. Set pattern, knit to the right to select ndls. Move Col. 2 to Feeder B and continue in thread lace pattern. After R 87 (91) [95] cancel pattern. Knit 1 plain row to the right and remove on W.Y.

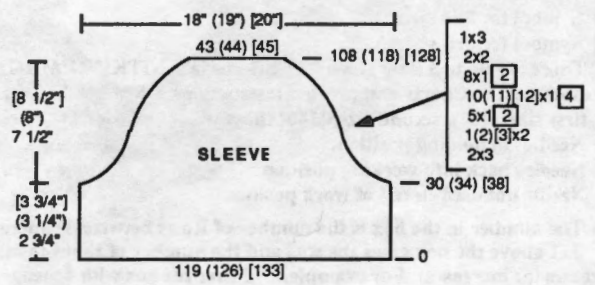
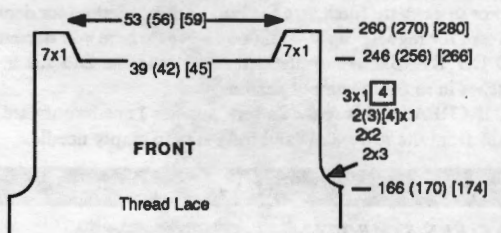
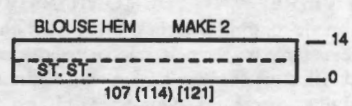
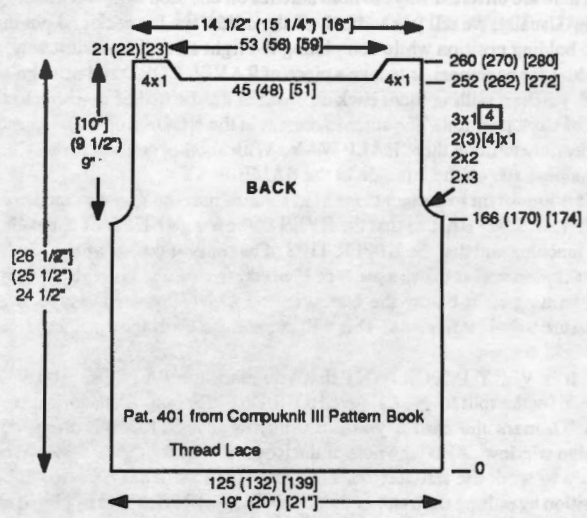

SKIRT WAISTBAND MAKE 2

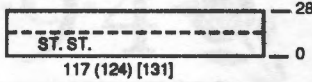

UPPER SKIRT SECTION MAKE 2

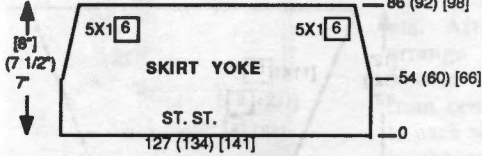

MIDDLE SKIRT LINING MAKE 2

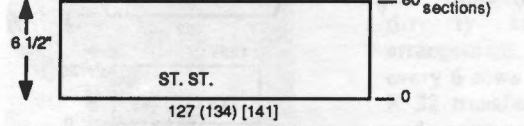

LOWER SKIRT LINING MAKE 2

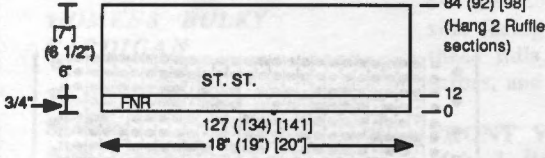

**SKIRT RUFFLE MAKE 8
(4 FOR BOTTOM RUFFLE, 4 FOR TOP RUFFLE)**

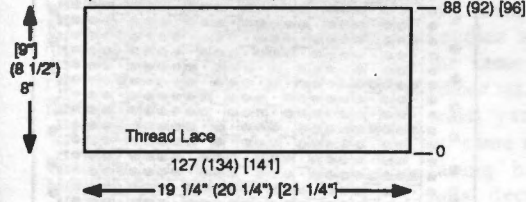

LOWER SKIRT: Make 2.
FRONT/BACK THE SAME
FNR: With Col. 1 cast on 127 (134) [141] sts. After selvedge knit 12 rows. Transfer ribber sts. to MB. and at T 4.2 continue in st. st. After R 84 (92) [98], with knit side facing, hang 2 ruffle sections onto these ndls., with seam in the center, hanging to each side doubling sts. across.

Counter at -0-. Knit in st. st. to R 80. Hang 2 more ruffle sections onto the ndls. same as before.

Counter at -0- (Skirt Yoke): Knit to R 54 (60) [66]. ON EACH SIDE dec. 1 st. every 6 rows 5 x. After R 86 (92) [98] remove on W.Y.

SKIRT WAIST BAND:

Make 2.
 W.Y. cast on 117 (124) [131] sts. After Ravel Cord row change to Col. 1 and at T 4.2 continue in st. st. After R 28 pick up first row to form hem. Hang open sts. of Skirt Section onto these ndls. BO.

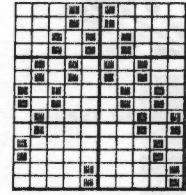

FINISHING:

See General Instructions. See center seams of ruffles. Gather top of sleeves to fit armholes.



LECTROLINK + YOU = LINKING MADE EASY

You can now assemble your knitted garments in record time. The **Lectrolink** is fast and incredibly easy -to-operate. It not only seams garment pieces, but performs additional functions such as *shirring, gathering and creative stitching* !

You will be delighted with the tremendous time and professional look that you will achieve with the **Lectrolink**.

Its 220-needle circular construction allows for continuous feeding of any length garment. Control of tension and linking speed allows you to execute a perfectly even crochet chain stitch seam in fine to medium weight yarns

Finishing, applique, ornamental chain stitch, piping, elastic shirring....*It's all at your fingertips with the amazing Lectrolink.*

It truly is professional finishing made easy !



6·9·3



WOMENS BULKY PULLOVER

YARN: Primo

SIZES: Petite (Sml) [Med]

AMOUNT:

21 oz. 23 oz. 25 oz.

KIT PRICE:

\$20.00 \$21.50 \$23.50

TENSION: St. st. T 6, Tuck st. T 6 Rib 1/1 II.

GAUGE: 8 sts. 11 rows = 2" (5 Cm)

Make on Bulky Punch Card machine with Ribber.

NOTE: 3 strands of Primo together throughout.

FRONT/BACK: The Same
Start on the left at Ndl. #35 (38) [41], W.Y. cast on to the right 71 (77) [83] sts. After several rows, end with 1 row Ravel Cord to the right. Change to garment yarn and knit 1 row to the left. Set Tuck Pattern and knit to the right to select ndls. Continue in Tuck pattern. After R 56 (56) [60] mark each side with W.Y. for armhole. After R 116 (116) [124], shape shoulders. On each side BO or use short row method 7 (7) [8] sts. 1 x, 6 (7) [8] sts. 1 x, 6 (7) [7] sts. 1 x. After R 120 (120) [128] knit 1 row at T 10, mark neck opening with W.Y. and BO using latch method.

SLEEVES:

St. St. - Purl side is the right side.

W.Y. cast on 62 sts. After Ravel Cord row, change to garment yarn, and continue in st. st. On each side inc. 1 st. every 4 rows, 11 x, (1 st. every 5 rows 11 x) [1 st. every 5 rows 11 x]. After R60 mark center with W.Y. and remove on W.Y.

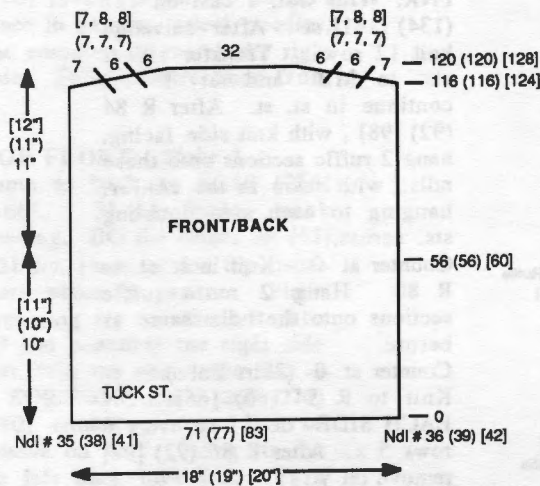

WAISTBAND MAKE 2

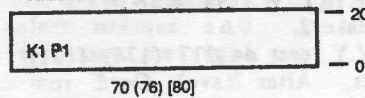

SLEEVE CUFFS:

K1/P1 rib: Cast on 36 (36) [40] sts. After selvedge, at T 1/1 II knit 14 rows. Transfer rib sts. to MB. With wrong side facing, hang open sts. of sleeve edge onto these ndls. decreasing evenly across, and BO.

WAISTBANDS: Make 2

K1/P1 rib: Cast on 70 (76) [80] sts. After selvedge, knit 20 rows. Transfer rib sts. to MB and with wrong size facing, hang open sts. of Front/Back onto these ndls. and BO.

FINISHING:

See General Instructions.

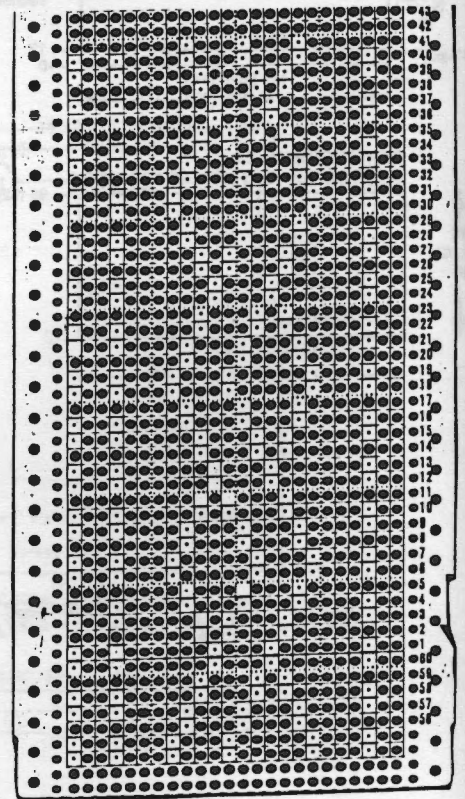
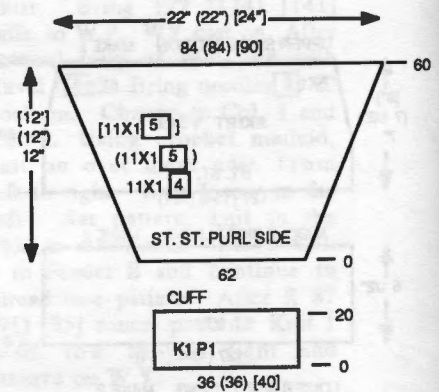

IS YOUR ADDRESS CHANGING ?

If so, you can insure the proper handling of this change by following the three suggestions below:

- 1) When advising us of your new address, please also indicate your old address.
- 2) Please provide us with six weeks notice to affect this change.
- 3) PLEASE PRINT ALL INFORMATION LEGIBLY.

6-9-4

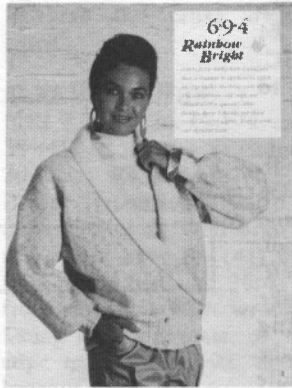

WOMENS BULKY CARDIGAN

YARN: Acrylite and Monofil
SIZES: 8/10 (14)
AMOUNT:
 Col. 1 23 oz. 25 oz.
 Col. 2 10 oz. 12 oz.
 Col. 3 Monofil 1 spool all sizes
KIT PRICE: \$33.00 \$37.00
TENSION: St. st. T 5, K1/P1 rib - T2/2 I, FNR see instructions.
GAUGE: 8 sts. 13 rows = 2" (5 CM)
NOTIONS: 4 buttons

Make on Bulky Machine with Ribber.

NOTE: Col. 1 is 3 strands together throughout. Col. 2 is 2 strands throughout.

BACK:
 W.Y. cast on 86 (92) sts. After several rows, end with 1 row Ravel Cord to the right. Change to Col. 1 and knit in st. st. to R 54 (56). Mark each side with W.Y. for sleeve. Continue in st. st. After R 126 (132) mark neck opening with W.Y. (See Chart) and BO or remove sts. on W.Y.

FRONT: Make 1, Reverse 1. W.Y. cast on same as Back 56 (60) sts. With Col. 1 knit 14 rows. Shape front. On edge side BO 3 sts. 1 x, 2 sts. 3 x, 1 st. 3 x, 1 st. every 4 rows 3 x., 1 st. every 6 rows 13 x., (1 st. every 6 rows 14 x.). After R 126 (132) BO or remove remaining sts. on W.Y.

SLEEVES:
CLOSE BOTH SHOULDERS.
 Bring 88 (94) ndls. to WP. With Wrong side facing, hang sleeve opening (between W.Y. markers) onto these ndls. With Col. 1 continue in st. st. On each side dec. 1 st. every 6 rows 17 x. After R 102 (106) remove remaining sts. on W.Y.

BACK WAIST BAND:
 Make 1.
NOTE: Col. 2 is 2 strands together throughout.
 K1/P1 rib: With Col. 2 and 1 strd. Monofil cast on 75 (81) sts. After regular selvedge arrange needles as per Cable Needle Chart. Be sure to start from center and work outwards to each side. This puts the cable in the center of back. Make first cable (2 sts. over 2 sts.) directly after the needle arrangement, knit 6 rows. Then every 6 rows make cables. After R 32 transfer ribber sts. to MB and remove on waist yarn, reverse and rehang. With wrong side facing, hang the back onto these ndls., decreasing evenly across, and BO.

FRONT WAIST BANDS:
 Make 1, Reverse 1.
 K1/P1 rib: With Col. 2 and 1 strd. Monofil, cast on 43 (47) sts. same as back. Transfer needles after selvedge and knit the same to Row 32. Transfer ribber sts. to MB and remove on waist yarn, reverse and rehang on same needles with wrong side facing hang front onto these ndls. decreasing evenly across. BO. (NOTE: THERE WILL BE 5 STRIPES OF CABLES FOR SIZE 14, AND 4 STRIPES OF CABLES FOR SIZE 8/10.)

SLEEVE CUFFS:
 K1/P1 rib: Cast on same as Waist bands, 29 (31) sts. After selvedge arrange needles and make cables as before knit to Row 26. Transfer st. from Ribber to Main Bed and remove on W.Y., reverse and rehang on same needles. With wrong side facing, hang sleeve onto these ndls. decreasing evenly across. BO.

COLLAR: Make 1, Reverse 1. (1 with Buttonholes.)
 FNR: With 2 strands of Col. 2 and 1 strand of Monofil, cast on 92 (96) sts. After selvedge change to T 2.2/2.2 I and knit 2 rows. Make Buttonhole (See Chart). Knit to row 10. Change to T 2.1/2.1 I and knit 6 rows. Change to T 2/2 I and continue. But AT THE SAME TIME begin short rows. On the left side (right for other) bring to HP 20 ndls. Knit 2 rows and then bring to HP 2 ndls. every other row 14 times. After R 46 transfer ribber sts. to MB and remove onto W.Y.

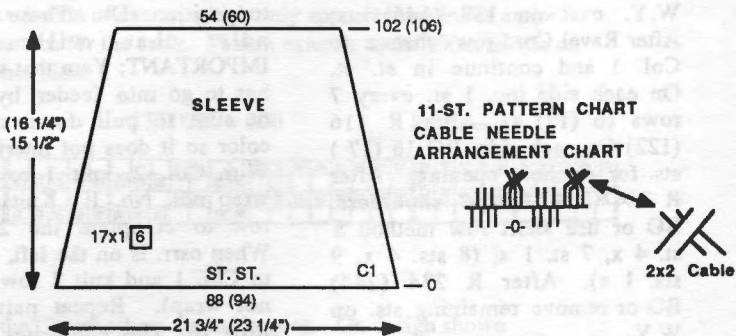
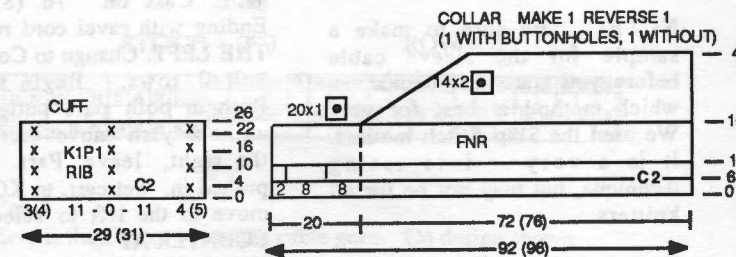
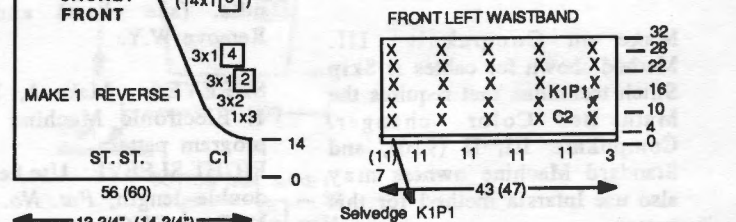
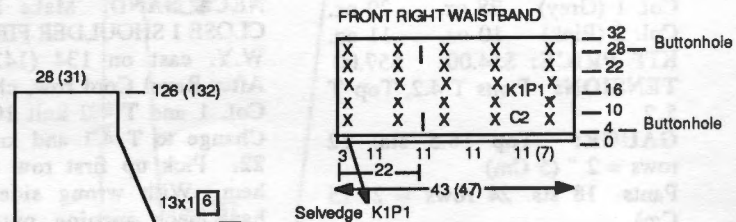
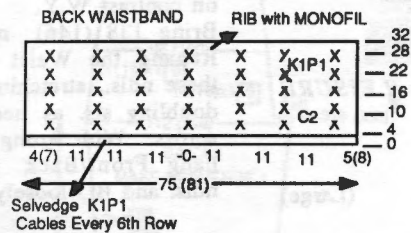
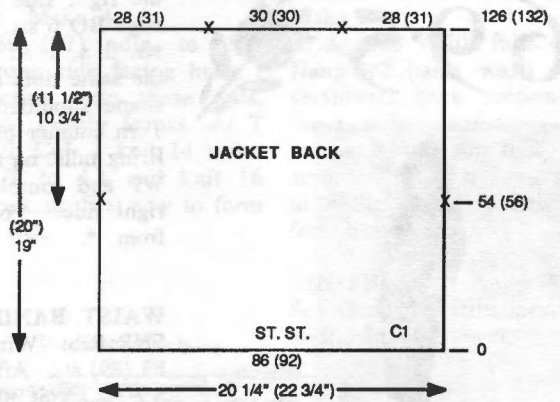

FINISHING:
 See General instructions.
 Weave collar starting at center of back neck opening. See photo.
 Attach buttons.

6-9-5

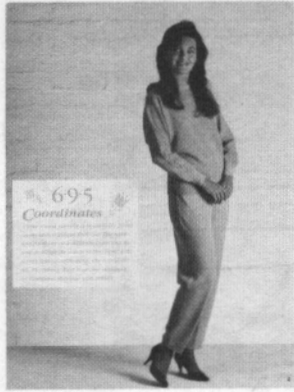

WOMENS 2 PC. LEISURE SUIT

YARN: Venetia
SIZES: Small/Med (Large)
AMOUNT:
 Col. 1 (Grey) 28 oz. 29 oz.
 Col. 2 (Pink) 10 oz. 11 oz.
KIT PRICE: \$54.00 \$57.00
TENSION: Pants T 4.2, Top T 5.2
GAUGE: Top 16.5 sts. 22 rows = 2" (5 Cm)
 Pants 18 sts. 24 rows = 2" (5 Cm)

Make on Compuknit III. Method shown for cables is Skip Stitch technique that requires the Main Bed Color changer. Compuknit III, II (910), and Standard Machine owners may also use Intarsia method for this pattern.

NOTE: Be sure to make a sample for the sleeve cable before you start, and decide on which method is best for you. We used the Skip Stitch method. It is a very interesting technique, but may not be for all knitters.

TOP BACK: Col. 1 Make 1. W.Y. cast on 138 (146) sts. After Ravel Cord row change to Col. 1 and continue in st. st. On each side inc. 1 st. every 7 rows 16 (17) x. After R 116 (122) On each side, BO 16 (17) sts. for armhole opening. After R 224 (234) shape shoulders. BO or use short row method 8 st. 4 x, 7 st. 1 x, (8 sts. 4 x, 9 sts. 1 x). After R 234 (244) BO or remove remaining sts. on W.Y.

TOP FRONT: Col. 2 Make 1. Same as Back (except use Col. 2) to R 202 (212). Shape neck opening. BO the center 20 (22) sts. Place the remaining sts. on the left into HP and complete

the right side first. *On neck edge BO 6 sts. 1 x, 4 sts. 1 x, 2 sts. 3 x, 1 st. 4 (5) x. But at the same time after R 224 (234) shape shoulders same as Back. Turn counter back to 202 (212). Bring ndls. on the left back into WP and complete to match the right side. Follow instructions from *.

WAIST BANDS: Make 2. FNR Rib: With Col. 1 cast on 83 (89) sts. After Selvedge, at T 3.2/3.2 I knit 30 rows. DO NOT transfer rib sts. to MB. Remove on contrast W.Y. Bring 138 (146) ndls. to WP. Rehang the Waist Band onto these ndls., stretching it out and doubling sts. as needed evenly across. With wrong side facing hang Front/Back onto these ndls. and BO loosely.

NECK BAND: Make 1. CLOSE 1 SHOULDER FIRST. W.Y. cast on 134 (142) sts. After Ravel Cord row, change to Col. 1 and T 4.2 knit 10 rows. Change to T 4.1 and knit to R 22. Pick up first row to form hem. With wrong side facing hang neck opening onto these ndls. (see chart) and BO. Remove W.Y.

SLEEVES: Make 1, Reverse 1. Electronic Machine owners program pattern. **RIGHT SLEEVE:** Use key #4 for double length, Pat. No. 1 - DO NOT use KHC button. W.Y. Cast on 76 (82) sts. Ending with ravel cord row TO THE LEFT. Change to Col. 1 and knit 2 rows. Begin Pattern. Push in both part buttons and without yarn move carriage to the right, leave Part buttons pushed in. Set carr. to KC II and move to the left to select ndls. COUNTER AT -0-

Needles on the left are selected to position -D-. These are the ndls. that will knit. **IMPORTANT:** Yarn that will knit has to go into feeder by itself, be sure to pull down on 2nd. color so it does not interfere. With Col. 2, knit 1 row and wrap ndl. No. 1. Knit 1 more row to complete the 2 rows. When carr. is on the left, change to Col. 1 and knit 2 rows. (Do not wrap). Repeat pattern to Row 16 This completes Pattern 1. (8 rows Col. 2 and 8 rows Col. 1).

MAKE CABLE - (2 X 2) St. #2 & #1 green, move to ndls. 1 & 2 yellow. Sts. 2 & 1 yellow, move to green 1 & 2.

With needle pusher, push all selected ndls. from -D- position to -B- position. Place carr. on the right Set to KC II and push in Both Part buttons. Program Pat. 2 (Row 16). Press Key #4 for double length and 6 for KHC. Move carr. from right to left to select ndls.

DO NOT COUNT THIS ROW. Wrap with Col. 1, yellow ndl. #3 before knitting 2 rows. On the left, change to Col. 2 and knit 1 row and wrap green ndl. No. 3 and knit to the left. Repeat to Row 32. Make Cables, same as before, being sure to cross them always in the same direction. With needle pusher, push all selected ndls. from -D- position to -B- position. This completes Pat. 2 (8 rows Col. 1 and 8 rows Col. 2.)

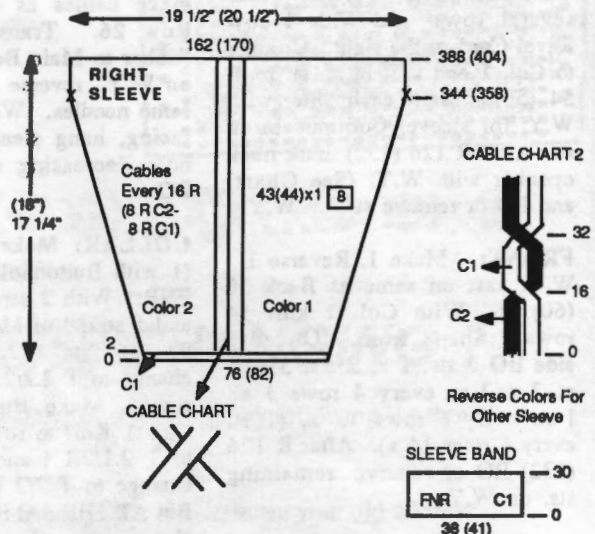
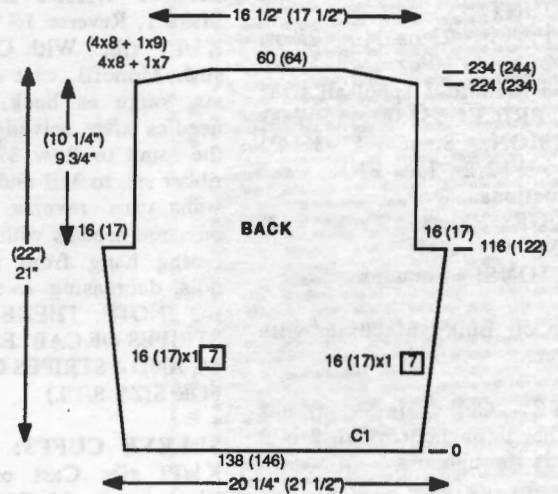
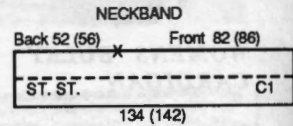
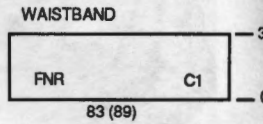

CONTINUE THESE SPECIAL INSTRUCTIONS AND AT THE SAME TIME

On each side inc. 1 st. every 8 rows 43 (44) x. After R 344 (358) on each side, mark with W.Y. After R 388 (404) BO or remove on contrast W.Y.

LEFT SLEEVE:

Knit the same as the Right Sleeve, with Col. 1 in left tension unit and Col. 2 in the right unit.
Reverse the cross over on cables.

SLEEVE BANDS:

FNR Rib: With Col. 1 cast on 38 (41) sts. After selvedge knit 30 rows. Remove on W.Y.
Bring 76 (82) ndls. to WP. Rehang Sleeve Band onto these ndls. (you have 38 (41) stitches from main bed and 38(41) sts. from ribber). With wrong side facing hang open sts. of sleeve edge onto these ndls. and BO loosely.

PANTS FRONT:

Make 1, Reverse 1.
Same as back to R 319 (331). On left side (right for other section) BO 7 (8) sts. 1 x, 6 sts. 1 x, 5 sts. 1 x, 1 st. every 3 rows 11 (12) x. After R 374 (398) on the right side (left for other section) dec. 1 st. every 10 rows 7 x. After R 444 (468) remove on contrast W Y

BOTTOM TRIM FOR PANTS:

Make 4.
Bring 50 (52) ndls. to WP. With wrong side facing hang 1 pant section onto these ndls. decreasing evenly across. At T 4.2 , with Col. 1 knit 14 rows. Change T to 4.1 and knit 16 rows. Pick up first row to form hem and BO.

WAIST BAND FOR PANTS:

Make 2.
Bring 112 (120) ndls. to WP. Hang 1/2 pants waist (2 front sections/2 back sections) onto these ndls. decreasing evenly across. Knit 1 row loose tension across. Change to T 4.2 and knit to R 30. Pick up first row to form hem and BO.

FINISHING:

See General Instructions. Insert elastic in Waistband.

PANTS BACK:

Make 1, Reverse 1.
W.Y. cast on 64 (66) sts. After Ravel Cord row change to Col. 1 and continue in st. st. On each side inc. 1 st. every 15 rows 17 x, 1 st. every 6 rows 7 (9) x. After R 318 (330), on right side (left for second side) BO 8 sts., then on each side dec. 1 st. every 9 rows 14 (15) x. After R 444 (468) begin short row. Carr. on the right. On side opposite carr. bring to HP 19 (20) ndls. 4 x. After R 450 (476), all ndls. in WP , knit 2 rows and remove on contrast W.Y.

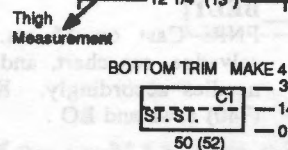
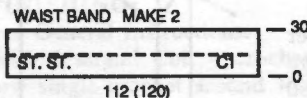
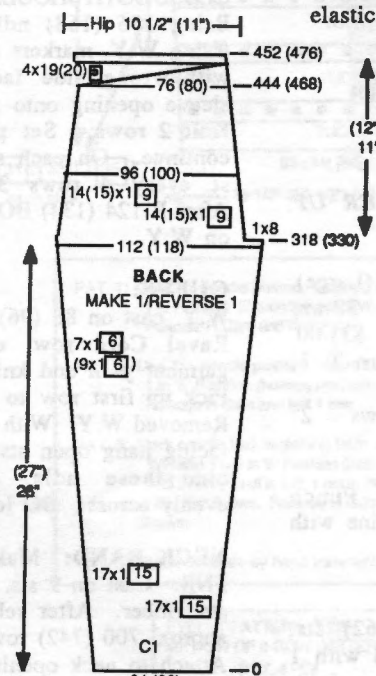
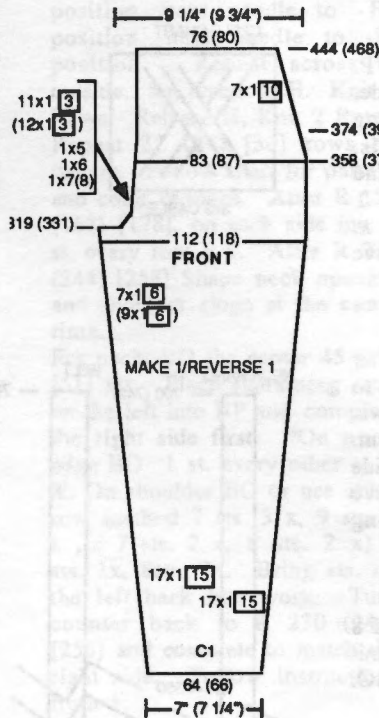

STITCH = 200 ROW = 4

1	2	3	4	5	6	7	8	9	10	11	12	13	14	15	16	17	18	19	20	21	22	23	24	25	26	27	28	29	30
1	2	3	4	5	6	7	8	9	10	11	12	13	14	15	16	17	18	19	20	21	22	23	24	25	26	27	28	29	30

- 0 -

Pat. 1

Zero is the Center where the cable goes. On design shown above extend identical needle pattern to left and right, with the exclusion of center, which only appears once in the entire pattern for the cable. Pattern extends to the 100th needle on each side.

STITCH = 200 ROW = 4

1	2	3	4	5	6	7	8	9	10	11	12	13	14	15	16	17	18	19	20	21	22	23	24	25	26	27	28	29	30
1	2	3	4	5	6	7	8	9	10	11	12	13	14	15	16	17	18	19	20	21	22	23	24	25	26	27	28	29	30

- 0 -

Pat. 2

Zero is the Center where the cable goes. On design shown above extend identical needle pattern to left and right, with the exclusion of center, which only appears once in the entire pattern for the cable. Pattern extends to the 100th needle on each side.

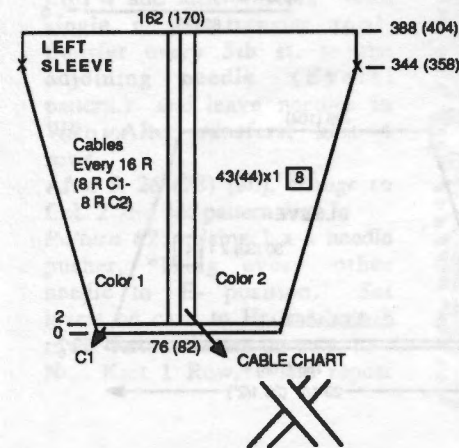
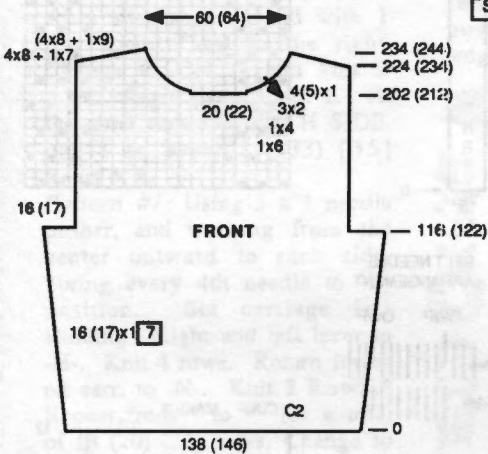

6-9-6

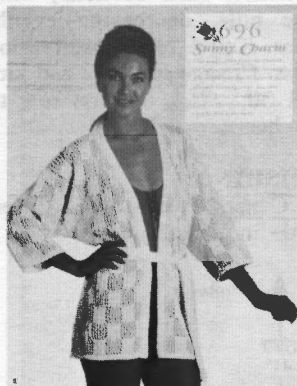

LADIES BEACH COVER UP

YARN: Kotton
SIZES: Small (Large)
AMOUNT: 34 oz. 38 oz.
KIT PRICE: \$28.00 \$31.00
TENSION: Lace pattern T 7,
 Bands T 6. Rib. 2/2 I
GAUGE: 13 sts. 20 rows = 2"
 (5 Cm)

Make on any Standard Punch card, or Electronic Machine with Ribber.

BACK:

W.Y. cast on 150 (162) sts. After several rows, end with 1 row Ravel Cord to the right. Change to Garment yarn and at T 7, knit 2 rows, begin lace and cable pattern and continue. See Chart and do 3 over 3 cables on Row 4, R 10 and R 16 and continue cables as established. After R 164 (180) mark each side with W.Y. for sleeve opening. After R 284 (304) mark with W.Y. for neck opening and BO or remove on W.Y.

FRONT: Make 1, Reverse 1. W.Y. cast on, same as back, 80 (86). Change to garment yarn. Knit 2 rows and begin Lace pattern. After R 164 (180), on edge side mark with W.Y. for sleeve. On neck edge dec. 1 st. every 4 rows 30 x, (1 st. every 4 rows 28 x, 1 st. every 3 rows 4 x). After R 284 (304) BO or remove on W.Y.

WAIST BAND FOR BACK:

Make 1. W.Y. cast on 136 (148) sts. After Ravel Cord row, change to garment yarn and knit 12 rows. Pick up first row to form hem, remove W.Y. and with wrong side facing, hang open sts. of back onto these ndls. decreasing evenly across. BO.

WAIST BAND FRONT:

Make 2. W.Y. cast on 72 (78) sts. same as back waist band and knit 12 rows. Pick up first row to form hem. Remove W.Y. With wrong side facing hang open sts. of front onto these ndls. decreasing evenly across and BO.

SLEEVES:

CLOSE BOTH SHOULDERS:

Bring 156 (168) ndls. to WP. Using W.Y. markers as a guide, with wrong side facing, hang sleeve opening onto these ndls. Knit 2 rows. Set pattern and continue. On each side dec. 1 st. every 4 rows 30 (32) x. After R 124 (134) BO or remove on W.Y.

CUFFS:

W.Y. cast on 88 (96) sts. After Ravel Cord row, change to garment yarn and knit 12 rows. Pick up first row to form hem. Removed W.Y. With wrong side facing hang open sts. of sleeve onto these ndls. decreasing evenly across. BO loosely.

NECK BAND:

Make 1. FNR: Cast on 9 sts. MB, and 8 sts. ribber. After selvedge, knit approx. 700 (742) rows and BO. Attach to neck opening.

BELT:

FNR: Cast on 15 sts. After selvedge, see chart, and arrange needles accordingly. Knit 700 (740) rows and BO.

FINISHING:

See General Instructions.

CABLE AND LACE CHART

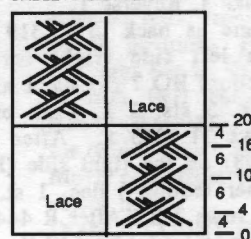

CABLE CHART



3x3 CABLE

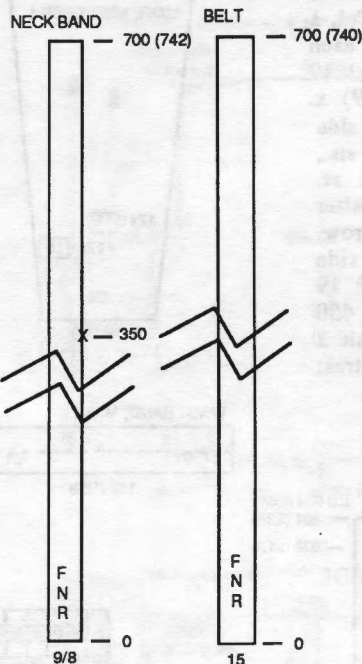
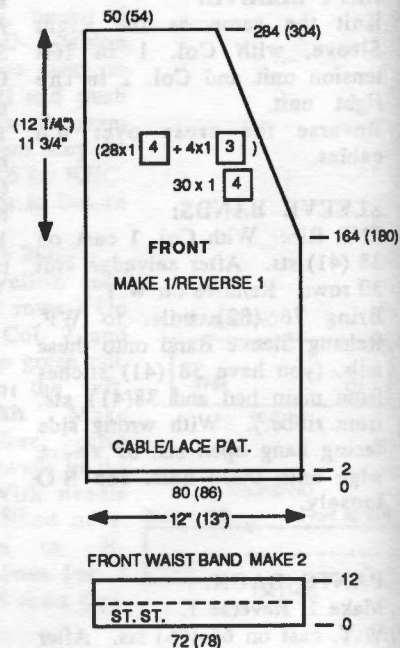

STITCH = 24 ROW = 60

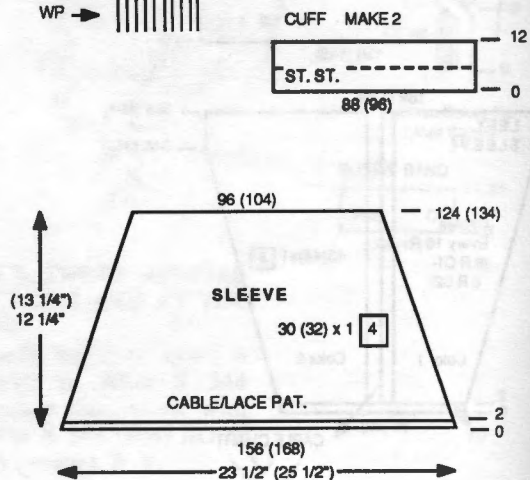
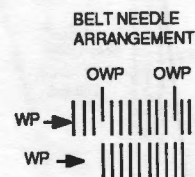
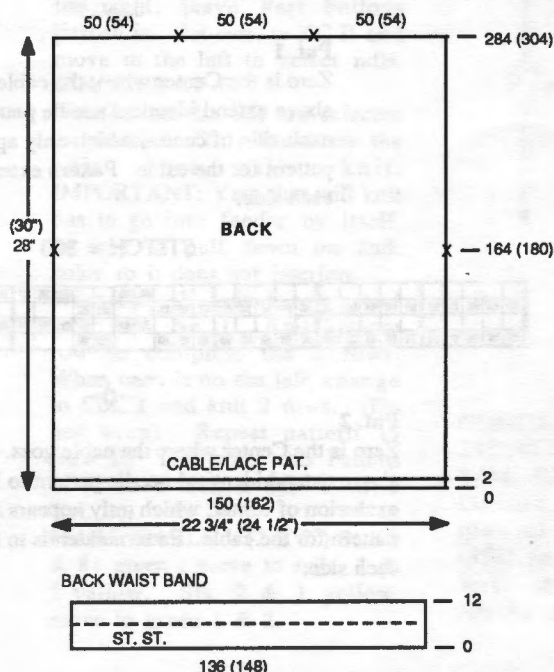
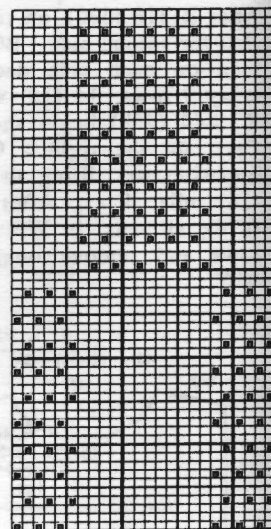

6-9-7



WOMENS TOP

YARN: Bulky Venetia
SIZES: 6/8 (10/12) [14]
AMOUNT:
 Col 1 Yel. 7 oz. 8 oz. 9 oz.
 Col 2 Pink 7 oz. 8 oz. 9 oz.
 Col 3 Blue 4 oz. 4 oz. 4 oz.
 Col 4 Whit 4 oz. 4 oz. 4 oz.
KIT PRICE:
 \$23.00 \$25.00 \$27.00
TENSION: T 3
GAUGE: 10.5 sts. 22 rows =
 2" (5 Cm)

Make on the Simple Seven.
 Some Patterns made using the
 needle pusher. Some by manual
 needle transfers.

FRONT/BACK: The Same.
 W.Y. cast on 89 (94) [99] sts.
 After several rows end with 1
 row Ravel Cord to the right.
 Change to Col. 1 and knit 2
 rows. Begin pattern No. 1. At
 the same time ON EACH SIDE,
 inc. 1 st. every 31 (33) [35]
 Rows 5 x.

Pattern #1: Using 3 x 1 needle
 pusher, and working from the
 center outward to each side,
 *bring every 4th needle to -E-
 position. Set carriage for
 Holding. Right and left lever to
 -H-. Knit 4 rows. Return levers
 on carr. to -N-. Knit 2 Rows.*
 Repeat from * to * for a total
 of 18 (20) [22] rows. Change to
 Col. 4 and knit 4 rows. With
 single needle transfer tool,
 transfer every 5th st. to the
 adjoining needle. (Eyelet
 pattern.) and leave needles in
 WP. After transfers, knit 4
 rows.

After R 26 (28) [30], change to
 Col. 2 and set pattern No. 2.
Pattern #2: Using 1 x 1 needle
 pusher, *bring every other
 needle to -E- position. Set
 levers on carr. to H, and knit 3
 rows. Return levers on carr. to -
 N-. Knit 1 Row,* and repeat

from * to * for pattern. After
 58 (62) [66] change Col. 4, knit
 4 rows. Make row of eyelets,
 same as before and knit 4 rows.
Pattern #3: Change to Col. 3.
 Arrange needles in the following
 manner. Starting from the
 outside, leave 3 needles in -B-
 position. Bring the next needle
 to -E- position next needle in -
 B- position, next needle to -E-
 position, next needle to -E-
 position. Repeat across to
 outside. Set levers to H. Knit 2
 Rows. Release H, Knit 2 Rows.
 Repeat 32 (34) [36] rows of
 pattern. Follow chart for pattern
 and color changes. After R 158
 (168) [178], on each side inc. 1
 st. every row 6 x. After R 230
 (244) [258] Shape neck opening
 and shoulder slope at the same
 time.

For neck, BO the center 45 (48)
 [51] sts. Place remaining sts.
 on the left into HP and complete
 the right side first. *On neck
 edge BO 1 st. every other st. 4
 X. On shoulder BO or use short
 row method 7 sts. 3 x, 9 sts. 1
 x, (7 sts. 2 x, 8 sts. 2 x) 7
 sts. 1x, 8sts. 3x. Bring sts. on
 the left back into work. Turn
 counter back to R 230 (244)
 [258] and complete to match the
 right side. Follow instructions
 from *.

FINISHING:
 See General Instructions.
 With 1 strand Col. 4 crochet 1
 row single crochet around lower
 edge, neck and sleeve opening.

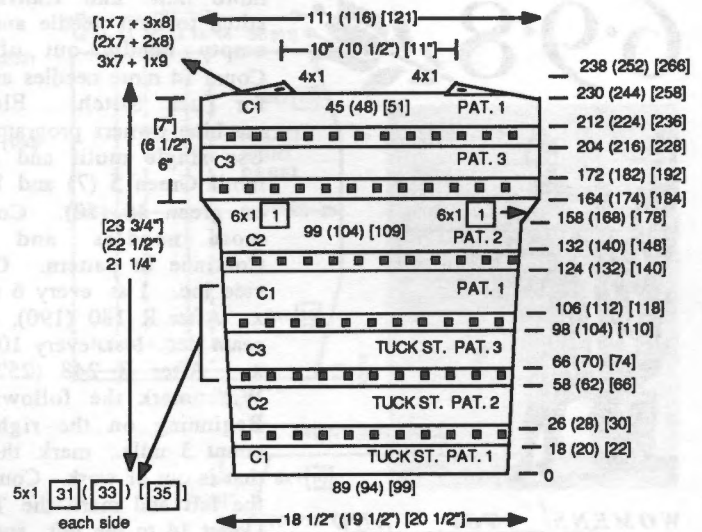

PAT. 1: Use 3x1 needle pusher. Leave 3 in WP and 1 in Position 'E' (holding position). Knit 4 rows. Release H Cam and Knit 2 rows.

PAT. 2: Use 1x1 needle pusher. Leave 1 in WP and 1 in 'E' Position (holding position). Knit 3 rows. Release H Cam and knit 1 row.

PAT. 3: Mark needle bed beginning from side. 3 ndls in WP and 1 ndl in 'E' position (holding position), 1 ndl in WP, 1 ndl in HP, 1 ndl in WP, 1 ndl in HP. Knit 2 rows. Release H Cam and knit 2 rows.

PAT. 4: Eyelet is made by hand transferring every 5th st.

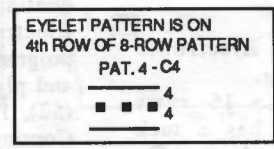

CUT YOUR KNITTING TIME IN HALF!!

•Features
Two Speeds

•Foot-Pedal
or
Push-Button
operation

•Continuous
or one-
row-at-a-
time knitting

With KNITKING's Motorized Drive Arm, available in early Fall, you will be able to reduce your knitting time by as much as half or more through the convenience of automation.

As its name implies, this motor attaches to the K-Carriage of your KNITKING knitting machines—Punch Card, Electronic or Bulky—and automatically moves it back-and-forth across the knitting bed, in the same fashion that your arm does... only it does it faster and effortlessly!

We will continue to tell you more about it as the "estimated time of arrival" approaches, but don't hesitate—a \$200.00 deposit will reserve one just for you!

•Automatic
Shut-Off

•Row
Counters

•Yarn
Tension
Units

6-9-8



WOMENS TOP AND PLEATED SKIRT

YARN: Venetia
SIZES: 8/10 (12/14)
AMOUNT:
 Col. 1 19 oz. 20 oz.
 Col. 2 11 oz. 12 oz.
KIT PRICE: \$43.00 \$45.50
TENSION: St. st. (Skirt & sleeves) T 4.2. Fairisle - T 6. Rib 6/6 II
GAUGE: Fairisle 17 sts. 22 rows = 2" (5 Cm)
 St. st. 18 sts. 24 rows = 2" (5 Cm)

Make on any Electronic Machine with Ribber. Fairisle is a 24 st. x 16 rows pattern. The skirt has a tuck stitch for form the pleats. On punch card machines these ndls. would have to be hand selected.

SKIRT BACK: Make 1. W.Y. cast on 168 (177) sts. After several rows, end with 1 row Ravel Cord to the right. Change to Col.1 and continue in st. st. On each side inc. 1 st. every 16 rows 6 x. After R 180 (190) on each side dec. 1 st. every 10 rows 6 x. After R 248 (252) mark each side with W.Y. (Guide for pleat and yoke sections). On each side dec. 1 st. every 10 rows 5 x. After R 300 (310) remove on W.Y.

SKIRT FRONT: Left panel. Starting at ndl. 64 (67) to the left of -0- W.Y. cast on 129 (134) sts. same as Skirt Back. Change to Col. 1 and knit 2 rows. Starting from the right side count 3 ndls. Transfer the 3rd st to next needle and place 3rd st. ndl. in -A- position, out of work. (Leave 3rd needle out of work for entire skirt). Count 14 ndls. to the left and mark the 14th ndl. as Tuck Stitch. Count 14 more ndls. to the left and mark the 14th ndl. Count 14

more ndls. and transfer this stitch to next needle and place empty. needle out of work. Count 14 more needles and mark for Tuck Stitch. Electronic machine owners program Pat. 1. Use single motif and place 1 motif Green 5 (7) and 1 Motif on green 48 (50). Count 14 more needles and mark. Continue in pattern. On edge side inc. 1 st. every 6 rows 16 x. After R 180 (190), on side seam dec. 1 st. every 10 rows 6 x. After R 248 (252), with W.Y. mark the following sts. Beginning on the right side, count 3 ndls., mark the stitch that is out of work. Count 14 to the left and mark the Tuck st. Count 14 to the left and mark, count 14 and mark st. out of work, count 14 and mark tuck st. count 14 to the left and mark. Remove skirt section on W.Y.

SKIRT FRONT: Right panel. Starting at ndl. 77 (80) to the left of -0- W.Y. cast on 154 (159) sts., same as before. Change to Col. 1 and knit 2 rows starting from the left side count 14 needles and mark the 14th needle. Follow chart and continue to mark skirt panel. Electronic machine owners program Pat 1. Use single motif and place 1 motif on Yellow 49 (52), 1 motif on Yellow 6 (9). Continue in pattern. On side edge inc. 1 st. every 16 rows 6 x, After R 180 (190) on side dec. 1 st. every 10 rows 6 x. After R 248 (252) Knit to R 300 (310). See chart and mark stitches accordingly. Remove on W.Y.

SKIRT YOKE: Front Only With purl side facing, rehang left panel on to 70 (73) needles forming pleats according to chart, decreasing the few extra needles evenly across. With purl side facing rehang the right panel onto 98 (101) needles same as before decreasing the few extra needles evenly across. on larger size. Bring ndls. to E, Cam at "N". Close latches and continue in st. st. On each side dec. 1 st. every 10 rows 5 x. After R 52 (58) remove on contrast W.Y.

SKIRT WAIST BAND: Make 2. Bring 116 (125) ndls. to WP. With wrong side facing, hang open stitches of skirt onto these ndls. decreasing evenly across. With Col. 1 knit 1 row at T 10. Change to T 4.2 and knit to row 30. Carriage on the right. Pick up first row (the loose tension row) to form hem and BO.

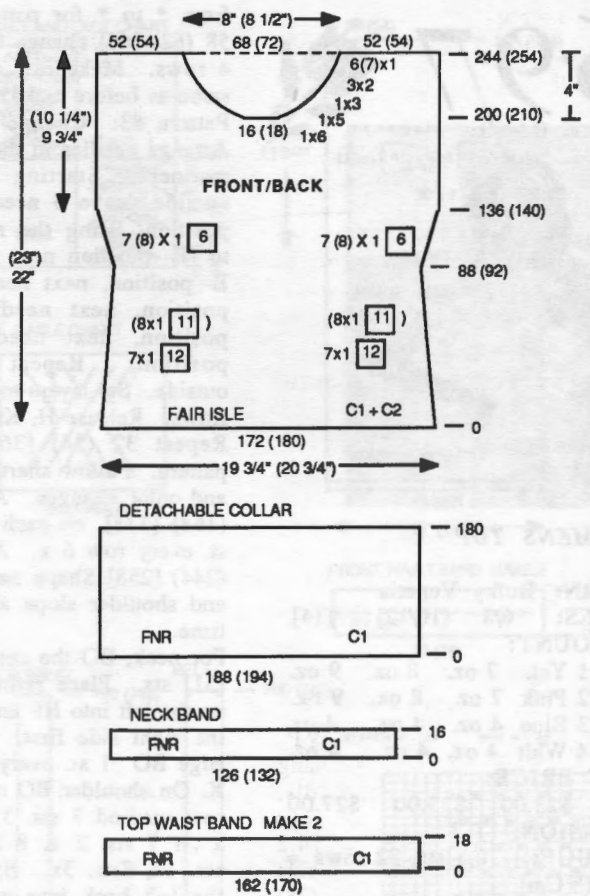

TOP FRONT: W.Y. cast on 172 (180) sts. After several rows, end with 1 row Ravel Cord to the right. Change to Col. 1 and knit 1 row to the left. Set Fairisle pattern and knit to the right to select ndls. With Col. 2 in feeder B continue in pattern. On each side dec. 1 st. every 12 rows 7 x, (1 st. every 11 rows 8 x.) After R 88 (92) on each side inc. 1 st. every 6 rows 7 (8) x. After R 136 (140) mark each side with W.Y. for sleeve opening. After R 200 (210) shape neck opening. BO the center 16 (18) sts. MARK PLACE IN PATTERN. Place remaining sts. on the left into 'A' position. Use Ravel Cord and place some tape over the side in front of Gate Pegs to avoid damage to that row and complete the right side first. *On the neck edge BO 6 sts. 1x, 5 sts. 1 x, 3 sts. 1 x, 2 sts. 3 x, 1 st. 6 (7) x. After R 244 (254) BO or remove sts. on W.Y.

Bring sts. on the left back into WP. Remove tape and see your manual for how to select same needles. Return to correct place in pattern and select ndls. Turn counter back to Row 200 (210) and complete to match the right side following instructions from *

TOP BACK:

Same as Front except no neck shaping.

NECK BAND: Make 1.

CLOSE ONE SHOULDER FIRST.
FNR: With Col. 1, cast on 126 (132) sts. After regular selvedge, knit 16 rows. Transfer ribber sts. to the MB. With wrong side facing, hang neck opening onto these ndls. and BO.

TOP FRONT WAIST BAND:

Make 2.
FNR: With Col. 1 cast on 162 (170) sts. After regular selvedge, knit 18 rows. Transfer ribber sts. to MB. With wrong side facing, hang open sts. of Front/Back onto these ndls. decreasing evenly across. and BO.

SLEEVES:

Close second shoulder.
 Bring 168 (176) ndls. to WP. With wrong side facing, hang sleeve opening onto these ndls. using W.Y. markers as your guide. With Col. 1 at T4.2 continue in st. st. On each side dec. 1 st. every 8 rows 27 (28) x. After R 226 (232), remove remaining sts. onto W.Y.

SLEEVE CUFFS:

FNR: With Col. 1 cast on 56 (62) sts. After selvedge knit 20 rows. Transfer ribber sts. to MB and with wrong side facing hang open sts. of sleeve onto these ndls. decreasing evenly across and BO.

DETACHABLE COLLAR:

Make 1.
FNR: With Col. 1 cast on 188 (194) sts. After selvedge knit 180 rows. Transfer rib sts. to MB and BO. Join ends to form a circle.

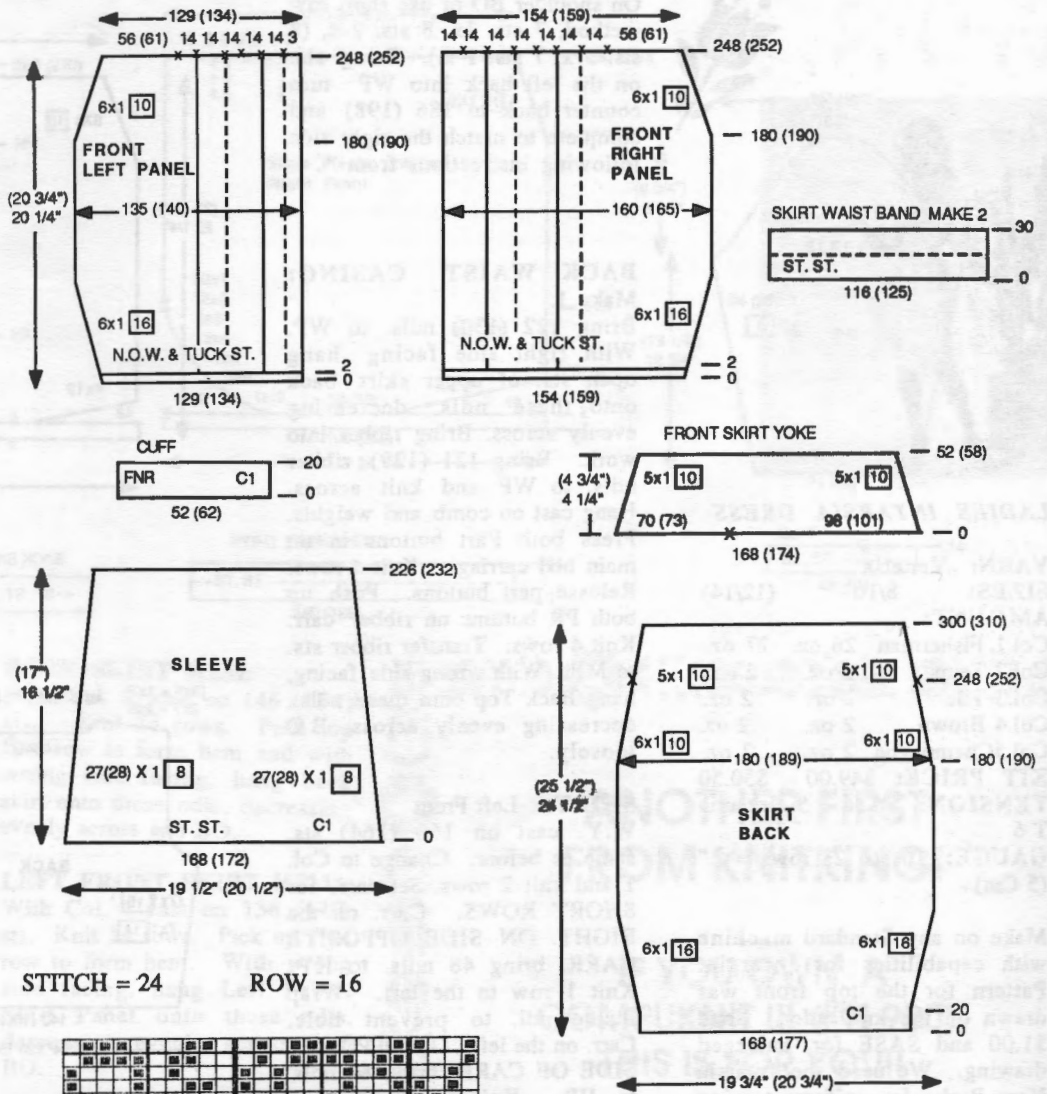

STITCH = 24 ROW = 16

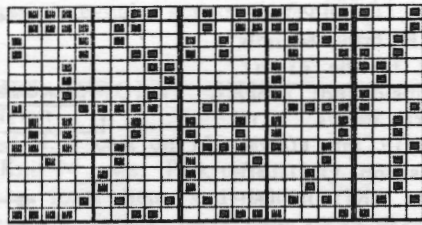

STITCH = 1 ROW = 2
 TUCK ST
 PLEATED SKIRT

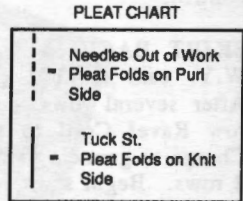

FINISHING:
 See General Instructions.



ONE PICTURE IS WORTH A 1000 WORDS !!

With the new KNITKING-compatible dot-matrix printer, you can now print out a hard copy of the original patterns you have created using the KC III pattern design computer.

USE THIS PRINTER TO:

- Provide a "hard copy" of your unique patterns to share with your friends.
- Provide a template of your patterns to use as a guide for creating your own punch cards for use with your punch card machines.
- Provide a ready pictorial reference of your design creations.

FEATURES INCLUDE: • Yarn color change Indicator • Extra large pattern print-out accommodation • Form Feed feature • Uses plain paper or tractor-fed • Includes a unique "Kwik-Konnect" cable for connection to KC III

By connecting this new printer to your KC III, you too can appreciate the "1000 word value" of having "one picture"...This innovative combination is truly a "match made in heaven," as the opportunities to expand your knitting horizons are now virtually unlimited!!

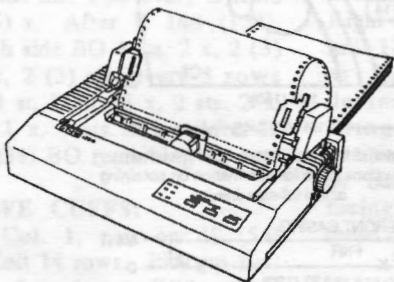



LADIES INTARSIA DRESS

YARN: Venetia
SIZES: 8/10 (12/14)
AMOUNT:
 Col.1 Fisherman 26 oz. 27 oz.
 Col.2 Taupe 2 oz. 2 oz.
 Col.3 Tile 2 oz. 2 oz.
 Col.4 Brown 2 oz. 2 oz.
 Col.5 Champagne 2 oz. 2 oz.
KIT PRICE: \$49.00 \$50.50
TENSION: St. st. T 5, Intarsia T 6
GAUGE: 16 sts. 23 rows = 2" (5 Cm)

Make on any Standard machine with capabilities for Intarsia. Pattern for the top front was drawn on the knitleader. Send \$1.00 and SASE for enlarged drawing. We used the Intarsia Yarn Brake for uniform tension control.

SKIRT BACK:

W.Y. cast on 172 (180) sts. After several rows, end with 1 row Ravel Cord to the right. Change to garment yarn and knit 2 rows. Begin short rows. On opposite side of carr. bring to HP 48 ndls. on each side. (Be sure to wrap to prevent holes.) On opposite side of carr. push back 12 sts. 4x on each side. Continue in st. st. After R 186 on each side dec. 1 st. every 10 rows 8 x. After R 260 (270). remove on W.Y.

TOP (BACK):

W.Y. cast on same as before. Change to Col.1 and continue in st. st. On each side inc. 1 st. every 14th row (15th row) 7 x. After R 100 (106) shape armhole. On each side BO 5 sts. 1 x, 3 (4) sts. 1 x, 2 sts. 4 x, 1 st. every 3 rows 6 x. After R 186 (198) Shape neck opening and shoulders at the same time. BO the center 44 (48) sts. Place the sts. on the left into HP and complete the right side first. *On neck BO 1 st. EOR 4 x..

On shoulder BO or use short row method, 7 sts. 1x, 8 sts. 2 x, (8 sts. 3-x, 7 sts. 1 x.). Bring sts. on the left back into WP turn counter back to 186 (198) and complete to match the right side following instructions from *.

BACK WAIST CASING:
 Make 1.

Bring 122 (130) ndls. to WP. With right side facing hang open sts. of upper skirt back onto these ndls. decreasing evenly across. Bring ribber into work. Bring 121 (129) ribber ndls. to WP and knit across. Hang cast on comb and weights. Press both Part buttons in on main bed carriage. Knit 4 rows. Release part buttons. Push up both PR buttons on ribber carr. Knit 4 rows. Transfer ribber sts. to MB. With wrong side facing, hang Back Top onto these ndls., decreasing evenly across. BO loosely.

SKIRT: Left Front

W.Y. cast on 160 (164) sts. same as before. Change to Col. 1 and knit 2 rows. Set carr. for SHORT ROWS. Carr. on the RIGHT. ON SIDE OPPOSITE CARR. bring 48 ndls. to HP. Knit 1 row to the left. Wrap inside ndl. to prevent hole. Carr. on the left. ON OPPOSITE SIDE OF CARR. bring 80 ndls. to HP. Knit to the right. Always wrap inside ndl. when knitting Short Rows. ON OPPOSITE SIDE OF CARR. push to 'D' position ON THE LEFT, 12 sts. 4x, AND ON THE RIGHT, push back 12 sts. 1x, 7 sts. 1x, 5 sts. 1x, 4 sts. 2x, 3 sts. 2x, 2 sts. 9x, 1 st. 24x. Continue in St. St. to R. 186. On left, dec. 1 st. every 10 rows 8x. After R 260 (270) remove on W.Y.

SKIRT: Right Front.

W.Y. cast on same as before. After Ravel Cord row change to Col. 1 and knit 2 rows. Work SHORT ROWS in the same way as you did for Left Front (see chart). ON THE LEFT, bring to HP 112 ndls., knit 1 row and ON THE RIGHT bring to HP 48 ndls. ON THE LEFT, 16 sts. 1x, 9sts. 1x, 5 sts. 2x, 4 sts. 2x, 3 sts. 5x, 2 sts. 12x, 1 st. 30x AND AT THE SAME TIME on the RIGHT, push back to 'D' position, 12 sts. 4x. Continue in St. St. to R186. On the right side dec. 1 st. every 10 rows 8x. After R 260 (270) mark the ndls. for pleats as shown on Chart, then remove on W.Y.

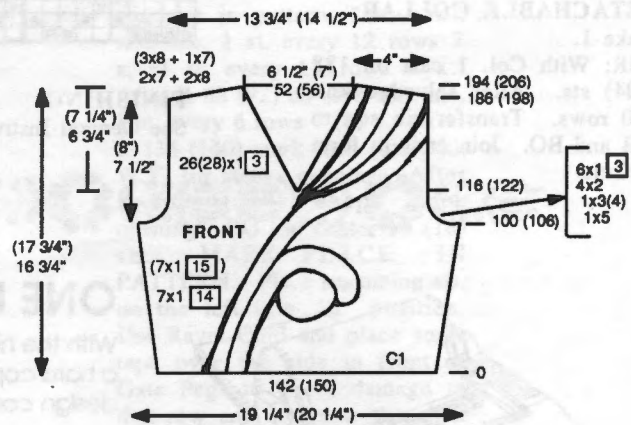
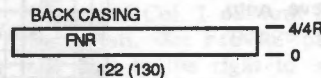
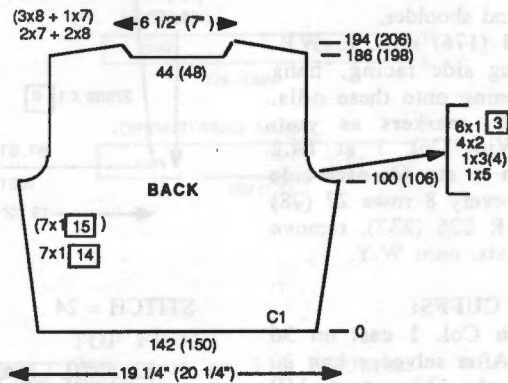
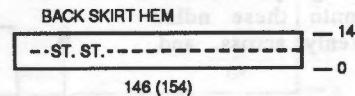
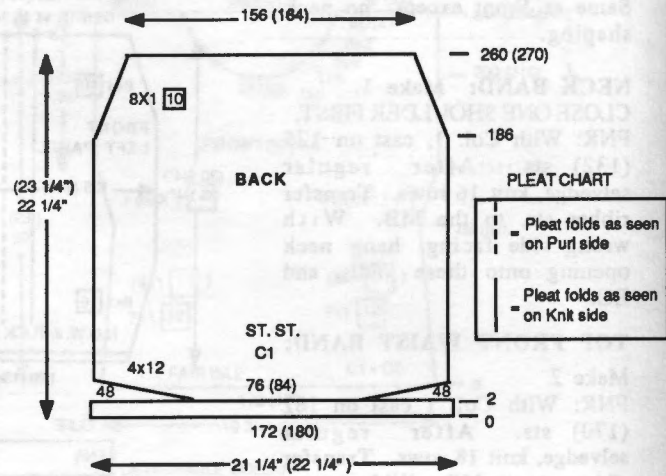

Simulated Intarsia Pattern. See "Note" on instructions page for information on obtaining actual full-size drawing.

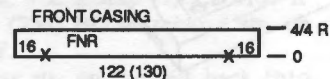

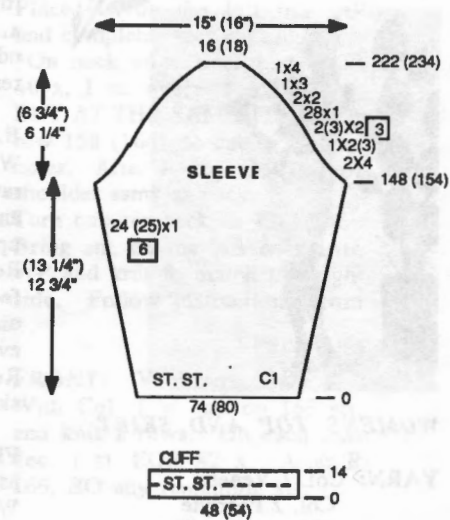
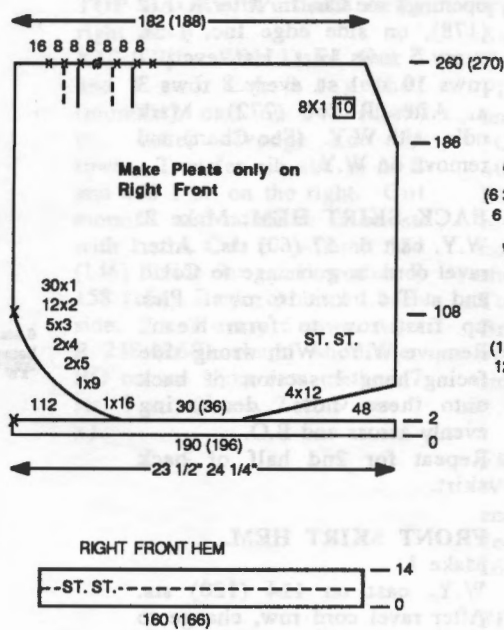
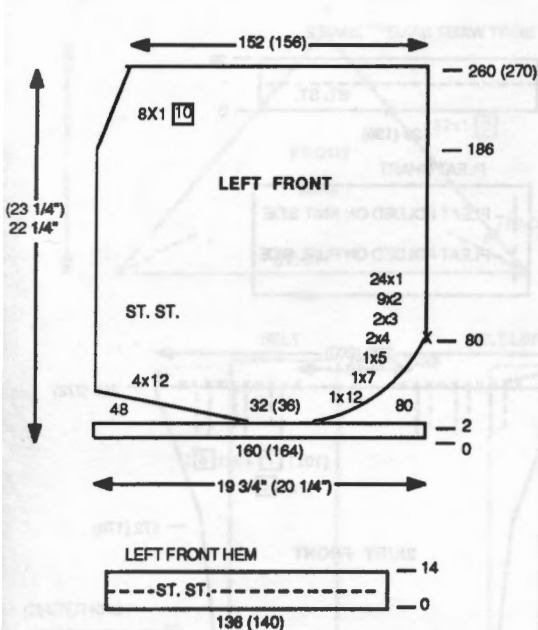

TOP FRONT:

Draw pattern on Knitleader or transfer to Graph paper. W.Y. cast on 142 (150) sts. After Ravel Cord row change to Col. 1. Knit 2 rows and begin Intarsia Pattern. On each side inc. 1 st. every 14 rows 7 x, (1 st. every 15 rows 7 x). After R 100 (106) shape armhole. On each side BO 5 sts. 1 x, 3 (4) sts. 1 x, 2 sts. 4 x, 1 st. every 3 rows 6 x. After Row 116 (122) divide in center for -V-neck. Remove the sts. on the left on W.Y. Continue in Intarsia pattern and *on neck edge. dec. 1 st. every 3 rows 26 (28) x. After R 186 (198) shape shoulders, same as back.* Hang sts. on left, held on W.Y. back onto machine. Turn counter back to 116 (122) and complete to match right side following instructions from * to *

SLEEVES:

W.Y. cast on 74 (80) sts. After Ravel Cord row, change to Col. 1 and continue in st. st. On each side inc. 1 st. every 6 rows 24 (25) x. After R 148 (154), on each side BO 4 sts. 2 x, 2 (3) sts. 1x, 2 (3) sts. every 3 rows 2 x, 1 st. EOR 28 x, 2 sts. 2 x, 3 sts. 1 x, 4 sts. 1 x. After R 222 (234) BO remaining sts.

SLEEVE CUFFS:

With Col. 1, cast on 48 (54) sts. Knit 14 rows. Pick up first row to form hem. With wrong side facing, hang open sts. of sleeve onto these ndls. decreasing evenly across and BO.

BACK SKIRT HEM:

With Col. 1, cast on 146 (154) sts. Knit 14 rows. Pick up first row to form hem and with wrong side facing, hang back skirt onto these ndls. decreasing evenly across and BO.

LEFT FRONT SKIRT HEM:

With Col. 1 cast on 136 (140) sts. Knit 14 rows. Pick up first row to form hem. With wrong side facing, hang Left Front Skirt Panel onto these ndls. decreasing evenly across, and BO.

RIGHT FRONT SKIRT HEM:

With Col. 1 cast on 160 (166) sts. Knit 14 rows. Pick up first row to form hem and with Wrong side facing, hang open sts. of R. Front skirt onto these ndls. and BO.

FRONT WAIST CASING:

Bring 122 (130) ndls. to WP. With right side facing, start on needle 17 on the left, hang Left Front panel onto these ndls. decreasing evenly across. With Right side facing, and starting at ndl. 17 on the right, form pleats as indicated on the chart decreasing evenly across. Bring ribber to working position and make casing same as back. With wrong side facing, hang Front Top onto these ndls. and BO.

FINISHING:

See General Instructions. Set in sleeve. Close side seams. Crochet 1 row single crochet and 1 row reverse single crochet around collar.



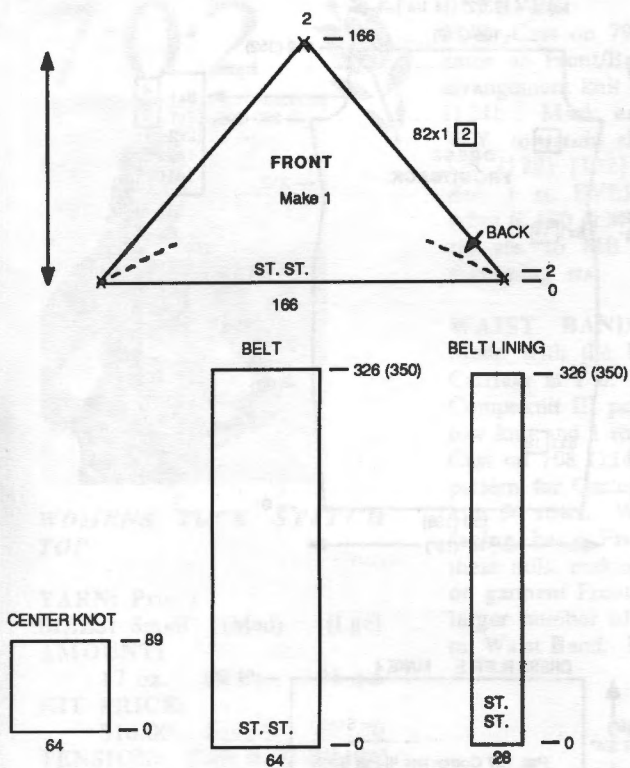

TOP BACK: (Purl side is the right side.)

K1/P1 Rib: With 1 strd. Col. 2 and 1 strd. Col. 3 together (monofil), cast on 141 (149) sts. After selvedge knit 36 rows. Transfer rib sts. to MB and add 1 st. on the right. Cut monofil and continue in st. st. with 1 strd. Col. 2. After R 134 (146) divide for opening after R 158 (164). Begin cables on each side. 2 x 2 every 6 rows. After R 238 (250) shape shoulders. BO or use short row method 7 sts. 3 x, (8 sts. 2 x, 9 sts. 1 x).

TOP FRONT:

Same as Back to R 134 (146). Divide in center for 'V' shaping. Place sts. on the left into HP and complete the right side first. *On neck edge Dec. 1 st. EOR 40 x, 1 st. every 3 rows 10 x BUT AT THE SAME TIME after row 158 (164) do cables on arm holes. After R 238 (250) shape shoulder same as back. Turn counter back to 134 (146). Bring sts. on the left back into WP and knit to match the right side. Follow instructions from *.

FRONT: 'V' Insert Make 1.

With Col. 1 'e' cast on 166 sts. and knit 2 rows. On each side dec. 1 st. EOR 82 x. After R 166, BO any remaining sts.

FINISHING:

See General Instructions.

Belt: Make pleats on knit side to fit the 28 sts. of belt lining (cut and seam center). Pleat knot and sew in center of belt. Seam on inside.

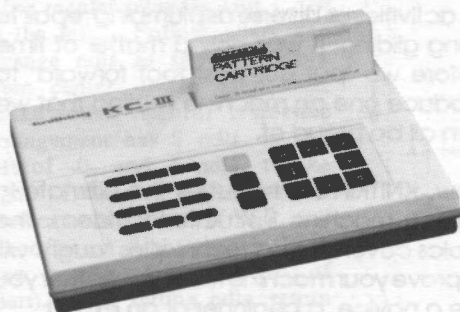

"CASEY" MAKES DESIGNING A BREEZE!

"Casey" is our nickname for the revolutionary new KCIII Pattern Design Computer. And, if you like to create your own designs, then you will find this newest of accessories to be a "dream come true."

This accessory for your **Compuknit III** knitting machine is not only the most recent entry in a long line of innovative products from KNITKING -- It is quite possibly the most versatile tool yet developed for creating the design masterpieces that will truly astound your friends.

By turning your color television set into a knitwear design studio, you can indulge all of your creative fancies, while at the same time make fine-tuning adjustments in your beautiful designs with the push of a button. Then, you can experiment with different yarn color combinations *right on your T.V. screen!*

You can find out more about "Casey" farther along in this magazine. But don't hesitate...order your very own KCIII today and take advantage of our low introductory price of \$449.95. The sky is the limit!

7·0·1



STRAPLESS STARLITE DRESS

YARN: Starlite
SIZES: 6/8 (10/12)
AMOUNT: 18 oz. 21 oz
KIT PRICE: \$17.00 \$20.00
TENSION: St. st. & Lace T 5,
 Rib 4/4 I
GAUGE: 15.5 sts. 24 rows =
 2" (5Cm)
NOTIONS: 1/4" elastic for
 Collar

Make on any Standard or Electronic machine with lace carriage and Ribber.

DRESS RUFFLE: Make 4.
 Bring 144 (168) needles to W.P. After W.Y. cast on, knit several rows, ending with one row Ravel Cord. Bring all needles to 'E' position. Using crochet method and latch tool, from Left to Right cast on with garment yarn 144 (168) sts. Knit 2 rows st. st. Set Lace pattern and continue in lace to R 94 (98). Remove on W.Y.

DRESS FRONT/BACK:
 Make 2.
 Bring 130 (138) ndls. to WP. With wrong side facing hang open sts. of 2 sections of Dress ruffle sections onto these ndls. decreasing evenly across and doubling or tripling sts. as needed. Bring all ndls. to -E-position, close the latches (easier to knit the first row) and continue in st. st. On each side inc. 1 st. every 18 rows 5 x. After R 134, on each side dec. 1 st. every 14 rows 5 x. After R 212 inc. 1 st. every 14 rows 5 x. After R 290 (296) on each side BO 4 (5) sts. 1 x, 3 sts. 1 x, 2 sts. EOR 2 x, 1 st. EOR 3 x, 1 st. every 4 rows 3x. After R 342 (352) remove remaining sts. on W.Y.

DRESS COLLAR: Make 2.
FNR: Cast on 128 (134) sts. after selvedge, at T 4/4 I knit 60 rows. Make casing. Put both PR buttons up on Ribber Carr. and knit 4 rows. Push in both Part buttons on Main Bed Carr. and return Ribber Carr. to regular setting. Knit 6 rows. Return MB carriage to normal setting each side mark the 14th st. Transfer ribber sts. to MB with wrong side facing hang dress front/back starting from mark and ending on mark, decreasing the few sts. evenly across. BO loosely.

FINISHING:
 See General Instructions.
 1 row of single crochet and 1 row of reverse single crochet around armhole opening.

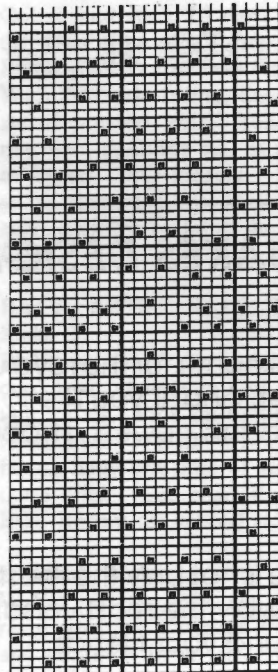
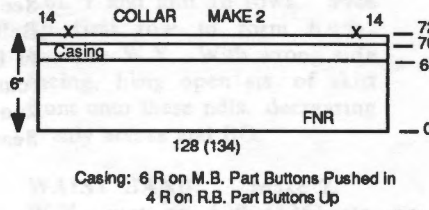

PAT. 137 IN PATTERN BOOK

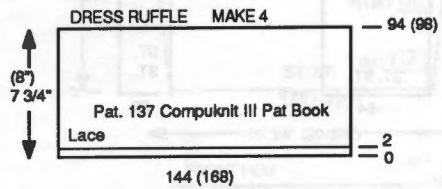
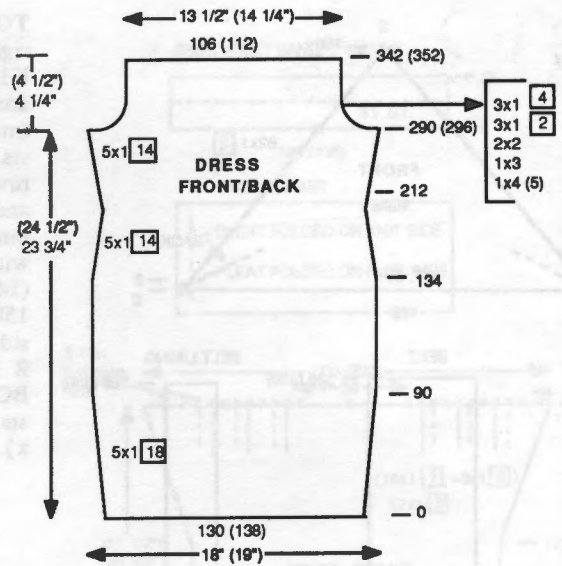

VIDEOTAPE LESSONS

With videotape lesson plans now available on activities as diverse as plumbing repair to hang gliding, it was only a matter of time before we "put our best foot forward" to produce one on machine knitting that we can all be proud of.

Now, KNITKING introduces the ultimate in knitting machine instructional videos. The topics covered and techniques taught will improve your machine knitting whether you are a novice, a beginner or an expert.

Featuring the knitting talents of Jan Wold and Jan Mills, two of the most respected writers and teachers in our industry, these videos even include a start-to-finish garment-making lesson, and cover the use of all of the accessories that KNITKING machines are famous for.

We will be advertising these videos for sale in upcoming bulletins . . . so stay tuned to KNITKING and get your video machine ready!

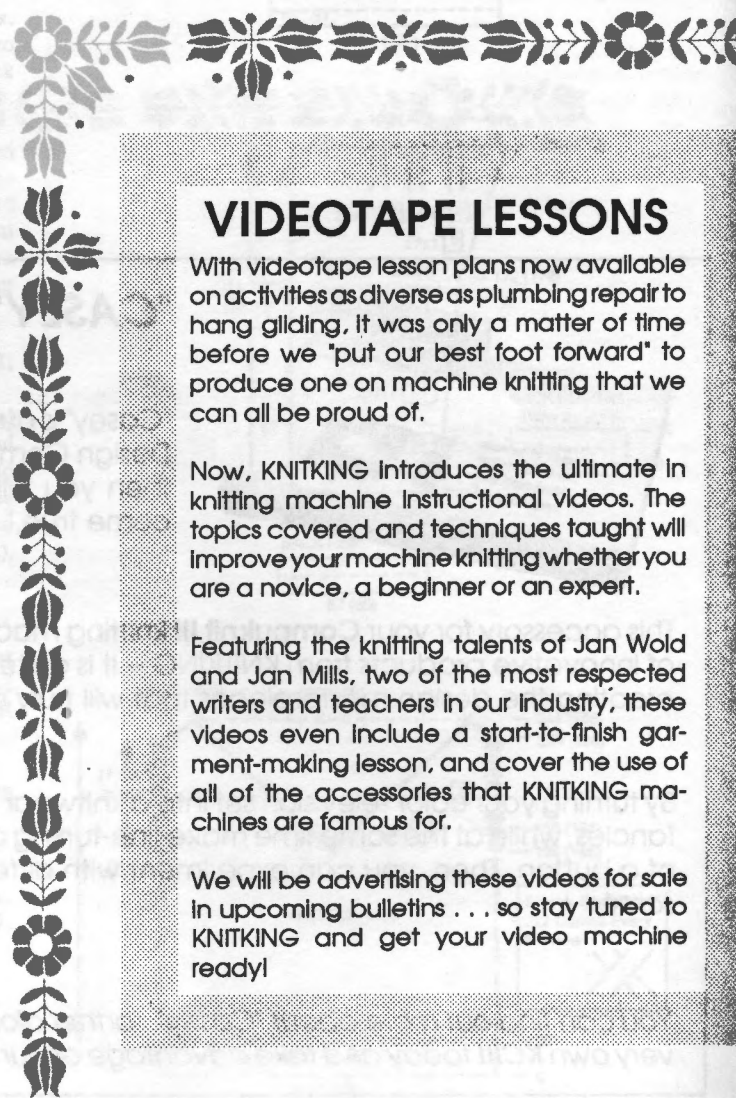

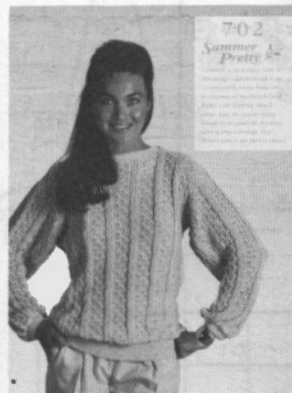

WOMENS TUCK STITCH TOP

YARN: Primo

SIZES: Small (Med) [Lge]

AMOUNT:

17 oz. 19 oz. 21 oz.

KIT PRICE:

\$16.00 \$18.00 \$20.00

TENSION: Tuck st. & Rib 2/2 I, Electric Garter Carr. T 6

GAUGE: 8.5 sts. 15.5 rows = 2" (5 Cm)

Make on the Bulky Punch card machine with Ribber. Bands were made on the Electric Garter Carriage in Garter Stitch. TWO strands of yarn throughout.

FRONT/BACK:

FNR: With garment yarn, pitch - H- cast on 85 (90) [95] sts. After regular selvedge knit 1 row to the left. Follow chart and arrange ndls as shown. Work from center -0- to each side. Make sure center needle arrangement has 3 ndls. to the left of -0- and 4 ndls. to the right. Pattern is as follows: 7 needles on main bed in W.P. and 3 needles on Ribber bed in W.P. (see needle arrangement of chart). After setting ndls. return Half Pitch lever to P. Set punch card and at KC knit to the right to select ndls. activate card and continue in pattern. After R 96 (100) [104] on each side BO 6 sts. 1 x, 1 st. EVERY ROW 6 x. After R 158 (166) [174] shape neck. BO the center 27 (30) [33] Mark place in pattern, and place remaining sts. on the left into HP and complete the right side first. *On neck edge dec. 1 st. EOR 3 x. After R 164 (172) [180] transfer rib sts. to MB and BO or remove sts. on W.Y. Bring ndls. on the left back into WP. Turn counter back to 158 (166) [174] find your place in pattern, select ndls. and complete to match the right side.

SLEEVES:

FNR: Cast on 79 (84) [89] sts. same as Front/Back. After ndl. arrangement knit to R 116 (120) [124]. Mark each side with W.Y. to set in sleeve. After R 124 (128) [132] on each side dec. 1 st. EVERY ROW 6 x. After R 130 (134) [138] transfer rib sts. to MB and BO the remaining sts.

WAIST BANDS:

Make 2. Made with the Electric Garter Carriage at T 6. Pattern #537 in CompuKnit III pattern book. 1 row knit and 1 row purl. Cast on 108 (114) [120] sts. Set pattern for Garter St. and at T 6 knit 34 rows. With wrong side facing hang Front/Back onto these ndls. making extra stitches on garment Front/Back to match larger number of stitches found on Waist Band. BO.

SLEEVE CUFFS:

Cast on 42 (46) [50] sts. Set Pattern and with Garter Carr. knit 14 rows. With wrong side facing hang sleeve edge onto these ndls. and BO.

NECK BANDS:

Make 2. Cast on 74 (80) [86] and with Garter Carr. knit 14 rows. With wrong side facing hang neck opening onto these ndls. and BO.

FINISHING:

See General Instructions.

After closing shoulders, overlap neckband at shoulder seam and stitch down. Set in sleeve.

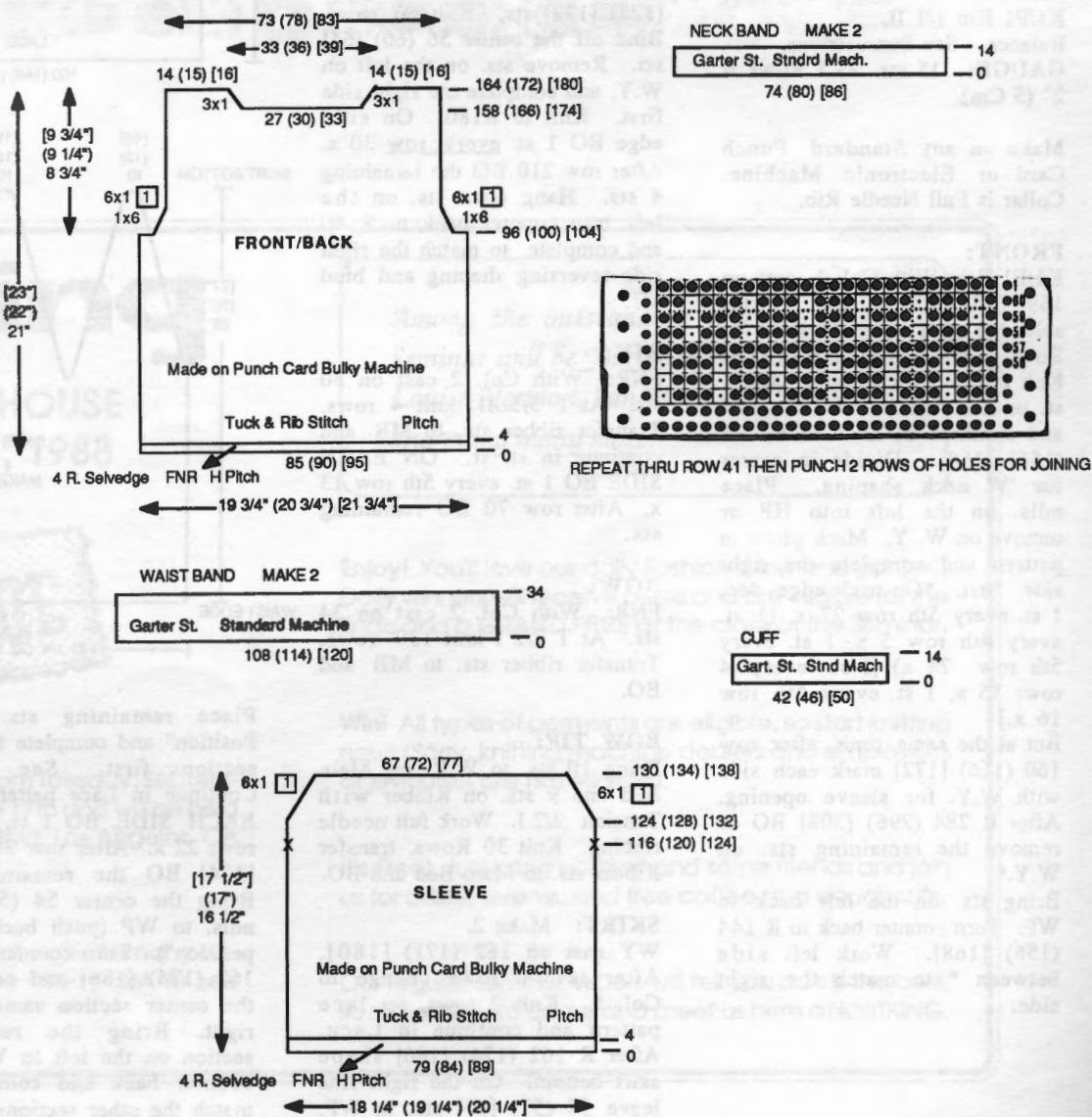

7·0·3



WOMENS 2 PC. LACE DRESS

YARN: Venetia
SIZES: 10/12 (14/16) [18]
AMOUNT:
 Col. 1 28 oz. 30 oz. 32 oz.
 Col. 2 3 oz. 3 oz. 4 oz.
KIT PRICE:
 \$44.00 \$47.00 \$50.00
TENSION: T5 for Lace,
 K1/P1 Rib 1/1 II.
 Balance - See Instructions.
GAUGE: 15 sts. 23.5 Rows =
 2" (5 Cm)

Make on any Standard Punch Card or Electronic Machine. Collar is Full Needle Rib.

FRONT:
 K1/P1 Rib: With Col. 1, cast on 159 (167) [175] sts. After selvedge at T 1/1 II, knit 44 Rows. Transfer Rib sts. to MB. Knit 2 rows over all ndls. Add 1 st. on the right. Set Lace Pat. and continue in Lace to R 144 (156) [168]. Divide in center for 'V' neck shaping. Place ndls. on the left into HP or remove on W. Y. Mark place in pattern and complete the right side first. *On neck edge dec. 1 st. every 5th row 27 x, (1 st. every 4th row 5 x, 1 st. every 5th row 24 x) [1 st. every 4 rows 15 x, 1 st. every 5th row 16 x.]
 But at the same time, after row 160 (166) [172] mark each side with W.Y. for sleeve opening. After R 284 (296) [308] BO or remove the remaining sts. on W.Y.*
 Bring sts. on the left back to WP. Turn counter back to R 144 (156) [168]. Work left side between * to match the right side.

BACK:
 Same as front but omit neck opening. After R 284 (296) [308] mark with W.Y. for neck opening. (See Chart) and BO or remove on W.Y.

SLEEVES:
CLOSE BOTH SHOULDERS.
 Bring 160 (168) [178] ndls. to WP. With wrong side facing hang sleeve opening between markers onto these ndls. With Col. 1, knit 2 rows over all ndls. Set Lace pattern and knit 110 (116) [122] rows. Remove on contrast W.Y.

SLEEVE CUFF:
 K1/P1 Rib: With Col. 1, cast on 81 (87) [93] sts. After selvedge knit 44 rows. Transfer rib sts. to MB. With Wrong side facing hang open sts. of sleeve edge onto these ndls., decreasing evenly across, and bind off loosely.

COLLAR: (St. St.)
 With Col. 2, 'e' cast on 124 (128) [132] sts. Knit 60 rows. Bind off the center 56 (60) [64] sts. Remove sts. on the left on W.Y. and complete the right side first. Knit to R180. On side edge BO 1 st. every row 30 x. After row 210 BO the remaining 4 sts. Hang open sts. on the left, turn counter back to R 60 and complete to match the right side reversing shaping and bind off.

BIB:
 FNR: With Col. 2 cast on 30 sts. At T 5/5 II. knit 4 rows. Transfer ribber sts. to MB and continue in st. st. ON EACH SIDE BO 1 st. every 5th row 13 x. After row 70 BO remaining sts.

BOW:
 FNR: With Col. 2 cast on 34 sts. At T 2/2 I knit 130 rows. Transfer ribber sts. to MB and BO.

BOW TIE:
 Bring 10 sts. to W.P. on Main Bed and 9 sts. on Ribber with Tension 2/2 I. Work full needle ribbing. Knit 30 Rows, transfer Ribber sts. to Main Bed and BO.

SKIRT: Make 2.
 WY cast on 162 (171) [180]. After several rows change to Col. 1. Knit 2 rows, set lace pattern and continue in Lace. After R 162 (174) [186] shape skirt bottom. On the right side leave 54 (57) [60] sts. in WP.

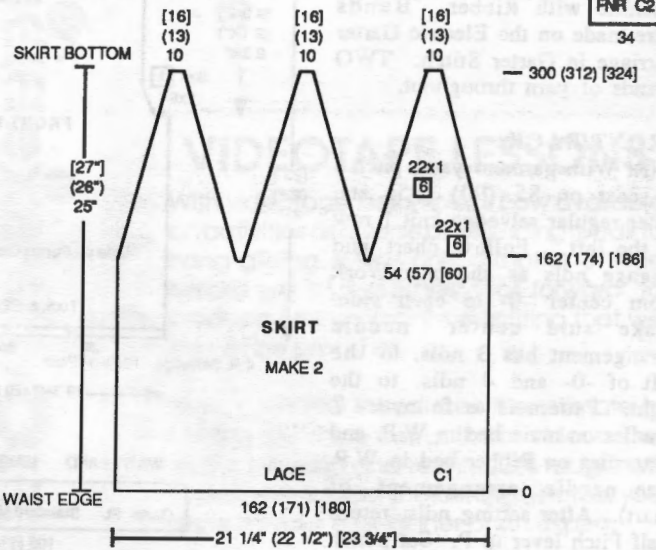
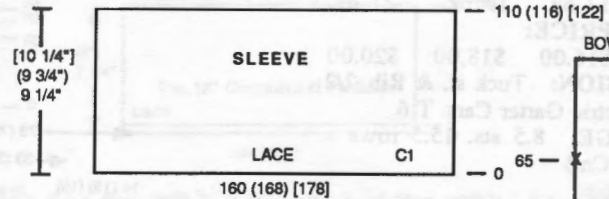
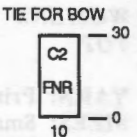
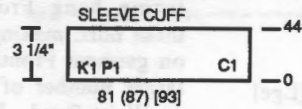
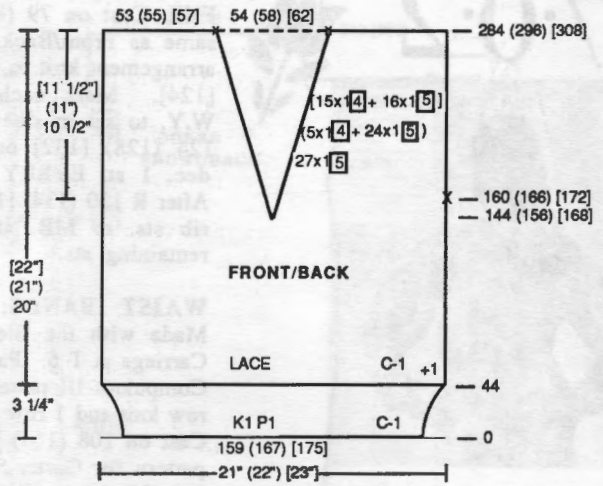

Place remaining sts. in "A Position" and complete the right sections first. See Chart. Continue in Lace pattern. ON EACH SIDE BO 1 st. every 6 rows 22 x. After row 300 (312) [324] BO the remaining sts. Bring the center 54 (57) [60] ndls. to WP (push back to "D position"). Turn counter back to 162 (174) [186] and complete the center section same as the right. Bring the remaining section on the left to WP, turn counter back and complete to match the other sections.

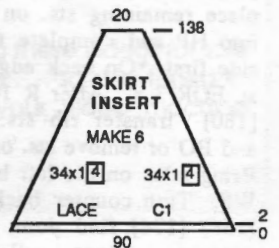
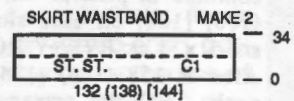

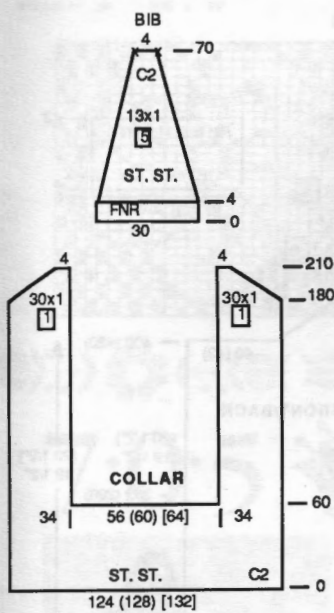

SKIRT INSERTS: Make 6. W.Y. cast on 90 sts. After several rows end with 1 row Ravel Cord to the right. Change to Col. 1 and knit 2 rows. Set Lace pattern. on each side BO 1 st. every 4th row 34 x. After R 138 BO the remaining sts.

SKIRT WAIST BAND:

Make 2. Bring 132 (138) [144] ndls. to WP. With wrong side facing hang open sts. of half of skirt waist onto these ndls. decreasing evenly across. Knit 34 rows st. st. Pick up 1st row to form hem and BO.

STITCH = 8 ROW = 22

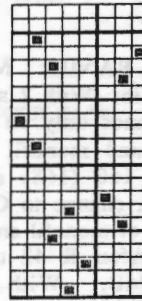

FINISHING:

See General Instructions. Join side seams of Skirt and stitch skirt inserts at skirt bottom. Pleat the small end into 2 pleats, one to be opposite from the other. Single crochet 1 row around skirt bottom and collar. Join Collar, Bib Bow around neck opening.



knitking

**SEMINAR & OPEN HOUSE
SEPTEMBER 13 - 17, 1988**



Join us! Our open house runs from Tuesday, September 13th through Saturday, the 17th and will be held at KNITKING, 1128 Crenshaw Blvd, Los Angeles, CA 90019.

Come and meet our experts along with many acknowledged guest authorities. You'll get to see great new products too!

Among the outstanding teachers at the Seminar will be Yukiko Mitsumata, Mary Louise Norman, Jan Wold and Jan Mills, and many many more.

Enjoy! You'll love our daily Fashion show and contest! Daily winners will receive prizes and are eligible for the finals and a GRAND PRIZE at the close of the Seminar.

Win! All types of garments are eligible, so start knitting now! (Sorry, knitting machine dealers and employees of KNITKING are not eligible).

It's Free! Just bring yourself and some friends and join us for prizes, events, and free coffee and doughnuts.

Our regular seminar visitors will tell you ours is the best, so remember to come and meet us here at KNITKING.

7·0·4



WOMENS TOP AND SKIRT

YARN: Col. 1 Pearlyte
Col. 2 Lumiyarn
Monofil

SIZES: 8/10 (12/14)

AMOUNT:

Col. 1 27 oz. 29 oz.

Col. 2 2 spools both sizes

Monofil: 1 spool both sizes

KIT PRICE: \$50.00 \$52.50

TENSION: T 4 Rib 0/0 II

GAUGE: 13 sts. 24 rows = 2"
(5 Cm)

Make on Electronic Machine with Ribber.

NOTE: For Compuknit III owners who do not want to input pattern as shown, see *Knitting News* this issue for alternate method of using Pattern #396 already in your machine.

Punch card owners substitute suitable pattern for isolated Fair Isle pattern on Front. Purl side is the right side on skirt and top, except yoke.

TOP FRONT: Make 1.

W.Y. cast on 52 (56) sts. After several rows, end with 1 row Ravel Cord to the right. Change to Col. 1 and continue in st. st. After R30, On the right inc. 1 st. every 8 rows 4 (5) x. 1 st. every 6 rows 2 x, 1 st. every 4 rows 12 x, 1 st. EOR 18 x, 2 Sts. 2 x. After R 163 shape neck. Dec. 1 st. EOR 40 x, 1 st. Every Row 38 x. After Row 164 (172) on the right side cast on 40 (42) sts. After row 177 shape neck same as for smaller size. After R 282 (296) inc. 1 st. every row 38 x, 1 st. EOR 40 x. After R 400 (420), on the right side BO 40 (42) sts. On the right side BO 2 sts. 2 x, 1 st. EOR 18 x, 1 st. every 4 rows 12 x, 1 st. every 6 rows 2 x, 1 st. every 8 rows 4 (5) x. After R 564 (592) remove on W.Y.

TOP BACK: Make 1.

Same as Front but omit neck opening and mark Rows 163 (177) and 399 (413) for neck opening.

WAIST BANDS: Make 2.

K1/P1 Rib: With 2 strands Col. 2 (2 strands only on selvedge) & 1 strand monofil together cast on 160 (168) sts. After selvedge, change to Col. 1 plus 1 strand of monofil and continue in rib. After R 42 transfer rib sts. to MB. With knit side facing hang bottom edge of Front/Back onto these ndls. BO loosely.

TOP YOKE: Make 4—2 with Single Motif (1 reversed) and 2 plain for lining, (1 reversed).

With Col.1 -e- cast on 42 sts. Knit 3 rows. Carr. on the left. Set Fairisle pattern #396 in Compuknit III Pattern Book. (See *Knitting News* notes if you plan to use this existing pattern in your machine, as you will only be using a portion of it for the design of this garment.) Single motif in center. With 2 strds Lumiyarn together in feeder B, continue in Fairisle. After R 90, on the right side (left for 2nd. piece) dec. 1 st. EOR 22 x, 1 st. EVERY ROW 20 x.

Sew Yoke and lining together and join to Front -V-. Make chain stitch design for front V-neck yoke.

Join Shoulder seams.

SLEEVE CUFFS:

K1/P1 Rib: With Col. 2 (2 strds. only for selvedge) and 1 strd. monofil, cast on 67 (73) sts. After regular selvedge change to Col. 1 and Monofil and knit to row 42. Transfer rib sts. to MB. With knit side facing hang open sts. of sleeve Back and Front onto these ndls. decreasing evenly across. BO.

SKIRT: Knit sideways in one piece.

W.Y. cast on 160 (166) sts. After Ravel Cord row, change to Col. 1 and at T 4, knit 6 rows. Bring all ndls. to HP. Set carr. to H and begin short rows. On same side as carriage push back to WP 8 sts. EOR 6 x, then on opposite side of carriage bring to HP 8 sts. EOR 5 x, all ndls. in HP. On same side as carr. push back to WP 58 sts. 2x. Repeat for a total of 36 (38) x ending with 6 rows of st. st. to complete the 12 rows of first pattern.

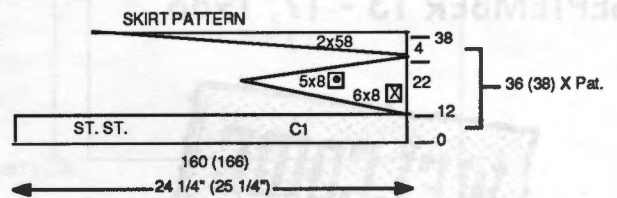
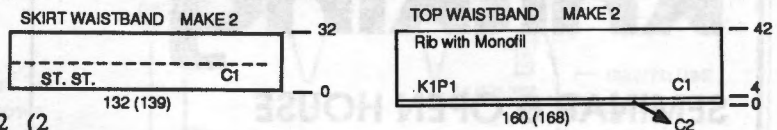
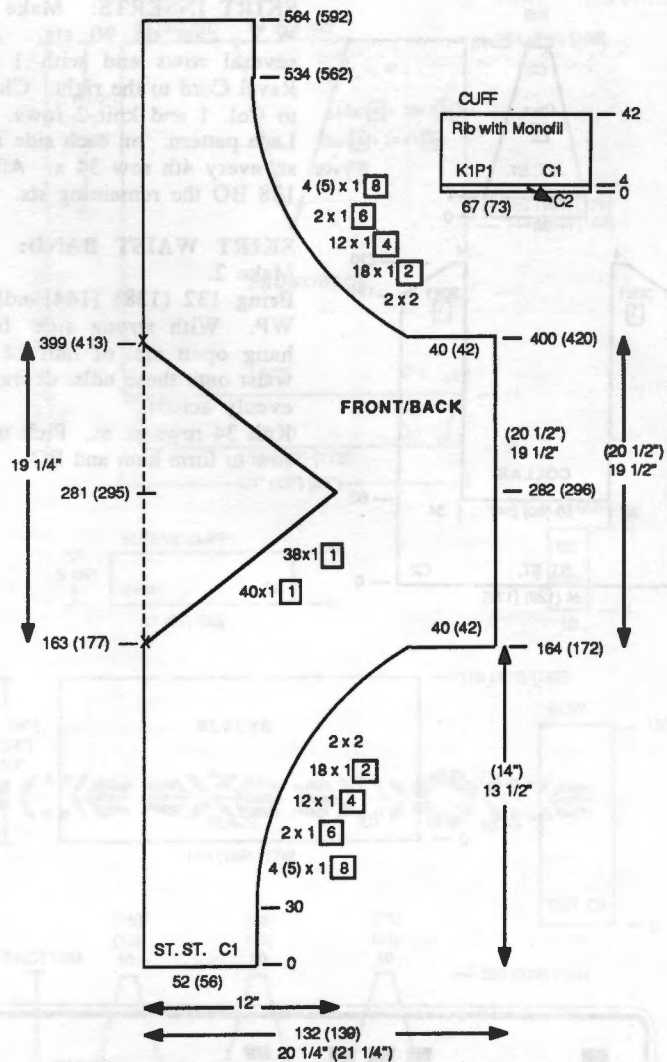

TOP YOKE
MAKE 4 - 2 w/Sngl Motif/ 2 w/o
MAKE 2/REVERSE 2

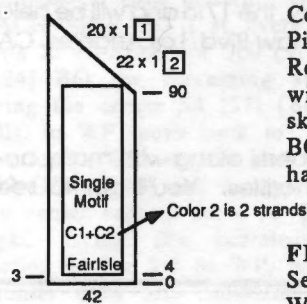

SKIRT WAIST BAND:

Make 2.

W.Y. cast on 132 (139) sts. After Ravel Cord row change to Col. 1 and at T 4 knit 32 rows. Pick up first row to form hem. Remove W.Y. with knit side facing hang 1/2 of skirt waist onto these ndls. and BO. Do the same for the other half.

FINISHING:

See General Instructions. Weave open sts. of skirt together for invisible seam.

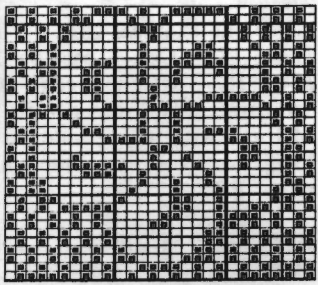

7·0·5



WOMENS 3 PC. OUTFIT

YARN: Roma
 Col. 1 Navy Blue
 Col. 2 White
SIZES: 6/8 (10/12)
AMOUNT:
 Col. 1 23 oz. 24 oz.
 Col. 2 8 oz. 9 oz.
KIT PRICE: \$28.50 \$31.00
TENSION: St. st. T4, FNR 0/0 I
GAUGE: 16.5 sts. 23 rows = 2" (5 Cm)

Make on any Standard or Electronic Machine with Ribber.

JACKET BACK:
 W.Y. cast on 172 (180) sts. After several rows end with 1 row Ravel Cord to the right. Change to Col. 1 and continue in st. st. After R 174 (180) shape shoulders. On each side dec. 1 st. EOR 41 (45) x. then 1 st. EVERY row 12 (10) x. But at the same time after R 258 (270) shape neck opening. BO the center 56 (60) sts. Place the sts. on the left into HP and complete the right side first. On neck edge dec. 1 st. EOR 5 x. Bring the ndls. on the left to WP. Turn counter back and complete to match the right side.

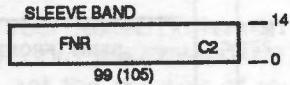
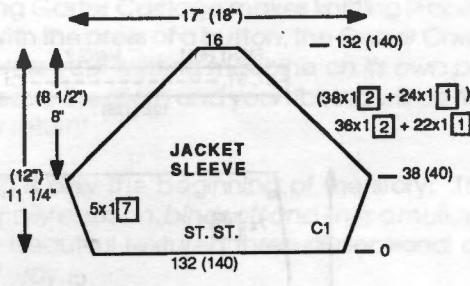
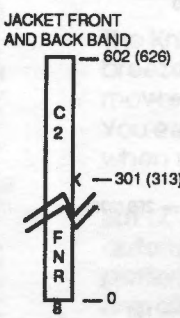
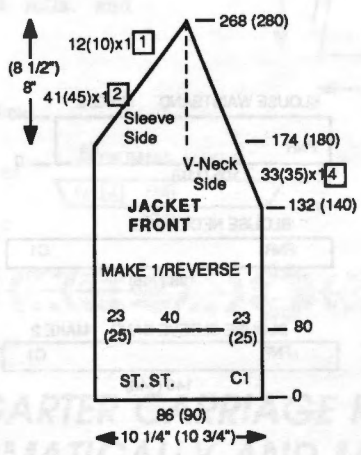
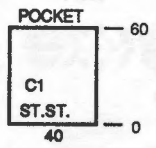
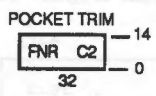
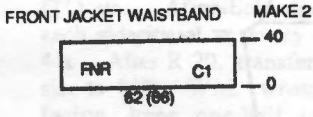
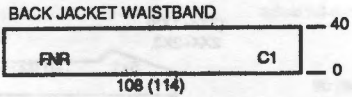
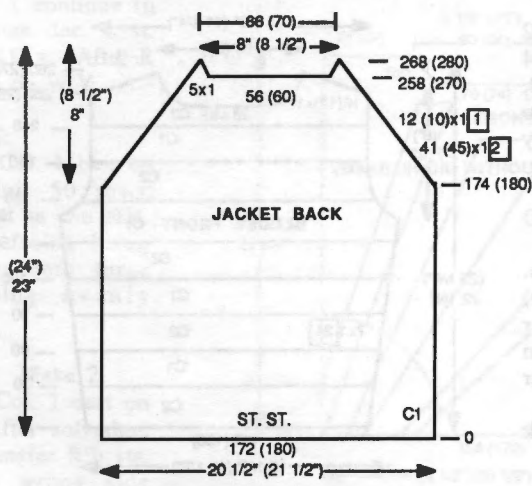

JACKET FRONT: Make 1, Reverse 1.
MAKE POCKETS FIRST: Make 2.
 W.Y. cast on 40 sts. After several rows, end with 1 row Ravel Cord. Change to Col. 1 and knit 160 rows. Remove on contrast W.Y.
 Begin the Jacket Front sections. W.Y. cast on, same as Back, 86 (90) sts. After ravel cord row change to Col. 1 and knit 80 rows. On each side bring 23 (25) sts. to HP. With Right side facing hang the open sts. of one end of the pocket onto the remaining center 40 sts. and remove these 40 sts. on W.Y. Now hang the other end of the pocket back onto the now empty center 40 sts. Hang weights and continue in st. st.
 After R 132 (140) on neck edge dec. 1 st. every 4 rows 33 (35) x. But at the same time after R 174 (180) on sleeve edge dec. 1 st. EOR 41 (45) x.

JACKET BACK WAIST BAND: Make 1.
 FNR: With Col. 1 cast on 108 (114) sts. After regular selvedge knit 40 rows. Transfer ribber sts. to MB. With wrong side facing hang open sts. of back onto these ndls., decreasing evenly across and BO.

JACKET FRONT WAIST BANDS: Make 2.
 FNR: With Col. 1 cast on 62 (66) sts. After selvedge, knit 40 rows. Transfer ribber sts. to MB and with wrong side facing hang open sts. of front onto these ndls., decreasing evenly across and BO.

JACKET SLEEVES:
 W.Y. cast on 132 (140) sts. After Ravel Cord row, change to Col. 1 and continue in st. st. On each side inc. 1 st. every 7th row 5 x. After R 38 (40), on each side dec. 1 st. EOR 36 x, 1 st. every row 22 x. (1 st. EOR 38 x, 1 st every row 24 x.) After R 132 (140) BO the remaining sts.

SLEEVE BANDS:
 FNR: With Col. 2 cast on 99 (105) sts. After selvedge knit 14 rows. Transfer rib sts. to MB and with wrong side facing hang open sts. of sleeve onto these ndls., decreasing evenly across. BO.

(continued next page)

(continued from previous page)

POCKET TRIM:

FNR: With Col. 2 cast on 32 sts. After selvedge knit 14 rows. Transfer rib sts. to MB. Hang open sts. of pocket onto these ndls. decreasing evenly across and BO.

JACKET FRONT AND BACK BAND:

FNR: With Col. 2 cast on 8 sts. After selvedge, knit 301 (313) rows. Place W.Y. marker for center of back. Continue in FNR to R 602 (626) Transfer rib sts. to MB and BO. Attach to Jacket front and back neck opening.

BLOUSE FRONT:

Pattern: 30 rows Col. 2 and 30 rows Col. 1 and repeat (except on shoulder).

W.Y. cast on 142 (150) sts. After Ravel Cord row change to Col. 2 and continue in pattern. ON EACH SIDE inc. 1 st. every 24 rows. 7x.

After R 164 (170) shape armhole. On each side BO 8 (9) sts. 1 x, 4 sts. 2 x, 3 sts. 1 x, 2 sts. 2 x, 1 st. EOR 11 x. After Row 218 (226) shape neck opening. BO the center 28 (30) sts. Place the remaining sts. on the left into HP and complete the right side first. On neck edge dec. 1 st. EOR 16 (17) rows. But at the same time after R 250 (260) shape shoulders. BO or use short row method 4 sts. 2 x, 3 sts. 2 x, (4 sts 3 x, 3 sts. 1 x).

Bring sts. on the left back into WP. Turn counter back to 218 (226) and complete to match the right side.

BLOUSE BACK:

Same as Front to R 250 (260). BO the center 50 (54) sts. Place the remaining sts. on the left into HP and complete the right side first. Shape neck opening and shoulder at the same time. On neck edge dec. 1 st. EOR 5 x. Shape shoulder same as Front.

BLOUSE WAIST BAND:

FNR: With Col. 1 cast on 105 (110) sts. After selvedge, knit 40 rows. Transfer rib sts. to MB and with wrong side facing hang open sts. of Front/Back onto these ndls. decreasing evenly across. BO.

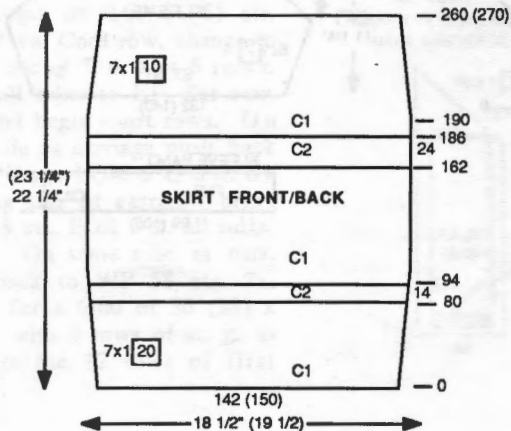
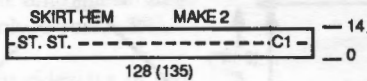
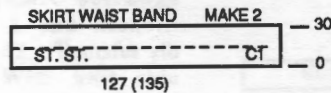
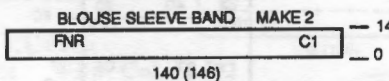
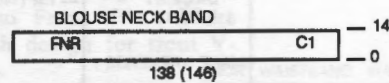
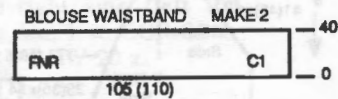
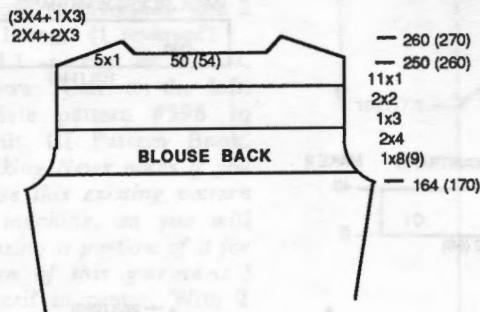
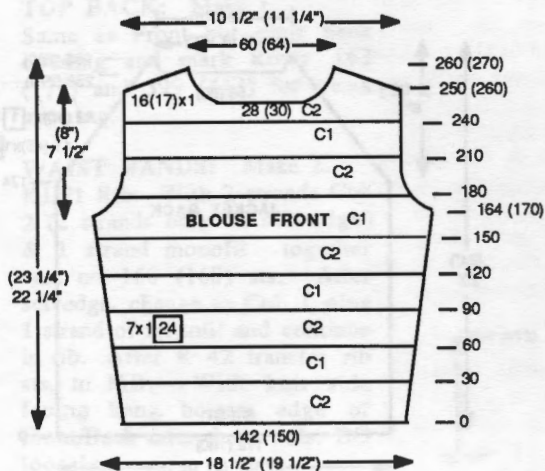

BLOUSE NECK BAND:

Make 1. Close one shoulder first. FNR: With Col. 1 cast on 138 (146) sts. After selvedge knit 14 rows. Transfer rib sts. to MB and with wrong side facing hang neck opening onto these ndls. BO.

BLOUSE SLEEVE BAND:

Make 2. Close second shoulder. FNR: With Col. 1 cast on 140 (146) sts. After selvedge knit 14 rows. Transfer rib sts. to MB and with wrong side facing hang open sts. of sleeve opening onto these ndls. and BO.

SKIRT: Make 2.

W.Y. cast on 142 (150) sts. After Ravel Cord row, change to Col. 1 and continue in st. st. On each side inc. 1 st. every 20 rows 7 x. At the same time, after R 80 change to Col. 2 and knit 14 rows. Change back to Col. 1 and knit to R 162. Change to Col. 2 and knit to R 186. Change to Col. 1 and knit to R 190. On each side Dec. 1 st. every 10 rows 7 x. After R 260 (270) remove on W.Y.

SKIRT WAIST BAND:

Make 2. W.Y. cast on 127 (135) sts. After Ravel Cord row Change to Col. 1 and knit 30 rows. Pick up first row to form hem. With wrong side facing hand open sts. of skirt waist onto these ndls., decreasing evenly across and BO.

SKIRT HEM: Make 2.

W.Y. cast on 128 (135) sts. After Ravel Cord row, change to Col. 1 and knit 14 rows. Pick up first row to form hem and with wrong side facing, hang open sts. of skirt edge onto these ndls.

FINISHING:

See General Instructions.

7·0·6



guide. With Col. 1 continue in st. st. On each side dec. 1 st. every 5 rows 39 (41) x. After R 206 (212) remove on W.Y.

SLEEVE CUFFS:

K1/P1 rib: With Col. 1 cast on 77 (83) sts. Knit 50 rows. Transfer ribber sts. to the MB. With wrong side facing hang open sts. of sleeve onto these needles, decreasing evenly across and BO.

WAIST BANDS: Make 2.

K1/P1 rib: With Col. 1 cast on 153 (161) sts. After selvedge, knit 50 rows. Transfer Rib sts. to MB and with wrong side facing hang open sts. of Front/Back onto these ndls., decreasing evenly across and BO.

NECK BAND: Make 2.

FNR: With Col. 1 cast on 67 (71) sts. After Selvedge, on each side inc. 1 st. every 4 rows 4 x. After R 20. transfer ribber sts. to MB. With wrong side facing, hang one-half of neck opening onto these ndls. and BO.

FINISHING:

See General Instructions.

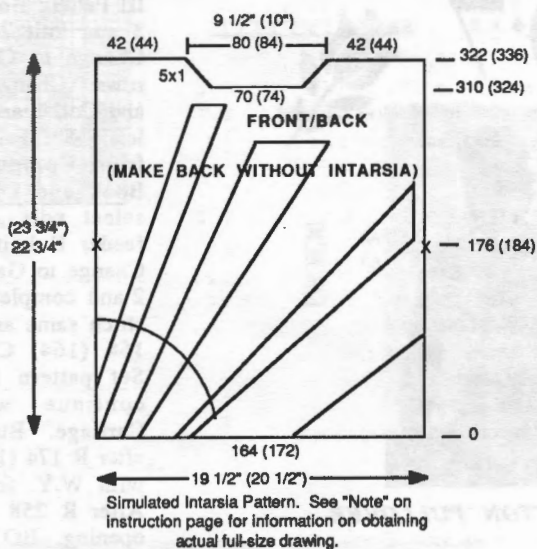

Simulated Intarsia Pattern. See "Note" on instruction page for information on obtaining actual full-size drawing.

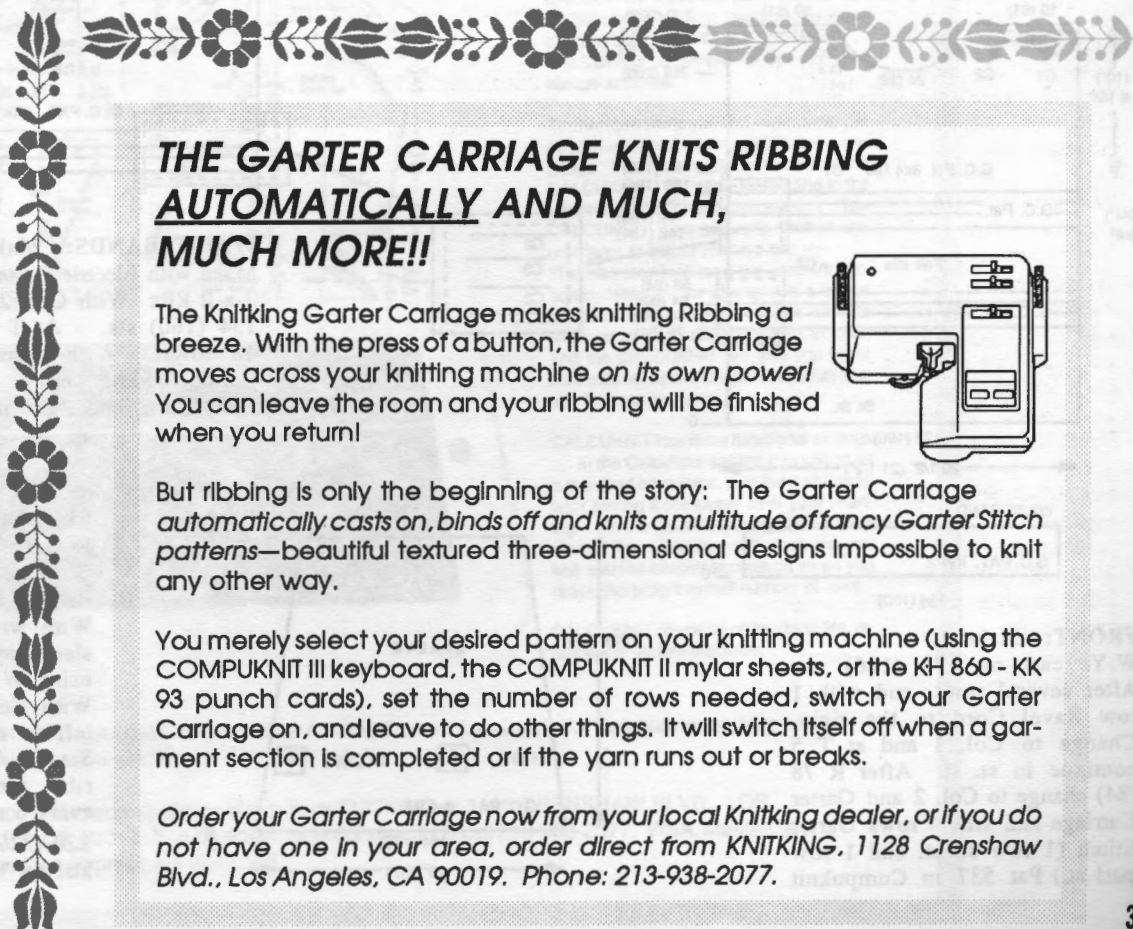
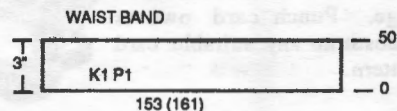
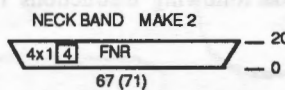
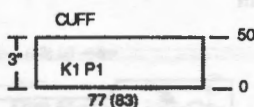
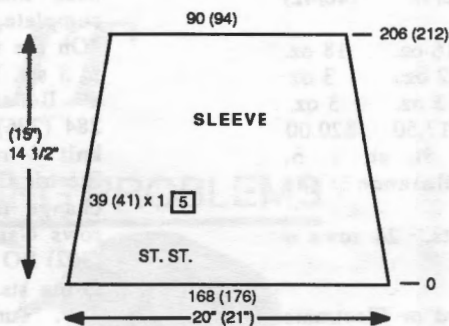

LADIES INTARSIA TOP

YARN: Venetia
SIZES: 8/10 (12/14)

AMOUNT:
Col. 1 Blk 15 oz. 16 oz.
Col. 2 White 4 oz. 4 oz.
Col. 3 Red 4 oz. 4 oz.
Col. 4 Grey 4 oz. 4 oz.
KIT PRICE: \$39.50 \$41.00
TENSION: St. st. T5, Intarsia T 6. FNR 1/1 I, K1/P1 Rib. 0.2/0.2 II
GAUGE: 16.5 sts. 28 rows = 2" (5 Cm)

Make on any Standard or Electronic Machine with Ribber. Pattern is done in Intarsia. We used the new Intarsia Brake. Send \$1.00 and SASE for line drawing.

NOTE: Please make a sample of the Intarsia and also St. st. for stitch gauge. As you can see our sample differed a whole number.

FRONT: Make 1. Intarsia. W.Y. Cast on 164 (172) sts. After several rows, end with 1 row Ravel Cord to the right. Set carr. for Intarsia and continue in pattern. After R 176 (184) mark each side with W.Y. for sleeve. After Row 310 (324) shape neck. In the center BO 70 (74) sts. Place the remaining sts. on the left into HP and complete the right side first. *On neck edge dec. 1 st. EOR 5 x. After R 322 (336) BO or remove on W.Y. Bring sts. on the left back into WP, turn counter back to R 310 (324), and complete to match the right side. Follow Instructions from *.

BACK: Make 1. Same as front, but omit Intarsia Design.

SLEEVES:
Bring 168 (176) sts. into WP. Hang sleeve opening onto these ndls., using W.Y. markers as a

THE GARTER CARRIAGE KNITS RIBBING AUTOMATICALLY AND MUCH, MUCH MORE!!

The KnitKing Garter Carriage makes knitting Ribbing a breeze. With the press of a button, the Garter Carriage moves across your knitting machine on its own power! You can leave the room and your ribbing will be finished when you return!

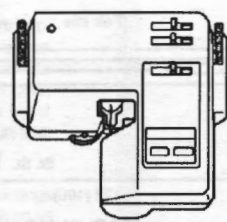

But ribbing is only the beginning of the story: The Garter Carriage automatically casts on, binds off and knits a multitude of fancy Garter Stitch patterns—beautiful textured three-dimensional designs impossible to knit any other way.

You merely select your desired pattern on your knitting machine (using the COMPUKNIT III keyboard, the COMPUKNIT II mylar sheets, or the KH 860 - KK 93 punch cards), set the number of rows needed, switch your Garter Carriage on, and leave to do other things. It will switch itself off when a garment section is completed or if the yarn runs out or breaks.

Order your Garter Carriage now from your local KnitKing dealer, or if you do not have one in your area, order direct from KNITKING, 1128 Crenshaw Blvd., Los Angeles, CA 90019. Phone: 213-938-2077.

7·0·7



MENS KOTTON PULLOVER

YARN: Kotton

SIZES: 36/38 (40/42)

AMOUNT:

Col. 1 Grey 16 oz. 18 oz.

Col. 2 Black 2 oz. 3 oz.

Col. 3 White 3 oz. 3 oz.

KIT PRICE: \$17.50 \$20.00

TENSION: St. st. T 5, Fairisle T 5, Balance see instructions.

GAUGE: 17 sts. 24 rows = 2" (5 Cm)

Make on Standard or Electronic Machine with Electric Garter Carriage. Punch card owners may substitute any suitable card for pattern.

III Pattern Book. Change to Col. 3 and knit 2 rows Garter St. Change to Col. 2 and knit 4 rows. Change to Regular Carr. and Col. 1 and knit 1 row to the left. Set Fairisle Pattern #470 from Compuknit III Pattern Book and knit to the right to select ndls. With Col. 3 in feeder B knit to R 148 (154). Change to Garter Carr. and Col. 2 and complete stripes in Garter stitch same as before. After R 158 (164) Change to Col. 1. Set pattern for 8 x 4 rib and continue with the Garter Carriage. But at the same time, after R 174 (180) mark each side with W.Y. for sleeve opening. After R 258 (266) shape neck opening. BO the center 24 (28) sts. Knit the sts. on the left back into -A- position and complete the right side first. *On the neck edge BO 4 sts. 1 x, 3 sts. 1 x, 2 sts. 2 x, 1 st. 7 x. But at the same time after R 284 (296) Change to Col. 2 and knit 4 rows Garter St. with Electric Carr. After R 288 (300) change to Col. 1 and knit 2 rows Garter st. After R 290 (302) BO or remove on W.Y. Bring sts. on the left back into WP. Turn counter back to 258 (266) and knit to match right side following instructions from *.

BACK: Make 1. Same as back to R280 (292). Shape back neck opening. BO the center 56 (60) sts. Place the remaining sts. on the left into -A- position and complete the right side first. *On neck edge dec. 1 st. EOR 2 x. After R 284 (296) Change to Electric Garter Carr. and Col. 2 and knit 4 rows Garter St. After R 288 (300) BO or remove remaining sts. on W.Y. Bring sts. on the left back into WP. Turn counter back to R 280 (292) and complete to match the right side. Follow instructions from *.

NECKBAND: Make 1. Use 1 strand Kotton plus 1 strd. filament for body.

CLOSE 1 shoulder first.

2 x 2 Rib: Make with the Electric Garter Carr. (Pat. 534 in Compuknit III Pattern Book). With Col. 2, cast on 158 (168) sts. At T 3 knit 6 rows. Change to Col. 1. Knit 2 rows. Change to Col. 2. Knit 2 rows. Change to Col. 1 and knit 2 rows. Change to Col. 2 and knit 26 rows. Pick up first row to form hem. With wrong side facing, hang neck opening onto these ndls. and BO.

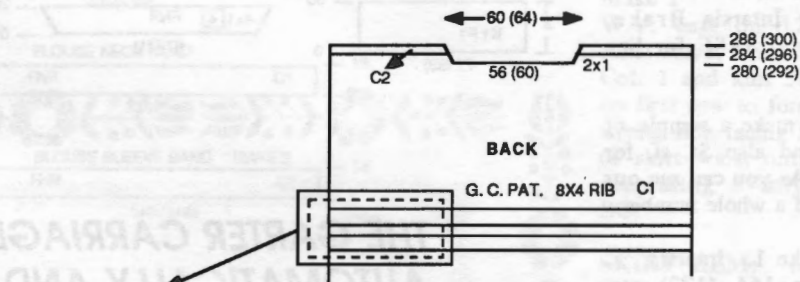
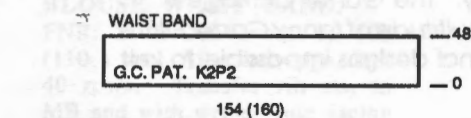
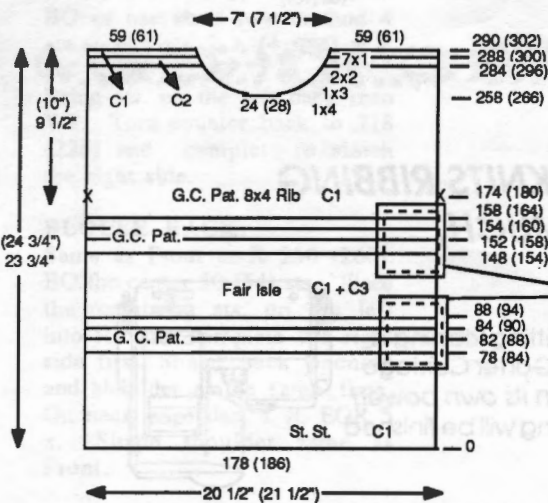

WAIST BANDS: Make 2. Make with Electric Garter Carr. 2 x 2 Rib: With Col. 2 cast on 154 (160) sts. At T 3.1 knit 48 rows. With wrong side facing, hang open sts. of Front/Back onto these ndls. and BO.

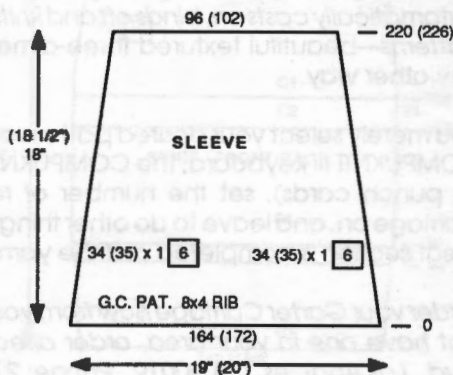

SLEEVES: Make 2 using the Electric Garter Carr. Close second shoulder. Bring 164 (172) ndls. to WP. With wrong side facing, hang sleeve opening onto these ndls., using W.Y. markers as a guide. With Col. 1, knit 1 row from left to right. Counter at -0-. Set 8 x 4 pattern and continue in rib. On each side dec. 1 st. every 6 rows 34 (35) x. After R 220 (226) remove the remaining sts. on W.Y.

FRONT: Make 1. W.Y. cast on 178 (186) sts. After several rows, end with 1 row Ravel Cord to the right. Change to Col. 1 and at T 5 continue in st. st. After R 78 (84) change to Col. 2 and Garter Carriage and knit 4 rows Garter Stitch (1 row st. st. and 1 row purl st.) Pat 537 in Compuknit

**SLEEVE CUFFS:
MAKE WITH ELECTRIC
GARTER CARR.**

2 x 2 Rib: Cast on 62 (68) sts.
At T 3 knit 36 rows. With
wrong side facing hang open
sts. of sleeve onto these ndls.
and BO.

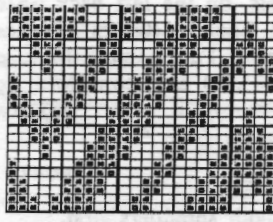
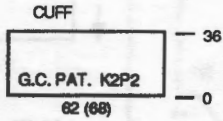

PAT. 470



PAT. 534



PAT. 537

FINISHING:

See General Instructions.
Join side seams and join neck
band.

NECK BAND (w/ Monofil)

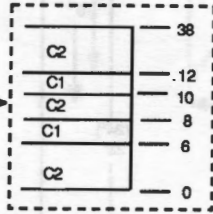
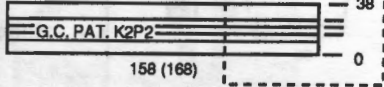

CALCUKNIT

by **knit**king

IT SOLVES ALL YOUR CHARTING PROBLEMS

It's purse size
6 1/2" x 4 1/4" x 3/4"

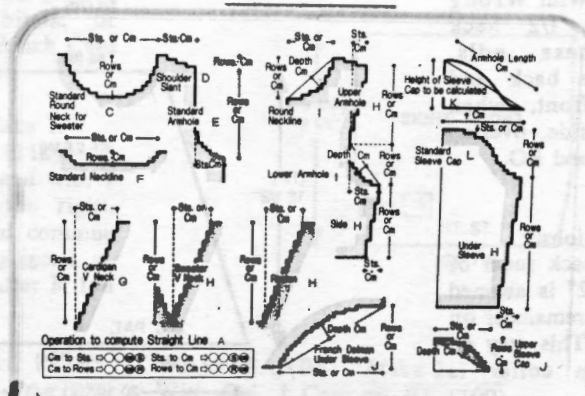

CALCUKNIT takes the time, the tedium, the guesswork and the inaccuracies out of charting both machine and hand knits . . . CALCUKNIT is simple to operate and always accurate.

To chart garments you first make a sample swatch and obtain a correct stitch and row gauge. You then feed them both into the CALCUKNIT . . . Follow by feeding in the garment section measurements . . . The CALCUKNIT then converts your measurements to actual stitches and rows . . . The next step is to feed the garment section by letter (H, for example, is a raglan shape or a V neck). Follow this with the width, in stitches, and the length, in rows, and the CALCUKNIT will give you exact instructions, where to increase, decrease, etc. for your shapings.

CALCUKNIT has three functional settings . . . In the Calculator setting it functions as a standard calculator . . . In the Knit Calculator setting it computes all of your charting . . . In the Counter setting it has a beep alarm: Press a button with each row you knit and the beeper sounds off when you reach the programmed number of rows.

CALCUKNIT operates on two long-life, replaceable lithium batteries.



CALCUKNIT breaks the price barrier for Knitting Computers. It sells for one quarter of the price of our previous low-priced Knit Computer.

Order from your local dealer or direct from KNITKING at 1128 CRENSHAW BLVD., LOS ANGELES, CA 90019. You can order by telephone. Just call 213-938-2077. VISA, MasterCard and American Express are accepted.

7·0·8

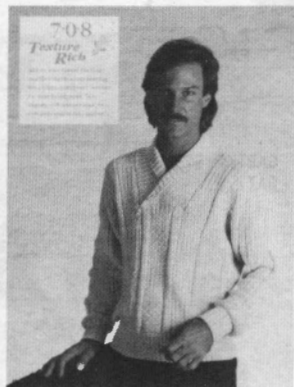

MANS SHAWL COLLAR PULLOVER

YARN: Roma
SIZES: Med. (Large)
AMOUNT: 32 oz. 34 oz.
KIT PRICE: \$39.00 \$41.50
TENSION: T 9 for Garter Stitch Pattern., Collar T 6.1, Waist Bands and Cuffs T 5.
GAUGE: 14 sts. 20 rows = 2" (5 Cm)

Make on any Electronic Machine with Electric Garter Carr.

NOTE: Use 2 strands of Roma together throughout. Except for Waste Yarn knitting, and 1 row on sleeves, entire garment was made using Electric Carr. Pattern is From Stitch World Extras #60.

BACK: Make 1.
 W.Y. cast on 164 (170) sts. After several rows, end with 1 row Ravel Cord to the right. Change to Garment Yarn. Place Garter Carr. on machine and knit 1 row Stockinette Stitch to the left. Program pattern and knit to Row 132 (136). Mark each side with W.Y. for sleeve opening. After R 234 (244) Mark neck opening with W.Y. and BO or remove each section on W.Y.

FRONT: Make 1.
 Same as Back to R 132 (136). Shape Neck opening. BO the center 38 sts. Manually knit to -A- position the remaining sts. on the left. **MARK YOUR PATTERN SO YOU CAN RETURN TO THE CORRECT ROW.**

Complete the right side first. Continue in pattern. *On Neck edge dec. 1 st. every 20 rows. 5 x, (1 st. every 15 rows 7 x) . After R 234 (244). BO or remove on W.Y.

Place sts. on the left back onto the ndl. hooks. Return to place in pattern. Turn counter back to R 132 (136) and complete to match the right side. Follow instructions from *.

SLEEVES:

Close both shoulders first. Bring 148 (154) ndls. to WP. With wrong side facing hang sleeve opening onto these ndls. Bring all ndls. to -E- position. Close hooks and at T 10, with regular carr. knit 1 row to the right. Counter a -0-. Attach Electric Garter Carr. and begin pattern. On each side dec. 1 st. every 5 rows, 33 (34) x. After R 168 (174) remove on W.Y.

WAIST BANDS:

K2/P2 rib: Cast on 154 (160) sts. and knit 40 rows. With wrong side facing hang open sts. of Front/Back onto these ndls. decreasing evenly across. BO.

SLEEVE CUFFS:

K2/P2 rib: Cast on 66 (70) sts. Knit 40 rows. With wrong side facing hang sleeve edge onto these ndls. decreasing evenly across and BO.

COLLAR: Make 2.

Cast on 106 (112) sts. At T 6.1 knit 68 rows. With Wrong side facing hang 1/2 neck opening onto these ndls. (Starting at center back and ending on the front, when seaming the other side, overlap collar on the front) and BO.

FINISHING:

See General Instructions. When closing the back seam of collar. Remember 2" is seamed on one side and the remainder on the opposite side. This way no seam shows when collar is folded.

STITCH = 4 ROW = 1



2 X 2 RIB
 PAT. 534

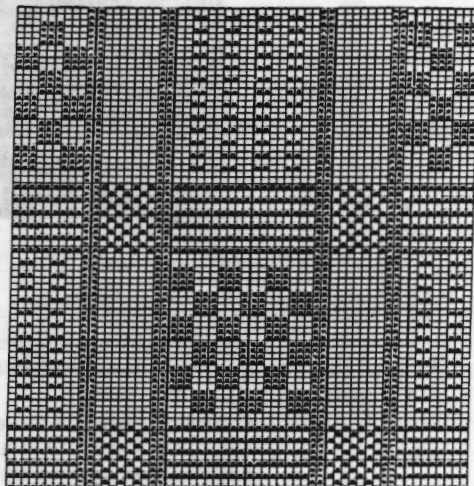
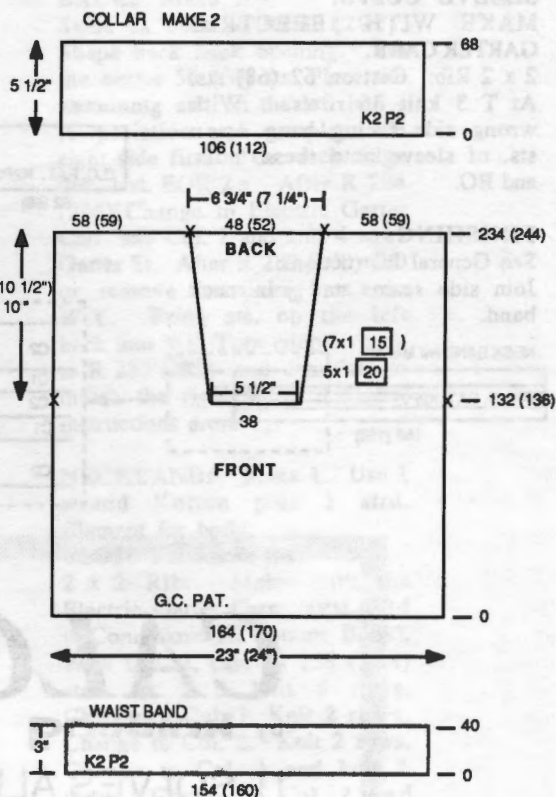



GIRLS SKIRT AND TOP

YARN: Venetia
SIZES: 6/7 (8)
AMOUNT:
 Col.1 Hot Pink 8 oz. 9 oz.
 Col.2 White 8 oz. 9 oz.
KIT PRICE: \$23.50 \$26.00
TENSION: Skirt T3 - Blouse T 5
GAUGE: Skirt - 17 sts. 27 rows = 2" (5 Cm)
 Top - 15 sts. 25 rows = 2" (5 Cm)
NOTIONS: 15 Buttons (Approx 1 Cm)

Make on any Standard or Electronic Machine. Single Motif 'Boat' can be programed for Electronic machines, or punched on card for Punch Card machines.

SKIRT FRONT: Make 1.
 W.Y. cast on 104 (112) sts. After several rows, end with 1 row ravel cord to the right. Change to Col. 1 and continue in st. st. On each side inc. 1 st. every 10 rows 5 x. After R 168 (180) BO.

SKIRT BACK: Make 1.
 Same as Front to R 76 (88). Divide in center and remove the stitches on the left on W.Y. Knit 1 row to the left. -e- cast on 6 sts. on left side and continue in st. st. Knit 2 rows. Make 3 st. buttonhole. Count 2 sts. to the left of '0'. Then begin buttonhole. Knit 12 rows, make buttonhole same as before. Continue until 6 buttonholes are completed. Continue in st. st. After R 168 (180) BO.
 Rehang sts. held on W.Y. back onto machine. Turn counter back to 76 (88) and knit to R 168 (180) (no buttonholes.) BO.

WAISTBANDS: Make 2.
 With Col. 1 Cast on 92 (100) sts. Knit 50 rows. Pick up first row to form hem. With wrong side facing, hang Front/Back skirt waist onto these ndls. decreasing evenly across, and BO.

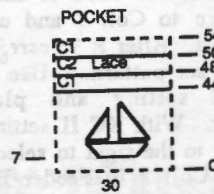
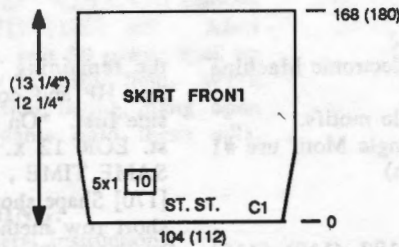
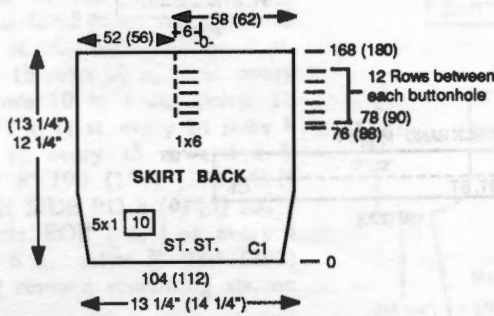
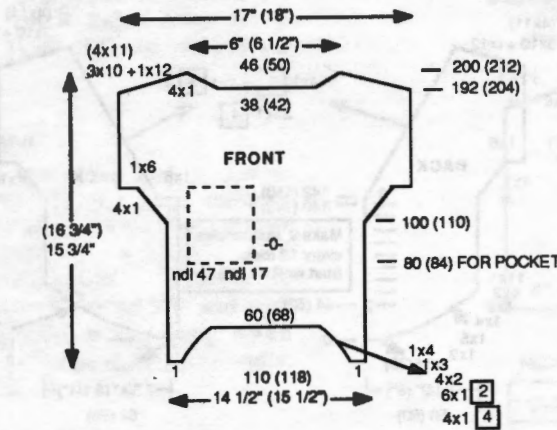
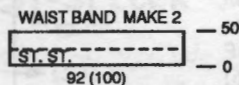

BLOUSE FRONT: Make 1.
 With Col.2, starting at ndl. 55 (59) to the right of -0-. -e- cast on 1 st. Knit 2 rows. On the inside, inc. 1 st. every 4 rows 4 x, 1 st. EOR 6 x, 2 sts. 4 x, 3 sts. 1 x, 4 sts. 1 x. Break yarn. Starting at ndl. 55 (59) to the left of -0-. With Col. 2, -e- cast on 1 st. and complete to match the right side, reversing shaping. With separate piece of yarn -e- cast on over the empty 60 (68) center ndls. Hang cast on comb and weights Row 80 (84). See chart for placement of pocket. See Knitting News for "Special Instructions for Pockets." Knit to R 100 (110) On each side inc. 1 st. EOR 4 x, then cast on 6 st. each side 1 x. Knit to R 192 (204) shape neck opening and shoulder, at the same time. BO the center 38 (42) sts. Place sts. on the left into HP and complete the right side first. *On neck edge dec. 1 st. EOR 4 x. On shoulder BO or use short row method, 10 sts. 3 x, 12 sts. 1 x, (11 sts. 4 x). Bring ndls. on the left back into WP. Turn counter back to R 192 (204) and complete to match the right side following instructions from *.

STITCH = 24

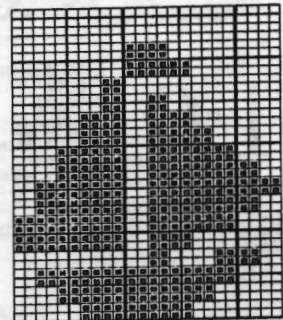

POCKET: Make 1.
 W.Y. cast on 30 sts. After several rows of W.Y. change to Col. 1 and knit 7 rows. Set pattern for Boat. Set KC for Single Motif and knit to the right to select ndls. With Col. 2 in feeder B complete Single Motif. After completion, knit to R 44. At T 8 knit 1 row to the left. Change back to T 5, and knit to row 48. Change to Col. 2 and knit 1 row. Carr. on the left. With transfer tool, transfer every other st. to the adjacent stitch. (every other needle empty). Knit 1 row to the right. Change to Col. 1, and knit 4 rows. Pick up loose tension row. (T8) to form hem, and BO.

(continued from previous page)

BLOUSE BACK: Make 2, Left and Right Sides

Left Side:

W.Y. cast on 56 (60) sts. After several rows, end with 1 row ravel cord to the right. Change to Col. 2 and working from left to right, -e- cast on over these sts. Knit 2 rows. Bring all ndls. to HP. and begin short rows. On same side as carr. push back to WP 16 (20) sts. Knit 2 rows. (Be sure to wrap inside ndl. to prevent holes after 1st row). Then on alternate rows, push back to WP 9 sts. 1 x, 5 sts. 1 x, 4 sts. 1 x, 3 sts. 1 x, 2 sts. 4 x, 1 st. 11 x. Set carr. to NL, knit to R44 (52). Make 3 st. buttonhole (2 stitches in from the edge - see chart). Repeat buttonholes every 12 rows. After R 142 (150), shape sleeve and neck opening at the same time. On armhole edge shape same as Front. On back neck opening dec. 1 st. every 4 rows 24 x, (1 st. every 4 rows 24 x, 1 st. every 3 rows, 2 x. After row 232 (244) shape shoulder, same as Front.

Right Side:

W.Y. cast on 62 (66) sts. After Ravel Cord row, -e- cast on over these sts. with Col. 2, and knit

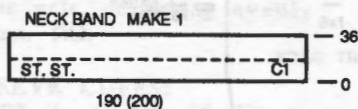
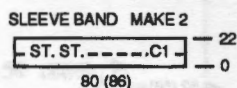
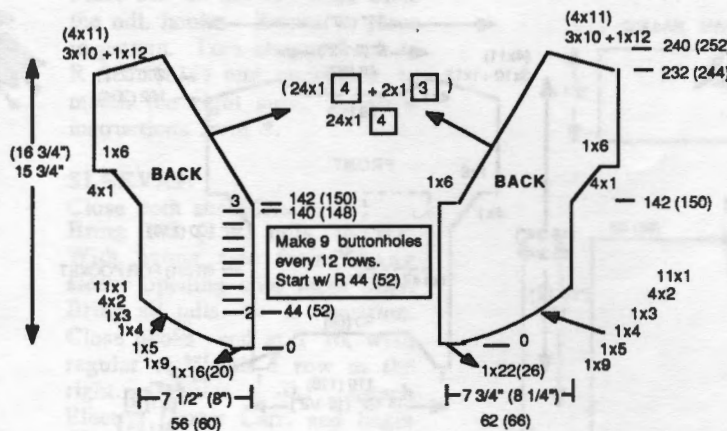

1 row. Carriage on the left and set for short rows. Bring all ndls. in working position to -E- (Holding Position). On same side as carr., push back to WP 22 (26) st. Knit 2 rows. (Wrap inside ndl. after 1st row) then on alternate rows, push back to WP 9 sts. 1 x, 5 sts. 1 x, 4 sts. 1 x, 3 sts. 1 x, 2 sts. 4 x, 1 st. 11 x. Knit to R 141 (149) on left side BO 6 sts. On right side, shape sleeve, same as before. On neck opening, shape same as Left side. After R 232 (244) shape shoulder same as Front.

SLEEVE BAND: Make 2.

Close Both shoulders first. With Col. 1 cast on 80 (86) sts. Knit 22 rows. Pick up first row to form hem. With wrong side facing hang sleeve opening onto these ndls. and BO loosely.

NECK BANDS: Make 1.

With Col. 1, cast on 190 (200) sts. Knit 36 rows. Pick up first row to form hem. With wrong side facing hang neck opening onto these ndls. (Start st lower edge of -V- in back). BO.

FINISHING:

See General Instructions. Sew on Buttons.



7-1-0 

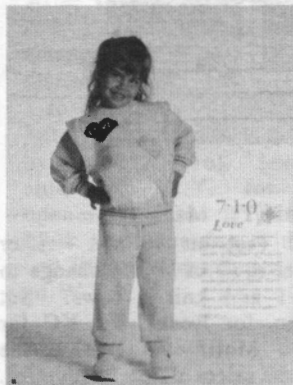

CHILDS HEART PULLOVER AND PANTS

YARN: Amore
SIZES: 3 (4/5) [6/7]
AMOUNT:
 Col. 1 7 balls 8 balls 9 balls
 Col. 2 1 ball 1 ball 1 ball
 Col. 3 1 ball 1 ball 1 ball
 Col. 4 1 ball 1 ball 1 ball
KIT PRICE:
 \$23.50 \$25.50 \$28.00
TENSION: T 5.2 Ribbing T 3.2/3.2 II
GAUGE: 14 sts. 24 rows = 2" (5 Cm)

Make on any Electronic Machine with Ribber. Hearts are single motifs. NOTE: For Single Motif use #1 (Reverse Button)

FRONT:

W.Y. cast on 102 (110) [118] sts. After several rows end with 1 row Ravel Cord to the right. Change to Col. 1 and continue in st. st. After R 9 (carr. on the left) set pattern. Use Single Motif setting and place in center. With KC II setting, knit 1 row to the right to select ndls. With Col. 2 in Feeder B, MC button in, continue in pattern. After completing pattern, cancel pattern and continue in st. st. After R 59 (69) [79] set pattern for second heart. Place on Orange 31 (35) [39], and with Col. 3 in feeder B complete second heart. BUT AT THE SAME TIME after R 74 (80) [86] mark each side with W.Y. for sleeve opening. After R93 (103) [113] Set pattern for 3rd. heart. Place on Green 1 (5) [9] and with Col. 4 in feeder B continue in pattern. After R 128 (138) [148] shape neck. BO the center 16 (18) [20] sts. Place

the remaining sts. on the left into HP and complete the right side first. *On neck edge dec. 1 st. EOR 12 x. BUT AT THE SAME TIME, after R 146 (158) [170] Shape shoulder. BO or use short row method 8 sts. 3 x, 4 sts. 1 x, (9 sts. 2 x, 8 sts. 2x) [9 sts. 3 x, 10 sts. 1 x]. Turn counter back to 128 (138) [148]. Bring ndls on the left into WP and complete to match the right side. Follow Instructions from *.

STITCH = 30 ROW = 30

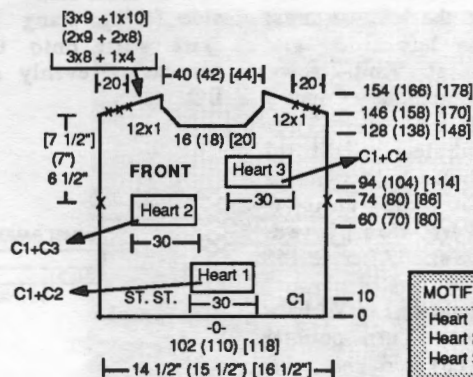
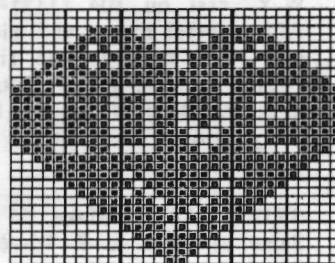

MOTIF NEEDLE POSITION
 Heart 1: In Center
 Heart 2: Yellow 31 (35) [39]
 Heart 3: Green 1 (5) [9]

BACK:

Omit Hearts. Same as front to R 146 (158) [170]. Shape neck opening and shoulder at the same time. BO the center 34 (36) [38] sts. Place remaining sts. on the left into HP and complete the right side first. *On neck edge dec. 1 st. EOR 3x. Shape shoulder same as front. After completion, turn counter back to 146 (158) [170] and complete to match the right side. Follow Instructions from *

WAIST BAND: Make 2.

K1/P1 Rib: With Col. 1 cast on 95 (103) [111] sts. After selvedge, knit 10 rows. Change to Col. 2 and knit 2 rows. Change to Col. 1 and knit 4 rows. Change to Col. 3 and knit 2 rows. Change to Col. 1 and knit 4 rows. Change to Col. 4 and knit 2 rows. Change to Col. 1 and knit 10 rows. Transfer rib sts. to MB and with wrong side facing hang open sts. of Back/Front onto these ndls. decreasing evenly across. BO.

NECK BAND: Make 1.

CLOSE ONE SHOULDER
K1/P1 Rib: With Col. 1 cast on 127 (133) [139] sts. After selvedge knit 30 rows. Pick up first row to form hem. With Wrong side facing hang neck opening onto these ndls. and BO.
CLOSE SECOND SHOULDER.

SLEEVES:

Bring 94 (100) [106] ndls. to WP. With Wrong side facing hang sleeve opening (between W.Y. markers) onto these ndls. Starting at the left, with Col. 1, 'e' cast on over these ndls. Bring all ndls to H.P. Close the latches of the ndls. and continue in st. st. On each side dec 1 st. every 8th R 12x, 1 st. every 9th R 2x, (1 st. every 8th R 15x),

[1 st. every 8th R 14x, 1 st. every 7th R 2x]. After R114 (120) [126] B.O. or remove on W.Y.

CUFFS:

K1/P1 Rib: With Col. 1 cast on 49 (53) [57] sts. After selvedge Knit 10 rows. FOLLOW COLOR CHANGES SAME AS WAISTBANDS. After R 34 transfer rib sts. to MB and with wrong side facing hang open sts. of sleeve onto these ndls. and BO.

PANTS: Make 2.

K1/P1 Rib: With Col. 1 cast on 85 (91) [97] sts. After selvedge, knit 30 rows. Transfer rib sts. to MB. Pick up first row to form hem. and continue in st. st. On each side inc. 1 st. every 16 rows 10 x, (1 st. every 15 rows 10 x, 1 st. every 16 rows 1 x, [1 st. every 14 rows 8 x, 1 st. every 15 rows 4 x]. After R 190 (196) [202] O N EACH SIDE BO 3 (4) [5] sts. 1 x, 2 sts. EOR 1 x, 1 st. every 4 rows 6 x. After R 280 (292) [304] remove remaining sts. on W.Y.

WAIST BAND FOR PANTS:

Make 1.
CLOSE ONE SIDE OF PANTS FIRST.
K1/P1 Rib: With Col. 1 cast on 165 (171) [189] sts. After selvedge, knit 30 rows. Pick up first row to form hem. With Wrong side facing, hang open sts. of pants onto these ndls. BO.

FINISHING:

See General Instructions.

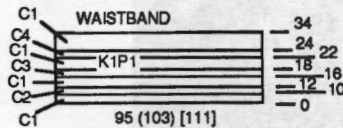

Measurement when Pleats are Folded

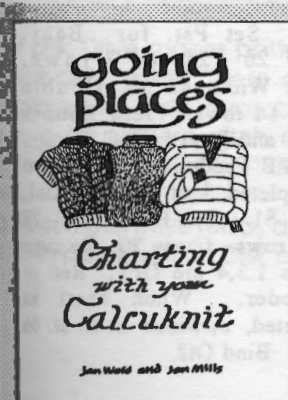
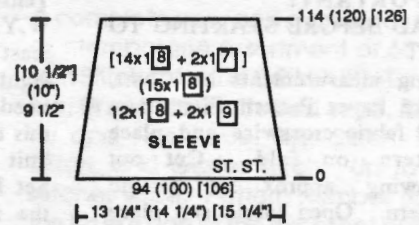
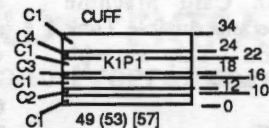
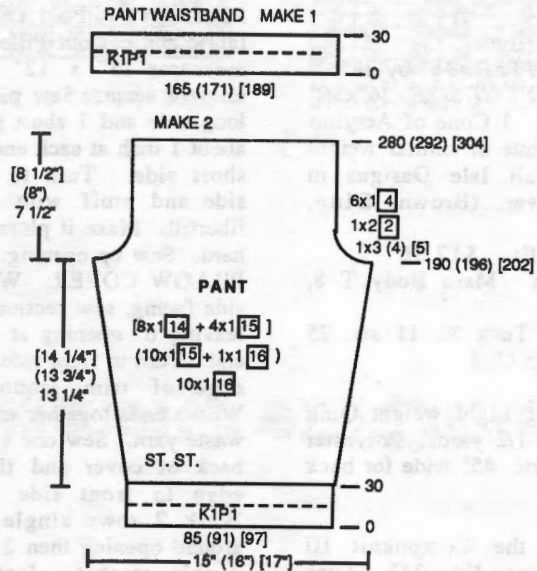
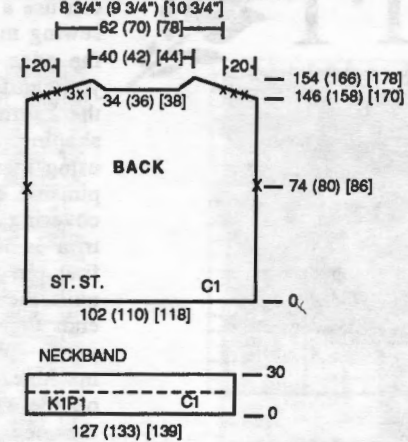

THIS NEWEST CHARTING BOOK IS A "HOW TO" BEST-SELLER ON USING KNITTING'S CALCUKNIT.

Written by Jan Wold and Jan Mills, this book is an excellent in-depth, step-by-step guide for charting pullovers on the Calcuknit. The book details each and every mode (shape) built into the Calcuknit. Upon completion, every reader and Calcuknit user should be an expert!

This great companion for your Calcuknit has become very popular in a short amount of time, so don't get shutout—order your copy today and take advantage of our introductory sale price of \$14.95!

7·1·1

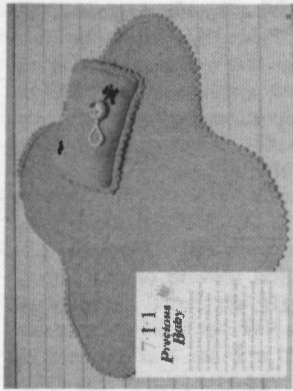

BABY QUILT AND PILLOW

YARN: Acrilyte

SIZE: KNITTED: 36" by 38"

FINISHED CUT SIZE: 36"x36"

AMOUNT: 1 Cone of Acrilyte
Small amounts of similar weight yarn for Fair Isle Designs in Pillow Cover. (Brown, Blue, Red.)

KIT PRICE: \$17.50

TENSION: Main Body T 8, Trim T 6

GAUGE: Tuck St. 11 sts. 25 rows = 2" (5 Cm)

NOTIONS: Light weight Quilt Batting - 1-1/2 yards. Polyester Cotton Fabric 45" wide for back of Quilt.

Made on the CompuKnit III using pattern No. 243 (Tuck Stitch) Punch Card Machine owners can use any suitable Tuck St. Card. Trim - Skip St. with needles out of work.

IMPORTANT: READ BEFORE STARTING TO KNIT

Using measurements on Chart, Make Paper Pattern First, then fold fabric crosswise and place pattern on fold. Cut out allowing approx. 1/4" around pattern. Open fabric and place on batting. Pin and cut all around. Be sure everything is smooth and pin or baste fabric to batting. Sew all around. You can use an overlock or your regular sewing machine with a straight stitch. Put aside and knit the front side of quilt. This will be a straight piece. When you have steamed the knitted sections it should measure at least 36" x 38". Place the sewn fabric and batting on top of wrong side of knitting. (Purl side is right side of knitting). Baste pieces together around edges and tack corner to corner so there will be no slipping.

With overlock machine or you can use a small zig zag stitch on sewing machine) sew all around the edge with quilt side UP so you can follow the shaping. Cut the knitting close to the edge of shaping. Knit the trim and using marked edges as a guide, pin one edge to the fabric side covering the edge seam. The trim is marked in quarters, so first pin to quarter sections of quilt then in between. Weave ends together and remove waste yarn. With straight stitch machine, sew this edge slowly on the very edge of trim, pin, then sew the trim on the knitted side by hand.

PILLOW: Fold remaining fabric and cut out Pillow. Pillow measures 15" x 12" - do not allow a seam. Sew pillow on 1 long side and 1 short side, plus about 1 inch at each end of other short side. Turn to the right side and stuff with Polyester fiberfill. Make it plump but not hard. Sew up opening.

PILLOW COVER: With wrong side facing, sew section together leaving 6" opening at one small end. Turn to right side. Pin one edge of trim around cover. Weave ends together and remove waste yarn. Sew one edge to the back of cover and then other edge to front side by hand. Work 2 rows single crochet around opening then 2 rows half double crochet. Insert pillow and tuck opening inside or you may want to sew some snaps or velcro for closing.

QUILT: Front Section Tension 8
W.Y. cast on 200 sts. Knit at least 2" of waste ending on the right side. (No ravel cord is needed as you are going to cut this off.) Change to main yarn, knit to the left beyond mark. Set Pat. 243 KC I and knit to the right to select needles. Push in both Tuck buttons and continue in pattern. After R 484 remove on contrast waste yarn (at least 2" of waste). Block into 36" x 38" rectangle.

BACK PILLOW COVER: T 8

W.Y. cast on 84 sts. After several rows end with 1 row Ravel Cord to the right. 'e' cast on over the Ravel Cord. Knit 2 rows, setting Pat. 243 on second row, same as for quilt. Knit to R 152. Stop Pat. and knit 2 rows st. st. Bind off loosely.

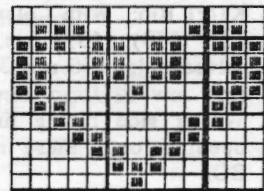
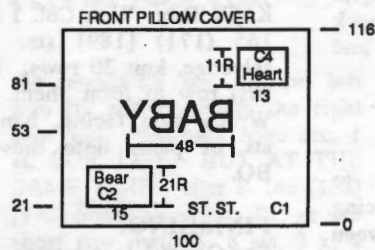
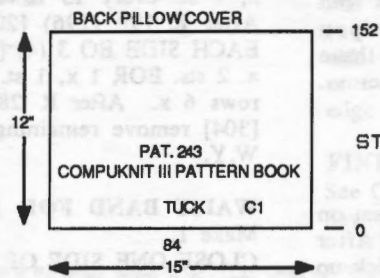
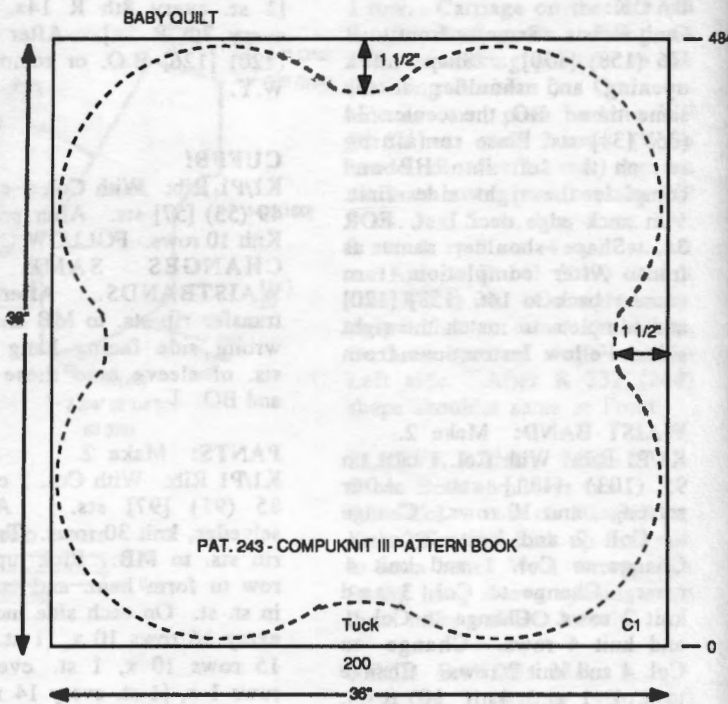

FRONT PILLOW COVER:

Stockinette and isolated Fair Isle.

'e' cast on over waste knitting same as before 100 sts.

Change to Main yarn and knit to R 21. Set Pat. for Bear. Set on Yellow 35 - Single Motif. 15 sts., 21 rows. Brown yarn in B feeder. When Bear is completed, continue in st. st. to R 53. Set Pat. for Baby. Yellow 26 24 sts. 7 rows. Double Width 48 sts. Double Length 14 rows. Press Buttons 1, 3, 4 and Push in MC Button. Blue in B Feeder. When pattern is completed, knit in st. Col. 1 to R 81. Set Heart Pat. 13 sts. 11 rows. Green 20. Be sure Buttons 1,3,4 are OFF. Red in B Feeder. When heart is completed, continue in st. st. to R 116. Bind Off.

QUILT TRIM: NDLS. OUT OF WORK FOR PATTERN. PUNCH CARD MACHINE OWNERS BE SURE TO TURN OFF SELECTION MECHANISM ON UNDERSIDE OF CARRIAGE. 930 Use KC II.

Tension 6
W.Y. cast on over the 15 ndls. in work. After waste knitting, end with 1 row Ravel Cord to the right. Change to main yarn, knit 1 row to the left, Set Pattern, knit to the right. Push in Both Part Buttons and continue in Pattern. Mark each side with W.Y. after rows 664, 1328, 1992. After R 2656, remove on W.Y.

PILLOW COVER TRIM:
Tension 6
Cast on same as quilt trim. Knit same as before and Mark each side after rows 238, 518, 746, knit to R 1026. Remove onto W.Y.

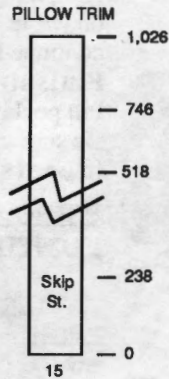
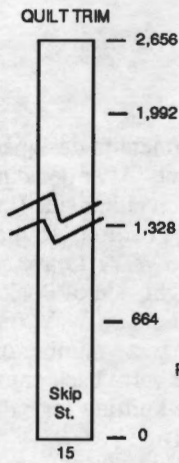

STITCH = 16

ROW = 32

STITCH = 15

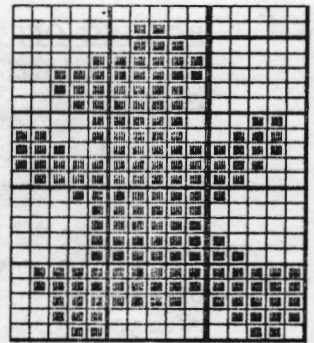
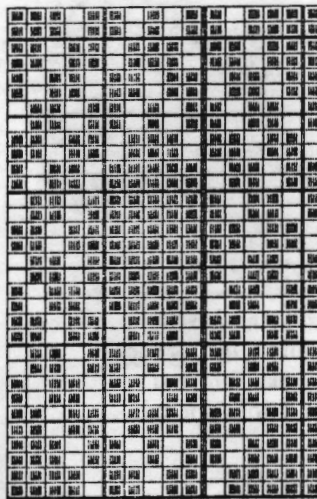

STITCH = 24 ROW = 7

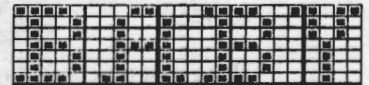

BE SURE TO REVERSE SO SPELLING APPEARS CORRECTLY ON KNIT SIDE

PAT. 243 IN PATTERN BOOK



FDD19

FLOPPY DISK DRIVE FOR COMPUKNIT III



The Floppy Disk Drive makes pattern work unbelievably easy. There are many programmed Disks available, including one for pattern stitch designs from each edition of KNITKING MAGAZINE.

Invest in a Floppy Disk Drive today and start your own pattern stitch Disk collection.

STITCH WORLD EXTRAS Pattern Stitch Book and Programmed Disk



A complete new and marvelous (very contemporary) assortment of 63 Pattern Stitches for the COMPUKNIT III. Fair Isle, Single Motifs, Thread Lace, Regular and Fine Lace, Skip Stitch, Tuck Stitch, and Garter Stitch. Up to 200 stitches wide. Pattern number 667 in this issue is one of the excellent pattern stitch designs illustrated in the Book and programmed onto the Disk.



Order from your local KNITKING DEALER or direct from KNITKING at 1128 Crenshaw Blvd., Los Angeles, CA 90019.



BINDING OFF WHEN YOU HAVE MORE THAN 2 STITCHES ON NEEDLES

A multiple number of stitches on needles can cause some difficulty if you need to bind them off.

Although there are different ways to do this, we like to do it in the following way. After you have all the sections hung onto the needles, knit 1 row by hand, pulling the sts back to -A- position. Be careful to make sure you hold previous stitches back (so it does not pull forward).

Hang cast on comb on the knitting to prevent stitches from popping off as you bring the stitches forward. You will have nice long stitches. Using your latch tool, bind off the crochet method, pulling 1 st. through the stitch on latch tool, across.

HOW TO HANG POCKET

Pattern # 709

First, knit the pocket (see instructions), and set aside.

Be sure to start pocket on waste yarn.

Knit Garment to designated row for pocket placement. After deciding placement, place needles on either side (in this case 30) into Holding Position. Remove the pocket stitches (30) onto W.Y. Leave empty needles in WP. With Right side of Pocket facing, hang open stitches held on W.Y. onto these needles. Now hang the same number of garment stitches (held on waste yarn) back onto these needles, and continue knitting for balance of garment.

Finishing:

Pin pocket to front and weave pocket to garment. Be sure to follow line between stitches for finished straight edge.

USING A PORTION OF AN EXISTING COMPUKNIT III PATTERN

PATTERN #704

Pattern number 396 from Compuknit III Pattern Book can be used, rather than inputing a new pattern as shown. Follow instructions "Knit 3 rows, carr. on the left. Set pattern 396. Use up arrow and advance to row 30. Go past end zone on the left and knit to the right to select ndls. Continue in Fairisle pattern. When you get to row 61 of pattern, your carriage is on the left. Using down arrow, return to row 30 and continue. Repeat for a total of three patterns.



yarns by knitking

The finest quality KNITKING yarns are used to create the beautiful fashions found in KNITKING Magazine. Kit prices are located with the instructions for each garment. Each yarn comes in a wide selection of colors. The different types of yarns have been selected to allow for blending, mixing, and contrasting—both color and texture. Color cards are available through KNITKING or an authorized Knitking dealer.

Content and approximate yardage of each yarn is included in the chart below:

		<i>Yds./Pound</i>
Amore	100 % Acrylic (50 gr. ball)	245 yds/ball
Angora	100% Rabbit Hair (10 gr. ball)	33 yds/ball
Acrylite	2/12 Acrylic	2400
Bulkytime	100% Bulky Orlon with slubs	1500
Glace	100% Slinky Bright Rayon	2400
Ice Cream	54% Cotton/46% Rayon	2100
Kotton	100% Cotton	2200
Lumiyarn	Thin Metallic Yarn (50 gr. cone)	1200/cone
Nordic	100% Australian Wool	1650
Pearlyte	100% Rayon Boucle	2200
Pebble	Boucle Cotton/Acrylic/Rayon	700
Primo	100% Mercerized Cotton	2500
Roma	80% Acrilan/20% Antron	2600
Silkie	2-Ply Orlon	2100
Starlite	Acrylic w/Metallic Thread	2400
Venetia	70% Wool/30% Rayon	2400

Complete Set
of
Color Cards:
Only \$12.00



7·0·3

Ship Aboy!

A perennial favorite is a two piece Lace Dress with a snow White Sailor Collar. The Skirt has separate inserts sewn in place to form a soft flair. Knit it on any Standard Punch Card machine with Lace Carriage or an Electronic machine. Venetia for the yarn.



 7·0·4
Captivating

A super two piece Dress you'll love wearing. The Skirt is knitted sideways and has a soft flair at lower edge. A Fair Isle Flower Design accents the Yoke on the pretty Pullover. Rib the sleeve and waistband. Knit this perfection with our Pearlyte and Lumiyarn.



7·0·5 ..:
**Fashion
Savy** 

A three piece wardrobe catches the eye with its bold stripings. A sleeveless Shell pairs up with a straight skirt. The short sleeve Jacket boasts wide contrast color bands. Knit it on any standard machine with our lovely Roma.

7·0·6

Glorious Intarsia

Such fun to knit and a delight to wear. (If you own an Intarsia Brake, you'll find it a breeze to knit). It's a designers Pullover that is a modern art triumph. The bands are ribbed and the yarn is Venetia.





7·0·7

Charm Your Man

and knit him this outstanding Pullover in his favorite colors. You can knit it on an Electronic or Standard machine using your Garter Carriage for the ribbings. The fair Isle Design is outlined with narrow stripes. Kotton is the yarn.



7·0·8

**Texture
Rich**



*Talk to your Garter Carriage
and let it turtle along knitting
this exclusive designers' sweater
for your loving man. Two
strands of Roma are used for a
rich and outstanding texture.*

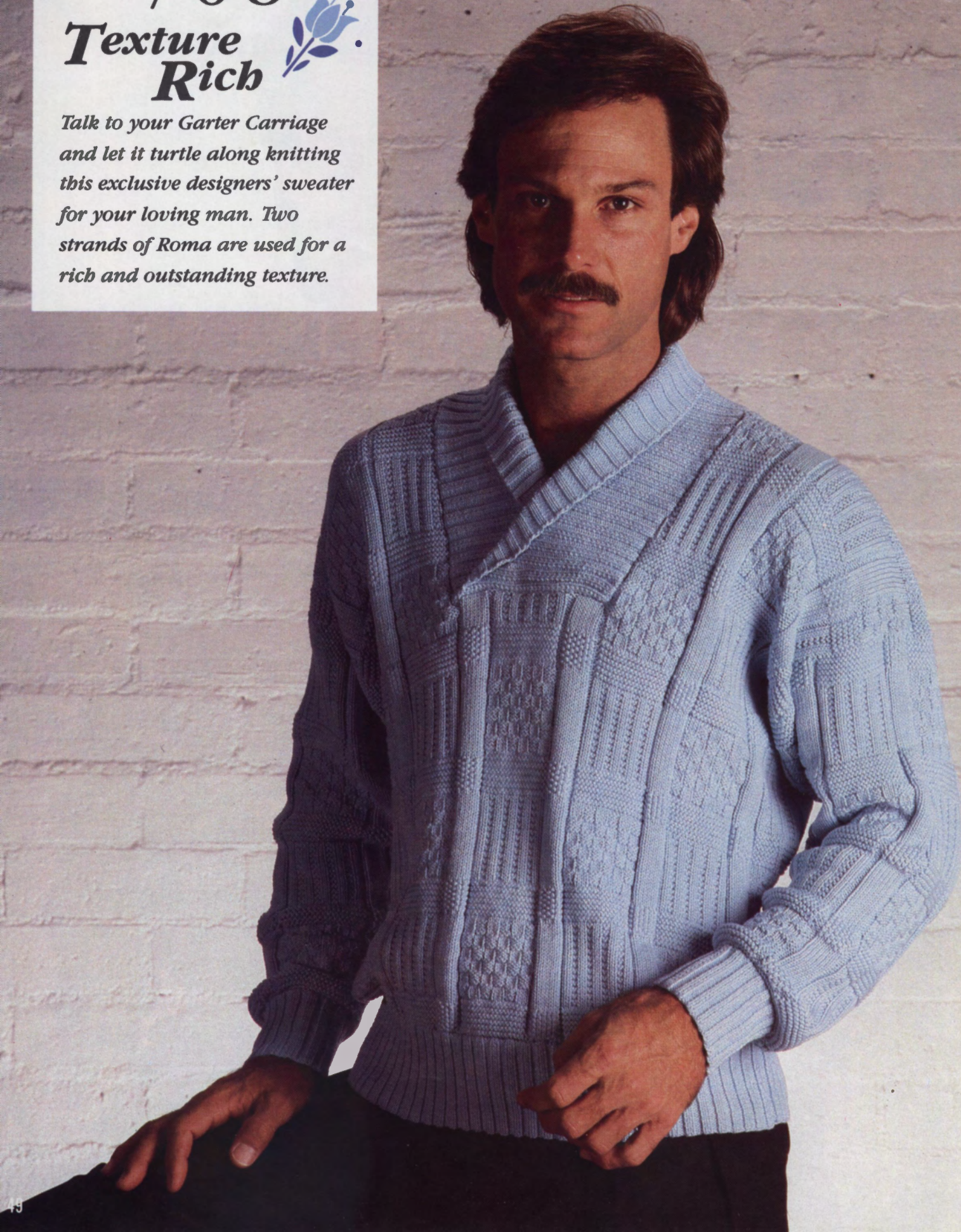

7·0·9

Brighten Her Day

and keep her deliriously happy in a Skirt and Top she'll adore wearing. It's easy to knit in Stockinette stitch. Take note of the special shaping of the Top - up in front and down in back. A boat pocket is on the front and a row of buttons march down below the back neck shaping. It's knitted with Venetia.





7·1·0

Love

and more love for toddler's Sweatsuit. The single heart motifs on the front of Pullover are in different colors. Repeat the color with stripes for the waist and sleeve bands. Form pleats at shoulder and tack in place. Knit it with our Amore that can be tossed in washer and dryer.

WAY TO GO . . .

knitking

Are you satisfied with nothing but the finest, most versatile and yet easy to use home knitting machine equipment? Then read on and be amazed . . .



"I bet you never saw a computer that looked like me before!! The folks at KNITKING call me KC III . . . You can call me "Casey". I have an affinity for (truth is I'm crazy about them) color Television sets, Disk Drives and Compuknit III knitting machines . . . Put us all together, manipulate our controls and I promise oodles of creative fun that will make you and your family the best dressed people on your block . . .

Hook me up (one plug only) to your color T.V. set and I will project a grid onto its screen. Also projected will be one cursor, the size of one rectangle in the grid . . . With the controls on my right-side you can move that cursor anywhere you wish

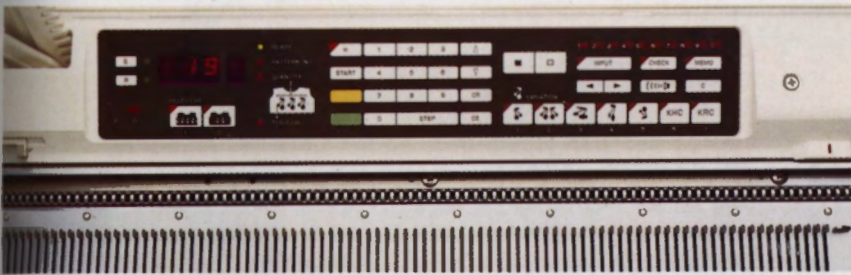

The Compuknit III has the capacity to store designs with a total number of 13,600 stitches . . . The total can be made up with a number of small designs or one very large one . . . I just know however that our creative juices will not allow us to stay there, even though it is possible to remove and replace any one design at random . . . Once we have created something together we will not want to let it go . . . and that is where my friend the Disk Drive comes in . . . Plug me into a Knitking Disk Drive and all of our design masterpieces can be transferred to a Disk for recall

to create any design your clever heart desires . . . My cursor moves accurately from rectangle to rectangle (each one represents a stitch) filling them in or leaving them blank at your command . . . When you have your design completed you can fill in the colors of your choice (with the controls on my left side). Any errors you make as you go along can easily be corrected . . . The 555 designs programmed into the Compuknit III knitter are also a part of my repertoire . . . You can project any one (or several) on to your T.V. screen and alter its form, remove or add parts, isolate sections, join several designs together and generally create unique designs that will please you and astound your friends.

I have an outlet that connects directly with a Compuknit III knitter . . . Hook me up and you can go ahead and knit your masterpiece, just as you viewed it on your T.V. screen . . . Now isn't that something?



at any time into the Compuknit III . . . Every design has its own number and you recall it just by pushing that number on your Compuknit III . . . Every Disk has 40 tracks and each track accomodates 13,600 stitches . . . One Disk actually has 40 times the capacity of the Compuknit III . . . and you can build a library of Disks.

And that's not all!! I have another friend with whom I am compatible (a special hook up cable is needed). Connect me to a Dot Matrix printer and we will print out actual designs created by you on your T.V. screen. This will give you ready pictorial reference to all the beautiful patterns we dreamed up and stored on Disks . . . Exciting?"

"If you would like a hands-on demonstration, or have any questions, get in touch with your local Knitking dealer or, if you do not have one in your area, call KNITKING at 213-938-2077 and ask for 'Casey'. I am at your service . . . KNITKING and its dealers will also tell you my current special price and that of my friends . . . Mastercard, Visa and American Express are accepted."

7.1.1

Precious Baby



quilt is shaped like a four leaf clover. Lucky is the baby smuggled in soft luxury. The Pillow has isolated Fair Isle designs. It's a cut and sew project that is a new innovation. Knit it in a Tuck stitch pattern. The scalloped trim in a skip stitch has needles out of work and you sew it around all edges of Quilt and Pillow Cover. Acryllite is the yarn.



Simple Seven by **knitking**

THE IDEAL KNITTING MACHINE FOR BEGINNERS . . .

Complete with well-illustrated, easy-to-follow, 60 page Instruction Manual. One hour V.H.S. video tape of lessons including step-by-step instructions for knitting three sweaters . . . The shipping carton doubles as a carrying case.

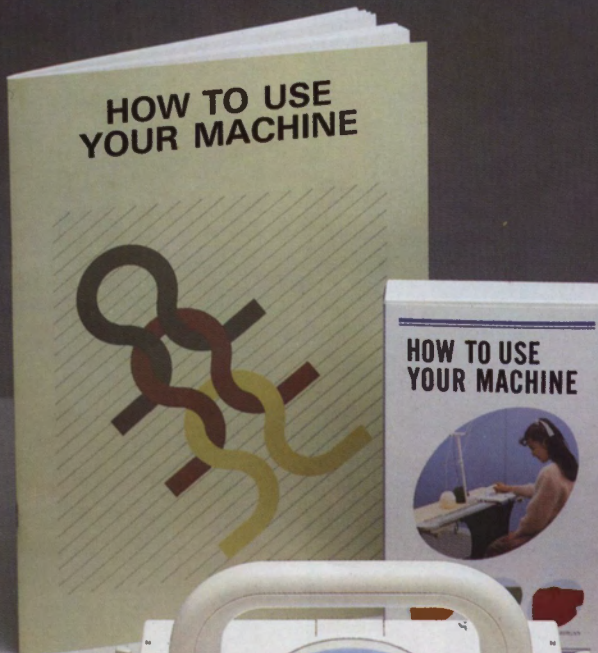

Has Twin Yarn Feeders for two color designs . . . The tool kit includes special Cable Tools, Needle Pushers for fancy stitch selection, Row Counter for accurate row count, Silicone oil for lubrication, etc. etc.

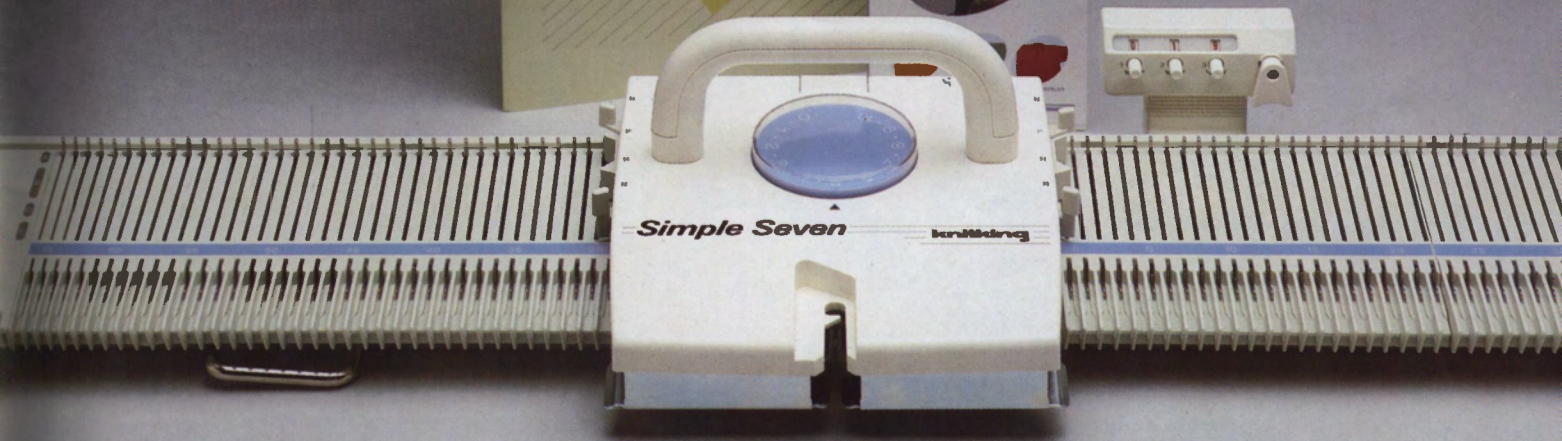

Home knitting machines generally come in two classifications: Standard—for knitting yarns from single ply to sport weight—Bulky for knitting yarns from sport weight to bulky . . . Standard machines have a space between needles of 4.5 millimeters. Bulky machines have a space of 9.00 millimeters . . . In order to knit a range of yarns from dress weight to bulky it was always necessary to own two machines. Simple Seven has a needle space of 7.00 millimeters and it knits dress yarns and bulky yarns with equal ease.

Simple Seven has 132 needles. If you knit four ply worsted at four stitches per inch, you can knit up to 33 inches wide . . . In addition to knitting clothes you can knit afghans, throw rugs, bed spreads, table clothes, etc . . . The instruction manual teaches you how to knit Skip Stitch Patterns, Lace Patterns, Tuck Stitch Patterns (popcorn stitch, etc), Knit and Purl Stitch Patterns, Cable Stitch Patterns and much much more . . . Simple Seven has great versatility for its low low price.

Order from your local Knitking dealer, or if you do not have one in your area, direct from KNITKING. Phone 213-938-2077. VISA, MasterCard and American Express are accepted.



KNITKING 1128 Crenshaw Boulevard, Los Angeles, California 90019

KnitKING

• • PUNCH CARD PROGRAMMED BULKY • •

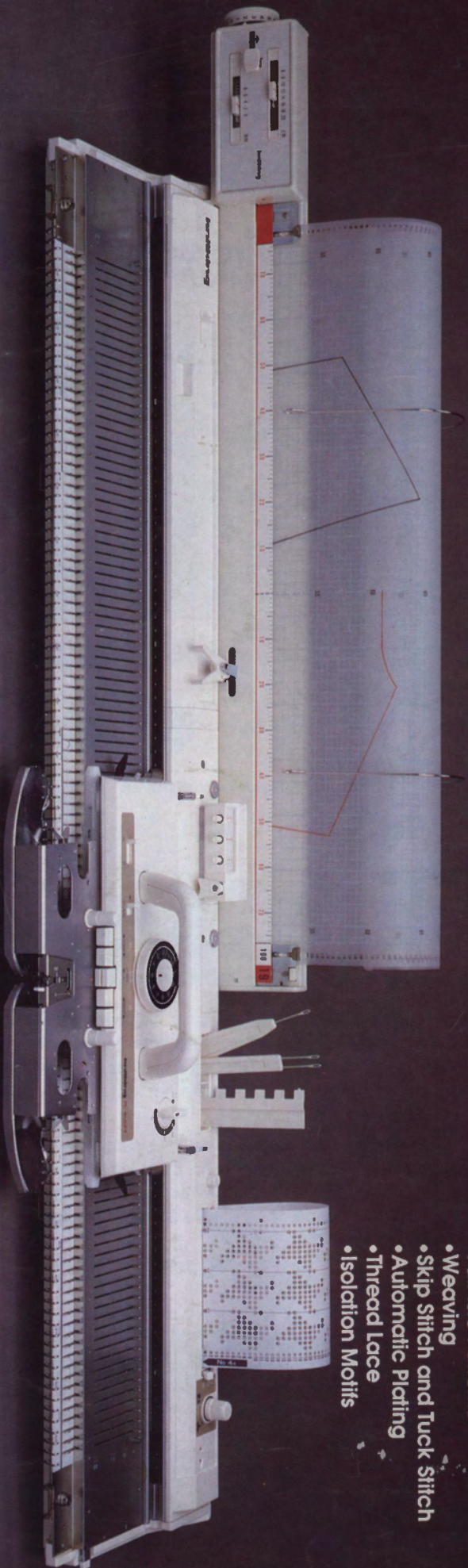

Accepts standard 24 stitch Punch Cards for:

- Fair Isle Patterns
- Weaving
- Skip Stitch and Tuck Stitch
- Automatic Platting
- Thread Lace
- Isolation Motifs

The KNITKING P.C.B. is easily the most versatile of all Bulky knitting machines. It's the first with automatic 24 stitch repeat PUNCH CARD PATTERN selection and it knits a range of yarns from sport weight to jumbo, including Angora, Mohair, Boucle, Ribbon, Cotton, Acrylic, etc. The KNITKING P.C.B. has 114 stainless steel needles in a needle bed 40" wide. At 3 stitches per inch, it knits up to 38" wide. The Tension Control Dial has 30 tensions for knitting different weights of yarn... Comes complete with TWIN OVERHEAD FEEDERS, 15 PRE-PUNCHED CARDS, (you can also make your own pattern stitch cards), ROW COUNTER, complete TOOL KIT, STITCH MEASURE SCALES for KNITLEADER, CARRYING CASE, a detailed, well illustrated, easy to understand INSTRUCTION MANUAL and a one year warranty on parts and service.

The KNITLEADER 16 (KL-16) is a charting accessory that locates on the back of the knitter. You draw, or trace a garment, full size, on a Mylar sheet that is furnished with the KNITLEADER. The chart rotates as you are knitting and shows you, on a row by row basis, exactly where to increase and decrease. A wide range of pre-drawn KNITLEADER patterns is available from your KNITKING dealer or direct from KNITKING.

Order from your local Dealer or direct from:
KNITKING CORPORATION, 1128 Crenshaw Blvd.

Los Angeles, CA 90019 Telephone: (213) 938-2077

