

PASSAP®

INTERNATIONAL

PASSAP®

CREATION 6





5924
Design
Kathe Keck
USA

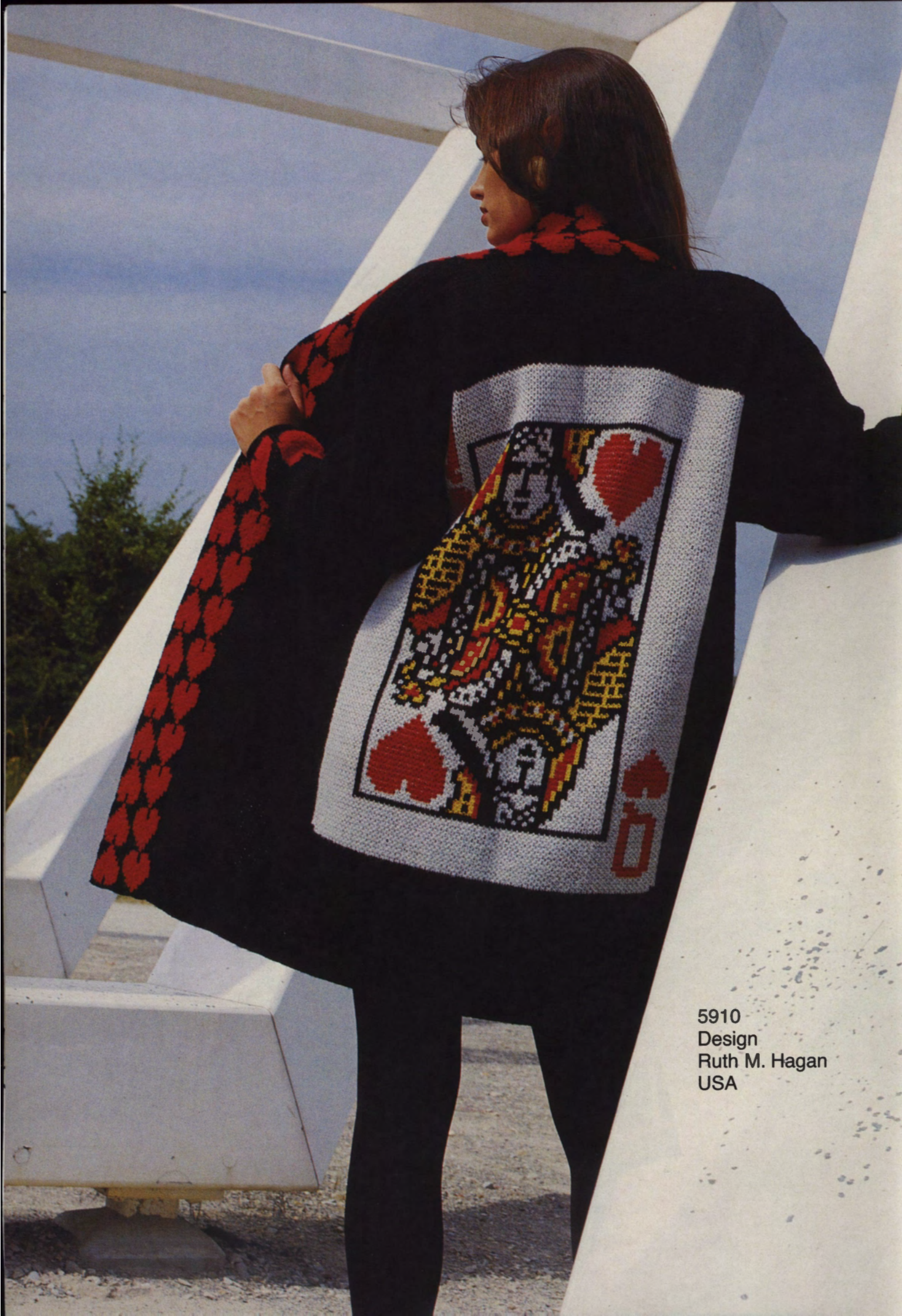

5910
Design
Ruth M. Hagan
USA

5911
Design
Ruth M. Hagan
USA

5912





5933

58
59
59



5904

5903



5902
5901



5908

Modelle
Lana Chic
Rapperswil-Jona

5927

592
592





5935
Design
Kathe Keck
USA

5916
Design
Ruth M. Hagan
USA



5918



5917
Design
Fern Wayne
USA





5914
Modell
Y. Wassmer
Arboldswil

5937

5913
Design
Rita Ehrhart
USA

5915





5934

5931

5932
Modell
Y. Wassmer
Arboldswil



Modelle
T. Roganova
Russia

5922
5923

5907



Modelle
T. Roganova
Russia

5919
5909

5920
5921





5928

Design
Sharon Nani
USA



5940
5941
5936



PICTO
Intarsienschloss

PICTO
Chariot intarsia

PICTO
Intarsia lock

Sonderzubehör
Accessoire spécial

Optional extra
Accesorio especial

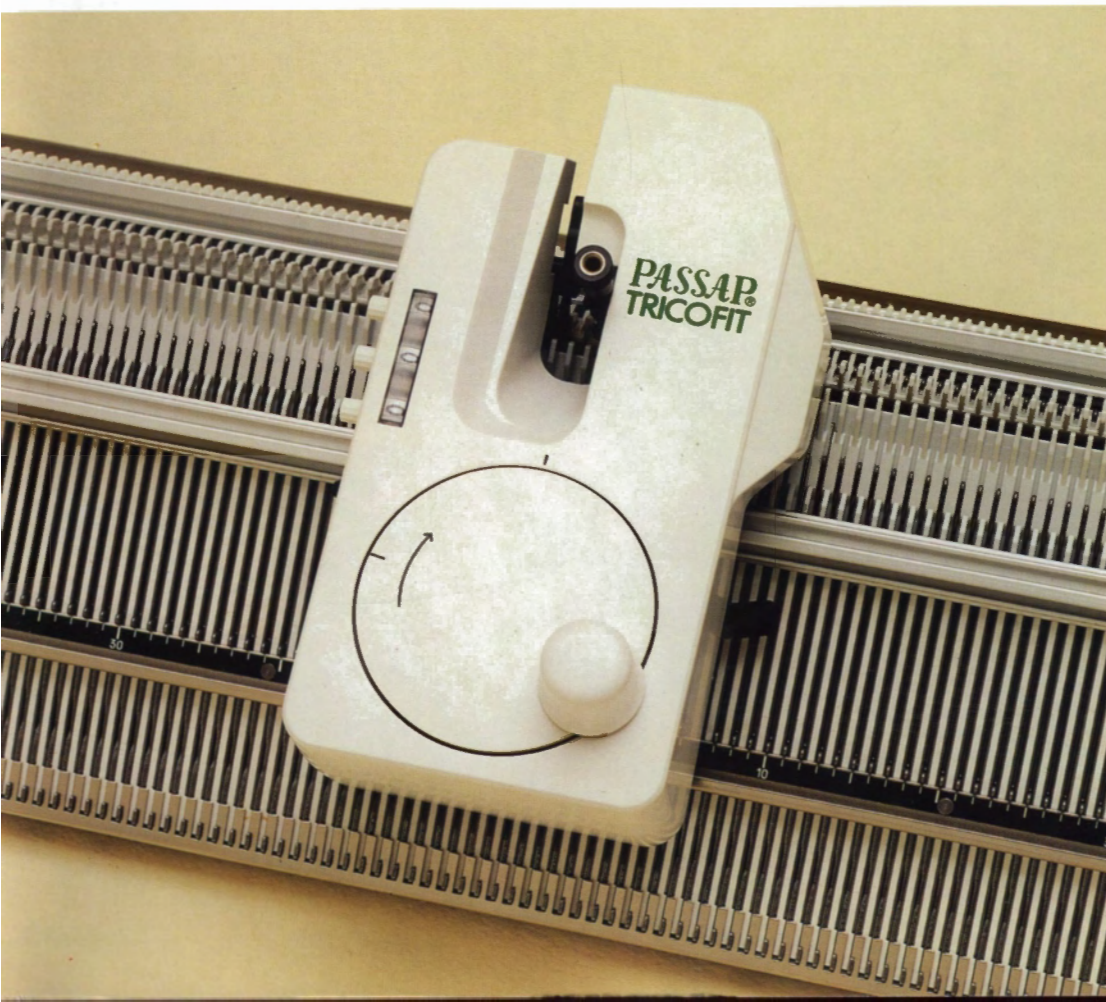

TRICOFIT
Abkettelgerät

TRICOFIT
pour arrêter les mailles

TRICOFIT
Casting off device



MADAG
8953 Dietikon
Schweiz

duomatic 80

duomatic S

ELECTRONIC 6000

Description Book for Model Book 59

<u>Front cover</u>			
5902 FC Lady's 3 col Fair Isle jacket	10	5917 FC Lady's 3 col Fairisle jacket	42
5900 FC Top	8	5918 FC Lady's 4 col Fairisle pullover	44
		5919 FC Child's pullover with cats	46
<u>Back cover</u>		5920 FC Child's jacket	18
5931 FC Lady's pullover	72	5921 FC Girl's skirt for 5920	19
		5922 FC Child's pullover 'Harlequin' PICTO	55
5900 FC Top	8	5923 FC Skirt to match 5823	37
5901 FC Fairisle top	8	5924 FC Lady's jacket with flowers	48
5902 FC Lady's 3 col Fairisle jacket	10	5925 FC Sleeveless dress	54
5903 FC Lady's 4 col Fairisle sweater	12	5926 FC Lady's cocktail jacket	53
5904 FC Linnen summer dress	5	5927 FC Lady's waistcoat	80
5905 FC Lady's pullover	7	5928 Baby overall with rabbit	57
5906 FC Lady's waistcoat	61	5929 FC Baby set	58
5907 FC Child's dress	20	5930 FC Baby's pullover with lacy pattern	71
5908 FC Child's 4 col Fairisle pullover	16	5931 FC Lady's pullover	72
5909 FC Child's trousers	45	5932 FC Men's pullover with scarf	62
5910 FC Lady's jacket Queen of Hearts CREATION 6	34	5933 FC Lady's pullover linen	64
5911 FC Lady's 2 col Fairisle jacket CREATION 6	22	5934 FC Men's 4 col Fairisle pullover	75
5912 FC Men's pullover	30	5935 FC Lady's jacket with butterflies	66
5913 FC Lady's jacket 'Red Indian'	24	5936 FC Leggings	79
5914 FC Men's pullover tuck stitch pattern	28	5937 Tie 'Ethno'	29
5915 FC Lady's 4 col Fairisle pullover	38	5940 FC Top and headband	77
5916 FC Lady's jacket 'tropical fish'	31	5941 FC Ladies jacket with bubble fairisle	78
		5942 Shawl summer Fairisle	65

CREATION 6

Creat your own patterns on your Persnal Computer.

Look at the pattern on the screen first, rotate it, enlarge or reduce it, play and have fun with the colour combinations until you are satisfied that this is going to be your dream sweater.

Would you like to know the actual size of your design when knitted? Simply enter your test square measurements into the the computer - it will tell you straight away. Too small or too large? Enlarge or reduce the pattern to the exact centimetres.

When you are ready, transfer your pattern to the ELECTRONIC 6000, the computer is now free again for other uses.

All this is possible on a fully IBM compatible Personal Computer.

Please ask your dealer for a list of the exact requirements for the use of CREATION 6.

Demands on the system

To run CREATION 6000 you need the following:

A Personal Computer 100% IBM compatible (PC, XT, AT, PS/2 (MS-DOS))

A Hard Disk

A 5.25" Floppy Disk Drive (360 KB) or

A 3.5" Floppy Disk Drive (720 KB)

Workspace with a minimum of 640 KB

Operation system MS-DOS version 3.0 or above

Colour screen CGA or VGA

MICROSOFT-compatible mouse, including driver already installed

1 serial port free for connection to ELECTRONIC 6000.

CREATION 6 - SELECTION 2

NEW : a second pattern collection for CREATION 6000 on disk

As the pattern SLECTION 1 has proved so popular, we offer you a second colletion in which contains most designs of Model Books 56 to 58 .

Naturally the collection SELECTION 1 will continue to be available so that you can start a basic collection to which you can go adding designs.

Ask your dealer for the software SELECTION 1 and SELECTION 2.

Whilst every care is taken to ensure the accuracy of the patterns, charts, diagrams, etc. published in the Model Book, MADAG and their dealers accept no responsibility whatsoever for any damage, loss or the like arising from their use.

ABBREVIATIONS

M	stitch(es)
MG	stitch size
Nd	needle(s)
R	row
RZ	row counter
2 R	knit 2 rows
4 R	knit 4 rows
1 ↻	racking handle one full turn to the right
2 ↻	racking handle two full turns to the right
1 ↻	racking handle one full turn to the left
	rack back bed completely to the right before you start a pattern
	Transfer stitches from back to front bed
	Transfer stitches from front to back bed
	Lever position for U80/U100/U100E
col 1	first colour
col 2	second colour
	with front lock alone
x	when finished, unravel these stitches
$C \rightarrow \odot$	$E \rightarrow \square$ rotate the pattern by one quarter turn to the right, etc..

PATTERN DIAGRAMS

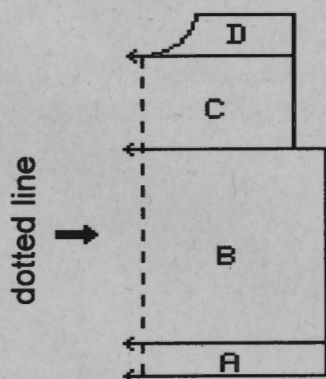

Diagram

This pattern only shows half of the the shape being knitted.

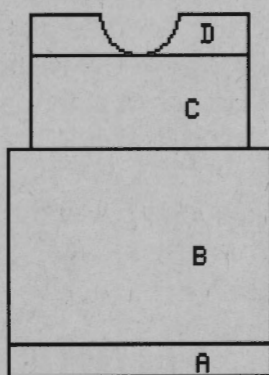

Knitting

This is the actual shape being knitted following the indications in the diagram on the left.

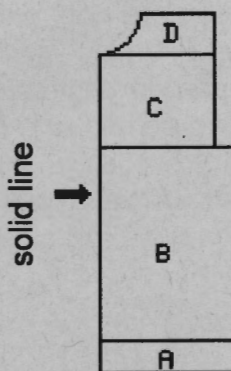

Diagram and Knitting

Here the diagram and the shape being knitted are identical as the centre line is not dotted; in this case the diagram represents a jacket front.

4

INCREASING AND DECREASING

+ 3 x • 8.R

= increase 2 stitches every 8th and following 8th row 3 times in all (i.e. the distance between the increases is always 8 rows).

-19 x 3 • 6.R

= decrease 3 stitches every 6th and following 6th row 19 times in all (i.e. the distance between the decreases is always 6 rows).

-17 x 1•2./4.R

= decrease 1 stitch alternately once after 2 rows and once after 4 rows 17 times in all.

◆ -4 x 8 •2.R◆

= the black triangles indicate increases or decreases with short rows (graduations). When decreasing, the stitches are not being cast off but the pushers are brought to Rest Position (for ELECTRONIC 6000 'out of work' = pushed right down). When increasing, not the actual stitches are increased but pushers are gradually brought to Working Position.

NUMBER OF STITCHES

Normally the stitches indicated refer to the stitches of the front bed, the stitches of the back bed are taken for granted.

(I.e. when you have to decrease two stitches for double bed knitting, this means two stitches have to be decreased on the front bed and two stitches on the back bed.)

Note: If you are not knitting with all the needles but only with every alternate needle (e.g. 1:1 rib), you still have to count the empty needles between the needles carrying stitches, i.e. the number of stitches will indicate the width on the needle bed across which you are going to knit.

Important: Always look at the indications given for 'Test Square'. For all double bed patterns we indicate how to count the stitches.

U70, U80, U100, U100E

- U70 kann gebraucht werden mit DUOMATIC S, DUOMATIC 80, ELECTRONIC 6000, jedoch nur für die Muster, die mit Schalterstellung 4 für U80, U100 und U100E beschrieben sind.
- U80 kann gebraucht werden mit DUOMATIC S und DUOMATIC 80
- U100 kann gebraucht werden mit DUOMATIC S und DUOMATIC 80
- U100E kann gebraucht werden mit DUOMATIC S, DUOMATIC 80 ELECTRONIC 6000

5904 DUOMATIC 80/S ELECTRONIC 6000

Length per 100 g = 480 m

Linen summer dress

[Instructions for ELECTRONIC 6000 in square brackets]

Size: To fit 88 - 92 cm bust

Material: 320 g Linen beige (Figaro from Conofil)

Stitch size: Pattern A = 5. Pattern B = back and front 4. Hem and Bindings = 4 1/2

Test square: Pattern A: 100 st = 40.5 cm, 100 R = 14 cm.

Pattern B: 100 st = 40.5 cm, RC 100 = 35 cm (after releasing the st)

Pattern: Pattern A: slip stitch pattern according to diagram 1 with self-punched DECO card 1 [Pattern 1005, TECH 130, with lock position according to diagram A]

Pattern B: pattern with released stitches according to diagram B with self-punched DECO card 2 [with self-drawn pattern sheet 2, TECH 251]. Hem and bindings = tubular [cast on 8, cont to knit.] For slit edge rear CX [ELECTRONIC the same]

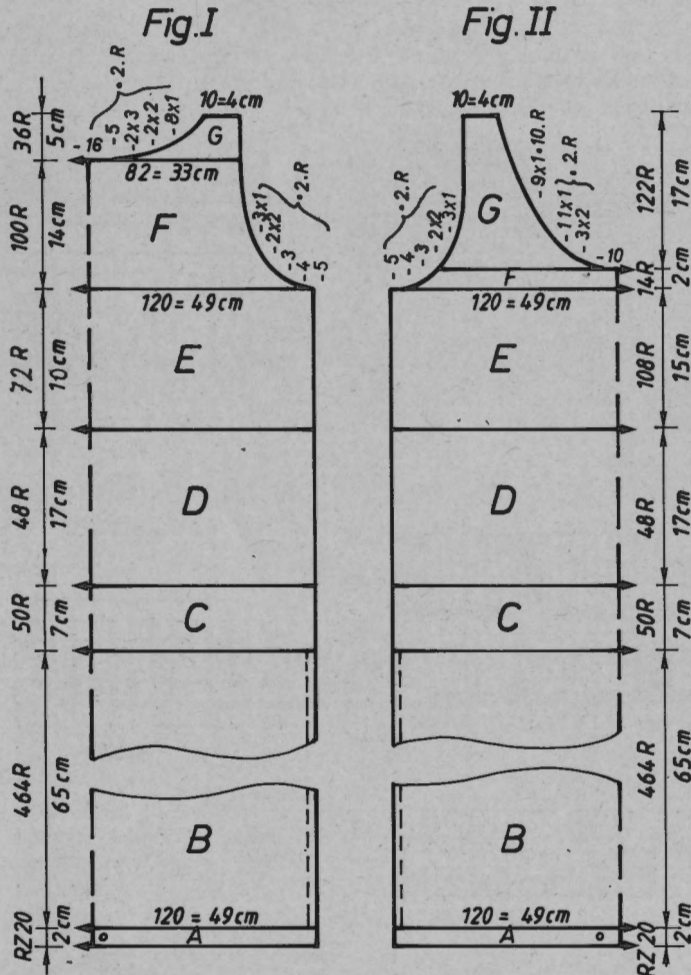

Fig.I: Back

A = closed cast on for tubular, [cast on 8, cont to knit] B = hang all st on front bed, on the right edge put 5 nds in working position acc to diagram C [ELECTRONIC the same]. Knit straight with stitch pattern A acc to diagram C with DECO punchcard 1 [Pattern 1005, TECH 130, but lock position acc to diagram C], hang the last 5 st from edge on the front bed. C = cont to knit with stitch pattern A. D = transfer all st to rear bed, knit with stitch pattern B acc to diagram B with DECO punchcard 2 [with pattern sheet 2 TECH 251], when complete, release all st from the front bed. E = transfer all st from rear bed to front bed, knit with stitch pattern A acc to diagram A with DECO punchcard [Pattern 1005, TECH 130 acc to diagram A]. F = cont to knit with stitch pattern A, and shape both sides for sleeveholes. G = divide work, cast off centre st (if you knit without FORM program, make a note of the electronic row counter), place left half onto decker combs. Cont to knit right half, and shape left for neck, cast off. Put left part back onto the same nds as before and finish knitting with reversed shape.

Fig.II: Front

A, B (but with the slit edge to the left), C, D, E = knit as in Fig.I. F = cont to knit with stitch pattern A, and shape for sleeveholes. G = divide work, cast off centre st (if you knit without FORM program, make a note of the electronic row counter), place left half onto decker combs. Cont to knit right half, and shape left for neck, cast off. Put left part back onto the same nds as before and finish knitting with reversed shape.

Bindings: Front neck: closed cast on for tubular [cast on 8, cont to knit] over 114 nds, st.s 4 1/2, knit RC 12, end with a few R of contrast yarn, release. Rear neck: knit the same, but over 120 nds. Sleeve hole: knit the same, but over 124 nds, knit two.

To make up: Block parts to size and leave to dry under a damp cloth. Sew shoulder seams. Sew neck bindings st by st with backstitch to front and rear neck through open loops and unravelling contrast yarn, hem down on inside. Sew shoulder seams. Sew sleeve hole bindings st by st with backstitch to sleeveholes through open loops and unravelling contrast yarn, hem down on inside. Sew side seams with mattress stitch.

Fig.I

34/3638/4042/44

1	56	56	56
2	162	162	162
3	.	.	A
4	.	.	B
5	111	121	131
6	88	96	104
7	.	.	**
8	195	195	195
9	.	.	C
10	135	135	135
11	128	128	128
12	38	38	38
13	111	121	131
14	88	96	104
15	.	.	**
16	72	72	72
17	125	125	125
18	.	.	***
19	98	98	98
20	192	192	192
21	2	2	2
22	195	195	195
23	.	.	C
24	135	135	135
25	181	181	181
26	233	233	233
27	135	135	135
28	47	47	47
31	153	153	153
32	162	162	162
33	155	155	155
34	135	135	135
35	53	53	53
29	169	169	169
30	161	161	161
36	73	73	73
37	184	184	184
38	128	129	130
39	169	169	169
40	178	178	178
41	162	162	162
42	191	191	191
43	129	129	129
44	1	1	1
45	133	133	133
46	0	0	0

5904

Diagram A

[Pattern 1005, TECH 130 but lock position according to diagram]

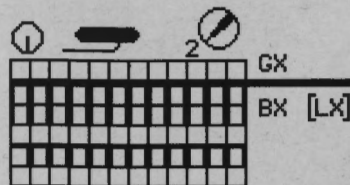
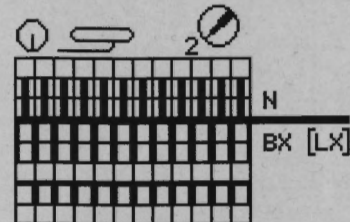

Diagram B

[TECH 251]



When complete, release all stitches from the front bed

Diagram C for slit edge

[ELECTRONIC the same TECH 132, but rear lock CX]

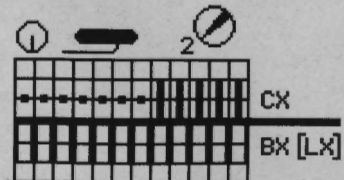

Chart for DECO card



Chart for DECO card / pattern sheet

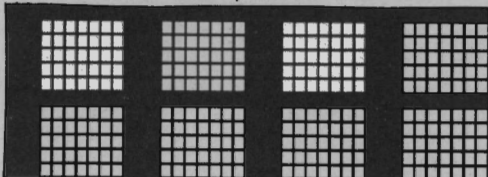

Fig.II

34/3638/4042/44

1	56	56	56
2	162	162	162
3	.	.	A
4	.	.	B
5	111	121	131
6	88	96	104
7	.	.	**
8	195	195	195
9	.	.	C
10	135	135	135
11	128	128	128
12	38	38	38
13	111	121	131
14	88	96	104
15	.	.	**
16	72	72	72
17	125	125	125
18	.	.	***
19	98	98	98
20	192	192	192
21	2	2	2
22	195	195	195
23	.	.	C
24	135	135	135
25	181	181	181
26	233	233	233
27	135	135	135
28	47	47	47
29	169	169	169
30	161	161	161
31	153	153	153
32	162	162	162
33	155	155	155
34	135	135	135
35	53	53	53
36	73	73	73
37	160	168	176
38	179	179	179
39	191	191	191
40	132	132	132
41	4	4	4
42	191	191	191
43	130	130	130
44	38	38	38
45	130	130	130
46	0	0	0

5905

9

Fig.I

34/3638/4042/44

1	42	42	42
2	158	158	158
3	.	.	A
4	.	.	B
5	116	127	137
6	82	90	98
7	.	.	**
8	38	38	38
9	111	122	132
10	82	90	98
11	.	.	**
12	58	58	58
13	80	80	80
14	.	.	***
15	102	102	102
16	162	162	162
17	154	154	154
18	146	146	146
19	158	158	158
20	135	135	135
21	86	86	86
22	0	0	0
23	.	.	184 184 184
24	.	.	129 130 131
25	.	.	170 170 170
26	.	.	154 154 154
27	.	.	164 164 164
28	.	.	175 175 175
29	.	.	3 3 3
30	.	.	135 135 135
31	.	.	8 8 8
32	.	.	0 0 0

Fig.II

34/3638/4042/44

42	42	42
158	158	158
.	.	A
.	.	B
116	127	137
82	90	98
.	.	**
38	38	38
111	122	132
82	90	98
.	.	**
58	58	58
80	80	80
.	.	***
230	230	230
162	162	162
154	154	154
146	146	146
158	158	158
135	135	135
86	86	86
73	73	73
184	184	184
129	130	131
170	170	170
154	154	154
164	164	164
175	175	175
3	3	3
135	135	135
8	8	8
0	0	0

Fig.III

34/3638/4042/44

42	42	42
158	158	158
.	.	A
.	.	B
73	76	78
3	3	3
.	.	**
3	3	3
38	38	38
99	101	104
39	40	41
.	.	**
25	25	25
43	43	43
.	.	***
108	108	108
133	133	133
162	162	162
154	154	154
164	164	164
191	191	191
136	136	136
53	53	53
164	164	164
190	190	190
130	130	130
188	188	188
129	129	129
0	0	0

Chart for DECO card / pattern sheet

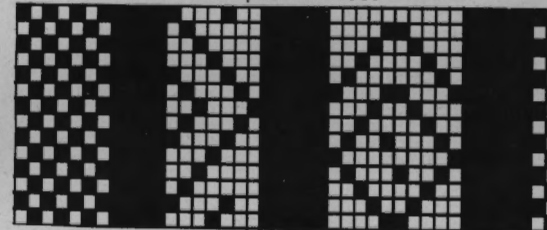

5905 DUOMATIC 80/S ELECTRONIC 6000

Length per 100 g = 480 m

Lady's pullover

[Instructions for ELECTRONIC 6000 in square brackets]

Size: To fit 88 - 92 cm bust

Material: 310 g linen beige

Stitch size: Pattern = back 5, front 4. Neckband = 4 1/2

Test square: 100 st = 39.5 cm. RC 100 = 10.5 cm

Pattern: Pattern according to diagram with self-punched DECO card [self-drawn pattern sheet, TECH 185, but rear lock and pusher position according to diagram]. Neckband = closed cast on for tubular [cast on 8, cont to knit].

Fig.I: Back

A = tubular cast on for 1:1 [cast on 1]. Transfer all st to rear bed, cont to knit with stitch pattern acc to diagram with DECO punchcard [with pattern sheet, TECH 185, but rear lock and pusher position acc to diagram]. B = shape both sides for sleeve

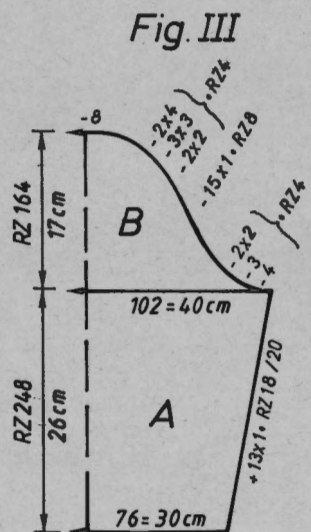
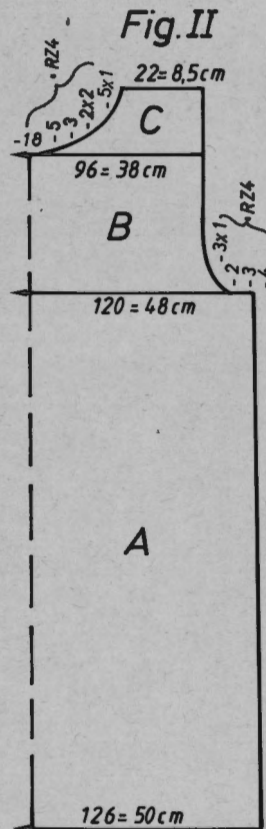
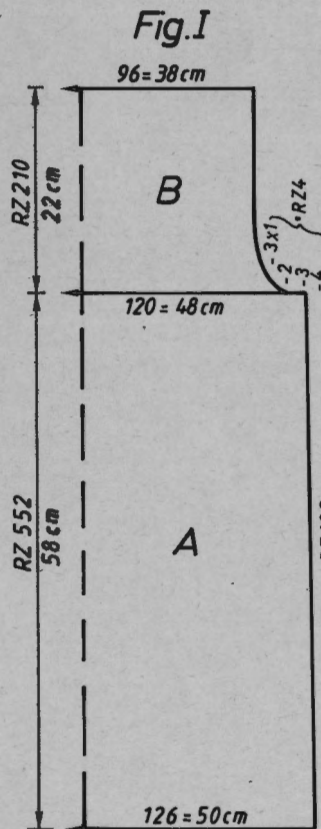

hole, cont to knit straight, cast off.

Fig.II: Front

A = knit as in Fig.I. B = shape both sides for sleeve hole, cont to knit straight. C = divide work, cast off centre st (if you knit without FORM program, make a note of the electronic row counter), place left half onto decker combs. Cont to knit right half, and shape left for neck, cast off. Put left part back onto the same nds as before and finish knitting with reversed shape.

Fig.III: Sleeves, knit 2

A = tubular cast on for 1:1 [cast on 1]. Transfer all st to rear bed, cont to knit with stitch pattern acc to diagram with DECO punchcard [with pattern sheet, TECH 185, but rear lock and pusher position acc to diagram], and inc on both sides. B = shape both sides for sleeve head, cast off.

Neckband: Closed cast on for tubular [cast on 8, cont to knit] over 112 nds, st.s 4 1/2, knit RC 16, end with a few R of contrast yarn, release.

To make up: Block parts to size and leave to dry under a damp cloth. Sew shoulder seams. Sew one shoulder seam. Sew neckband st by st with backstitch to neck through open loops and unravelling contrast yarn, hem down on inside. Sew other shoulder seam. With right sides together, sew sleeves to back and front part. Sew sleeve and sleeve seams with mattress stitch.

Note: The row count in pattern refers to the ELECTRONIC 6000 stitch sample. If you knit with the DUOMATIC, you only need half as many rows.

Diagram for DUOMATIC

Note: Before beginning the pattern transfer all st to rear bed.

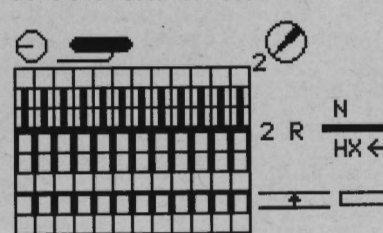
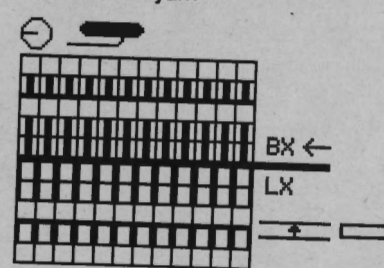

Diagram for ELECTRONIC 6000

[TECH 185, but rear lock and pusher position according to diagram]

2 R knit without yarn
2 R knit with yarn



5900 + 5901 ELECTRONIC 6000

Fig.I	34/3638/4042/44			Fig.II	34/3638/4042/44		
1	96	96	96	1	96	96	96
2	152	152	152	2	152	152	152
3	.	.	A	3	.	.	A
4	.	.	B	4	.	.	B
5	89	100	111	5	89	100	111
6	82	90	96	6	82	90	96
7	.	.	**	7	.	.	**
8	194	194	194	8	194	194	194
9	.	.	C	9	.	.	C
10	132	132	132	10	132	132	132
11	38	38	38	11	38	38	38
12	89	100	111	12	89	100	111
13	82	90	96	13	82	90	96
14	.	.	**	14	.	.	**
15	25	25	25	15	25	25	25
16	27	27	27	16	27	27	27
17	.	.	***	17	.	.	***
18	0	0	0	18	103	103	103
				19	161	169	177
				20	161	161	161
				21	153	153	153
				22	145	145	145
				23	155	155	155
				24	135	135	135
				25	3	3	3
				26	0	0	0

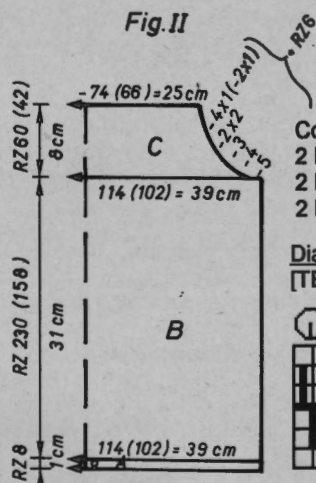
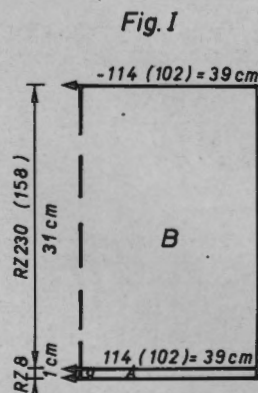

Col sequence :
 2 R black FORM program and
 2 R white pattern sheets 9 + 12
 2 R pink see p. 9.

Diagram for long stitch:
 [TECH 117]

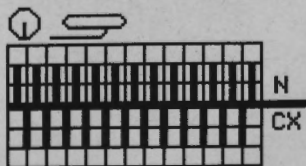

Top to 5902

[Instructions for ELECTRONIC 6000 in square brackets]

Size: To fit 88 - 92 cm bust

Length per 100 g = 500 m

Material: 160 g polyacryl pink

Stitch size: Pattern = 5, Hem = 5 3/4

Test square: 100 sts (counted on front bed) = 34 cm., RC 100 = 13,5 cm

Pattern: Long stitch acc. to diagram [TECH 117], hem = tubular [CAST ON 8, cont to knit]

Fig. I: Back

A = closed tubular cast on [CAST ON 8, cont to knit] B = knit long st. acc to diagram [TECH 117], cast off.

Fig. II: Front

A + B as for Fig. I. C = shape both sides for sleeve hole, cast off.

Bindings and straps: nit 2

Closed tubular cast on over the whole width of the bed [CAST ON 8, cont to knit], st.s 5 1/2, knit RC 16, end with a few R of contrast yarn, cast off.

Front bindings:

Closed tubular cast on over 48 nds [CAST ON 8, cont to knit], st. s 5 1/2, knit RC 16, end with a few R of contrast yarn, cast off.

To make up: Block parts to size and leave to dry under a damp cloth. Close side seams with mattress stitch. Sew front bindings st by st, backstitching through the open loops and gathering front slightly, at the same time unravelling contrast yarn. Hem down on inside. Sew binding, starting from the centre of the back, to back and sleeve holes stitch by stitch backstitching into the open loops, unravelling the contrast yarn. Hem down at the inside. Crochet the remaining free stitches unravelling the contrast yarn. Sew straps to back according to your measurement, approx. 4 cm to the right and left of center.

5901 : Fairisle top for 5902

Size : To fit 88 - 92 cm bust

Material : 130 g polyacryl pink, 50 g wool white (Brillanta from Conofil), 30 g Acetate black (Clara from Conofil)

Stitch size : 3 colour Fairisle pattern = back 4 1/2, front 5, hem 5 3/4.

Test square : 100 st. (counted on front bed) = 38 cm, RC 100 = 19.5 cm

Pattern : 3 colour Fairisle pattern according to diagram and colour sequence with-self drawn pattern sheets. Pattern sheet 1 with continuation 2, ALTER = ENT, C → N, ADD pattern sheet 3 with continuation 4, ALTER = ENT, C → N. TECH 195. Hem = cast on 8, cont. to knit.

Fig. I: Back

A = polyacryl pink cast on 8, cont to knit. B = in 3 col Fairisle knit acc to diagram and col seq with stitch pattern TECH 195, cast off.

Fig. II: Front

Knit A + B as for Fig. I. C = shape both sides for sleeveholes, knit with pattern, cast off.

Bindings and straps :

Knit as described for top 5900.

To make up :

As described for top 5900.

Length per 100 g

Polyacryl pink = 500 m

Acetate black = 435 m

Wool white = 385 m

5902

Fig.I				Fig.II			Fig.III		
34/3638/4042/44				34/3638/4042/44			34/3638/4042/44		
1	54	54	54	54	54	54	54	54	54
2	136	136	136	391	391	391	136	136	136
3	.	.	A	.	.	A	.	.	A
4	.	.	B	.	.	B	.	.	B
5	141	153	165	71	76	82	88	91	94
6	82	90	98	82	90	98	3	3	3
7	.	.	**	.	.	**	3	3	3
8	38	38	38	38	38	38	38	38	38
9	126	138	150	56	62	68	118	121	124
10	82	90	98	82	90	98	40	41	42
11	.	.	**	.	.	**	.	.	**
12	12	12	12	12	12	12	7	7	7
13	58	58	58	58	58	58	25	25	25
14	.	.	***	.	.	***	.	.	***
15	38	38	38	166	166	166	111	111	111
16	138	150	162	76	82	88	132	132	132
17	82	90	98	82	90	98	171	171	171
18	.	.	**	.	.	**	163	163	163
19	21	21	21	21	21	21	191	191	191
20	3	3	3	3	3	3	128	128	128
21	3	3	3	3	3	3	14	14	14
22	233	233	233	67	67	67	191	191	191
23	132	132	132	191	191	191	129	129	129
24	171	171	171	150	151	152	5	5	5
25	163	163	163	221	221	221	191	191	191
26	155	155	155	105	104	105	133	133	133
27	166	166	166	132	171	132	5	5	5
28	159	159	159	171	163	171	191	191	191
29	2	2	2	163	155	163	137	137	137
30	135	135	135	155	166	155	5	5	5
31	58	58	58	166	159	166	0	0	0
32	69	69	69	159	2	159			
33	184	184	184	2	135	2			
34	135	136	137	135	58	135			
35	191	191	191	58	0	58			
36	136	136	136	0		0			
37	128	128	128						
38	0	0	0						

Pattern sheet 12

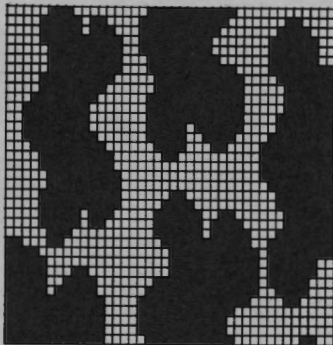

Pattern sheet 9

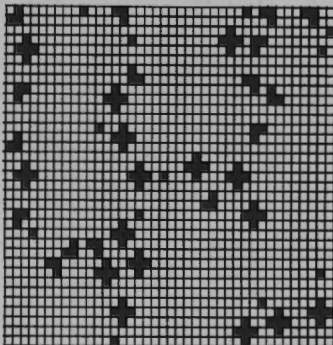

5901

Pattern sheet 2

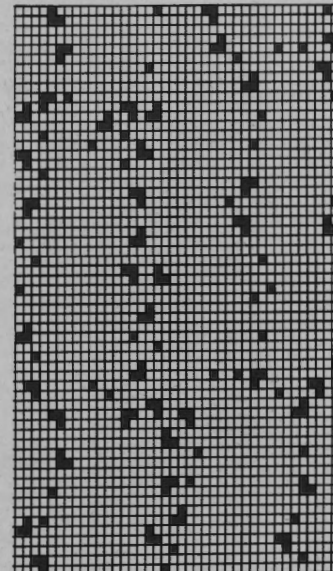

Pattern sheet 1

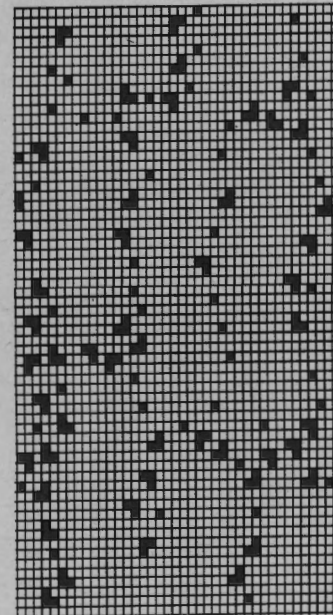

Pattern sheet 4

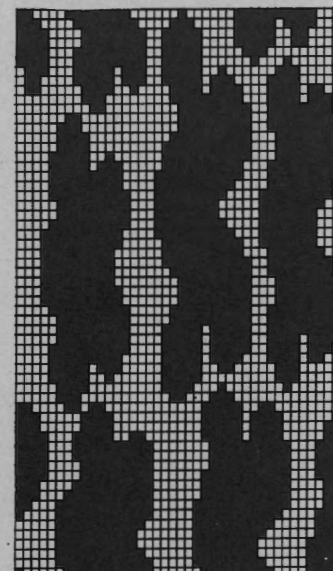

Pattern sheet 3

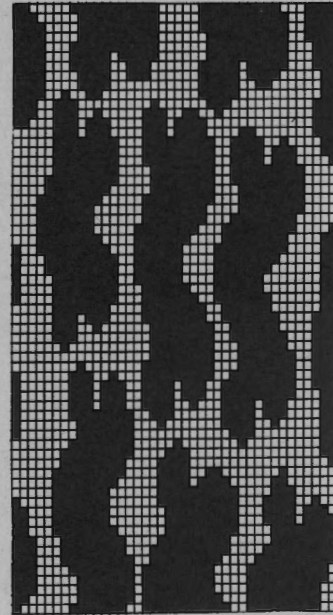

5902 ELECTRONIC 6000

Lady's jacket 3 colour Fairisle pattern

Size : To fit 88 - 92 cm bust
 Material : 360 g polyacryl pink, 140 g Acetate black (Clara from Conofil) 150 g wool white (Brillanta from Conofil)
 Stitch size : 3 colour Fairisle pattern = back 4 1/2, front 5, neckband = 6.
 Test square : 100 st. (counted on front bed) = 34 cm, RC 100 = 13.5 cm
 Pattern : 3 colour Fairisle pattern according to colour sequence
 Stitch pattern A: pattern sheet 1 with continuation 2 + 3, ALTER = ENT, \hookrightarrow , ADD pattern sheet 4 with continuation 5 + 6, ALTER = ENT, \hookrightarrow , 3.COL = ENT, TECH 195 but pusher and lock on rear bed according to diagram.
 Stitch pattern B: pattern sheet 7 with continuation 8 + 9, ALTER = ENT, \hookrightarrow , ADD pattern sheet 10 with continuation 11 + 12, ALTER = ENT, \hookrightarrow 3.COL = ENT, TECH 195 but pusher and lock on rear bed according to diagram.
 Neckband = cast on 8, TECH 108 + 109 cont to knit, according to colour sequence.

Fig. I: Back

A = cast on 2, knit with stitch pattern A and col seq, and shape both sides. B = inc both sides, after RC 240 after casting on switch to stitch pattern B and cont inc. C = shape both sides for sleeveholes, cont to knit with same stitch pattern. D = divide work, cast off

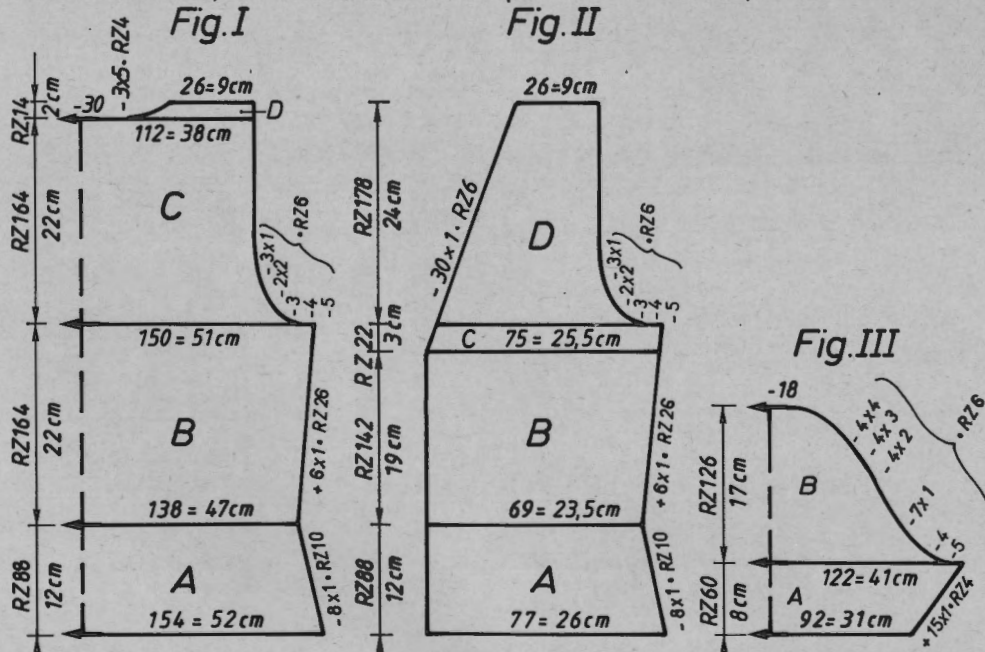

centre st (if you knit without FORM program, make a note of the electronic row counter), place left half onto decker combs. Cont to knit right half, and shape left for neck, cast off. Put left part back onto the same nds as before and finish knitting with reversed shape.

Fig. II: Front part, knit two reversed shapes.

A = cast on 2, knit with stitch pattern A and col seq., and shape right. B = inc right. C = shape left for neck, after RC 240 after casting on switch to stitch pattern B and cont inc. D = shape right for sleeveholes, left for neck, cast off.

Fig. III: Sleeves, knit 2

A = cast on 2, knit with stitch pattern A and col seq, and inc on both sides. B = shape both sides for sleeve head, cast off.

Neckband: knit two reversed shapes.

Cast on 8 with contrast yarn front over 175 nds, rear over 70 nds. TECH 108, st.s 6, 8 R black, 6 R white, 8 R black, and shape left with double-decker needles 8 times every fourth R cast off a stitch, end with a few R of contrast yarn with lock N/N, release. Knit second part with TECH 109.

Back border: Knit with black cast on 8 over 135 nds, st.s. 6, 8 R black, 6 R white, 8 R black, 6 R white, 8 R black, end with a few R of contrast yarn, release.

Sleeve cuffs: knit two.

Knit as for back border but only over 80 nds.

To make up: Block parts to size and leave to dry under a damp cloth. Sew shoulder seams. Join border pieces at centre back, st by st, backstitching through open loops to front edge and seam, unravelling contrast yarn. Hem down on inside. Sew back border st by st with backstitching to back hem through open loops and unravelling contrast yarn. Sew sleeve cuffs st by st with backstitching to sleeve hem through open loops and unravelling contrast yarn, hem down on inside. With right sides together, sew sleeves to back and front part. Sew sleeve and sleeve seams with mattress stitch.

Diagram for Technique 195 (Rear pushers and lock position according to diagram and not according to indicator.)

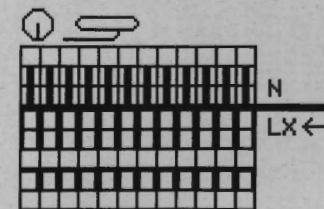

Col sequence
 2 R black
 2 R white
 2 R pink

FORM program and pattern sheets 9 + 12 see page 9

Length per 100 g
 Polyacryl pink = 500 m
 Acetate black = 435 m
 Wool white = 385 m

Pattern sheet 2

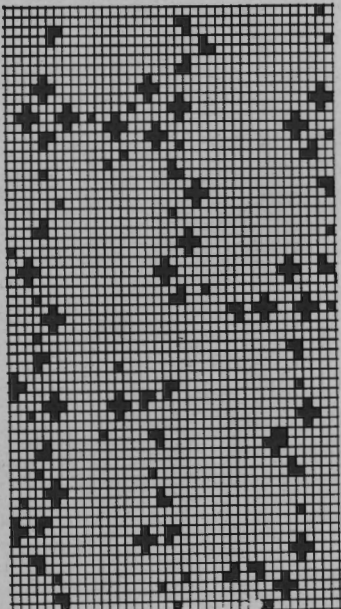

Pattern sheet 1

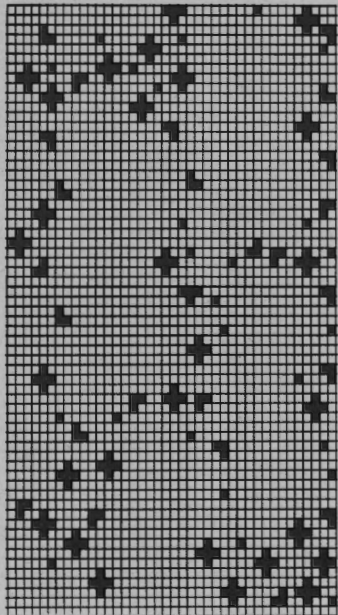

Pattern sheet 6

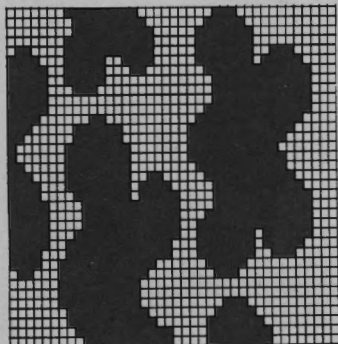

Pattern sheet 3

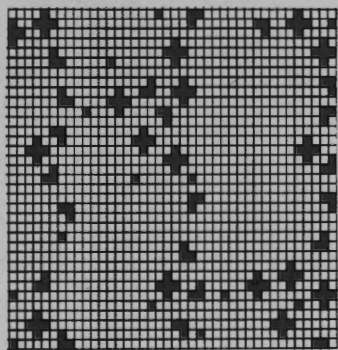

Pattern sheet 5

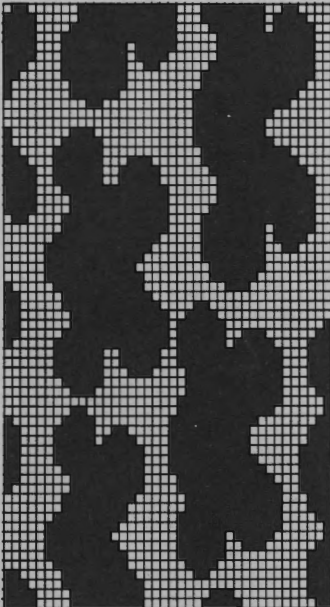

Pattern sheet 4

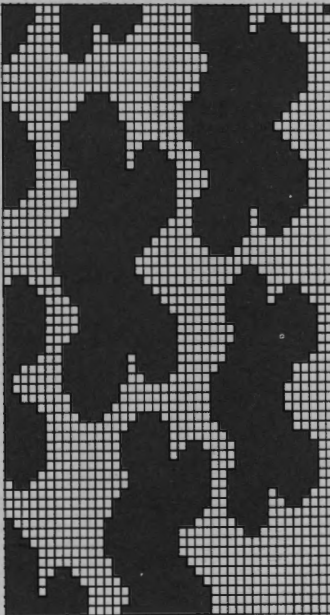

Pattern sheet 8

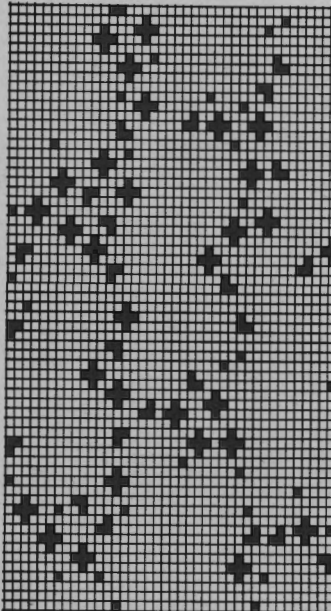

Pattern sheet 7

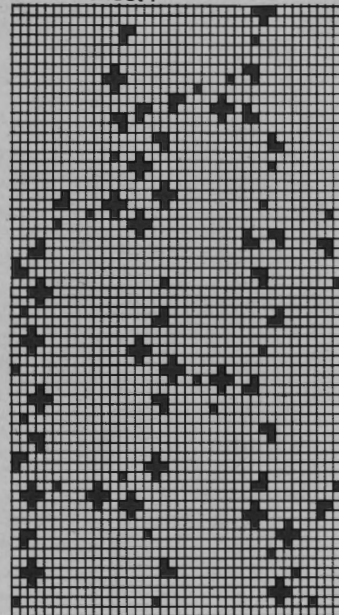

Pattern sheet 10

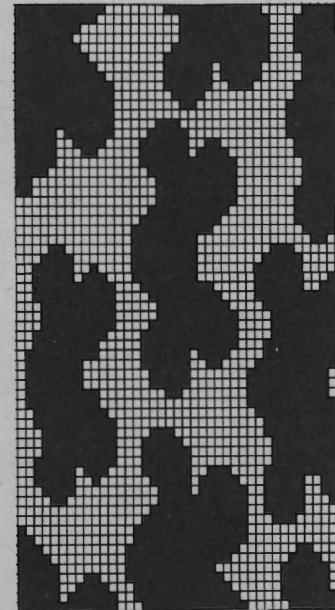

Pattern sheet 9

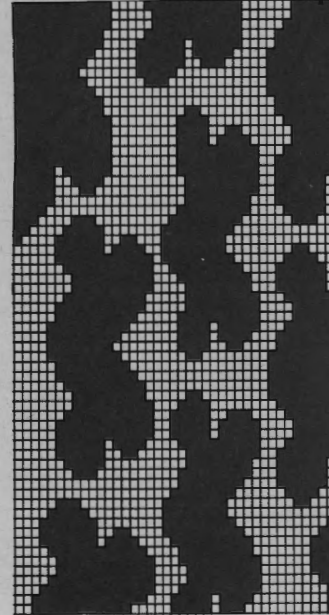

5903 ELECTRONIC 6000

Lady's pullover 4 colour Fairisle

Size: To fit 88 - 92 cm bust
Material: 380 g polyacryl pink, 130 g polyacryl turquoise, 160 g acetate black (Clara from Conofil), 140 g wool white (Brillanta from Conofil). 80 g each of wool; green, orange and blue (Nadine from Conofil)
Stitch size: 4 colour Fairisle = back 4 1/2, front 5. Seam and neckband = 4
Test square: 100 st (counted on front bed) = 31 cm, RC 100 = 7.5 cm
Pattern: According to colour sequence with self-drawn pattern sheets.
 Pattern A: pattern sheet 1 with continuation 2 + 3, ALTER = ENT, c → n, ADD pattern sheet 4 with continuation 5 + 6, ALTER = ENT, c → n, 3.COL = ENT, ADD pattern sheet with continuation 8 + 9, ALTER = ENT, c → n, 4.COL = ENT, TECH 209.
 Pattern B: Pattern sheet 10 with continuation 11 + 12, ALTER = ENT, c → n, ADD pattern sheet 13 with continuation 14 + 15, ALTER = ENT, c → n, 3.COL = ENT, ADD pattern sheet 16 with continuation 17 + 18, ALTER = ENT, c → n, 4.COL = ENT, TECH 209.

Pattern C: Pattern sheet 19 with continuation 20 + 21, ALTER = ENT, c → n, ADD pattern sheet 22 with continuation 23 + 24, ALTER = ENT, c → n, 3.COL = ENT, ADD pattern sheet 25 with continuation 26 + 27, ALTER = ENT, c → n, 4.COL = ENT, TECH 209. Cuff and neckband cast on 8, cont to knit.

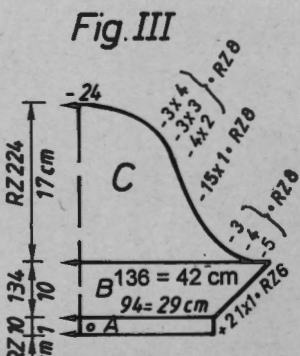
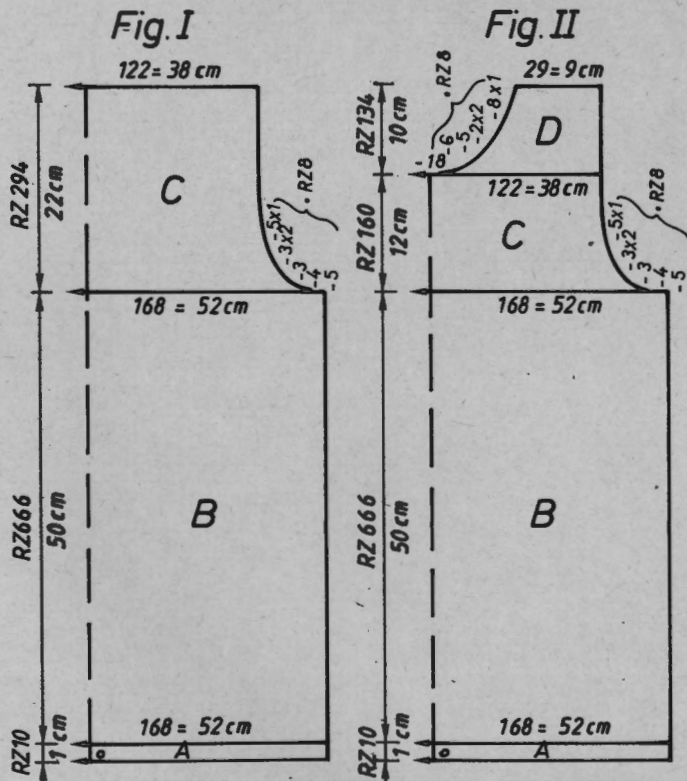

Fig.I: Back

A = cast on 8 with black, cont to knit. B = knit with pattern A and col seq, after RC 320 from the beginning of section A switch to pattern B, knit with stitch pattern and col seq, after RC 640 from the beginning of section A switch to pattern C, knit with stitch pattern and col seq. B = shape both sides for sleeveholes, cont to knit with stitch pattern, cast off.

Fig.II: Front

Knit A + B as in Fig.I. C = shape both sides for sleeveholes. D = divide work, cast off centre st (if you knit without FORM program, make a note of the electronic row counter), place left half onto decker combs. Cont to knit right half, and shape left for neck, cast off. Put left part back onto the same nds as before and finish knitting with reversed shape.

Fig.III: Sleeves, knit two

A = cast on 8, cont to knit, B = start with RC 128 in pattern B, set the mechanical row counter to 128 and knit with col seq, and inc on both sides. C = shape both sides for sleeve head, when mechanical row counter indicates RC 320 switch to pattern C, knit with stitch pattern and col seq, shape both sides for sleeve head, cast off.

Neckband: cast on 8 black, two strands, over 116 nds, st.s 5, knit RC 10, end with a few R of contrast yarn, release.

To make up: Block parts to size and leave to dry under a damp cloth. Sew shoulder seams. Sew neckband to neck st by st with backstitching through open loops and unravelling contrast yarn, hem down on inside. With right sides together, sew sleeves to back and front part. Sew sleeve and sleeve seams with mattress stitch.

Col Sequence for Fig. I + II

- RC 0-224 2 R white
- 2 R black
- 2 R green
- 2 R pink
- RC 225-432 2 R white
- 2 R black
- 2 R turquoise
- 2 R pink
- RC 433-656 2 R white
- 2 R black
- 2 R gold
- 2 R pink
- RC 657-960 2R white
- 2 R white
- 2 R black
- 2 R blue
- 2 R pink

Col sequence Fig.III

- RC 0-144 2 R white
- 2 R black
- 2 R gold
- 2 R pink
- RC 145-360 2 R white
- 2 R black
- 2 R blue
- 2 R pink

Length per 100
 Polyacryl pink and turquoise = 500 m
 Acryl black = 435 m
 Wool white = 385 m
 Wool green, orange, blue = 650 m

Pattern sheet 1

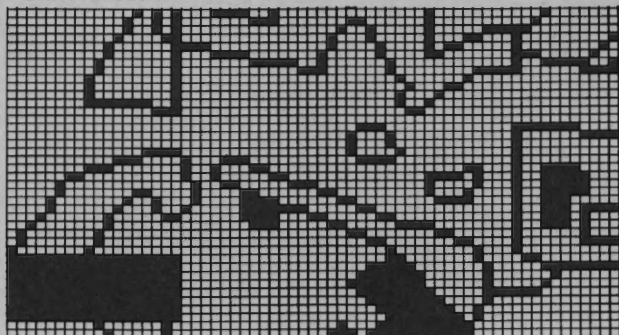

Pattern sheet 2

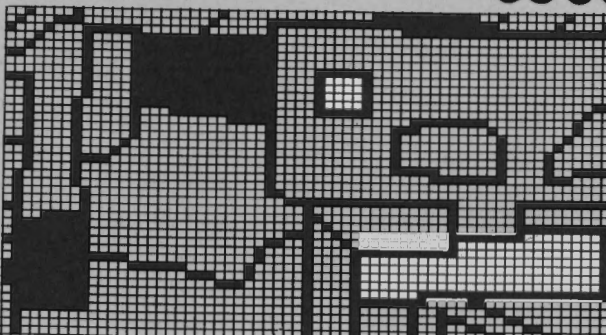

Pattern sheet 3

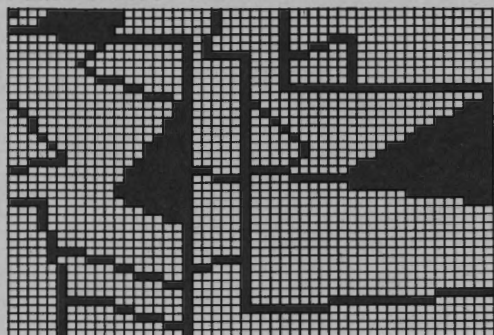

Pattern sheet 4

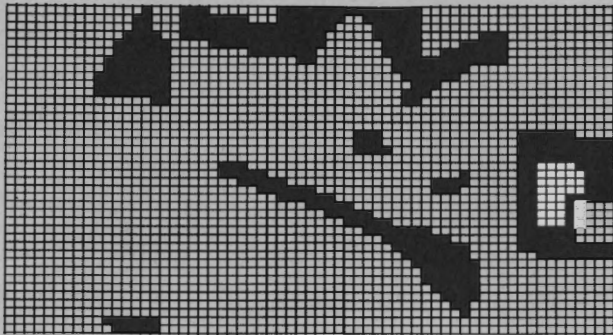

Pattern sheet 5

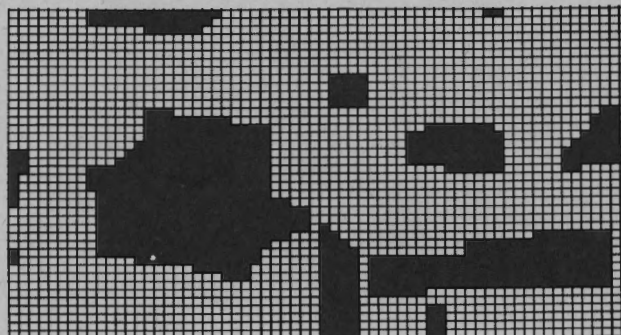

Pattern sheet 6

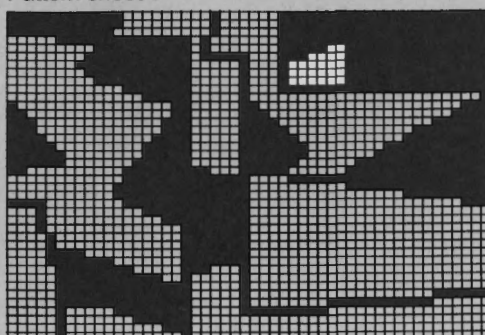

Pattern sheet 7

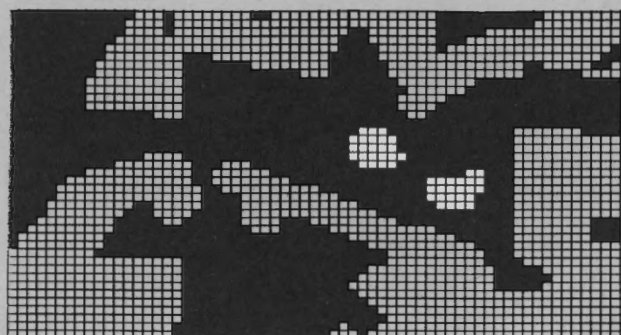

Pattern sheet 8

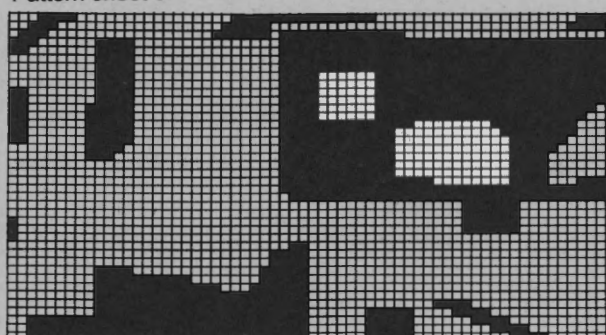

Pattern sheet 9

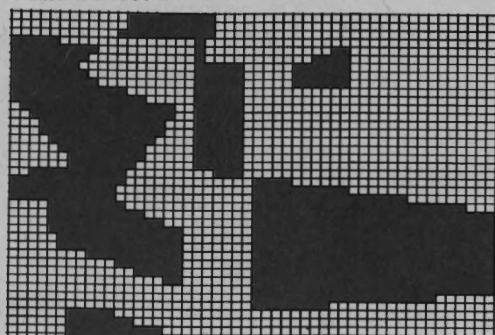

Pattern sheet 10

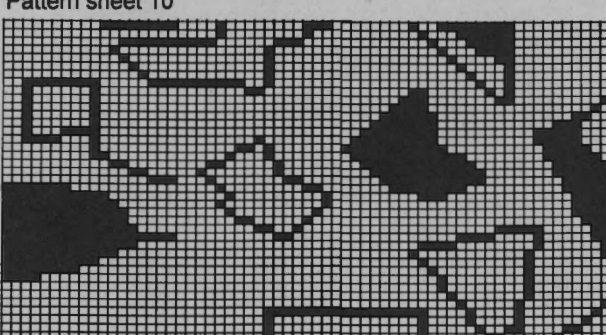

Pattern sheet 11

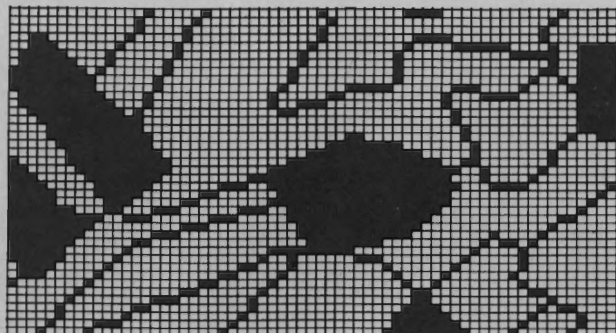

Pattern sheet 12

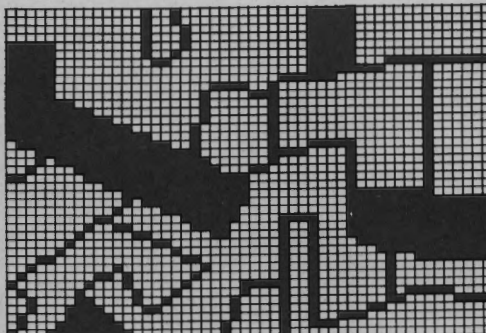

Pattern sheet 13

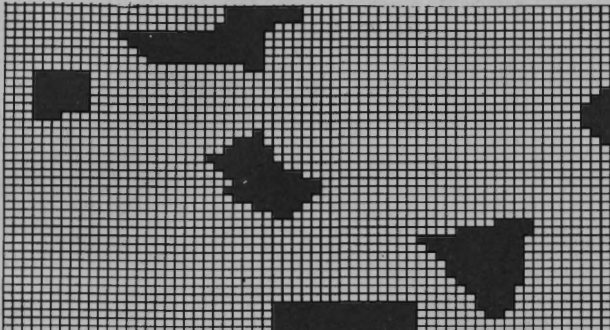

Pattern sheet 14

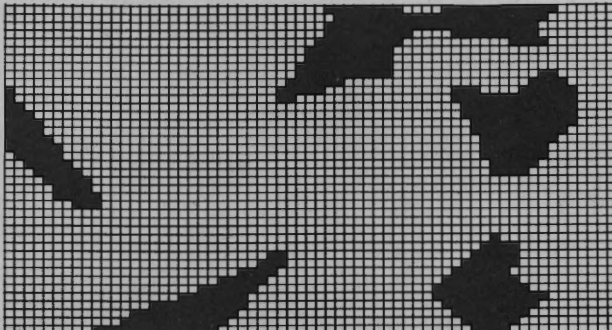

Pattern sheet 15

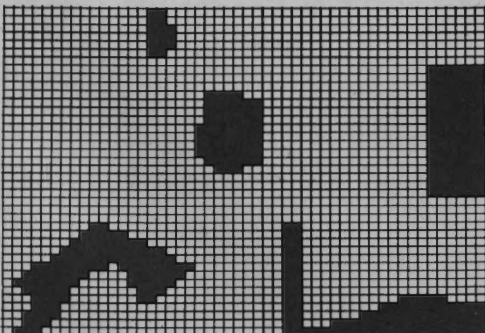

Pattern sheet 16



Pattern sheet 17

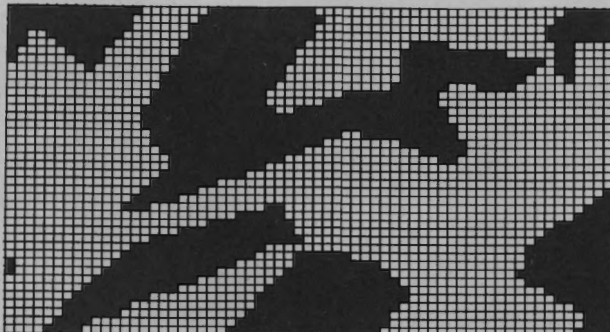

Pattern sheet 18

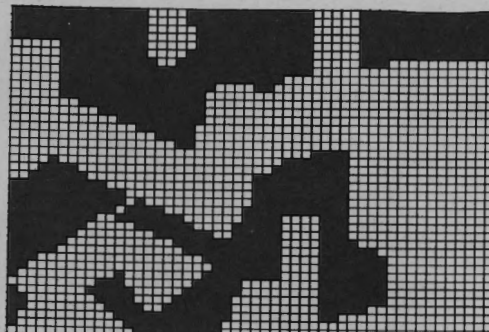

Pattern sheet 19

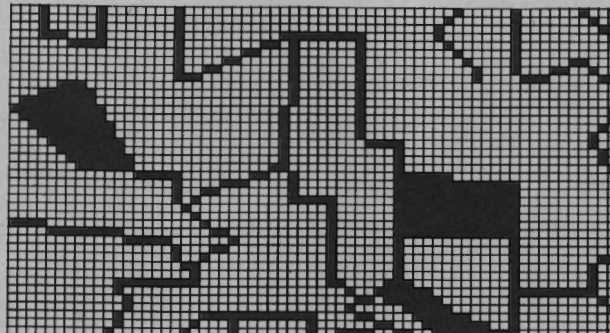

Pattern sheet 20

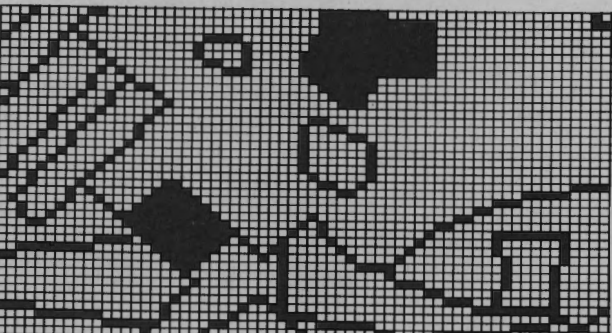

5903

Pattern sheet 22

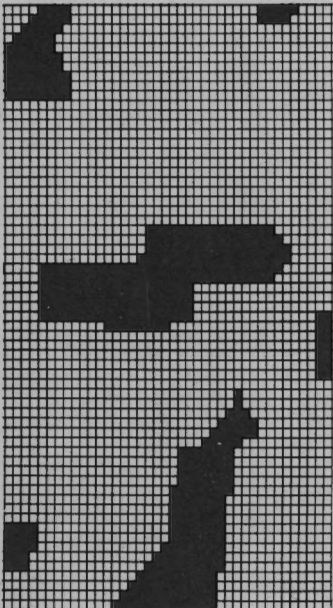

Pattern sheet 24

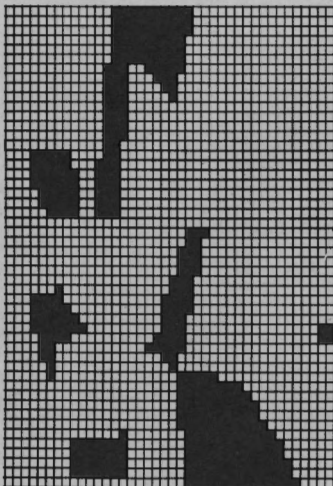

Pattern sheet 26

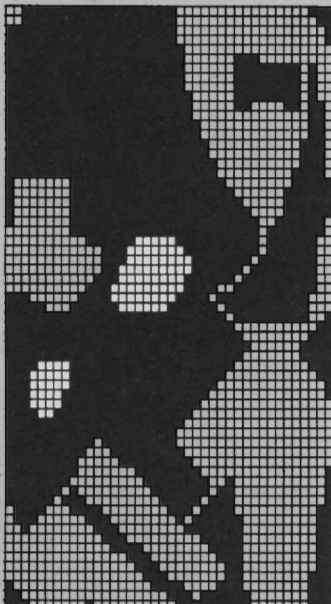

Pattern sheet 21

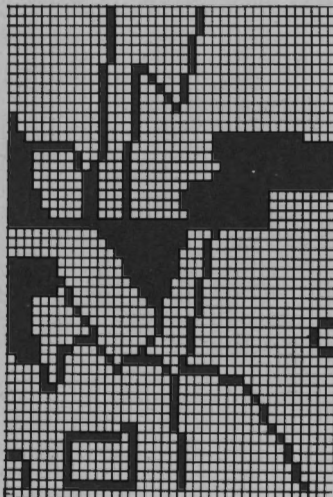

Pattern sheet 23

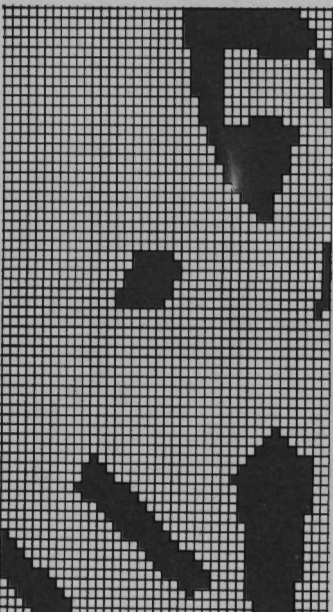

Pattern sheet 25

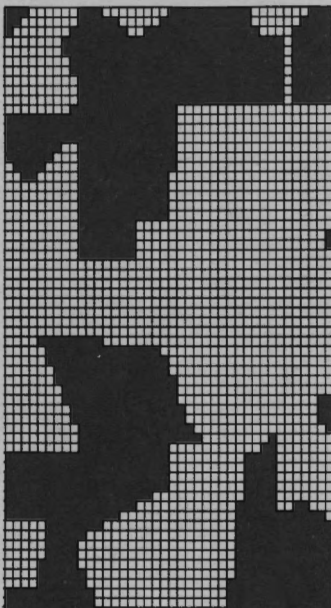

Pattern sheet 27

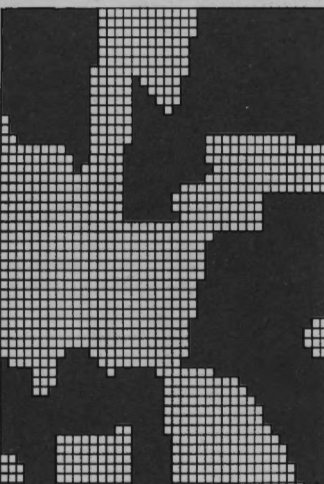

	Fig.II			Fig.III		
	34/3638/4042/44			34/3638/4042/44		
1	30	30	30	30	30	30
2	124	124	124	124	124	124
3	.	.	A	.	.	A
4	.	.	B	.	.	B
5	155	168	181	90	94	97
6	82	90	98	3	3	3
7	.	.	**	3	3	3
8	195	195	195	195	195	195
9	.	.	C	.	.	C
10	135	135	135	135	135	135
11	134	134	134	134	134	134
12	38	38	38	38	38	38
13	155	168	181	132	135	139
14	82	90	98	41	42	43
15	.	.	**	.	.	**
16	49	49	49	8	8	8
17	73	73	73	28	28	28
18	.	.	***	.	.	***
19	233	233	233	110	110	110
20	172	172	172	135	135	135
21	164	164	164	128	128	128
22	156	156	156	172	172	172
23	183	183	183	164	164	164
24	5	5	5	156	156	156
25	175	175	175	191	191	191
26	13	13	13	136	136	136
27	135	135	135	53	53	53
28	96	96	96	191	191	191
29	75	75	75	129	129	129
30	184	184	184	9	9	9
31	129	130	131	191	191	191
32	180	180	180	130	130	130
33	172	172	172	5	5	5
34	167	167	167	99	99	99
35	1	1	1	191	191	191
36	191	191	191	133	133	133
37	129	129	129	5	5	5
38	25	25	25	0	0	0
39	135	135	135	.	.	.
40	12	12	12	.	.	.
41	0	0	0	.	.	.

FORM programme for
Fig. I see page 17

5908 DUOMATIC 80 ELECTRONIC 6000

Child's pullover 4 colour Fairisle

[Instructions for ELECTRONIC 6000 in square brackets]

Size: To fit 140 cm height

Material: 170 g polyacryl turquoise, 120 g polyacryl pink, 70 g acetate black, wool green, orange, blue 60 g each

Stitch size: 4 colour Fairisle = back = 4 1/2, front = 5. Band and Neckband = 4

Test square: 100 st (counted on front bed) = 31 cm, RC 100 = 7.5 cm

Pattern: 4 colour Fairisle according to diagram a col sequence with self-punch DECO cards [with self-drawn pattern sheets, pattern sheet 1, ADD pattern sheet 2, 3.COL = ENT, ADD pattern sheet 3, 4.COL = ENT, TECH 209]. Band and neckband 1:1 [cast on 1, cont to knit]

Fig.I: Back

A = tubular cast on for 1:1 with polyacryl turquoise [cast on 1, cont to knit]. B = bring all nds in working position, cont to knit acc to diagram and col seq with DECO punchcard [with pattern sheet, TECH 209]. C = shape both sides sleeve hole, cast off.

Fig.II: Front

Knit A + B as in Fig.I. C = shape both sides for sleeve hole. D = divide work, cast off centre st (if you knit without FORM program, make a note of the electronic row counter), place left half onto decker combs. Cont to knit right half, and shape left for neck, cast off. Put left part back onto the same nds as before and finish knitting with reversed shape.

Fig.III: Sleeves, knit 2

A = tubular cast on for 1:1 with polyacryl turquoise [cast on 1, cont to knit]. B = bring all nds in working position, cont to knit Fairisle acc to diagram and col seq with DECO punchcard [with pattern sheet, TECH 209] and inc on both sides. C = shape both sides sleeve head, cast off.

Neckband: Tubular cast on for 1:1 with polyacryl turquoise [cast on 1, cont to knit] over nds, st.s 4, knit 26 R, end with a few R of contrast yarn.

To make up: Block parts to size and leave to dry under a damp cloth. Sew shoulder seams. Seam shoulders. Sew neckband st by st to neck with backstitches through open loops and unravelling contrast yarn, hem down on inside. With right sides together, sew sleeves to back and front. Sew sleeves and side seams with mattress stitch.

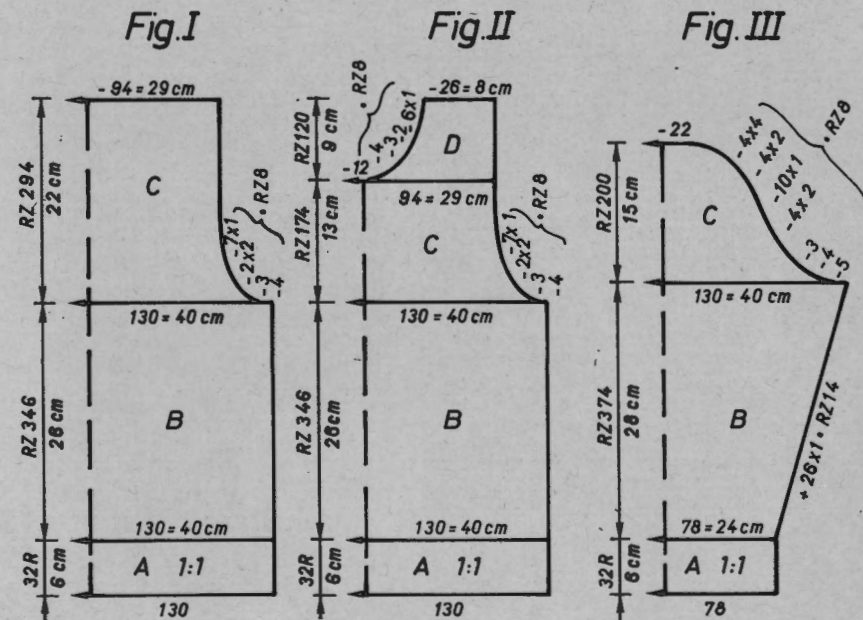
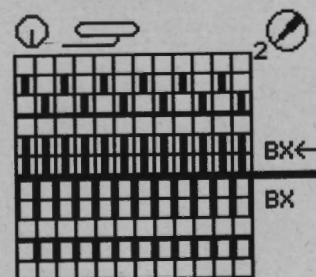

Diagram for 4 colour Fairisle [TECH 209]



Length per 100 g =
Polyacryl turquoise, pink 500 m
Acetate black 435 m
Wool green, orange, blue 650 m

Fig.I

	116	128	140	152	164
1	30	30	30	30	30
2	124	124	124	124	124
3	A
4	B
5	116	123	129	142	155
6	60	64	68	76	84
7	**
8	195	195	195	195	195
9	C
10	135	135	135	135	135
11	161	161	161	161	161
12	38	38	38	38	38
13	116	123	129	142	155
14	60	64	68	76	84
15	**
16	23	24	26	30	33
17	49	51	54	58	62
18	***
19	105	105	105	105	105
20	164	164	164	164	164
21	156	156	156	156	156
22	167	167	167	167	167
23	1	1	1	1	1
24	191	191	191	191	191
25	128	128	128	128	128
26	21	21	21	21	21
27	135	135	135	135	135
28	82	89	96	96	102
29	0	0	0	0	0

Colour sequence
RC0-16 2 R turquoise
2 R black
2 R green
2 R pink
RC17-80 2 R turquoise
2 R black
2 R green
2 R gold
RC 81-104 2 R turquoise
2 R black
2 R green
2 R pink
RC105-160 2 R turquoise
2 R black
2 R blue
2 R pink
RC161-208 2 R turquoise
2 R black
2 R green
2 R pink
repeat

Fig.II

	116	128	140	152	164
1	30	30	30	30	30
2	124	124	124	124	124
3	A
4	B
5	116	123	129	142	155
6	60	64	68	76	84
7	**
8	195	195	195	195	195
9	C
10	135	135	135	135	135
11	161	161	161	161	161
12	38	38	38	38	38
13	116	123	129	142	155
14	60	64	68	76	84
15	**
16	23	24	26	30	33
17	49	51	54	58	62
18	***
19	233	233	233	233	233
20	164	164	164	164	164
21	156	156	156	156	156
22	167	167	167	167	167
23	1	1	1	1	1
24	191	191	191	191	191
25	128	128	128	128	128
26	21	21	21	21	21
27	135	135	135	135	135
28	82	89	96	96	102
29	72	72	72	73	73
30	168	168	176	184	184
31	183	164	164	128	129
32	1	156	156	164	164
33	148	148	148	156	156
34	183	183	183	148	148
35	17	17	17	183	167
36	135	135	135	17	17
37	17	17	17	135	135
38	0	0	0	17	17
39	.	.	.	0	0

Fig.III

	116	128	140	152	164
1	30	30	30	30	30
2	124	124	124	124	124
3	A
4	B
5	71	74	77	81	84
6	3	3	3	3	3
7	3	3	3	3	3
8	195	195	195	195	195
9	C
10	135	135	135	135	135
11	161	161	161	161	161
12	38	38	38	38	38
13	123	126	129	132	135
14	38	39	40	41	42
15	**
16	20	23	27	31	34
17	41	45	49	53	58
18	***
19	110	110	110	110	110
20	135	135	135	135	135
21	128	128	128	128	128
22	172	172	172	172	172
23	164	164	164	164	164
24	156	156	156	156	156
25	191	191	191	191	191
26	129	129	129	129	129
27	9	9	9	9	9
28	191	191	191	191	191
29	129	131	131	131	133
30	25	33	33	33	41
31	191	191	191	191	191
32	129	129	129	129	129
33	9	9	9	9	9
34	99	99	99	99	99
35	191	191	191	191	191
36	137	137	137	137	137
37	9	9	9	9	9
38	0	0	0	0	0
39

DECO card 2

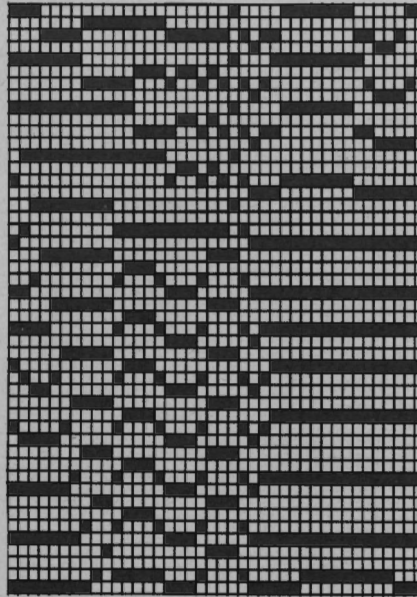

DECO card 1

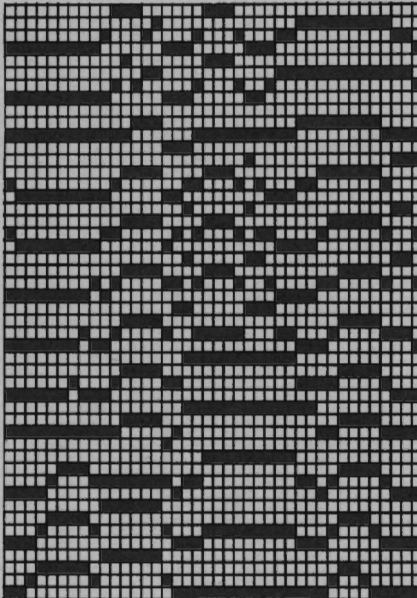

DECO card 3

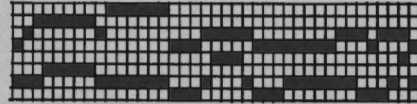

Pattern sheet 3

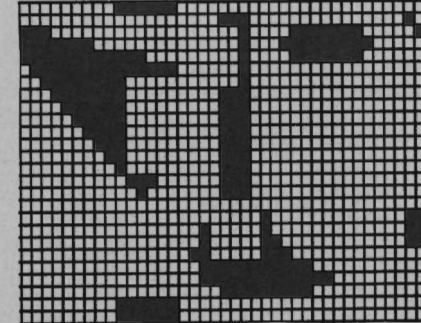

Pattern sheet 2

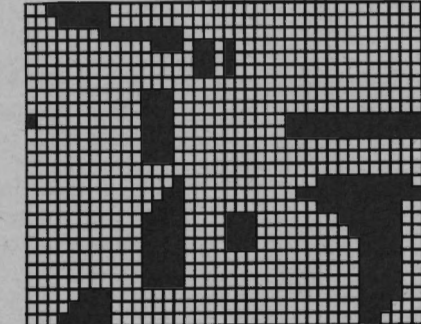

Pattern sheet 1

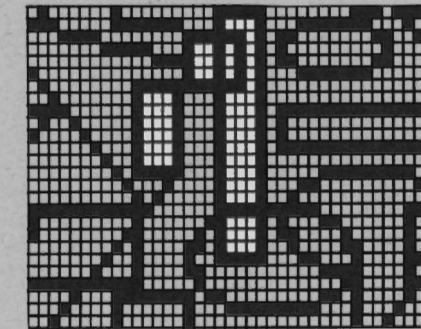

Fig.I

34/3638/4042/44

	30	30	30
1	30	30	30
2	124	124	124
3	.	.	A
4	.	.	B
5	155	168	181
6	82	90	98
7	.	.	**
8	195	195	195
9	.	.	C
10	135	135	135
11	134	134	134
12	38	38	38
13	155	168	181
14	82	90	98
15	.	.	**
16	49	49	49
17	73	73	73
18	.	.	***
19	105	105	105
20	172	172	172
21	164	164	164
22	156	156	156
23	183	183	183
24	5	5	5
25	175	175	175
26	13	13	13
27	135	135	135
28	96	96	96
29	0	0	0

5920 DUOMATIC 80/S ELECTRONIC 6000

Length per 100 g = 720 m

Child's jacket

Model T. Roganova Russia

[Instructions for ELECTRONIC 6000 in square brackets]

Size: To fit 110 cm height

Material: 210 g wool yellow, 15 g wool pink, 15 g wool rust, 10 g wool lilac, 7 buttons

Stitch size: Stocking stitch = 5, Hem = 4 1/2

Test square: 100 st = 32.5 cm, 100 R = 18.5 cm

Pattern: Stocking stitch [TECH 100], Fairisle single bed according to diagram and colour sequence with self-punched DECO cards [with self-drawn DECO pattern sheets, TECH 176], hem and buttonhole facings = tubular [cast on 8, cont to knit].

Fig. I: Back

A = closed tubular cast on with yellow wool [cast on 8, cont to knit], knit RC 30, lock rear N, front CX [TECH 117] knit RC 14. B = with rust wool knit RC 27 lock rear GX, front N [ELECTRONIC as well] st.s 5, transfer all st to the front bed, lock rear GX, front N [ELECTRONIC as well] st.s 4 1/2, knit 1 R. Knit with pink wool st.s 5, stocking stitch [TECH 100] 12 R. C = cont to knit with yellow wool. D = shape both sides for sleeve. E = divide work, cast off centre st, place left half onto decker combs. Cont to knit right half, and shape left for neck, cast off. Put left part back onto the same nds as before and finish knitting with reversed shape.

Fig. II: Front, knit two reversed shapes

A = closed tubular cast on with yellow wool [cast on 8, cont to knit], knit RC 30, lock rear N, front CX [TECH 117] knit RC 14. B = with rust wool knit RC 27 lock rear GX, front N [ELECTRONIC as well] st.s 5, transfer all st to the front bed, lock rear GX, front N [ELECTRONIC as well] st.s 4 1/2, knit 1 R. Knit with pink wool st.s 5, stocking stitch [TECH 100] knit 4 R single bed Fairisle acc to diagram 2 R pink, 2 R lilac with

DECO punchcard. Put positioning pin to the right edge of the knitting, 2nd. positioning pin under nd 20 right, 3rd positioning pin under 21 left [with pattern sheet, TECH 176], knit R 16. Knit single Fairisle with col seq 2 R yellow, 2 R lilac RC 24, (DECO after RC 23 leave on left half of bed) [switch ELECTRONIC 6000 box off]. C = work in pocket as follows: break yarn at lock right, lock rear GX, front BX [LX] bring 34 pushers to working position as acc to pattern (all other pusher out of working position) knit 6 R lilac, st.s 4, knit 80 R yellow, break yarn. Connect DECO to lock again, [switch box on] knit single Fairisle [TECH 176] 2 R yellow 2 R lilac, st.s 5, knit RC 28. D = cont to knit stocking stitch [TECH 100] with yellow wool. E = shape right for sleeve, knit straight left. F = shape left for neck, knit straight right, cast off. For the right front, read in the DECO upside down, therefore with unprinted side uppermost.

Fig. III: Sleeves, knit 2

A = closed tubular cast on with yellow wool [cast on 8, cont to knit], knit RC 20, lock rear N, front CX [TECH 117] knit RC 14. With lilac wool lock rear GX, yellow wool lock rear N, front CX [TECH 117] knit RC 10. Knit with pink wool RC 19 as with lilac wool, transfer all st to front bed, lock rear GX, front N, knit 1 R. C = knit stocking stitch [TECH 100] with yellow wool, and inc on both sides. D = shape both sides for sleeve head, cast off.

Button facing: knit 2

Closed tubular cast on with yellow wool [cast on 8, cont to knit] over 96 nds, st.s 4 1/2, knit RC 14. In the 15th R, work in button holes over nds 39-36, 33-30 and 16-13 left of centre, and 2-5, 19-22, 36-39, 42-45 right of centre, knit RC 15, end with a few R of contrast yarn, release. Knit 2nd facing without button holes, knit RC 30.

Buttons: 3 pink, 2 each lilac and rust

Closed tubular cast on [cast on 8, cont to knit] over 7 nds on both beds, st.s 3 1/2, knit RC 20, end with a few R of contrast yarn, release.

Neckband:

Tubular cast on 1:1 [cast on 8, cont to knit] with rust wool over 120 nds, st.s 3, knit 20 R. Bring all nds into working position, with yellow wool lock rear GX, front N, st.s 4 1/2, knit 3 R, lock rear N, front GX, knit 8 R, 1 R lock rear and front N. With lilac wool lock rear and front CX, st.s 5, knit RC 20 [ELECTRONIC as well], end with a few R of contrast yarn, lock N/N, release.

To make up: Block parts to size and leave to dry under a damp cloth. With right sides together, sew shoulder seams. Sew neckband st by st to outside neck with backstitches through open loops and unravelling contrast yarn. Seam down on inside. Fold over 1:1 and seam down on inside. With right sides together, sew button and buttonhole facings st by st to front edge and unravelling contrast yarn. Seam down on inside. Lay sleeve up in fold and sew into sleeve hole. Sew sleeves and side seams. Cover and sew buttons.

Flashing figures:

8 = cont to knit stocking stitch

9 = work in pocket

10 = cont to knit stocking stitch

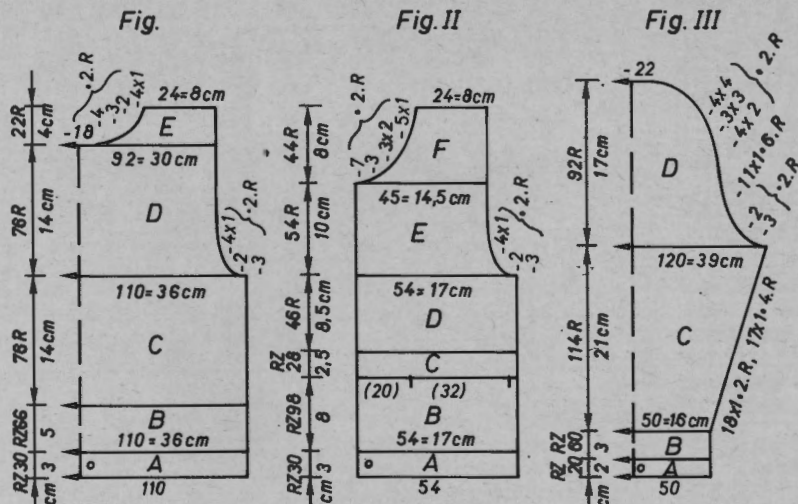

5921 DUOMATIC 80/S ELECTRONIC 6000

Girl's skirt for 5920

Model T. Roganova Russia

[Instructions for ELECTRONIC 6000 in square brackets]

Size: To fit 110 cm height

Material: 130 g yellow wool, 45 cm elastic 1 x 0.5 cm, 1 x 1.5 cm wide

Stitch size: Stocking stitch = 5 1/2

Test square: 100 st = 34 cm, 100 R = 18.5 cm

Pattern: Stocking stitch [TECH 100] Hem = tubular [cast on 8, cont to knit]

Fig.IV: Skirt part, knit 2

A = closed tubular cast on [cast on 8, cont to knit]. B = transfer all st to front bed, knit stocking stitch, [TECH 100], cast off.

Waistband: Closed tubular cast on [cast on 8, cont to knit] over 160 nds, st.s 4 1/2, lock rear GX, front N, knit 14 R, lock rear N, front GX, knit 13 R, lock rear and front N, knit 1 R, st.s 5, lock rear GX, front N, knit 6 R, lock rear N, front GX, knit 6 R, end with a few R of contrast yarn, release. [ELECTRONIC as well]

To make up: Block parts to size and leave to dry under a damp cloth. Sew one side seam with mattress stitch. Gather top of skirt and sew waist band st by st with backstitches through open loops to skirt and unravelling contrast yarn. Seam down on inside. Pull both elastic through and seam the second side.

Length per 100 g = 720 m

Fig.IV

92	104	116	128
98	110	122	134
74	74	74	74
136	136	136	136
.	.	.	A
.	.	.	B
171	174	176	179
62	65	68	73
.	.	.	**
195	195	195	195
.	.	.	C
135	135	135	135
129	129	129	129
38	38	38	38
171	174	176	179
62	65	68	73
.	.	.	**
20	22	24	27
26	28	30	33
.	.	.	***
0	0	0	0

Fig. IV

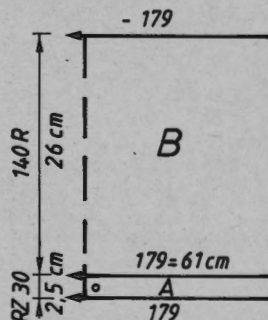
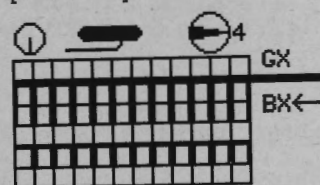
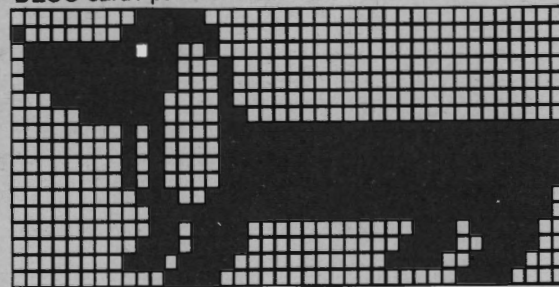

Diagram for single bed Fairisle [TECH 176]



DECO card / pattern sheet



5920

Fig.I

92	104	116	128
98	110	122	134
74	74	74	74
130	130	130	130
.	.	.	A
.	.	.	B
108	111	114	126
57	59	61	65
.	.	.	**
195	195	195	195
.	.	.	C
135	135	135	135
129	129	129	129
131	131	131	131
.	.	.	C
135	135	135	135
129	129	129	129
131	131	131	131
.	.	.	C
135	135	135	135
134	134	134	134
98	98	98	98
192	192	192	192
2	2	2	2
38	38	38	38
108	111	114	126
57	59	61	65
.	.	.	**
12	14	16	18
38	40	42	44
.	.	.	***
229	229	229	229
153	153	153	153
145	145	145	145
164	164	164	164
135	135	135	135
36	36	36	36
71	71	71	71
184	184	184	184
129	130	131	132
161	161	161	161
153	153	153	153
145	145	145	145
164	164	164	164
132	132	132	132
0	0	0	0

Fig.II

92	104	116	128
98	110	122	134
74	74	74	74
385	385	385	385
.	.	.	A
.	.	.	B
49	52	55	62
57	59	61	65
.	.	.	**
195	195	195	195
.	.	.	C
135	135	135	135
129	129	129	129
131	131	131	131
.	.	.	C
135	135	135	135
142	142	142	142
98	98	98	98
192	192	192	192
3	3	3	3
130	130	130	130
.	.	.	C
133	133	133	133
98	98	98	98
192	192	192	192
4	4	4	4
38	38	38	38
49	52	55	62
57	59	61	65
.	.	.	**
7	9	11	13
38	40	42	44
.	.	.	***
229	229	229	229
153	153	153	153
145	145	145	145
164	164	164	164
135	135	135	135
36	36	36	36
71	71	71	71
184	184	184	184
129	130	131	132
161	161	161	161
153	153	153	153
145	145	145	145
164	164	164	164
173	179	179	179
135	173	173	173
6	135	135	135
0	6	6	6
0	0	0	0

Fig.III

92	104	116	128
98	110	122	134
74	74	74	74
130	130	130	130
.	.	.	A
.	.	.	B
46	49	52	55
3	3	3	3
3	3	3	3
194	194	194	194
.	.	.	C
133	133	133	133
131	195	131	131
.	.	.	C
135	135	135	135
129	129	129	129
98	98	98	98
192	192	192	192
2	2	2	2
38	38	38	38
117	120	123	126
38	39	40	41
.	.	.	**
14	20	23	27
32	39	42	46
.	.	.	***
108	108	108	108
131	131	131	131
153	153	153	153
.	.	.	**
145	145	145	145
191	191	191	191
132	132	132	132
23	26	26	26
188	188	188	188
129	129	129	129
187	187	187	187
130	130	130	130
188	188	188	188
137	137	137	137
0	0	0	0

5907 DUOMATIC 80 ELECTRONIC 6000

Child's dress

Model T. Roganova Russia

[Instructions for ELECTRONIC 6000 in square brackets]

Size: To fit 116 cm height

Material: Wool, rust and orange 115 g each; wool yellow, pale yellow, pale lilac, dark lilac, rose, pink, apricot and caramel 15 g each; 1 15 cm zip

Stitch size: Stocking stitch = 5

Test square: Long stitch Fig. I + II : 100 st (counted on front bed) = 37 cm, RC 100 = 12.5 cm.

Pattern: Long st (Fig. I + II) according to diagram 1 [TECH 117] Single bed Fairisle (Fig. IV) acc to diagram 3 and colour sequence with self-punched DECO cards [self-drawn pattern sheet, TECH 176]

Fig.I: Back, knit two reversed parts

A = closed cast on with contrast yarn for tubular [cast on 8, cont to knit]. Cont to knit with two strands. B = Cont to knit with long st acc to diagram 1 [TECH 117]. C = shape left for neck, knit straight right, cast off.

Fig.II: Front

A = closed cast on with contrast yarn for tubular [cast on 8, cont to knit]. Cont to knit with two strands. B = Cont to knit with long st acc to diagram 1 [TECH 117]. C = divide work, cast off centre st, place left half onto decker combs. Cont to knit right half, and shape left for neck, cast off. Put left part back onto the same nds as before and finish knitting with reversed shape.

Fig.III: Sleeves knit two

A = simple cast on with contrast yarn for stocking st [cast on 7]. Cont to knit in following col seq, after every 10 R rust 2 R any decorative colour. B = inc right for Sleeve head, knit straight left. C = cont to knit straight. D = shape right for sleeve, knit straight right sleeve hole, knit straight left. E = knit straight, end with a few R of contrast yarn, release.

Fig.IV: Skirt

A = simple cast on with contrast yarn for stocking st [cast on 7]. Knit 2 R with pale lilac wool acc to diagram 2, but rear lock GX [ELECTRONIC the same]. Knit with two strand 2 R rust and orange wool single bed Fairisle acc to diagram 3 and col seq, knit 2 R wool pale lilac with DECO punchcard [with pattern sheet, TECH 176, POSITION = ENT, TO.R/TO.L - - - 32, ↔ REP. ST = NO]. 1st positioning pin at right of knitting, 2nd positioning pin under nds 20 at left, knit in col seq RC 44 2 R with pale lilac wool acc to diagram 2, but rear lock GX [ELECTRONIC the same]. B = knit 1 R, from the right hand side, move 90 pushers out of working position, knit 2 R, bring pushers acc to the pattern in working position. C = From the right hand side, move pushers out of working position acc to pattern. Repeat section A, B + C 13 times with the col rose, yellow, pink, pale yellow, apricot, pink, pale lilac, pink, pale yellow, apricot, pink, pale yellow, pale lilac, end with a few R of contrast yarn, cast off.

Fig.V: Collar

A = closed cast on with caramel wool for tubular [cast on 8, cont to knit]. B = knit 1 R with caramel wool, the from right hand side, move 35 pushers out of working position, knit 2 R, then acc to pattern bring pushers into working position. C = knit with pale yellow wool, and move pushers acc to pattern out of working position. D = knit sections B, C, + D 13 times acc to diagram 2, and between section B and C change to the following col: rose, pale lilac, yellow, pink, dark lilac, caramel, yellow, dark lilac, pink, caramel, rose, dark lilac, caramel. On completion, instead of D, hang tubular st forwards, knit 12 R stocking st, end with a few R of contrast yarn, release.

Neckband: closed cast on with rust wool for tubular [cast on 8, cont to knit] over 74 nds, st.s 4, knit RC 11, 1 R lock rear and front N. St.s 5, 3 R lock rear GX, front N, 8 R lock rear N front GX, 1 R lock rear and front N. Lock rear and front CX, knit RC 12, end with a few R of contrast yarn, release. [ELECTRONIC the same]

Cuff: knit as for neckband, but with two pin tucks and over 40 nds.

To make up: Block parts to size and leave to dry under a damp cloth. Sew shoulder seams. Gather top part of skirt. Sew back and front st by st to skirt with backstitches through open loops and unravelling contrast yarn, hem down on inside. Seam skirt with mattress stitches and unravelling contrast yarn. Seam shoulders. Lay collar on the inside of neck and seam. Sew neckband st by st to collar and neck with backstitches through open loops and unravelling contrast yarn, hem down on inside. Gather sleeves, sew cuff st by st to sleeve with backstitches through open loops and unravelling contrast yarn, hem down on inside. With right sides together, sew sleeves to back and front. Sew zip in back. Sew coloured tassels to collar.

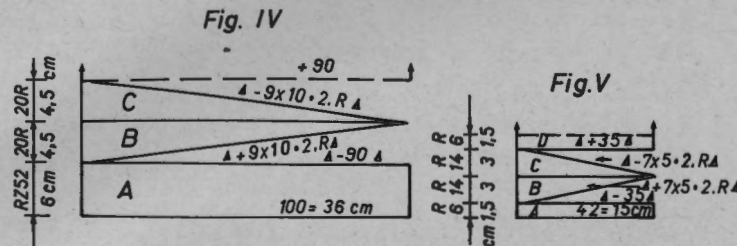
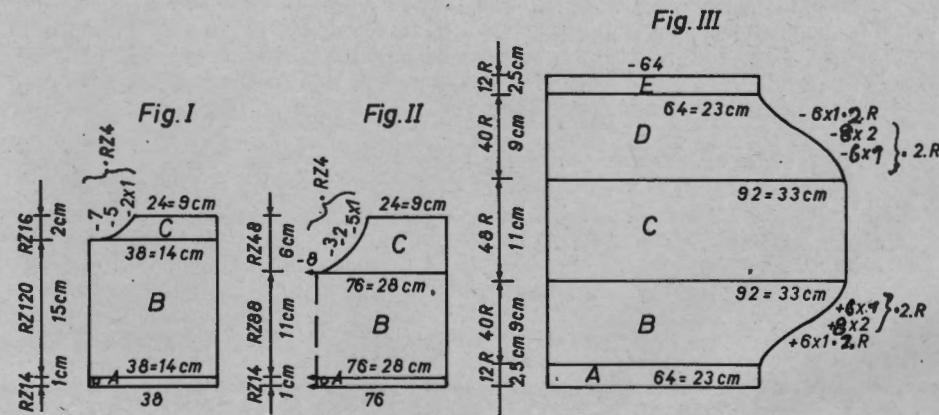

5907

Diagram 1: for long stitches

[TECH 117]

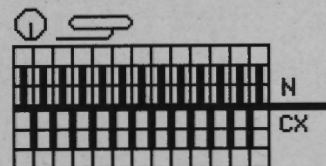

Diagram 2: Edge

[ELECTRONIC the same]

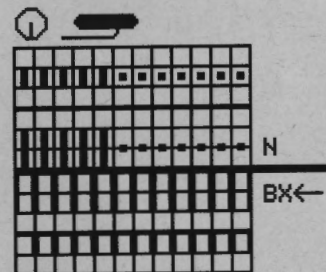
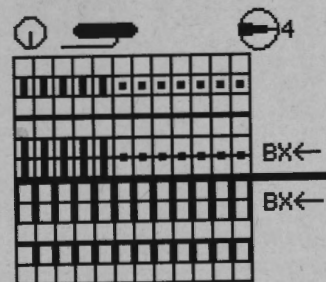

Diagram 3: single bed Fairisle

[TECH 176 but on rear bed acc to diagram]



DECO card / pattern sheet

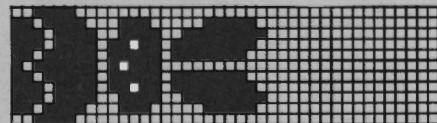

	Fig.I				Fig.II				Fig.III				Fig.IV				Fig.V	
	092	104	116	128	092	104	116	128	104	116	128	92	092	104	116	128	092/128	
1	50	50	50	50	50	50	50	50	90	90	90	90	90	90	90	90	85	80
2	403	403	403	403	148	148	148	148	144	144	144	144	144	144	144	144	142	142
3	.	.	.	A	.	.	.	A	A	.	A
4	.	.	.	B	.	.	.	B	B	.	B
5	32	35	38	41	70	73	76	81	53	64	72	39	78	89	100	114	42	42
6	56	58	60	64	56	58	60	64	31	35	40	25	42	48	54	61	3	3
7	.	.	.	**	.	.	.	**	.	.	.	**	.	.	.	**	3	3
8	195	195	195	195	195	195	195	195	97	97	97	97	38	38	38	38	194	194
9	.	.	.	C	.	.	.	C	134	134	134	134	78	89	100	114	.	C
10	135	135	135	135	135	135	135	135	66	66	66	66	42	48	54	61	132	133
11	129	129	129	129	129	129	129	129	135	135	135	135	.	.	.	**	78	78
12	166	166	166	166	166	166	166	166	57	57	59	55	6	6	6	6	130	130
13	32	35	38	41	70	73	76	81	79	79	79	79	3	3	3	3	191	191
14	56	58	60	64	56	58	60	64	34	34	34	34	3	3	3	3	156	156
15	.	.	.	**	.	.	.	**	49	49	49	49	66	66	66	66	128	128
16	13	15	17	19	13	15	17	19	33	33	33	33	135	135	135	135	63	63
17	3	3	3	3	3	3	3	3	17	17	17	17	11	13	13	15	156	156
18	3	3	3	3	3	3	3	3	63	63	63	63	75	75	75	75	128	128
19	67	67	68	69	71	71	71	71	133	133	135	133	184	184	184	184	133	133
20	188	178	186	186	144	152	160	168	136	136	136	136	189	197	211	225	191	191
21	131	170	128	129	154	154	154	154	135	135	135	135	63	63	63	63	156	156
22	148	148	170	170	146	146	146	146	15	17	19	15	189	197	211	225	128	128
23	0	0	148	188	175	175	175	175	191	191	191	191	2	3	3	4	120	120
24	.	.	0	149	3	3	3	3	133	133	135	133	191	191	191	191	66	2
25	.	.	0		135	135	135	135	136	136	136	136	189	197	211	225	156	156
26	.	.	.		3	3	3	3	145	145	145	145	1	2	2	3	66	66
	.	.	.		0	0	0	0	161	161	161	161	120	120	248	120	135	135
	.	.	.						177	177	177	177	2	2	2	2	21	21
	.	.	.						65	65	65	65	189	197	211	225	0	0
	.	.	.						134	134	134	134	0	0	0	0		
	.	.	.						66	66	66	66						
	.	.	.						162	162	162	162						
	.	.	.						132	132	132	132						
	.	.	.						0	0	0	0						

Length per 100 g =

Wool rust and orange 900 m

Wool yellow, pale yellow, pale lilac, rose, pink, apricot, dark lilac,

caramel 720 m

5911 ELECTRONIC 6000

Lady's jacket 2 colour Fairisle CREATION 6

Model Ruth M. Hagan, USA

Size: To fit 92 - 96 cm bust

Material: 420 g cotton white, 460 g cotton black. Shoulder pads

Stitch size: 2 colour Fairisle = 4 1/2. Hem = 3 3/4

Test square: 100 st (counted on front bed) = 31 cm. RC 100 = 8.5 cm

Pattern: Read domino pattern in as follows: pattern A = RC 1-60 pattern sheet 1 with continuation 2 + 3, ALTER = ENT, \hookrightarrow . TECH 180. Pattern B = RC 160-320 pattern sheet 4 with continuation 5 + 6, ALTER = ENT, \hookrightarrow . TECH 180. Pattern C = RC 360-464 pattern sheet 7 with continuation 8 + 9, ALTER = ENT, \hookrightarrow . TECH 180. For edging pattern, pattern sheet 10 with continuation 11 + 12. For front move pattern 39 nds to the right or left

Fig.I: Back

A = cast on 8 with white cotton, cont to knit. B = knit with domino pattern, TECH 180. C = divide work, cast off centre st (if you knit without FORM program, make a note of the electronic row counter), place left half onto decker combs. Cont to knit right half, and shape left for neck, cast off. Put left part back onto the same nds as before and finish knitting with reversed shape.

Fig.II: Front, knit two reversed shapes

A = cast on 8 with white cotton, cont to knit. B = knit with domino pattern, TECH 180. C = cont to knit with pattern, and shape left for neck, cast off.

Fig.III: Sleeves, knit 2

A = cast on 2 with white cotton, knit with domino pattern, TECH 180, and inc on both sides, cast off.

Edging: cast on 2 with white cotton over 32 nds on front bed, knit with edging pattern, TECH 180, RC 2016, cast off.

To make up: Block parts to size and leave to dry under a damp cloth. Sew shoulder seams. Sew edging to neck and front edge, sew plain Fairisle to the inside. With right sides together, sew sleeves to back and front part. Sew sleeves and side seams with mattress stitch.

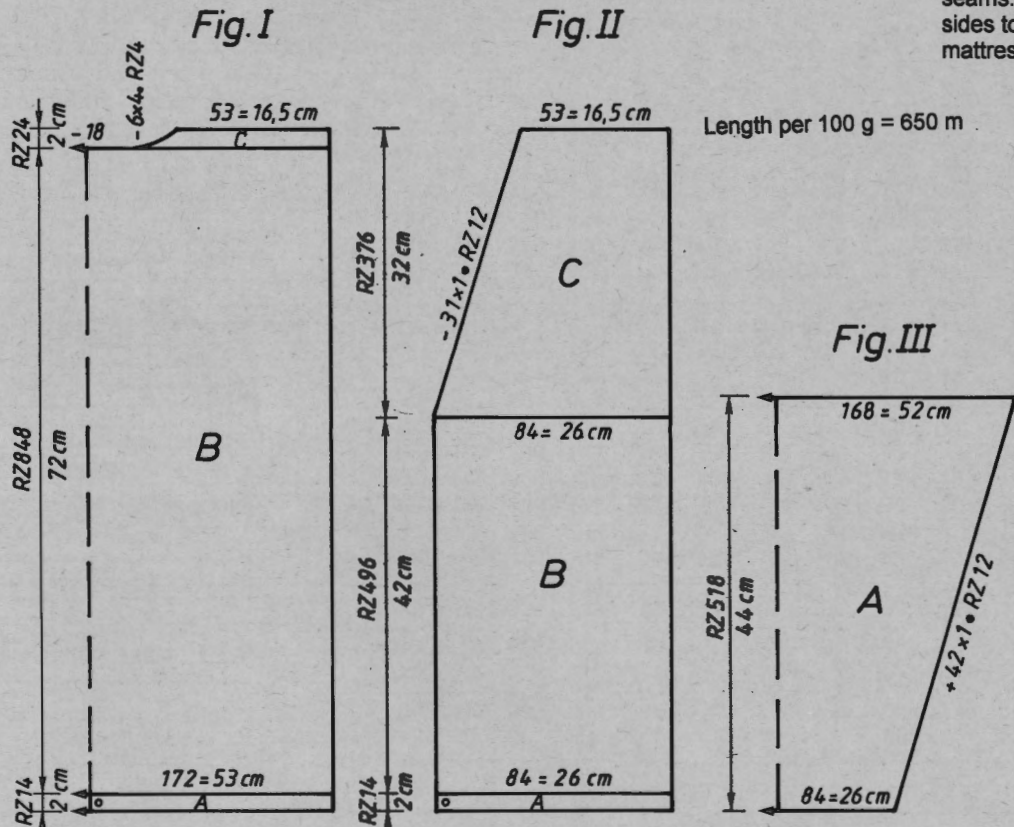

Length per 100 g = 650 m

	Fig.I			Fig.II			Fig.III		
	34/3638/4042/44			34/3638/4042/44			34/3636/3842/44		
1	34	34	34	34	34	34	34	34	34
2	124	124	124	379	379	379	124	124	124
3	A	.	.	A
4	B	.	.	B
5	158	171	184
6	82	90	98	77	84	90	81	84	87
7	.	.	.	82	90	98	3	3	3
8	195	195	195	.	.	**	3	3	3
9	.	.	.	195	195	195	38	38	38
10	135	135	135	.	.	C	165	168	171
11	133	133	133	135	135	135	51	52	53
12	166	166	166	133	133	133	.	.	**
13	158	171	184	166	166	166	43	43	43
14	82	90	98	77	84	90	58	59	60
15	.	.	.	82	90	98	.	.	***
16	74	74	74	.	.	**	97	97	97
17	76	76	76	74	74	74	132	132	132
18	.	.	.	76	76	76	0	0	0
19	69	69	69	.	.	***	.	.	.
20	184	184	184	68	68	68	.	.	.
21	129	130	131	191	191	191	.	.	.
22	191	191	191	151	152	153	.	.	.
23	145	145	145	255	255	255	.	.	.
24	5	5	5	182	182	182	.	.	.
25	0	0	0	0	0	0	.	.	.

5911

Pattern sheet 2

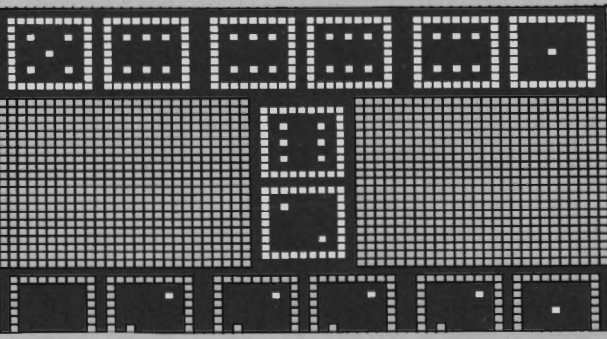

Pattern sheet 4

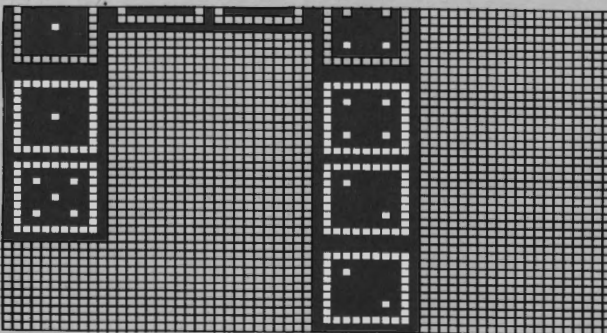

Pattern sheet 6

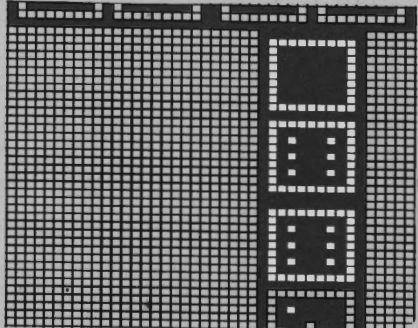

Pattern sheet 8

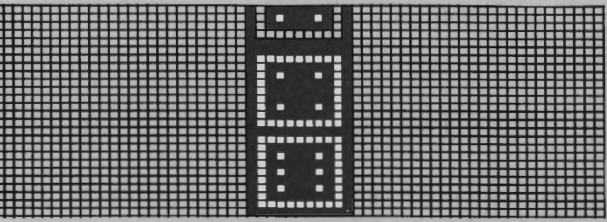

Pattern sheet 10

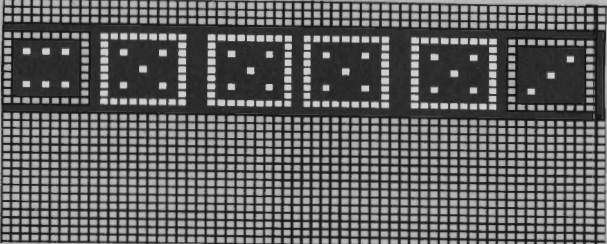

Pattern sheet 12

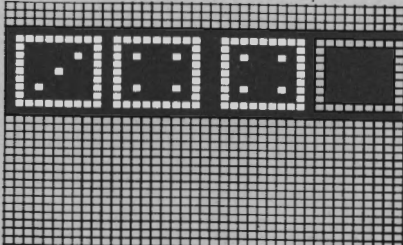

Pattern sheet 1

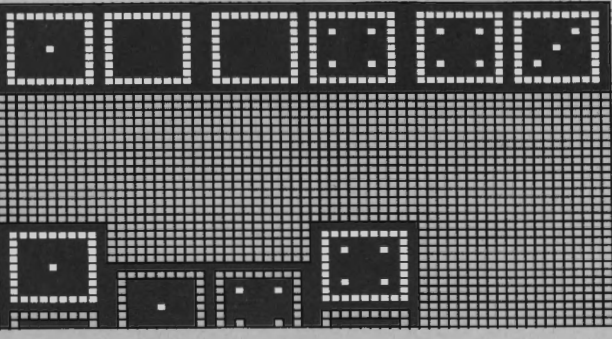

Pattern sheet 3

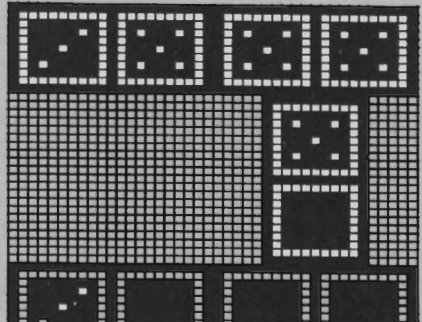

Pattern sheet 5

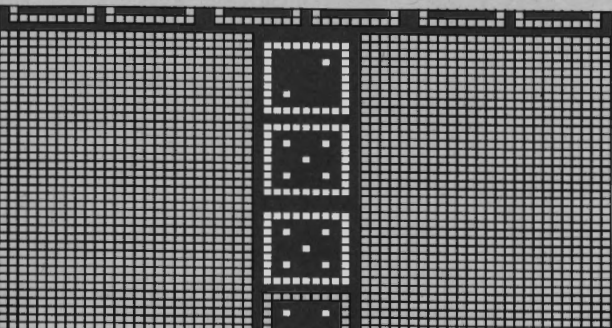

Pattern sheet 7

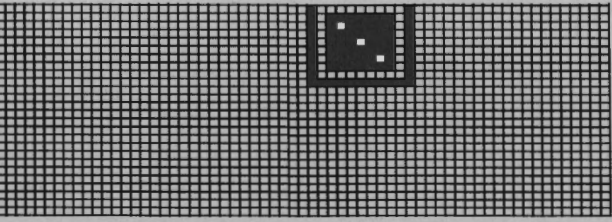

Pattern sheet 9

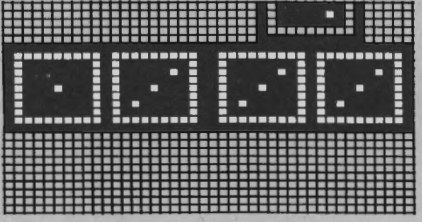

Pattern sheet 11

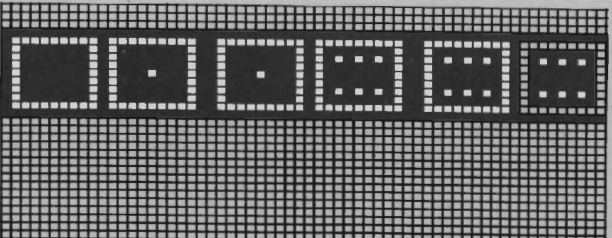

5913 DUOMATIC 80 ELECTRONIC 6000

ALTER = ENT, $c \rightarrow n$, ADD pattern sheet 9 with continuation 10, ALTER = ENT, $c \rightarrow n$, 3.COL = ENT, ADD pattern sheet 11 with continuation 12, ALTER = ENT, $c \rightarrow n$, 4.COL = ENT, TECH 207, ENLARGE POSITION = ENT, \uparrow REP.R = NO, \leftrightarrow REP.ST = NO
3 col Fairisle according to diagram and colour sequence with self-punched DECO cards [with self-drawn pattern sheets: read in pattern sheet 14, ADD pattern sheet 15, 3.COL = ENT, TECH 197, ENLARGE POSITION = ENT, \uparrow REP.R = NO; \leftrightarrow REP.ST = NO]

Lady's jacket Red Indian

Model Rita Ehrhart USA

Length per 100 g = 720 m

[Instructions for ELECTRONIC 6000 in square brackets]

Size: To fit 88 - 92 cm bust

Material: 500 g grey wool, 250 g dark lilac wool, 150 g pale lilac wool, 100 g black wool, 50 g red wool, 25 g green wool

Stitch size: Pattern = 6, Hem = 5, border and neckband = 4 1/2

Test square: 4 colour Fairisle : 100 m (counted on front bed) = 35 cm, RC 100 = 9.5 cm. 3 colour Fairisle: 100 m (counted on front bed) = 32 cm, RC 100 = 11.5 cm

Pattern: 4 colour Fairisle according to diagram and colour sequence with self-punched DECO cards (looks a bit different than the picture) [Pattern A : with self-drawn pattern sheets, read in pattern 1 with continuation 2, ALTER = ENT, $c \rightarrow n$, ADD pattern sheet 3 with continuation 4, ALTER = ENT, $c \rightarrow n$, 3.COL = ENT, ADD pattern sheet 5 with continuation 6, ALTER = ENT, $c \rightarrow n$, 4.COL = ENT, TECH 207]. Pattern B : read in pattern sheet 7 with continuation 8,

Fig.I: Back

A = closed cast on for tubular [cast on 8, cont to knit]. B = with 4 col Fairisle acc to diagram 1 and col seq with DECO punchcards, put reader on needle 40 right of centre. Put 1st position pin to the right of the knitting, 2nd positioning pin under nd 60, 3rd positioning pin under nd 20 right of centre, 4th positioning pin under nd 20, 5th positioning pin under nd 60 left of centre, [with pattern sheet pattern A, knit RC 320, cont to knit with pattern B, TECH 207], cast off.

Fig.II: Front knit two reversed shapes

A = closed cast on for tubular [cast on 8, cont to knit]. B = with 4 col Fairisle acc to diagram 1 and col seq with DECO punchcards, put reader on needle 40 right of centre. Put 1st position pin to the right of the knitting, 2nd positioning pin under nd 20 right of centre, 3rd positioning pin under nd 21 left of centre, [with pattern sheet 1, ALTER = ENT, ADD pattern sheet 3, ALTER = ENT, $c \rightarrow n$, 3.COL = ENT, ADD pattern sheet 5, ALTER = ENT, $c \rightarrow n$, 4.COL = ENT, TECH 207, knit RC 320, then pattern sheet 7, ALTER = ENT, $c \rightarrow n$, ADD pattern sheet 9, ALTER = ENT, $c \rightarrow n$, 3.COL = ENT, ADD pattern sheet 11, ALTER = ENT, $c \rightarrow n$, 4.COL = ENT, TECH 207, Knit second front with patter sheets 2,4,6,8,10, 12. C = shape left for neck, knit straight right, cast off.

Fig.III: Sleeves knit 2

A = tubular cast on for K/K [cast on 2], 3 col Fairisle acc to diagram and col seq with DECO punchcards. Put 1st position pin to the right of the knitting, 2nd positioning pin under nd 20 right, 3rd positioning pin under nd 20 left, [with pattern sheets, TECH

Fig.I

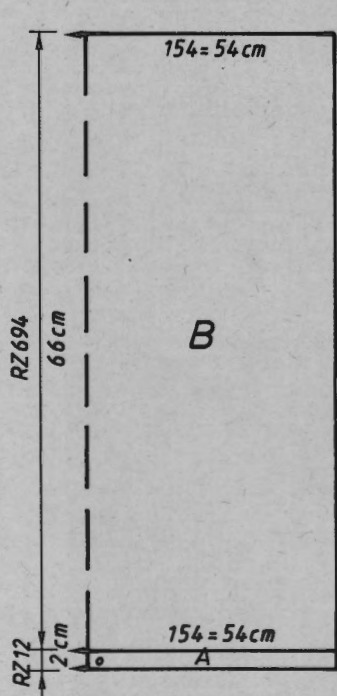

Fig.II

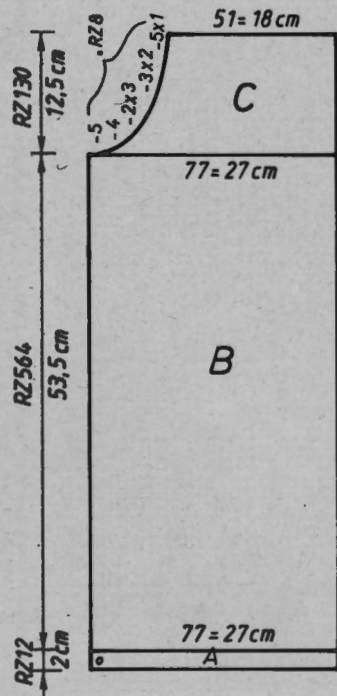

Fig.III

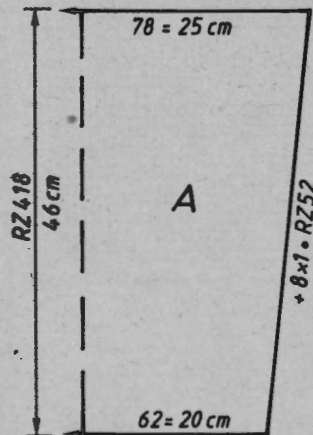

Diagram 1 for 4 colour Fairisle
TECH 207

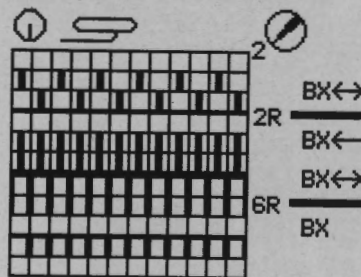

Diagram 2 for 3 colour Fairisle
TECH 197

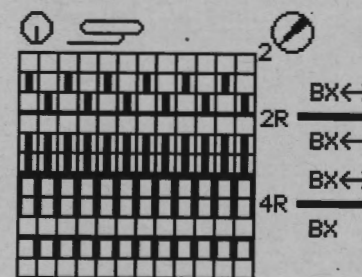

	Fig.I			Fig.II			Fig.III		
	34/3638/4042/44			34/3638/4042/44			34/3638/4042/44		
1	38	38	38	38	38	38	46	46	46
2	140	140	140	395	395	395	128	128	128
3	.	.	A	.	.	A	.	.	A
4	.	.	B	.	.	B	.	.	B
5	143	154	166	71	77	83	122	125	128
6	82	90	98	82	90	98	3	3	3
7	.	.	**	.	.	**	3	3	3
8	195	195	195	195	195	195	38	38	38
9	.	.	C	.	.	C	153	156	159
10	135	135	135	135	135	135	49	50	51
11	131	131	131	131	131	131	.	.	**
12	38	38	38	166	166	166	45	45	45
13	143	154	166	71	77	83	58	59	60
14	82	90	98	82	90	98	.	.	***
15	.	.	**	.	.	**	97	97	97
16	66	66	66	66	66	66	132	132	132
17	68	68	86	68	68	68	0	0	0
18	.	.	***	.	.	***	.	.	.
19	0	0	0	74	74	74	.	.	.
20	.	.	.	160	168	176	.	.	.
21	.	.	.	164	164	164	.	.	.
22	.	.	.	183	183	183	.	.	.
23	.	.	.	1	1	1	.	.	.
24	.	.	.	183	183	183	.	.	.
25	.	.	.	5	5	5	.	.	.
26	.	.	.	175	175	175	.	.	.
27	.	.	.	13	13	13	.	.	.
28	.	.	.	135	135	135	.	.	.
29	.	.	.	14	14	14	.	.	.
30	.	.	.	0	0	0	.	.	.

Colour sequence for 3 colour Fairisle

2 R grey
2 R pale lilac
2 R dark lilac

Colour sequence for 4 colour Fairisle

RC 0-200 2R grey
2R red
2R black
2R dark lilac
RC 201-208 2R grey
2R red
2 R black
2R pale lilac
RC 209-400 2R grey
2R white
2R black
2R pale lilac
RC 401-464 2R grey
2R white
2R black
2R red
RC 465-480 2R grey
2R pale lilac
2R black
2R dark lilac
RC 481-560 2R grey
2R green
2R black
2R dark lilac
RC 561-694 2R grey
2R pale lilac
2R black
2R dark lilac

To make up: Block parts to size and leave to dry under a damp cloth. Sew shoulder seams. Sew neckband st by st to neck with backstitches through open loops and unravelling contrast yarn. Hem down on inside. With right sides together, sew front edging to front. With right sides together, sew cuff to sleeve. With right sides together, sew sleeves to back and front. Sew sleeves and side seams with mattress stitch.

DECO card 2, 3 col

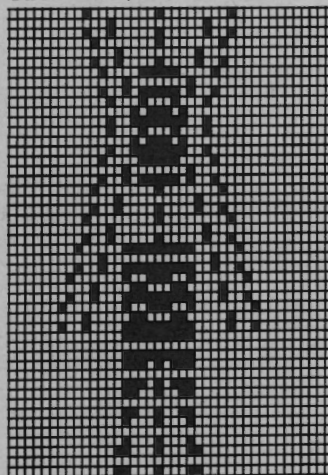

DECO card 7, 4 col

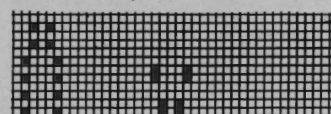

DECO card 4, 3 col

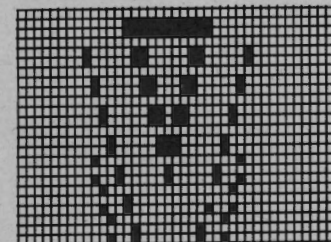

DECO card 1, 3 col

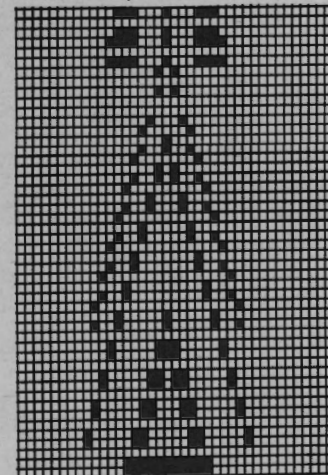

DECO card 3, 3 col

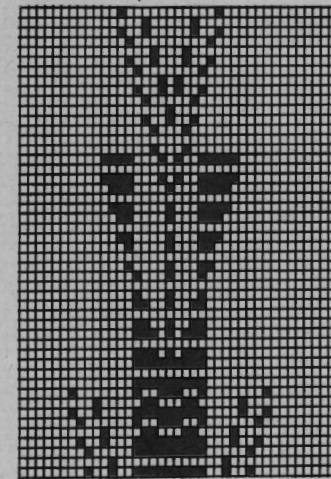

197, POSITION = ENT, ↔ REP.ST = NO] cont to knit, inc on both sides, release.

Sleeve cuff: cast on tubular with dark lilac wool for 1:1 [cast on 1, cont to knit] over 74 nds, st.s 4 1/2, knit 12 R, knit 6 R with pale lilac wool, knit 16 R with dark lilac wool, end with a few R of contrast yarn, cast off.

Neckband: cast on tubular with dark lilac wool for 1:1 [cast on 1, cont to knit] over 140 nds, st.s 4 1/2, knit 28 R, knit 6 R with pale lilac wool, knit 6 R with dark lilac wool, lock rear and front N, knit 2 R, lock rear and front CX [ELECTRONIC as well] st.s 5 1/2, knit RC 10, end with a few R of contrast yarn, cast off.

Front edging: tubular cast on for K/K [cast on 2] over 16 nds on read bed and 15 nds on front bed. St.s 4 1/2, lock rear N, front CX [TECH 117] knit RC 540, cast off.

Pattern sheet 2

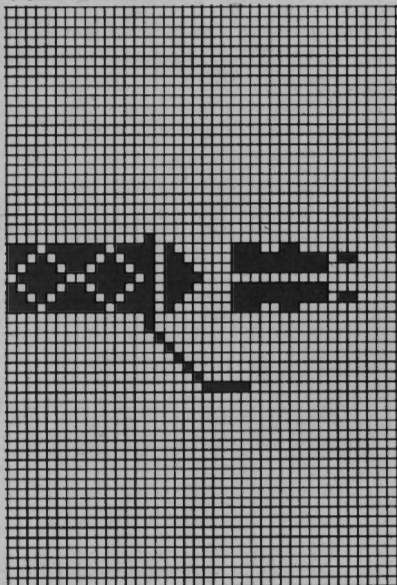

Pattern sheet 1

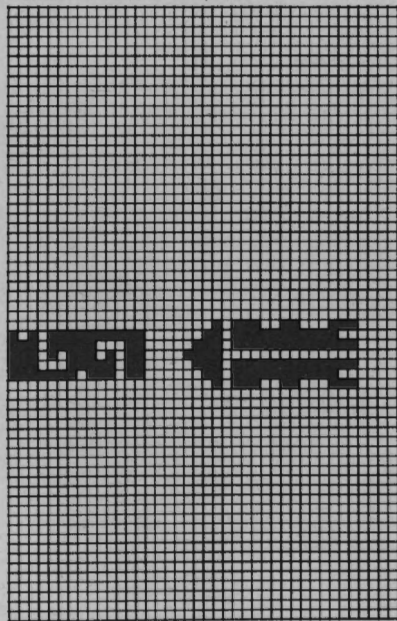

Pattern sheet 4

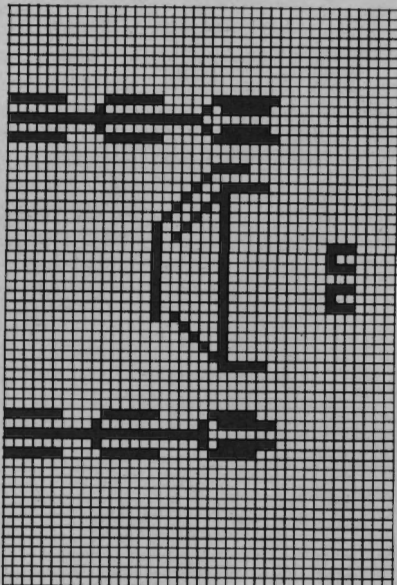

Pattern sheet 3

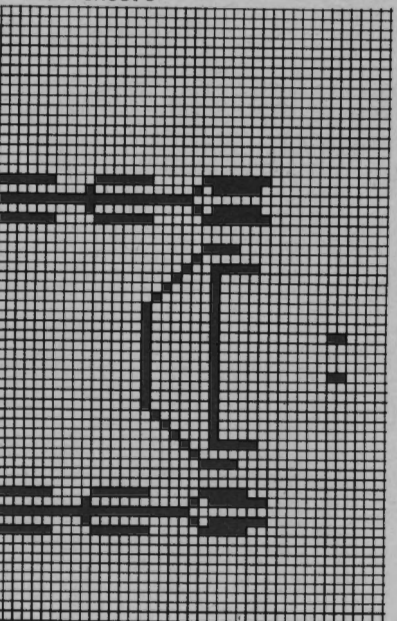

Pattern sheet 6

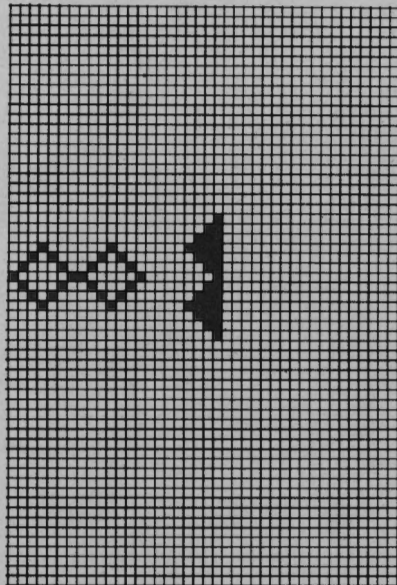

Pattern sheet 5

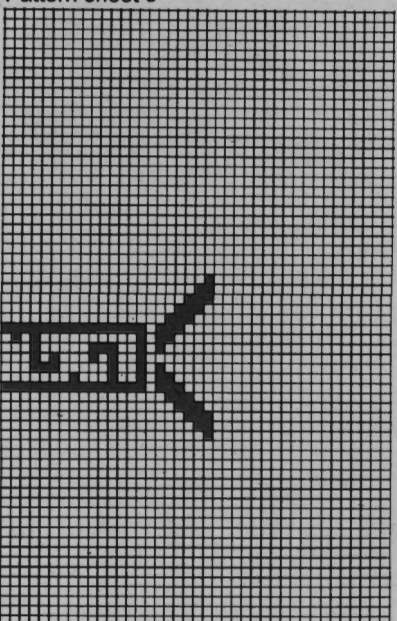

Pattern sheet 8

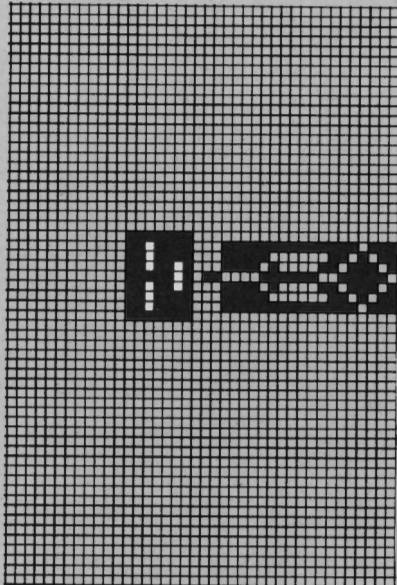

Pattern sheet 7

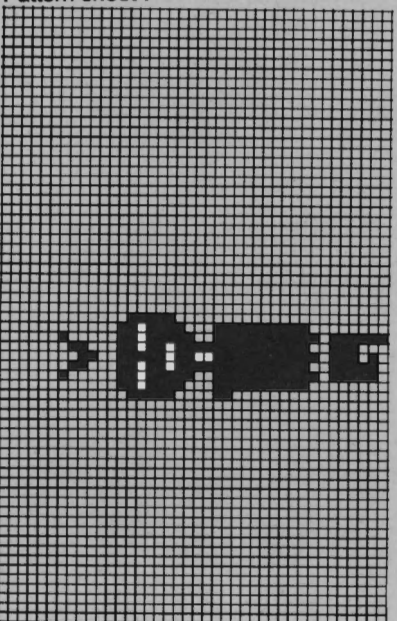

Pattern sheet 10

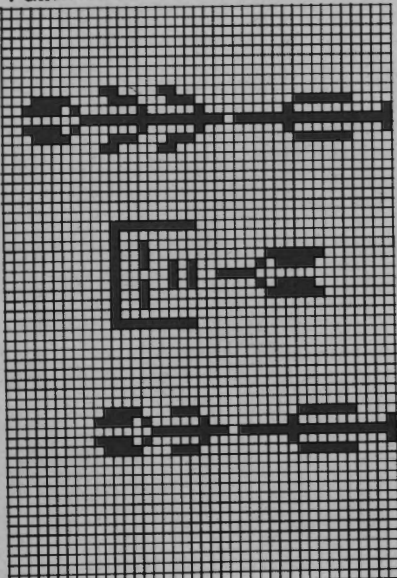

Pattern sheet 9

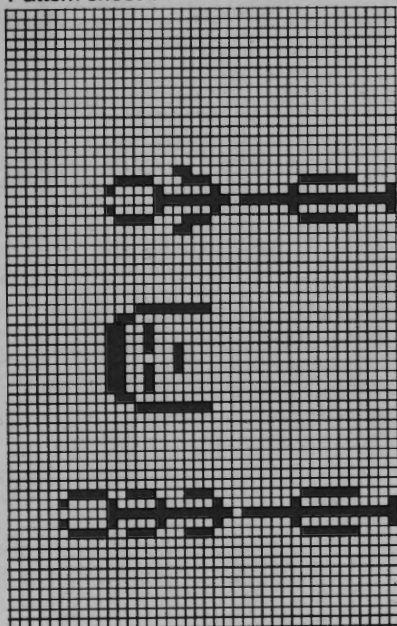

Pattern sheet 12

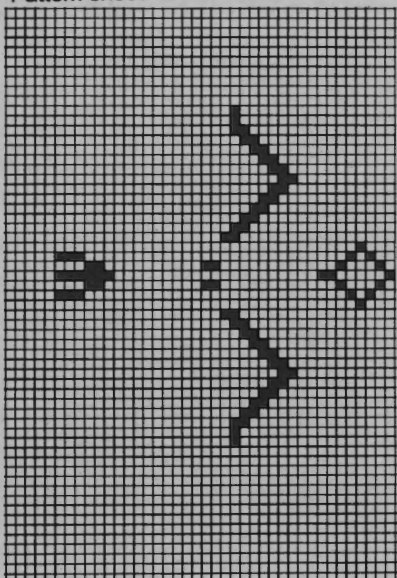

Pattern sheet 11

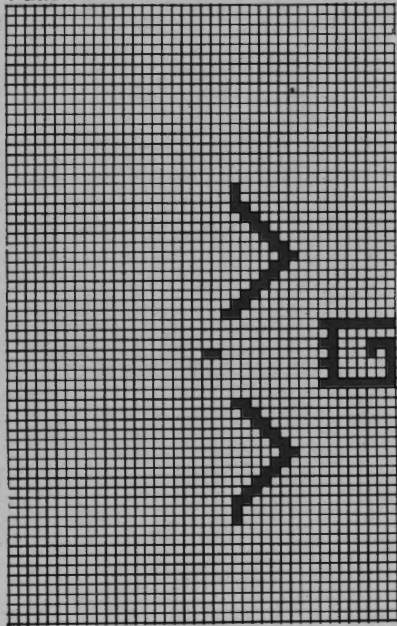

Pattern sheet 14

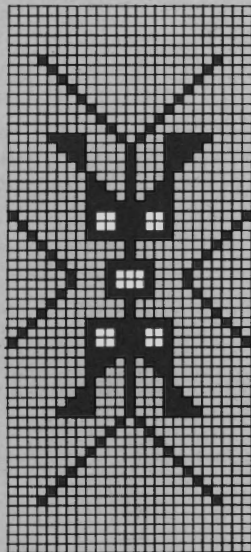

Pattern sheet 13

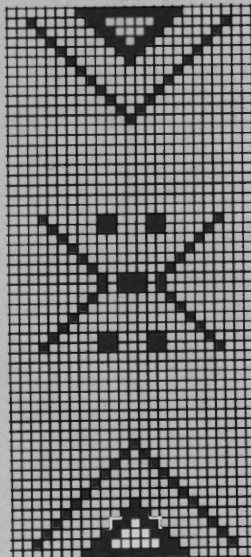

DECO card 3, 4 col

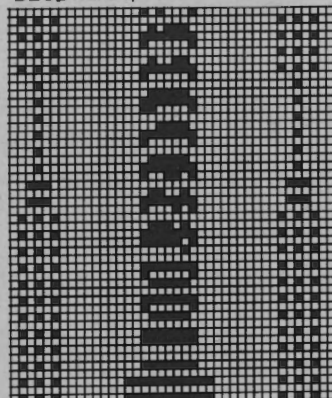

DECO card 2, 4 col

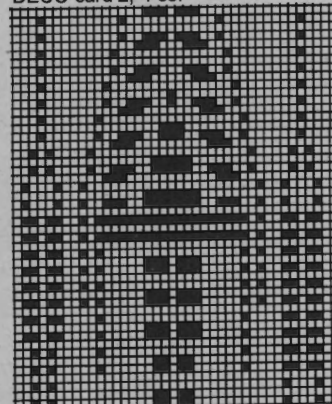

DECO card 1, 4 col

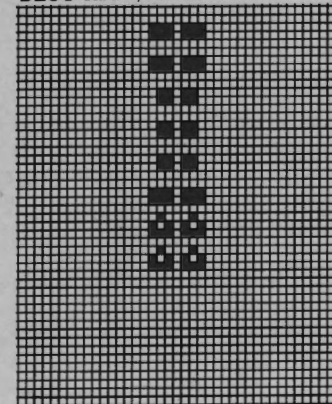

DECO card 6, 4 col

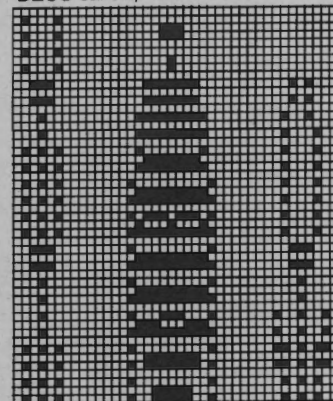

DECO card 5, 4 col

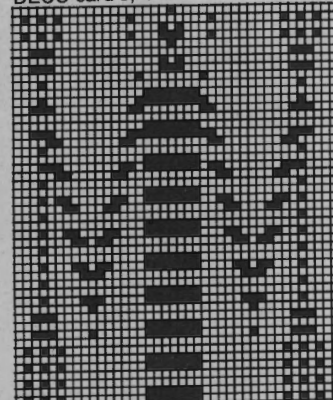

DECO card 4, 4 col

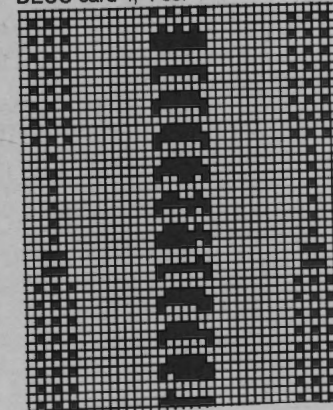

5914 DUOMATIC 80/S ELECTRONIC 6000

Men's pullover with tuck stitch pattern

Model Y. Wassmer, Arboldswil

[Instructions for ELECTRONIC 6000 in square brackets]

Size: To fit 92 - 98 cm chest

Material: 400 g anthracite wool (Blauband from Fröhlich) 300 g chappe silk blue (Gemma from Conofil) 3 buttons

Stitch size: Tuck stitch pattern = 5 3/4, band = 4 1/2, cuffs and neckband = 4.

Test square: 100 st = 35.5 cm, 100 R = 18 cm

Pattern: Tuck stitch pattern according to diagram and colour sequence with self-punched DECO cards [with self-drawn pattern sheet, TECH 131] band 2:2 [cast on 4, cont to knit]

Fig.I: Back

A = tubular cast on 2:2 with anthracite wool, [cast on 4, cont to knit] B = hang all st on front bed, knit with anthracite wool, lock rear GX, front N [ELECTRONIC as well] st.s 5 3/4 knit two R, cont to knit acc to diagram and col seq with DECO punchcard [with pattern sheet, TECH 131]. C = shape both sides for sleeves, cont to knit with

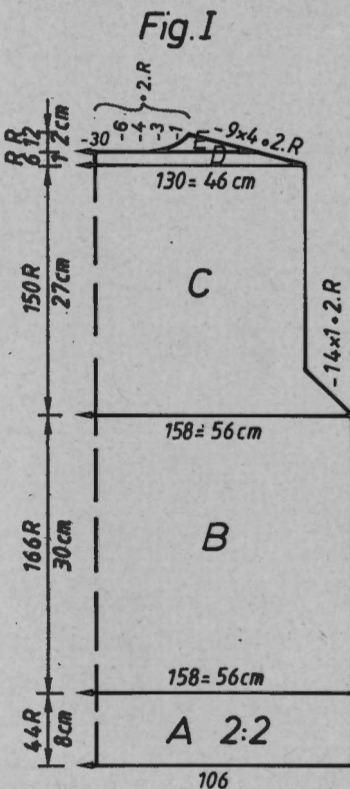

Fig. II

Length per 100 g:
Wool anthracite = 400 m
Silk blue = 330 m

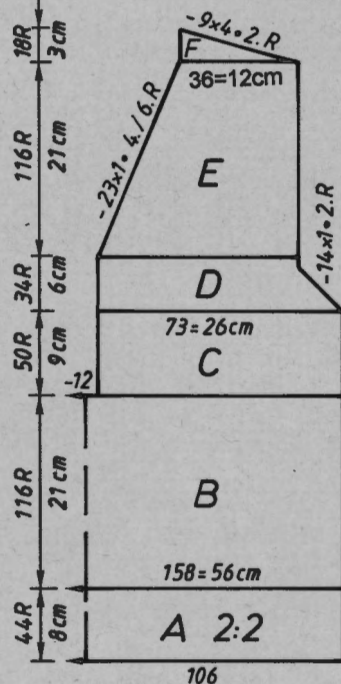
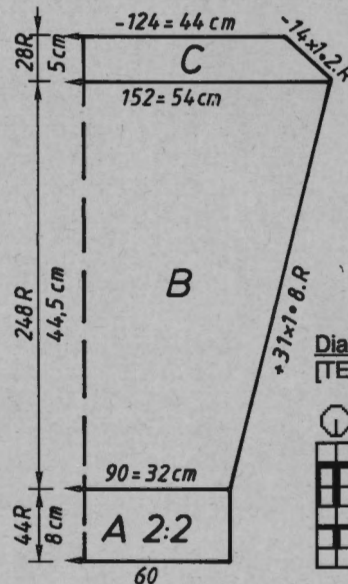

Fig. III



pattern. D = shape both sides for shoulder. E = divide work, cast off centre st (if you knit without FORM program, make a note of the electronic row counter), place left half onto decker combs. Cont to knit right half, and shape left for neck, cast off. Put left part back onto the same nds as before and finish knitting with reversed shape.

Fig.II: Front

Knit A + B as in Fig.I. But row count for B acc to pattern sheet. C = divide work, cast off centre st (if you knit without FORM program, make a note of the electronic row counter), place left half onto decker combs. Cont to knit right half. D = shape right for sleeve, knit left straight. E = knit right straight, shape left for neck. F = shape right for shoulder, cast off. Put left part back onto the same nds as before and finish knitting with reversed shape.

Fig.III: Sleeves knit 2

A = tubular cast on 2:2 with anthracite wool, [cast on 4, cont to knit] B = hang all st on front bed, knit with anthracite wool, lock rear GX, front N st.s 5 3/4 knit two R, [ELECTRONIC as well] cont to knit acc to diagram and col seq with DECO punchcard [with pattern sheet, TECH 131] and inc on both sides. C = shape both sides for sleeve head, cast off.

Neckband: knit 2

Tubular cast on for 2:2 with anthracite wool [cast on 4, cont to knit] over 170 nds, st.s 4 knit 15 R. Work a buttonhole to the right of centre over nds 69-73, 49-53 and 29-33. Knit 16 R. Bring empty nds on both beds into the working position, lock rear and front CX [ELECTRONIC as well] st.s 5, knit RC 8, end with a few R of contrast yarn, cast off.

Knit the second neckband as well, but without buttonholes.

To make up: Block parts to size and leave to dry under a damp cloth. Sew shoulder seams. Sew the neckband together at the back, the sew st by st to neck with backstitches through open loops and unravelling contrast yarn. Hem down on inside. With right sides together, sew sleeves to back and front. Sew sleeves and side seams with mattress stitch. Sew on buttons.

Diagram for tuck stitch pattern [TECH 131]

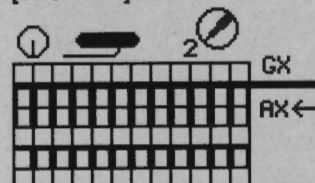

Colour Sequence:
2 R anthracite
2 R blue

5914

Fig.I	Fig.II	Fig.III
44/4648/5052/54	44/4648/5052/54	44/4648/5052/54
1	72 72 72	72 72 72
2	142 142 142	142 142 142
3	. . . A	. . . A
4	. . . B	. . . B
5	146 158 169	146 158 169
6	90 98 106	90 98 106
7	. . . **	. . . **
8	195 195 195	195 195 195
9	. . . C	. . . C
10	135 135 135	135 135 135
11	143 143 143	143 143 143
12	38 38 38	38 38 38
13	146 158 169	146 158 169
14	90 98 106	90 98 106
15	. . . **	. . . **
16	30 30 30	30 30 30
17	68 68 68	68 68 68
18	. . . ***	. . . ***
19	232 232 232	72 72 72
20	191 191 191	176 176 176
21	135 135 135	135 135 135
22	7 7 7	35 35 35
23	135 135 135	191 191 191
24	54 54 54	143 144 145
25	191 191 191	179 179 179
26	152 157 161	135 135 135
27	2 2 2	2 2 2
28	71 71 71	104 104 104
29	184 184 184	191 191 191
30	135 136 137	135 135 135
31	177 177 177	7 7 7
32	161 161 161	135 135 135
33	153 153 153	54 54 54
34	137 137 137	191 191 191
35	130 130 130	152 157 161
36	0 0 0	2 2 2
		0 0 0

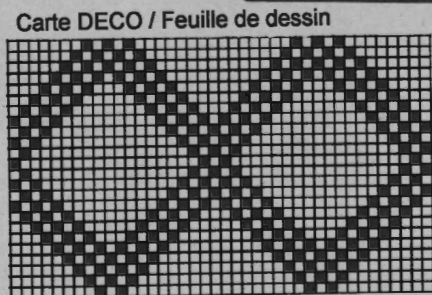

5937

Carte DECO / Feuille de dessin

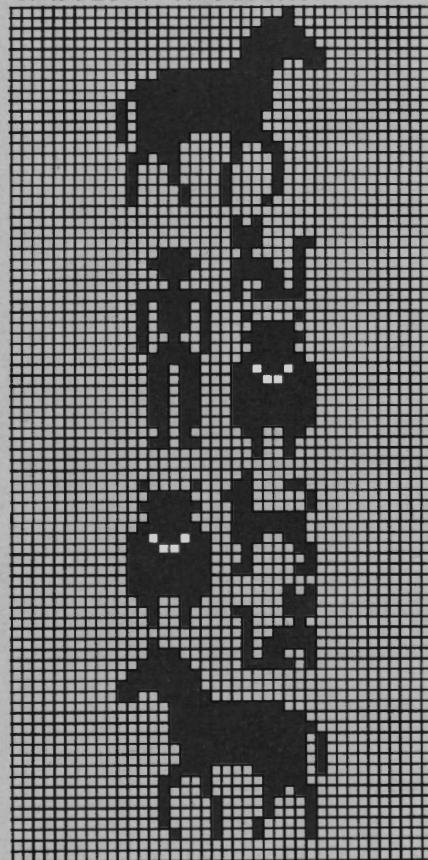

Colour sequence
2R bordeaux
2R green

Length per 100 g = 480 m

Tie: Ethno

[Instructions for ELECTRONIC 6000 in square brackets]

Size: Length 120 cm

Material: 35 g linen bordeaux, 25 g linen green (Figaro from Conofil)

Stitch size: Pattern = 4, tubular = 4 1/2

Test square: 2 colour Fairisle = 100 st (counted on front bed) = 40 cm, RC 100 = 16.5 cm

Pattern: 2 colour Fairisle according to diagram 1 and colour sequence with self-punched DECO cards [with self-drawn pattern sheets, TECH 183, POSITION = ENT, REP.R = NO, REP.ST = NO]. Plain Fairisle according to diagram 2 and colour sequence, tubular [TECH 107].

Tubular cast on with bordeaux linen [cast on 8] over 44 nds, st.s 4, acc diagram 1 and col seq with self-punched DECO cards, Put 1st positioning pin to the right of the knitting, 2nd positioning pin under nd 20 to the right of centre, 3rd positioning pin under nd 21 to the left of centre. [with pattern sheets, knit TECH 183]. Knit straight RC 308, shape both sides 6 x 1 st every RC 8. After RC 332 at the end knit plain Fairisle acc to diagram and col seq until RC 346. Transfer all st to the front bed, 2 R stocking stitch, then hang st for tubular, therefore release the outermost 8 st, on both sides, hang the outermost 8 st onto decker combs, and hang on the rear bed, so that the knitting forms a circle. St.s 4 1/2, lock rear and front CX [TECH 107] with bordeaux linen, knit RC 500, cast off.

Diagram 1 for 2-col Fairisle
[TECH 183]

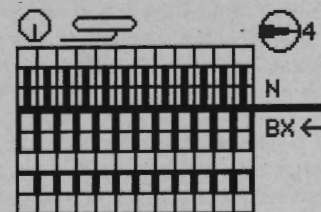
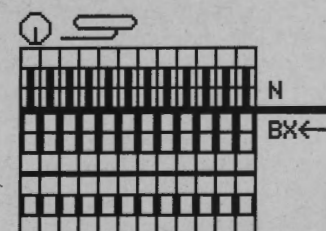

Diagram 2 for plain Fairisle
[TECH 183]



5912 DUOMATIC 80/S ELECTRONIC 6000

Men's pullover

[Instructions for ELECTRONIC 6000 in square brackets]

Size: To fit 96 - 100 cm chest

Material: 440 g wool white (Blauband from Fröhlich), 310 g black (Rotband from Fröhlich)

Stitch size: Pattern = back 4, front 5. Band and polo neck = 4

Test square: 100 st (counted on front bed) = 39 cm. RC 100 = 15 cm

Pattern: 2 colour Fairisle according to diagram and colour sequence with self-punch DECO cards [with self-drawn pattern sheet, TECH 183].
Band and polo neck = 2:2 [cast on 4, cont to knit]

Fig.I: Back

A = tubular cast on with white wool for 2:2 [cast on 4, cont to knit]. B = bring all nds into working position, cont to knit acc to diagram and col seq with DECO punchcard [with pattern sheet, TECH 183], cast off.

Fig.II: Front

A = tubular cast on with white wool for 2:2 [cast on 4, cont to knit]. B = bring all nds into working position, cont to knit acc to diagram and col seq with DECO punchcard [with pattern sheet, TECH 183]. C = divide work, cast off centre st (if you knit without

FORM program, make a note of the electronic row counter), place left half onto decker combs. Cont to knit right half, and shape left for neck, cast off. Put left part back onto the same nds as before and finish knitting with reversed shape.

Fig.III: Sleeves, knit 2

A = tubular cast on with white wool for 2:2 [cast on 4, cont to knit]. B = bring all nds into working position, cont to knit acc to diagram and col seq with DECO punchcard [with pattern sheet, TECH 183] and inc on both sides, cast off.

Turtle neck: Tubular cast on with white wool for 2:2 [cast on 4, cont to knit] over 150 nds. St.s 4, knit 60 R. Bring all nds into working position, hang the stitch loops on the adjacent empty nds, lock rear GX, front N, st.s 5, knit 6 R, lock rear N, front GX, st.s 5, knit 6 R, end with a few R of contrast yarn, cast off.

To make up: Block parts to size and leave to dry under a damp cloth. Sew shoulder seams. Sew turtle neck st by st to neck with backstitches through open loops and unravelling contrast yarn. Seam polo neck. With right sides together, sew sleeves to back and front. Sew sleeves and side seams with mattress stitch.

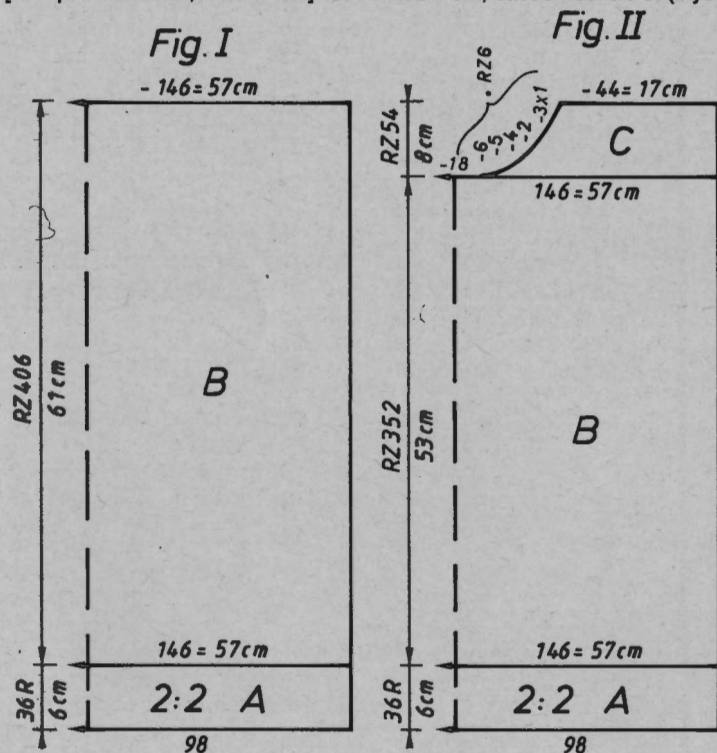

Length per 100 g =
Wool white 420 m
Wool black 540 m

Fig. III

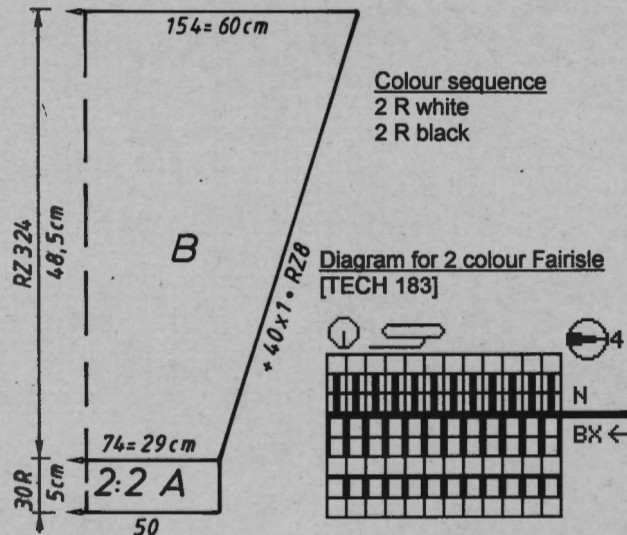

FORM program
see page 33

DECO card / pattern sheet

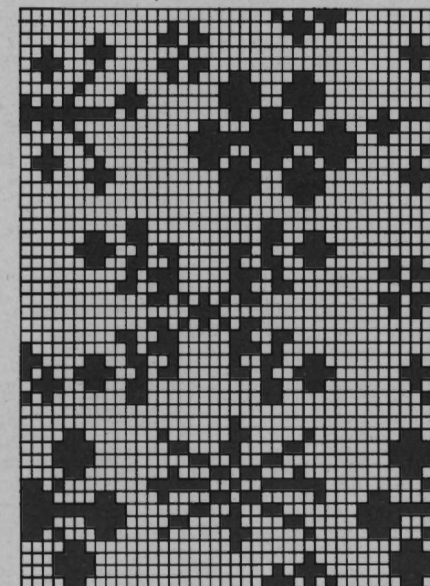

5916 ELECTRONIC 6000

Lady's jacket Tropical fish

Model Ruth M. Hagan USA

Size: To fit 92 - 96 cm bust

Material: 130 g wool/rayon black, 120 g rayon turquoise, 12 g wool/rayon green, 100 g cotton lilac, shoulder pads, 2 fasteners

Stitch size: 4 colour Fairisle = 4 1/2. Hem and neckband = 4

Test square: 100 st (counted on front bed) = 35.5 cm, RC 100 = 6.5 cm

Pattern: Read in pattern sheets as follows: For pattern A RC 1-320 pattern sheet 1 with continuation 2 + 3, ALTER = ENT, \curvearrowright , ADD, pattern sheet 4 with continuation 5 + 6, ALTER = ENT, \curvearrowright , 3.COL = ENT, ADD pattern sheet 7 with continuation 8 + 9, ALTER = ENT, \curvearrowright , 4.COL = ENT TECH 207. For pattern B RC 321-640 pattern sheet 10 with continuation 11 + 12, ALTER = ENT, \curvearrowright , ADD pattern sheet 13 with continuation 14 + 15, ALTER = ENT, \curvearrowright , 3.COL = ENT, ADD pattern sheet 16 with continuation 17 + 18, ALTER = ENT, \curvearrowright , 4.COL = ENT, TECH 207. For pattern C, RC 641-760 pattern sheet 19 with continuation 20 + 21, ALTER = ENT, \curvearrowright , ADD pattern sheet 22 with continuation 23 + 24, ALTER = ENT, \curvearrowright , 3.COL = ENT, ADD pattern sheet 25 with cont 26 + 27, ALTER = ENT, \curvearrowright , 4.COL = ENT, TECH 207. For front move the pattern either 24 nd to the left or right. Hem = cast on 2, cont to knit. Neckband = TECH 118.

Fig.I: Back

A = cast on 2 with black wool/rayon, cont to knit. B = knit tropical fish pattern A, TECH 207 to RC 320, then read in pattern B. C = cont to knit with pattern to RC 640, read in pattern C, cont to knit and shape both sides for sleeve hole. D = divide work, cast off centre st (if you knit without FORM program, make a note of the electronic row counter), place left half onto decker combs. Cont to knit right half, and shape right for shoulder left for neck, cast off. Put left part back onto the same nds as before and finish knitting with reversed shape.

Fig.II: Front, knit two reversed shapes

A = cast on 1 with black wool/rayon, cont to knit. B = knit tropical fish pattern A, TECH 207 as in Fig.I. C = cont to knit pattern as in Fig.I, shape left for neck. D = shape right for sleeve hole. E = shape right for shoulder.

Fig.III: Sleeves, knit 2

A = cast on 2 with black wool/rayon, cont to knit. B = knit tropical fish pattern, and inc on both sides. C = shape both sides for sleeve head, cast off. When patterns A, B and C are knitted, cont to knit with col seq plain Fairisle = TECH 207 but without pattern. **Neckband:** A = cast on 2 with black wool/rayon over 18 nds, TECH 118 interlock, st.s 4, knit RC 586, cast off.

To make up: Block parts to size and leave to dry under a damp cloth. Sew shoulder seams. Sew neckband to neck and front edge, seam down. With right sides together, sew sleeves to back and front. Sew sleeves and side seams with mattress stitch. Sew on fasteners.

Length per 100 g =
Wool/Rayon black 630
Rayon turquoise 600
Wool/Rayon green 470
Cotton lilac 600 -

Fig.I

34/3638/4042/44

1	26	26	26
2	142	142	142
3	.	.	A
4	.	.	B
5	130	141	152
6	82	90	98
7	.	.	**
8	195	195	195
9	.	.	C
10	135	135	135
11	136	136	136
12	38	38	38
13	130	141	152
14	82	90	98
15	.	.	**
16	24	24	24
17	49	49	49
18	.	.	***
19	234	237	234
20	164	164	164
21	156	156	156
22	167	167	167
23	1	1	1
24	135	135	135
25	127	127	127
26	140	140	140
27	191	191	191
28	151	139	160
29	9	1	9
30	70	191	70
31	184	137	184
32	135	1	137
33	172	70	172
34	156	184	156
35	148	136	148
36	132	172	132
37	0	156	0
38	.	148	.
39	.	132	.
40	.	0	.

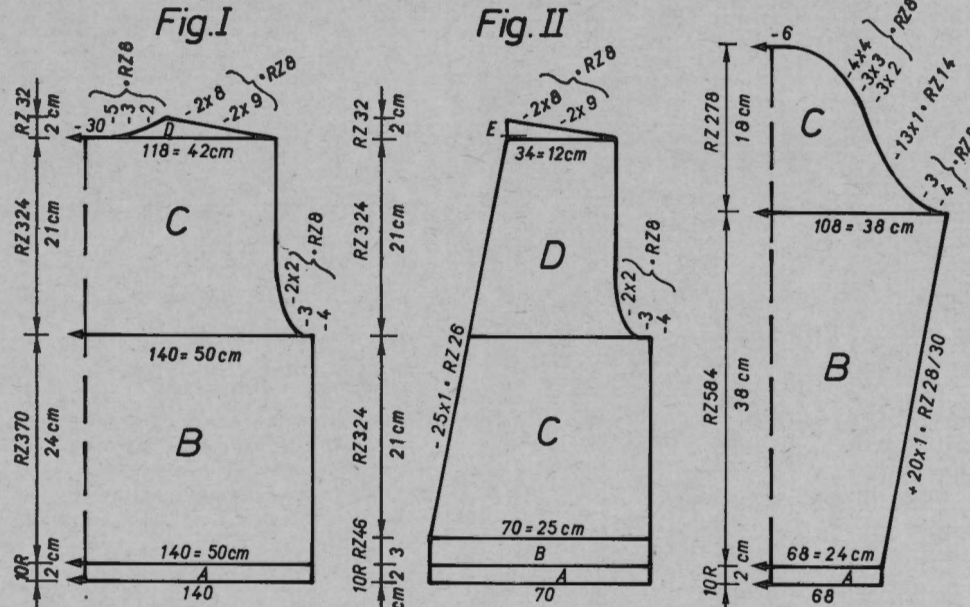

5916

Fig.II

Fig.III

	34/3638/4042/44			34/3638/4042/44		
1	26	26	26	26	26	26
2	397	397	397	142	142	124
3	.	.	A	.	.	.
4	.	.	B	.	.	.
5	65	70	76	65	68	81
6	82	90	98	3	3	3
7	.	.	**	3	3	3
8	195	195	195	195	195	195
9	.	.	C	.	.	C
10	135	135	135	135	135	135
11	136	136	136	136	136	136
12	166	166	166	38	38	38
13	65	70	76	104	107	126
14	82	90	98	37	38	39
15	.	.	**	.	.	**
16	24	24	24	37	37	37
17	49	49	49	58	59	60
18	.	.	***	.	.	***
19	72	72	72	111	111	111
20	191	191	191	135	135	135
21	145	146	147	1	1	1
22	255	255	255	164	164	164
23	255	255	255	156	156	156
24	135	135	135	191	191	191
25	184	184	184	134	134	134
26	135	135	135	84	84	84
27	9	9	9	183	183	183
28	106	109	106	5	5	5
29	164	164	164	191	191	191
30	156	156	156	130	130	130
31	167	167	167	5	5	5
32	1	1	1	191	191	191
33	135	135	135	137	137	137
34	127	127	127	9	9	9
35	140	140	140	0	0	0
36	191	191	191			
37	151	139	160			
38	9	1	9			
39	0	191	0			
40		137				
41		1				
42		0				

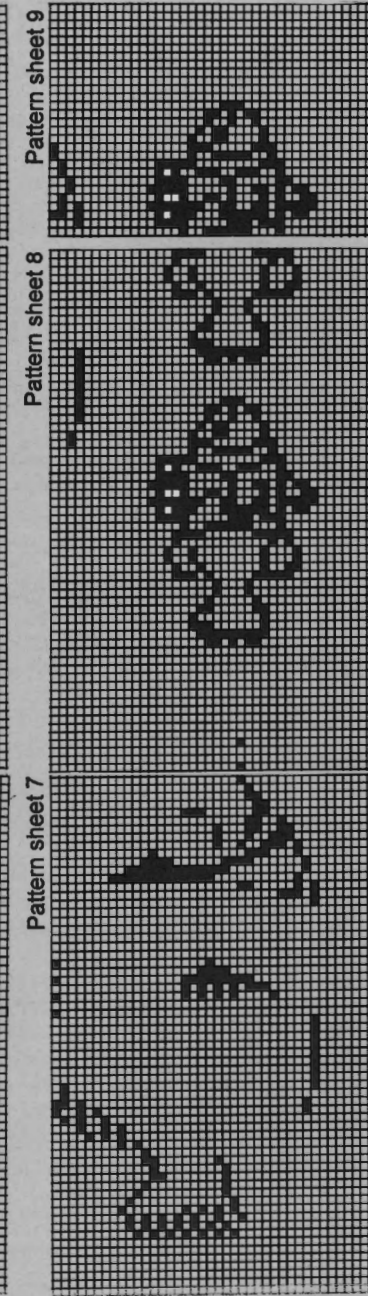
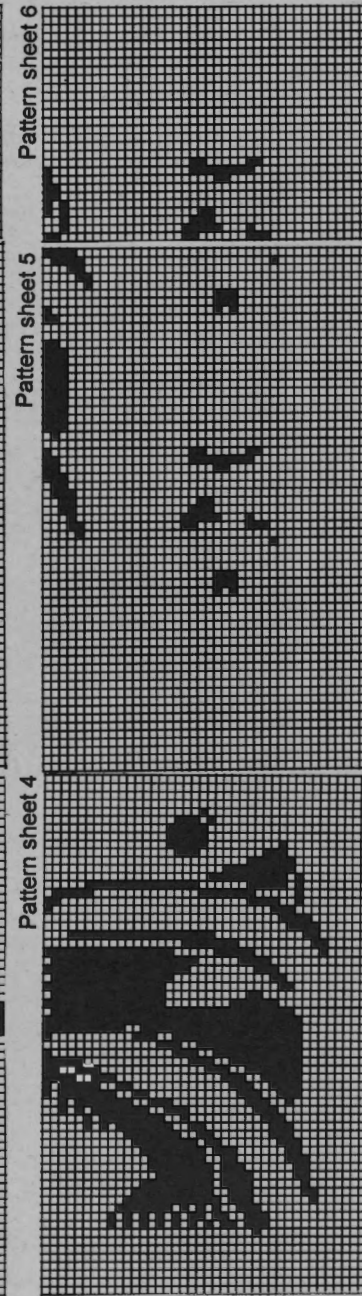
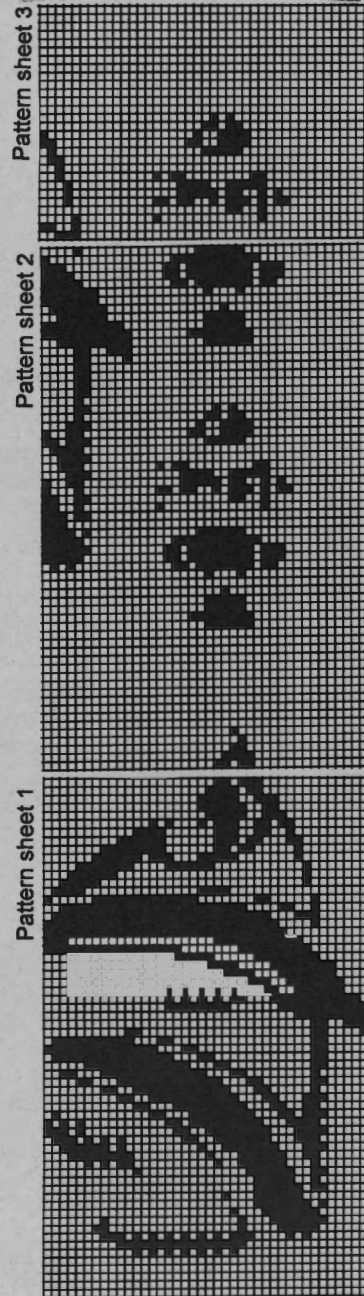

5916

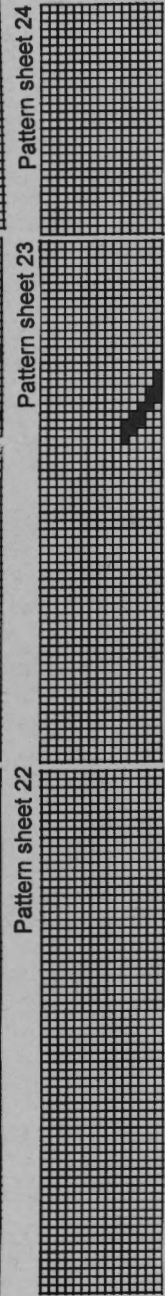
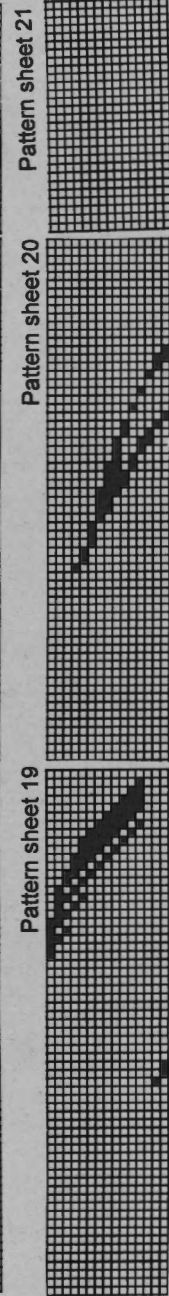
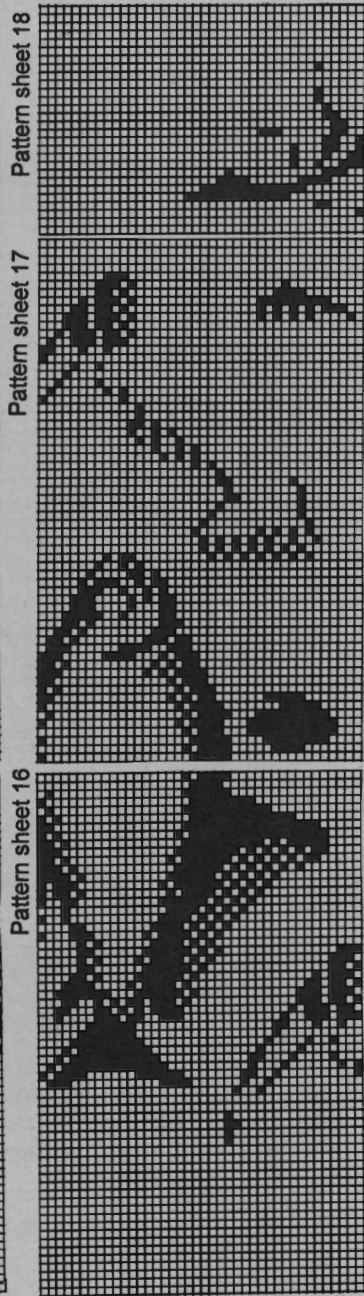
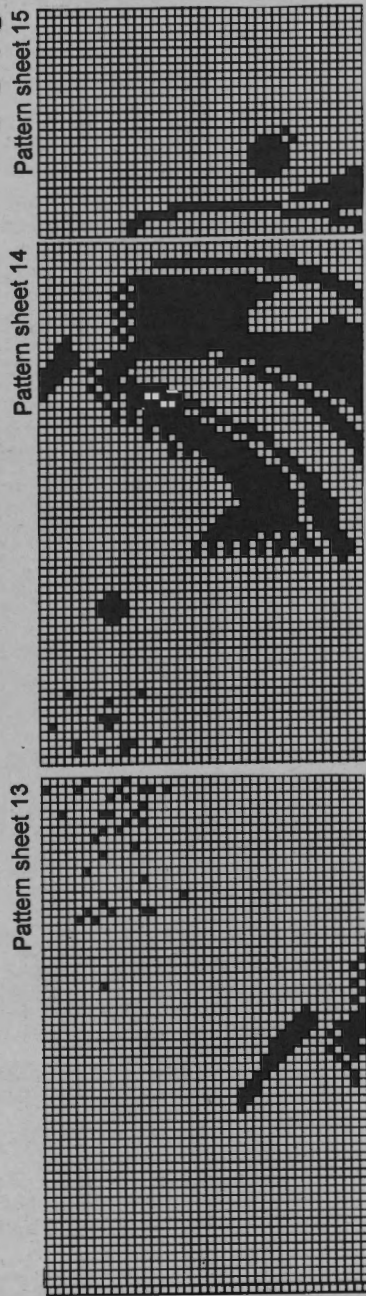

5912

Fig.I			Fig.III			Fig.II		
44/4648/5052/54			44/4648/5052/54			44/4648/5052/54		
60	60	60	60	60	60	60	60	60
156	156	156	156	156	156	156	156	156
.	.	A	.	.	A	.	.	A
.	.	B	.	.	B	.	.	B
136	146	156	72	74	74	136	146	156
90	98	106	3	3	3	90	98	106
.	.	**	3	3	3	.	.	**
195	195	195	195	195	195	195	195	195
.	.	C	.	.	C	.	.	C
135	135	135	135	135	135	135	135	135
141	141	141	137	137	137	141	141	141
38	38	38	38	38	38	166	166	166
136	146	156	151	154	156	136	146	156
90	98	106	59	60	61	90	98	106
.	.	**	.	.	**	.	.	**
61	61	61	48	50	52	61	61	61
67	67	67	68	64	66	67	67	67
.	.	***	.	.	***	.	.	***
0	0	0	97	97	97	73	73	73
.	.	.	131	131	131	184	184	184
.	.	.	0	0	0	129	130	131
.	179	179	179
.	171	171	171
.	163	163	163
.	147	147	147
.	159	159	159
.	2	2	2
.	134	134	134
.	0	0	0

5910 ELECTRONIC 6000

Lady's jacket Queen of Hearts CREATION 6

Model Ruth M. Hagan, USA

Size: To fit 92 - 96 cm bust

Material: 370 g wool black, 90 g mohair white, 70 g mohair red, 50 g mohair yellow. 110 g wool bouclé. Shoulder pads

Stitch size: Four colour Fairisle = 4 1/2. Two colour Fairisle = 6. Hem = 4 1/2

Test square: Four colour Fairisle Queen of Hearts: 100 st (counted on front bed) = 31 cm, RC 100 = 7 cm. Two colour Fairisle: 100 st (counted on front bed) = 40.5 cm. RC 100 = 14 cm.

Pattern: Fig.I, part C : knit pattern A until RC 320 : pattern sheet 1 with continuation 2 + 3, ALTER = ENT, $c \rightarrow n$, ADD pattern sheet 4 with continuation 5 + 6, ALTER = ENT, $c \rightarrow n$, 3.COL = ENT, ADD

Fig.I

Fig.II

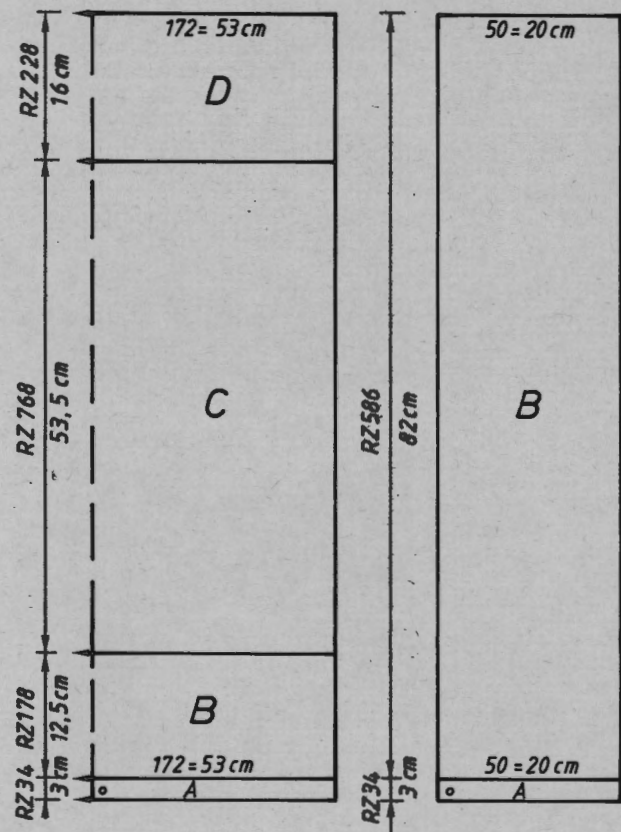

Col sequence

4 colour Fairisle

2 R white
2 R black
2 R red
2 R yellow

2 colour Fairisle

2 R black
2 R red

Fig.III

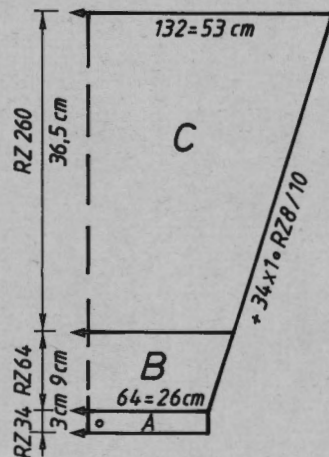

pattern sheet 7 with continuation 8 + 9, ALTER = ENT, $c \rightarrow n$, 4.COL = ENT. TECH 207, ENLARGE POSITION = ENT, \uparrow REP.R = NO, \leftrightarrow REP.ST = NO.

Pattern B knit RC 320 to 640 : pattern sheet 10 with continuation 11 + 12, ALTER = ENT, $c \rightarrow n$, ADD pattern sheet 13 with continuation 14 + 15, ALTER = ENT, $c \rightarrow n$, 3.COL = ENT, ADD pattern sheet 16 with continuation 17 + 18, ALTER = ENT, $c \rightarrow n$ 4.COL = ENT.

TECH 207, ENLARGE POSITION = ENT \uparrow REP. R = NO, \leftrightarrow REP.ST = NO

Pattern C knit RC 640 to 768 : pattern sheet 19 with continuation 20 + 21 ALTER = ENT, $c \rightarrow n$, ADD pattern sheet 22 with continuation 23 + 24 ALTER = ENT, $c \rightarrow n$, 3.COL = ENT, ADD pattern sheet 25 with continuation 26 + 27, ALTER = ENT, $c \rightarrow n$, 4.COL = ENT. TECH 207, ENLARGE POSITION = ENT \uparrow REP.R = NO, \leftrightarrow REP.ST = NO

Section B + D TECH 207 without colour sequence.

Fig.II: TECH 180 without colour sequence

Fig.III: section : pattern sheet 28, TECH 180, ENLARGE POSITION = ENT \uparrow REP.R = NO, \leftrightarrow REP.ST = ENT. Section C, TECH 180 without colour sequence. Hem = cast on 8, cont to knit. Edging = patter sheet 29, TECH 180

Fig.I: Back

A = knit with single strand black wool, cast on 8, cont to knit. B = knit with double strand black wool without col seq, TECH 207. C = knit using Queen of Hearts pattern, TECH 207, knit with col seq. D = knit TECH 207 with col seq, cast off.

Fig.II: Front part, knit 2

A = knit with single strand black wool, cast on 8, cont to knit. B = knit with double strand black wool without col seq, TECH 180, cast off

Fig.III: Sleeves, knit 2

A = knit with single strand black wool, cast on 8, cont to knit. B = knit Fairisle with pattern sheet 28, knit with col seq, knit with double strand red/black wool, knit TECH 180 and inc on both sides. C = cont to knit TECH 180 without col seq, and inc on both sides, cast off.

Edging: Knit with double stranded black wool, cast on 2 over 23 nds, with pattern sheet 29, TECH 180 with col seq black / bouclé red, st.s 6, knit RC 1440, cast off

To make up: Block parts to size and leave to dry under a damp cloth. Sew shoulder seams. With right sides together, sew sleeves to back and front part. Sew sleeve and side seams with mattress stitch.

Length per 100 g =

Wool black = 900 m

Mohair white, yellow, red 600 m

Wool Bouclé red 444 m

5910

	Fig.I			Fig.II			Fig.III		
	34/3638/4042/44			34/3638/4042/44			34/3638/4042/44		
1	28	28	28	56	56	56	56	56	56
2	124	124	124	417	162	417	162	162	162
3	.	.	A	.	.	A	.	.	A
4	.	.	B	.	.	B	.	.	B
5	158	171	184	44	49	54	62	64	67
6	82	90	98	82	90	98	3	3	3
7	.	.	**	.	.	**	3	3	3
8	195	195	195	195	195	195	195	195	195
9	.	.	C	.	.	C	.	.	C
10	135	135	135	135	135	135	135	135	135
11	142	142	142	131	131	131	131	131	131
12	38	38	38	38	38	38	38	38	38
13	158	171	184	44	49	54	128	131	133
14	82	90	98	82	90	98	52	53	54
15	.	.	**	.	.	**	.	.	**
16	82	82	82	82	82	82	44	44	44
17	85	85	85	85	85	85	58	59	60
18	.	.	***	.	.	***	.	.	***
19	0	0	0	0	0	0	97	97	97
20							132	132	132
							0	0	0

Pattern sheet 9

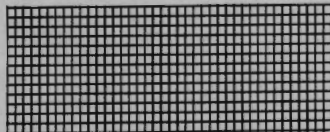

Pattern sheet 6

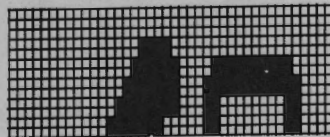

Pattern sheet 3

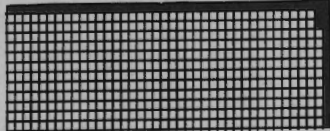

Pattern sheet 2



Pattern sheet 1

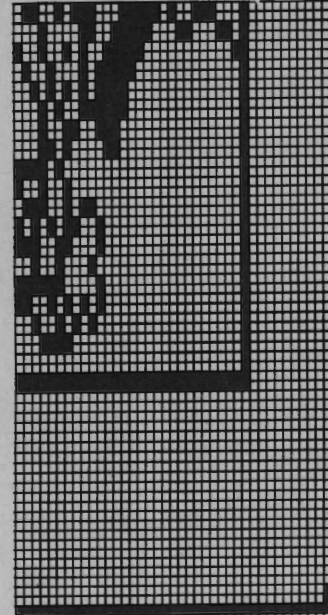

Pattern sheet 5

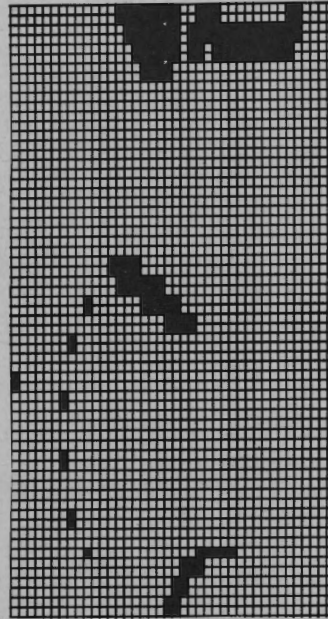

Pattern sheet 4

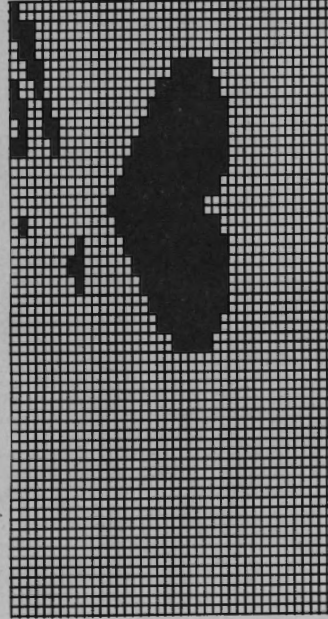

Pattern sheet 8

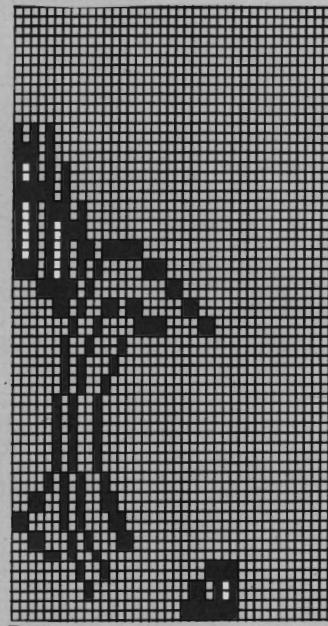

Pattern sheet 7

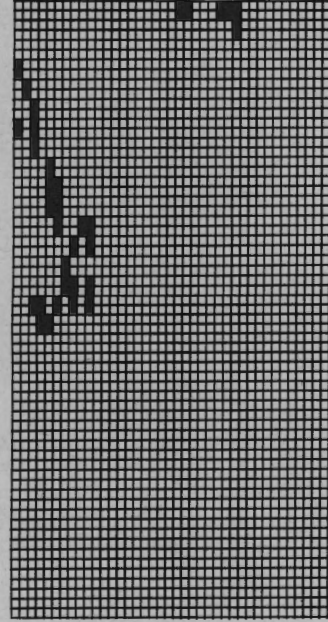

Pattern sheet 11

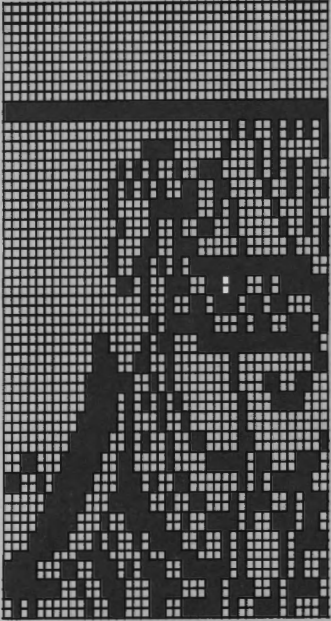

Pattern sheet 10

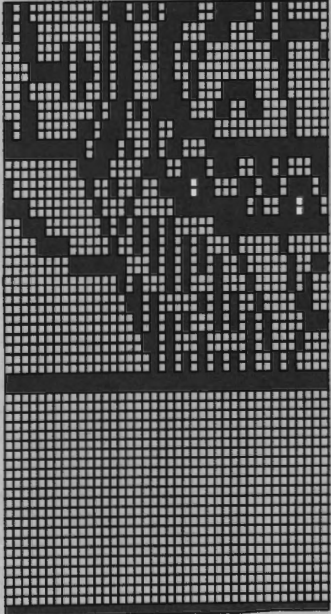

Pattern sheet 14

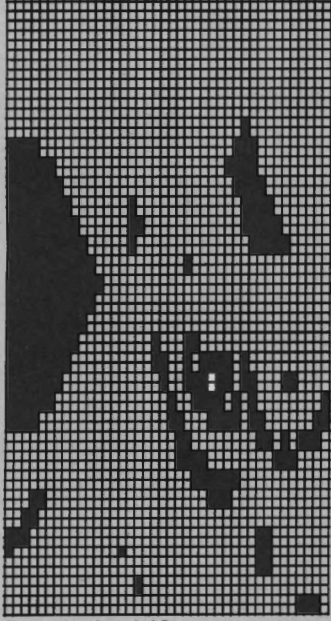

Pattern sheet 13

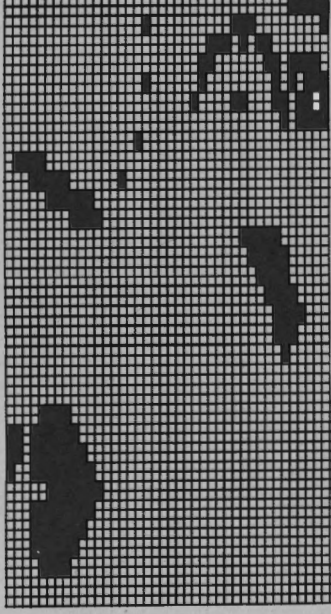

Pattern sheet 17

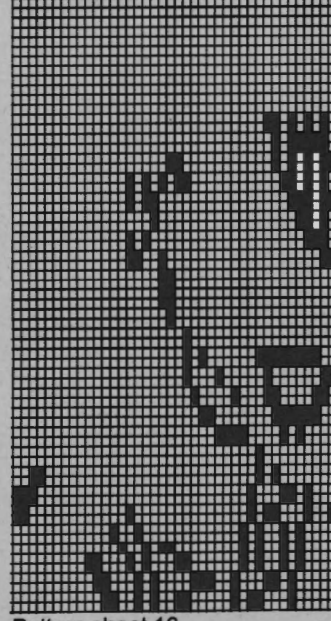

Pattern sheet 16

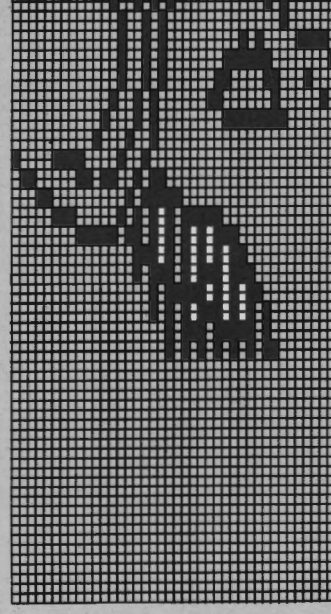

20

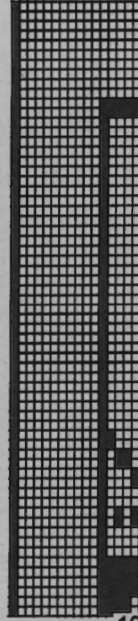

19

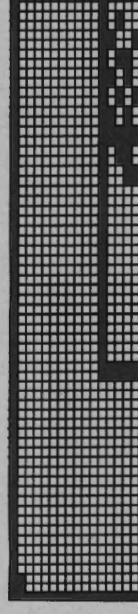

23

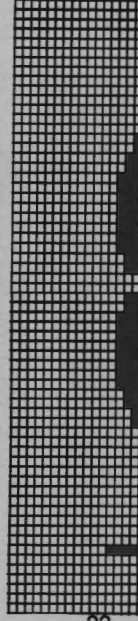

22

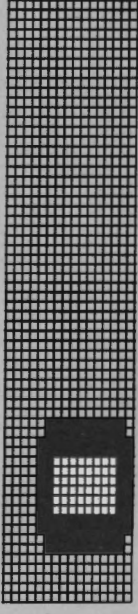

26

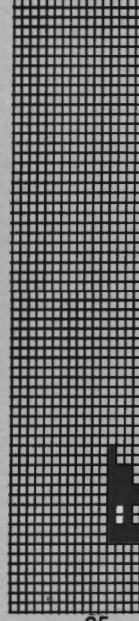

25

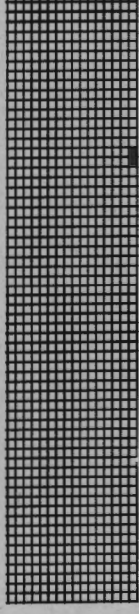

Pattern sheet 29



Pattern sheet 28

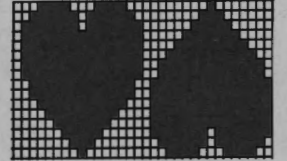

21

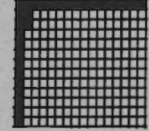

24 27

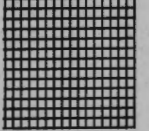

Pattern sheet 15 18

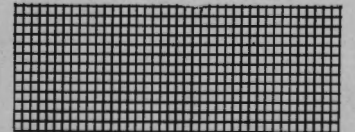

Pattern sheet 12



5923 DUOMATIC 80/S ELECTRONIC 6000 PICTO

Length per 100 g = 720 m

Child's skirt for 5922 with intarsia

Model T. Roganova Russia

[Instructions for ELECTRONIC 6000 in square brackets]

Size: To fit 116 cm height

Material: 90 g red wool, 30 g lilac, 45 cm elastic

Stitch size: Stocking stitch = 5, Hem = 4 1/2

Test square: Stocking stitch 100 st = 32 cm, 100 R = 20.5 cm

Pattern: Fig.IV: Stocking stitch [TECH 100], Fig.V: intarsia according to diagram and colour sequence [pattern 1100, ENLARGE POSITION = ENT, ↔ x 50, TECH 245] Hem = tubular [cast on 8, cont to knit]

Fig.I: Back

A = closed tubular cast on with red wool [cast on 8, cont to knit]. B = transfer all st.s to front bed and knit stocking stitch [TECH 100]. C = knit st.s 4, cast off.

Fig.V: Hem

A = closed tubular cast on with lilac wool [cast on 8, cont to knit]. B = transfer all st.s from front bed to decker combs.

Fig.Va: Front

A = closed tubular cast on right of centre with red wool [cast on 8, cont to knit]. B = transfer all st.s to front bed, transfer from decker combs Fig.V to the left of centre. In the centre of the rear bed leave one rd in working position. Knit intarsia acc to diagram and col seq. 1st feeding eyelet from left lilac, 2nd feeding eyelet from left red [ELECTRONIC as well, pattern 1100 ↔ x 50, TECH 245]. C = knit st.s 4, cast off.

To make up: Block parts to size and leave to dry under a damp cloth. Sew shoulder seams. Seam side seams with mattress stitch. Fold over waistband, seam down on inside. Pull elastic through.

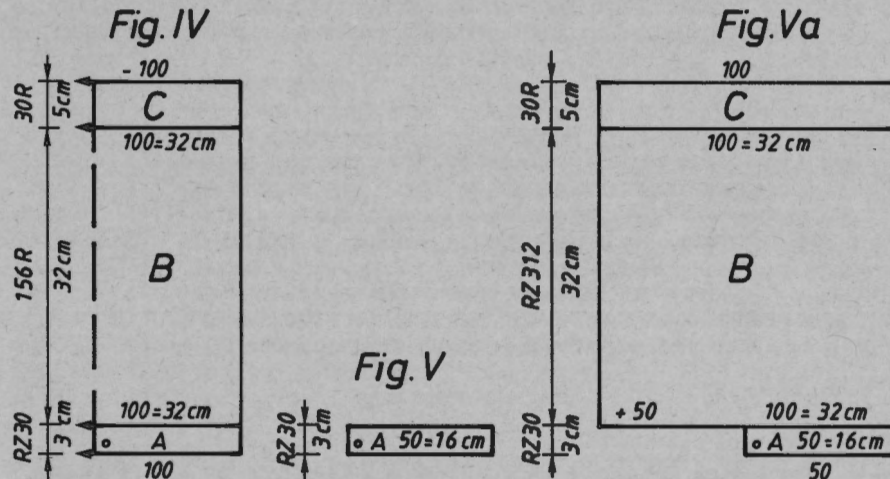
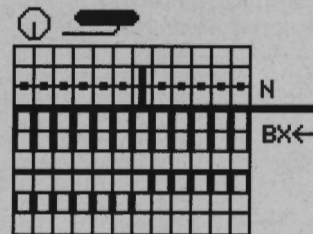

Fig.IV				Fig.Va				Fig.V			
116	128	140	152	116	128	140	152	116	128	140	152
82	82	82	82	82	82	82	82	82	82	82	82
128	128	128	128	128	128	128	128	128	128	128	128
.	.	.	A	.	.	.	A	.	.	.	A
.	.	.	B	.	.	.	B	.	.	.	B
100	109	119	131	100	106	119	131	50	53	59	66
64	69	74	82	64	69	74	82	64	69	74	82
.	.	.	**	.	.	.	**	.	.	.	**
195	195	195	195	195	195	195	195	131	131	131	131
.	.	.	C	.	.	.	C	.	.	.	C
135	135	135	135	135	135	135	135	135	135	135	135
128	128	128	128	128	128	128	128	128	128	128	128
38	38	38	38	38	38	38	38	98	98	98	98
100	109	119	131	100	106	119	131	192	192	192	192
64	69	74	82	64	69	74	82	3	3	3	3
.	.	.	**	.	.	.	**	0	0	0	0
25	30	37	45	25	30	37	45				
30	35	42	50	30	35	42	50				
.	.	.	***	.	.	.	***				
98	98	98	98	98	98	98	98				
192	192	192	192	192	192	192	192				
2	2	2	2	2	2	2	2				
131	131	131	131	131	131	131	195				
.	.	.	C	.	.	.	C				
135	135	135	135	135	135	135	135				
133	133	133	133	133	133	133	133				
0	0	0	0	0	0	0	0				

Diagram for intarsia [TECH 245]



5915 DUOMATIC 80 ELECTRONIC 6000

Lady's pullover 4 colour Fairisle

[Instructions for ELECTRONIC 6000 in square brackets]

Size: To fit 88 - 92 cm bust

Material: 70 g acryl mohair pale grey, 80 g orange wool, 60 g each of dark grey and olive wool, 50 g each of beige, yellow and bordeaux wool, 30 g each of blue and red wool (Moragam from Conofil)

Stitch size: 4 colour Fairisle = back 3 ¼, front 4 ¼, cuffs = 3 ½, tubular = 5

Test square: 100 st (counted on front bed) = 32 cm, RC 100 = 6.5 cm

Pattern: 4 colour Fairisle according to diagram and colour sequence with self-punched DECO cards [with self-drawn pattern sheets, pattern sheet 1 with cont 2, ADD pattern sheet 3, with cont 4, 3.COL = ENT, pattern sheet 5 with cont, 4.COL = ENT, TECH 207]. Hem and neckband = tubular [cast on 8, cont to knit], cuffs = 1:1 [cast on 1, cont to knit].

Fig.I: Back

A = closed tubular cast on with double strand [cast on 8, cont to knit]. B = cont to knit acc to diagram and col seq with DECO punchcards [with pattern sheets, TECH 207]. C = shape both sides for sleeves, cast off.

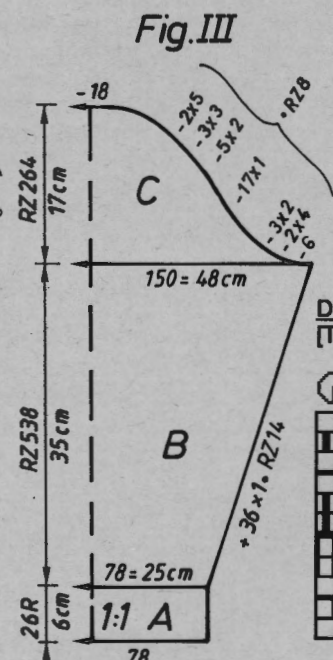
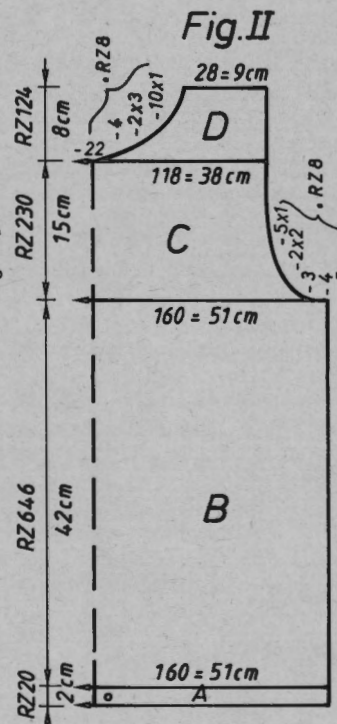
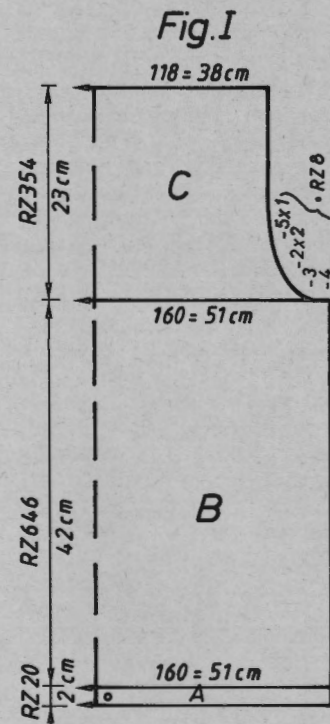

Fig.II: Front

Knit A + B as in Fig.I. C = shape both sides for sleeve. D = divide work, cast off centre st (if you knit without FORM program, make a note of the electronic row counter), place left half onto decker combs. Cont to knit right half, and shape left for neck, cast off. Put left part back onto the same nds as before and finish knitting with reversed shape.

Fig.III: Sleeves knit 2

A = tubular cast on for 1:1 with orange wool [cast on 1, cont to knit]. B = bring all nds to working position, knit acc to diagram and col seq with DECO punchcards [pattern sheets, TECH 207, cont to knit], and inc on both sides. C = shape both sides for sleeve head, cast off.

Neckband:

Closed tubular cast on with double strand orange wool [cast on 8, cont to knit] over 114 nds, st.s 5, knit RC 20, end with a few R of contrast yarn, cast off.

To make up: Block parts to size and leave to dry under a damp cloth. Sew shoulder seams. Sew neckband st by st to neck with backstitches through open loops and unravelling contrast yarn. Hem down on inside. With right sides together, sew sleeves to back and front. Sew sleeves and side seams with mattress stitch.

Length per 100 g :
 Acryl mohair pale grey = 620 m
 Wool orange, dark grey, olive, yellow, beige, bordeaux, blue, red = 900 m

Diagram for 4 colour Fairisle [TECH 207]

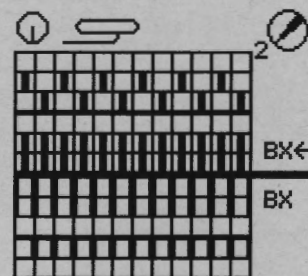

5915

Colour sequence

as required
(the pullover shown was
knitted as follows)

- RC 0-48 2 R beige
2 R orange
2 R pale grey
2 R blue
- RC 49-56 2 R blue
2 R olive
2 R pale grey
2 R yellow
- RC 57-96 2 R blue
2 R olive
2 R bordeaux
2 R yellow
- RC 97-112 2 R orange
2 R olive
2 R bordeaux
2 R yellow
- RC 113-128 2 R yellow
2 R bordeaux
2 R olive
2 R blue
- RC 129-136 2 R dark blue
2 R bordeaux
2 R olive
2 R blue
- RC 137-144 2 R beige
2 R bordeaux
2 R olive
2 R blue
- RC 145-152 2 R orange
2 R bordeaux
2 R olive
2 R blue
- RC 153-168 2 R yellow
2 R blue
2 R olive
2 R bordeaux
- RC 169-184 2 R bordeaux
2 R blue
2 R olive
2 R dark grey

- RC 185-248 2 R beige
2 R dark grey
2 R olive
2 R bordeaux
- RC 249-336 2 R pale grey
2 R yellow
2 R orange
2 R dark grey
- RC 337-384 2 R dark grey
2 R olive
2 R red
2 R pale grey
- RC 385-472 2 R pale grey
2 R dark grey
2 R beige
2 R red
- RC 473-520 2 R dark grey
2 R olive
2 R red
2 R pale grey
- RC 521-544 2 R red
2 R beige
2 R blue
2 R olive
- RC 545-608 2 R orange
2 R bordeaux
2 R yellow
2 R dark grey
- RC 609-624 2 R olive
2 R bordeaux
2 R dark grey
2 R yellow
- RC 625-640 2 R beige
2 R orange
2 R pale grey
2 R yellow
- RC 641-648 2 R dark grey
2 R orange
2 R pale grey
2 R yellow
- RC 649-656 2 R beige
2 R orange
2 R pale grey
2 R yellow

- RC 657-664 2 R blue
2 R orange
2 R pale grey
2 R yellow
- RC 665-680 2 R beige
2 R orange
2 R pale grey
2 R yellow
- RC 681-696 2 R bordeaux
2 R yellow
2 R pale grey
2 R orange
- RC 697-736 2 R yellow
2 R blue
2 R red
2 R olive
- RC 737-744 2 R pale grey
2 R olive
2 R blue
2 R yellow
- RC 745-776 2 R pale grey
2 R orange
2 R blue
2 R yellow
- RC 777-800 2 R yellow
2 R bordeaux
2 R pale grey
2 R olive
- RC 801-808 2 R beige
2 R bordeaux
2 R pale grey
2 R olive
- RC 809-848 2 R red
2 R dark grey
2 R pale grey
2 R orange
- RC 849-896 2 R bordeaux
2 R yellow
2 R olive
2 R red
- RC 897-944 2 R blue
2 R beige
2 R red
2 R orange
- RC 945-1000 2 R orange
2 R bordeaux
2 R yellow
2 R dark grey

Pattern sheet 2

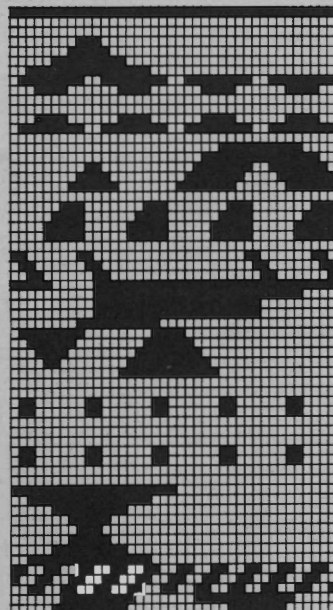

Pattern sheet 1

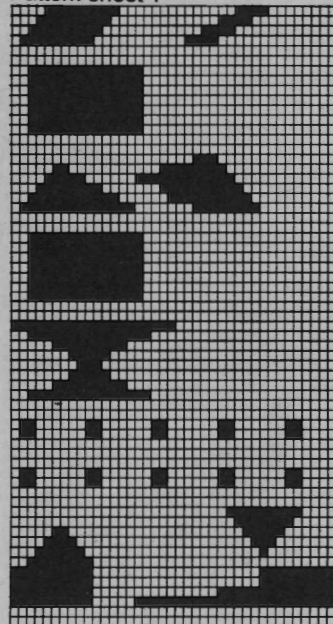

Pattern sheet 4

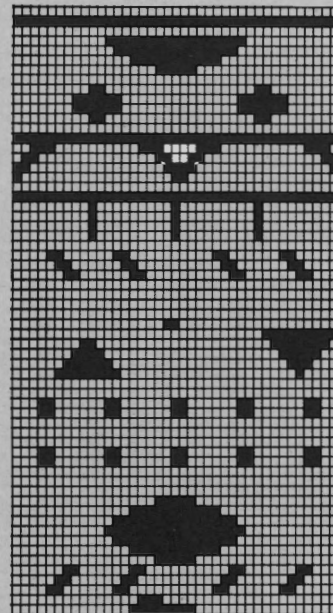

Pattern sheet 3

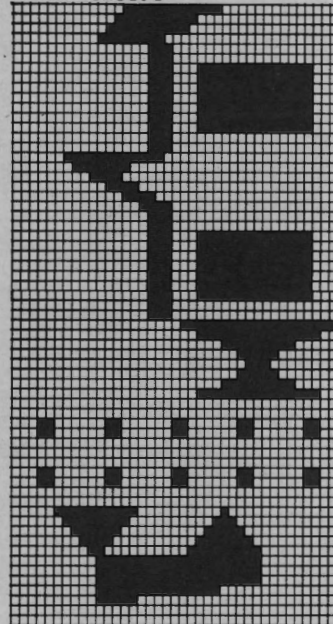

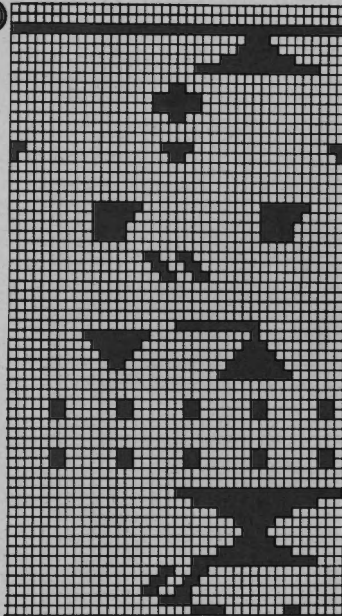

Pattern sheet 5

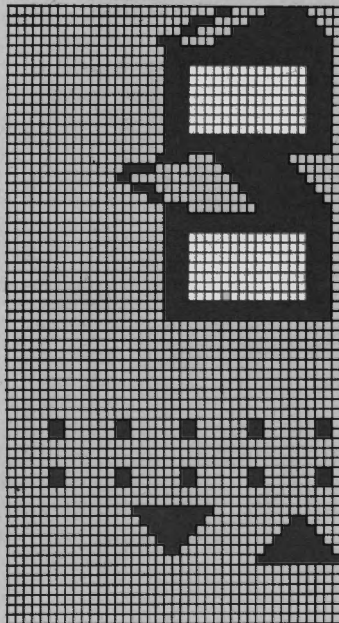

DECO card 2

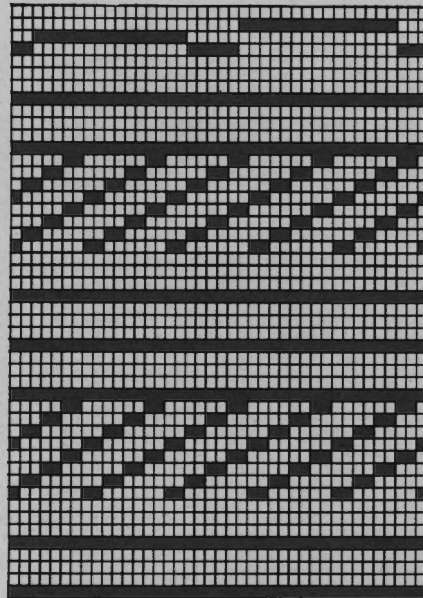

DECO card 4

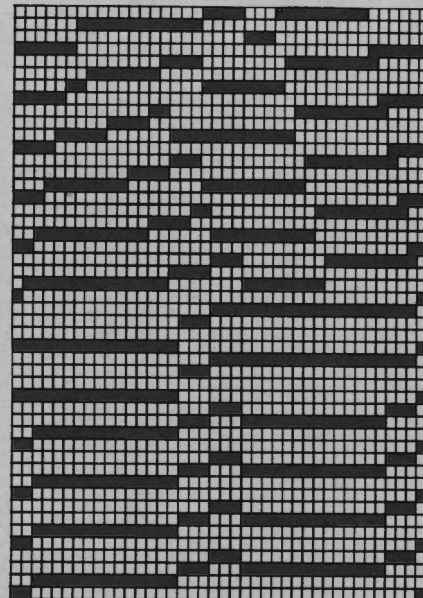

DECO card 6

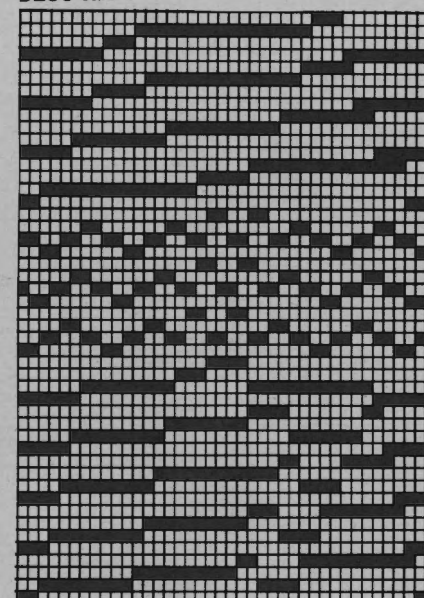

DECO card 1

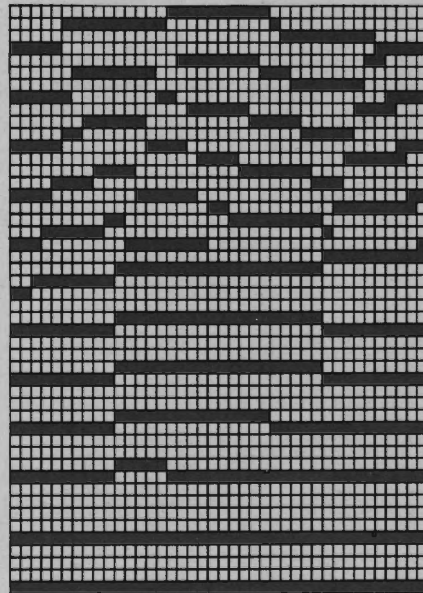

DECO card 3

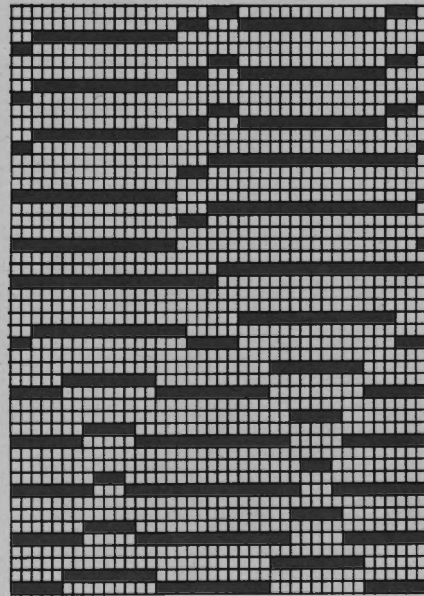

DECO card 5

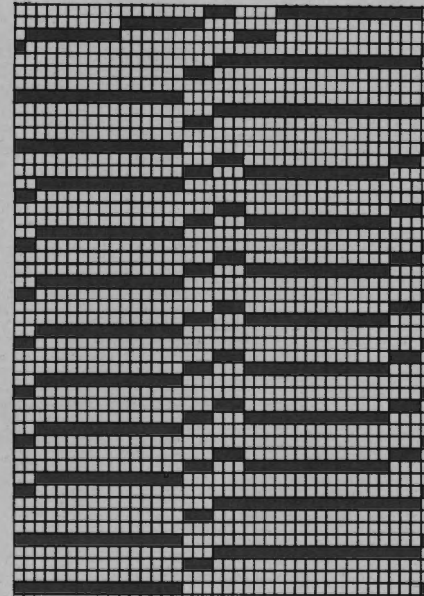

DECO 8

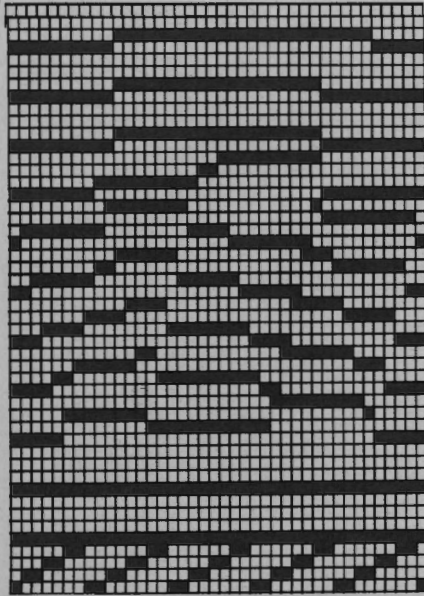

DECO 7

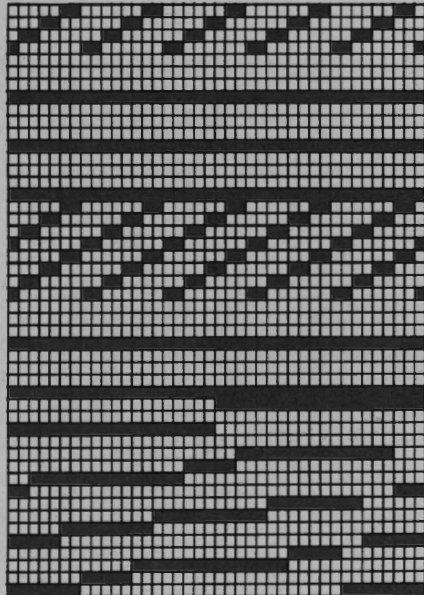

DECO 10

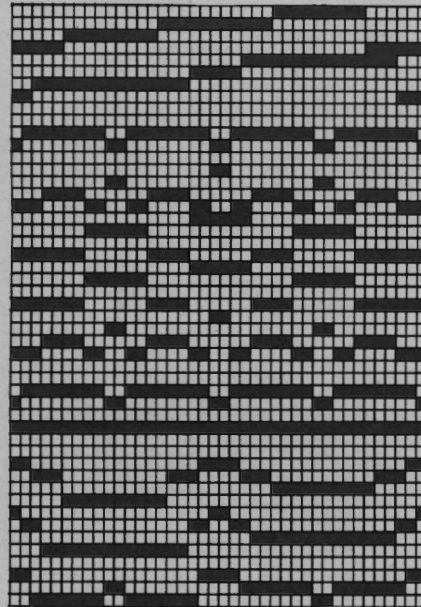

DECO 9

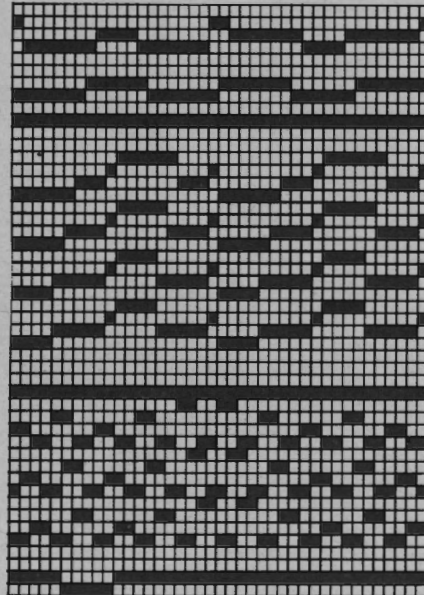

DECO 11

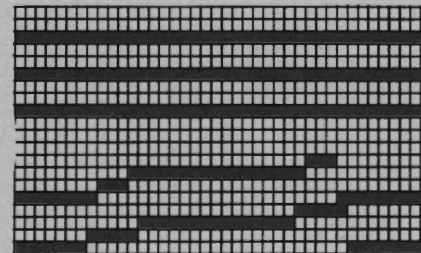

	Fig.I			Fig.II			Fig.III		
	34/3638/4042/44			34/3638/4042/44			34/3638/4042/44		
1	26	26	26	26	26	26	26	26	26
2	114	114	114	114	114	114	114	114	114
3	.	.	A	.	.	A	.	.	.
4	.	.	B	.	.	B	.	.	.
5	165	179	193	165	179	193	88	91	95
6	82	90	98	82	90	98	3	3	3
7	**	3	3	3
8	195	195	195	195	195	195	195	195	195
9	.	.	C	.	.	C	.	.	.
10	135	135	135	135	135	135	135	135	135
11	136	136	136	136	136	136	167	167	167
12	38	38	38	38	38	38	38	38	38
13	165	179	193	165	179	193	165	168	172
14	82	90	98	82	90	98	47	48	49
15	**	.	.	.
16	41	41	41	41	41	41	33	33	33
17	66	66	66	66	66	66	58	59	60
18	***	.	.	.
19	106	106	106	234	234	234	110	110	110
20	172	172	172	172	172	172	135	135	135
21	164	164	164	164	164	164	1	1	1
22	156	156	156	156	156	156	172	172	172
23	183	183	183	183	183	183	164	164	164
24	5	5	5	5	5	5	156	156	156
25	167	167	167	167	167	167	191	191	191
26	9	9	9	9	9	9	145	145	145
27	135	135	135	135	135	135	65	65	65
28	127	127	127	127	127	127	191	191	191
29	131	131	131	131	131	131	129	129	129
30	0	0	0	75	76	76	9	9	9
				168	184	184	191	191	191
				172	128	130	133	133	133
				164	172	172	9	9	9
				183	164	164	99	99	99
				1	183	183	191	191	191
				183	1	1	137	137	137
				5	183	183	9	9	9
				191	5	5	0	0	0
				129	191	191			
				25	129	129			
				130	25	25			
				0	130	130			
						0			

5917 DUOMATIC 80 ELECTRONIC 6000

Lady's jacket 3 colour Fairisle

Model Fern L. Wayne USA

[Instructions for ELECTRONIC 6000 in square brackets]

Size: To fit 88 - 92 cm bust

Material: 180 g wool/rayon black, 170 g cotton olive, 160 g cotton lilac, 30 g lurex thread lilac, knitting elastic, 1 fastener.

Stitch size: Pattern = back 4, front 4 1/2, Hém and neckband = 4

Test square: 100 st (counted on front bed) = 30 cm, RC 100 = 17 cm

Pattern: 3 colour Fairisle for Fig.I+II according to diagram 1 and colour sequence with self-punched DECO cards [with self-drawn pattern sheet, pattern sheet 1 ADD pattern sheet 2, 3.COL = ENT, TECH 197]. 3 colour Fairisle for Fig.III according to diagram 1 and colour sequence with self-punched DECO cards [pattern 1364 ADD pattern 1364, ALTER = ENT, \curvearrowright , 3.COL = ENT, TECH 197, ENLARGE POSITION = ENT, \leftrightarrow x 3]. Hem = tubular [cast on 8, cont to knit]

Fig.I: Back

A = closed tubular cast on with black wool/rayon [cast on 8, cont to knit] B = knit 3 col Fairisle acc diagram 1 and col seq with DECO punchcards [with pattern sheets, TECH 197]. C = shape both sides for sleeves, cont to knit with pattern. D = divide

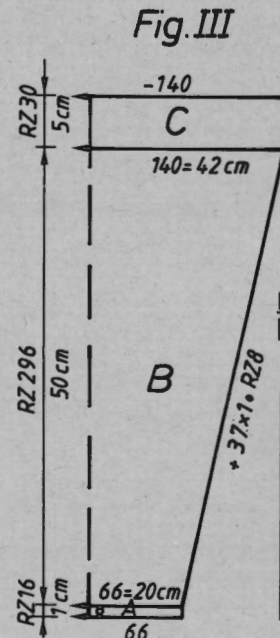
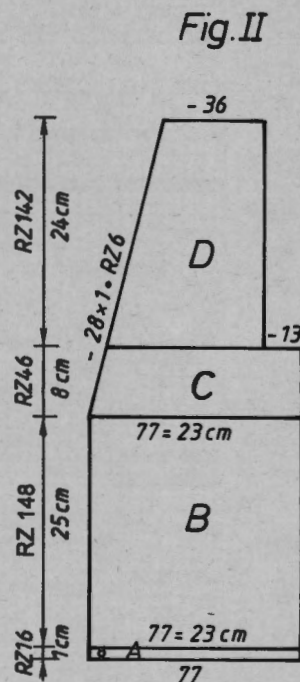
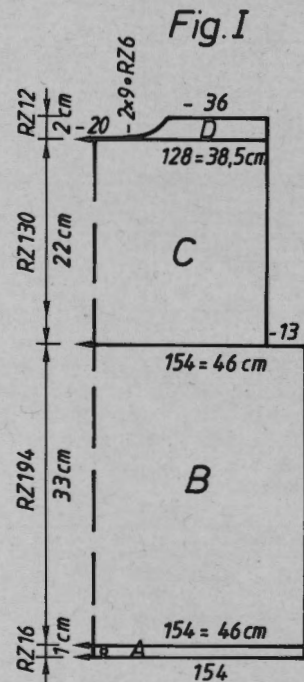

Colour sequence
2R black
2R olive
2R lilac with lurex thread

Diagram 1 for 3 colour Fairisle
[TECH 197]

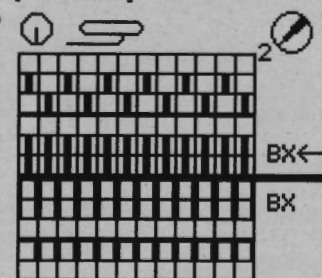
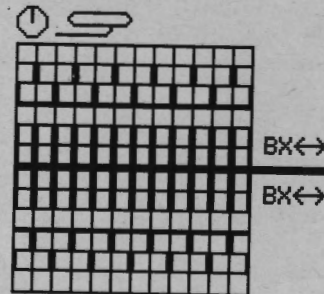

Diagram 2 for neckband
[TECH 118]



Length per 100 g =
Wool/Rayon black 2800 yds
Cotton olive 650 m
Cotton lilac 850 m
Lurex thread 1500 m

work, cast off centre st (if you knit without FORM program, make a note of the electronic row counter), place left half onto decker combs. Cont to knit right half, and shape left for neck, cast off. Put left part back onto the same nds as before and finish knitting with reversed shape.

Fig.II: Front, knit two reversed shapes

A = closed tubular cast on with black wool/rayon [cast on 8, cont to knit] B = knit 3 col Fairisle acc diagram 1 and col seq with DECO punchcards [with pattern sheets, TECH 197]. C = shape both sides for sleeves, cont to knit with pattern. D = shape right for sleeve, left for neck, cast off.

Fig.III: Sleeves, knit 2

A = closed tubular cast on with black wool/rayon and black knitting elastic [cast on 8, cont to knit] B = knit 3 col Fairisle acc diagram and col seq with DECO punchcards [pattern 1364, TECH 197], and inc on both sides. C = knit straight, cast off.

Neckband: Closed tubular cast on with black wool/rayon [cast on 8] over 9 nds, st.s 4, interlock acc diagram 2 [TECH 118] knit RC 960, cast off.

Bindings for sleeveholes: knit 2

Cast on with contrast yarn 12 st stocking stitch [cast on 8] knit 620 R stocking stitch with black wool/rayon [TECH 100], cast off.

To make up: Block parts to size and leave to dry under a damp cloth. Sew shoulder seams. With right side together, sew neckband to front edge and back, fold over and seam down. With right sides together, sew sleeves to back and front with the bindings in between. Sew sleeve and side seams with mattress stitch. Sew on fastener.

5917

	Fig.I			Fig.II			Fig.III		
	34/3638/4042/44			34/3638/4042/44			34/3638/4042/44		
1	68	68	68	68	68	68	68	68	68
2	120	120	120	375	375	375	120	120	120
3	.	.	A	.	.	A	.	.	A
4	.	.	B	.	.	B	.	.	B
5	140	153	167	70	77	83	63	67	70
6	82	90	98	82	90	98	3	3	3
7	.	.	**	.	.	**	3	3	3
8	194	194	194	194	194	194	194	194	194
9	.	.	C	.	.	C	.	.	C
10	134	134	134	134	134	134	134	134	134
11	38	38	38	166	166	166	38	38	38
12	140	153	167	70	77	83	137	140	143
13	82	90	98	82	90	98	41	42	43
14	.	.	**	.	.	**	.	.	**
15	33	33	33	33	33	33	50	50	50
16	59	59	59	59	59	59	58	59	60
17	.	.	***	.	.	***	.	.	***
18	228	228	228	67	67	67	98	98	98
19	184	184	184	191	191	191	135	135	135
20	134	134	134	148	149	150	8	8	8
21	135	135	135	215	215	215	0	0	0
22	64	64	64	100	100	100			
23	68	68	68	184	184	184			
24	184	184	184	134	134	134			
25	130	131	132	135	135	135			
26	190	190	190	64	64	64			
27	139	139	139	0	0	0			
28	0	0	0						

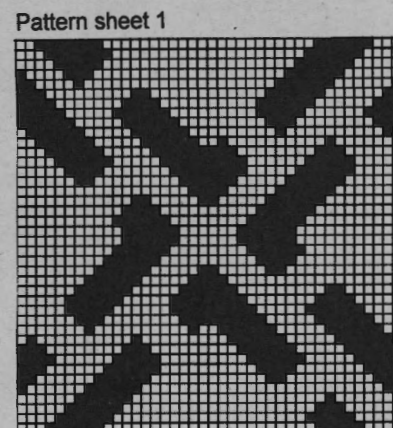
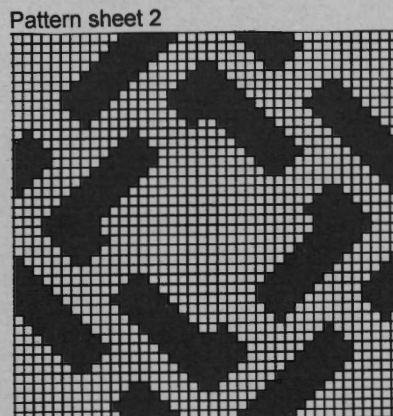
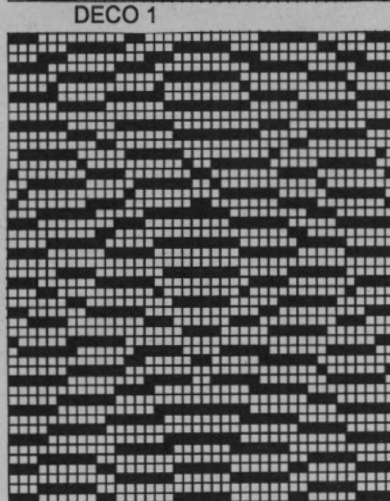
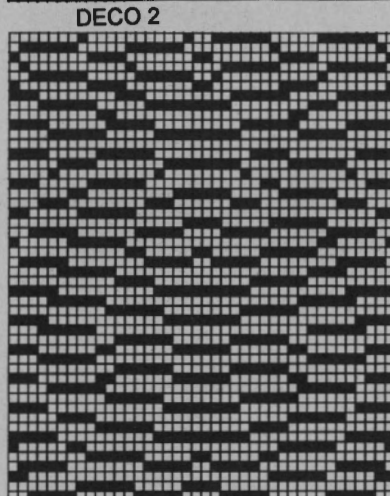
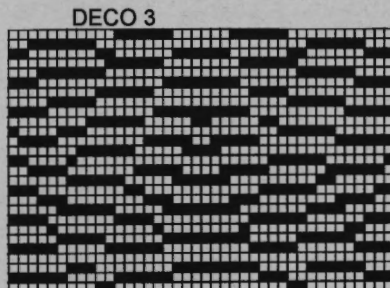

5918

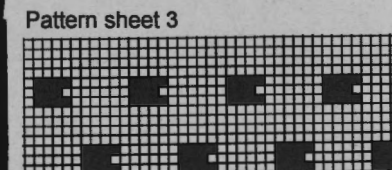
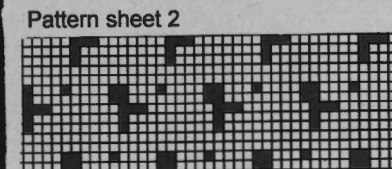

5918 DUOMATIC 80 ELECTRONIC 6000

Lady's 4 colour Fairisle pullover

[Instructions for ELECTRONIC 6000 in square brackets]

Size: To fit 88 - 92 cm bust

Material: 210 g acryl/mohair blue, 100 g wool lilac, 90 g wool olive (Moragam from Conofil). 120 g mohair/nylon black (Finesse from Conofil)

Stitch size: Pattern = back 4, front 4 1/2. Hem = 4 1/2. Cuffs and polo neck = 3.

Test square: 100 st (counted on front bed) = 42 cm. RC 100 = 8.5 cm.

Pattern: 4 colour Fairisle according to diagram and colour sequence with self-punched DECO cards [with self-drawn pattern sheets, pattern sheet 1 ADD pattern sheet 2, 3.COL = ENT, ADD pattern sheet 3, 4.COL = ENT, TECH 210]. Hem = closed tubular cast on [cast on 8, cont to knit]. Cuffs and polo neck = 1:1 [cast on 1, cont to knit]

Fig.I: Back

A = closed tubular cast on with blue acryl/mohair [cast on 1, cont to knit] B = cont to knit with 4 col Fairisle acc to diagram and col seq with DECO punchcards [with pattern sheets, TECH 210]. C = shape both sides for sleeves, cont to knit with pattern, cast off.

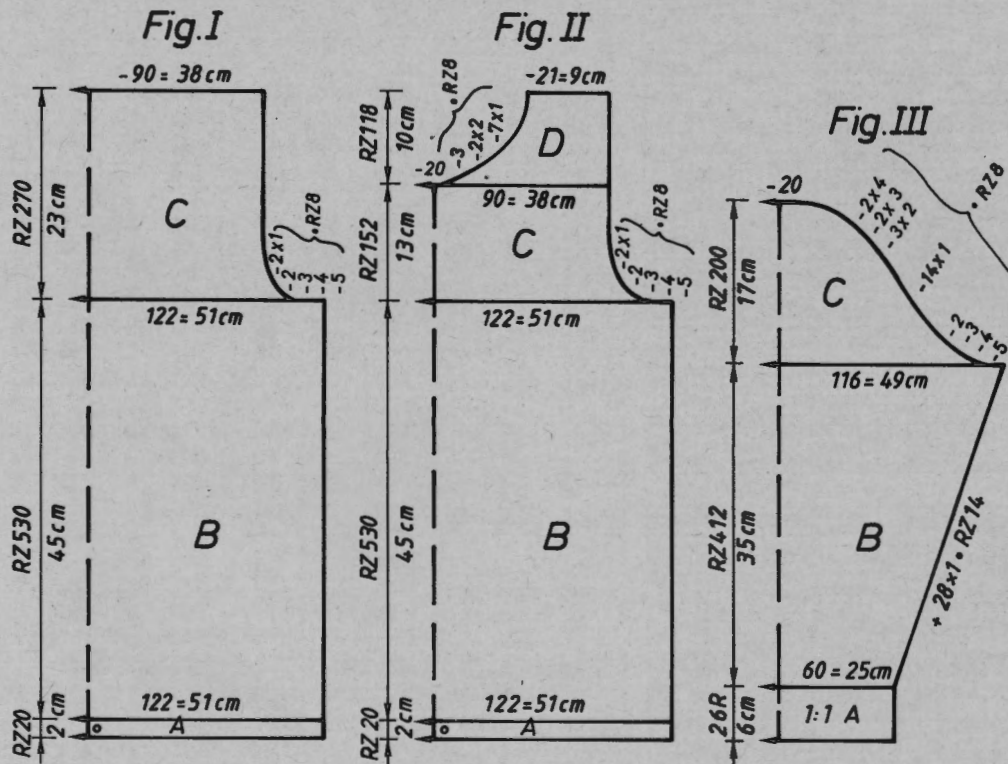

Fig.II: Front

Knit A + B as in Fig.I. C = shape both sides for sleeves, cont to knit with pattern. D = divide work, cast off centre st (if you knit without FORM program, make a note of the electronic row counter), place left half onto decker combs. Cont to knit right half, and shape left for neck, cast off. Put left part back onto the same nds as before and finish knitting with reversed shape.

Fig.III: Sleeves, knit 2

A = tubular cast on 1:1 with blue acryl/mohair [cast on 1, cont to knit]. B = cont to knit with 4 col Fairisle acc to diagram and col seq with DECO punchcards [with pattern sheets, TECH 210] and inc on both sides. C = shape both sides for sleeve head, cast off.

Polo neck: tubular cast on 1:1 with acryl/mohair [cast on 1, cont to knit] over 140 nds. St.s 3, knit 64 R, locks back and front CX [ELECTRONIC as well] st.s 4 1/2, knit RC 12, end with a few R of contrast yarn, cast off.

To make up: Block parts to size and leave to dry under a damp cloth. Sew shoulder seams. Sew polo neck st by st to neck with backstitches through open loops and unravelling contrast yarn. Seam polo neck. With right sides together, sew sleeves to back and front. Sew sleeves and side seams with mattress stitch.

Pattern sheets see pp 43

Length per 100 g =
 Acryl/mohair blue 620 m
 Wool lilac and olive 900 m
 Mohair/nylon black 600 m

Colour sequence

- 2 R blue
- 2 R lilac
- 2 R olive
- 2 R black

DECO 1

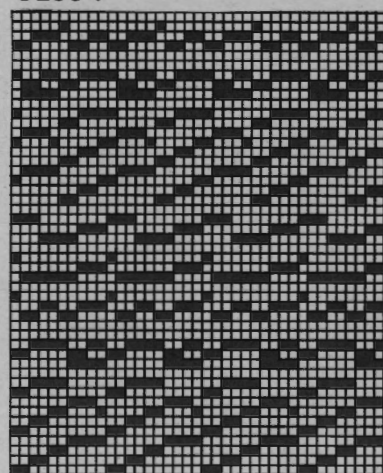
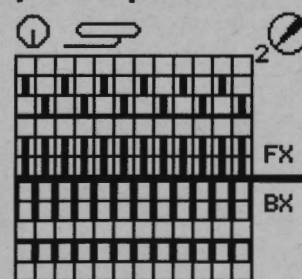

Diagram for 4 colour Fairisle [TECH 210]



DECO 2



5909 DUOMATIC 80/S ELECTRONIC 6000 5918

Child's trousers for 5919

Model T. Roganova Russia

[Instructions for ELECTRONIC 6000 in square brackets]

Size: To fit 116 cm height

Material: 80 g wool brown, 40 g wool lilac, 45 cm elastic

Stitch size: Pattern = 4 1/4

Test square: 100 st (counted on front bed) = 36.5 cm, RC 100 = 13.5 cm

Pattern: 2 colour Fairisle single colour according to diagram and colour sequence [according to diagram, TECH 183], waistband stocking stitch [TECH 100]

Fig.V: Trousers

A = tubular cast on with brown wool K/K [cast on 2], cont to knit acc diagram and col seq [acc diagram TECH 183] and inc on both sides. B = shape both sides, cont to knit. C = transfer all st to front bed st.s 5 and knit with stocking st [TECH 100], cast off.

To make up: Block parts to size and leave to dry under a damp cloth. Sew leg as well as front and rear seams with mattress stitch. Fold over waistband on inside and seam. Pull elastic through.

Length per 100 g =
Wool brown 300 m
Wool lilac 720 m

<u>Colour sequence for</u> <u>DUOMATIC 80/S</u>	<u>Colour sequence for</u> <u>ELECTRONIC 6000</u>
2 R lilac	2 R brown
2 R brown	2 R lilac

Fig.V + VI

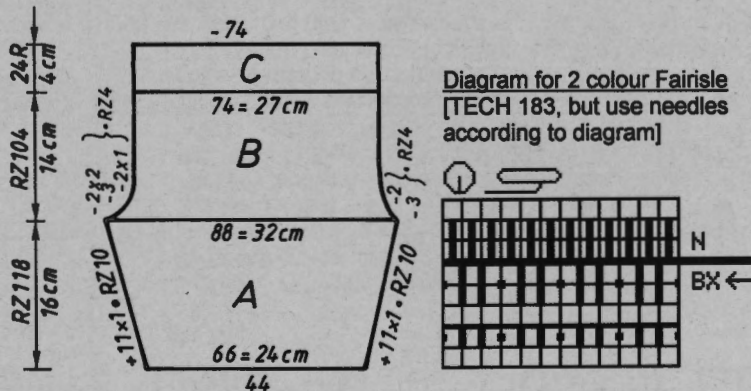

	Fig.V			
	104	116	128	140
1	54	54	54	54
2	146	146	146	146
3	.	.	.	A
4	.	.	.	B
5	63	66	68	71
6	3	3	3	3
7	3	3	3	3
8	38	38	38	38
9	85	88	93	101
10	3	3	3	3
11	3	3	3	3
12	11	15	18	21
13	12	16	19	22
14	.	.	.	**
15	97	97	97	97
16	132	132	132	132
17	69	69	69	69
18	164	164	164	164
19	154	154	156	154
20	164	148	148	148
21	135	135	135	135
22	27	35	50	64
23	70	70	70	70
24	154	154	154	154
25	146	146	146	146
26	135	135	135	135
27	33	41	56	70
28	193	193	193	193
29	2	2	2	2
30	131	131	131	131
31	.	.	.	C
32	135	135	135	135
33	136	136	136	136
34	0	0	0	0

	Fig.I			Fig.II			Fig.III		
	34/3638/4042/44			34/3638/4042/44			34/3638/4042/44		
1	34	34	34	34	34	34	34	34	34
2	168	168	168	168	168	168	168	168	168
3	.	.	A	.	.	A	.	.	A
4	.	.	B	.	.	B	.	.	B
5	112	121	131	112	121	131	57	60	62
6	82	90	98	82	90	98	3	3	3
7	.	.	**	.	.	**	3	3	3
8	195	195	195	195	195	195	195	195	195
9	.	.	C	.	.	C	.	.	C
10	135	135	135	135	135	135	135	135	135
11	133	133	133	133	133	133	156	156	156
12	38	38	38	38	38	38	38	38	38
13	112	121	131	112	121	131	114	117	119
14	82	90	98	82	90	98	48	49	50
15	.	.	**	.	.	**	.	.	**
16	45	45	45	45	45	45	34	34	34
17	70	70	70	70	70	70	58	59	60
18	.	.	***	.	.	***	.	.	***
19	104	104	104	232	232	232	111	111	111
20	172	172	172	172	172	172	134	134	134
21	164	164	164	164	164	164	172	172	172
22	156	156	156	156	156	156	164	164	164
23	148	148	148	148	148	148	156	156	156
24	151	151	151	151	151	151	148	148	148
25	1	1	1	1	1	1	191	191	191
26	135	135	135	135	135	135	135	135	135
27	104	104	104	104	104	104	49	49	49
28	0	0	0	74	74	74	183	183	183
				184	184	184	5	5	5
				130	131	132	183	183	183
				156	156	156	1	1	1
				167	167	167	191	191	191
				1	1	1	129	129	129
				191	191	191	1	1	1
				128	128	128	0	0	0
				21	21	21			
				135	135	135			
				12	12	12			
				0	0	0			

5919 DUOMATIC 80/S ELECTRONIC 6000

Child's pullover with cats

Model T. Roganova Russia

[Instructions for ELECTRONIC 6000 in square brackets]

Size: To fit 116 cm height

Material: 180 g lilac and 30 g brown wool, 30 g yellow and 10 g orange wool.

Stitch size: 2 colour Fairisle = 4 1/4, long stitch = 3 1/2, 2:2 = 4 1/2.

Test square: Fig.I + II: 2 colour Fairisle : 100 st (counted on front bed) = 37 cm
RC 100 = 11.5 cm. Fig.III: long stitch = 100 st (counted on front bed) = 39 cm, RC 100 = 11 cm

Pattern: Single bed Fairisle 2 colour "windows" according to diagram 1 and colour sequence with self-punched DECO cards 1 [pattern sheet 1, TECH 176]. Double bed Fairisle 2 colour "roof" Fairisle stitch plain according to diagram 2 (results in a roof without slope) [with self-drawn pattern sheets. Pattern sheet 2 ADD pattern sheet 3, ALTER = ENT, 3.COL = NO, DIST.R = NO, DIST STS = 0, ADD pattern sheet 4, ALTER = ENT, DIST.R = NO, DIST STS = 0. TECH 183] Fairisle "cats" acc to diagram 3 and col sequence with selfpunched DECO card 2 [with pattern sheet 5 TECH 183, POSITION = ENT REP. R = NO, REP M = NO.] Two colour fairisle "starry sky" acc to diagram 3 and col sequence with selfpunched DECO card 3 [with pattern sheet 6, TECH 183] Sleeves and neck binding 2:2 [cast on 4, con to knit] Pattern E : long stitch [TECH 117]

Fig.I: Back

A = simple cast on with contrast yarn for stocking stitch [cast on 6]. Knit single bed Fairisle "window" acc to diagram 1 with col seq [pattern sheet 1, TECH 176]. Cast on the rear bed nds, unravel the contrast yarn, 2R locks rear and front N [ELECTRONIC as well]. B = knit with brown wool st.s 4, lock rear GX, front N, knit 8 R, locks rear and front CX, knit RC 11, locks rear and front N, knit 1 R [ELECTRONIC as well]. Double bed Fairisle "roof" acc to diagram 2 with col seq 2R brown, 2R lilac fine [with pattern sheet TECH 183] knit RC 76. Knit over the central 42 st a tuck of 4 R, bring the pusher's of these nds into the working position. Lock rear GX, front BX [LX]. Then cont to knit long st [TECH 117] with lilac wool. C = shape both sides for sleeve, cast off.

Fig.II: Front

A = as in Fig.I. B = knit double bed Fairisle "roof" as in Fig.I. Tucks as well, knit then double bed Fairisle "cats" acc to diagram 3 and col seq with DECO punchcard 2. 1st positioning pin to the right of the knitting, 2nd positioning pin under nd 20 right, 3rd positioning pin under nd 21 left of centre [with pattern sheet 5, TECH 183] knit RC 76. Knit orange bow tie, acc to diagram 4 knit DECO to the left of the bow tie as with DUOMATIC] lock rear GX, front BX [LX]. Knit 20 R over pusher under nd 1 left - 11 to the right of centre. Reset row counter, knit with DECO punchcard 2 with col seq to RC 120 [switch ELECTRONIC 6000 BOX on again, cont to knit TECH 183]. C = shape both sides for sleeve, finish knitting double bed Fairisle "cats". Knit double bed Fairisle "starry sky" acc to diagram 3 and col seq with DECO punchcard 3 [with pattern sheet 6 TECH 183]. D = divide work, cast off centre st (if you knit without FORM program, make a note of the electronic row counter), place left half onto decker combs. Cont to knit right half, and shape left for neck, cast off. Put left part back onto the same nds as before and finish knitting with reversed shape.

Fig.III: Sleeves, knit 2

A = tubular cast on 2:2 [cast on 4, cont to knit]. B = bring all nds to the working position, knit with long st [TECH 117] and inc on both sides. C = shape both sides for sleeve head, cast off.

Neckband: tubular cast on 2:2 with yellow wool [cast on 4, cont to knit] over 110 nds, st.s 4 1/2, knit 20 R, bring all nds to the working position, locks rear and front CX [ELECTRONIC as well] knit 12 R, end with a few R of contrast yarn, cast off.

To make up: Block parts to size and leave to dry under a damp cloth. Sew shoulder seams. Sew neckband st by st to neck with backstitches through open loops and unravelling contrast yarn. Fold over 2:2 and seam down on inside. With right sides together, sew sleeves to back and front. Sew sleeves and side seams with mattress stitch.

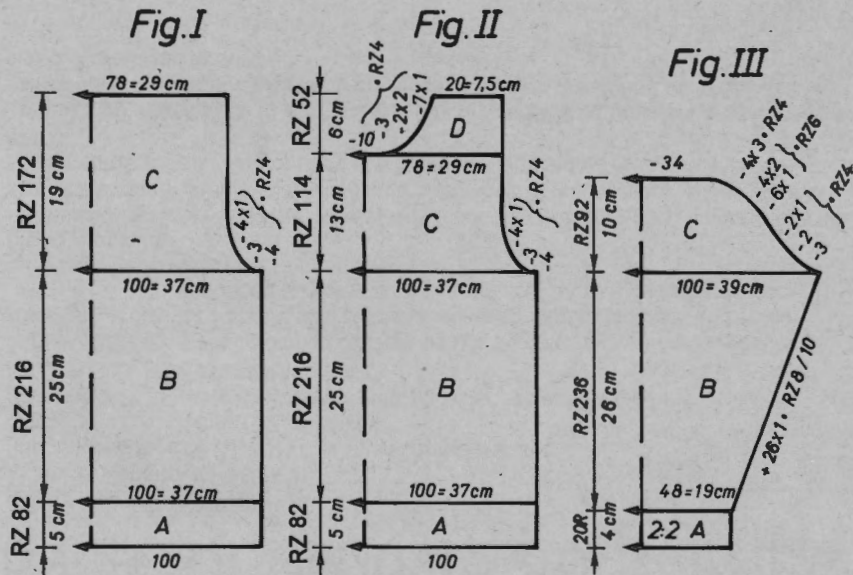

Length per 100 g =
Wool lilac and brown 300 m
Wool yellow and lilac 720 m

5919

Diagram 1 for Fairisle single bed
[TECH 176]

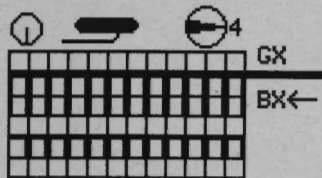

Diagram 2 for plain Fairisle
[TECH 183]

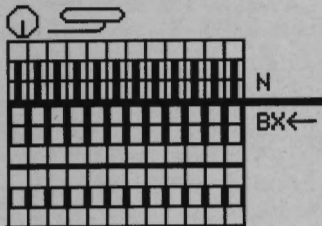

Diagram 3 for 2 colour Fairisle
[TECH 183]

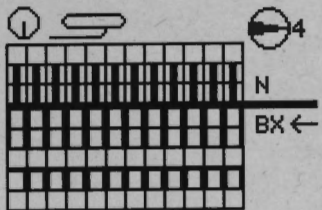
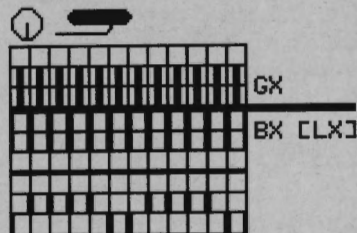
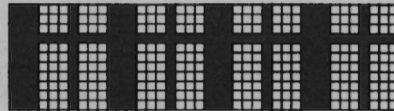

Diagram 4 for bow tie
[ELECTRONIC as well]



DECO 1 Pattern sheet 1



Pattern sheet 2

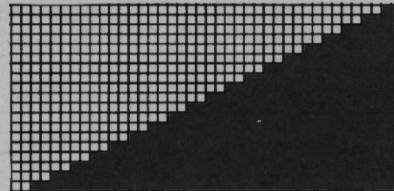

Pattern sheet 3



Pattern sheet 4

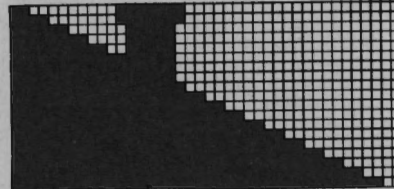

DECO 2 Pattern sheet 5

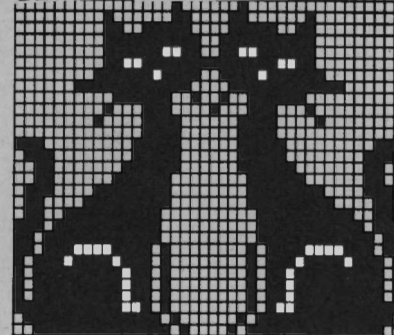

DECO 3 Pattern sheet 6

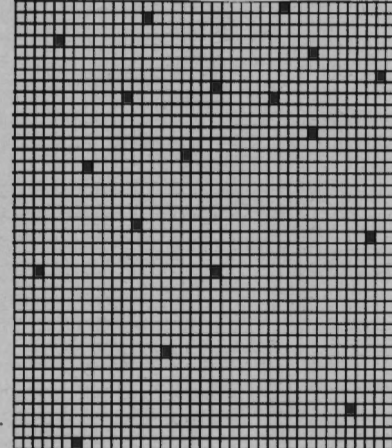

Fig.I

	104	116	128	140
1	46	46	46	46
2	148	148	148	148
3	.	.	.	A
4	.	.	.	B
5	97	100	105	111
6	58	60	64	68
7	.	.	.	**
8	195	195	195	195
9	.	.	.	C
10	135	135	135	135
11	142	142	142	147
12	38	38	38	38
13	97	100	105	111
14	58	60	64	68
15	.	.	.	**
16	23	25	27	28
17	47	49	52	55
18	.	.	.	***
19	102	102	102	102
20	162	162	162	162
21	154	154	154	154
22	167	167	167	167
23	1	1	1	1
24	135	135	135	135
25	57	57	68	72
26	0	0	0	0

Fig.II

	104	116	128	140
46	46	46	46	46
148	148	148	148	148
.	.	.	.	A
.	.	.	.	B
97	100	105	111	46
58	60	64	68	3
.	.	.	.	**
195	195	195	195	195
.	.	.	.	C
135	135	135	135	135
142	142	142	147	139
38	38	38	38	38
97	100	105	111	97
58	60	64	68	38
.	.	.	.	**
23	25	27	28	21
47	49	52	55	37
.	.	.	.	***
230	230	230	230	108
162	162	162	162	132
154	154	154	154	154
167	167	167	167	146
1	1	1	1	148
135	135	135	135	183
57	57	68	72	11
71	71	71	72	191
160	168	176	184	129
154	154	154	128	5
164	164	164	154	191
191	191	191	164	133
128	128	128	191	1
7	7	7	128	0
132	132	132	7	.
0	0	0	132	.
.	.	.	.	0

Fig.III

	104	116	128	140
44	44	44	44	44
156	156	156	156	156
.	.	.	.	A
.	.	.	.	B
46	49	51	54	46
3	3	3	3	3
.	.	.	.	**
195	195	195	195	195
.	.	.	.	C
135	135	135	135	135
139	139	139	143	139
38	38	38	38	38
97	100	103	105	97
38	39	40	41	38
.	.	.	.	**
21	24	27	29	21
41	45	49	49	41
.	.	.	.	***
108	108	108	108	108
132	133	133	133	132
154	154	154	154	154
146	146	148	146	146
148	148	191	191	148
183	183	129	133	183
11	11	13	18	11
191	191	191	191	191
129	129	128	128	129
5	5	7	7	5
191	191	191	191	191
133	133	133	133	133
1	1	1	1	1
0	0	0	0	0
.
0	0	0	132	.
.	.	.	.	0

Colour sequence for
"cats" and "starry sky"
2R lilac
2R yellow

5924 DUOMATIC 80 ELECTRONIC 6000

Lady's jacket with flowers

Model Kathe Keck USA

[Instructions for ELECTRONIC 6000 in square brackets]

Size: To fit 88 - 92 cm bust

Material: 130 g cotton pale turquoise, 110 g dark turquoise, 90 g pale blue and dark pink, 85 g lilac, 80 g blue and red, 75 g pale pink, 70 g pink and dark green. 160 g cotton pale green, 60 g black. 180 g chenille yellow, 80 g white. A bobbin each of lurex green and lilac. 5 buttons.

Stitch size: 3 + 4 colour Fairisle = 5, hem = 4

Test square: Fairisle : 100 st (counted on front bed) = 38.5 cm, RC 100 = 7.5 cm, long stitch : 100 st (counted on front bed) = 36 cm, RC 100 = 16.5 cm.

Pattern: 4 colour Fairisle according to diagram 1 and colour sequence with self-punched DECO cards [self-drawn pattern sheets
 Pattern A : read in pattern sheet 1 with continuation 2, ALTER = ENT, $c \rightarrow n$, ADD pattern sheet 3 with continuation 4, ALTER = ENT, $c \rightarrow n$, 3.COL = ENT, ADD pattern sheet 5 with continuation 6, ALTER = ENT, $c \rightarrow n$, 4.COL = ENT, TECH 207.

Pattern B : read in pattern sheet 7 with continuation 8, ALTER = ENT, $c \rightarrow n$, ADD pattern sheet 9 with continuation 10, ALTER = ENT, $c \rightarrow n$, 3.COL = ENT, ADD pattern sheet 11 with continuation 12, ALTER = ENT, $c \rightarrow n$, 4.COL = ENT, TECH 207]. Plain Fairisle acc diagram 2 and col seq [TECH 207].

Long st with col seq for sleeves [TECH 207]

[Pattern D : read in pattern sheet 13 with continuation 14, ALTER = ENT, $c \rightarrow n$, read in pattern sheet 15 with continuation 16, ALTER = ENT, $c \rightarrow n$, 3.COL = ENT, ADD pattern sheet 17 with continuation 18, ALTER = ENT, $c \rightarrow n$, 4.COL = ENT, TECH 207, ENLARGE POSITION, TO RE./TO LI + 4 (2nd part - 4) \uparrow REP R = NO, \leftrightarrow REP ST = NO.

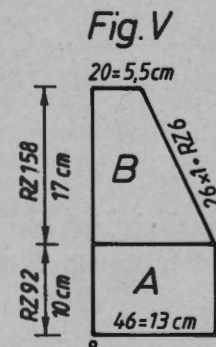
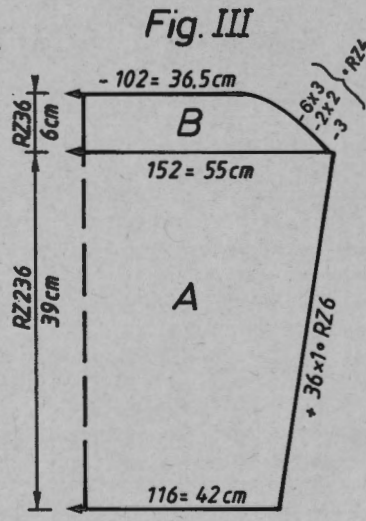
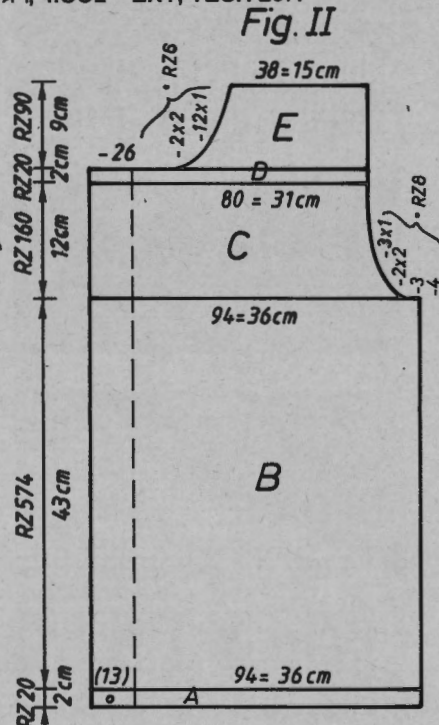
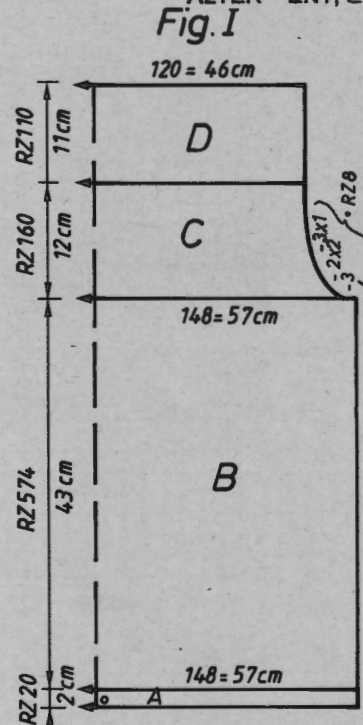

Fig. I: Back

A = closed tubular cast on with 4 strand lilac cotton and lilac lurex [cast on 8, cont to knit]. B = knit with DECO punchcards acc to diagram 1 and col seq. Put 1st positioning pin to the right of the knitting, 2nd positioning pin under nd 60 right of centre, 3rd positioning pin under nd 61 left of centre. Cont to knit after col seq, [knit with pattern A and col seq, after RC 320, change to pattern B at end of cast on]. C = shape both sides for sleeve, cont to knit with pattern. D = knit tuck with pale blue cotton 4 strands st.s 5, knit 2 R lock rear and front N. Lock rear GX, front N, knit 8 R, repeat tuck as follows 1 x pale blue, 2 x pale turquoise, 2 x dark turquoise, 2 x blue [ELECTRONIC as well], cast off.

Fig. II: Front, knit two reversed parts

A = closed tubular cast on with 4 strand lilac cotton and lilac lurex [cast on 8, cont to knit]. B = knit with DECO punchcards acc to diagram 1 and col seq. Put 1st

Length per 100 g =

Cotton blue, dark turquoise, pale turquoise, pale blue pale pink, pink, dark pink, red, dark green, 1000 m

Cotton pale green and black 385 m

Rayon/chenille white and gold 380 m

Lurex lilac and green 1500 m

5924

positioning pin to the right of the knitting, 2nd positioning pin under nd 24 right of centre, 3rd positioning pin under nd 17 left of centre. After the end of DECO punchcard RC 528, cont to knit plain Fairisle acc to diagram and col seq [with pattern D TECH 207]. C = tuck as in Fig.1. D = shape left for neck, cont to knit tuck, cast off. 2nd part, put 1st positioning pin to the right of the knitting, 2nd positioning pin under nd 17 right of centre, 3rd positioning pin under nd 24 left of centre. Work in a buttonhole over the nds 25-28 and 38-41 right of centre in the RC 240, 396, 552 and 708.

Fig.III: Sleeves, knit 2

A = tubular cast on for K/K [cast on 2], knit long st with col seq [TECH 117] and inc on both sides. B = shape both sides for sleeve head, cast off.

Fig.V: Pockets, knit 2

A = tubular cast on with blue cotton [cast on 8] cont to knit semi-circle left open [TECH 109]. B = shape right, cast off

Cuffs: knit 2

Tubular cast on for K/K [cast on 2] over 62 nds with lilac and blue cotton double stranded, st.s 5, knit 38 R. Knit 17 R double stranded with lilac cotton and lilac lurex, st.s 4, lock rear GX, front N, 1 R lock rear and front N. Knit 30 R double stranded with blue and lilac cotton, st.s 5. Knit 17 R double stranded with lilac cotton and lilac lurex, st.s 4, lock rear GX, front N, 1 R lock rear and front N, cast off.

Neckband: tubular cast on 4 stranded with pale turquoise cotton 1:1 [cast on 1, cont to knit] over 128 nds st.s 5, knit 24 R. Bring all nds to the working position, lock rear and front CX, st.s 4, knit 14 R [ELECTRONIC as well], end with a few R of contrast yarn, lock N/N, cast off.

To make up: Block parts to size and leave to dry under a damp cloth. Sew shoulder seams. Turn trim inside, sew neckband st by st to neck with backstitches through open loops and unravelling contrast yarn, seam down on inside. Gather sleeve front and sew on cuffs. With right sides together, sew sleeves to back and front. Sew pockets on side seam about 7 cm from hem. Sew sleeves and side seams. Sew on buttons.

Diagram 1 for 4 colour Fairisle
[TECH 207]

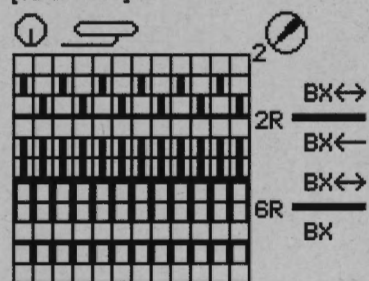
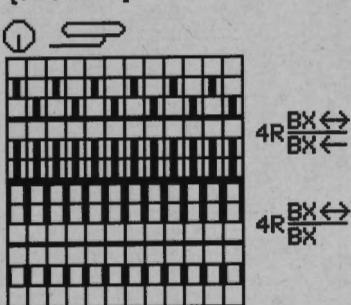

Diagram 2 for plain Fairisle
[TECH 207]



Colour sequence: for back (str = strands)

- RC 0-40 2R lilac 3 str
2R black
2R white
2R green + lurex thread
- RC 41-96 2R lilac 2 str + blue 1 str
2R black
2R white
2R green + lurex thread
- RC 97-152 2R lilac 2 str + blue 1 str
2R pale pink 3 str
2R yellow
2R green + lurex thread
- RC 152-200 2R blue 3 str
2R pale pink 2 str + pink 1 str
2R yellow
2R green + lurex thread
- RC 201-272 2R blue 2 str + dark turquoise 1 str
2R pale pink 2 str + pink 1 str
2R yellow
2R green + lurex thread
- RC 273-304 2R dark turquoise 3 str
2R pink 2 str + dark pink 1 str
2R yellow
2R green + lurex thread
- RC 305-344 2R dark turquoise 2 str + pale turquoise 1 str
2R dark pink 2 str + pink 1 str
2R yellow
2R green + lurex thread
- RC 345-376 2R dark turquoise 2 str + pale turquoise 1 str
2R dark pink 3 str
2R yellow
2R green + lurex thread
- RC 377-472 2R pale blue 2 str + dark turquoise 1 str
2R dark pink 2 str + red 1 str
2R yellow
2R green + lurex thread
- RC 473-504 2R pale blue 2 str + dark turquoise 1 str
2R red 2 str + dark pink 1 str
2R yellow
2R green + lurex thread
- RC 505-680 2R pale blue 2 str + blue 1 str
2R red 2 str
2R yellow
2R green + lurex thread
- RC 681-736 2R pale blue 3 str
2R red 2 str
2R yellow
2R green + lurex thread

Colour sequence: for front

- RC 0-504 as in Fig.1
- RC 505-560 2R pale blue 2 str + blue 1 str
2R red 2 str
2R yellow
2R green + lurex thread
- RC 561-736 2R pale blue 3 str
2R red 2 str
2R yellow
2R green + lurex thread

Colour sequence: for sleeves

- RC 0-14 lilac 3 str
- RC 15-28 lilac 2 str
+ blue 1 str
- RC 29-54 blue 2 str
+ lilac 1 str
- RC 55-68 blue 3 str
- RC 69-80 blue 2 str
+ dark turquoise 1 str
- RC 81-98 dark turquoise 2 str
+ blue 1 str
- RC 99-112 dark turquoise 3 str
- RC 113-138 dark turquoise 2 str
+ pale turquoise 1 str
- RC 139-168 pale turquoise 2 str
+ dark turquoise 1 str
- RC 169-194 pale turquoise 3 str
- RC 195-206 pale turquoise 2 str
+ blue 1 str
- RC 207-218 pale turquoise, blue
+ pale blue each 1 str
- RC 219-248 pale blue 2 str
+ blue 1 str
- RC 249-272 pale blue 3 str

Fig.I			Fig.II			Fig.III			Fig.V
34	38/4042/44		34/3638/4042/44			34/3638/4042/44			34/44
30	30	30	30	30	30	66	66	66	44
154	154	154	409	409	409	144	144	144	112
		A			A			A	A
		B			B			B	B
138	148	158	88	94	99	114	117	119	46
82	90	98	82	90	98	3	3	3	3
		**			**	3	3	3	3
195	195	195	195	195	195	38	38	38	38
		C			C	150	153	156	46
135	135	135	135	135	135	54	55	56	3
134	134	134	134	134	134			**	3
38	38	38	38	38	38	38	38	38	10
138	148	158	88	94	99	58	59	60	3
82	90	98	82	90	98			***	3
		**			**	102	102	102	66
43	43	43	43	43	43	131	131	131	135
68	68	68	68	68	68	154	154	154	72
		***			***	164	164	164	67
107	107	107	235	235	235	191	191	191	191
164	164	164	164	164	164	139	139	139	147
156	156	156	156	156	156	5	5	5	72
167	167	167	167	167	167	0	0	0	0
1	1	1	1	1	1				
159	159	159	159	159	159				
5	5	5	5	5	5				
135	135	135	135	135	135				
45	45	45	45	45	45				
199	199	199	199	199	199				
2	2	2	2	2	2				
44	44	44	44	44	44				
0	0	0	70	70	70				
			184	184	184				
			147	147	147				
			158	166	182				
			191	191	191				
			133	133	133				
			29	29	29				
			0	0	0				

Pattern sheet 2

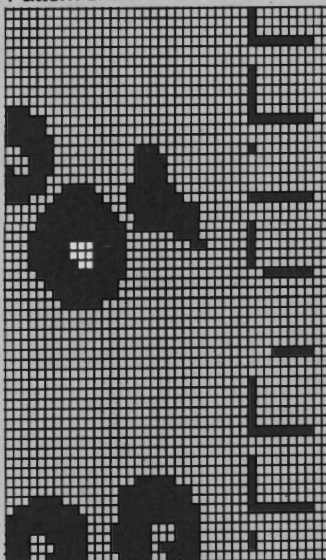

Pattern sheet 4

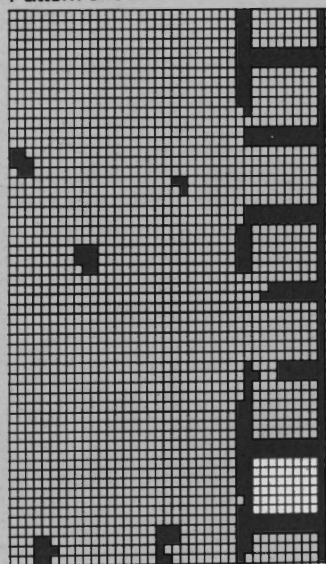

Pattern sheet 6

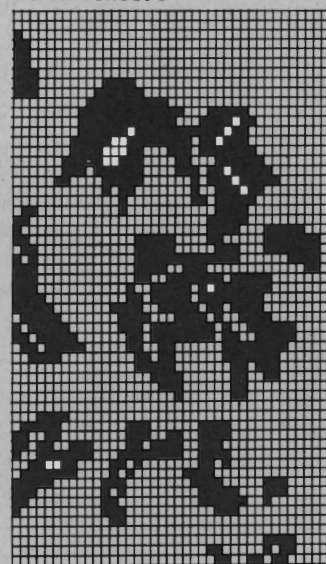

Pattern sheet 1

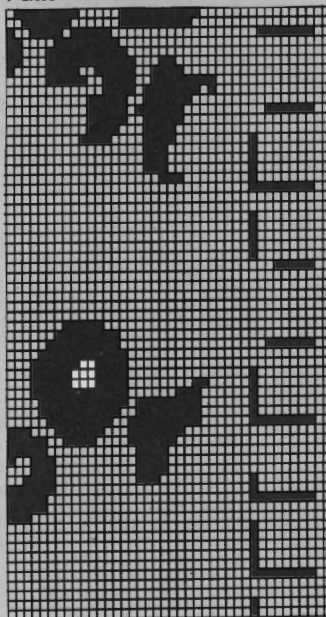

Pattern sheet 3

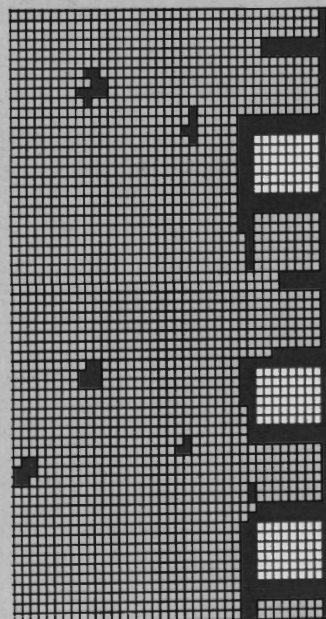

Pattern sheet 5

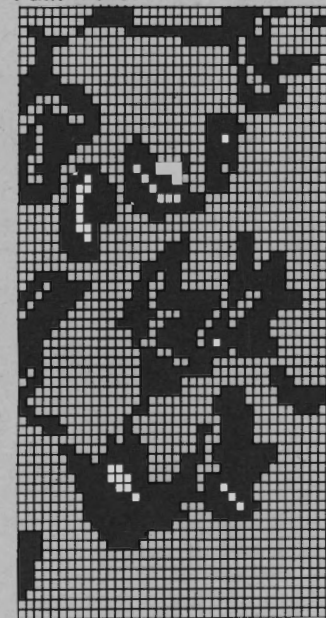

Pattern sheet 8

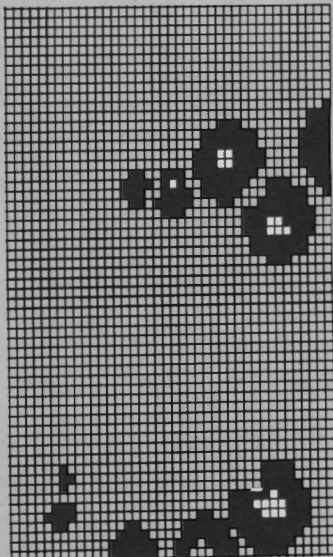

Pattern sheet 10

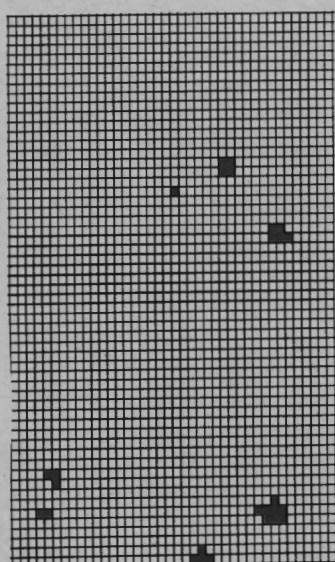

Pattern sheet 12

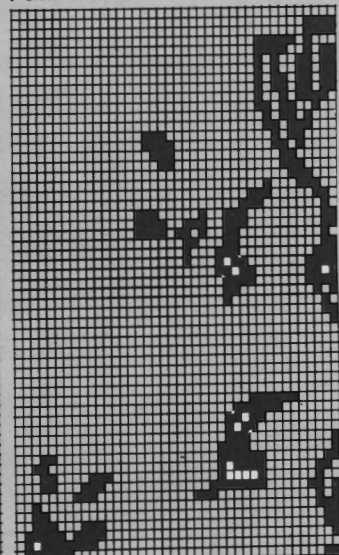

Pattern sheet 18

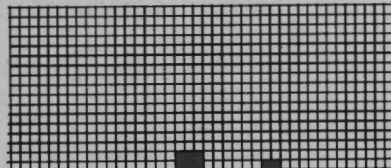

Pattern sheet 16

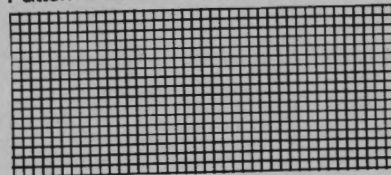

Pattern sheet 14

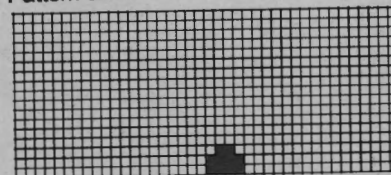

Pattern sheet 17



Pattern sheet 7

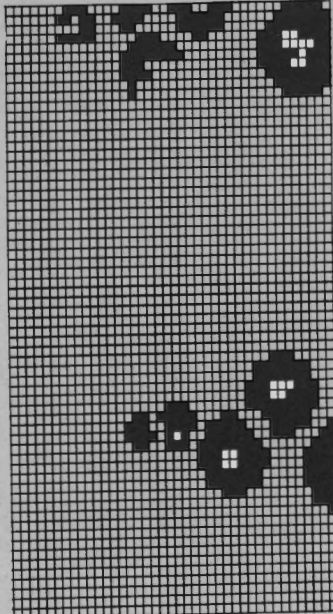

Pattern sheet 9

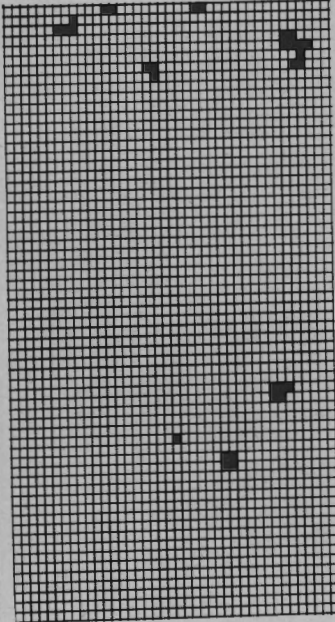

Pattern sheet 11

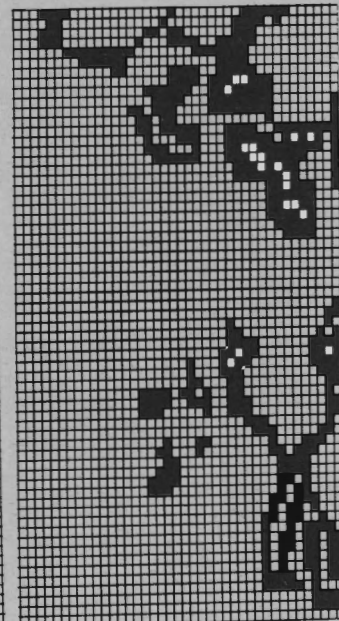

Pattern sheet 13

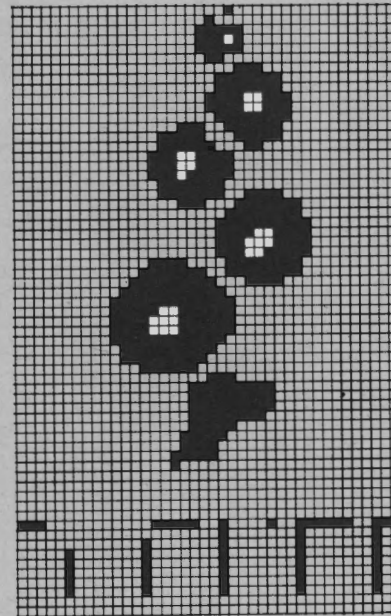

Pattern sheet 15

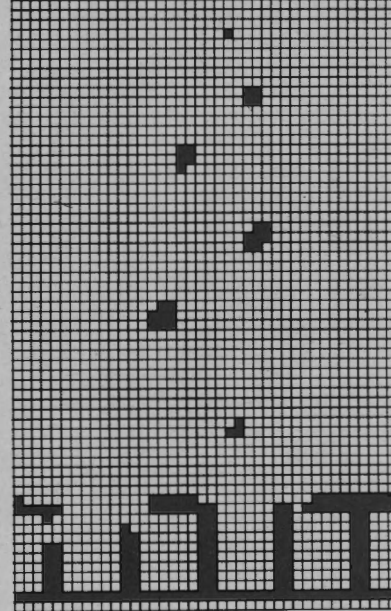

DECO 2

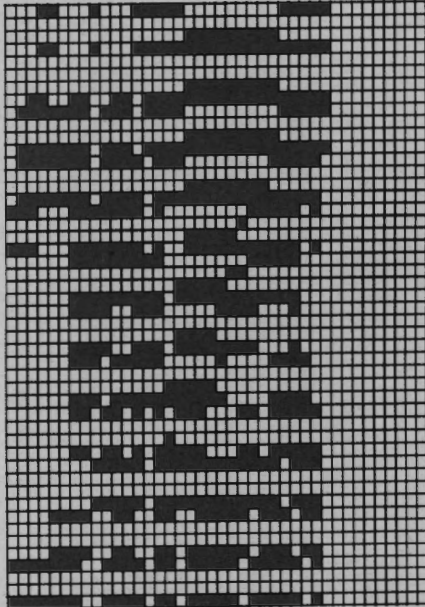

DECO 1

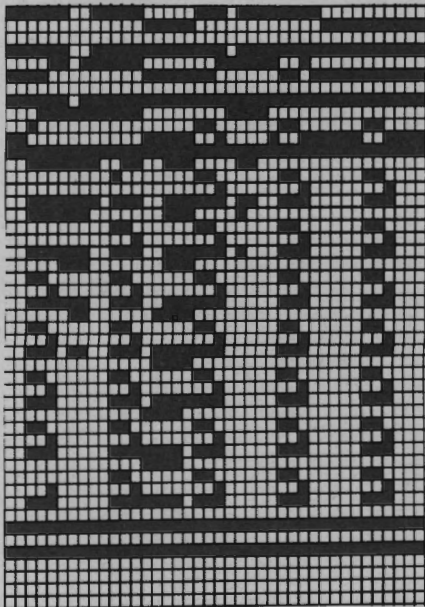

DECO 4

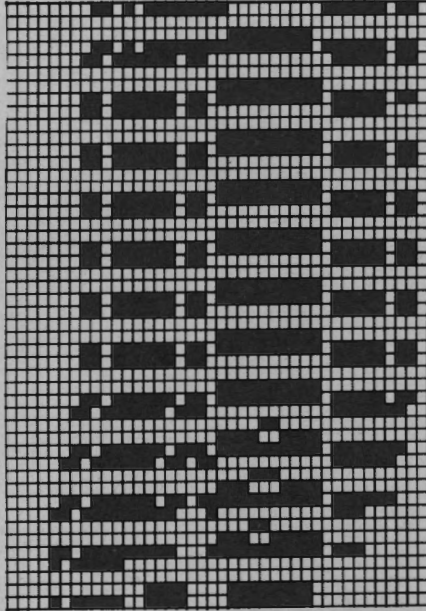

DECO 3

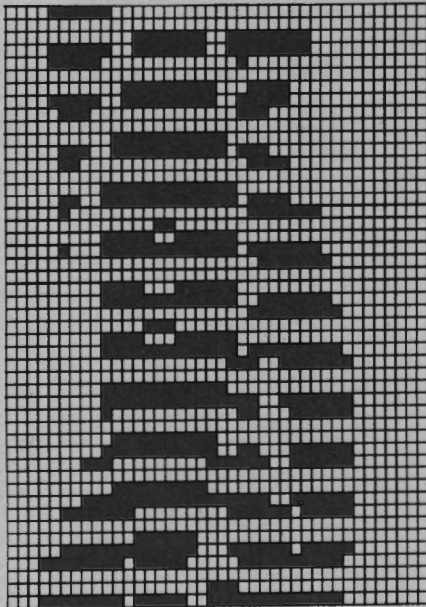

DECO 6

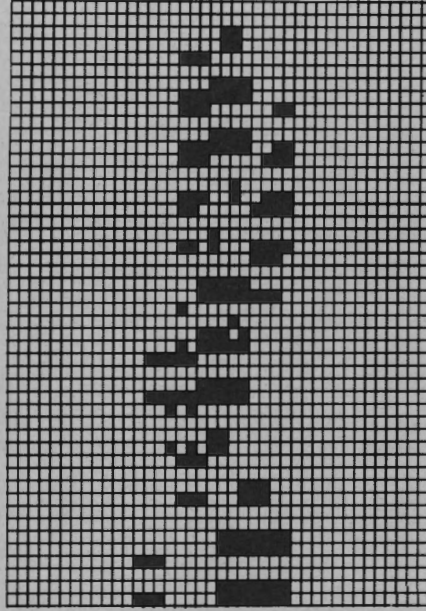

DECO 5

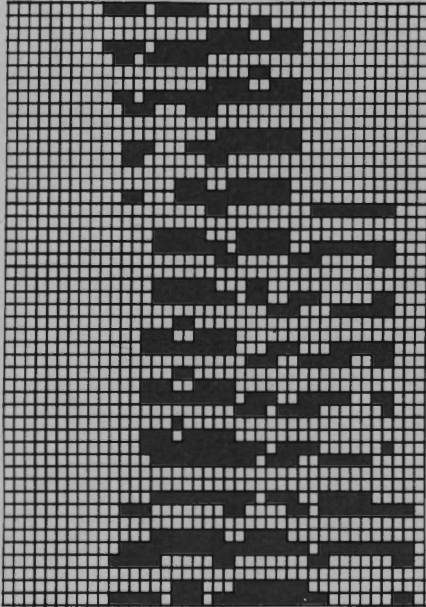

Fig.I Fig.II Fig.III
34/3638/4042/44 34/3638/4042/44 34/3638/4042/44

104	104	104	104	104	104	104	104	104
152	152	152	407	407	407	152	152	152
.	.	A	.	.	A	.	.	A
.	.	B	.	.	B	.	.	B
137	147	158	66	71	76	103	105	108
82	90	98	82	90	98	3	3	3
.	.	**	.	.	**	3	3	3
194	194	194	194	194	194	194	194	194
.	.	C	.	.	C	.	.	C
132	132	132	132	132	132	132	132	132
131	131	131	131	131	131	38	38	38
.	.	C	.	.	C	155	158	161
135	135	135	135	135	135	59	60	61
155	155	155	155	155	155	.	.	**
98	98	98	98	98	98	28	28	28
192	192	192	192	192	192	41	41	41
2	2	2	2	2	2	.	.	***
38	38	38	166	166	166	106	106	106
137	147	158	66	71	76	130	130	130
82	90	98	82	90	98	182	182	182
.	.	**	.	.	**	190	190	190
27	27	27	27	27	27	133	133	133
73	73	73	73	73	73	188	188	188
.	.	***	.	.	***	133	133	133
101	101	101	67	67	67	186	186	186
191	191	191	191	191	191	131	131	131
139	139	139	145	146	147	185	185	185
2	2	2	181	181	181	131	131	131
135	135	135	101	101	101	0	0	0
34	34	34	191	191	191	.	.	.
0	0	0	139	139	139	.	.	.
.	.	.	130	130	130	.	.	.
.	.	.	135	135	135	.	.	.
.	.	.	34	34	34	.	.	.
.	.	.	0	0	0	.	.	.

5926 DUOMATIC 80/S ELECTRONIC 6000

Length per 100 g = 430 m

Lady's cocktail jacket

Model Lana Chic, Rapperswil-Jona

[Instructions for ELECTRONIC 6000 in square brackets]

Size: To fit 88 - 92 cm bust

Material: 430 g Polyester/rayon white, fur hook and eyelet

Stitch size: Release pattern = 7

Test square: Pattern = 100 st 38 cm, 100 R = 20 cm, hole pattern : 100 R = 30 cm

Pattern: Lacy pattern for border: hang every 2nd - 6th stitch with a 5-decker needle, 1 stitch to the left onto the 1st stitch, hang the 8th - 12th stitches, 1 stitch to the right onto the 13th stitch. Continue to repeat the pattern, knit 52 R. Then begin the top edge: hang only 4 stitches 1 stitch to the left, to the right as well, knit 2 R, then using the same method, hang 3, 2 and 1 stitch to left and right [ELECTRONIC as well].
Release pattern according to diagram [ELECTRONIC as well]

Fig.I: Back

A = tubular cast on for 1:1 [cast on 1]. B = transfer all st to the front bed, knit lacy pattern for border [ELECTRONIC as well]. C = arrange nds acc diagram for release pattern, on the front bed, hang every 12th st onto the neighbouring nd. Knit release pattern acc to diagram [ELECTRONIC as well]. D = shape both sides for sleeve, cont to knit with pattern, cast off.

Fig.II: Front, knit two reversed parts

A + A as in Fig.I, but with different stitch count. C = knit release pattern acc to diagram [ELECTRONIC as well]. D = shape left for neck. E = shape right for sleeve, left for neck, cast off.

Fig.III: F Sleeves, knit 2

A = tubular cast on for 1:1 [cast on 1]. B = transfer all st to front bed, arrange nds acc to release pattern, knit pattern acc to diagram [ELECTRONIC as well], and inc on both sides. C = shape both sides, cast off.

Border for front edge and neck: knit 4

Tubular cast on for 1:1 [cast on 1, cont to knit] knit twice over 128 nds and twice over 120 nds, st.s 5, 8R, end with a few R of contrast yarn, cast off.

To make up: Block parts to size and leave to dry under a damp cloth. Sew shoulder seams. With right sides together, sew sleeves to back and front. Sew border together, st by st to front edge and neck with backstitches through open loops and unravelling contrast yarn. Sew on hooks and eyes. Sew sleeves and side seams with mattress stitch.

Fig.I

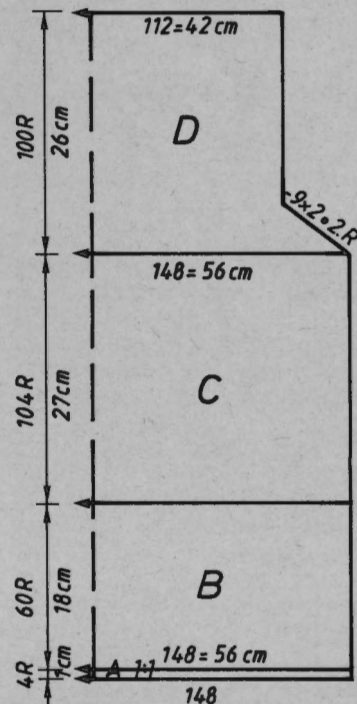

Fig. II

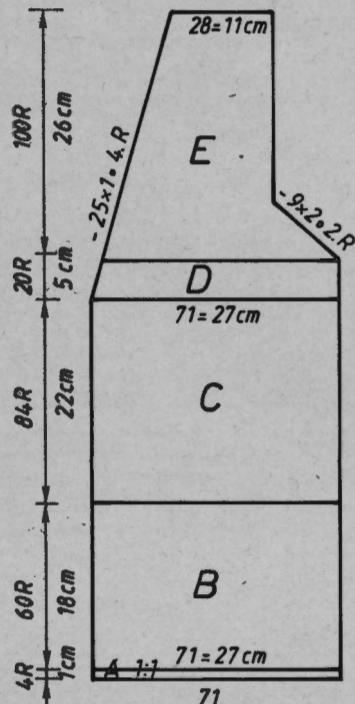

Fig. III

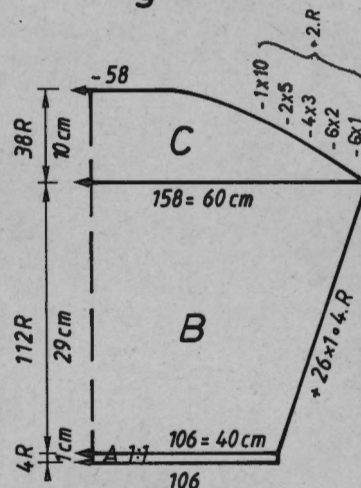
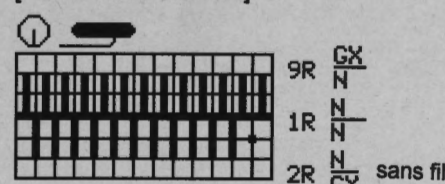

Diagram for release pattern [ELECTRONIC as well]



5925 DUOMATIC 80/S ELECTRONIC 6000

Length per 100 g = 250 m

Sleeveless dress

Model Lana Chic, Jona-Rapperswil

[Instructions for ELECTRONIC 6000 in square brackets]

Size: To fit 88 - 92 cm bust

Material: 630 g cotton-rayon, 25 buttons

Stitch size: Stocking stitch = 7, 1:1 = 4 1/2

Test square: 100 st = 37 cm, 100R 27.5 cm

Pattern: Stocking stitch [TECH 100], cuffs and neckband 1:1 [cast on 1, cont to knit]

Fig.I: Back, knit 2

A = tubular cast on for 1:1 [cast on 1, cont to knit]. B = transfer all st to front bed. Knit stocking stitch [TECH 100]. C = shape right with 3-Decker of sleeve. D = shape left for neck, right for sleeve.

Fig.II: Front

A = tubular cast on for 1:1 [cast on 1, cont to knit]. B = transfer all st to front bed. Knit stocking stitch [TECH 100]. C = shape both sides for sleeve. D = divide work, cast off centre, place left half onto decker combs and shape left for neck, right for sleeve, cast off.

Neckband: tubular cast on for 1:1 [cast on 1, cont to knit] over 144 nds, st.s 4 1/2, knit 30 R, end with a few R of contrast yarn, cast off.

Fig.III: Sleeve bindings, knit 2

A = tubular cast on for 1:1 over 136 nds [cast on 1, cont to knit]. After casting on, bring 100 pushers in the centre into working position, then inc with short rows, end with a few R of contrast yarn, cast off.

To make up: Block parts to size and leave to dry under a damp cloth. Sew shoulder seams. Sew neckband st by st to neck with backstitches through open loops and unravelling contrast yarn. Sew sleeve bindings st by st to sleeve hole with backstitches through open loops and unravelling contrast yarn. Sew side seams with mattress stitch. Crochet 1 row on the left edge of the back. Crochet 2 rows on the right edge of the back and work in the second row 25 eyelets. Sew buttons on.

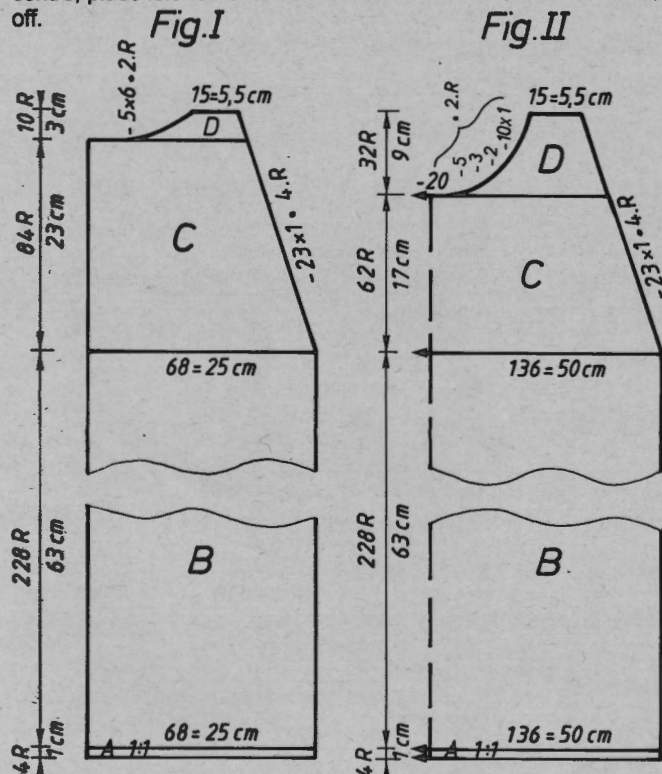

Fig.III

	34/44
1	108
2	140
3	A
4	B
5	100
6	3
7	3
8	102
9	129
10	184
11	139
12	54
13	62
14	133
15	0

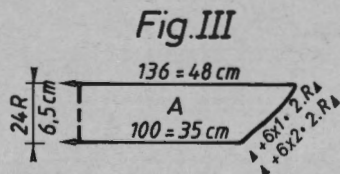

	Fig.I			Fig.II		
	34/3638/4042/44			34/3638/4042/44		
1	110	110	110	110	110	110
2	403	403	403	148	148	148
3	.	.	A	.	.	A
4	.	.	B	.	.	B
5	62	68	73	124	135	146
6	82	90	98	86	90	98
7	.	.	**	.	.	**
8	194	194	194	194	194	194
9	.	.	C	.	.	C
10	131	131	131	131	131	131
11	38	38	38	38	38	38
12	62	68	73	124	135	146
13	82	90	98	82	90	98
14	.	.	**	.	.	**
15	62	62	62	62	62	62
16	90	90	90	90	90	90
17	.	.	***	.	.	***
18	227	227	227	227	227	227
19	191	191	191	191	191	191
20	142	144	146	142	144	146
21	168	168	168	168	168	168
22	66	66	66	73	73	73
23	189	189	189	184	184	184
24	150	151	152	130	131	132
25	0	0	0	169	169	169
				153	153	153
				145	145	145
				191	191	191
				131	131	131
				3	3	3
				131	131	131
				0	0	0

5922 DUOMATIC 80/S ELECTRONIC 6000 PICTO

Length per 100 g = 720 m

Child's pullover Harlequin intarsia with PICTO

Model T. Roganova Russia

Size: To fit 116 cm height
 Material: 170 g red, 40 g lilac, 20 g rust and yellow and 10 g pink wool
 Stitch size: Stocking stitch = 5 1/2, hem = 4 1/2
 Test square: 100 st = 32 cm, 100 R = 20.5 cm
 Pattern: Intarsia according to pattern diagram with PICTO [ELECTRONIC as well]. Hem = tubular [cast on 8, cont to knit]

Fig.I: Back

A = closed tubular cast on with red wool [cast on 8, cont to knit]. B = transfer all st to front bed, cont to knit red stocking stitch [TECH 100]. C = shape both sides for sleeve. D = divide work, cast off centre, place left half onto decker combs. Cont to knit right half, and shape left for neck, cast off. Put left part back onto the same nds as before and finish knitting with reversed shape.

Fig.II: Front

A = closed tubular cast on with pink wool [cast on 8, cont to knit]. B = transfer all st to rear bed, knit intarsia with PICTO acc to pattern diagram [ELECTRONIC as well]. C = shape both sides for sleeve, cont to knit acc to pattern diagram. D = knit intarsia with PICTO right half lilac, left half red. E = divide work, cast off centre, place left half onto decker combs. Knit right half with lilac, and shape left for neck, cast off. Put left part back onto the same nds as before and finish knitting red wool with reversed shape.

Fig.III: Sleeves, knit 2

A = closed tubular cast on with red wool [cast on 8, cont to knit]. B = transfer all st to front bed, knit stocking stitch [TECH 100], and inc both sides. C = shape both sides

for sleeve head, cast off.

Neckband: Closed tubular cast on with rust wool [cast on 8, cont to knit] over 80 nds, st.s 4, knit RC 16, end with a few R of contrast yarn, lock N/N, release

Trimnings: Closed tubular cast on [cast on 8, cont to knit] knit RC 18, transfer all st to front bed, knit 1 R with lock front N, rear GX, end with a few R of contrast yarn, release.

Trim cords: Closed tubular cast on with yellow, rust and pink wool [cast on 8, cont to knit] over 3 nds on rear and front beds. St.s 4, knit RC 300, cast off.

To make up: Block parts to size and leave to dry under a damp cloth. With the small red trimming in the middle sew 4 cm from hem with mattress stitch. Sew on the pink trimming according to photo, sew the red and yellow trimmings 2.5 cm higher and unravel contrast yarn.

Sew trim cords on according to photo. Seam one shoulder.

Sew neckband st by st to neck with backstitches through open loops and unravelling contrast yarn, seam down on inside and V-neck. Seam second shoulder.

With right sides together, sew sleeves to back and front. Sew sleeves and side seams with mattress stitch.

FORM programme see page 56

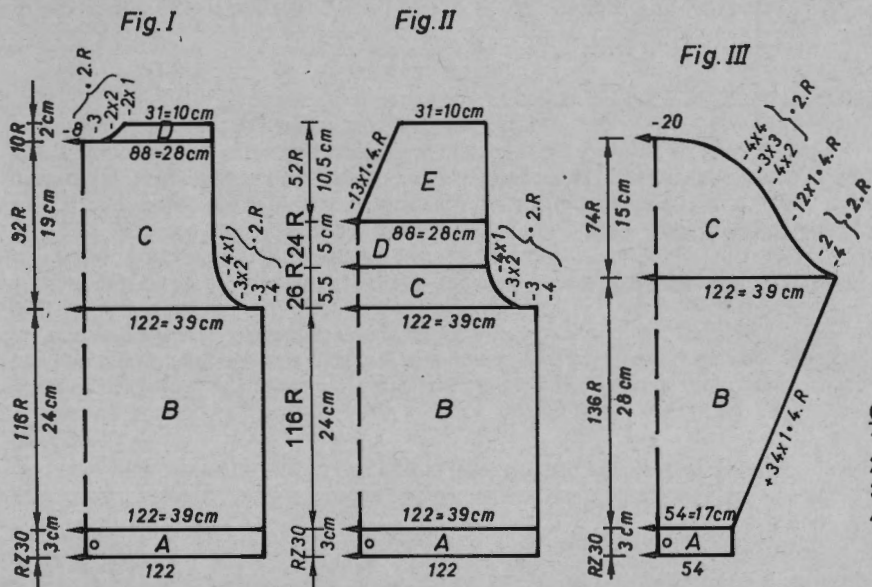

Colour:
 1 = lilac
 2 = yellow
 3 = rust
 4 = red

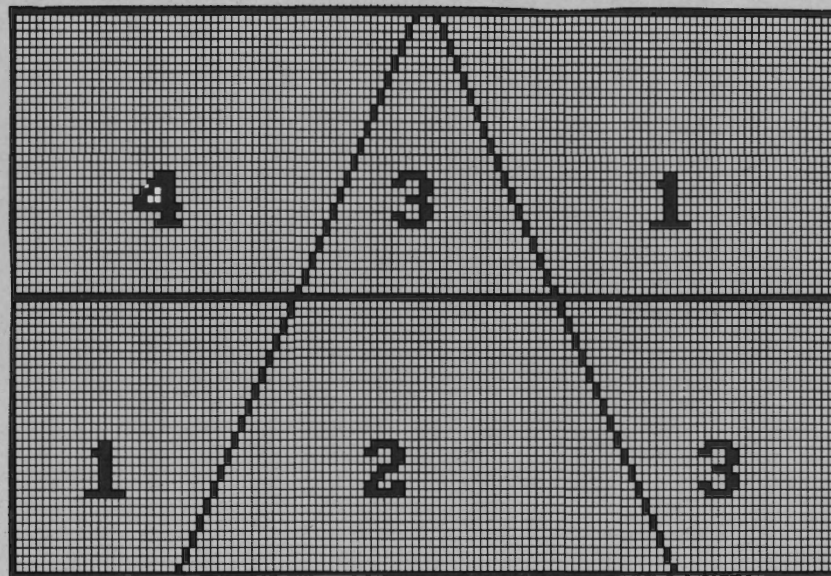

onto decker combs. Cont to knit right half, and shape left for neck, cast off. Put left part back onto the same nds as before and finish knitting with reversed shape.

Neckband:

Tubular cast on for 1:1 [cast on 1] over 66 nds. Transfer all st to front bed, knit stocking stitch [TECH 100], st.s 6, 20 R. Hang for 1:1, bring all nds on front and rear bed into the working position, lock rear and front CX [ELECTRONIC as well], knit RC 10, end with a few R of contrast yarn, cast off.

Cuffs:

Tubular cast on for 1:1 [cast on 1, cont to knit] over 50 nds, st.s 3 1/2, knit 20 R, end with a few R of contrast yarn, cast off.

To make up: Block parts to size and leave to dry under a damp cloth. Sew shoulder seams. Sew neckband st by st with backstitch to neck through open loops and unravelling contrast yarn, hem down on inside. Sew cuff st by st with backstitch to sleeve through open loops and unravelling contrast yarn. Crochet slit in back, and sew in zip. Sew inside leg seams with mattress stitch.

DECO card / pattern sheet

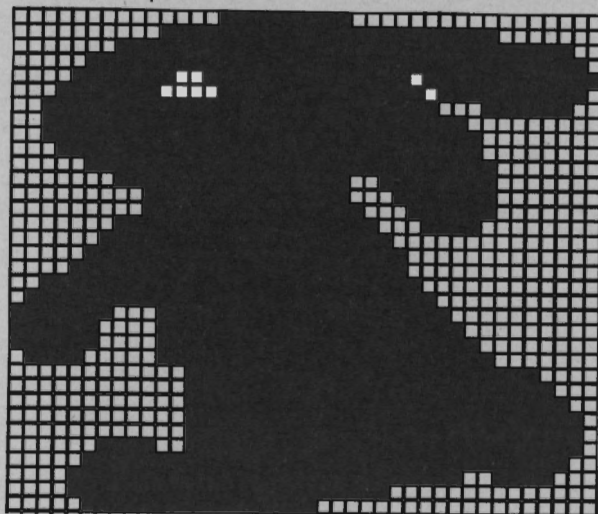

	Fig.I				Fig.II				Fig.III			
	116	128	140	152	116	128	140	152	116	128	140	152
1	82	82	82	82	82	82	82	82	82	82	82	82
2	128	128	128	128	128	128	128	128	128	128	128	128
3	.	.	.	A	.	.	.	A	.	.	.	A
4	.	.	.	B	.	.	.	B	.	.	.	B
5	116	122	128	141	116	122	128	141	50	53	56	59
6	60	64	68	76	60	64	68	76	3	3	3	3
7	.	.	.	**	.	.	.	**	3	3	3	3
8	195	195	195	195	195	195	195	195	195	195	195	195
9	.	.	.	C	.	.	.	C	.	.	.	C
10	135	135	135	135	135	135	135	135	135	135	135	135
11	128	128	128	128	128	128	128	128	128	128	128	128
12	38	38	38	38	38	38	38	38	38	38	38	38
13	116	122	128	141	116	122	128	141	119	122	125	128
14	60	64	68	76	60	64	68	76	38	39	40	41
15	.	.	.	**	.	.	.	**	.	.	.	**
16	23	24	27	30	23	24	27	30	23	26	30	33
17	46	48	51	55	46	48	51	55	41	45	49	53
18	.	.	.	***	.	.	.	***	.	.	.	***
19	230	230	230	230	230	230	230	230	108	108	108	108
20	161	161	161	161	161	161	161	161	130	130	130	130
21	153	153	153	153	153	146	153	153	161	161	161	161
22	179	179	179	179	179	179	179	179	145	145	145	145
23	164	164	164	164	164	164	164	164	191	191	191	191
24	135	135	135	135	135	135	135	135	133	133	133	133
25	33	35	35	38	33	35	35	38	14	17	17	19
26	68	68	68	69	67	67	67	67	188	188	188	188
27	152	160	168	184	191	191	191	191	129	129	129	129
28	153	153	153	128	133	134	135	137	187	187	187	187
29	162	162	162	153	145	147	147	149	130	130	130	130
30	146	146	146	162	0	0	0	0	188	188	188	188
31	0	0	0	146					137	137	137	137
32				0					0	0	0	0

5928 DUOMATIC 80/S ELECTRONIC 6000

Baby overall with rabbit

[Instructions for ELECTRONIC 6000 in square brackets]

Size: To fit 62 cm, 68 cm, 74 cm height

Material: 240 g wool turquoise (Brillanta from Conofil), 30 g angora pink, zip 30 cm

Stitch size: Stocking stitch = 6, band = 3 1/2, neckband = 6.

Test square: Stocking stitch : 100 st = 35 cm, 100 R = 23.5 cm

Pattern: Stocking stitch [TECH 100], single bed Fairisle with self-punched DECO cards [with self-drawn pattern sheet, TECH 176, POSITION = ENT, ↑ REP. R = NO, ↔ REP. ST = NO]
Leg and sleeve band = 1:1, [cast on 1, cont to knit]

Fig.I + II: Legs for back and front, knit two reversed parts.

A = tubular cast on for 1:1 [cast on 1, cont to knit]. B = transfer all st to front bed, knit stocking stitch [TECH 100] and inc on both sides. Transfer to decker comb.

Fig.Ia: Back

C = with a distance of '19 "' 20 left from center tubular cast on for 1:1 [cast on 1, cont to knit]. D = transfer all nds to front bed, knit stocking stitch [TECH 100] and inc on both sides. E = transfer the leg st from the decker comb back to the knitting

Diagram for single bed Fairisle
[TECH 176]

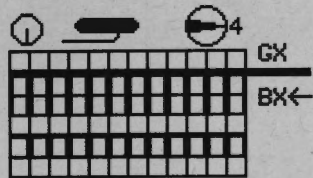

Length per 100 g =
Cotton turquoise = 385 m
Angora pink = 480 m

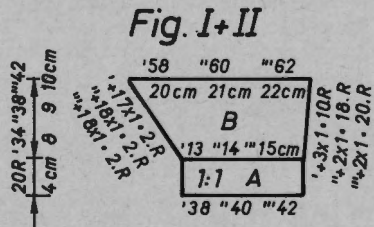

Fig. Ia

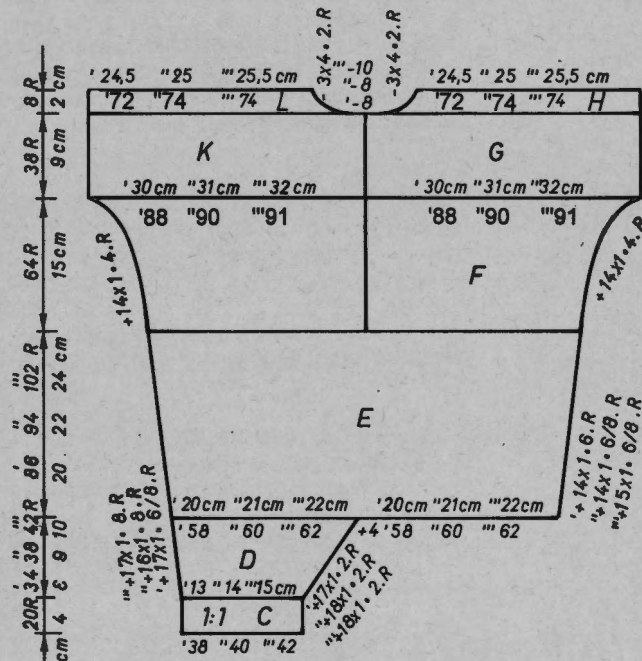
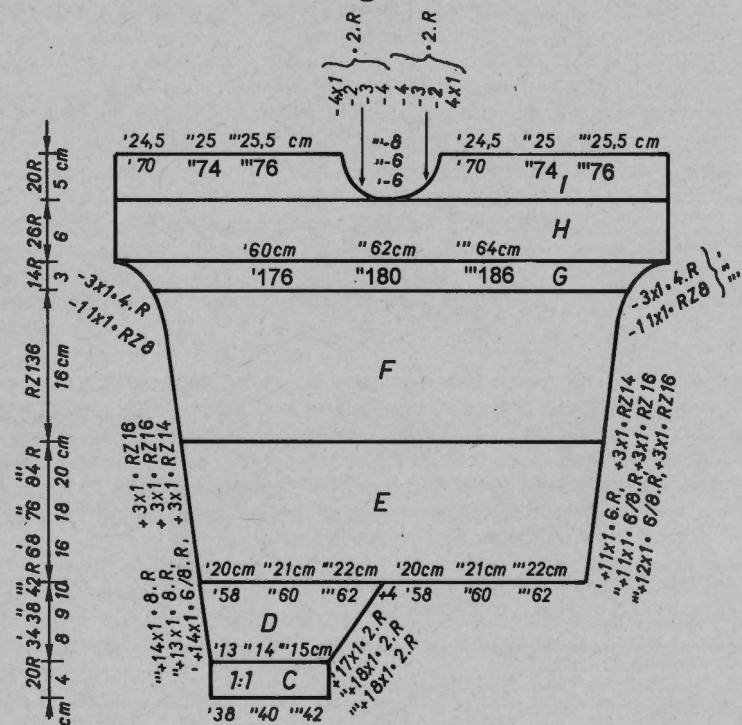

Fig.IIa



machine to the right in a distance of 4 nds. Of these 4 empty nds, bring 2 into the working position. Knit 1 R, bring the remaining 2 nds into the working position. Cont to knit stocking stitch [TECH 100], and inc on both sides. F = divide work, place left half onto decker combs, inc right, left knit straight. G = knit straight stocking stitch [TECH 100]. H = shape left for neck, knit right straight, cast off. Put left half back onto the same nds as before and finish knitting reversed shape for I, K and L.

Fig.IIa: Front

C, D + E knit as in Fig.Ia. F = knit single bed Fairisle acc to diagram and col seq knit 2 R turquoise, 2 R pink with DECO punchcard [with pattern sheet, TECH 176]. Put 1st positioning pin to right of the knitting, 2nd positioning pin under nd 20 to the right of centre, 3rd positioning pin under nd 21 left of centre. To achieve a nice transition between main and decoration colour, bring an extra nd on the rear bed into the working position where the colours meet. Lock rear CX [ELECTRONIC as well]. Every time when this position moves, bring a nd on the rear bed into the working position, hang the st on the new nd and take the old nd out of the working position, and inc on both sides. G = cont to knit stocking stitch [TECH 100], and inc on both sides. H = knit straight stocking stitch. I = divide work, cast off centre, place left half

5929 DUOMATIC 80/S ELECTRONIC 6000

Baby set

Model L. Poletti, CH-6467 Schattendorf

[Instructions for ELECTRONIC 6000 in square brackets]

Size: To fit 62/68/74 cm height

Material: 120 g wool/rayon blue (Noblesse from Conofil). 260 g wool pink. 2 buttons for pullover, 2 buttons for trousers, 4 buttons for jacket.

Stitch size: Pattern pullover, jacket and hat = 6. Trousers and braces = 6 1/2. Band 3.

Test square: 100 st = 41.5 cm, RC 16.5 cm

Pattern: According to diagram 1 [pattern 1000, TECH 169]. Band, neckband and shawl collar = 1:1 [cast on 1, cont to knit].

Baby pullover

Fig. I: Back

A = Tubular cast on for 1:1 with blue wool/rayon [cast on 1, cont to knit]. B = transfer all st to front bed, knit acc to diagram 1, 2 R blue, 2 R pink [pattern 1000, TECH 169], cast off right st. C = hang for 1:1 [TECH 101 or lock rear and front N]. St.s 3, knit with blue wool/rayon, cast off

Fig. II: Front

Knit A + B as in Fig. I, but RC from Fig. II. C = divide work, cast off centre st (if you knit without FORM program, make a note of the electronic row counter), place left half onto decker combs. Cont to knit right half, and shape left for neck. D = hang for 1:1 [TECH 101 or lock rear and front N]. St.s 3, knit with blue wool/rayon, cont to shape left for neck. In the 5th R in the centre, work in a buttonhole over 3 nds, cast off. E = put left part back onto the same nds as before, knit acc to diagram 1 and col seq, and shape right for neck, cast off.

Fig. III: Sleeves, knit 2

A = Tubular cast on for 1:1 with blue wool/rayon [cast on 1, cont to knit]. B = transfer all st to front bed, knit acc to diagram 1, 2 R blue, 2 R pink [pattern 1000, TECH 169], and inc on both sides, cast off.

Neckband: Tubular cast on for 1:1 with blue wool/rayon [cast on 1, cont to knit] over 70, 72, 74 nds, st.s 3, knit 8 R, over the last 4-7 nds outside left, work in a buttonhole. Bring all nds to the working position, lock rear and front CX [ELECTRONIC as well], st.s 4, knit RC 8, end with a few R of contrast yarn, cast off.

To make up: Block parts to size and leave to dry under a damp cloth. Sew right shoulder seam, lay left shoulder, front band on back band. With right side together, sew back and front. Sew neckband st by st to neck with backstitch through open loops and unravelling contrast yarn, hem down on inside. Sew sleeve and side seams with mattress stitch.

Baby shoes, knit 2

A = tubular cast on for 1:1 with pink wool [cast on 1, cont to knit] cont to knit with pink wool. B = cont to knit and inc on both sides. C = cont to knit acc to diagram 2 with tuck stitch pattern [pattern 1000, TECH 149]. D = knit in 1:1, lock rear and front N [ELECTRONIC as well], end with a few R of contrast yarn, cast off.

To make up: Block parts to size and leave to dry under a damp cloth. Sew foot seams and unravel contrast yarn. Sew front seam, section B-D with mattress stitch. Make a cord approx. 40 cm long with pink and blue wool, pull through a stitch.

Hat: cast on stocking stitch with contrast yarn with pushers [cast on 6] over 80 nds, knit a few R. With pink wool, st.s 6, knit 20 R acc to diagram 2, 2 R pink, 2 R blue [pattern 1000, TECH 169] st.s 6 1/2, knit RC 56. With blue wool, st.s 6, knit 10 R, end with a few R of contrast yarn, cast off. Unravel the contrast yarn, pull wool through the open loops and pull together. Sew seam with mattress stitch.

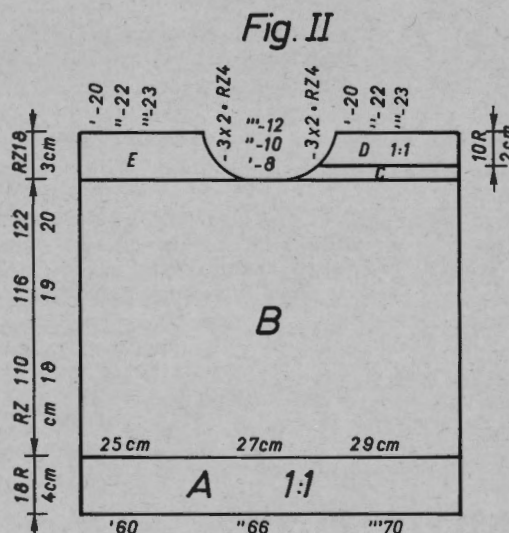
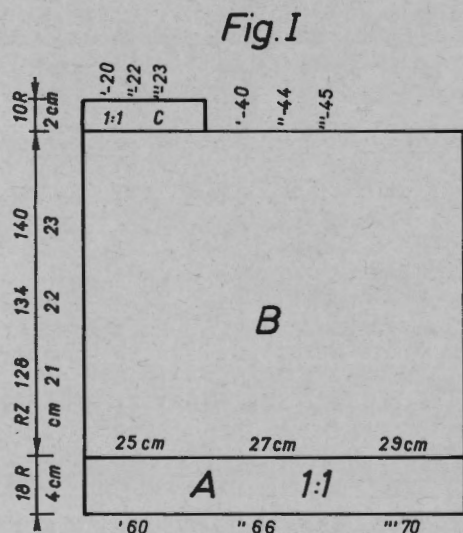

Length per 100 g =
Wool pink 380 m
Wool/rayon blur 415 m

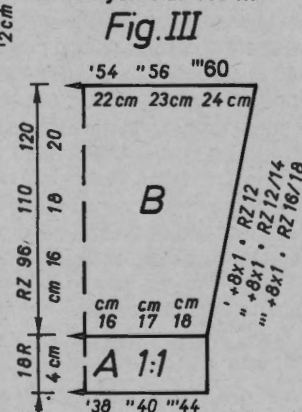
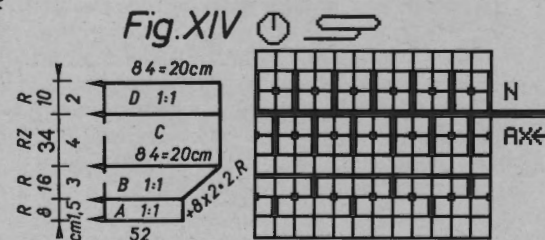

Diagram 2 for tuck stitch pattern for shoes
[pattern 1000, TECH 149]



5929 DUOMATIC 80/S ELECTRONIC 6000

Trousers

Fig.IXa: Trousers back

A = Tubular cast on for 1:1 with blue wool/rayon [cast on 1, cont to knit], cont to knit with pink wool. B = transfer all st to front bed, cont to knit acc to diagram 1 [pattern 1000, TECH 169], note position of pushers at the beginning. Transfer first leg to decker combs. Start cast on for second leg at nd 4, knit section A + B. Hang right leg alongside left leg separated by 4 nds. Cast on the empty nds and cont to knit with pattern, note pattern join. D = hang for 1:1 [TECH 101 or lock rear and front N], st.s 3 knit, knit the last 4 R with blue wool/rayon, cast off.

Fig.IXb: Trousers front

Knit A + B as Fig.IXa. C = knit as in Fig.IXa, but knit RC as in Fig.IXb. D = knit as in Fig.IXa, but work in a buttonhole 5 nds right and left of centre over 3 nds.

Braces: knit 2

Tubular cast on for 1:1 [cast on 1, cont to knit] over 13 nds, st.s 4 knit 120 R, end with a few R of contrast yarn, cast off.

To make up: Block parts to size and leave to dry under a damp cloth. Gather in the trouser back in section C and seam with mattress stitch to trouser front. Seam trouser legs with mattress stitch. Sew braces to centre back with mattress stitch and unravelling contrast yarn. Sew buttons on front.

Jacket with shawl collar

Fig.Ia: Back

A = tubular cast on for 1:1 with pink wool [cast on 1, cont to knit]. B = transfer all st to the front bed, knit acc to diagram 1, 2 R pink, 2 R blue [pattern 1000, TECH 169], cast off.

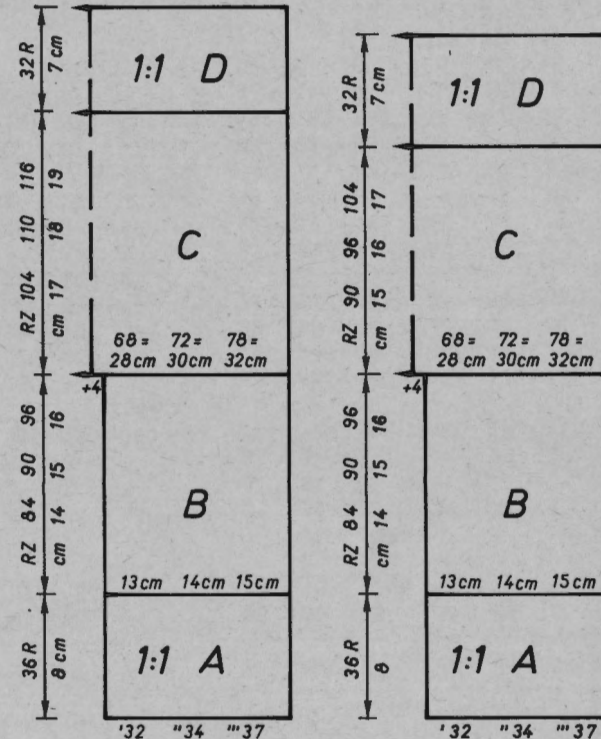
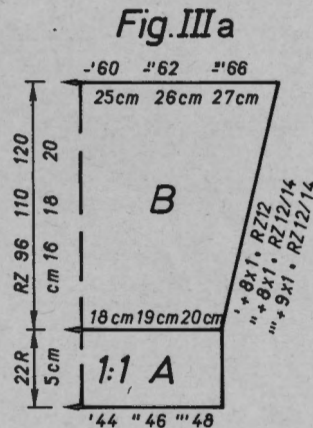
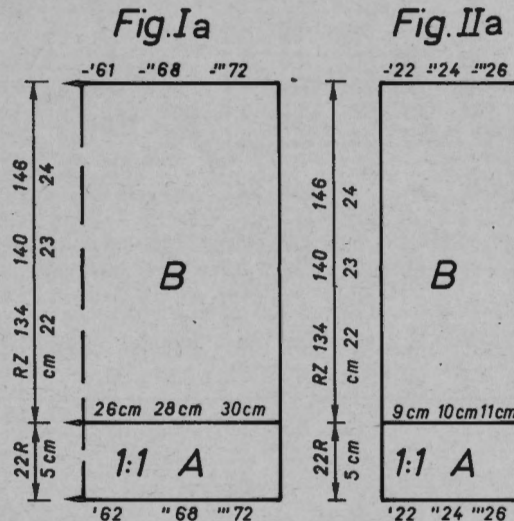

Diagram 1 for tuck stitch pattern single bed [pattern 1000, TECH 169]

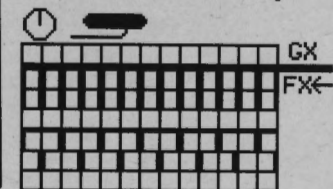

Fig.IIa: Front, knit 2

A = tubular cast on for 1:1 with pink wool [cast on 1, cont to knit]. B = transfer all st to the front bed, knit acc to diagram 1, 2 R pink, 2 R blue [pattern 1000, TECH 169], cast off.

Fig.IIIa: Sleeve, knit 2

A = tubular cast on for 1:1 with pink wool [cast on 1, cont to knit]. B = transfer all st to the front bed, knit acc to diagram 1, 2 R pink, 2 R blue [pattern 1000, TECH 169], and inc on both sides, cast off.

Shawl collar: Tubular cast on for 1:1 with pink wool [cast on 1] over 179 nds, half patent [TECH 113] knit RC 50, and work in buttonholes in RC 16 and 34 over nds 62-64, 82-84 left, cast off.

To make up: Block parts to size and leave to dry under a damp cloth. Sew shoulder seams. With right side together, sew shawl collar to front edge and neck. With right side together, sew sleeves to back and front. Sew sleeve and side seams with mattress stitch.

	Fig.I			Fig.II			Fig.III			Fig.XIV
	62	68	74	62	68	74	62	68	74	62-74
1	66	66	66	66	66	66	66	66	66	66
2	166	166	166	166	166	166	166	166	166	96
3	.	.	A	.	.	A	.	.	A	A
4	.	.	B	.	.	B	.	.	B	B
5	60	65	70	60	65	70	39	41	43	54
6	48	50	52	48	50	52	3	3	3	3
7	.	.	**	.	.	**	3	3	3	3
8	195	195	195	195	195	195	195	195	195	130
9	.	.	C	.	.	C	.	.	C	C
10	135	135	135	135	135	135	135	135	135	134
11	133	133	133	133	133	133	133	133	133	100
12	38	38	38	166	166	166	38	38	38	127
13	60	65	70	60	65	70	53	55	58	4
14	48	50	52	48	50	52	22	23	24	137
15	.	.	**	.	.	**	.	.	**	1
16	21	22	23	21	22	23	15	17	19	101
17	25	26	27	25	26	27	20	22	24	199
18	.	.	***	.	.	***	.	.	***	5
19	65	65	65	68	68	68	97	97	97	5
20	133	133	133	160	168	176	131	131	131	192
21	68	68	68	155	155	155	0	0	0	6
22	248	248	248	222	222	222	.	.	.	130
23	2	2	2	3	3	3	.	.	.	C
24	161	165	166	0	0	0	.	.	.	134
25	133	133	133	0
26	0	0	0

Flashing figures

- 8 = Fig.I knit section C
- 9 = Fig.II knit section D
- 10 = Fig.XIV cont to knit in 1:1
- 11 = Fig.XIV knit section D

Fig.Ia			Fig.IIIa		
62	68	74	62	68	74
66	66	66	66	66	66
166	166	166	166	166	166
.	.	A	.	.	A
.	.	B	.	.	B
63	67	72	43	46	48
48	50	52	3	3	3
.	.	**	3	3	3
195	195	195	195	195	195
.	.	C	.	.	C
135	135	135	135	135	135
136	136	136	136	136	136
38	38	38	38	38	38
63	67	72	60	63	65
48	50	52	25	26	27
.	.	**	.	.	**
22	23	24	15	17	19
27	28	29	21	23	25
.	.	***	.	.	***
0	0	0	97	97	97
.	.	.	131	131	131
.	.	.	0	0	0
Fig.IIa					
62	68	74			
66	66	66			
421	421	421			
.	.	A			
.	.	B			
22	24	27			
48	50	52			
.	.	**			
195	195	195			
.	.	C			
135	135	135			
136	136	136			
38	38	38			
22	24	27			
48	50	52			
.	.	**			
22	23	24			
27	28	29			
.	.	***			
0	0	0			

Fig.IX			Fig.IXa			Fig.IXb		
62	68	74	62	68	74	62	68	74
66	66	66	66	66	66	66	66	66
166	166	166	166	166	166	166	166	166
.	.	A	.	.	A	.	.	A
.	.	B	.	.	B	.	.	B
31	34	36	31	34	36	31	34	36
3	3	3	3	3	3	3	3	3
3	3	3	3	3	3	3	3	3
195	195	195	195	195	195	195	195	195
.	.	C	.	.	C	.	.	C
135	135	135	135	135	135	135	135	135
145	145	145	145	145	145	145	145	145
38	38	38	38	38	38	38	38	38
31	34	36	31	34	36	31	34	36
3	3	3	3	3	3	3	3	3
3	3	3	3	3	3	3	3	3
14	15	16	14	15	16	14	15	16
18	19	20	18	19	20	18	19	20
.	.	***	.	.	***	.	.	***
98	98	98	66	66	66	66	66	66
192	192	192	56	56	56	56	56	56
4	4	4	155	157	160	155	157	160
0	0	0	66	66	66	66	66	66
.	.	.	193	193	193	193	193	193
.	.	.	2	2	2	2	2	2
.	.	.	100	100	100	100	100	100
.	.	.	135	135	135	135	135	135
.	.	.	45	48	51	38	41	45
.	.	.	192	192	192	192	192	192
.	.	.	3	3	3	3	3	3
.	.	.	131	131	131	131	131	131
.	C	.	.	C
.	.	.	135	135	135	135	135	135
.	.	.	142	142	142	142	142	142
.	.	.	0	0	0	0	0	0

Note: FORM program for trousers
 Fig.IX = 1st leg, knit two
 Fig.IXa = 2nd back leg and sections C + D
 Fig.IXb = 2nd front leg and sections C + D
 *** = leg length

Flashing fig 8 = hang 1st leg on nds
 Flashing fig 9 = knit section D

5906 DUOMATIC 80/S ELECTRONIC 6000

Length per 100 g = 480 m

Lady's waistcoat for 5905

[Instructions for ELECTRONIC 6000 in square brackets]

Size: To fit 88 - 92 cm bust
Material: 140 g linen beige (Figaro from Conofil), 5 buttons
Stitch size: Pattern = back 5, front 4. Bindings = 4 1/2
Test square: 100 st (counted on front bed) = 36 cm. RC 100 = 21 cm
Pattern: Long stitches according to diagram [TECH 117]. Hem, bindings for sleeve hole = tubular [cast on 8, cont to knit]. Bindings for front edge and neck = half tubular, right open [TECH 108] and half tubular left open [TECH 109]

Fig.I: Back

A = closed cast on for tubular [cast on 8, cont to knit]. B = knit long st acc to diagram [TECH 117] and inc on both sides. C = shape both sides for sleeve hole, knit straight long st. D = divide work, cast off centre st, place left half onto decker combs. Cont to knit right half, and shape left for neck, cast off. Put left part back onto the same nds as before and finish knitting with reversed shape.

Fig.II: Front, knit two reversed parts, left without buttonholes

A = closed cast on for tubular [cast on 8, cont to knit]. B = knit long st acc to diagram [TECH 117], outside right work in buttonholes by RC 6, 32, 58, 84 and 100 over the 4th and 5th nds, inc left. C = shape left for sleeve hole, right knit straight, work in further buttonholes. D = shape right for neck, cast off.

Neck binding: knit two reversed parts.

Closed cast on for tubular [cast on 8] with contrast yarn over nds 58 on both beds. Half tubular right open [TECH 108] st.s 4 1/2, inc 1 st left with double-decker nds 3 times every RC 4, and hang the left piece on empty nds, knit RC 4, 3 times shape every RC 4, knit RC 4, end with a few R of contrast yarn, release.

Part 2: Knit half tubular left open [TECH 109].

Sleeve hole bindings: knit two.

Closed cast on for tubular [cast on 8, cont to knit] over 128 nds, st.s 4 1/2, RC 16 knit tubular, end with a few R of contrast yarn, release.

To make up: Block parts to size and leave to dry under a damp cloth.

Sew shoulder seams. Sew neckbinding together at the back, and to front edge and neck st by st with backstitches through open loops and unravelling contrast yarn, hem down on inside. Sew bindings for sleeve hole st by st with backstitches to sleeve hole through open loops and unravelling contrast yarn, hem down on inside. Sew sleeve and sleeve seams with mattress stitch. Sew on buttons.

	Fig.I			Fig.II		
	34/3638/4042/44			34/3638/4042/44		
1	84	84	84	84	84	84
2	144	144	144	399	399	399
3	.	.	A	.	.	A
4	.	.	B	.	.	B
5	119	131	142	64	69	75
6	82	90	98	82	90	98
7	.	.	**	.	.	**
8	194	194	194	194	194	194
9	.	.	C	.	.	C
10	133	133	133	133	133	133
11	38	38	38	38	38	38
12	128	136	147	72	78	83
13	82	90	98	82	90	98
14	.	.	**	.	.	**
15	8	8	8	8	8	8
16	37	37	37	37	37	37
17	.	.	***	.	.	***
18	233	233	233	233	233	233
19	130	130	130	130	130	130
20	170	170	170	170	170	170
21	162	162	162	162	162	162
22	154	154	154	154	154	154
23	164	164	164	164	164	164
24	175	175	175	175	175	175
25	3	3	3	3	3	3
26	135	135	135	135	135	135
27	35	35	35	35	35	35
28	72	72	72	72	72	72
29	184	184	184	160	168	176
30	130	131	132	161	161	161
31	185	185	185	153	153	153
32	129	129	129	179	179	179
33	161	161	161	182	182	182
34	145	145	145	183	183	183
35	137	137	137	5	5	5
36	129	129	129	129	129	129
37	0	0	0	0	0	0

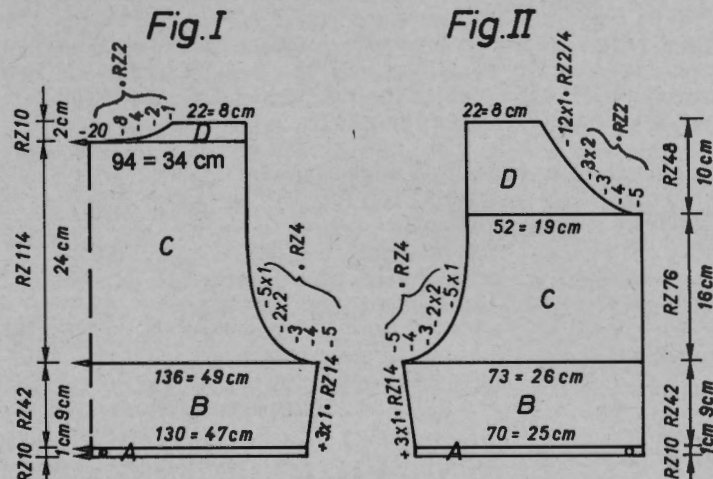
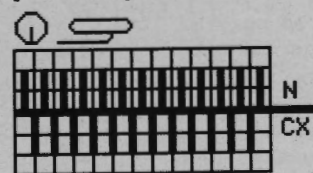

Diagram for pattern [TECH 117]



5932 DUOMATIC 80/S ELECTRONIC 6000

Men's pullover with scarf

Model Y. Wassmer, Arboldswil

[Instructions for ELECTRONIC 6000 in square brackets]

Size: To fit 92 - 98 cm chest

Material: 420 g wool grey (i.d.e.e. from Lang) 90 g wool emerald, 70 g wool bordeaux (Camel from Fröhlich)

Stitch size: Tuck stitch pattern = 6 1/4, band = 4 1/2, neckband and cuff = 4

Test square: 100 st = 37 cm, 100 R = 19 cm

Pattern: Tuck stitch pattern according to diagram and colour sequence with self-punched DECO cards [with self-drawn pattern sheets, TECH 130] band and neckband = 1:1 [cast on 1, cont to knit]

Fig. I: Back

A = tubular cast on for 1:1 with grey wool [cast on 1, cont to knit], knit with col seq 2 R grey, 2 R emerald. B = transfer all st to front bed, end with a few R of contrast yarn, cast off. Hang band on 125 nds of the knitting machine, on every 18th nd hang 2 st. Knit straight in tuck stitch acc to diagram and col seq with DECO punchcard [with

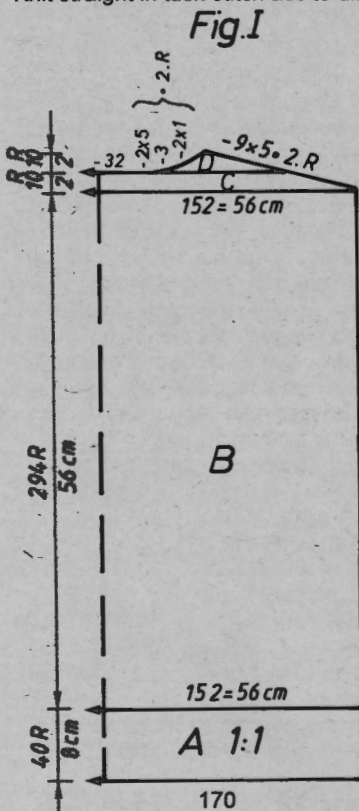

Fig. I

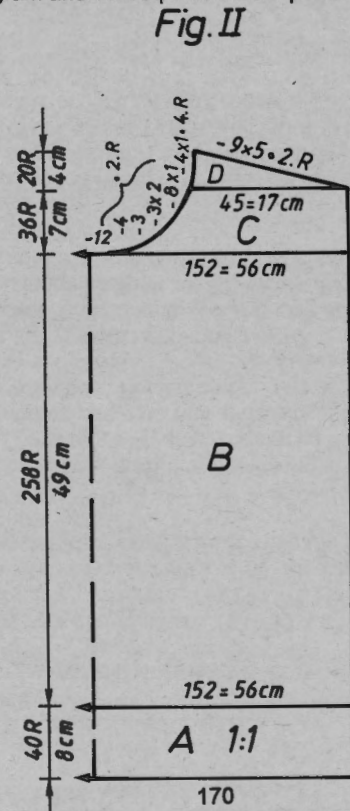

Fig. II

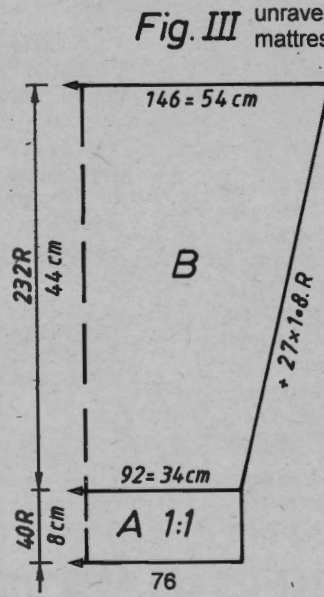
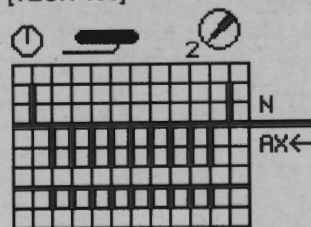

Fig. III

Diagram for tuck stitch pattern

[TECH 130]



Length per 100 g =
Wool grey = 320 m
Wool emerald, bordeaux = 400 m

Colour sequence for tuck stitch pattern:

- RC 0-38 grey
- RC 39-76 2 R bordeaux
- 2 R grey
- RC 77-114 grey
- RC 115-152 2 R emerald
- 2 R grey

pattern sheet, TECH 130]. C = shape both sides for shoulder, cont to knit with pattern. D = divide work, cast off centre st (if you knit without FORM program, make a note of the electronic row counter), place left half onto decker combs. Cont to knit right half with pattern and col seq, and shape right for shoulder, left for neck, cast off. Put left part back onto the same nds as before and finish knitting with reversed shape.

Fig. II: Front

Knit A + B as in Fig. I. Note, RC in B from Fig. II. C = divide work, cast off centre st (if you knit without FORM program, make a note of the electronic row counter), place left half onto decker combs. Cont to knit right half with pattern and col seq, and shape left for neck, cast off. Put left part back onto the same nds as before and finish knitting with reversed shape.

Fig. III: Sleeves, knit 2

A = tubular cast on for 1:1 with grey wool [cast on 1, cont to knit], knit with col seq 2 R grey, 2 R emerald. B = transfer all st to front bed, end with a few R of contrast yarn, cast off. Hang cuff on 92 nds, leave every 5th nd empty, on completing the left stitch loop, hang the neighbouring st on it. Knit tuck stitch acc to diagram and col seq with DECO punchcard [with pattern sheet, TECH 130], and inc on both sides, cast off.

Neckband: Tubular cast on for 1:1 with grey wool [cast on 1, cont to knit] over 168 nds, st.s 4 knit 6 R, st.s 4 1/4, knit 6 R, st.s 4 1/5, knit 6 R. Bring all nds into the working position, st.s 6, lock rear and front CX [ELECTRONIC as well] knit RC 8, end with a few R of contrast yarn, cast off.

To make up: Block parts to size and leave to dry under a damp cloth. Sew shoulder seams. Sew neckband st by st with backstitch through open loops to neck, unravelling the contrast yarn, hem down on inside. Sew sleeve and side seams with mattress stitch.

Fig.I	46/4850/5254/56			Fig.II	46/4850/5254/56			Fig.III	46/4850/5254/56		
1	76	76	76	76	76	76	76	76	76	76	
2	148	148	148	148	148	148	148	148	148	148	
3	.	.	A	.	.	A	.	.	A	.	
4	.	.	B	.	.	B	.	.	B	.	
5	151	162	173	151	162	173	92	95	97		
6	94	102	110	94	102	110	3	3	3		
7	.	.	**	.	.	**	3	3	3		
8	195	195	195	195	195	195	195	195	195		
9	.	.	C	.	.	C	.	.	C		
10	135	135	135	135	135	135	135	135	135		
11	142	142	142	142	142	142	142	142	142		
12	38	38	38	166	166	166	38	38	38		
13	151	162	173	151	162	173	146	149	151		
14	94	102	110	94	102	110	54	55	56		
15	.	.	**	.	.	**	.	.	**		
16	58	58	58	58	58	58	44	44	44		
17	68	68	68	68	68	68	63	65	67		
18	.	.	***	.	.	***	.	.	***		
19	227	227	227	75	76	76	97	97	97		
20	191	191	191	176	184	184	131	131	131		
21	166	170	174	161	128	129	0	0	0		
22	3	3	3	153	161	161					
23	70	70	70	179	153	153					
24	184	184	184	191	179	179					
25	137	138	139	129	191	191					
26	186	186	186	1	129	129					
27	131	131	131	167	1	1					
28	153	153	153	1	167	167					
29	146	146	146	135	1	1					
30	0	0	0	128	135	135					
				99	128	128					
				191	99	99					
				166	191	191					
				3	170	174					
				0	3	3					
				0	0						

Colour sequence for scarf

RC 0-32	2 R bordeaux
	2 R emerald
RC 33-64	2 R grey
	2 R emerald
RC 65-96	2 R bordeaux
	2 R grey
RC 97-1088	2 R bordeaux
	2 R emerald
RC 1089-1120	2 R bordeaux
	2 R grey
RC 1121-1152	2 R grey
	2 R emerald
RC 1153-1184	2 R bordeaux
	2 R emerald

Diagram for reversible pattern for scarf
[TECH 182 arrange pushers according to description]

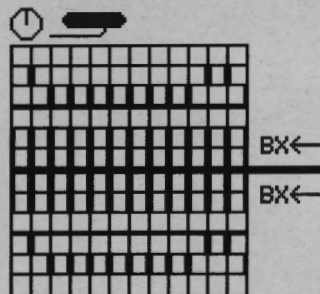

Scarf:

Thread the feeding eyelet as follows: 1st eyelet from left emerald, 2nd grey, 3rd bordeaux

Closed tubular cast on over 72 nds front and rear with grey wool [cast on 8] knit 4 RC tubular. Position the pushers as follows: from left, 1 pusher up, 8 down, 2 up, 1 down, 1 up, 18 down, 2 up, 2 down, 4 up, 2 down, 4 up, 4 down, 1 up, 1 down, 2 up, 8 down, 2 up, 1 down, 1 up, 5 down, 2 up, 3 down. Read in pattern sheet 2, ADD pattern sheet 2, ALTER = ENT, DIST.R = NO, DIST. STS = NO]. The pushers on the rear bed are in the reversed positions to those on the front bed, e.g. those on the front bed that are in the working position, are not in the working position on the rear bed [ELECTRONIC as well. Knit acc to diagram and col seq with st.s 6 1/4, RC 1184. Then knit with grey wool, st.s 4, RC 6, lock rear and front CX, cast off.

DECO card / pattern sheet

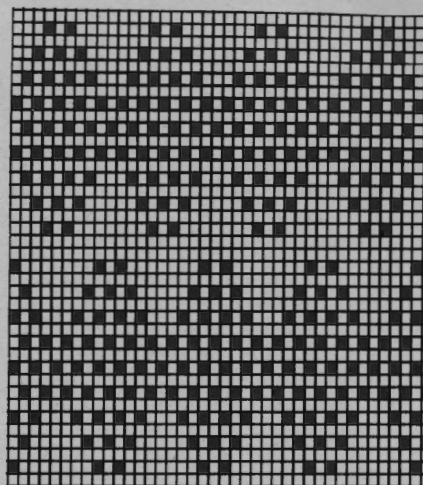

Pattern sheet 2

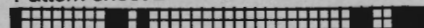

Pattern sheet 3

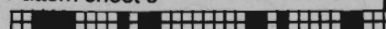

5933 DUOMATIC 80 ELECTRONIC 6000

Length per 100 g = 350 m

Lady's pullover linen

[Instructions for ELECTRONIC 6000 in square brackets]

Size: To fit 88 - 92 cm bust

Material: 260 g cotton/linen beige, 90 g cotton/linen rust, 40 g cotton/linen olive (Omega from Conofil)

Stitch size: Stocking stitch and single bed Fairisle = 6 3/4, lacy pattern = rear 6 3/4, front 4

Test square: Single bed Fairisle : 100 st = 36 cm, RC 100 = 14 cm, stocking stitch : 100 st = 36 cm, 100 R = 30 cm, lacy pattern = 100 st (counted on rear bed) = 40 cm, RC 100 = 15 cm.

Pattern: Single bed 2 colour Fairisle according to diagram and colour sequence with self-punched DECO card 1 [with self-drawn pattern sheet 1, TECH 176], stocking stitch [TECH 100], lacy pattern without transfer according to diagram with self-punched DECO card 2 [with self-drawn pattern sheet 2, TECH 256], neckband tubular [cast on 8, cont to knit]

Fig.I: Back

A = tubular cast on for 1:1 with beige cotton/linen [cast on 1]. Transfer all st to the front bed, knit single bed Fairisle acc to diagram and col seq with DECO punchcard 1

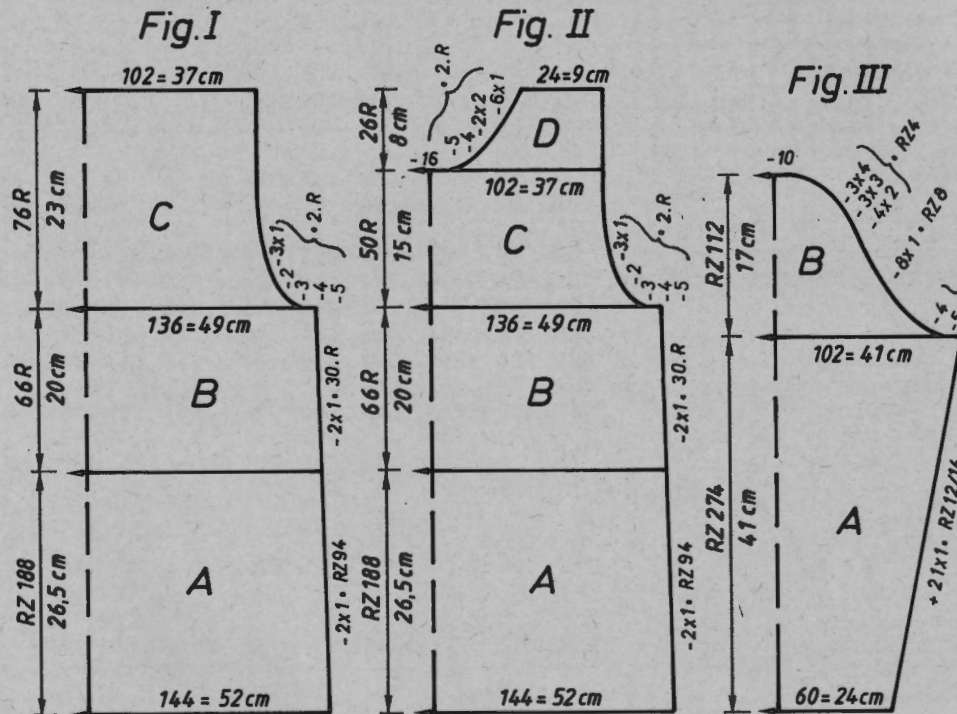

[with pattern sheet 1, TECH 176]. B = knit straight stocking stitch beige [TECH 100]. C = stocking stitch, shape both sides for sleeve, cast off.

Fig.II: Front

Knit A + B as in Fig. I. C = stocking stitch, shape both sides for sleeve. D = divide work, cast off centre st, place left half onto decker combs. Cont to knit right half, and shape left for neck, cast off. Put left part back onto the same nds as before and finish knitting with reversed shape.

Fig.III: Sleeve, knit 2

A = tubular cast on for 1:1 with beige cotton/linen [cast on 1]. Transfer all st to the rear bed, knit lacy pattern without transfer acc to diagram with DECO punchcard 2 [with pattern sheet 2, TECH 256], and inc on both sides. B = shape both sides for sleeve head, cast off.

Neckband: closed tubular cast on with beige cotton/linen [cast on 8, cont to knit] over 180 nds, st.s 6 knit RC 20, end with a few R of contrast yarn, lock N/N, cast off.

To make up: Block parts to size and leave to dry under a damp cloth. Sew shoulder seams. Sew neckband st by st with backstitch through open loops to neck, unravelling the contrast yarn, hem down on inside. With right sides facing, sew sleeves to back and front. Sew sleeve and side seams with mattress stitch.

Colour sequence for single bed Fairisle:

- RC 0-40 2 R beige
2 R rust
- RC 41-56 2 R beige
2 R olive
- RC 57-64 2 R rust
2 R olive
- RC 65-80 2 R beige
2 R olive
- RC 81-188 2 R beige
2 R rust

Diagram for single bed Fairisle [TECH 176]

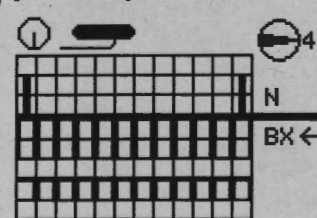
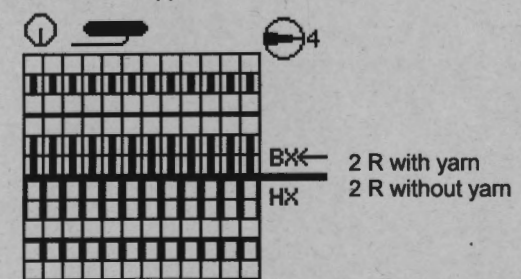

Diagram for lacy pattern without transfer [TECH 256] use black stripper



5933

	Fig.I			Fig.II			Fig.III		
	34/3638/4042/44			34/3638/4042/44			34/3638/4042/44		
1	120	120	120	120	120	120	60	60	60
2	144	144	144	144	144	144	160	160	160
3	.	.	A	.	.	A	.	.	A
4	.	.	B	.	.	B	.	.	B
5	133	144	156	133	144	156	58	60	63
6	82	90	98	82	90	98	3	3	3
7	.	.	**	.	.	**	3	3	3
8	195	195	195	195	195	195	38	38	38
9	.	.	C	.	.	C	100	103	105
10	135	135	135	135	135	135	40	41	42
11	166	166	166	166	166	166	.	.	**
12	38	38	38	38	38	38	40	40	40
13	125	136	147	125	136	147	58	59	60
14	82	90	98	82	90	98	.	.	***
15	.	.	**	.	.	**	109	109	109
16	20	20	20	20	20	20	131	131	131
17	70	70	70	70	70	70	170	170	170
18	.	.	***	.	.	***	162	162	162
19	103	103	103	231	231	231	191	191	191
20	169	169	169	169	169	169	129	129	129
21	161	161	161	161	161	161	25	25	25
22	153	153	153	153	153	153	191	191	191
23	145	145	145	145	145	145	129	129	129
24	155	155	155	155	155	155	1	1	1
25	135	135	135	135	135	135	190	190	190
26	24	24	24	24	24	24	130	130	130
27	0	0	0	71	71	71	190	190	190
				184	184	184	133	133	133
				128	129	130	0	0	0
				169	169	169			
				161	161	161			
				162	162	162			
				182	182	182			
				131	131	131			
				0	0	0			

DECO 1 Pattern sheet 1

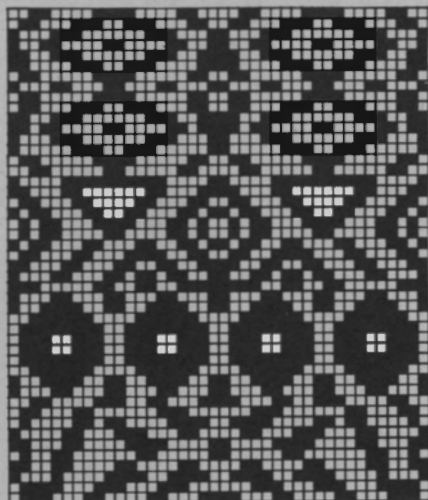

DECO 2 Pattern sheet 2

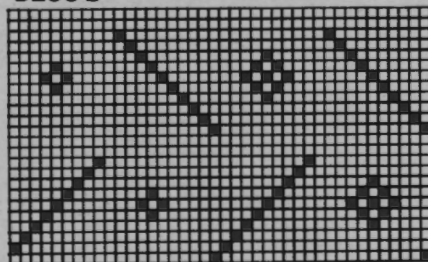

5942

Shawl in summer Fairisle

[Instructions for ELECTRONIC 6000 in square brackets]

Size: 190 x 65 cm

Material: 200 g linen ochre or rust (Figaro from Conofil)

Stitch size: 4

Test square: 100 st (counted on rear bed) = 50 cm, RC 100
(measured after releasing the stitches) = 50.5 cm

Pattern: Summer Fairisle according to diagram with self-punched DECO cards [with self-drawn pattern sheets, TECH 251]

Tubular cast on for 1:1 [cast on 1] over 130 nds. Transfer all st to the rear bed, knit RC 378 acc to diagram with DECO punchcard [with pattern sheet, TECH 251], cast off all st knitted on front bed. End with a few R of contrast yarn, lock rear N, front GX, knit, cast off. Release st. Unravel contrast yarn and crochet loose st.

Diagram for summer Fairisle

[TECH 251]

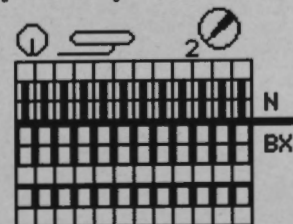

DECO card / pattern sheet



Pattern sheet 10

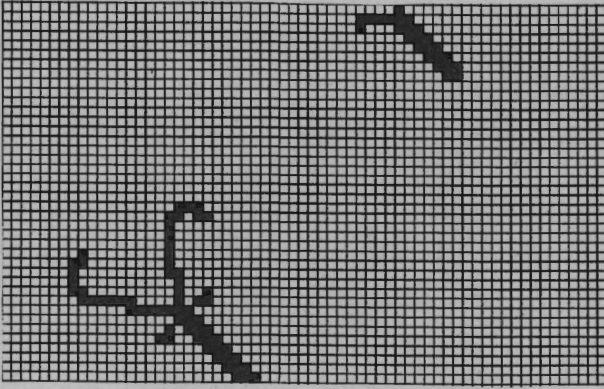

Pattern sheet 9

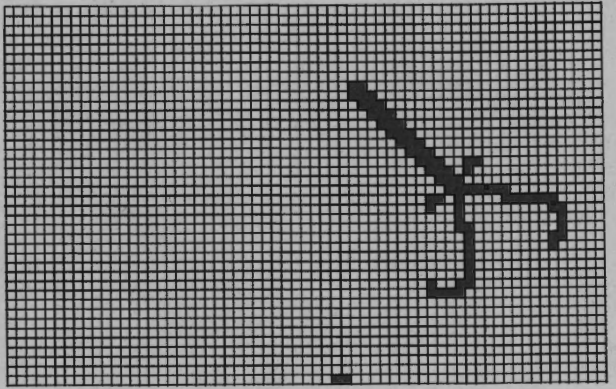

Pattern sheet 8

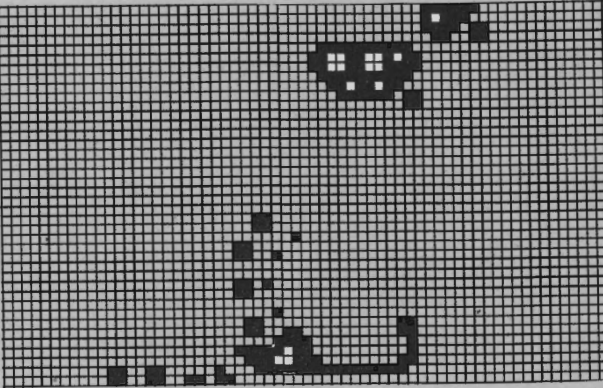

Pattern sheet 7

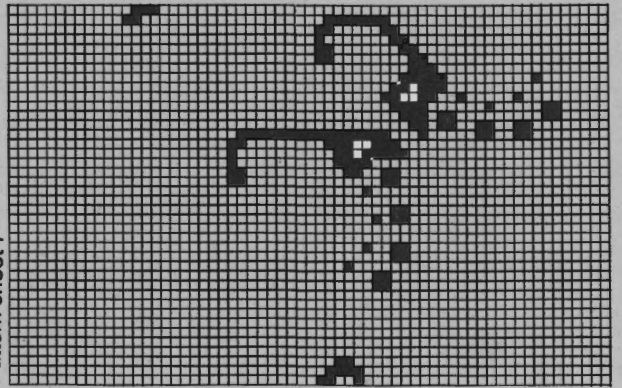

Pattern sheet 6

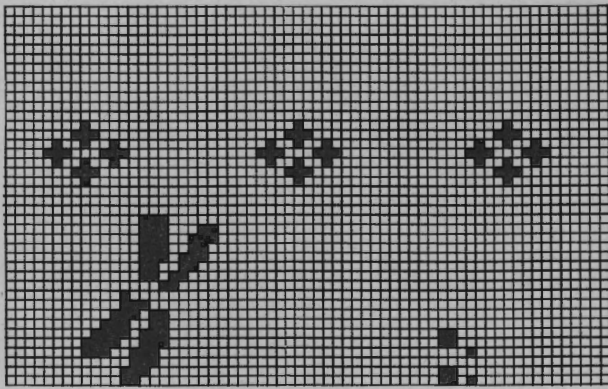

Pattern sheet 5

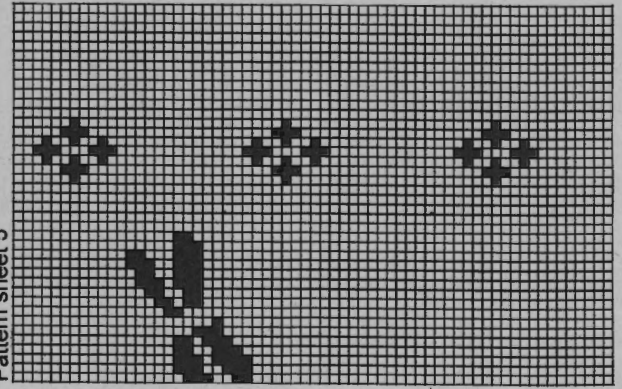

Pattern sheet 4

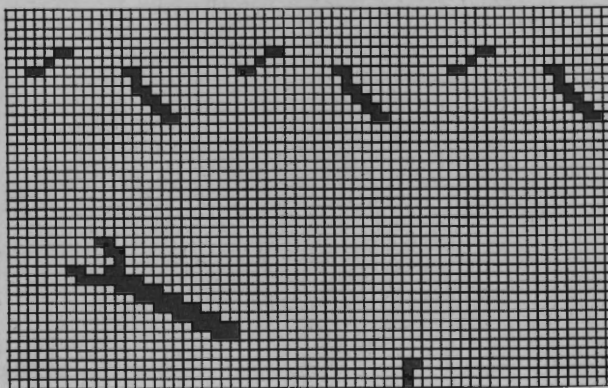

Pattern sheet 3

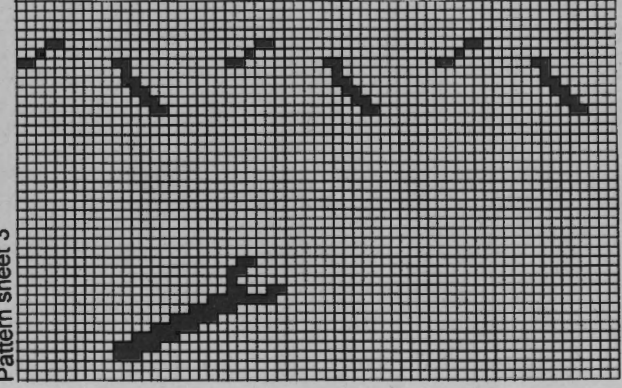

Pattern sheet 12

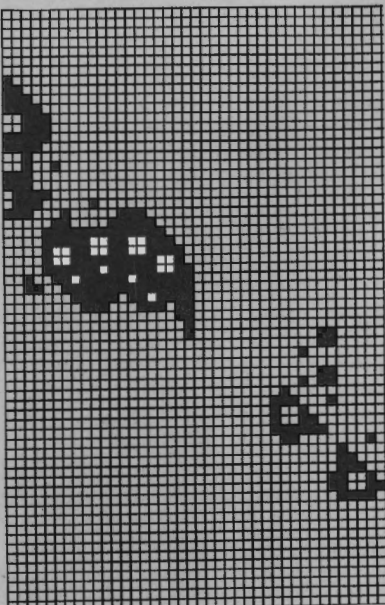

Pattern sheet 11

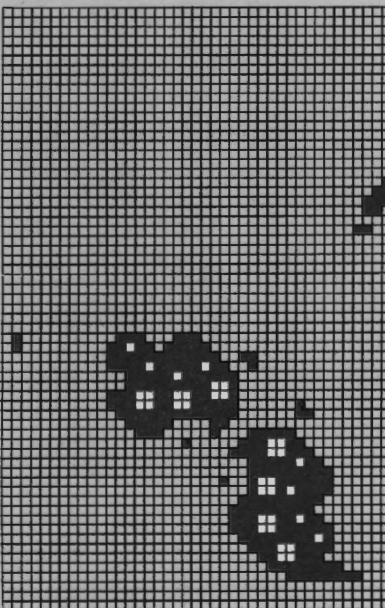

Pattern sheet 14

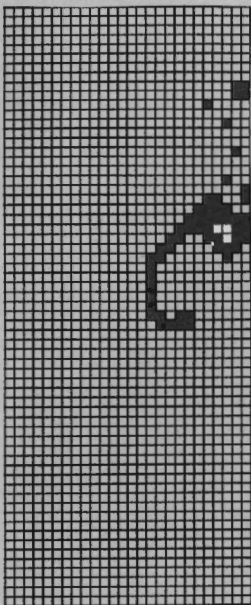

Pattern sheet 13

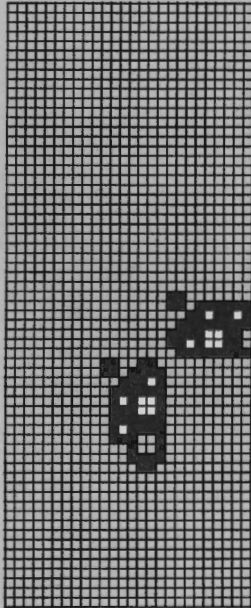

Pattern sheet 16

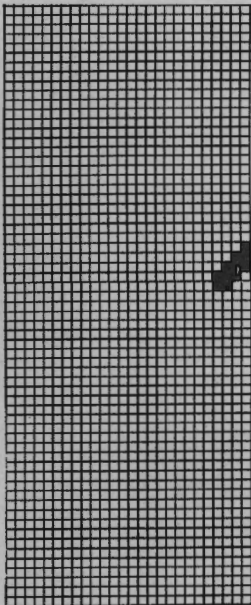

Pattern sheet 15

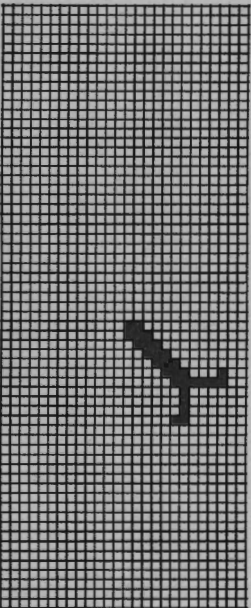

Pattern sheet 18

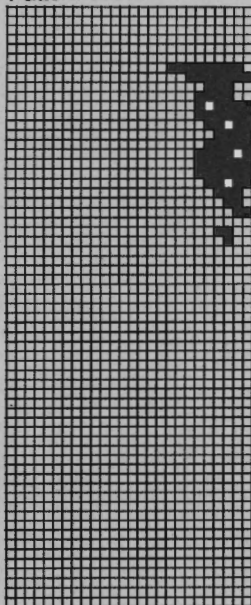

Pattern sheet 17

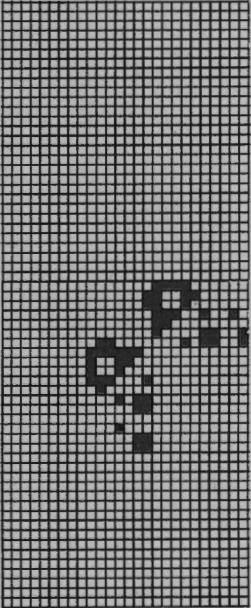

Pattern sheet 22

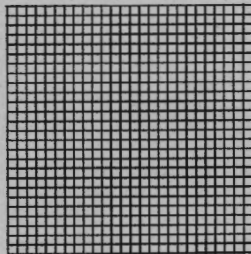

Pattern sheet 23

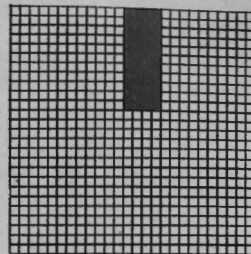

Pattern sheet 21

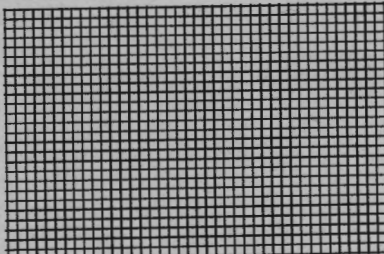

Pattern sheet 20

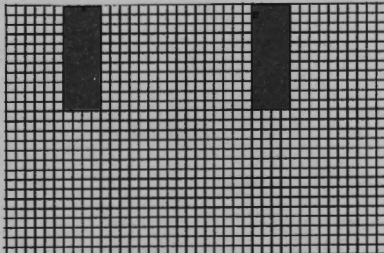

Pattern sheet 19

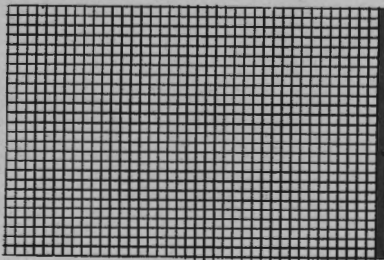

5930

To make up: Block parts to size and leave to dry under a damp cloth. Unravel contrast yarn from top and bottom and pull wool through the open loops. Sew seam with mattress stitch. Pull hat at top together in a knot.

Headband:

Closed tubular cast on [cast on 8] with contrast yarn over 45 nds on front and rear bed. RC 8 turquoise, RC 12 set colour (grey/white flecked), RC 24 turquoise, RC 12 set colour, RC 8 turquoise. End with a few R of contrast yarn, cast off. Unravel contrast yarn and pull wool the open loops. Sew set if required.

	Fig.I			Fig.II			Fig.III		
	62	68	74	62	68	74	62	68	74
1	94	94	94	94	94	94	94	94	94
2	124	124	124	124	124	124	124	124	124
3	.	.	A	.	.	A	.	.	A
4	.	.	B	.	.	B	.	.	B
5	81	87	94	81	87	94	58	61	65
6	48	50	52	48	50	52	3	3	3
7	.	.	**	.	.	**	3	3	3
8	194	194	194	194	194	194	195	195	195
9	.	.	C	.	.	C	.	.	C
10	132	132	132	132	132	132	135	135	135
11	38	38	38	166	166	166	129	129	129
12	81	87	94	81	87	94	38	38	38
13	48	50	52	48	50	52	71	74	77
14	.	.	**	.	.	**	22	23	24
15	24	25	26	24	25	26	.	.	**
16	26	27	28	26	27	28	15	17	19
17	.	.	***	.	.	***	20	22	24
18	65	65	65	70	70	71	.	.	**
19	133	133	133	160	176	184	97	97	97
20	68	68	68	153	153	128	130	130	130
21	248	248	248	217	217	153	0	0	0
22	2	2	2	3	3	217			
23	175	181	185	162	162	3			
24	133	133	133	130	130	162			
25	0	0	0	0	0	130			

Diagram for transfer by hand

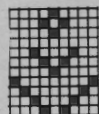

DECO punchcard, pattern sheet

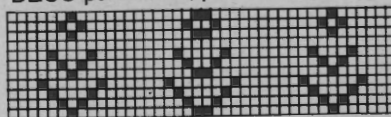

DECO punchcard, pattern sheet for hat

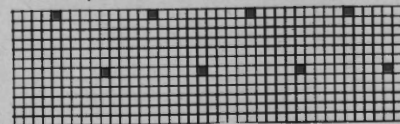

5935

Pattern sheet 27

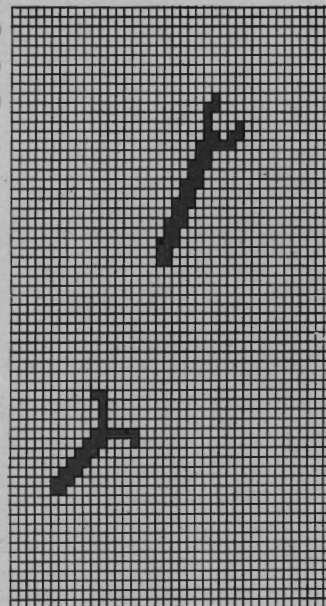

Pattern sheet 26

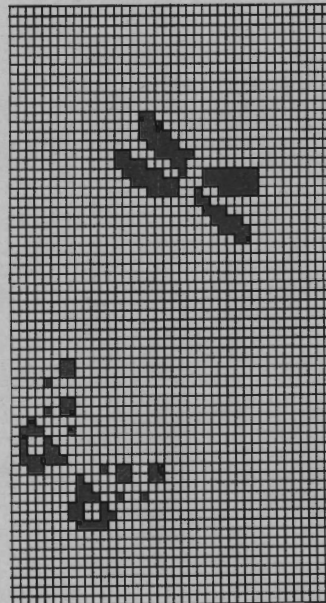

Pattern sheet 25

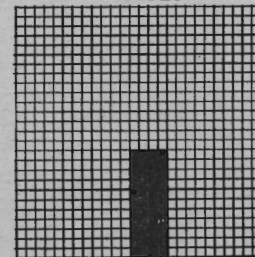

Pattern sheet 24

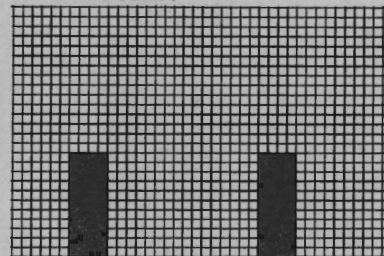

Pattern sheet 28

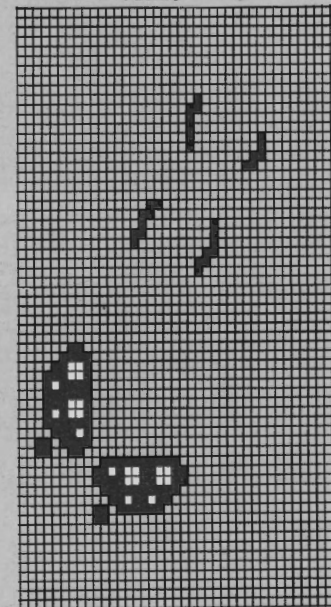

5930 DUOMATIC 80/S ELECTRONIC 6000

Length per 100 g = 385 m

Baby's pullover with lacy pattern

Model L. Poletti, Schattdorf

[Instructions for ELECTRONIC 6000 in square brackets]

Size: To fit 62/68/74 cm height

Material: 140 g turquoise wool (Brillanta from Conofil). 3 buttons

Stitch size: Stocking stitch pattern = 6. Hem = 5. Cuffs and neckband = 3 1/4.

Test square: 100 st = 31 cm, 100 R = 23.5 cm

Pattern: Fig.I + II stocking stitch [TECH 100]. Fig. II acc to diagram with self-punched DECO card. Looks a bit different in the picture [with self-drawn pattern. Pattern A: POSITION = ENT, PATT. AFT R 18, ↑ REP.R = NO, ↔ REP.ST = ENT, TECH 280. Pattern B: POSITION = ENT, PATT. AFT R 18, ↑ REP.R = NO, ↔ REP.ST = NO, TECH 280]. The pullover shown was knitted according to diagram with 6 st stocking stitch in between, st hung with double-deckneedle on neighbouring nd. HEM = closed tubular cast on [cast on 8, cont to knit]. Cuff and neckband = 1:1 [cast on 1, cont to knit].

Fig.I: Back

A = closed tubular cast on [cast on 8, cont to knit]. B = transfer all st to front bed, cont to knit with stocking stitch [TECH 100], cast off right. C = hang for 1:1 [TECH 101 or lock rear and front N], st.s 3 1/4, knit, cast off.

Fig.II: Front

A = closed tubular cast on [cast on 8, cont to knit]. B = if you knit with DECO punchcards or ELECTRONIC 6000, transfer all st to rear bed. Set row counter to 0, knit 18R stocking stitch, then acc to diagram and DECO punchcard knit to R 40 [with

pattern sheet, TECH 280, knit pattern A]. In the first 18 R, no st are transferred, then transfer with transfer lock. Cont to knit to RC 58 with stocking stitch, then acc to diagram and DECO punchcard. Put 1st positioning pin to the right of the knitting, 2nd positioning pin under nd 20 left, knit with pattern to R 80 [with pattern sheet, TECH 280, knit pattern B. In the 1st 18 R, no st are transferred, then to R 40 transfer with transfer lock, then cont to knit without transfer]. C = divide work, cast off centre st, place left half onto decker combs. Cont to knit right half, and shape left for neck. D = hang for 1:1 [TECH 101 or lock rear and front N] knit, cont to shape for neck. Work in a buttonhole on the 97th R over nds '33/34, 25/26, "34/35, 26/27, "'35/36, 27/28, cast off E = put left part back onto the same nds as before, knit stocking stitch [lock rear N, front GX], shape right for neck, cast off.

Fig.III: Sleeve, knit 2

A = tubular cast on for 1:1, cont to knit [cast on 1, cont to knit]. B = transfer all st to front bed, knit stocking stitch [TECH 100] and inc on both sides, cast off.

Neckband:

Tubular cast on for 1:1 [cast on 1, cont to knit], over '86, "90, "'90 nds, st.s 3 1/4, knit 8 R, hang the 4th st from the left on the neighbouring nd for the buttonhole. Bring all nds into the working position, lock rear and front CX [ELECTRONIC as well], st.s 4 3/4, knit RC 8, end with a few R of contrast yarn, cast off.

To make up: Block parts to size and leave to dry under a damp cloth. Sew right shoulder seam, lay left shoulder over and with right sides together sew sleeve to back and front. Sew neckband st by st with backstitch through open loops to neck, unravelling the contrast yarn, hem down on inside. Sew sleeve and side seams with mattress stitch.

Hat:

Cast on stocking stitch [cast on 6] with contrast yarn over 86 nds. Knit 56 R with turquoise wool acc to diagram and DECO self-punched cards [with pattern sheet, TECH 280]. End with a few R of contrast yarn, cast off.

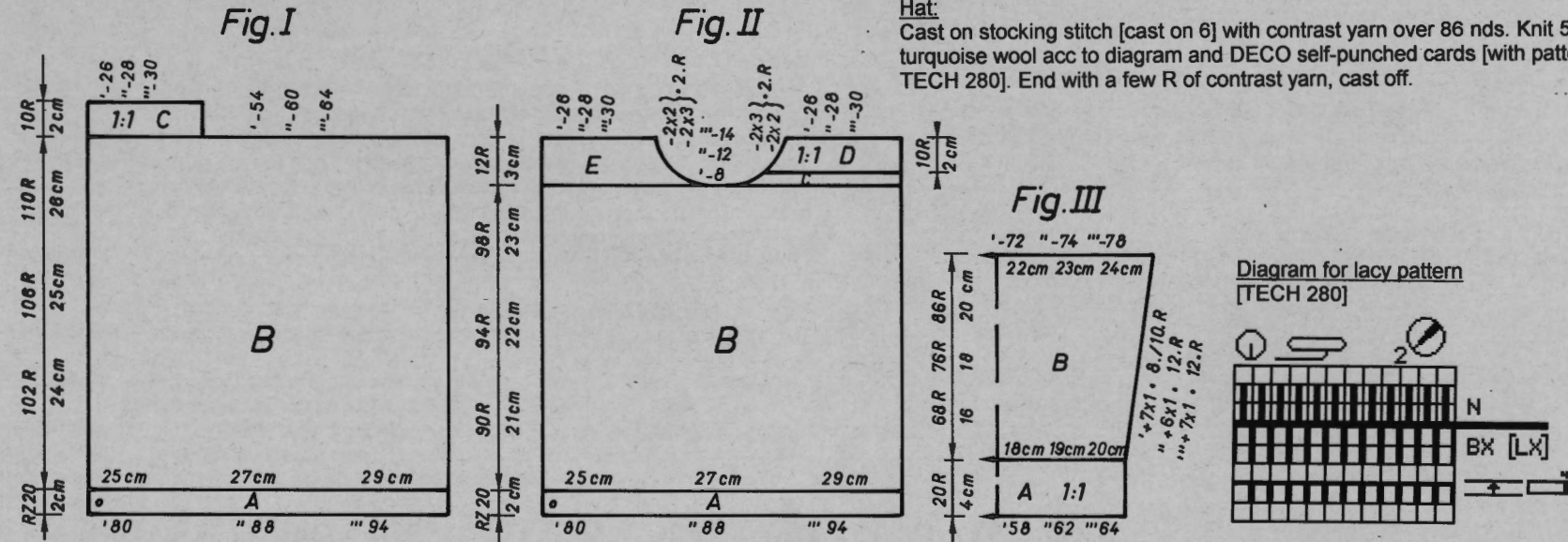

5931 DUOMATIC 80/S ELECTRONIC 6000

Length per 100 g = 900 m

Lady's pullover

[Instructions for ELECTRONIC 6000 in square brackets]

Size: To fit 88 - 92 cm bust

Material: 110 g wool blue, 70 g wool brown and yellow, 50 g wool green and rust (Moragarn from Conofil)

Stitch size: 3 + 4 colour Fairisle = back 4, front 4 1/2, cuff = 3 1/2, neckband = 5.

Test square: 4 colour Fairisle : 100 st (counted on front bed) = 34 cm, RC 100 = 10 cm. 3 colour Fairisle : 100 st (counted on front bed) = 36 cm, RC 100 = 11.5 cm.

Pattern: 4 colour Fairisle according to diagram and colour sequence with self-punched DECO cards 1 - 8 [with self-drawn pattern sheet, pattern sheet 1 with cont 2, ADD pattern sheet 3 with continuation 4, 3.COL = ENT, ADD pattern sheet 5 with continuation 6, 4.COL = ENT, TECH 208 but needle and lock position according to diagram] 3 colour Fairisle according to diagram and colour sequence self-punched DECO card 9 + 10 [with self-drawn pattern sheets, pattern sheet 7 ADD pattern sheet 8, 3.COL = ENT, TECH 196 but needle

and lock position according to diagram]

Neckband = tubular [cast on 8, cont to knit]

Fig.I: Back

A = closed tubular cast on [cast on 8] with blue wool. Knit 4 colour Fairisle acc to diagram and col seq with DECO punchcards [with pattern sheet, TECH 208 but acc to diagram]. B = shape both sides for sleeve, cast off.

Fig.II: Front

A = knit as for Fig.I. B = shape both sides for sleeve, knit straight. C = divide work, cast off centre st (if you knit without FORM program, make a note of the electronic row counter), place left half onto decker combs. Cont to knit right half, and shape left for neck, cast off. Put left part back onto the same nds as before and finish knitting with reversed shape.

Fig.III: Sleeves, knit 2

A = tubular cast on for 1:1 with double stranded blue wool [cast on 1, cont to knit]. B = bring all nds into the working position. Knit Fairisle acc to diagram and col seq with DECO punchcards [with pattern sheets TECH 196 knit acc diagram], and inc on both sides. C = shape both sides for sleeve head. Cast off.

Neckband: closed tubular cast on with double stranded blue wool [cast on 8, cont to knit] over 114 nds, st.s 5, knit 20 R, end with a few R of contrast yarn, cast off.

To make up: Block parts to size and leave to dry under a damp cloth. Sew shoulder seams. Sew neckband st by st with backstitch through open loops to neck, unravelling the contrast yarn, hem down on inside. Sew sleeve and side seams with mattress stitch.

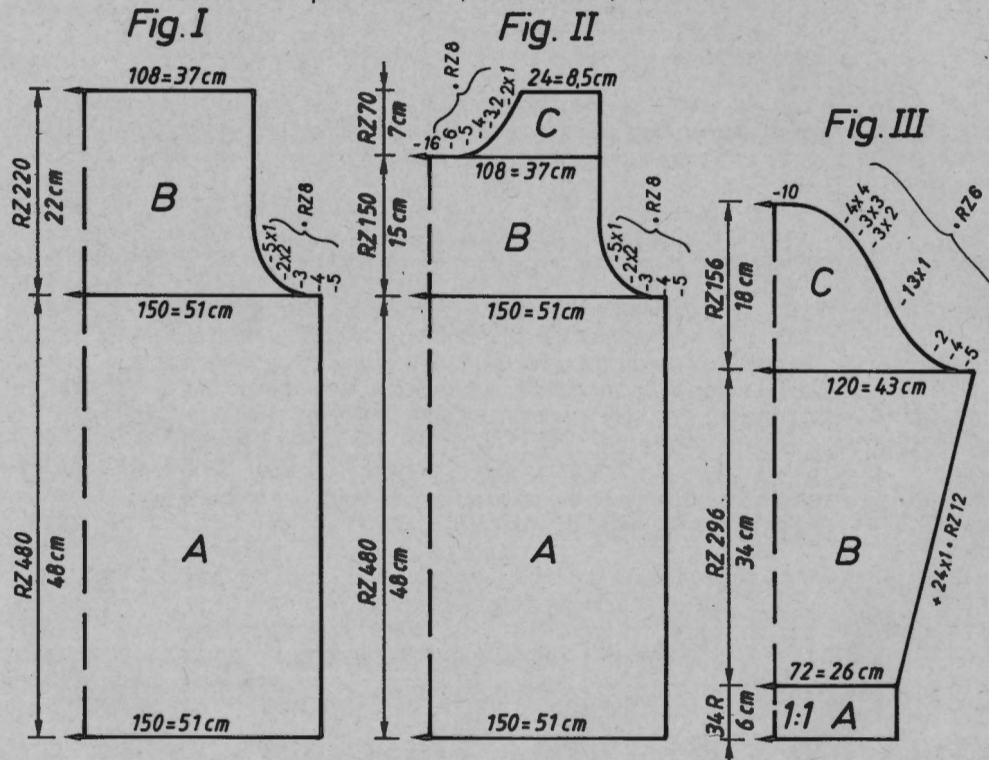
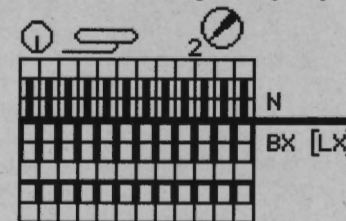

Diagram for 3 and 4 colour Fairisle
[TECH 208 and 196 but needle and lock according to diagram]



Colour sequence for Fig.III:

- 2 R yellow
- 2 R blue
- 2 R yellow
- 2 R brown

	Fig.I			Fig.II			Fig.III		
	34/3638/4042/44			34/3638/4042/44			34/3638/4042/44		
1	40	40	40	40	40	40	46	46	46
2	136	136	136	136	136	136	144	144	144
3	.	.	A	.	.	A	.	.	A
4	.	.	B	.	.	B	.	.	B
5	138	150	162	138	150	162	69	72	75
6	82	90	98	82	90	98	3	3	3
7	.	.	**	.	.	**	3	3	3
8	38	38	38	38	38	38	195	195	195
9	138	150	162	138	150	162	.	.	C
10	82	90	98	82	90	98	135	135	135
11	.	.	**	.	.	**	147	147	147
12	48	48	48	48	48	48	38	38	38
13	70	70	70	70	70	70	117	119	122
14	.	.	***	.	.	***	42	43	44
15	105	105	105	233	233	233	.	.	**
16	172	172	172	172	172	172	33	33	33
17	164	164	164	164	164	164	58	59	60
18	156	156	156	156	156	156	.	.	***
19	167	167	167	167	167	167	111	111	111
20	1	1	1	1	1	1	132	132	132
21	175	175	175	175	175	175	171	171	171
22	13	13	13	13	13	13	163	163	163
23	135	135	135	135	135	135	147	147	147
24	63	63	63	63	63	63	191	191	191
25	0	0	0	75	75	75	134	134	134
				184	184	184	32	32	32
				128	129	130	183	183	183
				180	180	180	2	2	2
				172	172	172	191	191	191
				164	164	164	130	130	130
				156	156	156	2	2	2
				148	148	148	191	191	191
				151	151	151	137	137	137
				1	1	1	5	5	5
				135	135	135	0	0	0
				128	128	128			
				0	0	0			

Colour sequence

- RC 0-48 2 R orange
- 2 R brown
- 2 R yellow
- 2 R blue
- RC 49-72 2 R green
- 2 R brown
- 2 R yellow
- 2 R blue
- RC 73-120 2 R rust
- 2 R brown
- 2 R yellow
- 2 R blue
- RC 121-224 2 R green
- 2 R brown
- 2 R yellow
- 2 R blue
- RC 225-296 2 R rust
- 2 R brown
- 2 R yellow
- 2 R blue
- RC 297-400 2 R green
- 2 R brown
- 2 R yellow
- 2 R blue
- RC 401-448 2 R orange
- 2 R brown
- 2 R yellow
- 2 R blue
- RC 449-472 2 R green
- 2 R brown
- 2 R yellow
- 2 R blue
- RC 473-520 2 R rust
- 2 R brown
- 2 R yellow
- 2 R blue
- RC 521-624 2 R green
- 2 R brown
- 2 R yellow
- 2 R blue
- RC 625-696 2 R rust
- 2 R brown
- 2 R yellow
- 2 R blue
- RC 697-704 2 R green
- 2 R brown
- 2 R yellow
- 2 R blue

Pattern sheet 2

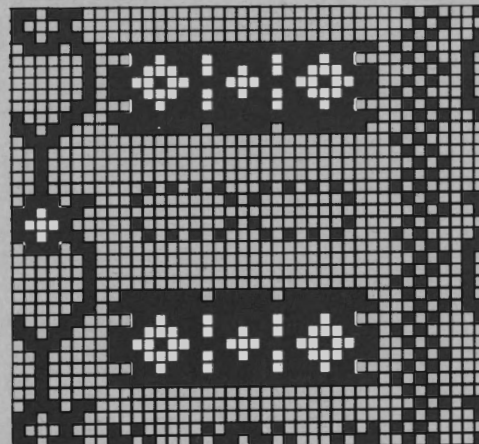

Pattern sheet 1

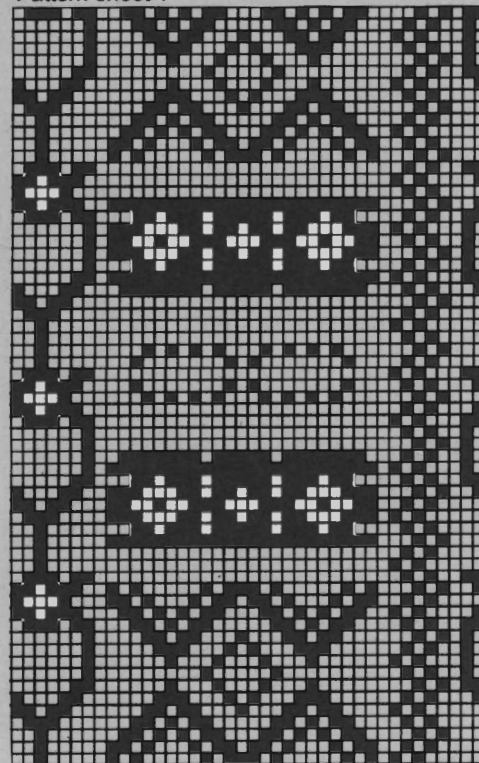

Pattern sheet 4

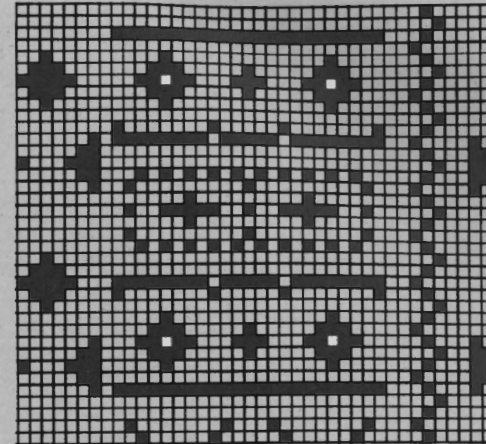

Pattern sheet 3

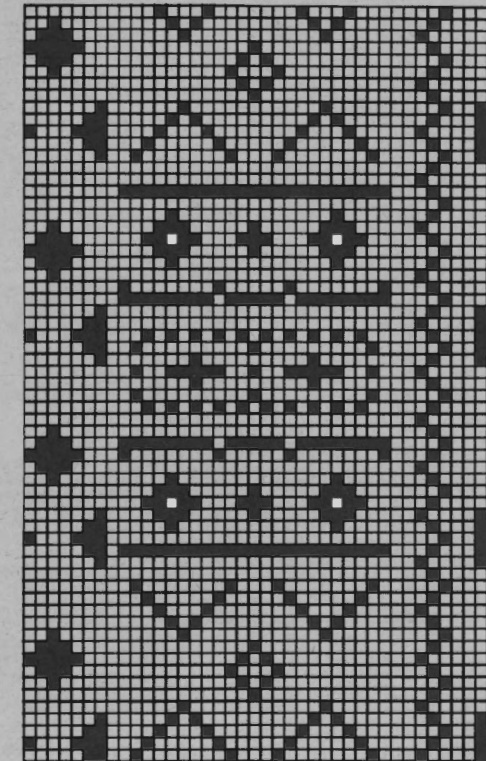

Pattern sheet 6

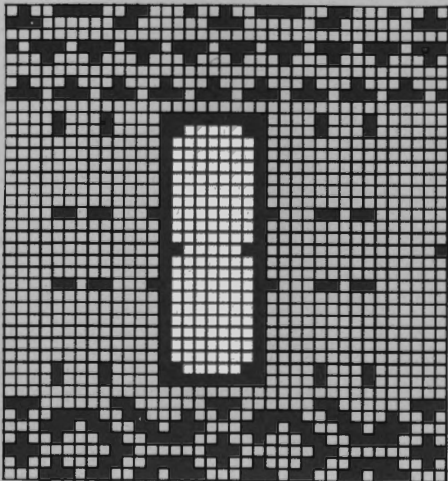

Pattern sheet 5

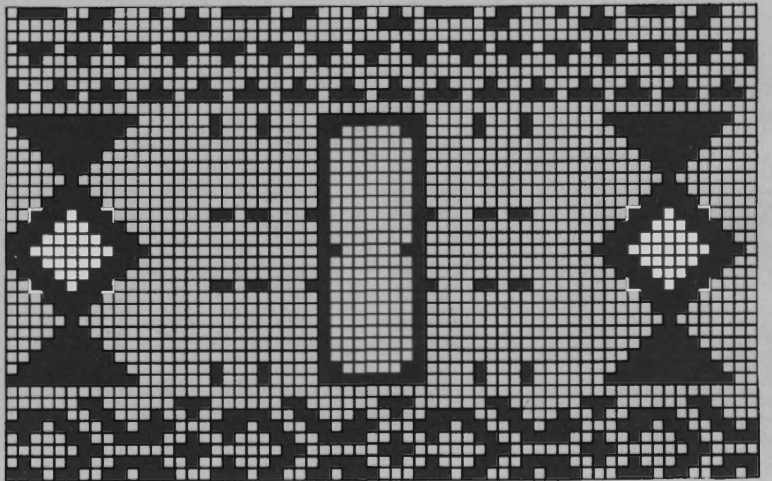

Pattern sheet 7

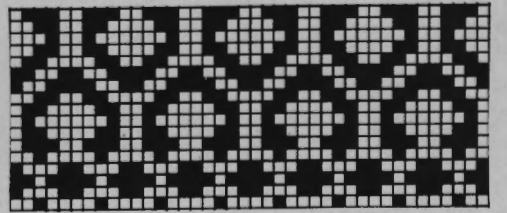

Pattern sheet 8

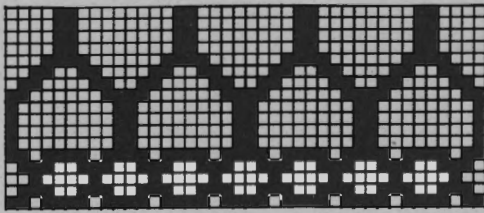

DECO 3

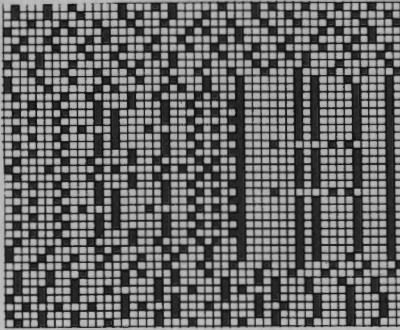

DECO 2

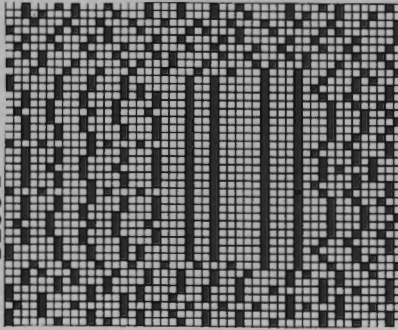

DECO 1

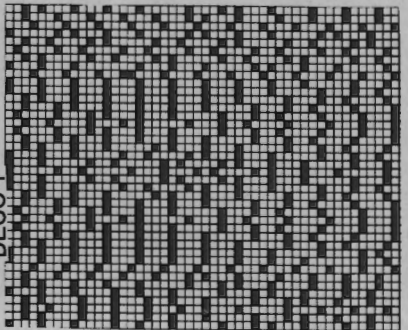

DECO 6

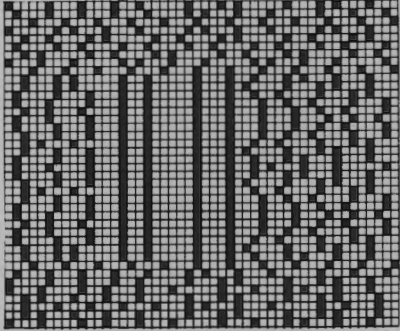

DECO 5

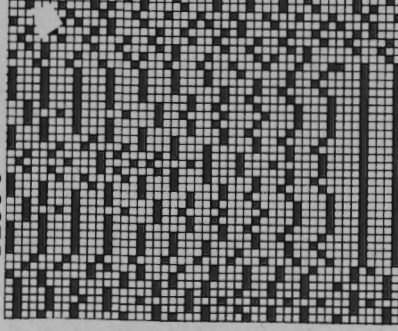

DECO 4

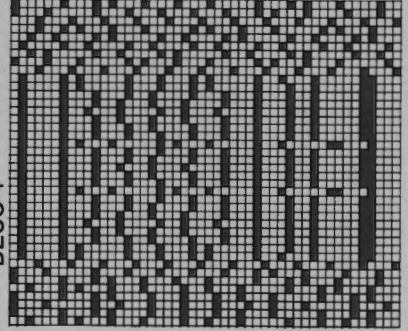

DECO 10



DECO 9

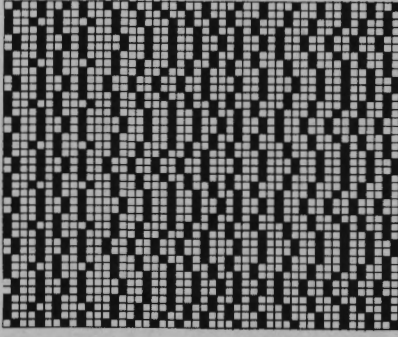

DECO 8

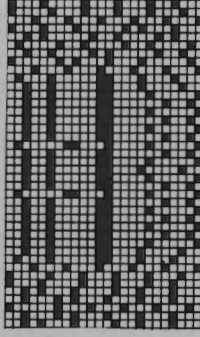

DECO 7

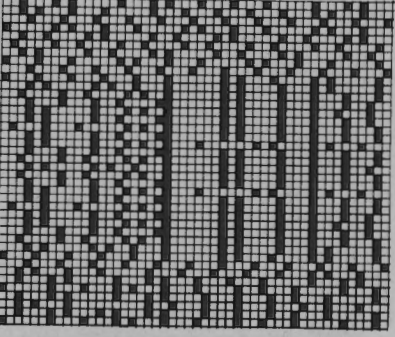

5934 DUOMATIC 80/S ELECTRONIC 6000

Length per 100 g = 900 m

Men's pullover 4 colour Fairisle

[Instructions for ELECTRONIC 6000 in square brackets]

Size: To fit 96 - 100 cm chest

Material: 100 g wool rust, 80 g wool orange, 70 g wool green and blue, 60 g wool yellow, 50 g wool brown (Moragarn from Conofil)

Stitch size: 4 colour Fairisle : back 4, front 4 1/2, band : 4, neckband : 4 1/2

Test square: 100 st 9 counted on front bed) = 34 cm, RC 100 = 10 cm

Pattern: 4 colour Fairisle according to diagram and colour sequence with self-punched DECO card [with self-drawn pattern sheets, pattern sheet 1, ADD pattern sheet 2, 3.COL = ENT, ADD pattern sheet 3, 4.COL = ENT, TECH 208 but lock and pusher position according to diagram], band = 2:2 [cast on 4, cont to knit]

Fig.I: Back

A = tubular cast on for 2:2 with rust wool double stranded [cast on 4, cont to knit]. B = bring all nds into the working position, knit acc to diagram and col seq with DECO punchcards [with pattern sheets, TECH 208 but acc to diagram]. C = shape both sides for sleeve, cont to knit straight, cast off

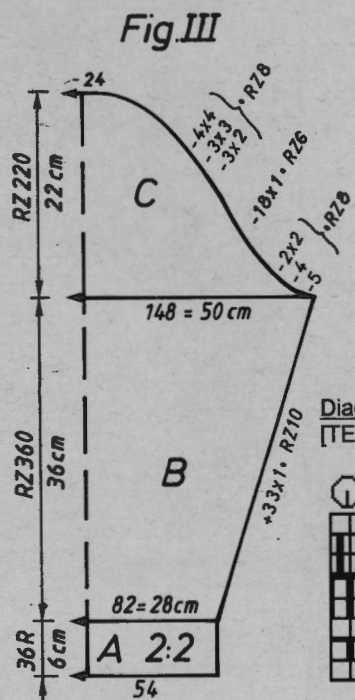
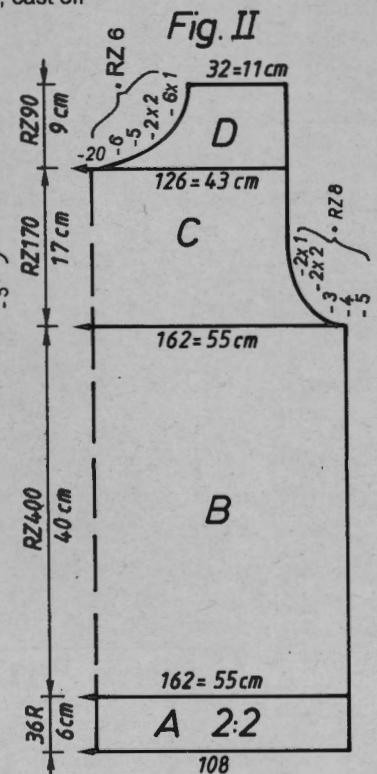
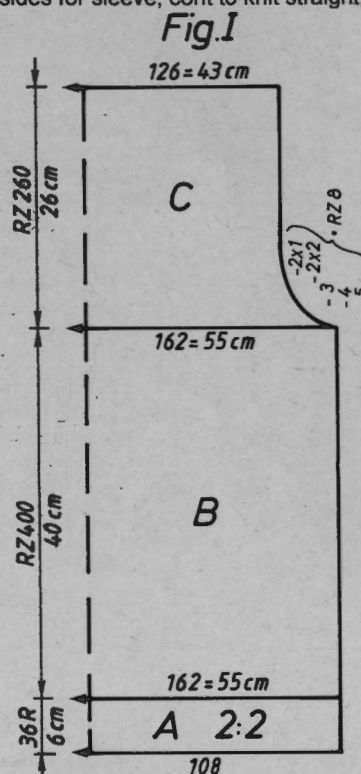

Diagram for 4 colour Fairisle
[TECH 208 but pusher and lock according to diagram]

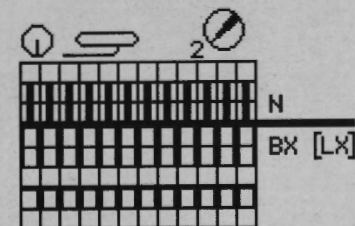

Fig.II: Front

Knit A + B as in Fig.1. C = shape both sides for sleeve, cont to knit. D = divide work, cast off centre st.(if you knit without FORM program, make a note of the electronic row counter), place left half onto decker combs. Cont to knit right half, and shape left for neck, cast off. Put left part back onto the same nds as before and finish knitting with reversed shape.

Fig.III: Sleeve, knit 2

A = tubular cast on for 2:2 with rust wool double stranded [cast on 4, cont to knit]. B = bring all nds into the working position, knit acc to diagram and col seq with DECO punchcards [with pattern sheets, TECH 208 but acc to diagram] and inc on both sides. C = shape both sides for sleeve head, cast off.

Neckband: Tubular cast on for 2:2 with double stranded rust wool [cast on 4, cont to knit] over 141 nds. Knit 16 R 2:2, then with lock front and rear CX knit 12 R, end with a few R of contrast yarn, lock N/N, release sts.

To make up: Block parts to size and leave to dry under a damp cloth. Sew shoulder seams. Sew neckband st by st with backstitch through open loops to neck, unravelling the contrast yarn, hem down on inside. With right sides together, sew sleeves to back and front. Sew sleeve and side seams with mattress stitch.

Colour sequence

RC 0-32	2 R rust
	2 R blue
	2 R green
	2 R orange
RC 33-48	2 R brown
	2 R blue
	2 R green
	2 R orange
RC 49-72	2 R brown
	2 R yellow
	2 R green
	2 R orange
RC 73-88	2 R blue
	2 R yellow
	2 R green
	2 R orange
RC 89-104	2 R blue
	2 R yellow
	2 R green
	2 R rust

repeat

5934

Fig.I	Fig.II			Fig.III					
44/4648/5052/54	44/4648/5052/54			44/4648/5052/54					
1	40	40	40	40	40	40	40	40	40
2	136	136	136	136	136	136	136	136	136
3			A			A			A
4			B			B			B
5	150	162	174	150	162	174	79	82	85
6	90	98	106	90	98	106	3	3	3
7			**			**	3	3	3
8	195	195	195	195	195	195	195	195	195
9			C			C			C
10	135	135	135	135	135	135	135	135	135
11	151	151	151	151	151	151	151	151	151
12	38	38	38	38	38	38	38	38	38
13	150	162	174	150	162	174	144	147	150
14	90	98	106	90	98	106	49	50	51
15			**			**			**
16	40	40	40	40	40	40	35	35	35
17	72	72	72	72	72	72	62	64	66
18			***			***			***
19	105	105	105	233	233	233	109	109	109
20	172	172	172	172	172	172	133	133	133
21	164	164	164	164	164	164	172	172	172
22	156	156	156	156	156	156	164	164	164
23	167	167	167	167	167	167	167	167	167
24	1	1	1	1	1	1	1	1	1
25	151	151	151	151	151	151	191	191	191
26	1	1	1	1	1	1	139	139	139
27	135	135	135	135	135	135	47	47	47
28	95	95	95	95	95	95	183	183	183
29	0	0	0	73	73	73	5	5	5
				184	184	184	191	191	191
				130	131	132	130	130	130
				180	180	180	5	5	5
				172	172	172	99	99	99
				167	167	167	191	191	191
				1	1	1	137	137	137
				183	183	183	9	9	9
				17	17	17	0	0	0
				133	133	133			
				0	0	0			

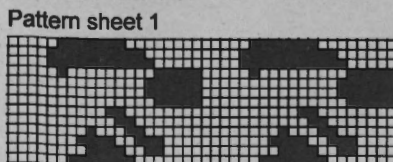
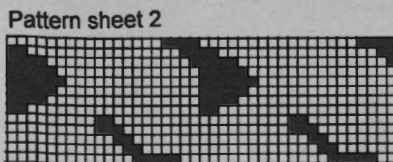
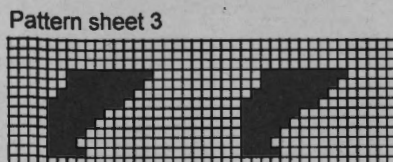
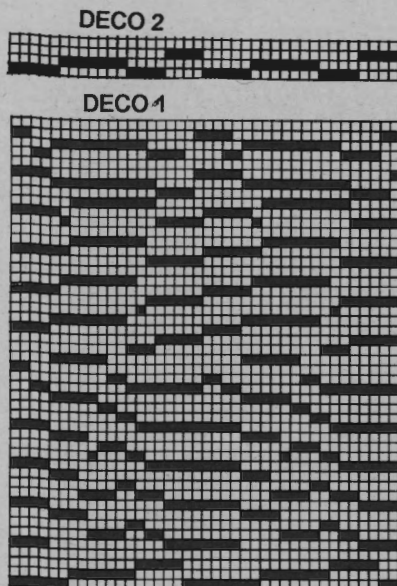

5940

Fig.I	Fig. II		
34/3638/4042/44	34/36	38/40	42/44
26	26	26	26
98	98	98	98
		A	A
		B	B
122	139	155	122
82	90	98	82
		**	**
195	195	195	195
		C	C
135	135	135	135
159	159	159	159
38	38	38	38
139	155	171	139
82	90	98	82
		**	**
18	18	18	18
40	40	40	40
		***	***
234	234	235	234
135	135	135	135
1	1	1	1
171	179	187	171
163	171	128	163
155	155	179	155
158	166	155	158
159	159	166	159
2	2	159	2
135	135	2	135
96	96	135	96
74	74	96	74
184	184	74	184
135	137	184	135
190	190	139	190
133	133	190	133
190	190	133	190
129	129	190	129
175	175	129	175
8	8	175	8
135	135	8	135
24	24	135	43
0	0	24	0
		0	0

5941

76

Fig.II	Fig.III		
34/3638/4042/44	34/3638/4042/44		
28	28	28	28
423	423	423	168
		A	A
		B	B
57	62	67	64
82	90	98	3
		**	3
195	195	195	195
		C	C
135	135	135	135
156	156	156	156
166	166	166	38
57	62	67	112
82	90	98	47
		**	48
56	56	56	42
61	61	61	58
		***	59
			60

68	68	68	98
191	191	191	135
142	143	144	128
255	255	255	0
201	201	201	0
0	0	0	0

Colour sequence

- RC 0-48 2R white
- 2R orange
- RC 49-80 2R white
- 96 2R green

Diagram for headband:
[TECH 180]

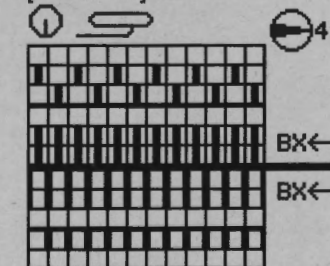

5940 DUOMATIC 80 ELECTRONIC 6000

Top and headband

Model Sharon Nani USA

[Instructions for ELECTRONIC 6000 in square brackets]

Size: To fit 88 - 92 cm bust

Material: 110 g cotton white, 130 g acryl orange, 90 g Rayon bouclés green, knitting elastic

Stitch size: 3 colour Fairisle: back = 4 1/2, front = 5 1/2, neck and sleeve bindings = 4

Test square: 100 st (counted on front bed) = 24.5 cm, RC 100 = 6.5 cm

Pattern: When knitting with DUOMATIC 2 colour Fairisle according to diagram for headband with self-punched DECO card 2 [with self-drawn pattern sheet, pattern 1, ADD pattern sheet 2, 3.COL = ENT, TECH 195 but lock and needle arrangement according to diagram 1], band = 1:1 [cast on 1, cont to knit]

Fig.I: Back

A = tubular cast on for 1:1 [cast on 1, cont to knit] with white cotton and knitting elastic. B = bring all nds into the working position, cont to knit 2 colour Fairisle acc to diagram for headband with col seq 2 and DECO punchcard 2 [with pattern sheet 1, TECH 195 but acc to diagram 1], and inc on both sides. C = shape both sides for sleeve. D = divide work, cast off centre st (if you knit without FORM program, make a note of the electronic row counter), place left half onto decker combs. Cont to knit right half, and shape left for neck, cast off. Put left part back onto the same nds as before and finish knitting with reversed shape.

Fig.II: Front

Knit A + B as in Fig.I. B = shape both sides for sleeve, cont to knit. C = divide work,

cast off centre st (if you knit without FORM program, make a note of the electronic row counter), place left half onto decker combs. Cont to knit right half, and shape left for neck, cast off. Put left part back onto the same nds as before and finish knitting with reversed shape.

Border: Neck front: cast on with racking for K/K with orange acryl [cast on 3] over 114 nds. Knit with double stranded white cotton and knitting elastic acc diagram 2, st.s 4, knit 6 R [ELECTRONIC as well] lock rear and front CX, st.s 4 1/2, knit RC 12 [ELECTRONIC as well], end with a few R of contrast yarn, cast off. For neck back over 94 nds, for sleeves over 128 nds, knit 2.

To make up: Block parts to size and leave to dry under a damp cloth. Sew neckband st by st with backstitch through open loops to neck, unravelling the contrast yarn, hem down on inside. Sew shoulder seams. Gather sleeves and sew on cuff. Sew sleeve and side seams with mattress stitch.

Headband: Tubular cast on for K/K [cast on 2] with white cotton and knitting elastic over 160 nds. St.s 4 1/2, front 5 1/2, knit acc to diagram and col seq 2 with DECO punchcard 2 [with pattern sheet 2, TECH 180] RC 80, cast off without knitting elastic.

Diagram 1 for 3 colour Fairisle
[TECH 195 needle rear according to diagram]

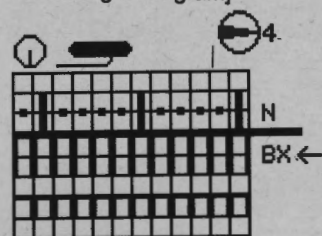
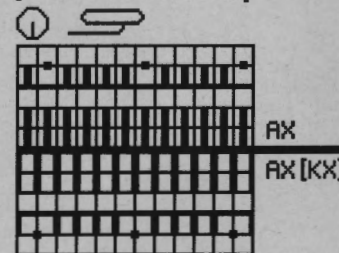

Diagram 2 for borders:
[ELECTRONIC as well]



DECO 2.
Pattern sheet 3

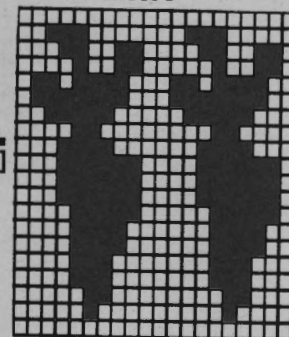

Fig. I

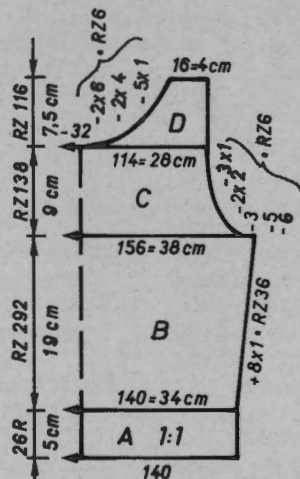
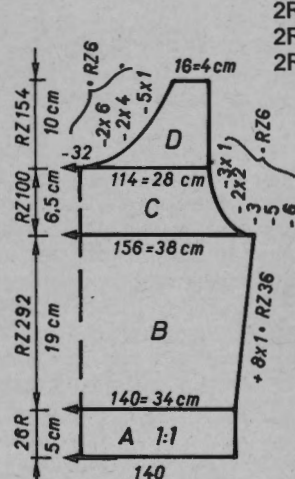
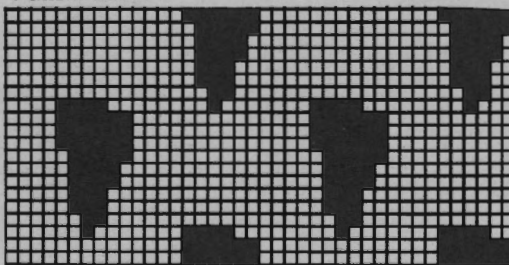

Fig. II



Colour sequence 1:
2R white with knitting elastic
2R orange
2R green

Pattern sheet 1



Pattern sheet 2

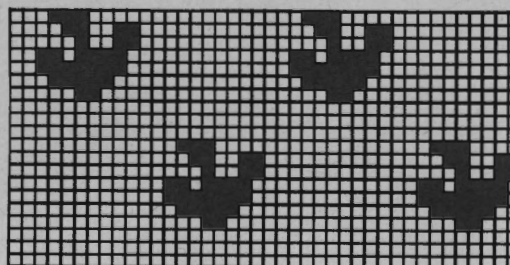

5941 DUOMATIC 80 ELECTRONIC 6000

Lady's jacket with bubble fairisle

Model Sharon Nani USA

[Instructions for ELECTRONIC 6000 in square brackets]

Size: To fit 88 - 92 cm bust

Material: 360 g cotton white, 180 g cotton green, 210 g acryl orange, 150 g rayon bouclés green, remnant knitting elastic, 5 buttons.

Stitch size: Pattern = back 5 1/2, front 6 1/2, buttonhole facing 4 1/2, band 4.

Test square: 100 st (counted on front bed) = 42 cm, RC 100 = 7 cm

Pattern: 2 colour Fairisle according to diagram and colour sequence with self-punched DECO cards [with self-drawn pattern sheets, TECH 193, POSITION = ENT, ↑ REP.R = NO, ↔ REP.ST = ENT] band and buttonhole facing = 1:1 [cast on 1, cont to knit].

Fig.I: Back

A = tubular cast on for 1:1 [cast on 1, cont to knit] with white cotton and knitting elastic, cont to knit without knitting elastic. B = bring all nds to the working position, cont to knit acc to diagram and col seq with DECO punchcards [with pattern sheets acc to diagram, TECH 193], cast off.

Fig.II: Front, knit two reversed shapes.

A = tubular cast on for 1:1 [cast on 1, cont to knit] with white cotton and knitting elastic, cont to knit without knitting elastic. B = bring all nds to the working position, cont to knit acc to diagram and col seq with DECO punchcards [with pattern sheets

acc to diagram, TECH 193]. C = shape left for neck, cast off.

Fig.III: Sleeves, knit 2

A = tubular cast on for 1:1 [cast on 1, cont to knit] with white cotton and knitting elastic, cont to knit without knitting elastic. B = bring all nds to the working position. Start to knit with DECO punchcard, right 76, left 38, acc to diagram [with pattern sheets, TECH 193, POSITION = ENT, ↑ REP.R = NO, ↔ REP.ST = ENT], cont to knit with col seq, and inc on both sides, cast off.

Buttonhole facings: Tubular cast on for 1:1 [cast on 1, cont to knit] with white cotton over 46 nds, hang centre st from rear bed onto the front bed, so that the facing fold is knitted over 3 nds, work in a buttonhole over 11-13 right and 12-14 left of centre in the rows 452, 486, 554, 588, knit to R 594, cast off.

To make up: Block parts to size and leave to dry under a damp cloth. With right side together, sew buttonhole facing to front edge and neck, fold over, and hem down on inside. With right sides together, sew sleeves to back and front. Sew sleeve and side seams with mattress stitch. Sew on buttons.

FORM program Fig.II + III page 76

Colour sequence:

RC 0-376 2R white
6R orange
RC 377-488 2R white
6R rayon bouclés green
RC 489-800 2R white
6R cotton green

Length per 100 g =

Cotton white double stranded 665 m
Acryl orange 1050 m
Rayon bouclés green 640 m
Cotton green 510 m

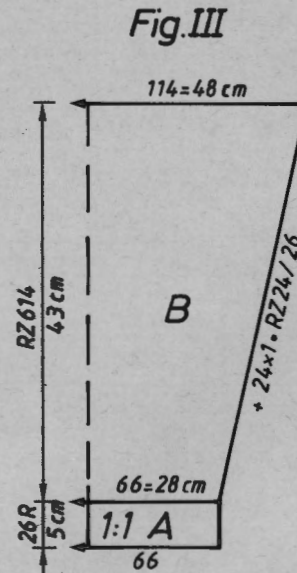
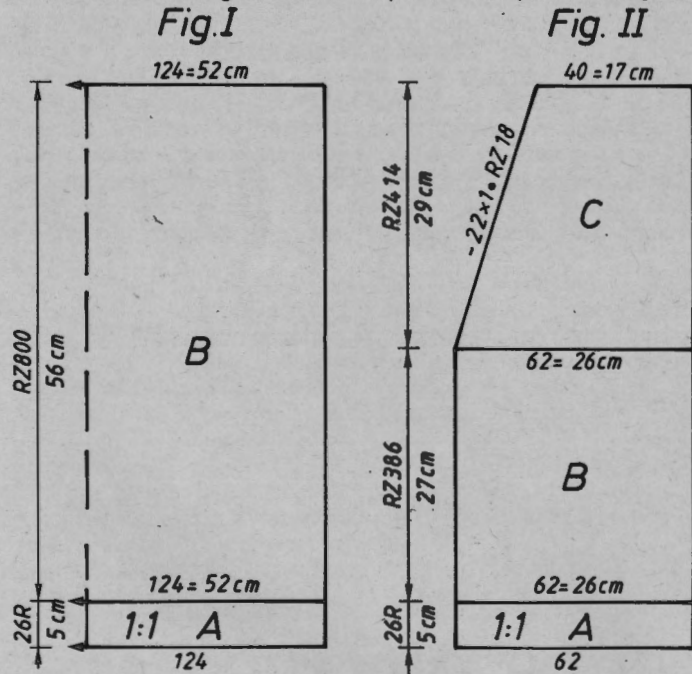
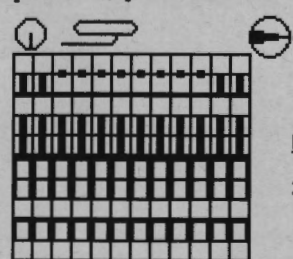

Diagram for 2 colour bubble Fairisle [TECH 193]



DUOMATIC 80:

2 R N with DECO
BX←
1 R BX with DECO
BX←
Leave DECO on the left bed
estension.
4 R BX without DECO
BX
Attach DECO to the loch again
1 R BX with DECO
BX←

Fig.I

	34/36	38/40	42/44
1	28	28	28
2	168	168	168
3	.	.	A
4	.	.	B
5	114	124	133
6	82	90	98
7	.	.	**
8	195	195	195
9	.	.	C
10	135	135	135
11	156	156	156
12	38	38	38
13	114	124	133
14	82	90	98
15	.	.	**
16	56	56	56
17	61	61	61
18	.	.	***
19	0	0	0

5936 DUOMATIC 80/S ELECTRONIC 6000

5941 DECO card / pattern sheet

	Fig.IX			Fig.X
	34/3638/4042/44			34/44
1	50	50	50	166
2	110	110	110	142
3	.	.	A	A
4	.	.	B	B
5	55	58	62	11
6	3	3	3	3
7	3	3	3	3
8	195	195	195	101
9	.	.	C	62
10	135	135	135	133
11	129	129	129	129
12	38	38	38	190
13	84	91	98	133
14	88	96	104	0
15	.	.	**	
16	46	46	46	
17	48	48	48	
18	.	.	***	
19	100	100	100	
20	135	135	135	
21	85	85	85	
22	192	192	192	
23	2	2	2	
24	195	195	195	
25	.	.	C	
26	135	135	135	
27	149	149	149	
28	0	0	0	

Leggings:

Model Sharon Nani USA

[Instructions for ELECTRONIC 6000 in square brackets]

Size: To fit 94 - 98 cm hips

Material: 510 g cotton white, 60 g knitting elastic, remnants acryl orange, 70 cm elastic.

Stitch size: Pattern = rear 4 1/2, front 5 1/2.

Test square: 100 st (counted on front bed) = 27.5 cm, 100 R = 12.5 cm.

Pattern: Ribbed according to diagram 1 [TECH 102 but needles arranged as in diagram 1]. Cast on according to diagram 2 and colour sequence [cast on 3, but pushers arranged according to diagram 2]. Waistband 1:1 [TECH 101]

Fig.IX: Knit 4

A = cast on with racking for K/K [cast on 3] with white cotton double stranded acc to diagram 2, st.s 4, knit 6 R [ELECTRONIC as well]. B = transfer st acc to diagram 1, knit ribs with white cotton and knitting elastic acc to diagram 1 [TECH 102 acc to diagram 1], and inc on both sides. C = cont to knit straight. D = Hang st for 1:1, cont to knit [ELECTRONIC as well], cast off.

Fig.X: Gusset

A = tubular cast on for 1:1 [cast on 1] with white cotton and knitting elastic stranded together. Transfer all st to the front bed, knit stocking stitch [TECH 100], and inc on both sides. B = shape both sides, cast off.

To make up: Block parts to size and leave to dry under a damp cloth.

With right sides together, sew gusset to inside leg. Sew front and back seams, sew inside leg and side seams with mattress stitch. Fold over waistband, hem down on inside. Pull elastic through.

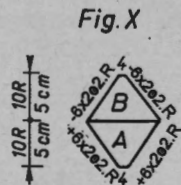
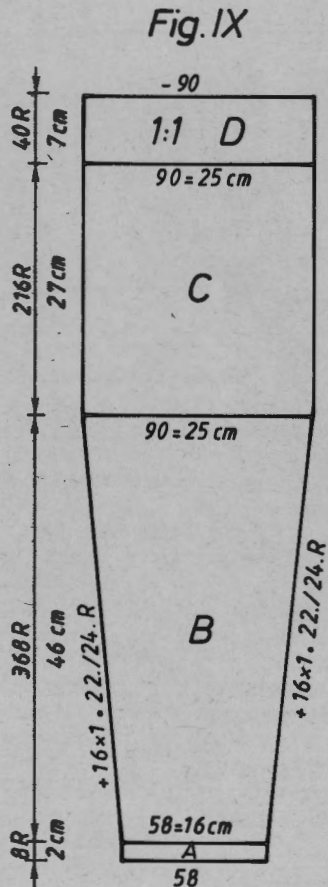

Diagram 1 for pattern:
[TECH 102, but needle arrangement according to diagram]

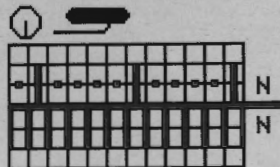
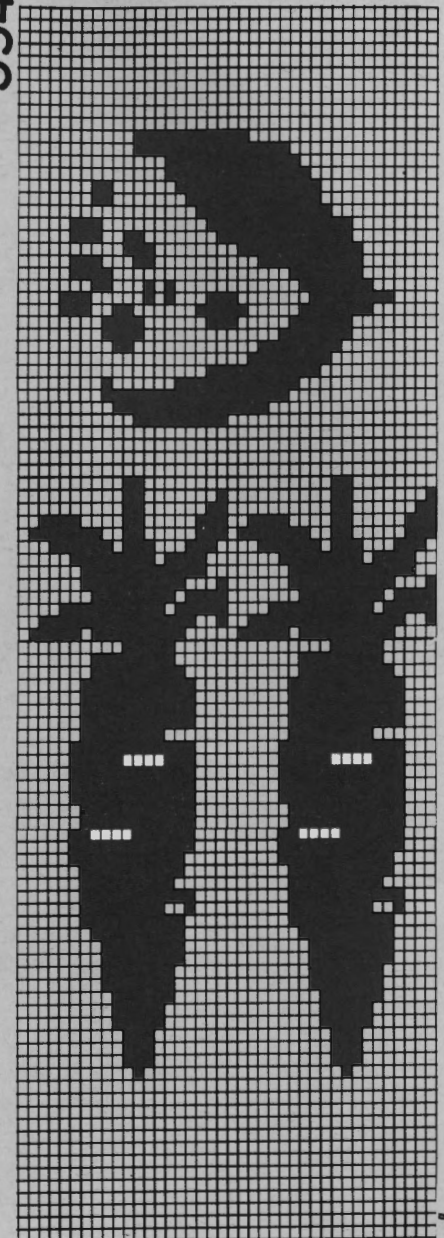
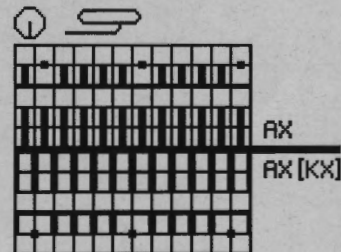

Diagram 2 for cast on:
[cast on 3, then knit according to instructions]



5927 DUOMATIC 80/S ELECTRONIC 6000

Length per 100 g = 288 m

Lady's waistcoat

Model Lana Chic, Rapperswil-Jona

[Instructions for ELECTRONIC 6000 in square brackets]

- Size:** To fit 88 - 92 cm bust
- Material:** 500 g green silk (LA-SE-TA from Lang) remainders of 4 colours
2 hooks and eyelets for fastener
- Stitch size:** Stocking stitch = 7, Hem = 5 1/2, sleeve bindings and border = 4
- Test square:** 100 st = 36 cm, 100R 24 cm
- Pattern:** Stocking stitch [TECH 100], Hem = tubular [cast on 8, cont to knit].
Border and sleeve bindings = interlock [TECH 118]

Fig.I: Back

A = closed tubular cast on [cast on 8, cont to knit]. B = transfer all st to the front bed, cont to knit stocking stitch [TECH 100]. In row 84, transfer the central 2 st to the rear bed, lock rear N, then every second row transfer another st to the rear bed. C = shape both sides for sleeve, cont to knit straight, cont to transfer st to the rear bed, cast off.

Fig.II: Front, knit two reversed parts

A = closed tubular cast on [cast on 8, cont to knit]. B = transfer all st to the front bed, cont to knit stocking stitch [TECH 100]. In row 84, transfer the 1 st on the left edge to

the rear bed, lock rear N, then every second row transfer another st to the rear bed, cont to knit. C = shape left for neck. D = shape right for sleeve, left for neck, cast off.

Border: Closed tubular cast on [cast on 8] over 8 nds, st.s 4, interlock acc diagram [TECH 118], knit RC 754, cast off.

Sleeve bindings: knit 2

Tubular cast on for 1:1 [cast on 1] over the whole width of the bed. St.s 4. After casting on, bring all nds to the working position, knit interlock [TECH 118] RC 8, end with a few R of contrast yarn, cast off.

Tube: knit in 4 different colours

Closed tubular cast on [cast on 8, cont to knit] with 3 nds front and 3 nds rear, st.s 3, knit RC 1200, end with a few R of contrast yarn.

To make up: Block parts to size and leave to dry under a damp cloth. Sew tube motive to back and front as shown. Sew shoulder seams. Sew sleeve bindings st by st with backstitch to sleeve hole through open loops and unravelling contrast yarn.

With right sides together, sew border to front and neck. Sew side seams with mattress stitch. Sew on 2 hooks and eyelets.

Fig.II

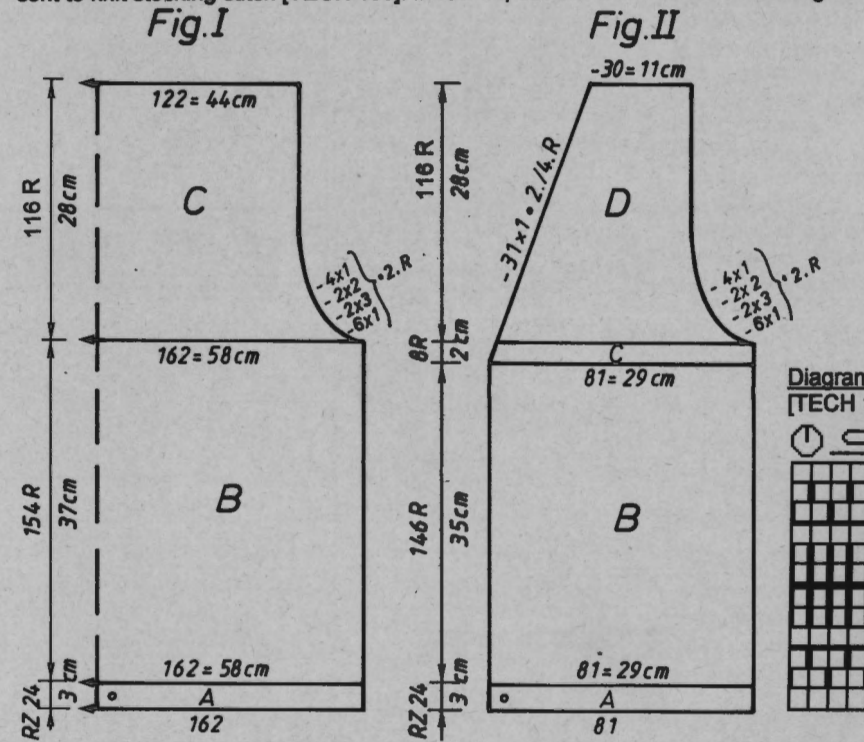

Fig.I	34/3638/4042/44			34/3638/4042/44		
1	96	96	96	96	96	96
2	144	144	144	399	399	399
3	.	.	A	.	.	A
4	.	.	B	.	.	B
5	150	161	172	75	81	86
6	82	90	98	82	90	98
7	.	.	**	.	.	**
8	194	194	194	194	194	194
9	.	.	C	.	.	C
10	134	134	134	134	134	134
11	38	38	38	166	166	166
12	150	161	172	75	81	86
13	82	90	98	82	90	98
14	.	.	**	.	.	**
15	37	37	37	37	37	37
16	68	68	68	68	68	68
17	.	.	***	.	.	***
18	102	102	102	67	67	67
19	178	178	178	191	191	191
20	182	182	182	151	152	153
21	162	162	162	183	183	183
22	164	164	164	102	102	102
23	135	135	135	178	178	178
24	37	37	37	182	182	182
25	0	0	0	162	162	162
				164	164	164
				135	135	135
				37	37	37
				0	0	0