

21-3



*Summertime,
and the
knitting
is easy.*

THE UNIVERSITY OF
217 EASTON 1800
NEWARK, NJ 07102



608
*Suited for
Success*

A beautiful three-piece Suit is always new, always admired and always a challenge to complete. . . The Skirt is a Stockinette stitch, the Shell and Jacket a striking Fair Isle Design. Wear it for any occasion and knit it with our Pearllite yarn in sizes 8 to 14.



620

*Lace &
Fine Lace*

Switch machine controls from normal Lace to fine Lace and an exciting two piece Dress is yours for the knitting. The full skirt drapes beautifully and the Top with three quarter sleeves has ribbed bands. Knit it with our favorite wash and wear Amore. Sizes 6 to 14.

Table of Contents

Editorial

KNITKING MAGAZINE -- VOLUME 21, NO.3

ITEM		PAGE
605	WOMEN'S TWO-PIECE DRESS.....	13
606	WOMEN'S SKIRT & JACKET.....	14
607	WOMEN'S DRESS.....	16
608	WOMEN'S THREE-PIECE SUIT.....	17
609	WOMEN'S DRESS & JACKET.....	19
610	WOMEN'S TWO-PIECE DRESS.....	21
611	WOMEN'S WOVEN JACKET.....	22
612	WOMEN'S MULTI-COLORED JACKET.....	23
613	WOMEN'S THREE-PIECE SUIT.....	25
614	WOMEN'S TWO-PIECE DRESS.....	26
615	WOMEN'S SKIRT & JACKET.....	28
616	WOMEN'S THREE-PIECE SUIT.....	29
617	WOMEN'S SKIRT & JACKET.....	31
618	WOMEN'S TWO-PIECE DRESS.....	32
619	WOMEN'S TENNIS DRESS.....	33
620	WOMEN'S TWO-PIECE DRESS.....	34
621	WOMEN'S YOKE SWEATER.....	35
622	CHILD'S DRESS, BLANKET & BIB.....	36
623	WOMEN'S DRESS.....	38
624	GIRL'S DRESS.....	39
625	MEN'S PULLOVER.....	40
626	MEN'S PULLOVER.....	41
KNITKING NEWS.....		43

It seems that no matter how often or by how much we increase the size of our premises at KNITKING we always are short of space, especially warehouse space. During the twenty-two years that we have published KNITKING MAGAZINE we have accumulated a substantial number of back issues that somehow got distributed to various parts of our premises. We recently decided to consolidate them in one area and take an inventory of the complete stock. The procedure gave your editor an opportunity to study back issues going back to our very first one. It was quite a revelation to see the styles once more and to note how similar they are to today's. Issue number one went out in September 1964 and the cover garment would look just as appropriate on the cover of this issue . . . The styles have changed, models have changed but most garments -- men's, women's and children's -- would fit in beautifully with today's styles.

Machines have, of course, become much more versatile, more automated and a lot easier to use in regard to forming stitch designs. KNITKING machines in 1964 had the capability of knitting tuck stitch and fairisle designs up to twelve stitches wide, and with a separate accessory (the JAC 40) fairisle up to 46 stitches wide. Intarsia knitting was also possible on these old model machines. So, there is no doubt that the patterns in back issues of KNITKING MAGAZINE can be duplicated on practically all modern design knitting machines.

We do not have all back issues available but now that we have them all in one place there is quite a selection and we have decided to make them available to our readers at big discount prices. A list and order form is included as an insertion in this issue.

We look forward to seeing old friends and meeting many new ones at our annual Seminar. Remember the dates, September 14th through the 19th . . . See you then.

605 Cover

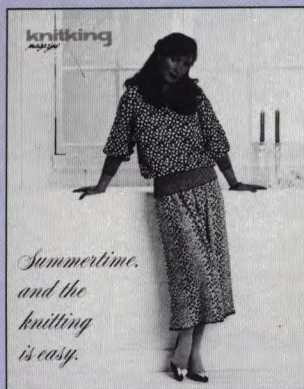

Every issue of KNITKING MAGAZINE promises to be the best ever and this one is no exception. Beginning with our Cover Model, the striking two-piece Dress is in a Fair Isle Design, the Skirt knitted sideways on the machine. You can knit it on any Punch Card or Electronic machine. The Sizes are 8 to 16, the Yarn Pearlite and Venetia.

Publisher: KNITKING CORPORATION, 1128 Crenshaw Blvd., Los Angeles, Calif. 90019. Telephone: (213) 938-2079. Published quarterly. Subscriptions: USA—\$18.00 annually, single copies \$5.00; \$21.00 all other countries. The entire contents of KNITKING MAGAZINE are copyright and must not be reproduced in any shape or form without the express permission, in writing, of the publisher.
© COPYRIGHT 1987 KNITKING CORPORATION



616

Dramatic

Perfectly styled to wear for any occasion. A Three-piece Suit takes top priority in knit fashions of the day. Make the Skirt and Top in Stockinette stitch, the Jacket in a Fair Isle Design. Use Venetia and knit it in sizes 8 to 14.



606
Cool
Cotton

Hook up your Garter Carriage and make an elegant two-piece Suit. The Pattern is programmed for the COMPUKNIT III machine. Bands are K1, P1 Ribbing. Knit it with our Fiorina (a super Egyptian Cotton). Sizes 8 to 16.



614

Flattering

Anyone can look elegant wearing this lovely two piece vertical striped Dress. The Top boasts the popular Dolman sleeves. It is knitted sideways on the machine. Bands are K1, P1 Ribbing. Pearlite is plated with Glace for a silky look. Sizes 8 to 18.

MRS J ZEREBECKY
217 EASTERN PKWY
NEWARK NJ 07106



618

Alluring

A whirl of a Skirt that is knitted sideways in Stockinette stitch. The full blouse has saddle shoulders and a soft round neckline. Ribbed bands complete a striking picture. The yarn is Pearlite. Sizes 8 to 16.



607

Refreshing

Thread Lace becomes more and more important as a part of any knitted collection. The simple lines and lovely Design will show off a pretty figure. Knit it with Glacé and matching sewing thread. Sizes 8 to 16.



613

Suitable

for travel, everyone needs a three piece ensemble. It has the sleek lines and elegant look we all love. Pretty Pebble and Glacé are knitted together in Stockinette stitch on a Bulky machine. The bands are crochet. Sizes 6 to 14.



609 Travel

around the world or on a romantic cruise and wear this simple sheath, and lovely Fair Isle Jacket. The Dress is Stockinette stitch and the Jacket can be knitted on any Electronic machine. Pearlite is the yarn and the sizes 8 to 16.



623 Ravishing Red

A very simple sheath Dress can be dressed up or down with chosen accessories such as a Necklace, Scarf, jeweled Pin or Belt. Knit it in Stockinette stitch and rib the bands. Venetia is the yarn and sizes are 8 to 16.

624 Charming

A sweet little girl shows off her pretty dress. An Ice Cream Cone is isolated on the front bodice. A band of Cherries trim waist and sleeves. Large single Motif Cherries are also on bodice and seem to be falling into the ice cream. Any little Girl 5 to 8 years old will adore it. Knit it with our Pearlite yarn.

General Instructions

THE PRINTED INSTRUCTIONS

Follow the printed instructions or use them in combination with the Charts. Where there is any question in the instructions, you have the Charts to show you how the section will look.

Be sure to READ AHEAD so that you KNOW what to do for the size you are knitting. In the shapings, where the number of stitches are the same but the number of times different, you might find shapings like this... 3 sts. 1 x (2x) [3x]—so that for the first size you will bind off 3 sts. 1x, 2nd size 3 sts. 2x, 3rd size 3 sts. 3x. Sometimes the ROWS will be different for each size—so you must watch out for different row numbers.

Shoulder and neck shapings for the back section of a garment usually are shaped at the same time—so ALWAYS WATCH for the words AT THE SAME TIME.

HOLDING STITCHES ON THE LEFT SIDE WHILE SHAPING THE RIGHT SIDE

There are different ways to hold stitches on one side while completing the other side. Usually, we tell you to bind off the center sts. for neck and put the left side into holding position while completing the right side. The easiest way and really the best way for beginners is to take a piece of RAVEL CORD and hand knit the center neck stitches, pulling them back against the needle bed of machine to the "A" or out of work position. The stitches remain in the HOOKS of the needles so you are really only knitting them HALF WAY. With another color of Ravel Cord, knit the remaining sts. on the left side in the SAME WAY.

It is important to protect these held stitches in some way—so you can either hang a REVERSING BAR so that the EYES of the Bar go BETWEEN the Gate Pegs on the machine and that the UPPER TIPS of Bar only—show above the needle bed...OR the simplest way is to use a piece of 1 inch masking tape and GENTLY place it beneath the knitting—right below the gate pegs. Do NOT press the tape—only enough pressure to hold it in place. This will prevent the Carriage (or Slide) from marking the held section.

It is VERY IMPORTANT that you mark the PATTERN ROW where you divide for the split for NECK (or SHOULDER) shaping....If you are using a PUNCH CARD—MARK THE CARD—if you are using an ELECTRONIC machine, MARK THE DESIGN WINDOW. Also take note of the Row number for the division. When you are ready to work the left section, bring the HELD stitches back to B (working) position by pulling each end of the Ravel Cord GENTLY and rip it off—be sure to align all needles straight in the B or knitting position.

Now you are ready to REFER TO YOUR OWN INSTRUCTION MANUAL for your machine—to set the controls to begin knitting the left half. The neck stitches can be bound off after completing the right side or you can leave them in hold until each side is finished, then bind them off or remove them onto contrast waste yarn ready to be picked up for knitting a neckband or for other finishing.

FULL FASHION DECREASING OR INCREASING

For Stockinette stitch, use the Full Fashion method for decreasing or increasing (except for regular cap shaping on sleeves where you decrease the edge stitch).

TO DECREASE: Hang the 3rd stitch onto the 2nd stitch then move the end stitches in to fill the empty needle.

TO INCREASE: Move the 2nd end stitches 1 needle outward, then pick up the 3rd stitch from the row below and hang it onto empty needle.

PATTERN SYMBOLS (Abbreviations on page 13)

() Symbol for 2nd size.

[] Symbol for 3rd size.

There are up to 3 sizes given for Patterns in KNITKING MAGAZINE. For example, the Charts and printed instructions will show the cast-on as... 124—First size. [132]—Second size. [140]—Third size.

R= ROW

☐ Needles in holding position.

☒ Needles back into working position.

For Short Row Knitting

THE SAMPLE SWATCH

Before you knit any garment, you must knit a sample swatch using the yarn you have chosen for your garment. If you do not get the correct Stitch and Row Gauge as given for a Pattern in KNITKING MAGAZINE—try different tensions. If you are using the specified yarn, you should be able to get the correct gauge using a smaller or larger tension. If you are using a different yarn, you may have to make several swatches—but the gauge is very important.

To make a sample swatch—Cast on 60 stitches with waste yarn and knit 6 rows. Mark the tension number for your sample swatch by making holes (you can do this with a Lace Carriage or by hand), 4 transfers for Tension 4, 6 transfers for Tension 6, etc. Knit 6 more rows.

Change to garment yarn and set Counter at 0. Knit 30 rows (in Stockinette stitch or Pattern stitch—according to the garment). With Contrast waste yarn knit the 10th stitch FROM EACH SIDE—by hand. Knit 30 rows. Change to waste yarn and knit 12 rows. Remove the sts. from the machine by pushing the Carriage (or Slide) across without yarn.

Pull and stretch the sample swatch both lengthwise and diagonally from corner to corner, then lengthwise again. Gently block the swatch (KNITKING PRESSING CLOTHS are great for this)—or you can allow the sample to rest several hours or even over night so that the stitches can return to their basic form.

THE KNITKING STITCH/ROW GAUGE and STITCH/ROW CALCULATOR can be used to find the NUMBER OF STITCHES or ROWS TO 1 INCH.

The KNITKING STITCH/ROW GAUGE will give you the NUMBER OF STITCHES or ROWS to 1 inch. After knitting a sample swatch by following our instructions, place the STITCH/ROW GAUGE horizontally with the START LINE on the INSIDE of LEFT stitch mark on sample.

Keep it straight then read the number on the Gauge directly below the inside RIGHT mark on Gauge. This will give you the STITCH GAUGE TO 1 INCH. For instance, if the number is 8, then you have 8 stitches to 1 INCH. To find the ROWS TO 1 INCH, measure from the first row of garment yarn, VERTICALLY to the last row. Read the NUMBER from the LOWER EDGE of GAUGE same as you did for stitches and if the number should be 14, you have 14 rows to 1 inch.

The STITCH/ROW CALCULATOR will now give you the number of sts. or rows needed for a specific measurement. Line the ARROW to the number 8 (8 sts. to 1 inch) and should you need 20 inches of stitches, find the number 20 below and right above the 20 the Calculator shows 160 sts. It works the same way for rows using the Row Gauge.

12 ROWS		12 ROWS
60 ROWS	10 ● 40 STS. ● 10 ↑ MARK ↑ MARK	30 ROWS 30 ROWS
12 ROWS	0000 TENSION HOLES	CONTRAST YARN
	60 STS.	6 ROWS 6 ROWS

FINISHING

Gently block all sections—For PULLOVERS, JACKETS and DRESSES: Join the front to back at shoulders and sides. Sew sleeves together and set in. Hem lower edge and sleeve edges if needed. For a double neckband or armhole, band sew 1 edge to inside and 1 to the outside of neck or armhole. For a single ribbed band, sew 1 edge to the outside of neck or armhole edge. For a cardigan or jacket with buttonholes, finish buttonholes and sew on buttons.

PANTS: Join front to back at sides. Sew inside leg seams, then join to center front and back. Make hem at waistline and insert elastic. Hem lower edge of pants' legs.

☐ Needle not used—in out of work position.

3x1

☐

The number in the box is the number of Rows between shapings. The 3 x 1 above the box gives you the sts. and number of times to make the decreases (or increases)—FOR EXAMPLE: 3 x 1 over the box with 4 means—At the given Row number, *decrease 1 st. knit 4 rows* and REPEAT from * to * 2 times more for a total of 3 times in all. All decreasing (or increasing) WITHOUT ROW NUMBER IN BOX must be made on EVERY 2nd ROW.

ABBREVIATIONS

Carr.	Carriage
CO	Cast on
BO	Bind off
Col.	Color
Dec.	Decrease
Inc.	Increase
EON	Every Other Needle
FNR	Full Needle Rib
HP	Holding Position
MB	Main Bed
RB	Ribber Bed
K	Knit
P	Purl
Pat.	Pattern
Ndls.	Needles
St.	Stitch
St. st.	Stockinette Stitch
T	Tension
WP	Working Position
L.C.	Lace Carriage
G.S	Garter Carriage
G.S	Garter Stitch
I.C.	Intarsia Carriage
W.Y.	Waste Yarn
Strd.	Strand

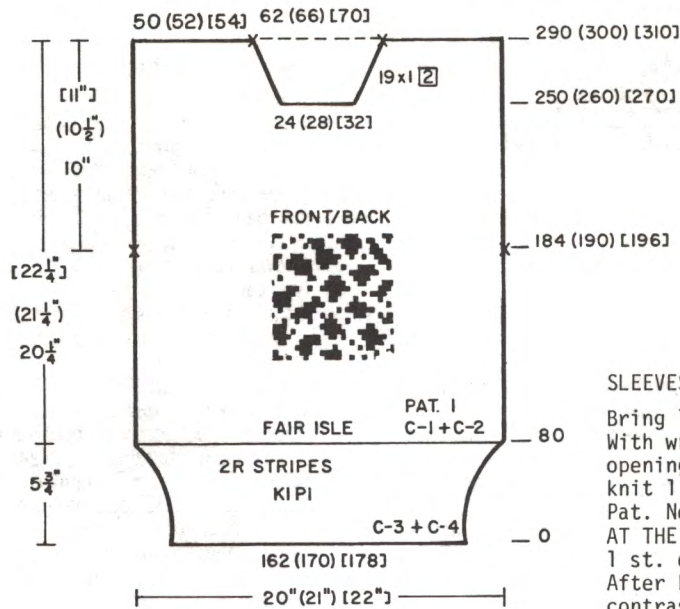

SLEEVES: Close 2nd shoulder.

Bring 168 (176) [184] Ndls. to W.P. With wrong side facing, hang sleeve opening onto these Ndls. With Col. 1 knit 1 row to the left. Set Fair Isle Pat. No. 1. Continue in Pattern and AT THE SAME TIME, ON EACH SIDE, decrease 1 st. every 10th row 10 (11) [12]x. After R 116 (120) [124], remove on contrast W.Y.

TOP FRONT:

K1, P1 Rib: T 1/1 II. With Col. 3, cast on 162 (170) [178] sts. After regular selvedge, change to Col. 4 and knit 2 rows, change to Col. 3 and knit 2 rows. Continue with color stripes of 2 rows each color to R 80.

Transfer Rib sts. to MB. With Col. 1, knit 1 row to the left. Set Fair Isle Pattern No. 1, knit to the right. Continue in Pattern with Col. 1 and 2.

After R 184 (190) [196], MARK EACH SIDE with W.Y. for setting in sleeves. After R 250 (260) [270] bind off the center 24 (28) [32] sts., place the Ndls. on left into HP and complete the right side first.

*ON NECK EDGE, dec. 1 st. EOR 19x. After R 290 (300) [310], bind off or remove remaining sts. on W.Y. Bring the Ndls. on left to W.P. Set THE NDLS. TO CORRECT PATTERN ROW, Turn Row Counter back to 250 (260) [270] and complete the left half. Follow instructions from *.

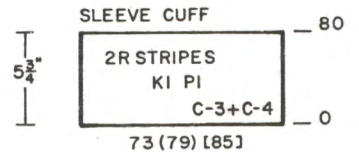
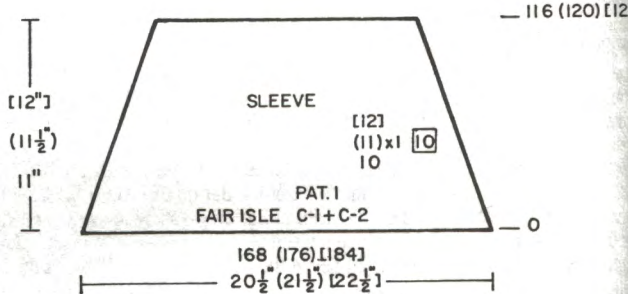

SLEEVE CUFFS: T 1/1 II
K1, P1 Rib: With Col. 3, cast on 73 (79) [85] sts. After regular selvedge. Change to Col. 4, and work the Color stripes same as Waistband. After R 80, transfer Rib sts. to MB. With wrong side facing hang open sts. of sleeve onto these Ndls. Bind off.

BACK:

Work the back the same as front but omit Neck Shaping. After R 290 (300) [310] bind off the center 62 (66) [70] sts. then bind off the shoulder sts. separately or remove them onto W.Y.

NECKBAND: Close 1 shoulder. T 1/1 I

K1, P1 Rib. With Col. 3, cast on 112 (120) [128] sts. After regular selvedge, change to Col. 4, knit 2 rows, Alternate 2 rows Col. 3, 2 rows Col. 4 same as for Waistband. After R 12, transfer Rib sts. to MB. Knit 1 row over all sts. With wrong side facing, pick up sts. around neckline and hang onto Ndls. Bind off.

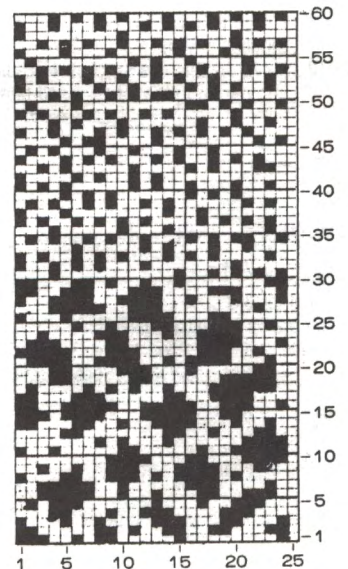

605

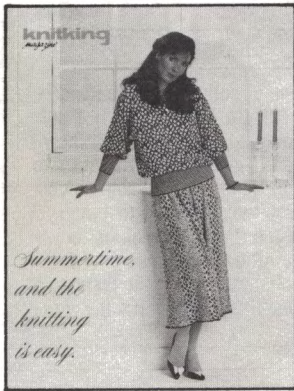

WOMEN'S TWO PIECE DRESS

SIZES: 8/10 (12/14) [16]
YARN: Pearlite = Col. 1 & Col. 2
Venetia = Col. 3 & Col. 4

AMOUNT:
Col. 1 22 23 24 oz.
Col. 2 22 23 24 oz.
Col. 3 4 ounces all sizes
Col. 4 4 ounces all sizes

TENSION: Fair Isle - T4. Ribbing see Instructions.

GAUGE: 16 Sts. 20.5 Rows = 2"

Make on any standard or Electronic Machine with Ribber. Skirt is knitted sideways on the machine for the lower section. A Fair Isle Design with stripes for the ribbed bands.

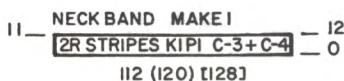

SKIRT:

W.Y. cast on 184 (192) [200] sts.
 After several rows end with 1 row
 Ravel Cord to the right.
 Change to Col. 2. Counter 0. Knit 1
 row to the left. Set Pattern No. 2
 and knit to the right. Continue in
 Fair Isle Pattern with Col. 2 and 1.
 After R 330 (360) [390], mark each
 side with W.Y. for center of skirt.
 After R 660 (720) [780] remove
 the sts. on contrast W.Y.

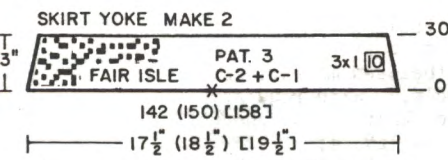

SKIRT YOKE: Make 2.
 Bring 142 (150) [158] Ndl's. to W.P.
 Hang half the skirt onto these Ndl's.
 With Col. 2, knit 1 row to the left.
 Set Pattern No. 3 and knit 1 row to
 the Right. Continue in Fair Isle
 Pattern with Colors 2 and 1 AND
 AT THE SAME TIME, ON EACH SIDE, dec.
 1 st. every 10th row 3x.
 After R 30, remove on contrast W.Y.

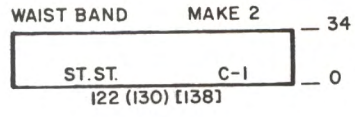
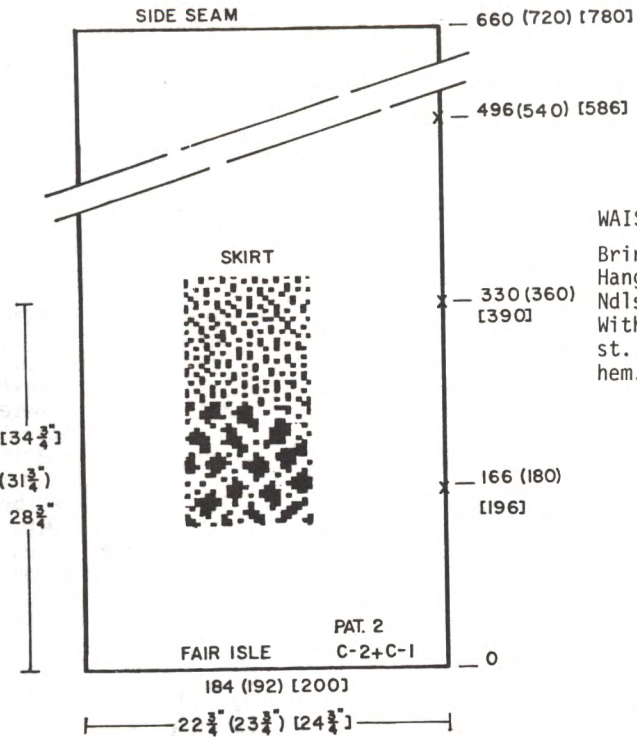

WAISTBAND: Make 2.
 Bring 122 (130) [138] Ndl's. to W.P.
 Hang open sts. of Skirt Yoke onto these
 Ndl's, decreasing evenly across.
 With Col. 2, work 34 rows Stockinette
 st. Pick up first row of band to form
 hem. Bind off.

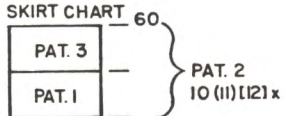

FINISHING:
 See General Instructions.
 Weave the open sts. of Skirt
 together.

606



WOMENS SKIRT AND JACKET
 SIZES: 8/10 (12/14) [16]
 YARN: Fiorina (Egyptian Cotton)
 AMOUNT: 39 40 41 oz.
 TENSION: 4 for Garter Carriage
 Ribbing - See Instructions.
 GAUGE: 17 sts. 23 Rows = 2"
 Make on the COMPUKNIT III machine
 with Garter Carriage.

NOTE: Enter Pattern using 'INPUT'.
 Record the 900 Number machine gives
 you. The Pattern is 92 stitches,
 16 rows. Begin to 'INPUT' Pattern
 from lower LEFT HAND CORNER of
 drawing.

BACK:
 K2,P1 Rib: Cast on 164(174)[184] Sts.
 Program Pat 533 from Pattern Book.
 T3 on Garter Carr. Knit 24 Rows.
 Press Selector 2, Press Step, Press CE
 Enter YOUR 900 Pat. Number.
 Press Step Enter 2. Press Step,
 Press Step. Enter 0. Press Step.
 Green Ready Lamp Lights. Press
 Variation Key #2.
 Change to G.C. T4 and Knit in
 Pattern to R 188 (192)[196].
 With W.Y. mark each side for sleeve
 opening. Continue in Pattern.
 After R 274 (284) [294], bind off
 the center 26 (30) [34] sts. With
 a Ravel Cord, knit the remaining sts.
 on the LEFT back to 'A' (out of
 work) position.
 PRESS 'M' Key (records data in
 window). Complete the right side
 first.
 *ON NECK EDGE, bind off 5 sts. 1x,
 3 sts. 1x, 1 st. 1x.
 After R 282 (292) [302] bind off or
 remove on W.Y. the remaining sts.
 Bring sts. on left back to working
 position. PRESS 'M' and check to
 see if information in window coin-
 cides with information you re-
 corded at R 274 (284) [294].
 Complete the left half, following
 instructions from *.

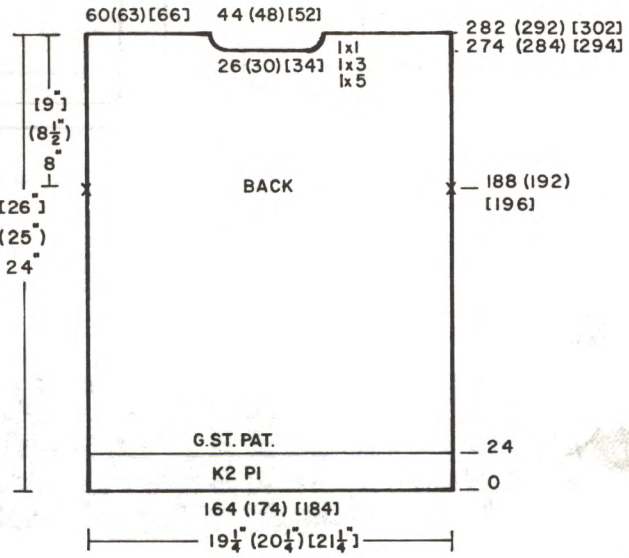
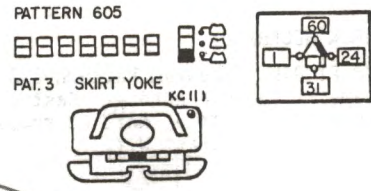
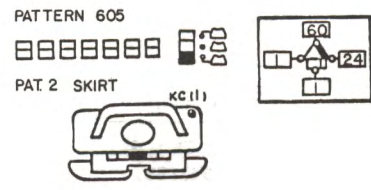
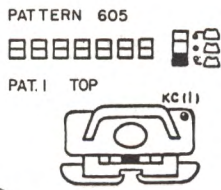

CONTINUED NEXT PAGE

FRONT: Make 1 reverse 1.

K2, P1 Rib: Cast on to the RIGHT OF 0 - 82 (87) [91] sts. Program PAT. 533 and knit Ribbing same as Back. After R 24, END PAT. 533 and enter YOUR 900 number Pattern same as for the back. Knit in Pattern to R 164 (170) [176].

SHAPE NECK: ON NECK EDGE, decrease 1 st. every 5th row 22 (24) [25]x BUT AT THE SAME TIME, after R 188 (192) [196] Mark with W.Y. for Sleeve opening. After R 282 (292) [302] bind off or remove on W.Y. WORK SECOND SECTION THE SAME EXCEPT CAST ON TO THE LEFT OF 0.

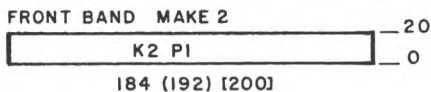

FRONT BANDS: Make 2.

K2, P1 Rib: Program Pat. 533 from Book Tension 3.2 on Garter Carriage. Cast on 184 (192) [200] sts. Knit 20 rows. Remove on contrast W.Y.

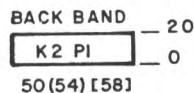

BACK NECKBAND:

K2 P1 Rib: Program Pattern 533 same as you did before. Cast on 50 (54) [58] sts. Knit 20 rows. Remove on contrast W.Y.

BACK BANDS:

CLOSE BOTH SHOULDERS OF JACKET FIRST.

Bring 50 (54) [58] Ndl. to working position. With RIGHT SIDE FACING, hang the open sts. of BACK NECKBAND onto these Ndl. then with WRONG SIDE FACING, hang Back Neck of Jacket onto these same Ndl. Bind off LOOSELY.

Bring 184 (192) [200] Ndl. to working position. With RIGHT SIDE FACING, hang open sts. of FRONT BAND onto these Ndl., then with WRONG SIDE FACING, hang front edge of Jacket onto the same Ndl. Bind off LOOSELY.

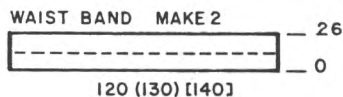
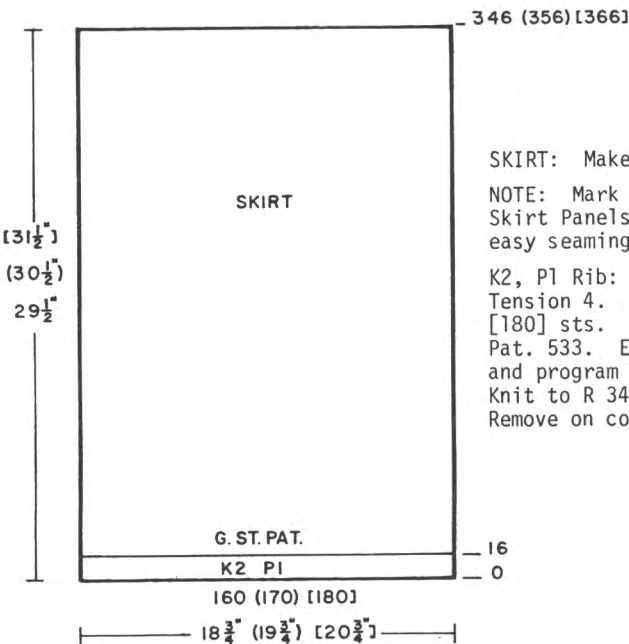
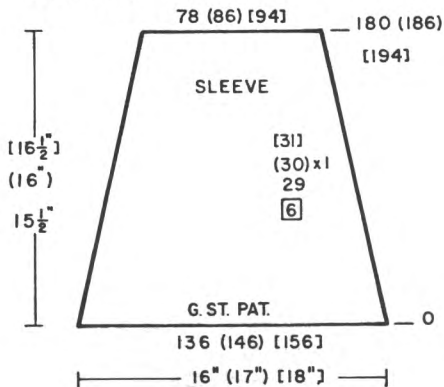
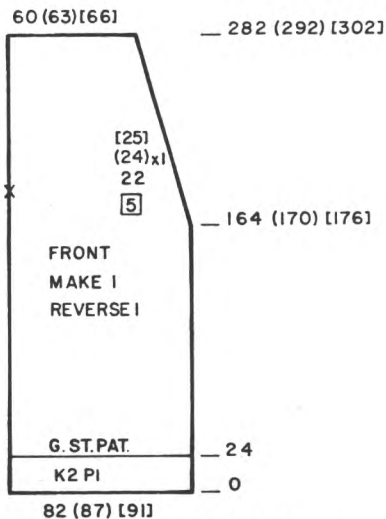

SLEEVES:

Bring 136 (146) [156] Ndl. to Working Position. With WRONG SIDE FACING, hang sleeve opening of Jacket (between markers) onto these Ndl. With regular carriage, knit 1 row from LEFT TO RIGHT WITH TEN. 4.

Set YOUR 900 Pattern number same as before. PRESS VARIATION KEY 2 PLUS VARIATION KEY 5. (Key 5 because we are knitting from the shoulder down and must use the upside down key). Knit in Pattern BUT AT THE SAME TIME, ON EACH SIDE, decrease 1 st. every 6th row 29 (30) [31]x. After R 180 (186) [194] remove on W.Y.

CUFFS:

K2, P1 Rib: Cast on 64 (70) [76] sts. and program Pattern 533 same as before. Tension 3.1. Knit 24 rows. Remove on W.Y. Bring 64 (70) [76] Ndl. to WP. With RIGHT SIDE FACING, hang open sts. of sleeve cuff onto these Ndl. With WRONG SIDE FACING, hang open sts. of Sleeve edge onto these same Ndl., decreasing evenly across. Bind off LOOSELY.

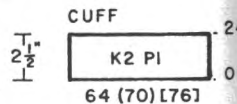

SKIRT: Make 2 sections.

NOTE: Mark each side of Skirt Panels every 100 rows for easy seaming of sections.

K2, P1 Rib: Program Pat 533. Tension 4. Cast on 160 (170) [180] sts. Knit 16 rows. End Pat. 533. Enter YOUR 900 Number and program same as for back. Knit to R 346 (356) [366]. Remove on contrast W.Y.

WAISTBAND: Make 2.

Stockinette stitch with Regular Carriage - Tension 5.2 Bring 120 (130) [140] Ndl. to working position. With WRONG SIDE FACING, hang open sts. of Skirt Back onto these Ndl., decreasing evenly across. Knit 26 rows. Pick up first row to form hem and bind off LOOSELY.

FINISHING:

See General Instructions.

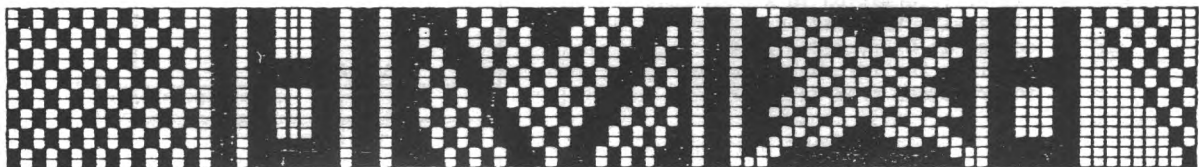

607



WOMENS DRESS

SIZES: 8/10 (12/14) [16]

YARN: Glace = Color 1

2 Strands Sewing Thread = Col.2 used throughout garment.

AMOUNT: Col.1 2 Cones) for all Col.2 6 Spools) sizes.

THREAD LACE PAT: No. 407 T-4

1 x 1 Rib. PAT: No. 532 T-1.2

2 x 1 Rib. PAT: No. 533 T-3.1

GAUGE: 17 sts. 23 Rows = 2"

Made on the COMPUKNIT III (KH 930) machine in THREAD LACE. Use GARTER CARRIAGE for Ribbing.

SKIRT: Make 2

TENSION 3.1 GARTER CARRIAGE

2 x 1 Rib. Pat. 533. WITH COL. 1

AND 2 TOGETHER, cast on

184 (192) [200] sts. Set G.C.

for 12 rows. After R 12, remove

G.C. and replace with Std. Carr.

Knit 1 row to the LEFT. (Carr. outside

Sensor). Program Pat. 407.

Knit 1 row to the right to select

Ndls. REMOVE COL. 2 (2 strnds.

sewing thread) from Feeder A

and place in Feeder B. Continue

in THREAD LACE.

After R 304 (314) [324], remove

on W.Y.

BODICE FRONT & BACK - The Same

Bring 158 (164) [170] Ndls. to Work-

ing position. Hang open sts. from

Skirt Waist onto these Ndls. de-

creasing evenly across. Counter 0.

With Col. 1 and 2, knit 1 row

LEFT TO RIGHT. Remove Std. Carr.

Replace with G.C. Program Pat.

532 (1 x 1 Rib) Tension 1.2.

Knit 22 rows.

Make EYELETS ACROSS (Transfer

approx. every 6th st. to adjacent

Ndl. (for FRONT SECTION, leave

double spacing in the center).

Continue 1 x 1 Rib to Row 44.

Remove G.C. and replace with Std.

Carr. Knit 1 row to the LEFT.

PROGRAM PAT. 407 - T-4.

Knit to the RIGHT to SELECT NDLS.

Continue in THREAD LACE same as

before BUT AT THE SAME TIME, ON

EACH SIDE, Inc. 1 st. every 30

rows 3x.

After R 128 (134) [140] ON EACH

SIDE, Inc. 1 st. EVERY ROW 12x.

After R 216 (226) [236] BEGIN NECK SHAPING: Bring the center 86 (90) [94] Ndls. plus all Ndls. to the left of these into HP and complete the right side first. PRESS M BUTTON.

*Knit in Pat. to R 228 (238)

[248] Remove on W.Y.

ON THE LEFT SIDE, bring back

to W.P. 51 (52) [53] Ndls.

CARR. ON THE LEFT SIDE BEYOND

THE TURN MARK. Leave the Neck

sts. in HP. Be sure the sts.

are in the HOOKS of Ndls.

PRESS M Button and push in BOTH

PART BUTTONS. Without yarn go

across to the right to select

Ndls. Counter 216 (226) [236]

Continue from * then remove

on W.Y.

Place the center 86 (90) [94]

Ndls. to working position, sts.

in the HOOKS of Ndls.

PROGRAM PAT. 533 (2 x 1 Rib)

and replace Carr with G.C.

and knit 12 rows. Bind off.

CORD: For Belt - T-1

Bring 6 Ndls. to working position.

'e' cast on. Set Carriage for

Tube knitting (Push in 1 Part

Button). Knit approx. 80" or

to your size.

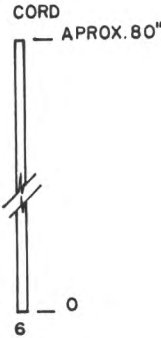

SLEEVE BAND MAKE 2
K2 P1 G ST. PAT. 12
128 (134) [140] 0

SLEEVE BANDS: T3.1

JOIN BOTH SHOULDERS.

Program Pat. 533. Use G.C. Cast on 128 (134) [140] sts. Knit 12 rows. Remove on W.Y. Turn Rib. over (so right side is facing and rehang on machine. With wrong side facing, hang sleeve edge onto these Ndls. Bind off loosely. Repeat for other sleeve.

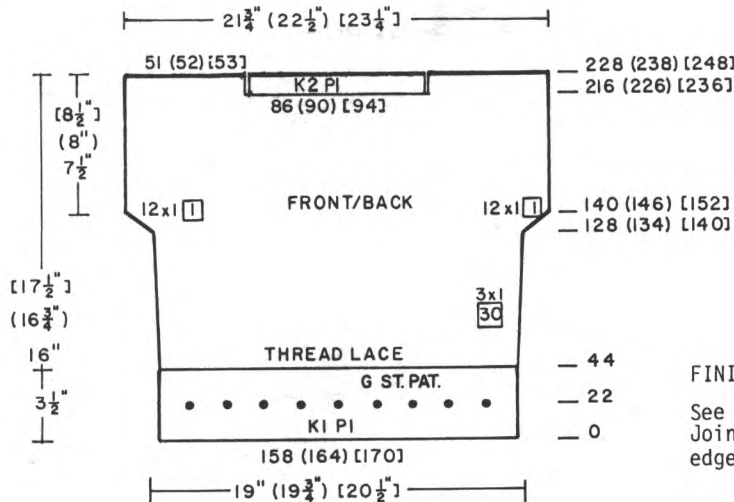
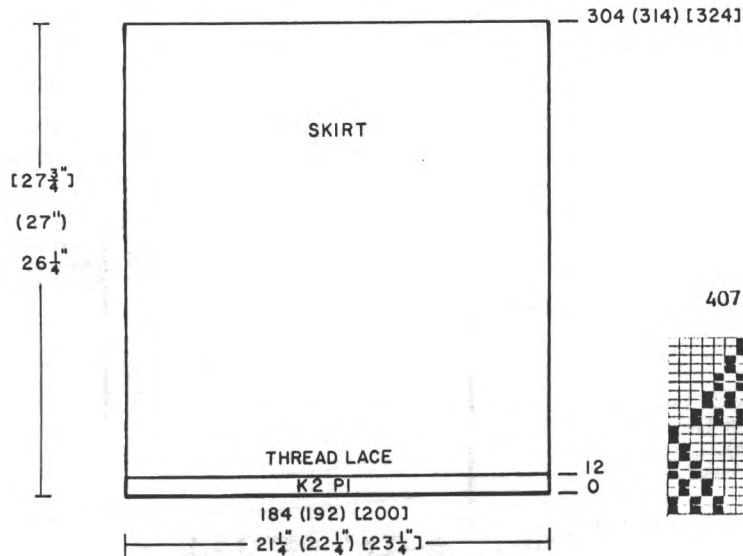

FINISHING:

See General Instructions. Join Ribbing at neck to side edge.

608



WOMENS 3-PIECE SUIT

SIZES: 8/10 (12/14)

YARN: Pearlite

AMOUNT:

Col. 1 38 oz. 39 oz.

Col. 2 38 oz. 39 oz.

TENSION Fair Isle T 8

St. st. T 8

Rib. See Instructions.

GAUGE: Fair Isle 13 sts. 19 rows = 2"

St. st. 13 sts. 19.5 rows = 2"

Make on any Standard Punch Card or Electronic machine with Ribber. Blouse & Jacket knitted sideways.

SKIRT: Make 2 Panels the same.

Use 2 strands Pearlite together throughout. Stockinette stitch. Automatic cast on over every other needle or waste yarn cast on (for hem) 130 (138) sts. Knit 24 rows then pick up first row to form hem.

Knit 2 rows and SET CARR. FOR SHORT ROW KNITTING.

ON OPPOSITE SIDE OF CARR, bring to HP 40 Ndl. before knitting the next 2 rows.

ON OPP. SIDE OF CARR. push back to WP 10 sts. 4x ON EACH SIDE. Knit to R 232 (242).

ON EACH SIDE, decrease 1 st. every 10th row 4x.

After R 272 (282), remove on W.Y.

SKIRT WAISTBAND: Make 2.

Bring 122 (130) Ndl. to W.P. WITH WRONG SIDE FACING, hang the open sts. of Skirt onto these Ndl. decreasing evenly across. With 1 strand Col. 1 and Tension 4 knit 36 rows. Pick up first row to form hem and bind off loosely. REPEAT for 2nd half of skirt.

SKIRT WAIST BAND MAKE 2

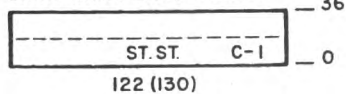

JACKET BACK: 2 strands Pearlite together throughout.
NOTE: ONE SIZE FITS ALL.

TO THE RIGHT OF 0, W.Y. cast on 65 sts. After several rows end with 1 row Ravel Cord to the right. Counter 0. Change to Col. 1, knit 1 row to the left. Set Pattern and knit to the right to select Ndl. Continue in Fair Isle Pattern with Col. 1 and 2.

ON THE LEFT SIDE, increase 1 st. every 5th row 20x, 1 st. EOR 5x. After R 12, change to St. st. and with Col. 2 knit 12 rows. Continue to FOLLOW COLOR CHART (12 rows Fair Isle, 12 rows St. st) throughout.

After R 112 ON THE LEFT SIDE, cast on 80 sts. After R 180, mark with W.Y. for neck opening. After R 222, mark for center of garment. After R 264, mark for neck opening.

After R 333 ON THE LEFT SIDE, bind off 80 sts. ON THE LEFT decrease 1 st. EOR 5x, 1 st. every 5th row 20x.

After R 444, remove on W.Y.

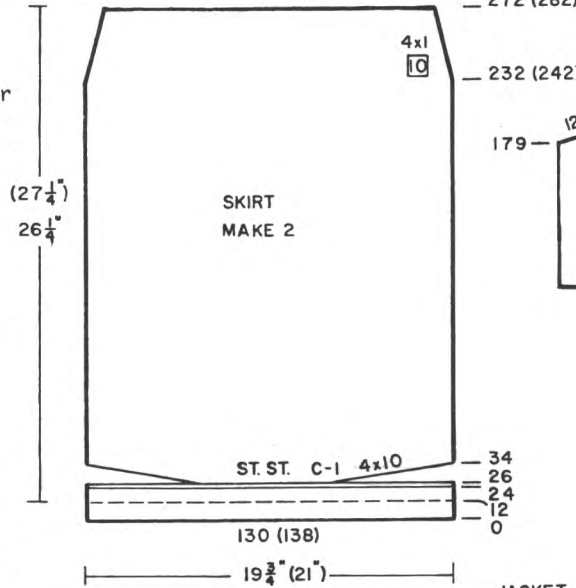
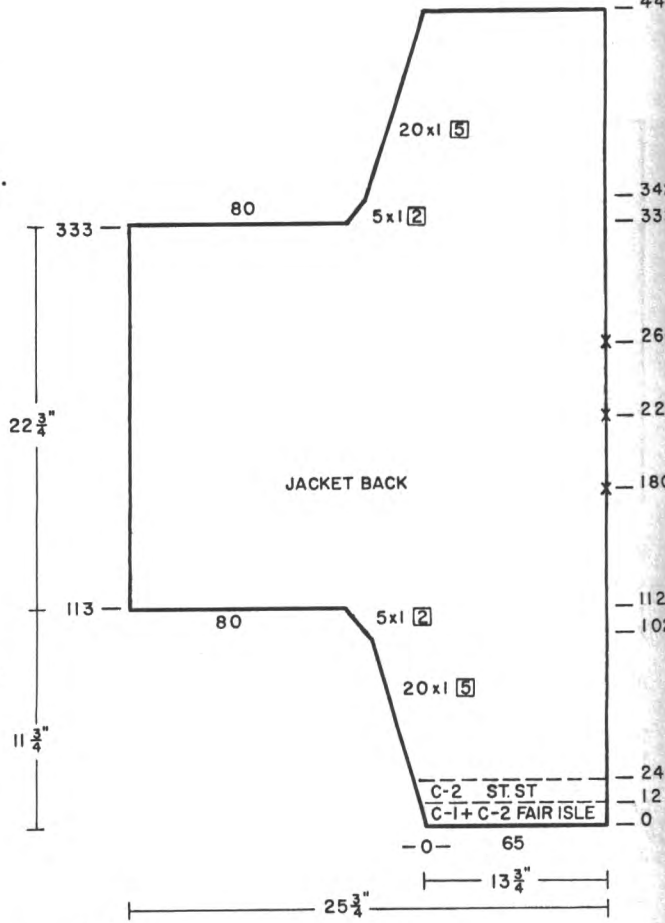

COLOR CHART FOR JACKET

St. st.

C-2	12R
-----	-----

FI

C-1 + C-2	12R
-----------	-----

JACKET BANDS: Make 2, 1 strd. Pearlite Col. 2

K1, P1 Rib: T 0/0 II. Cast on 159 sts. Knit 80 rows. Transfer Rib sts. to MB. Knit 1 row. Pick up first row to form hem. Remove on W.Y. These bands begin at center of back neck and continue down to decreases on the front. (See (X) on Chart.

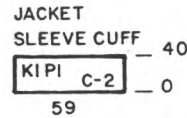

JACKET FRONT: Make 1, reverse 1. Work the same as back to R 179. ON THE LEFT, BO (or use Short Row method) 4 sts. EOR 12x. After R 180, ON THE RIGHT, BO 6 sts. EOR 12x. After R 204, bind off the remaining sts. REVERSE FOR SECOND FRONT SECTION

JACKET SLEEVE CUFFS: T 3/3 I. Use 2 strands Pearlite. CLOSE BOTH SHOULDERS FIRST. K1, P1 Rib: With Col. 2, cast on 59 sts. Knit 40 rows. Transfer Rib sts. to MB. With wrong side facing, hang lower edge of sleeve onto these Ndl. decreasing evenly across. Bind off. REPEAT FOR 2nd SLEEVE.

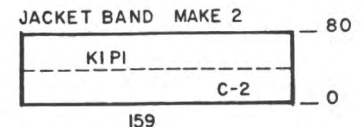

JACKET BANDS: Make 3 T O/O I I
1 strd. Pearlite

K1/P1 Rib: Col. 2. Cast on
199 sts. Knit 80 rows. Transfer
Rib sts. to MB. Pick up first
row to form hem.

One band is for the Back, the
other two are for the front
beginning from side seam to
mark.

Attach all bands by hand.

BLOUSE FRONT: - 2 strds Pearlite

W.Y. cast on 130 (136) sts.
After several rows end with 1 row
Ravel Cord
Change to Col. 2. Counter 0.
Mark for armhole.
Knit 5 (6) rows. *Change to
Col. 1 & Col. 2 and knit 12
rows Fair Isle. Change to Col. 2
and knit 10 (12) rows St. st. *
Continue following Color Chart
for changes in color and knit
from * to *.
After R 68 (76), ON NECK EDGE,
bind off 41 (45) sts. 1x, 1 st.
EOR 5x. After R 100 (109)
mark with WY for center of
garment. After R 122 (132) on
Neck edge, cast on 1 st. EOR 5x,
41 (45) sts. 1x. Continue in
Pat. After R 200 (218), mark
for armhole and remove on W.Y.

BLOUSE BACK:

Work the same as front but OMIT
NECK SHAPING.

BLOUSE NECKBAND: 2 Strds. Pearlite

CLOSE ONE SHOULDER FIRST.
K1, P1 Rib: T 3/3 I. With
Col. 2 cast on 189 (199) sts.
Knit 10 rows. Transfer Rib
sts. to MB. Knit one
row over all sts.. Starting
at shoulder and with wrong side
facing, hang neck edge onto
these Ndl. Bind off.
CLOSE SECOND SHOULDER.

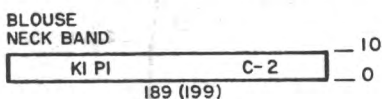
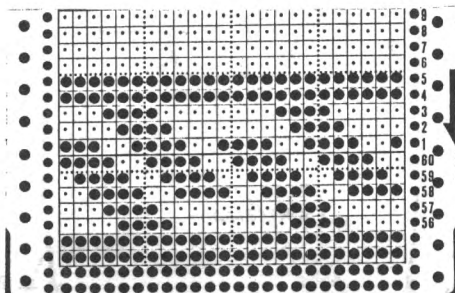
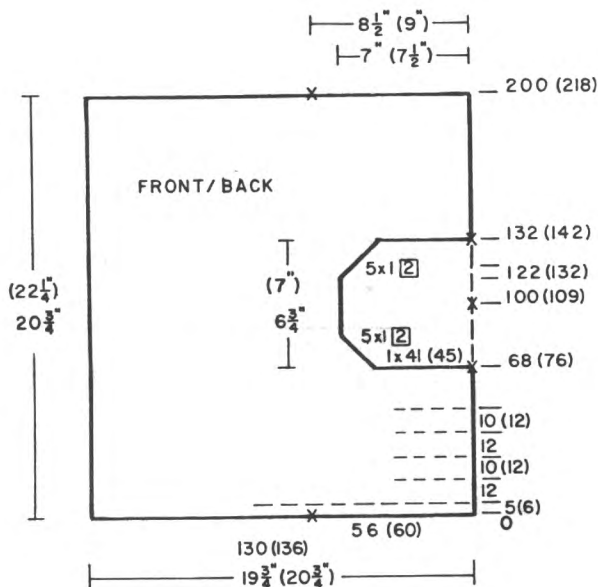
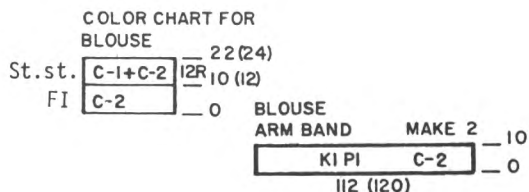
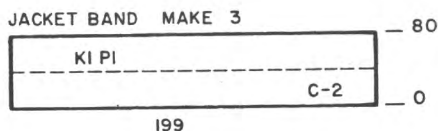

BLOUSE ARM BANDS: MAKE 2, 2 Strds.
Pearlite.

K1, P1 Rib. T 3/3 I. With
Col. 2, cast on 112 (120) sts.
Knit 10 rows. Transfer Rib
sts. to MB. With wrong side
facing, hang Armhole from marker
to marker onto these Ndl. Bind off.

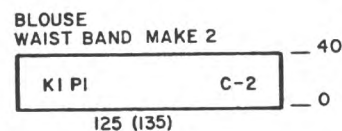

BLOUSE WAISTBAND: Make 2, 2 Strds.
Pearlite

K1, P1 Rib: T 3/3 I. With
Col. 2, cast on 125 (135) sts.
Knit 40 rows. Transfer Rib
sts. to MB. With wrong side
facing, hang lower edge of
front onto these Ndl. Bind off.

FINISHING:

See General Instructions.



September 14 through 19

Join us! Our open house runs from September 14
through 19 and will be held at KNITKING, 1128
Crenshaw Blvd, Los Angeles, Calif. 90019.

Come and meet our experts along with many
acknowledged guest authorities. You'll get to see great
new products too!

Enjoy! You'll love our daily Fashion Show and Contest!
Daily winners will receive prizes and are eligible for the
finals and a GRAND PRIZE at the close of the seminar.

SEMINAR & OPEN HOUSE

knitking

Among the teachers in attendance: Yukiko Mitumata, Mary Louise Norman, Dan Jenkins, Mary Nishisaki, Eva Eisenstein, Mike Armstrong, Mitsi Tani, Jessica Madera, Ruth Williams, Jan and Jean, the twins from San Diego, plus all the resident experts at KNITKING.

1987

Win! All types of garments are eligible, so start knitting now! (Sorry, knitting machine dealers and employees of KNITKING not eligible)

It's Free! Just bring yourself and some friends and join us for prizes, events, and free coffee and doughnuts.

Our regular seminar visitors will tell you ours is the best, so remember to come and meet us here

609



WOMENS DRESS & JACKET

SIZES: 8/10 (12/14) [16]
 YARN: Pearlite & Monofil or Elastic.

AMOUNT:

Col. 1 48 49 50 oz.
 Col. 2 18 19 20 oz.

Monofil or Elastic - 1 Spool
 all sizes.

TENSION: Fair Isle 8, St. st. 8,
 Rib. 3/3 I use 1 strd
 Monofil in all RIBBING

GAUGE: Fair Isle - 14.5 Sts. 18 R=2
 St. st., 13 sts. 17.5 Rows. = 2"

Make on any Electronic machine or substitute any suitable Punch Card for Std. Punch Card machines. Bands are K1, P1 Ribbing.

DRESS FRONT: 2 strds Pearlite knitted together.

With Col. 1, cast on 132 (138) [144] sts. (or you can use cast on comb hem method).
 Knit 24 rows. Pick up first row to form hem.

Knit 2 rows then work SHORT ROWS. ON OPPOSITE SIDE OF CARR, bring to HP 40 sts. before knitting the next two rows.

ON OPPOSITE SIDE OF CARR, push back to WP 10 sts. 4x ON EACH SIDE. Always be sure to wrap inside Ndl. when knitting short rows to prevent holes. Continue in St. st.

After R 216 (220) [224], ON EACH SIDE, dec. 1 st. every 10th row 4x. After R 256 (260) [264], ON EACH SIDE, inc. 1 st. every 10th row 4x. After R 312 (316) [320], MARK EACH SIDE FOR ARMHOLE.

After R 366 (370) [374], bind off the center 32 (34) [36] sts., put the Ndl. on the left into HP and complete the right side first.

*ON NECK SIDE, decrease 1 st. EOR 8x. After R 382 (390) [398], bind off.

Bring the Ndl. on the left to W.P. Turn Row Counter back to 366 (370) [374] and complete the left half. Follow instructions from *.

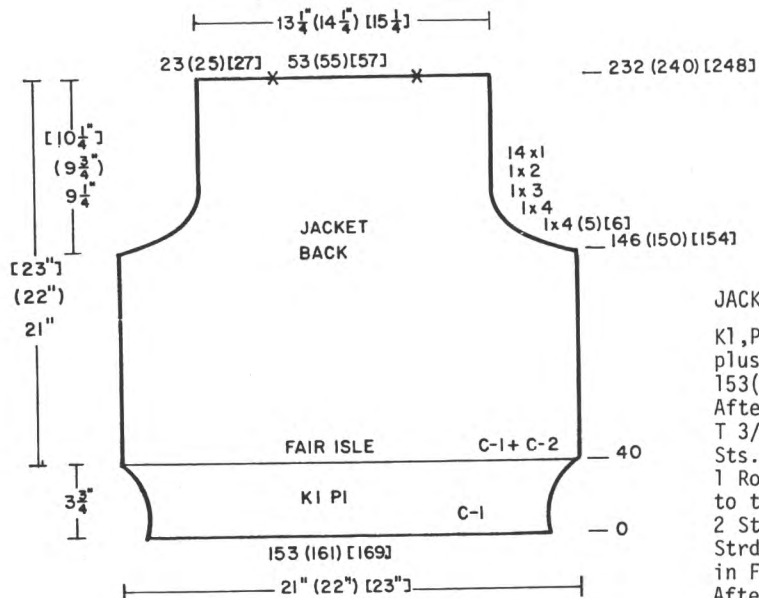

JACKET BACK:

K1, P1 Rib: With Col. 1 (2 Strds. plus 1 Strd. Monofil. Cast on 153 (161) [169] Sts. After Regular selvedge, change to T 3/3 I. Knit 40 Rows. Transfer R Sts. to MB. Remove Monofil and Knit 1 Row to the Left. Set KC. Knit to the Right to select Ndl. With 2 Strds. Col. 1 in Feeder A and 2 Strds. Col. 2 in Feeder B Continue in Fair Isle Pattern. After R 146 (150) [154] Shape Armhole. ON EACH SIDE, BO 4 (5) [6] Sts. 1x, 4 Sts. 1x, 3 Sts. 1x, 2 Sts. 1x, 1 St. 14x. After R 232 (240) [248] Mark for neck opening then remove on W.Y.

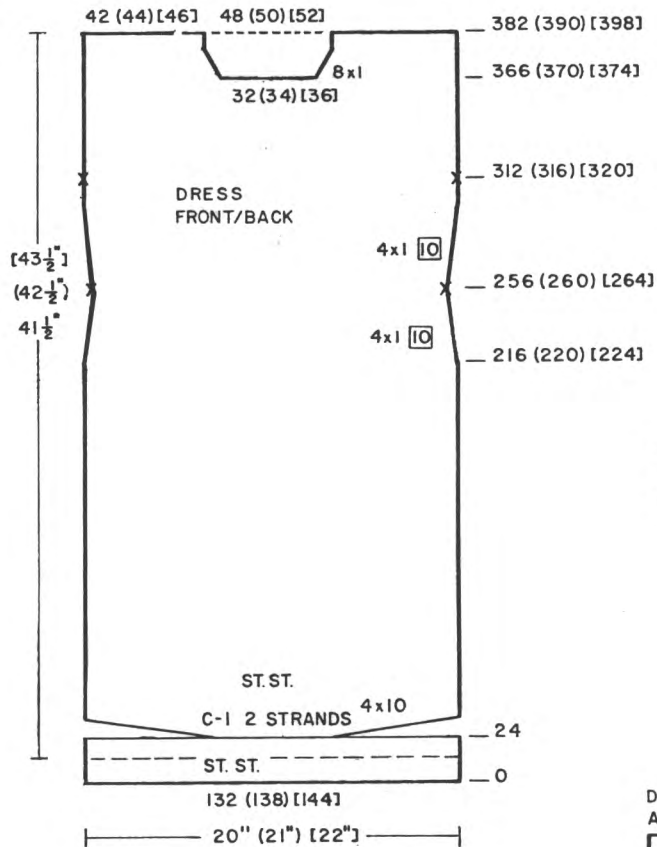

DRESS NECKBAND: Make 1, Col

K1, P1 Rib. With Col. 1, cast on 153 (161) [169] sts. After Selvedge, knit 10 rows Transfer Rib sts. to MB. Knit 1 row. Remove on W.Y.

DRESS NECKBAND MAKE 1

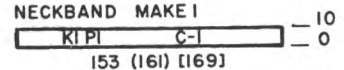

DRESS ARM BAND MAKE 2

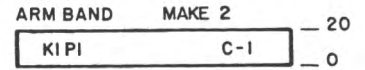

143 (151) [157]

DRESS BACK:

Work the back the same as the front to R 382 (390) [398]. Mark each side for neck opening then remove on W.Y.

DRESS ARMBANDS: Make 2.

K1, P1 Rib: With Col. 1 cast on 143 (151) [157] sts. With T 3/3 I, knit 20 rows. Transfer Rib sts. to MB, knit 1 row then remove on W.Y.

JACKET FRONT: Make 1 Reverse 1

K1, P1 Rib. Col. 1 (2 Strds. plus 1 Strd. Monofil.) Cast on 77(81)[85] Sts. After Regular selvedge Knit 40 Rows. Transfer Rib Sts. to MB. Remove Monofil. Knit 1 row to the left and Set Pattern same as Back. Continue with Col. 1 and 2. After R 124(128)[132] ON NECK EDGE, Dec. 1 St. every 4th row 27(28)[29]x. BUT AT THE SAME TIME, after R146(150)[154] SHAPE ARMHOLE SAME AS the BACK. After R 232(240)[248] remove on W.Y.

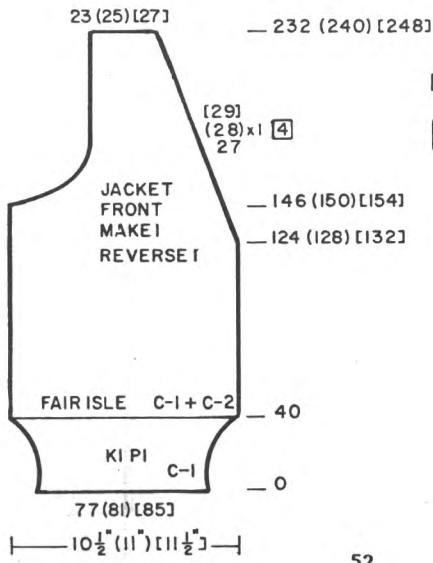

JACKET NECKBAND: Make 2 (2 strds. tog.)

K1, P1 Rib: Col. 1. T 3/3 I. Cast on 193 (199) [199] sts. After reg. selvedge, knit 20 rows. Tran. Rib. sts. to MB. Knit 1 row then remove on W.Y.

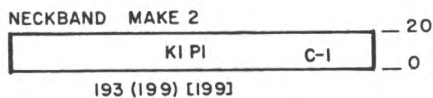

JACKET NECKBAND INSERT (FOR LARGE SIZE ONLY)

For the Large size, you will need to knit the Neckband PLUS this insert. Use same yarn and Tension given for the NECKBAND PAT.

K1, P1 Rib: Cast on 13 sts. After regular selvedge, knit 20 rows. Transfer Rib sts. to MB, knit 1 row then remove on W.Y.

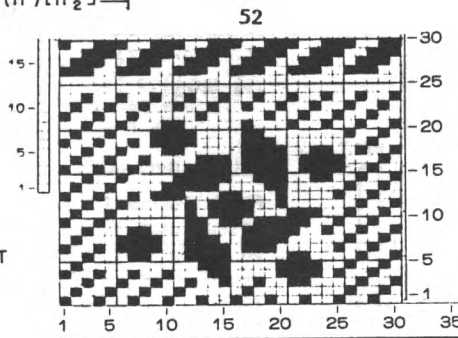
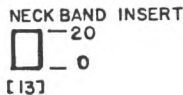

JACKET SLEEVES: (2 strds. Col. 1 2 strds. Col. 2

W.Y. cast on 108 (114) [120] sts. After several rows, end with 1 row Ravel Cord to the LEFT. Change to garment yarn and set Fair Isle Pat.. ON EACH SIDE, inc. 1 st. every 10th row 8x. After R 80 (84) [88], SHAPE CAP: ON EACH SIDE, follow the bind-offs FOR YOUR SIZE as shown on the Chart. After R 166 (174) [182], bind off the remaining sts.

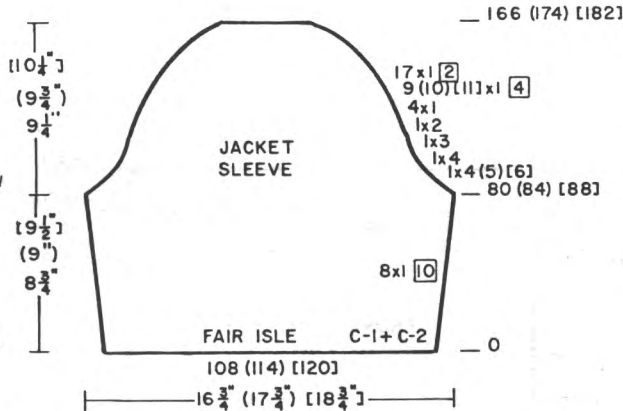

JACKET SLEEVE CUFFS: (Strds. Col.1 plus 1 Strd. Monofil.) T 3/3 I

K1, P1 Rib: Cast on 55 (59) [63] sts. After regular selvedge, knit 40 rows. Transfer rib sts. to MB and with wrong side facing, hang open sts. of sleeve edge onto these Ndls. decreasing evenly across. Bind off.

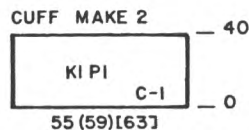

FINISHING:

See General Instructions. For the LARGE SIZE, sew Neckband insert in at center of neckband.

fashion

The leading knitting publication from England, it contains 36 complete and outstanding patterns for women, men and children. Illustrated in **full color**. **VOLUME 9** has a marvelous assortment of sweaters designed to please and satisfy every taste.

VOLUME 10 displays, in knit dresses, sweaters and childrens clothes, the astonishing versatility of modern knitting machines.

Garments are knitted with **PUNCH CARD, ELECTRONIC** and **BULKY** machines. At **\$6.95 postpaid** anywhere in the world, it's definitely a **'BEST BUY'**.

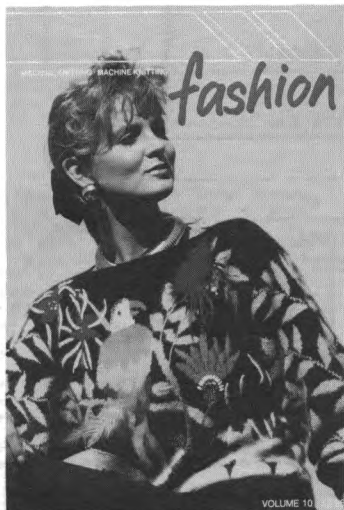

610



WOMENS TWO-PIECE DRESS

SIZES: 8/10 (12/14) [16]

YARN: Venetia = Col. 1

Sewing Thread = Col. 2

AMOUNT:

Col. 1 24 26 28 oz.
Col. 2 2 2 4 spools

TENSION: Thread Lace T 5
Stockinette st. T 3

GAUGE: 15.5 sts. 22.5 rows = 2"

Made on the COMPUKNIT III machine using Thread Lace Pat. 396 from Pattern Book. The Skirt is Stockinette st.

TOP: Make 2.

With W.Y. cast on 164 (172) [180] sts. After several rows end with 1 row Ravel Cord to the right. Counter 0. Change to Col. 1 and with T 10, knit 1 row. Continue in Stockinette st. with T 3. After R 34, change to T 4 and continue in St. st. After R 65, knit 1 row to the right with T 10. Pick up first row to form hem. With T 5, knit 1 row to the left. Program Pat. No. 396. Knit 1 row to the right to select Ndl.

USING 2 STRANDS OF SEWING THREAD THROUGHOUT, continue in Thread Lace Pattern..

After Row 238(244)[250] Mark Each side for Sleeve opening. After Row 302(314)[326] Knit 1 row to the left. Change to Tension 10 and Knit 1 row to the right. Change to T4 and continue in St. st. After Row 334(346)[358] Program Pat 103 from Pat. Book. Move lace carriage across needle bed 2x. (This forms Picot for Hem.) End Pat. 103 Change to T3 and continue in St.st. After Row 368(380)[392] pick up loose row to form hem. Bind off LOOSELY.

SLEEVE BANDS: Make 2

With Col. 1, cast on 122 (130) [138] sts. With T 4, knit 18 rows St. st. Pick up first row to form hem. Knit 1 row. With WRONG SIDE FACING, hang front and back armhole opening from mark to mark onto these Ndl. Bind off loosely.

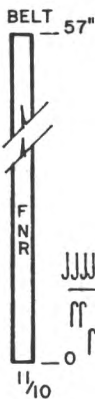
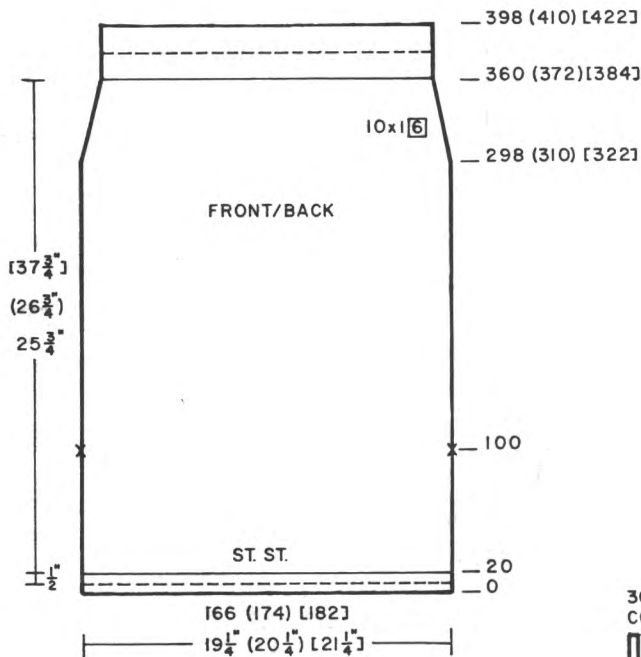

BELT: Optional

FNR: Follow Chart for Needle selection. Pitch on H. Cast on 11/10 Sts. Knit approximately 57 inches of rows or as long as you wish.

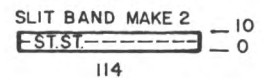
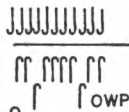

CORD For Lacing Front/Back together
SET YOUR MACHINE FOR KNITTING A CORD. Cast on 3 sts. and with T 1 knit approximately 36". Bind off. Make another the same.

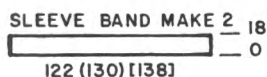
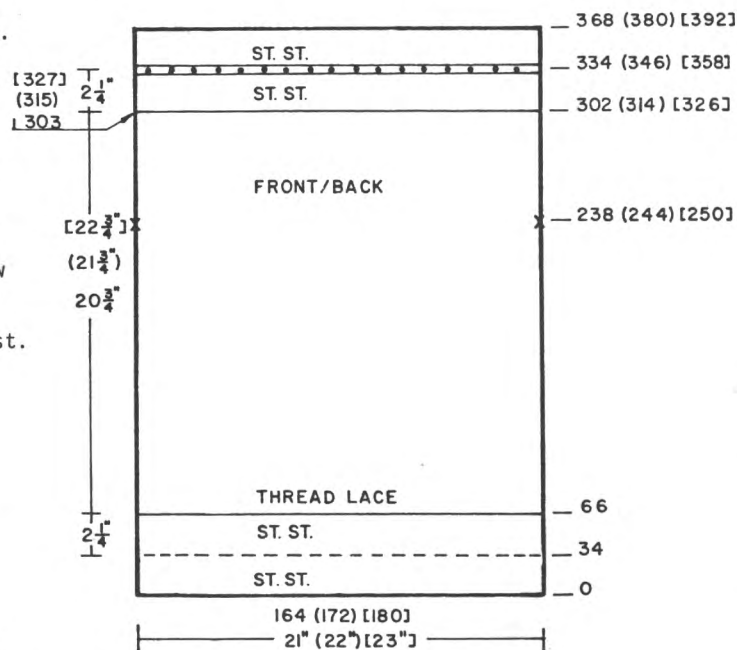

SKIRT: Make 2 sections the same 'e' cast on with color 1, 166 (174) [182] sts. With T 2, knit 20 rows St. st. Pick up first row to form hem. Continue in St. st. with T 3. After R 100, mark each side with W.Y. for Slit opening. After R 298 (310) [322], ON EACH SIDE, decrease 1 st. every 6th row 10x. After R 360 (372) [384] knit 1 row T 10 then change to T 3. After R 398 (410) [422] pick up loose row to form hem. Knit 1 row T 10. Bind off LOOSELY.

BAND FOR SIDE SLIT:

Close 1 side seam down to W.Y. marker. Bring 114 Ndl to WP. With WRONG SIDE FACING, hang side slit opening onto these Ndl. being sure to include lower hem. With T 2.2, knit 10 rows St. st. Pick up first row to form hem and bind off.

396

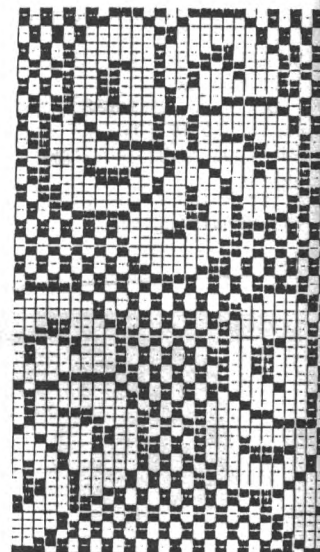

FINISHING:

See General Instructions. Weave the cords through the eyelets alternating from front to back for approximately 5" ON EACH SHOULDER.

611



WOMENS WOVEN JACKET

SIZES: 8/10 (12/14) [16]
YARN: Papillon - Col. 1
 Glace = Col. 2
AMOUNT: Col. 1 - 2 Cones all sizes
 Col. 2 - 1 Cone all sizes
TENSION: Weaving - T5
GAUGE: 12.5 Sts. 20 Rows. =2"

Make on any Standard Punch Card or Electronic machine in a Weaving Pattern. No. 444 in Book.

BACK:

Bring 134 (140) [146] Ndl. to WP. Using Latch Tool and Papillon, begin at left side of Needle Bed and cast on using the Crochet method. Repeat the cast on a total of 5 rows. Yarn and Carriage on the right. With Papillon, manually knit 1 row across - Push needle back 1/2 way between position 'B' and position 'A'. Break Papillon yarn. Place Carriage on the left side. Thread with Glace yarn and knit 1 row to the right to select Ndl. Counter 0. Begin Weaving Pattern. After R 158 (164) [170], SHAPE ARMHOLE: ON EACH SIDE, BO 4 (5) [6] sts. 1x, 3 Sts. 5x. After R 238 (248) [258] SHAPE NECK: Bind off center 34 (38) [42] sts. Place sts. on left to HP and complete right side first. *ON NECK EDGE, BO 1 st. EOR 3x. After R 246 (256) [266] bind off or remove on WY. the remaining sts. Bring sts. on the left back to WP. Turn Counter back to 238 (248) [258] Set Pattern and complete the left half. Follow instructions from *.

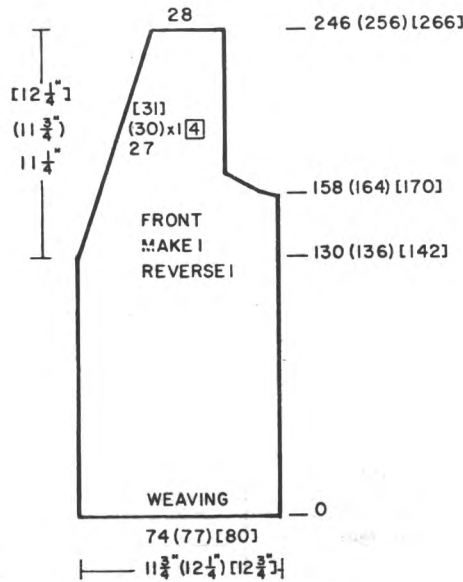

FRONT: Make 1, reverse 1.
 Bring 74 (77) [80] Ndl. to WP. Cast on with Papillon same as the back. Counter 0. Set Weaving Pat. and with Glace, knit 1 row to the right to select Ndl. After R 130 (136) [142] on the LEFT BO 1 st. every 4th row 27 (30) [31]x BUT AT THE SAME TIME, after R 158 (164) [170], SHAPE ARMHOLE SAME AS BACK. After R 246 (256) [266], remove on W.Y. Work second half with reverse shaping.

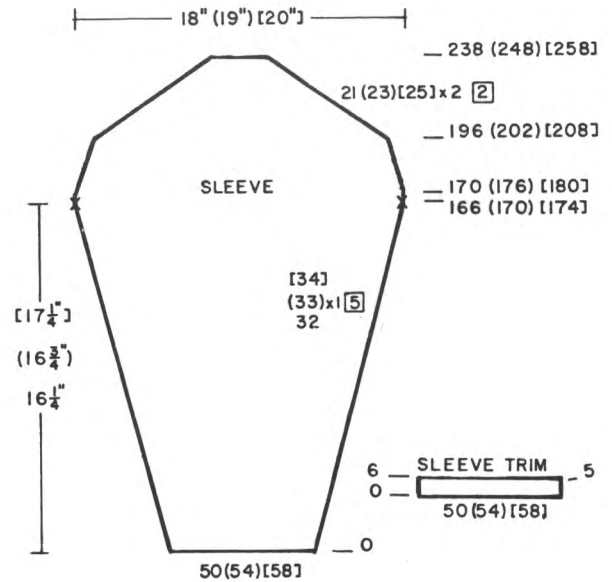
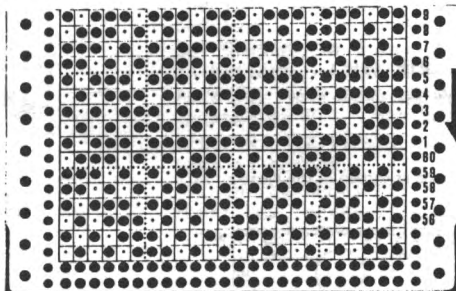
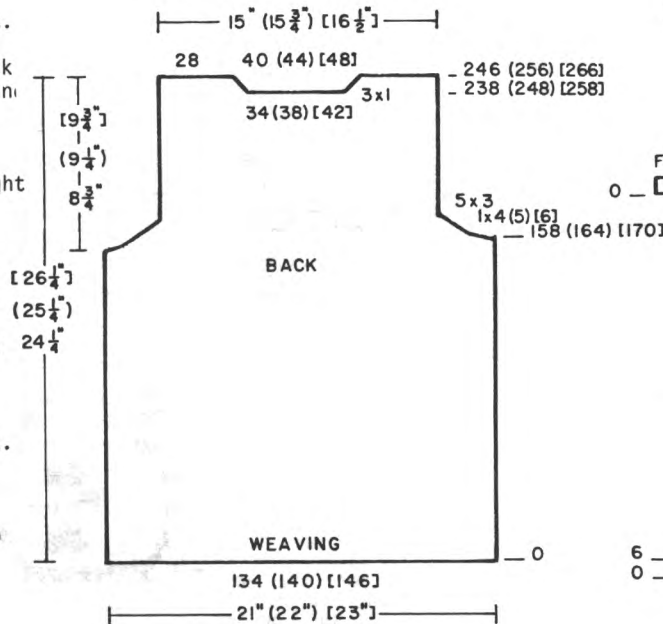

SLEEVES:

Bring 50 (54) [58] Ndl. to WP. With Papillon cast on same as back. Counter 0. Set Weaving pattern and continue same as before. ON EACH SIDE, inc. 1 st. every 5th row 32 (33) [34]x. After R 166 (170) [174] ON EACH SIDE mark with W.Y. After R 170 (176) [180], decrease 1 st. every 6th row 5x. After R 196 (202) [208] ON EACH SIDE, bind off 2 sts. EOR 21 (23) [25]x. After R 238 (248) [258], bind off the remaining sts. with Glace.

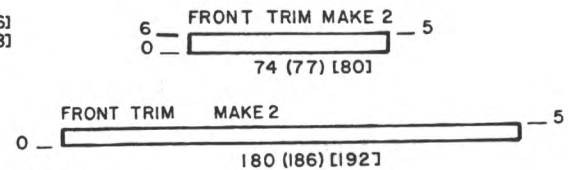

FRONT TRIM: Make 2.

Bring 180 (186) [192] Ndl. to WP. With Papillon make the crochet cast on same as you did before but OMIT THE 6th MANUAL ROW. With WRONG SIDE FACING, hang front edge of Jacket onto these Ndl. With Papillon, MANUALLY KNIT 1 LOOSE ROW, then bind off.

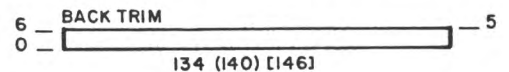

BACK NECK TRIM:

Bring 36 (40) [44] Ndl. to WP. Complete the 5 rows with Papillon same as front Trim. With WRONG SIDE FACING, hang back neck edge onto these Ndl. Manually knit 1 LOOSE row with Papillon and bind off.

FINISHING:

See General Instructions.

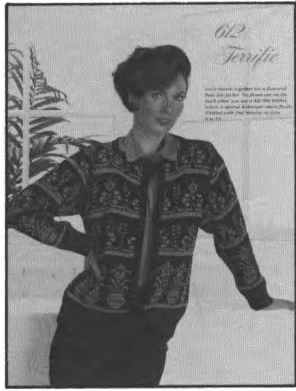

WOMENS MULTI-COLORED JACKET

SIZES: 8/10 (12/14)
YARN: Fine Venetia
 Col. 1 15 16 oz.
 Col. 2 5 5 oz.
 Col. 3 5 5 oz.
 Col. 4 5 5 oz.
TENSION: FNR 4/4 (111) 900 Ribber
 Bands: K1, P1 3/3 I
GAUGE: FNR Pattern: 18.5 sts.
 48 Rows = 2"

Note:
 The number of rows on the row counter is divided between the main bed and the Ribber, but follow the pattern as specified.

Made on Electronic Machine using 900 Ribber and EON selection method for FNR Pattern. Bands are K1, P1 Rib. Front Bands are a Tuck st. Ribber Color Changer is essential. Fair Isle Design has no floats using this method. If you are not familiar with this method, please refer to the Ribber Instruction Manual.

BACK: T 4/4 (111)

FNR: With Col. 1 cast on 189 (199) sts. After selvedge end with Carr. on the LEFT. Program Pat. 1, set KC and continue in Pattern. After R 12 (16), change to Col. 2. After R 16 (20) change to Col. 3. After R 20 (24) change to Col. 4. After R 24 (28) change to Col. 1. After R 26 (30) PROGRAM PAT. 2. Knit 2 rows Col. 1. After R 28 (32) change to Col. 2 AND ALTERNATE COLORS 1 & 2. After R 80 (84) change to Col. 3 ALTERNATE COLORS 1 & 3. After R 112 (116) change to Col. 4. ALTERNATE COLORS 1 & 4. After R 154 (158) PROGRAM PAT. 1. Knit 2 rows. After R 156 (160) change to Col. 1 and continue in Pattern. After R 168 (176) change to Col. 2. After R 172 (180) Change to Color 3. After R 176 (184) change to Col. 4. After R 180 (188) change to Col. 1. After R 182 (190) PROGRAM PAT. 3. Knit 2 rows. After R 184 (192) Alternate Colors 1 and 2. After R 258 (266) PROGRAM PAT. 1. Knit 2 rows.

FRONT: Make 1, reverse 1

NOTE: See CHART FOR NEEDLE Selection.

FNR: With Col.1 Cast on 95 (101) sts. Use same chart for programming and color changes same as back to R 448 (460). Bind off 36 (39) sts. on neck edge. After R 496 (516) transfer Rib sts. to MB and bind off.

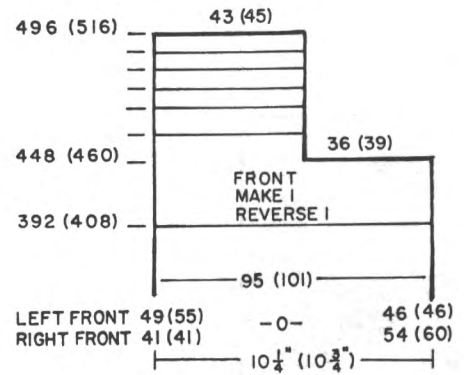

REPROGRAM ROWS	496 (516)	492 (512)	488 (508)	484 (504)	480 (500)	PAT. I	466 (482)	468 (484)
PAT. 3	392 (408)	388 (404)	384 (400)	380 (396)	376 (392)	PAT. I	362 (374)	364 (376)
PAT. 3	286 (298)	284 (296)	280 (292)	276 (288)	272 (284)	PAT. I	258 (266)	260 (268)
PAT. 3	182 (190)	180 (188)	176 (184)	172 (180)	168 (176)	PAT. I	154 (158)	156 (160)
PAT. 2	26 (30)	28 (32)	24 (28)	20 (24)	16 (20)	PAT. I	0	0

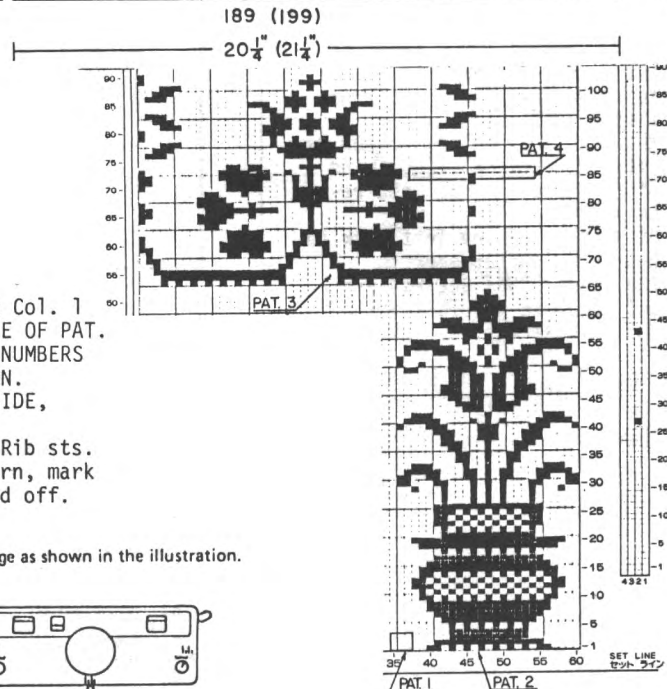
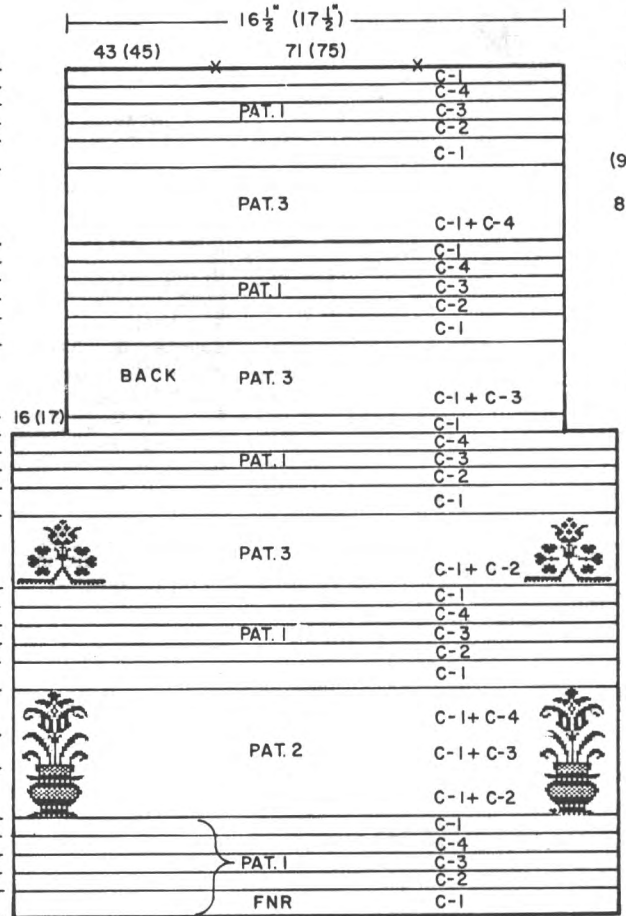

After R 260 (268) change to Col. 1 AND FOLLOW CHART FOR BALANCE OF PAT. PLEASE BE SURE TO READ ROW NUMBERS UNDER RE-PROGRAM ROWS COLUMN. After R 284 (296) ON EACH SIDE, bind off 16 (17) sts. After R 496 (516) transfer Rib sts. to main bed. With waste yarn, mark for neck opening, then bind off.

Set the K-Carriage and the KR Carriage as shown in the illustration.

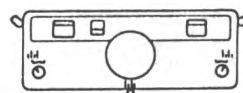
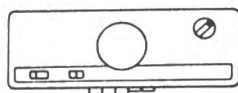

SLEEVES:

FNR: With Col. 1, cast on 181 (191) sts. After regular selvedge, SET PAT. 1 and follow Sleeve chart for color changes and Pattern changes.

NOTE: On the left are listed the rows for Pattern change. After R 28 (32) ON EACH SIDE, decrease 1 st. every 8th row 46(47)x. (ALWAYS MAKE DECREASES WHEN CARR. IS ON THE LEFT SIDE). After R 392 (404) transfer Rib sts. to MB and bind off.

WAISTBAND: Back, make 1 (2 strds. Col. 1)
K1, P1 Rib: With Col. 1 T 3/3 I cast on 189 (199) sts. Knit 40 rows. Transfer Rib sts. to MB. With wrong side facing, hang lower edge of back onto these Ndl's. Bind off LOOSELY.

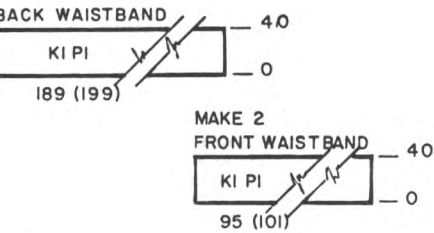

WAIST BANDS: Front, make 2 (2 strds. Col. 1)
K1, P1 Rib: With Col. 1, cast on 95 (101) sts. same as back band. Knit 40 rows. Transfer Rib sts. to MB. With wrong side facing, hang lower edge of one front onto these Ndl's. Bind off LOOSELY.

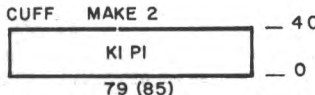

SLEEVE CUFF: Make 2 (2 strds. Col. 1)
K1, P1 Rib: With Col. 1, cast on 79 (85) sts. same as waistbands. After R 40 transfer Rib sts. to MB. With wrong side facing, hang sleeve edge onto these Ndl's. Bind off LOOSELY.

NECK BAND: Make 1, 2 strds. Col. 1
TUCK STITCH PATTERN. NOTE: Needle Selection. 'e' cast on 17 sts. between Yellow 8 and Green 9. Set Pat. 4. Knit 1 row. Push in LEFT TUCK BUTTON. Knit to R 290 (296). USING SHORT ROW METHOD, ON EACH SIDE, DEC. 1 st. EOR 8x, then INC. 1 st. EOR 8x. Set Counter to 0 (Short Rows do not count.) Continue in Pat to R 42 (46). WORK INSIDE SHORT ROWS. Bring to HP 9 Ndl's. opposite Carr. Knit 1 row, bring the 10th Ndl. to HP. Knit 2 rows. Carr is on the LEFT. Bring 1 Ndl. same side as Carr to HP and continue 7x more. End with Carr. on the right. *PUSH BACK 2 Ndl's OPP. CARR. knit across and bring 1 Ndl. to HP and REPEAT FROM * till the sts. on this side are in work.

REPROGRAM ROWS	
392 (404) -	C-1
376 (388) -	C-2
372 (384) -	C-3
368 (380) -	C-4
364 (376) -	C-1
358 (370) -	C-1
308 (320) -	C-1 + C-2
276 (288) -	C-1 + C-3
230 (242) -	C-1 + C-4
220 (228) -	C-1
216 (224) -	C-2
212 (220) -	C-3
208 (216) -	C-4
202 (210) -	C-1
128 (136) -	C-1 + C-3
118 (122) -	C-1
114 (118) -	C-2
110 (114) -	C-3
106 (110) -	C-4
100 (104) -	C-1
26 (30) -	C-1 + C-4
16 (16) -	C-1
12 (12) -	C-2
8 (8) -	C-3
4 (4) -	C-4
0 -	0

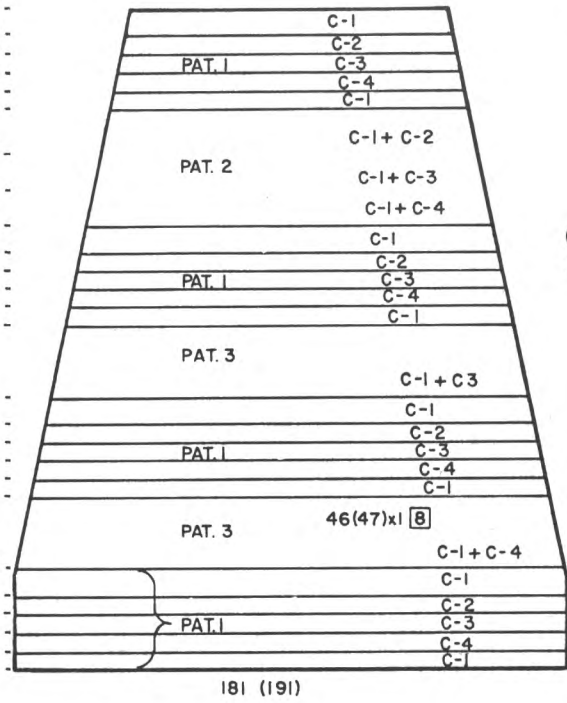

(16 1/2")
(16")

FRONT & NECK BAND MAKE 1
— 290 (296)

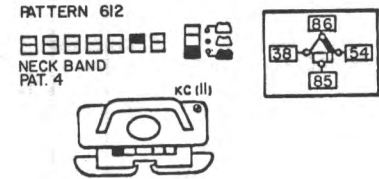
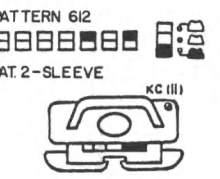
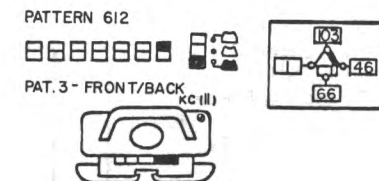
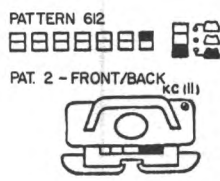
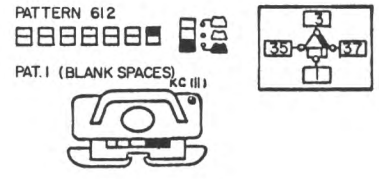
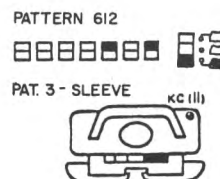
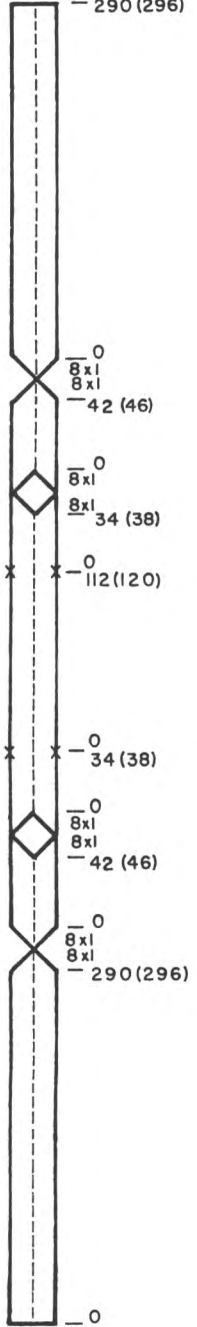

Move Carr. to the left side and work the inside short rows in the same way (put the sts. on right to HP) and work the left side same as you did before. Set Counter to 0 and continue in Pattern. After R 34 (38) mark for neck opening with W.Y. Counter to 0. After R 112 (120), mark for neck as before. FOLLOW THE CHART for remaining Short Row increases and Decreases. After R 290 (296), bind off.

FINISHING:
See General Instructions. Pin 1 side of band to the inside and 1 to the outside of front and neck edge, then sew in place. making sure to match the shapings made by the short row knitting.

613



JACKET BACK: Use 1 Strd. Pebble and 1 Strd. Glace together. Tension 3

W.Y. Cast on 99(105)[110] Sts., same as Skirt. Change to Garment Yarn and continue in St. st. After Row 88(90)[92] Shape Armhole.
 ON EACH SIDE Bind off 3(4)[5] Sts. 1x, 3 Sts. 1x, 2 Sts. 3x, 1 St. 2x. After row 132(138)[144] Shape Neck. Bind off the center 19(21)[22] Sts. Place Sts. on the left into HP and complete the right side 1st. *on Neck edge B0 6 Sts. 1x, 1 st. 1x.
 After Row 138(144)[150] Bind off Remaining Sts.
 Bring Sts. on the left back to WP Turn Counter Back to 132(138)[144] and complete the same as Right side following instructions from * to *.

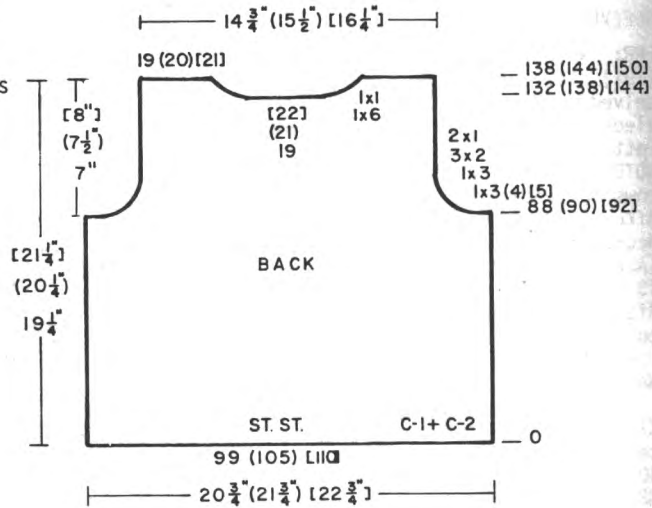

WOMENS 3 PIECE SUIT

SIZES: 6 8/10 [12/14]
YARN: Pebble, Glace and Angora
AMOUNT:
 Col.1 48 50 52 oz.
 Col.2 23 24 25 oz.
 Col.3 2 Balls all Sizes (Angora)
TENSIONS: See Instructions
GAUGE: Skirt & Top 9 Sts. 13 Rows = 2"
 Jacket 9.5 Sts. 14 Rows = 2"

Made on the Bulky Machine. The Purl side is the Right Side. Trim is Crochet Using #E Hook. Small amount of ribbing on the top.

TOP: T 5. Front/Back the same Use 1 strand of Pebble and 1 Strand Glace together.

K2/P2: Cast on 78(82)[86] Sts. Knit 10 Rows. Transfer Rib Sts. to MB and continue in St. st. After R 74(78)[82] ON EACH SIDE Bind off 1 St. EOR 18(19)[20]x. BUT AT THE SAME TIME after R 90 (94)[98] Bind off the center 8 (10)[12] Sts. Place the Ndl. on the left into HP and Complete the right side first.
 *On Neck edge bind off 4 Sts. 1x, 3 Sts. 1x, 1 St. 6(7)[8]x.
 After row 110(116)[122]. Bind off the remaining Sts. Bring Ndl. on the left back into WP, turn row counter back to 90(94)[98] and complete the right side following instructions from * to *

SKIRT: T5. Use 1 Strd. Pebble 1 Strd. Glace together.

MAKE 2

W.Y. Cast on 86(90)[94] Sts. After several rows end with 1 row Ravel cord to the Right. Counter at 0. Change to Garment yarn and knit in St. st. After row 174(180)[186] Remove on W.Y.

WAIST BANDS: Make 2

Bring 72(76)[80] Ndl. to WP. Hang open Sts. of Skirt top onto these Ndl. decreasing evenly across. With 1 Strand Pebble and 1 Strand Glace Tension 3.2. Knit 10 Rows. Break Yarn. With 4 Strands of Glace together. Knit 10 Rows. Pick up 1st row to form hem and Bind off Loosely.

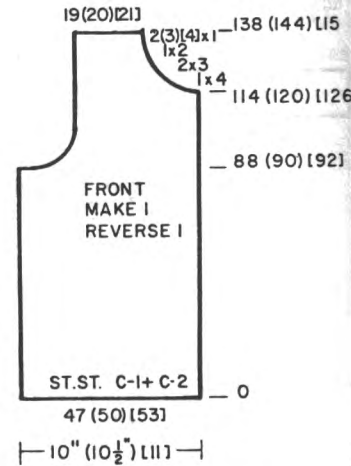
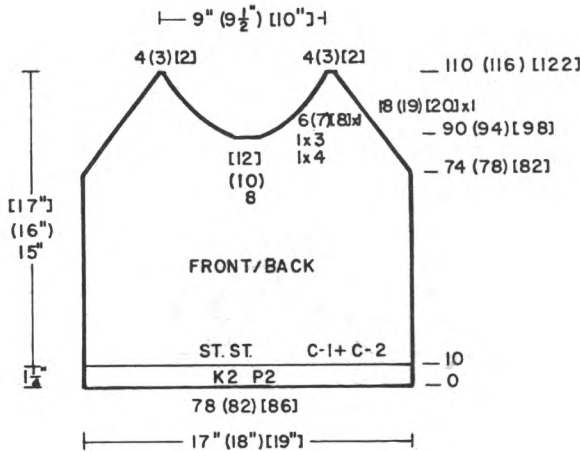

JACKET FRONT: Make 1 Reverse 1 Same yarn as back T3.

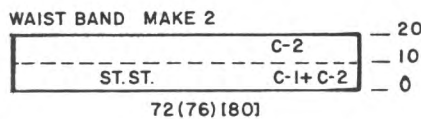
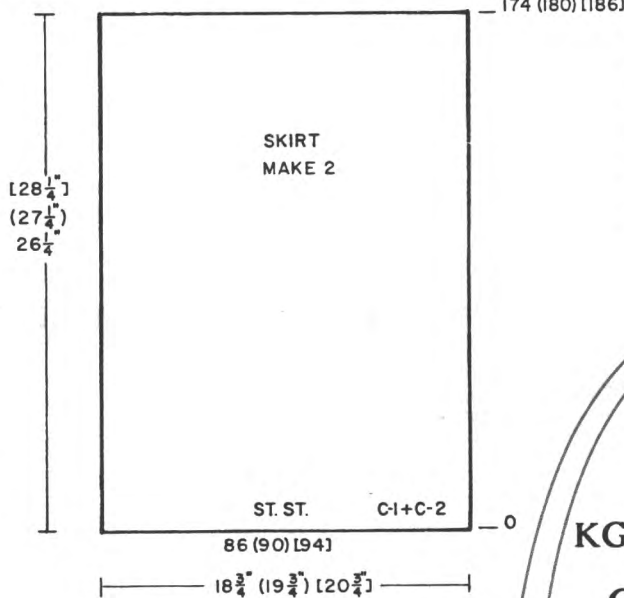

W.Y. Cast on 47(50)[53] Sts. same as Skirt. Change to Garment Yarn and continue in St. st. After Row 88(90)[92] Shape Armhole same as back. After R 114(120)[126] Shape Neck. On neck edge Bind off 4 Sts. 1x. 3 Sts. 2x, 2 Sts. 1x, 1 St. 2(3)[After R 138(144)[150] Bind off the Remaining Sts.

CLEARANCE SALE

KG 89
GARTER CARRIAGE
 OK for KH890 KH 891 and COMPUKNIT III

Regular Price \$309.95
SALE PRICE \$174.00

Order direct from KNITKING

SLEEVES: T3

Section 1:
W.Y. Cast on 26 Sts. After several rows end with 1 row Ravel cord. Using 4 Strands of Glace together Knit 2 rows. Dec. 1 St. EOR 12 x using short row Method. Bring all ndls. to HP. When Section is completed Remove on W.Y. (Remove each side on separate Yarn). Reverse and rehang right edge of Section 1 back onto Machine. Bring to HP.

Section 2: Cast on To the Right of St. in HP(Or use Cast on Rag) 10 Sts. Col.3 (Angora). Knit 2 Rows. Using short rows Inc. 1 St. on the left by pushing back to WP and on opposite side of Carr. Bring 1 St. to HP. Knit ONLY over the 10 Sts. 1 St. EOR 12x. Cut Yarn. Bring all Ndls. to HP.

Section 3: Col. 3 Rehang other side of section 1, Bring all Ndls. to HP and complete Same as Section 2 but over the left side.

Section 4: Col.3 Bring the Center 22 Ndls. to W.P. On side opposite Carr. Bring to HP 1 St. EOR 10x. on each side. Bring remaining 2 Sts. to HP. Remove all Sts. on W.Y. Reverse and Rehang on Same Needles.

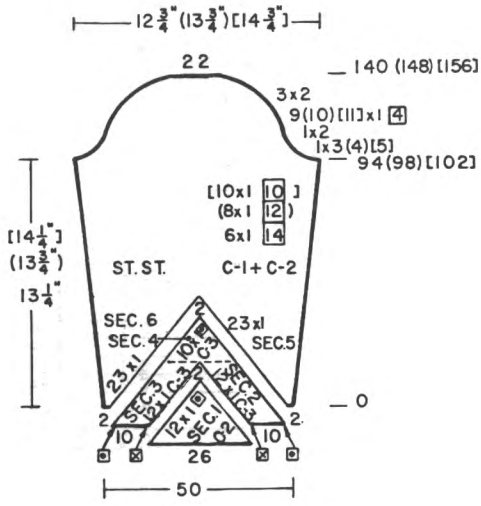

Section 5: Col.1 Place all Ndls into HP. On one side cast on 2 Sts. with Col. 1 & 2 Knit 2 rows over these 2 Sts. Work increase short rows. Push Back 1 Ndl. EOR 23x. BUT AT THE SAME TIME on side edge Inc. 1 St. every 14 Rows 16x(Every 12th row 8x)[Every 10th row 10x]

Section 6: Col.1 Break Yarn. Bring all Ndls. to HP.. Move Carr. to other side Cast on 2 Sts. Knit 2 rows and complete in same manner as other side. Place all Ndls. into WP and continue in St. st. Continue the increases on each side. After R 94(98)[102] Shape sleeve cap. On each side B0 1 St. 3(4)[5]x. 2 Sts. 1x, 1 St. every 4 rows 9 (10)[11]x. 2 Sts. 3x. After row 140(148)[156] Bind off the remaining Sts.

FINISHING:
Join the side seams of Skirt. With 1 Strd. Pebble & 1 Strd. Glace, Single crochet 2 rows around skirt bottom edge. JACKET: See General Instructions. With 4 Strds. Glace together Single Crochet 8 rows around Jacket bottom then 1 Row reverse Single Crochet. For front and neck trim and the sleeve edge Crochet 5 rows Single Crochet and 1 row reverse Single Crochet. Sleeveless top: 2 rows crochet around neck opening and 1 row reverse single crochet. Crochet Straps for top to desired length.

614



Make on any Standard or Electronic machine with Plating ability. The Ribbing is K1, P1 using 2 strds Pearlite in Col. 1. Worn on the PURL SIDE. Knitted sideways on the machine.

BLOUSE FRONT: PLATING with Col. 1. (Dark Pearlite in Plating Feeder, Dark Glace in Main Feeder.

W.Y. cast on beginning with Ndl. 64 (70) [74] to the RIGHT OF 0. Cast on 52 (54) [56] sts. After several rows, end with 1 row Ravel Cord to the right. COUNTER 0. Change to Col. 1 (see above explanation) and knit 10 (12) [14] rows. FOLLOW THE CHART FOR COLOR CHANGES THROUGHOUT. AT UNDERARM EDGE, increase 1 st. EOR 26 (28) [30]x. After R 54 (58) [62] ON THE LEFT, cast on 55 (58) [61] sts. After R 124 (132) [142], SHAPE NECK: Bind off 3 sts. EOR 12x. 4 sts. 4x. (3 sts. EOR 12x, 4 sts. 5x) [3 sts. EOR 12x, 4 sts. 6x]. After R 155 (166) [177], BEGIN INCREASES FOR NECK. Cast on 4 sts. EOR 4x, 3 sts. 12x. (4 sts. EOR 5x, 3 sts. 12x). [4 sts. EOR 6x, 3 sts. 12x]. After R 256 (274) [292] ON THE LEFT, bind off 55 (58) [61] sts. Continue in Pat. BUT AT THE SAME TIME, AT UNDERARM EDGE, dec. 1 st. EOR 26 (28) [30]x. After R 310 (332) 354], remove on contrast waste yarn.

WOMENS TWO-PIECE DRESS
SIZES: 8/10 (14) [16/18]
YARN: PEARLITE & GLACE
You will need 1 Cone each of the following Blending Colors.
Light Pearlite
Dark Pearlite
Lite Glace
Dark Glace
COLOR 1 = 1 strd. Dark Pearlite in PLATING FEEDER PLUS 1 strd Dark Glace in MAIN FEEDER
COLOR 2 = 1 strd. Light Pearlite in PLATING FEEDER PLUS 1 strd Light Glace in MAIN FEEDER
TENSION: PLATING 8, Rib. See instructions.
GAUGE: 13 sts. 19 rows = 2"

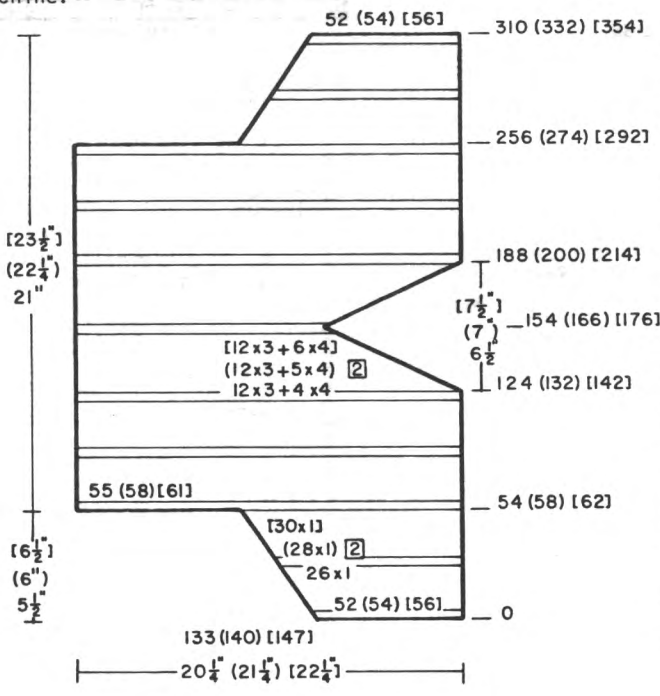

CONTINUED NEXT PAGE

BLOUSE BACK:

Work the back the same as the front but OMIT THE NECK SHAPING. MARK ROW 124 (132) [142] then MARK ROW 188 (200) [214] for NECK OPENING.

NECKBAND: Make 1 - 2 strds. Dark Pearlite ONLY (Col. 1)

CLOSE ONE SHOULDER FIRST.

K1, P1 Rib: T 3/3 II. With 2 strds. Dark Pearlite ONLY (Col. 1) Cast on 119 (125) [131] sts. After regular cast on, ON THE LEFT, increase 1 st. EVERY ROW 14x. After R 16, transfer Rib sts. to MB. With KNIT SIDE FACING, hang back neck and one half of Front V onto these Ndl. Bind off LOOSELY.

NECKBAND: Make 1 - 2 strds. Dark Pearlite Only (Col. 1)

MAKE OTHER NECKBAND FIRST.

K1, P1 Rib. T 3/3 II With 2 strds Dark Pearlite ONLY (Col. 1), cast on 65 (69) [73] sts. Work the same as other band but ON THE RIGHT, increase 1 st. EVERY ROW 14x. After R 16, transfer Rib sts. to MB. WITH KNIT SIDE FACING, hang the other side of V Neck onto these Ndl. Bind off LOOSELY.

SLEEVE BANDS: 2 strds. same as Neckband.

CLOSE SECOND SHOULDER FIRST.

K1, P1 Rib. T 3/3 II. With Col. 1, cast on 103 (107) [111] sts. After regular selvedge knit 16 rows. Transfer Rib sts. to MB. With KNIT SIDE FACING, hang sleeve edge onto these Ndl. decreasing evenly across. Bind off LOOSELY.

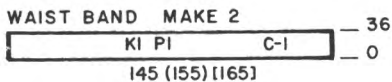

BLOUSE WAISTBANDS: Make 2 - 2 strds. same as neck and sleeve bands.

K1, P1 Rib: T 3/3 II. With Col. 1 cast on 145 (155) [165] sts. After regular selvedge, knit 36 rows. Transfer Rib sts. to MB. WITH KNIT SIDE FACING, hang lower edge of Blouse onto these Ndl. Bind off LOOSELY.

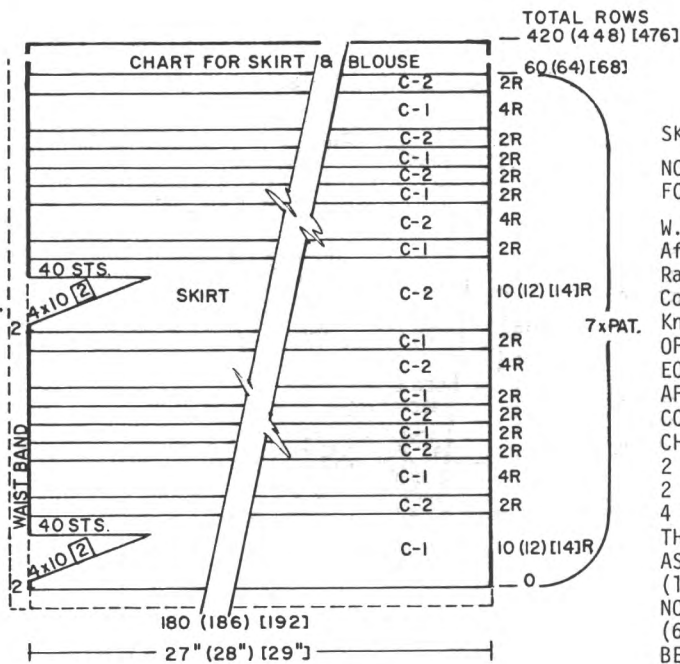

SKIRT: Knit Sideways, PLATING.
 NOTE: PLEASE FOLLOW THE CHART FOR CHANGES IN COLOR STRIPES.
 W.Y. cast on 180 (186) [192] sts. After several rows end with 1 row Ravel Cord to the right. Counter 0. Change to Col. 1. Knit 2 rows. ON OPPOSITE SIDE OF CARR. bring to HP 10 sts. EOR 4x. ALL NDLS. IN WORK. AFTER R 10 (12) [14] BEGIN THE COLOR STRIPES AS SHOWN ON THE CHART.
 2 ROWS COL. 2, 4 ROWS COL. 1, 2 ROWS EACH COL. 2, 1, 2, 1, 4 ROWS COL. 1. 2 ROWS COL. 2 THEN WORK THE SHORT ROWS SAME AS BEFORE, completing 10 (12) [14] rows COL. 2. NOW FOLLOW THE CHART TO ROW 60 (64) [68].
 BEGIN FROM THE BEGINNING AND COMPLETE THE PATTERN 7x. After R 420 (448) [476], remove the sts. onto contrast waste yarn.

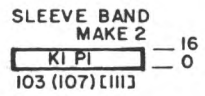

SKIRT WAISTBAND: MAKE 2 USING 2 strds. PEARLITE ONLY. Col. 1. T 3.2

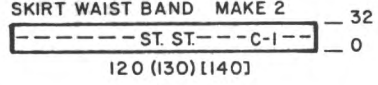

'e' cast on with Col. 1, 120 (130) [140] sts. Knit St. st. to R 32. Pick up first row to form hemi. With KNIT SIDE FACING, hang one half waist edge onto these Ndl. Bind off LOOSELY. REPEAT FOR 2nd HALF OF SKIRT WAIST..

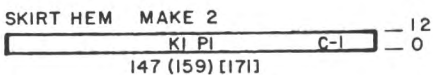

SKIRT HEM: Make 2. T 4/4 II strd. Pearlite. 2 Strds.

K1, P1 Rib: With Col. 1 (1 strd only). cast on 147 (159) [171] sts. After regular selvedge, knit 12 rows. Transfer Rib sts. to MB. With KNIT SIDE FACING, hang one half bottom edge of skirt onto these Ndl. Bind off LOOSELY. REPEAT FOR 2nd HALF.

FINISHING:
 See General Instructions. Weave side seam of Skirt. Thread elastic through waist band.

IT'S READY NOW!

KNITKING MAGAZINE BOUND VOLUME 20

- * HARD BOARD COVER
- * COMPLETE INSTRUCTIONS
- * WILL HOLD ANOTHER COMPLETE VOLUME

Price: \$24.95
 Shipping Costs - \$3.25



615



WOMENS TWO-PIECE SUIT

SIZES: 6/8 (10/12) [14]

YARN: Venetia

AMOUNT:

Col. 1 25 26 27 oz.

Col. 2 9 10 11 oz.

TENSION: Fair Isle & St. st. T 5

Rib. See Instructions.

GAUGE: Fair Isle = 17 sts. 20

rows = 2"

St. st. 16 sts. 21 rows = 2"

Make on any Electronic Machine.

Bands are K1/P1 Ribbing.

Skirt hem is FNR. Design is

2 Color Fair Isle.

JACKET BACK:

K1, P1 Rib. With Col. 1, cast on 166 (171) [179] sts. Knit selvedge. With T 1/1 II, knit 50 rows. Transfer Rib sts. to MB. Add 1 st. on right. Knit 1 row to the left Set Fair Isle Pattern. Continue in Pattern.

After R 156 (162) [168] mark each side with W.Y. for setting in sleeves.

After R 260 (270) [280], mark each side for neck opening then BO or remove the sts. separately onto W.Y.

FRONT: Make 1, reverse 1.

K1, P1 Rib: With Col. 1, cast on 81 (85) [89] sts. same as Back. Knit 50 rows. Transfer Rib sts. to MB. Knit 1 row to the left then set Pat and continue in Fair Isle Pattern.

After R 156 (162) [168] mark for armhole. After R 178 (184) [190], ON NECK EDGE, BO 1 st. every 3rd row 27 (28) [29]x. After R 260 (270) [280], bind off or remove on W.Y.

NECKBAND: Make 1 with Buttonholes
Make 1 without

FNR: T 5/5 II With Col. 1, cast on 180 (190) [200] sts. Knit 15 rows.

For the Buttonhole Band, follow Chart for placement of buttonholes. Knit 15 rows. Transfer Rib sts. to MB. Knit 1 row T 10, Remove on W.Y.

SLEEVES:

W.Y. cast on same as before.

146 (154) [162] sts.

With Col. 1, knit 1 row to the left.

Set Fair Isle Pattern

and continue in Pattern. ON

EACH SIDE, increase 1 st. every 10th row 14x.

After R 142 (146) [150], remove on W.Y.

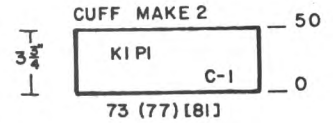
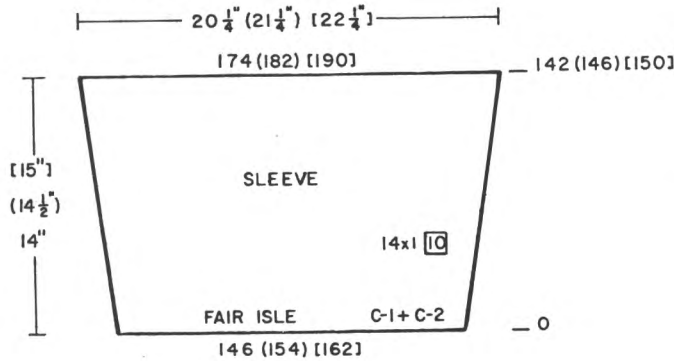

SLEEVE CUFFS: T 1/1 II

K1, P1 Rib. With Col. 1 cast on 73 (77) [81] sts. Knit selvedge. Knit 50 rows. Transfer Rib sts. to MB. With wrong side facing, hang open sts. of sleeve onto these Ndl. decreasing evenly across. Bind off.

FINISHING:

See General Instructions. Weave Neckband to front and back neck edge.

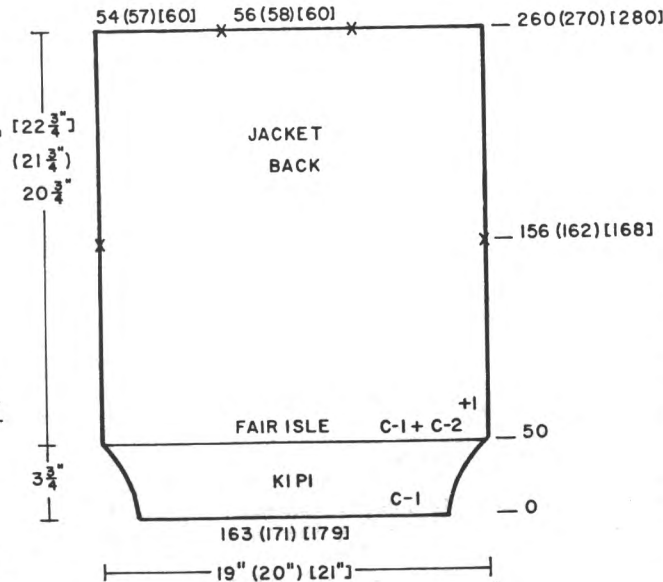

SKIRT: Make 2 sections.

FNR: With Col. 1 Cast on 152 (160) [168] sts. Knit selvedge. T 5/5 II. Knit 14 rows. Transfer Rib sts. to MB, T 5 St. st.. Begin Short Rows. ON OPPOSITE SIDE OF CARR. Bring 40 Ndl. to HP before knitting next 2 rows. ON OPPOSITE SIDE OF CARR. push back to WP 10 sts. 4x ON EACH SIDE.

After Short Rows, knit to R 210 (220) [230].. ON EACH SIDE decrease 1 st. every 10th row 7x. After R 280 (290) [300] remove on W.Y.

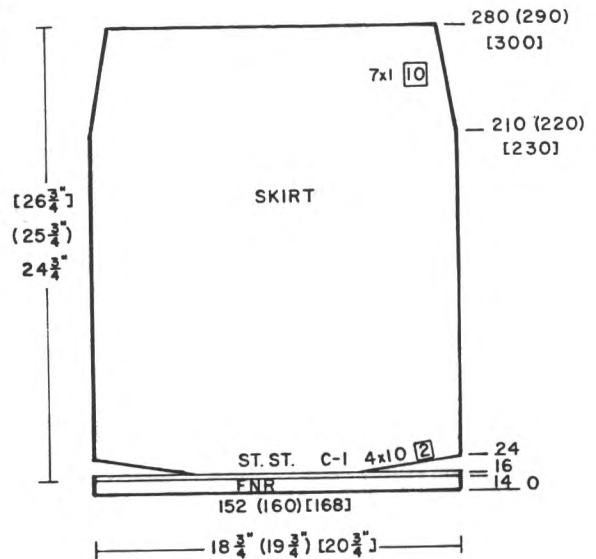
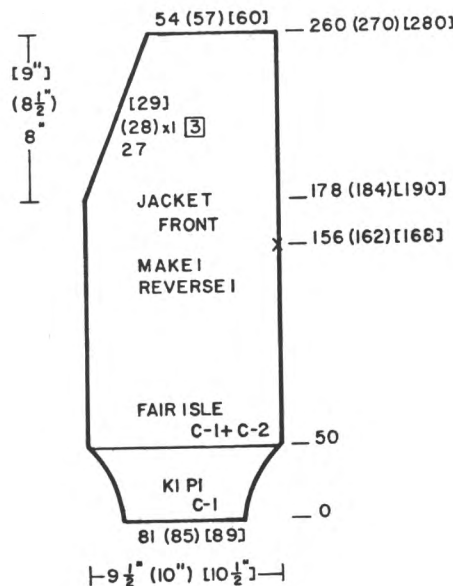

NECK BAND MAKE 2 (OMIT BUTTON HOLES IN 1)

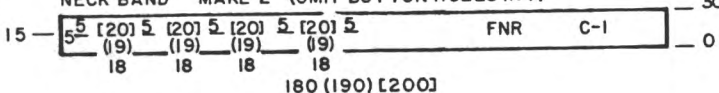

CONTINUED NEXT PAGE

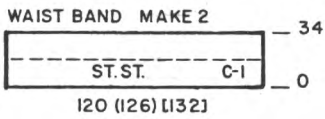

SKIRT WAISTBAND: Make 2.

Bring 120 (126) [132] Ndls. to WP. Hang open sts. of Skirt onto these Ndls. decreasing evenly across. With Col. 1 T 5, knit 34 rows. Pick up first row to form hem. Bind off.

FINISHING:

Join side seams. Steam lightly.

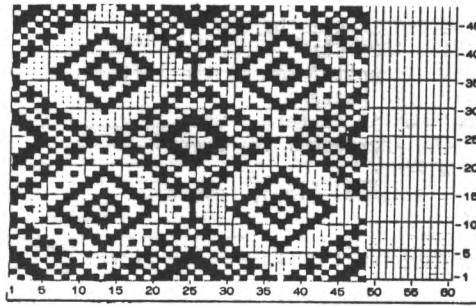

PATTERN 615

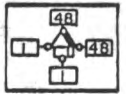

616



WOMENS 3-PIECE SUIT

SIZES: 8/10 (12/14)

YARN: Regular Venetia

AMOUNT:

Col. 1 22 23 oz.
Col. 2 20 21 oz.

TENSION: Fair Isle 4.2 Rib. &

St. st. See Instructions

GAUGE: Fair Isle 16.5 sts. 22 rows = 2"

TOP. 16 sts. 25 rows = 2"

Make on any Electronic Machine with Ribber. (COMPUKNIT III owners use Pat. 32 from Pattern book.)

BLOUSE BACK:

K1, P1 Rib: T 2/2 I. With Col. 2 cast on 152 (160) sts. Knit 20 rows. Transfer Rib sts. to MB. T 4.1. Continue in St. st. After R 160 (168) ON EACH SIDE, increase 1 st. EOR 14x, cast on 4 sts. 1x. After R 268 (280) bind off the center 22 (24) sts. place sts. on the left to HP and complete the right side first. *ON NECK EDGE, BO 5 (6) sts. 1x, 4 sts. 1x, 3 sts. 1x, 1 st. 1x. After R 278 (290), bind off the remaining sts. Bring the Ndls. on the left to WP. turn Row Counter back to 268 (280) and complete the left half. Follow instructions from *.

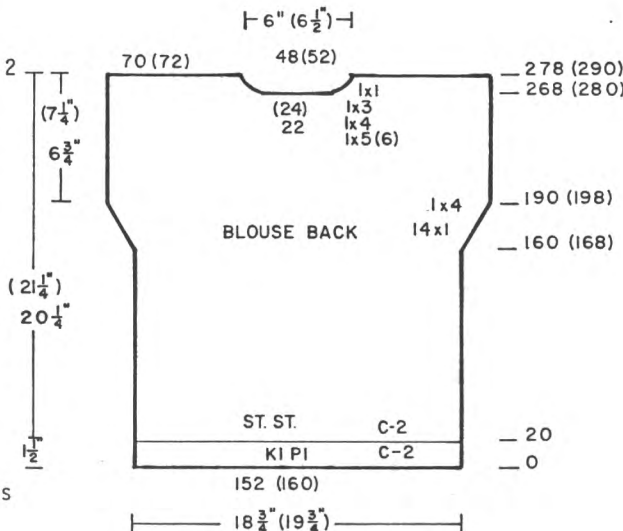

BLOUSE FRONT:

Work front the same as back to R 260 (272). Bind off the center 22 (24) sts. place sts. on the left to HP and complete right side first.

*ON NECK EDGE, BO 4 Sts. 1x, 3 Sts. 1x, 2 Sts. 1x, 1 St. 4(5)x. After R 278(290) bind off the remaining Sts.

Bring the Ndls. on the left to WP Turn Row Counter back to 260(272) and complete the left half. Follow instructions from*.

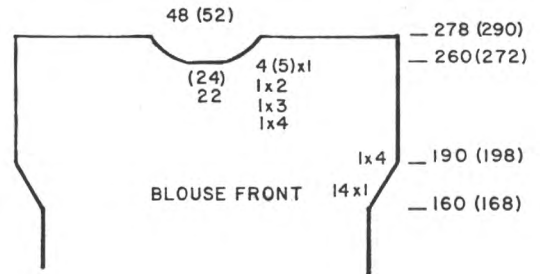

JACKET BACK: Fair Isle T 4.2

W.Y. cast on 172 (180) sts. After several rows end with 1 row Ravel Cord to the right. Counter 0. Change to Col. 1 and knit 1 row to the left. Set Fair Isle Pat. Knit 1 row to the right to select Ndls. Continue in Fair Isle Pat. with Col. 1 and 2.

After R 136 (142), SHAPE ARMHOLE: ON EACH SIDE, bind off 4 (5) sts. 1x, 2 sts. 2x, 1 st. 13x.

After R 232 (242) mark neck opening with W.Y. then bind off or remove each section on W.Y.

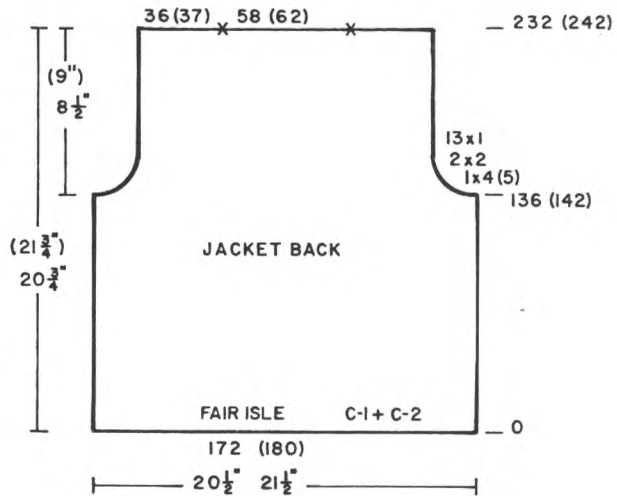

JACKET FRONT: Fair Isle T 4.2

W.Y. cast on 86 (90) sts. same as back. Knit to R 136 (142).
 SHAPE ARMHOLE on one side same as the back. (See Chart).
 After R 208 (218) SHAPE NECK: ON NECK EDGE, bind off 9 (10) sts. 1x, 4 (5) sts. 1x, 4 sts. 1x, 3 sts. 1x, 2 sts. 2x, 1 st. 5x.
 After R 232 (242) bind off or remove on W.Y. the remaining sts. MAKE SECOND HALF WITH REVERSE SHAPING.

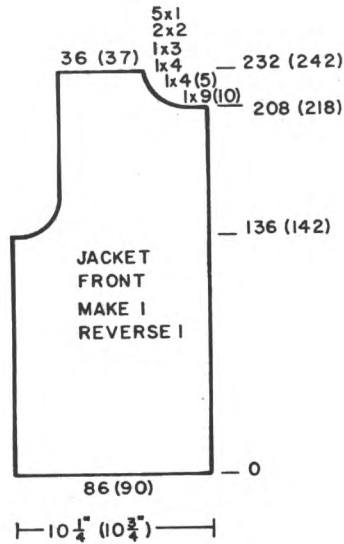

JACKET BACK HEM: Col. 1 T 4

'e' cast on 156 (164) sts. Knit 28 rows St. st. Pick up first row to form hem. With wrong side facing, hang open sts. of lower edge of back onto these Ndl. decreasing evenly across. Bind off Loosely.

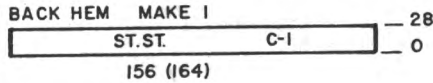

JACKET FRONT HEM: Col. 1 T 4

'e' cast on 76 (80) sts. ON THE RIGHT (left for second half) increase 1 st. EOR 6x. After R 14, decrease 1 st. EOR 6x. Pick up first row to form hem. With wrong side facing, hang open sts. of lower front onto these Ndl. Bind off LOOSELY.

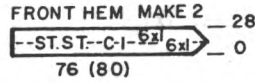

JACKET FRONT BANDS: Make 2. Col. 1 T 4

Cast on 118 (124) sts. and work St. st. ON EACH SIDE, inc. 1 st. EOR 6x, then dec. 1 st. EOR 6x. After R 28, pick up first row to form hem. With wrong side facing, hang front edge of Jacket onto these Ndl. Bind off LOOSELY.

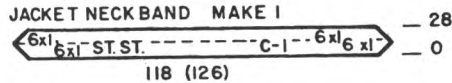
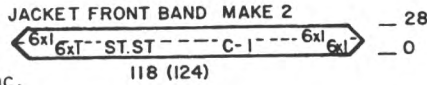

JACKET NECKBAND: Make 1, Col. 1 Close Sh. first. T 4 St. st.

Cast on 118 (126) sts. ON EACH SIDE inc. 1 st. EOR 6x, then dec. 1 st. EOR 6x. After R 28, pick up first row to form hem. With wrong side facing, hang neck edge onto these Ndl. Bind off LOOSELY.

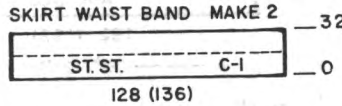

SKIRT: Make 2 sections. Col. 1.

W.Y. cast on 162 (170) sts. After several rows, end with 1 row Ravel Cord to the right. Set Carr. for Short Rows, knit across (be sure to wrap inside Ndl. to prevent holes). REPEAT FROM * for right side. ON OPPOSITE SIDE OF CARR, PUSH BACK TO WP 15 sts. 4x ON EACH SIDE. Continue in St. st to R 234. Change tension to 4.2. Knit to R 284. Change tension to 4. After R 308 (318), remove on contrast W.Y.

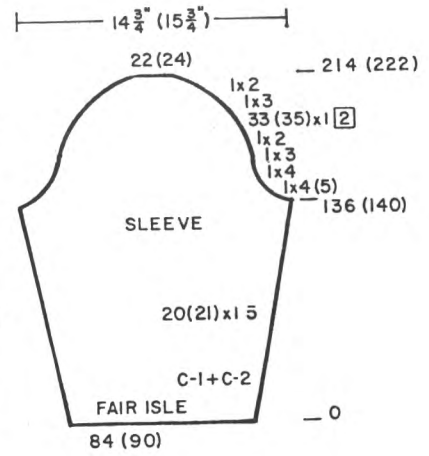

JACKET SLEEVES: T 4.2

OPEN CAST ON with W.Y. 84 (90) sts. same as for back and front. then Counter 0 and continue in Fair Isle Design with colors 1 and 2. ON EACH SIDE, increase 1 st. every 5th row 20 (21)x. After R 136 (140), SHAPE CAP: ON EACH SIDE, bind off 4 (5) sts. 1x, 4 sts. 1x, 3 sts. 1x, 2 sts. 1x, 1 st. 33 (35)x, 3 sts. 1x, 2 sts. 1x. After R 214 (222), bind off the remaining sts.

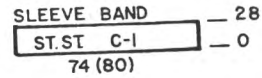

JACKET SLEEVE BAND: Col. 1 T 4 St. st.

Cast on 74 (80) sts. and knit 28 rows. Pick up first row to form hem. With wrong side facing hang the open sts. of sleeve onto these Ndl. decreasing evenly across. Bind off LOOSELY.

SKIRT WAISTBAND: Make 2 St. st.

Bring 128 (136) Ndl. to WP. With wrong side facing, hang open sts. of waist edge onto these Ndl. With T 4, Col. 1, knit 32 rows. Pick up first row to form hem and bind off LOOSELY.

SKIRT BOTTOM EDGE: Make 2. St. st.

Bring 152 (160) Ndl. to WP. With wrong side facing, hang open sts. of Skirt edge onto these Ndl., decreasing evenly across. T 4, Col. 1. Knit 6 rows. Change to T 5 and knit 6 rows. Pick up first row to form hem. Bind off LOOSELY.

FINISHING:

See General Instructions. Work 1 row single crochet and 1 row REVERSE single crochet around neckline of Blouse.

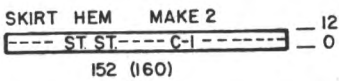
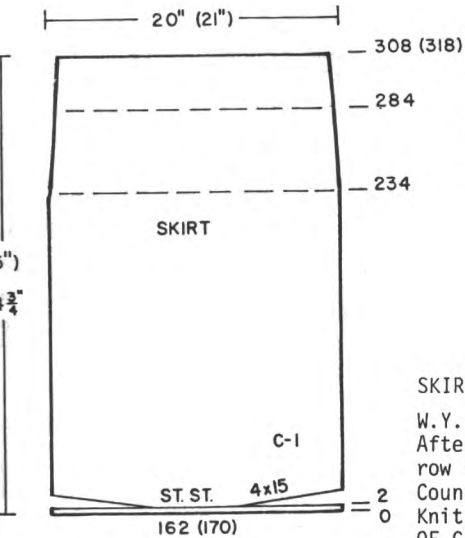

32

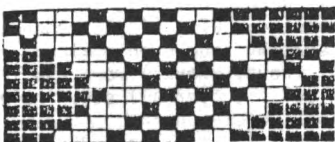

617

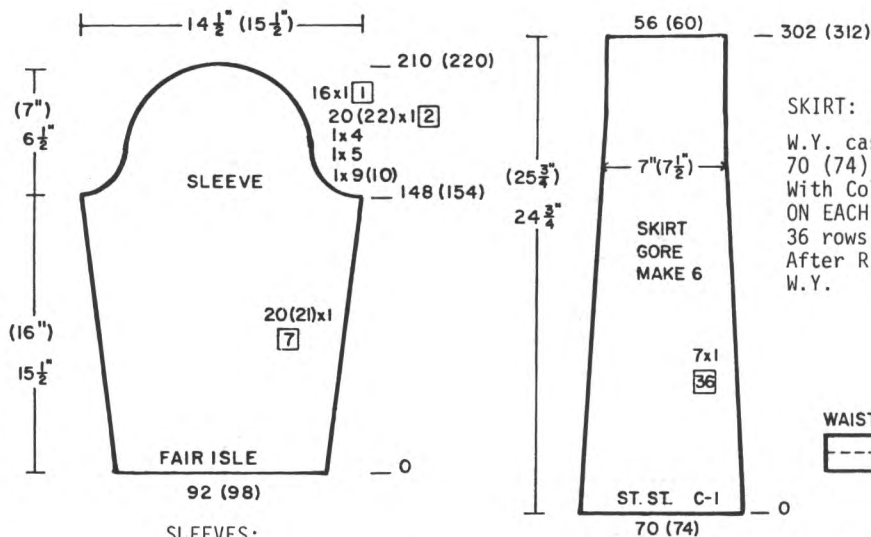

SKIRT: Make 6 Gores.
 W.Y. cast on (SEE NOTE).
 70 (74) sts.
 With Col. 1, knit St. st.
 ON EACH SIDE, dec. 1 st. every
 36 rows 7x.
 After R 302 (312), remove on
 W.Y.

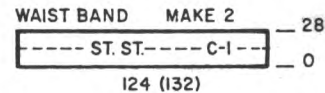

WOMENS HOUNDS TOOTH 2-PIECE SUIT

SIZES: 8/10 (12/14)

YARN: Venetia

AMOUNT:

Col. 1 27 29 oz.

Col. 2 10 11 oz.

TENSION: Fair Isle T 6

Skirt - St. st. 4.2

GAUGE: Fair Isle 18 sts. 19 rows = 2"

St. st. 17 sts. 24 rows = 2"

9 Buttons. Crochet over 5/8" rings
 or purchase buttons.

Make on any Standard or Electronic
 machine. - A Fair Isle Design.

NOTE: For all sections which specify
 Waste Yarn (W.Y.) cast on. Follow
 these instructions.

W.Y. cast on. After 7 to 9 rows
 knit 1 row with Ravel Cord to
 RIGHT (LEFT). Turn Row Counter
 to 0, change to Garment yarn
 and knit as per instructions.

BACK:

W.Y. cast on 182 (192) sts. (SEE NOTE)
 Set Pattern with Col. 1. Continue in
 Fair Isle Pattern.

ON EACH SIDE, dec. 1 st. every
 20 rows 3x.

After R 90 ON EACH SIDE, inc. 1 st.
 every 20 rows 3x.

After R 152 (158), SHAPE ARMHOLE:
 ON EACH SIDE, bind off 9 (10) sts.
 1x, 5 sts. 1x, 4 sts. 1x, 1 st.
 4 (5)x.

After R 232 (242) Mark Neck opening
 with W.Y. then remove each section
 on W.Y. or you can bind off.

FRONT: Make 1, reverse 1.

W.Y. cast on same as back.
 91 (96) sts.

Continue in Fair Isle Pattern.
 On SIDE EDGE, decrease 1 st.
 every 20 rows 3x.

After R 74 (80) MARK FOR POCKET
 (see Chart). After R 90, on
 SIDE EDGE, increase 1 st. every
 20 rows 3x.

After R 152 (158) SHAPE ARMHOLE
 SAME AS THE BACK.

After R 198 (204) SHAPE NECK:
 Bind off 13 sts. 1x, 1 st. EVERY
 ROW 13 (14)x, 1 st. EOR 9 (10)x.
 After R 232 (242), bind off or
 remove on W.Y.

SLEEVES:

W.Y. cast on same as before.
 Set Fair Isle Pattern with Col. 1
 and continue in Pattern.
 ON EACH SIDE, increase 1 st. every
 7th row 20 (21)x.
 After R 148 (154) ON EACH SIDE
 bind off 9 (10) sts. 1x, 5 sts. 1x,
 4 sts. 1x, 1 st. EOR 20 (22)x,
 1 st. EVERY ROW 16x.
 After R 210 (220) bind off remain-
 ing sts.

SKIRT WAISTBAND:

JOIN 3 of the GORES TOGETHER 2x.
 Bring 124 (132) Ndl's. to WP.
 With Color 1, knit 28 rows St. st.
 Pick up first row to form hem.
 With wrong side facing, hang the
 waist edge of joined gores onto
 these Ndl's. decreasing evenly
 across. Bind off LOOSELY.
 REPEAT FOR OTHER 3 GORES.

FALSE POCKET TRIM: Make 2.

With Col. 1 and Crochet Hook
 chain 32. Working down 1
 side then other side,, (DO
 NOT TURN) work 2 rows single
 crochet with 3 sts. at each
 end into same stitch.
 With Col. 2, work 1 row REVERSE
 SINGLE CROCHET.
 Sew to marked row (See Chart).

SLEEVE TRIM: Make 2.

With Col. 1, chain 24 and
 complete same as False Pocket
 Trim. Attach to sleeve edge.

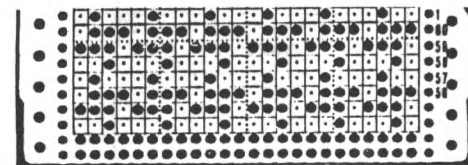
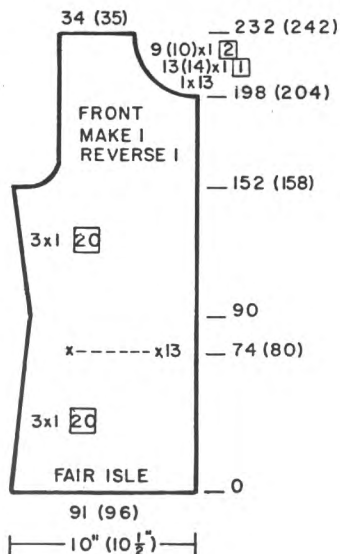
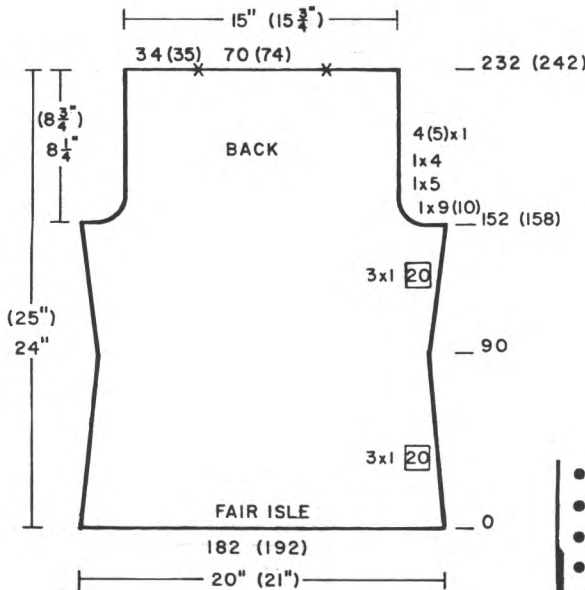

Punch thru Line 53

FINISHING:

See General Instructions.
 With Col. 1, work 2 rows of
 single crochet around fronts
 and neckline. On row 3, single
 crochet and make 9 BUTTONHOLES
 ON THE RIGHT FRONT by making chains
 to fit across Buttons, skip sts.
 and continue with single crochet
 and spacing them evenly along
 right front. Work 1 more row
 with Col. 1, over all sts. including
 the buttonhole chains.
 With Col. 2, work 1 row REVERSE
 single crochet.

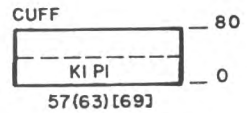
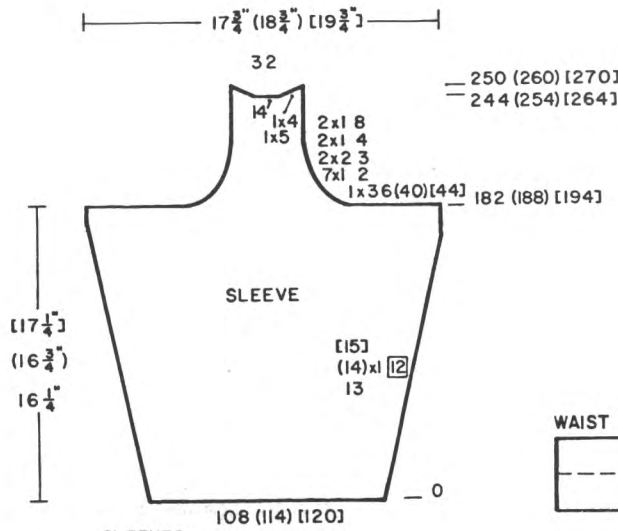

CUFFS: Make 2.
K1, P1 Rib: T 0/0 II.
Cast on 57 (63) [69] sts.
After selvedge, knit 80 rows.
Transfer Rib sts. to MB.
Pick up first row to form hem.
With knit side facing, hang open
sts. of sleeve edge onto these
Ndls. decreasing evenly across.
Bind off.

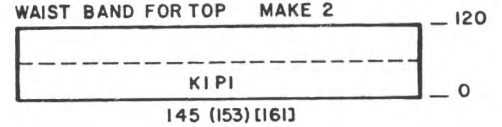

TOP WAISTBAND: Make 2
K1, P1 Rib: T 0/0 II.
Cast on 145 (153) [161] sts.
After selvedge, knit 120 rows.
Transfer Rib sts. to MB.
Pick up first row to form hem.
With knit side facing, hang
open sts. of Top onto these
Ndls. decreasing evenly across.
Bind off.

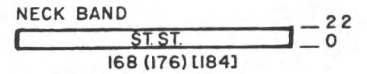

Join sleeves to body of top
first. Be sure to leave 1 seam open
so neckband can be made.

NOTE: See Photo.
Gather to fit.

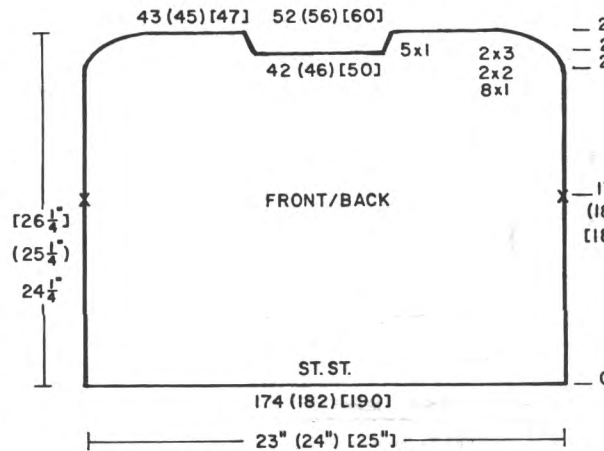

— 272 (282) [292]
— 260 (270) [280]
— 248 (256) [268]

NECKBAND: st. st.
W.Y. cast on same as front/back.
168(176)[184] Sts. At T2 Knit 22 rows.
Pick up first row to form hem.
With knit side facing, hang neck
opening onto these Ndls. Bind off.

FINISHING:
Close side seams and steam LIGHTLY.

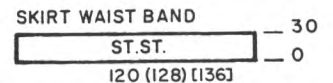

WAISTBAND: Make 2
Bring 120(128)[136] Ndls. to
WP. With wrong side facing
hang 1/2 of skirt waist onto these
Ndls. Knit 30 rows St. st.
Pick up first row to form hem.
Bind off. REPEAT FOR 2nd. HALF.
FINISHING: See General Instructions.
Weave open sts. of skirt
together.

WOMENS SADDLE SHOULDER TOP & SKIRT

SIZES: 8/10 (12/14) [16]
YARN: Pearlite
AMOUNT: 42 44 46 oz.
TENSION: St. st. 4, Rib 0/0 II (as
tight as possible)
GAUGE: 15 sts. 22 rows = 2"

Make on any Standard Machine with
Ribber. Stockinette stitch with
Ribbed Bands. The Purl side is the
right side.

NOTE: For all sections which specify
Waste Yarn (W.Y.) cast on, follow
these instructions.
W.Y. cast on. After 7 to 9 rows,
knit 1 row with Ravel Cord to the
RIGHT (LEFT). Turn Row Counter to
0 Change to garment yarn and knit
the section as per instructions.

TOP: FRONT & BACK THE SAME

W.Y. cast on 174 (182) [190] sts.
(SEE NOTE) Continue in St. st.
After R 178 (180) [186], mark each
side with W.Y. for sleeve opening.
After R 248 (256) [268], ON EACH
SIDE, dec. 1 st. EOR 8x, 2 sts. 2x,
3 sts. 2x BUT AT THE SAME TIME,
after R 260 (270) [280], bind off
the center 42 (46) [50] sts.,
place the sts. on the left into
HP and complete the right side
first.
*Continue dec. on shoulder but
ON NECK EDGE, BO 1 st. EOR 5x.
After R 272 (282) [292] bind off
the remaining sts.

Bring the Ndls. on the left to WP.
Turn Row Counter back to 260 (270)
[280] and complete the left half.
Follow instructions from *.

SKIRT: St. st. with Short Rows
W.Y. cast on same as front/back.
184 (192) [200] sts.
Knit 4 rows. Begin first section.
*Knit 10 rows. Carr. on the right.
Bring all Ndls. to HP
ON SAME SIDE AS CARR. push back
to WP, 15 Ndls. knit 2 rows.
(Be sure to wrap inside Ndl. to
prevent holes) and REPEAT 9x
MORE.
ON OPPOSITE SIDE OF CARR. bring
to HP. 15 Ndls. 10x (SEE CHART).
After R 50, one section is completed.*
REPEAT FROM * TO * for a total of
34 (36) [38] sections.
END WITH 6 ROWS ST. ST.
Remove on contrast W.Y.

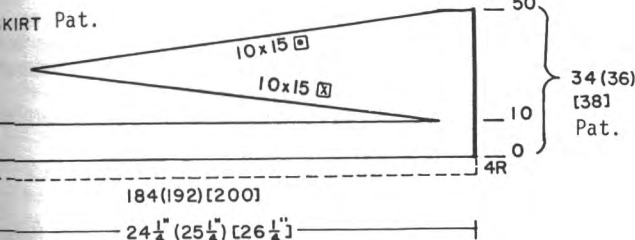



WOMENS TENNIS DRESS

SIZES: 8/10 (12/14) [16]

YARN: Glace = Col. 1
 Glace = Col. 2
 Angora = Col. 3
 Lurex = Col. 4
 Mirage = Col. 5

AMOUNT:
 Col. 1 2 2 2 Cones
 Col. 2 1 Small Spool all sizes
 Col. 3 2 Balls all sizes
 Col. 4 1 Ball (very small amount)
 Col. 5 1 Spool all sizes

TENSION: St. st. 3 Rib. 1/1 I

GAUGE: 17 sts. 24 rows = 2"

Make on any Standard or Electronic machine with Ribber. Stockinette stitch with Color Changes as given. Bands are K1, P1 Ribbing.

FRONT/BACK: The same

W.Y. cast on 166 (174) [182] sts. After several rows end with 1 row Ravel Cord to the right. Change to Col. 1. Counter 0. Continue in St. st.

After R 132 (140) [148], SHAPE SLEEVES: ON EACH SIDE, Cast on 4 sts. 1x, 3 sts. 1x, 1 st. 1x. After R 238 (250) [262], bind off the center 56 (60) [64] sts. Place the sts. on the left in HP and complete the right side first.

*SHAPE SHOULDER AND NECK AT THE SAME TIME.

FOR SHOULDER, bind off (or use Short Rows) 12 sts. 3x, 11 sts. 2x, (12 sts. 5x) [12 sts. 3x, 13 sts. 2x]

FOR NECK, decrease 1 st. EOR 5x. Bring the Ndl. on the left back to WP, turn Counter back to 238 (250) [262] and complete the left half. Follow the instructions from *.

WAIST BANDS: Make 2.

K1, P1 Rib: With 1 Strd. Col.1 and 1 Strd. Col.5 together, cast on 147 (153) [159] sts. After regular selvedge, knit 40 rows. Transfer Rib sts. to MB. WITH WRONG SIDE FACING, hang lower edge of Front/Back onto these Ndl. decreasing evenly across. Knit 1 row with LOOSE tension and bind off.

REPEAT for second section of top.

JOIN ONE SHOULDER then
 Make NECKBAND: Color 1, Ten. 2

'e' Cast on over 151 (159) [167] Ndl. Knit 20 rows St. st. Pick up first row to form hem. With wrong side facing, hang neck opening onto these Ndl. Knit 1 row Ten. 10 over all sts. Bind off. Close second shoulder.

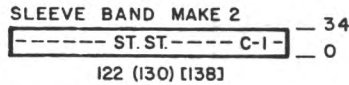
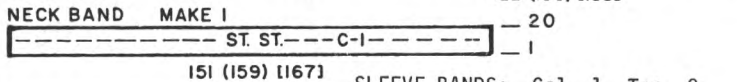

SLEEVE BANDS: Col. 1 Ten. 2
 Bring 122 (130) [138] Ndl. to WP. With WRONG SIDE FACING, hang sleeve edge onto these Ndl. Knit 30 rows. Pick up first row to form hem and bind off.

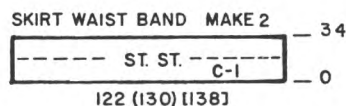
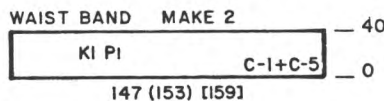
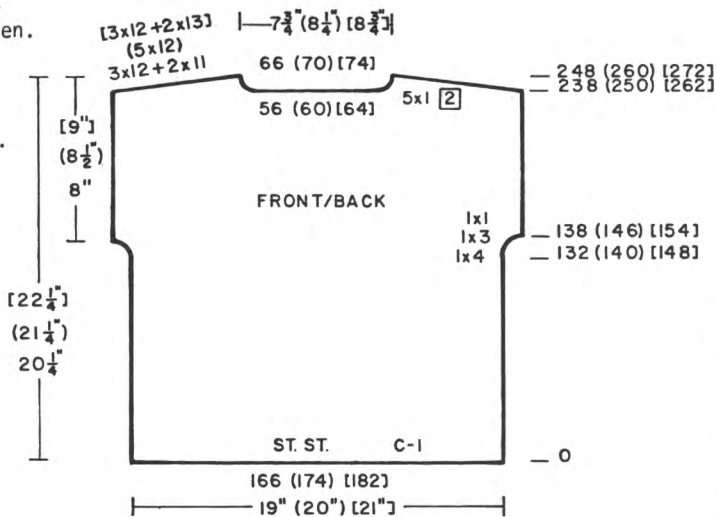
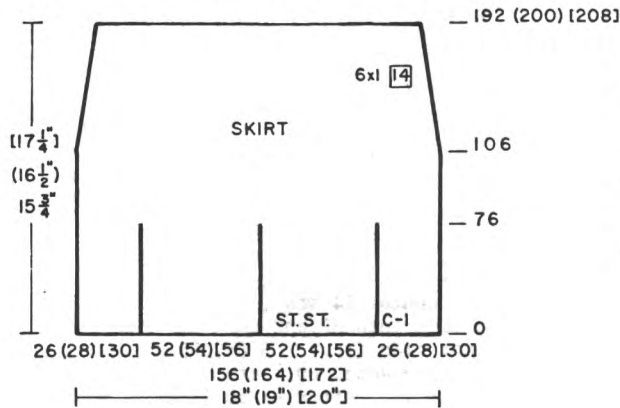

WAIST BAND FOR SKIRT: Make 2.

With Col. 1, cast on 122 (130) [138] sts. Knit 30 rows St. st. Pick up first row to form hem. WITH WRONG SIDE FACING, hang HALF of waist of skirt onto these Ndl. decreasing evenly across. Bind off loosely. REPEAT for 2nd half.

SKIRT: Front and Back the same

NOTE: The bottom of the Skirt is made in sections so be sure to place the first needle to the right or left of -0-. (If you start on the left be sure to begin on Ndl 78 (82) [86] to the left of -0- SEE CHART.

W.Y. Cast on 26 (28) [30] sts. After several rows end with 1 row Ravel Cord to the right. Counter 0. With Color 1 'e' cast on over these Ndl. With T 3, knit 76 rows. Put these Ndl. in HP (or you can put them out of work by manually knitting them back to position 'A').

SECOND PANEL ON LEFT.

W.Y. cast on same as before, 52 (54) [56] sts. After Ravel Cord row, Counter 0 With Col. 1, 'e' cast on over these Ndl. Knit 76 rows. Put these sts. in HP or back to 'A' (out of work) position. FOLLOW THE CHART for the 2 Panels on the right same method as before. When 4th Panel is completed, bring all 156 (164) [172] sts. into WP.

Continue in St. st. over all sts. After R 106, ON EACH SIDE, decrease 1 st. every 14th row 6x. After R 192 (200) [208], remove on W.Y.

CHART FOR PLEAT SECTION MAKE 6

C-1	4R	} 3x PAT.
C-4	2R	
C-1	4R	
C-2	2R	
C-1	4R	
LACE		
C-1	4R	
C-3	2R	
C-4	2R	
C-3	2R	
C-1	4R	
LACE		
C-1	4R	
C-2	2R	
60		

PLEAT SECTIONS: Make 6 the same

NOTE: FOR THE EYELET ROWS, you can transfer every other stitch adjacent needle and leave empty needles in work - or you can use any eyelet Punch Card or Mylar Sheet and Lace Carriage. KH 930 machine owners can program Pat. 103 from Pat. book for each SINGLE ROW OF EYELETS. With Col. 2 'e' cast on 60 sts. Knit 2 rows. With Col. 1, knit 4 rows. MAKE ROW OF EYELETS same as Noted.

With Col. 1, knit 4 rows. Col. 3, knit 2 rows. Col. 4, knit 2 rows. Col. 3, knit 2 rows. Col. 1, knit 4 rows.

MAKE ROW OF EYELETS same as before. Continue to follow Color change as shown on the Chart and REPEAT PATTERN 3x for 1 complete Pleat section.

FINISHING:

See General Instructions. Make inverted pleats. See Photo.



TOP: WAISTBANDS:

K1, P1 Rib: T 3/3 II. Cast on 133 (141) [149] sts. Knit selvedge then knit 60 rows. Transfer Rib sts. to MB. With wrong side facing, hang open sts. of front onto these Ndls. decreasing evenly across. Bind off.

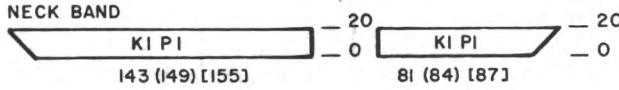
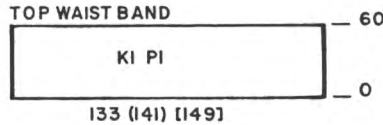

NECKBAND: Make 1 T 3/3 I

Close one shoulder first. Cast on 143(149)[155] sts. Knit selvedge. ON LEFT SIDE inc. 1 st. EVERY ROW 16x. After R 20 transfer Rib sts. to MB. With wrong side facing, hang Back neck and 1 SIDE OF V onto these Ndls. BO.

NECKBAND: Make 1 same T as first band. K1, P1 Rib. Cast on 81 (84) [87] sts. same as before. ON RIGHT SIDE inc. 1 st. EVERY ROW 16x. After R 20, transfer Rib sts. to MB. With wrong side facing, hang other half of V neck onto these Ndls. BO.

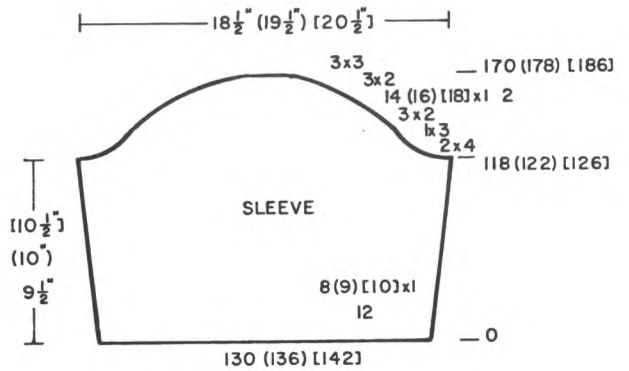

SLEEVES:

CLOSE SECOND SHOULDER FIRST. W.Y. cast on (SEE NOTE). 130 (136) [142] sts. Knit 2 rows first then begin LACE PATTERN. WATCH THE CHANGES from FINE LACE TO REGULAR LACE. ON EACH SIDE, increase 1 st. every 12 rows 8 (9) [10]x. After R 118 (122) [126], SHAPE CAP: PLEASE FOLLOW THE INSTRUCTIONS ON EACH SIDE FOR SHAPING THE CAP IN YOUR SIZE. After R 170 (178) [186], bind off the remaining sts.

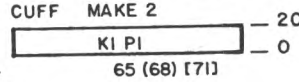

SLEEVE CUFFS: T 3/3 I

K1, P1 Rib: cast on 65 (68) [71] sts. Knit selvedge. Knit 20 rows. Transfer Rib sts. to MB. With wrong side facing, hang open sts. of sleeve onto these Ndls. decreasing evenly across. Bind off.

SKIRT: Make 4. T 3/3 I

FNR: Cast on 138 (146) [154] sts. Knit selvedge. Knit 12 rows. Transfer Rib sts. to MB. Knit 2 rows St. st. then continue in LACE PATTERN WATCH CHANGES FROM FINE TO NORMAL LACE. After R 270 (282) [294], remove on W.Y.

SKIRT YOKE: Make 2 T 3/3 I or Use Garter Carr. T3

Join 2 Panels of Skirt 2x. First. W.Y. Cast on same as for front and Back 120(130)[140] Sts. Change to garment yarn. Transfer every other St. to Ribber. (Or use Garter Carr.) Work K1, P1 Ribbing. ON EACH SIDE inc. 1 St. every 10th row 6x. After R 70, Transfer Sts. to MB if you used Ribber. With wrong side facing, hang half the skirt onto these Ndls. Doubling Sts. evenly across. BIND OFF.

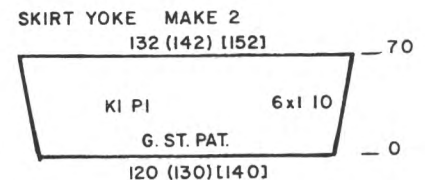

CONTINUED NEXT PAGE

WOMENS TWO-PIECE DRESS

SIZES: 6/8 (10/12) [14]
YARN: Amore
AMOUNT 19 20 21 oz.
TENSION: Lace T 6. Rib. 3/3 II
GAUGE: 15.5 sts. 24 Rows = 2"

Make on any Standard or Electronic machine with Lace Carriage. COMPUKNIT III owners, use Pattern 215 from Pat. Book. Pattern is a combination of Regular and Fine Lace. K1, P1 Ribbing for bands.

NOTE: For all sections which specify Waste Yarn (W.Y.) cast on, follow these instructions. W.Y. cast on. After 7 to 9 rows, knit 1 row with Ravel Cord to the RIGHT (LEFT). Turn Row Counter to 0, change to garment yarn and knit section.

TOP FRONT:
W.Y. cast on 150 (160) [170] sts. (SEE NOTE). Knit 2 rows St. st. BEFORE beginning to use Lace Carr. **NOTE:** Please WATCH FOR SYMBOLS ON LEFT SIDE OF CARD SHOWING CHANGES FROM FINE LACE TO REGULAR LACE. Knit in Pat. to R 150 (158) [166]. Divide in Center. Remove the sts. on the LEFT onto W.Y. or you can knit them back to 'A' (out of work) position. MARK PATTERN ROW and NEEDLE BED if you removed the sts. Complete the right side first. *ON NECK EDGE, BO 1 st. every 5th row 19 (20) [21]x, BUT AT THE SAME TIME AFTER R 172 (180) [188], SHAPE ARMHOLE: BO 3 Sts. 2x, 2 Sts. 2x. 1 st. EOR 4 (6) [8]x, 1 st. every 4th row 2x. After R 248 (260) [272], bind off or remove on W.Y. Bring the sts. on the left back to W.P. (or hang the sts. back on to the marked needles). Turn Row Counter back to 150 (158) [166] and complete the left half. Follow instructions from *.

TOP: BACK:

Work the back the same as front but omit the neck shaping. After R 248 (260) [272], Mark for Neck opening Bind off or remove on W.Y.

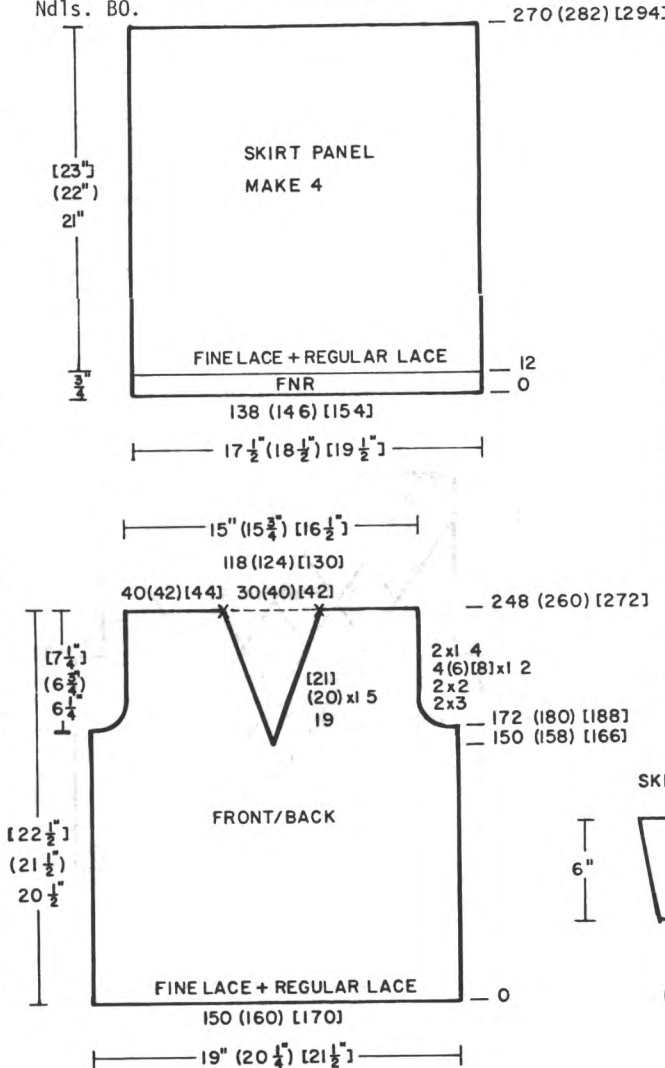

SKIRT WAIST BAND MAKE 2 — 30
 ST. ST. — 0
 114 (122) [130]

SKIRT WAISTBAND: Make 2

Bring 114 (122) [130] Ndl. to WP. With wrong side facing, hang open sts. of cast on edge of Yoke onto these Ndl., decreasing evenly across. With T 6, knit 30 rows St. st. Pick up first row to form hem and bind off.

FINISHING:

See General Instructions.

CHART FOR COMBINATION LACE

NORMAL LACE	12R	8
FINE LACE	8R	0

Normal Lace

Fine Lace

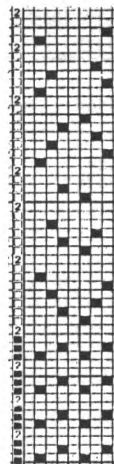
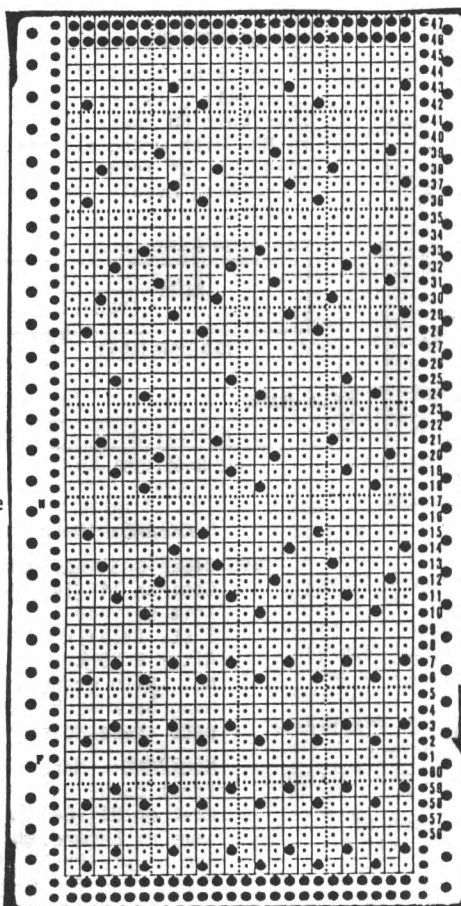

IMPORTANT NOTE:

To change the Lace Change Lever to either N or F move the lace carriage from outside the left mark to inside then change either from Fine Lace to Normal Lace or from Normal Lace to Fine Lace.

621

WOMENS YOKE SWEATER

SIZES: 8/10 (12/14)
 YARN: Venetia = Col. 1 2 lbs. } All Sizes
 Mirage = Col. 2 2 Spools }
 Capriccio = Col. 3 2 Balls }
 TENSION: 10+ for Pattern
 5/5 I Rib. USE 2 STRANDS Venetia
 GAUGE: 13 sts. 19 Rows = 2"
 Notions: 4 Dozen Beads

Make on the KH 910 Machine with Ribber.
 Fair Isle Pattern on Yoke & Sleeves.
 Bands are K1, P1 Ribbing.



FRONT & BACK: The same.

K1, P1 Rib. With Col. 1 (use 2 strds. Venetia) cast on 131 (137) sts. After regular selvedge, change to T 5/5 I and knit 40 rows. Transfer Rib sts. to MB. Add 1 st. on the right side. Continue in Stockinette stitch using 2 strds. Venetia PLUS 1 strd. Mirage together. Knit to R 71 (81). Carr. on the LEFT. SET PAT. No. 1 and knit 1 row to the right to set Ndl. Work Fair Isle Pat with Col. 3 in Feeder B. Knit to R 132 (138). ON EACH SIDE, bind off 9 sts. Continue in Pattern to R 220 (230). With W.Y., mark for Neck Opening. Bind off or remove each section onto W.Y. REPEAT FOR BACK SECTION.

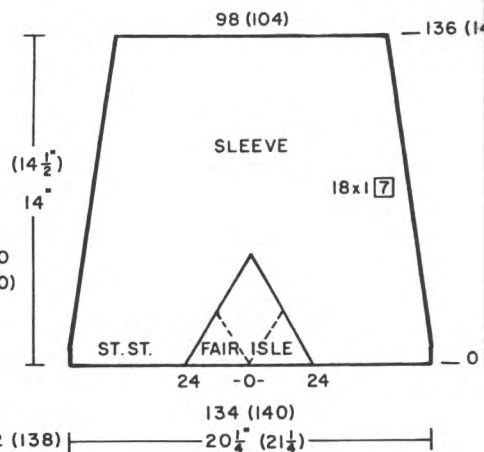
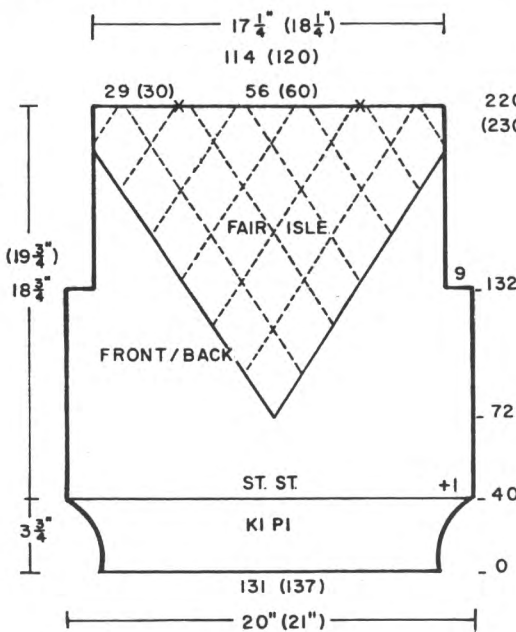

JOIN BOTH SHOULDERS THEN WORK SLEEVES:

Bring 134 (140) Ndl. to WP. With wrong side facing, hang arm edge onto these Ndl. (PLEASE MAKE SURE THE FAIR ISLE DESIGN WILL BE CENTERED OVER THE CENTER 48 NDLS. SET PATTERN and be sure to follow SLEAVE PROGRAM EXACTLY so the Pattern will be knit from top to bottom. AT THE SAME TIME, ON EACH SIDE, decrease 1 st. every 7th row 18x. After R 136 (140), remove remaining sts. on Waste yarn.

CUFF: 2 Strds. Venetia together.
 K1, P1 Rib. T-5/5 I.
 Cast on 49 (53) sts. After regular selvedge, knit 40 rows. Transfer Rib sts. to MB.
 With wrong side facing, hang open sts. of sleeve onto these Ndls. decreasing evenly across. Bind off.

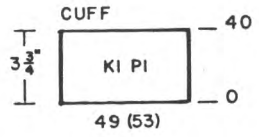

PATTERN 621

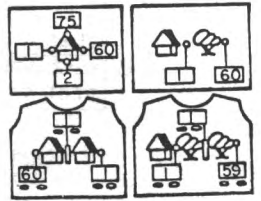
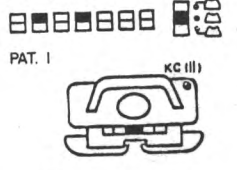

Sleeve PATTERN 621

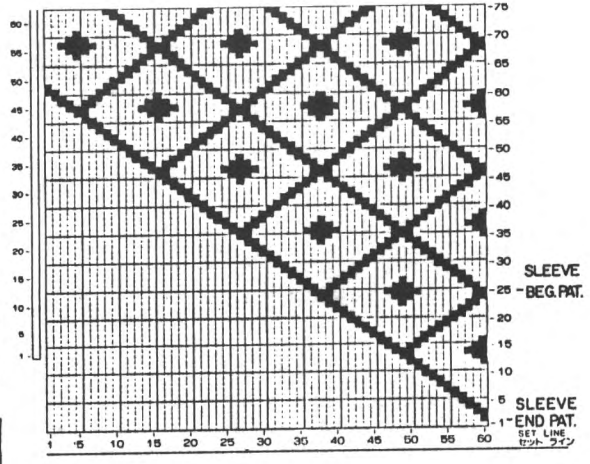
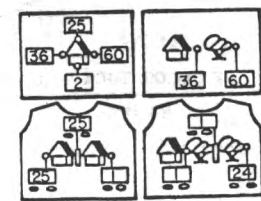
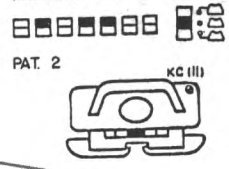

FINISHING:
 See General Instructions. With 2 strds. Venetia, work 1 row single crochet then with Capriccio, work 1 row single crochet around neck opening.

622



BABY SET

SIZES: 6/12 Months (12/18 Months)
YARN: Baby/Baby & Glace
AMOUNT:
 Col. 1 - 1 Cone Baby/Baby all sizes.
 Col. 2 - 1 Cone Glace all sizes.
TENSION: Tuck St. 5, Lace T-4
GAUGE: Tuck St. 13 sts. 31.5 rows = 2"
 Make on the COMPUKNIT III machine with KH 820 COLOR CHANGER.
 Pattern: 2 Color Tuck St. and Lace. Knit side is right side.

376

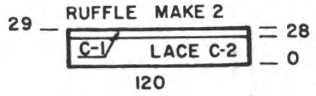
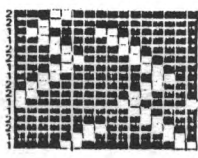

FINISHING FOR BLANKET:

Bring 200 Ndls. to WP. With right side facing, hang open sts. from one end of Blanket onto these Ndls. Take 2 of the 200 Nd1. pieces held on W.Y. and with WRONG SIDE FACING, DOUBLE THE STS. and hang onto these Ndls. Bind off LOOSELY. FOR EACH OF THE LONG SIDES OF BLANKET, USE 2 of the 200 st. pieces and 1 of the 120 st. ruffle sections and hang on the machine in the same way but you will have to do it in two steps as there are only 200 Ndls. on machine. Be sure to double the ruffle sts. for the full effect.

DRESS SKIRT Make 2 - T 5

W.Y. Cast on 170 (178) sts. After several rows end with 1 row Ravel Cord to the right. Change to Col. 2. Knit 5 rows. Change to Col. 1 and knit 1 row to the right. Make row of eyelets for Picot Hem (Transfer EO st. to neighboring Nd1. leave empty Ndls. in Work.) Knit 1 row to the left. Change to Col. 1, knit 5 rows. After R 12, pick up first row to form hem. Knit 1 row to the left. SET TUCK PATTERN (KC 1) same as for blanket. Change Colors every 2 rows. Continue in Pat. to R 160 (176). Remove on W.Y.

BLANKET:

W.Y. Cast on 200 Sts. After several rows end with Carr. on the left. Begin with color 1. Set pattern 376 from Pattern Book. Knit to the right to select Ndls. Push TUCK BUTTONS Knit to the left. Change to Col.2. and continue in Tuck pattern changing colors every 2 rows. After Row 550 Remove on Contrast W.Y.

RUFFLE FOR BLANKET: Lace Pat. 120 Make 2.
 W.Y. Cast on 120 sts. After several rows end with 1 row Ravel Cord to the right. Change to Col. 2, Counter 0. ALWAYS knit 2 rows Stockinette stitch before using Lace Carriage. Knit in Pattern to R 28. Change to Col. 1 and at T 10, knit 1 row. Bind off the crochet method.

RUFFLE FOR BLANKET: MAKE 8
 Lace Pat. 120.

W.Y. cast on 200 sts. same as you did for smaller sections. Work the Lace Pattern the same to R 28. Change to Col 2 and with T 10, knit 1 row. Bind off the crochet method.

34 1/2"

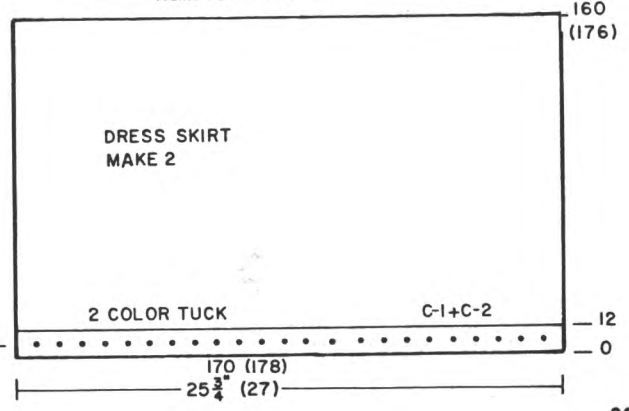
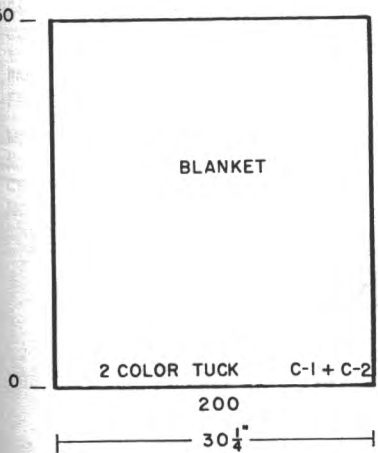
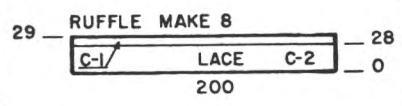

CONTINUED

DRESS NECKBAND: Make 1.

W.Y. cast on 94 (100) sts. After several rows, end with 1 row Ravel Cord to the right. Change to Col. 2. Counter 0. Work the same as you did for SKIRT HEM, making the eyelets after R 5. After R 12, pick up the first row to form hem. Knit 1 row across then remove on W.Y.

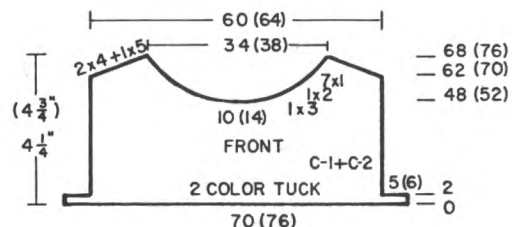
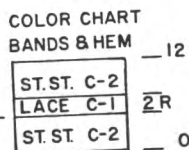
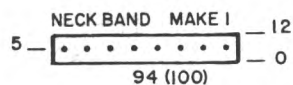

DRESS BODICE - FRONT:

Bring 70 (76) Ndl. to W.P. Hang open sts. of Skirt onto these Ndl. decreasing evenly across. Knit 1 row. SET TUCK PATTERN SAME AS BEFORE. and continue in 2 color Tuck Pattern to R 48 (52). Bind off the center 10 (14) sts. Place the sts. on the left to HP and complete the right side first. *ON NECK EDGE, bind off 3 sts. 1x, 2 sts. 1x, 1 st. 7x BUT AT THE SAME TIME, after R 62 (70), SHAPE SHOULDER: Bind off or use short row method, 4 sts. 2x, 5 sts. 1x. Bring the Ndl. on the left to WP, Set Correct Pattern Row. Turn Counter back to 48 (52) and complete the left half. Follow instructions from *.

SLEEVES:

W.Y. cast on 84 (90) sts. After several rows, end with 1 Row Ravel Cord to the right. Change to Col. 1 and begin 2 color TUCK PATTERN same as before. After R 30 (36), USING FULL FASHION METHOD, ON EACH SIDE, dec. 2 sts. EOR 12x. After R 54 (60), bind off the remaining sts.

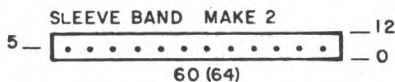
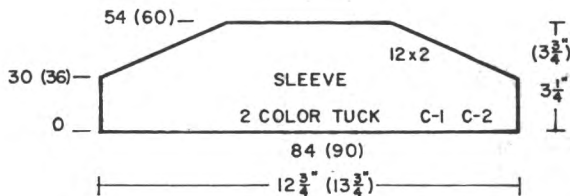

SLEEVE BANDS:

W.Y. cast on 60 (64) sts. After several rows end with 1 row Ravel Cord to the right. Change to Col. 1. Counter 0. Work the same as NECKBAND, making eyelets after R 5, After R 13, pick up first row to form hem. With wrong side facing, hang open sts. of Sleeve onto these Ndl. decreasing evenly across. Bind off.

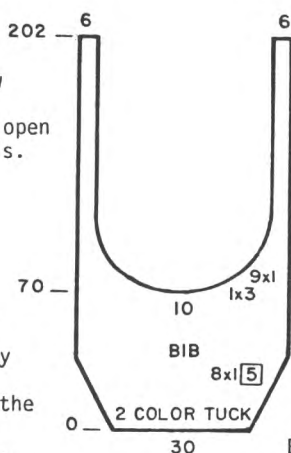
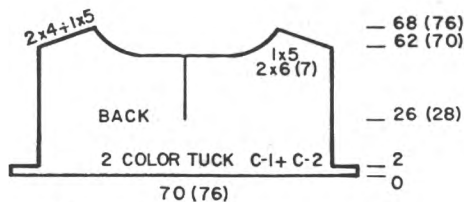

BIB RUFFLE: Make 2.

W.Y. cast on 130 sts. After several rows end with 1 row Ravel Cord to the right. Change to Col. 2. Set LACE PATTERN NO. 120 in 930 Pat. Book. Knit 2 rows then begin Lace Pattern.

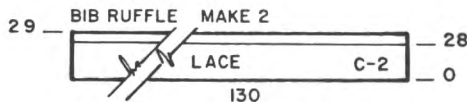

DRESS BODICE - BACK:

Work the back the same as front to R 26 (28). Divide in the center. Place sts. on left to HP and complete the right side first. *Knit to R 62 (70). SHAPE SHOULDER & NECK AT THE SAME TIME, ON NECK EDGE, bind off 6 (7) sts. 2x, 5 sts. 1x. FOR SHOULDER, bind off same as front. Bring the Ndl. on left to WP. Set Correct Pattern Row. Turn Counter back to 26 (28) and complete the left half. Follow instructions from *.

After R 28, change to Col. 1. Knit 1 row then bind off LOOSELY. Bring 65 Ndl. to WP. Hang the open sts. of Bib Ruffle onto these Ndl. doubling the sts. With wrong side facing, hang side of bib onto these Ndl. from center mark to R 90. Bind off LOOSELY. REPEAT FOR 2nd half of Bib Trim.

FLYING HIGH WITH THE 930

If you own a COMPUKNIT III, this latest book from the pen of Mary Louise Norman will be of great value to you. It is well written, easy to understand and filled with detailed explanations regarding the operation of this 'State of the Art' knitting machine.

If you also own a Floppy Disk Drive, you will need the Floppy Data Disk, programmed with 20 tracks of pattern stitches referred to in the book.

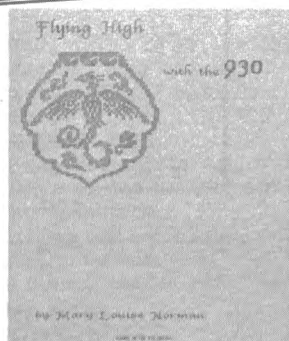
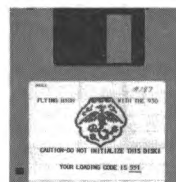

Book only \$18.00
Disk only \$12.00
Combination Book and Disk \$27.00
Shipping costs: Book \$1.60 Disk \$.65
Combination \$1.85

623

NECKBAND: FNR T 6/6 II

FNR: Cast on 114 (120) [126] sts. Knit 10 rows. Transfer Rib sts. to MB. Knit 1 row across then remove on contrast W.Y.

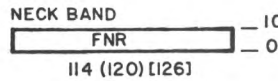

SLEEVES:

W.Y. cast on 122 (130) [126] sts. After several rows end with 1 row Ravel Cord to the right. Change to garment yarn. Counter 0. Continue in St. st.
 Knit to R 144 (150) [156]
 SHAPE CAP: ON EACH SIDE bind off 4 (5) [6] sts. 1x, 4 sts. 1x, 3 sts. 1x, 2 sts. 1x, 1 st. 4x, 1 st. every 4th row 14 (15) [16]x 1 st. every 2nd row 10x, 2 sts. 5x. After R 246 (256) [266] bind off the remaining sts.

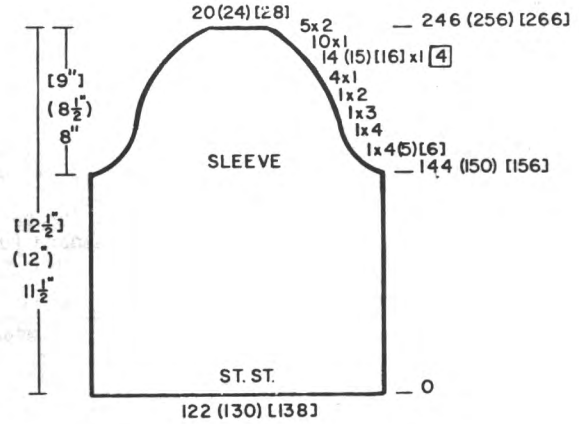

WOMENS DRESS

SIZES: 8/10 (12/14) [16]
 YARN: Venetia
 AMOUNT: 24 oz. 28 oz. 32 oz.
 TENSION: 5 FNR 6/6 II
 GAUGE: 15.5 sts. 25 rows = 2"

Make on any Standard machine with Ribber. Stockinette stitch with Full Needle Ribbing for Bands.

BACK:

FNR: T 6/6 II. Cast on 168 (176) [184] sts. Knit 14 rows. Transfer Rib sts. to MB and continue St. st. Knit 2 rows then work SHORT ROWS. ON OPPOSITE SIDE OF CARR. bring to HP, 40 Ndl. knit 1 row. ON OPPOSITE SIDE OF CARR. bring to HP 40 Ndl. and knit 1 row.
 ON OPPOSITE SIDE OF CARR. bring back to WP 10 sts. 4x ON EACH SIDE. Continue in St. st. and AT THE SAME TIME, ON EACH SIDE, decrease 1 st. every 40th row 6x., every 10th row 7x. After R 346 (350) [354], inc. 1 st. every 10th row 7x.
 After R 432 (440) [448], SHAPE ARMHOLE: ON EACH SIDE bind off 5 (6) [7] sts. 1x, 5 sts. 1x, 4 sts. 1x, 3 sts. 1x, 2 sts. 1x, 1 st. 5 (6) [7]x.
 After R 518 (530) [542], bind off the center 46 (48) [50] sts., put the Ndl. on the left into HP and complete the right side first.
 *ON NECK EDGE, dec. 1 st. EOR 4x. After R 528 (540) [552], bind off the remaining sts.
 Bring the Ndl. on the left to WP. Counter back to 518 (530) [552] and complete the left half. Follow the instructions from *.

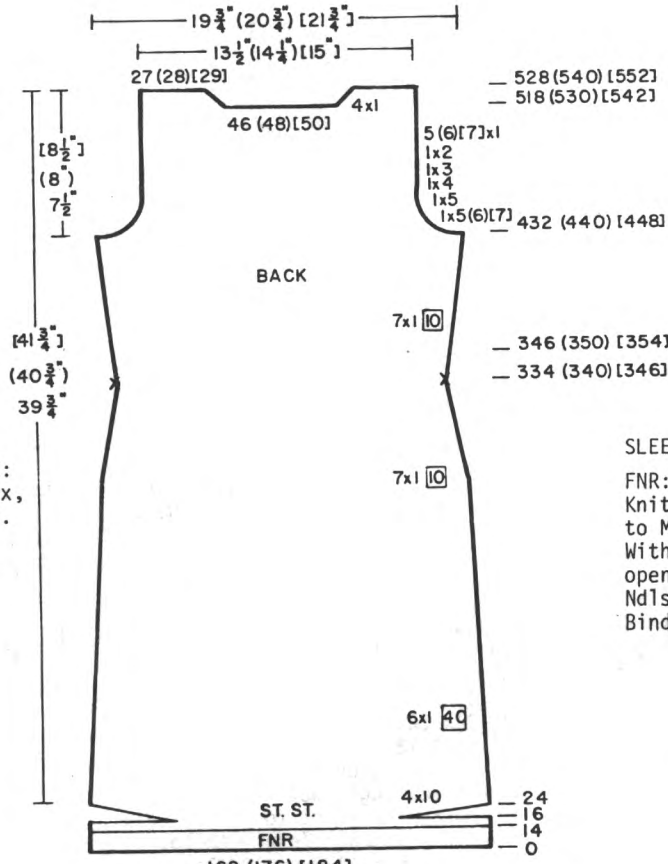

FRONT:

Work the front the same as back to R 498 (508) [518]. Bind off the center 8 (10) [12] sts., put the Ndl. on left into HP and complete the right first.
 *ON NECK EDGE, bind off 2 sts. 10x, 1 st. 3x.
 Bring the Ndl. on left back to WP. Turn Row Counter back to 498 (508) [518] and complete the left half. Follow instructions from *.

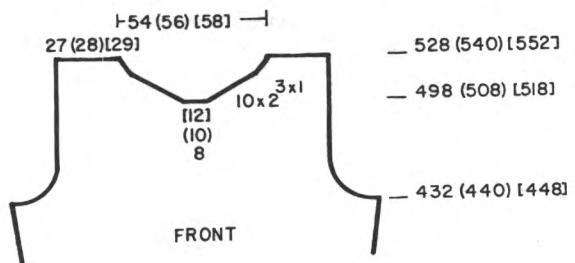

SLEEVE CUFFS: FNR T 6/6 II
 FNR: Cast on 45 (50) [55] sts. Knit to R 26. Transfer Rib sts. to MB. Knit 1 row over all sts. With wrong side facing, hang open sts. of Sleeve onto these Ndl. decreasing evenly across. Bind off LOOSELY.

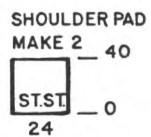

SHOULDER PADS: Make 2.
 'e' cast on 24 sts. Knit 40 rows St. st. Bind off. Roll to form a puff pad for sleeves.

FINISHING:
 See General Instructions.



GIRLS DRESS

SIZES: 5/6 7/8
 YARN: Pearlite
 AMOUNT:
 Col. 1 1 lb. both sizes (Cream)
 Col. 2 1 oz. " (Red)
 Col. 3 1 oz. " (Green)
 Col. 4 1 oz. " (Brown)
 Col. 5 1 oz. " (Purple)
 TENSION: 4 for Main Body.
 3 for Bands and Cuffs
 GAUGE: 14 sts. 23 rows = 2"

Make on the COMPUKNIT III or other Electronic machine. Designs are isolated Single Motifs except for Waistband which is all over Fair Isle. No ribbing. Different Motifs can be chosen to adapt to the standard Punch Card machines.

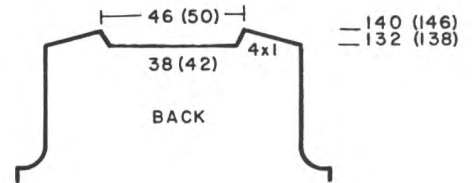

BACK BODICE:

Work the back the same as front (but omit the Single Motifs) to R 132 (138). Bind off the center 38 (42) sts. place the sts. on the left in HP and complete the right side first. *SHAPE SHOULDER AND NECK AT THE SAME TIME. FOR SHOULDER, bind off (or use short row method) 6 sts. 3x. FOR NECK, dec. 1 st. EOR 4x. Bring the Ndl. on left to WP, turn Row Counter back to 132 (138) and complete the left half. Follow instructions from *.

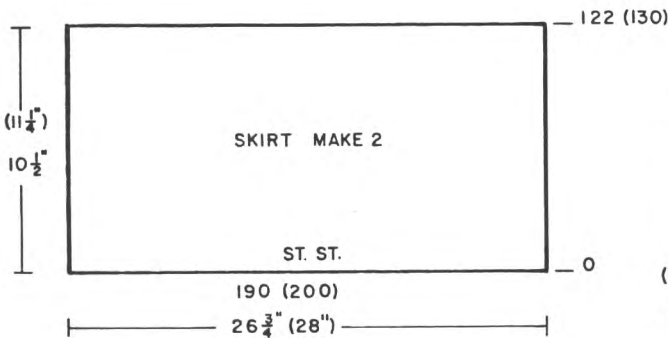

SKIRT: Make 2 section.

W.Y. cast on 190 (200) sts. After several rows end with one row Ravel Cord to the right. Change to Col. 1 and continue in St. st. After R 122 (130) remove on contrast waste yarn.

WAISTBAND: Make 2.

W.Y. cast on 88 (96) sts. same as Skirt. Change to Co. 1 and knit 3 rows St. st.. Carr.on the left. Program Pat. 53. Selector 1. Press UP ARROW 6 times. (We did not use the first 6 rows of Pat.) Begin on R 7. Set Carr to KC I and knit 1 row to the right. Continue in Fair Isle Pat. Col.1 & 2. Knit 4 rows, remove Col. 2 and add Col. 4. Knit 3 rows. Remove Col. 4 add Col 3, knit 5 rows. Cancel KC. Knit 3 rows St. st. and REPEAT 1 more time ending with 4 rows St. st. with Col. 1. Remove on contrast Waste yarn.

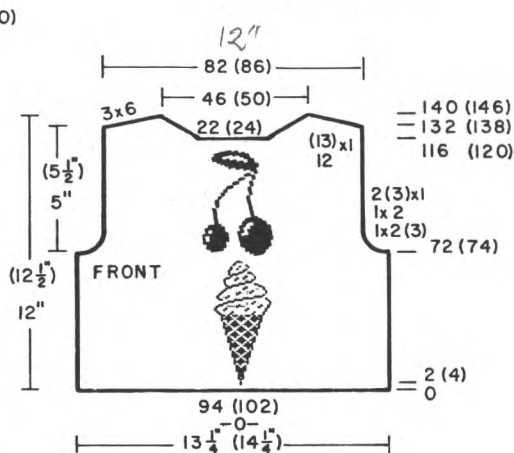
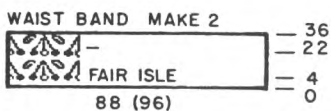

FRONT BODICE:

W.Y. cast on 94 (102) sts. same as for back. Change to Col. 1 and knit 1 (3) rows St. st. Set Program 85 (Selector 2 - Single Motif). and knit to the right to select Ndl. With Col. 1 and 4, knit 40 rows Fair Isle Design making sure to wrap each side of the single Motif (See Instruction Manual). Replace Col. 4 with Col. 5. Knit 30 rows. After R 72 (74) SHAPE ARMHOLE: ON EACH SIDE, bind off 2 (3) sts. 1x, 2 sts. 1x, 1 st. 2 (3)x BUT AT THE SAME TIME, after R 72 (74) knit 1 row to the LEFT. SET PROGRAM 100 (Single Motif setting). Set KC II and knit 1 row to the right to select Ndl. Continue in Fair Isle with Col. 1 and 2. Knit 14 rows. Replace Col. 2 with Col. 4. Knit 16 rows. Replace Col. 4 with Col. 3, knit 10 rows. After R 116 (120) bind off center 22 (24) sts. for neck opening. Place sts. on left in HP and complete the right side first. *ON NECK EDGE, dec. 1 st. EOR 12 (13)x BUT AT THE SAME TIME, after R 132 (138) SHAPE SHOULDER. Bind off (or use Short Row Method) 6 sts. 3x. Bring Ndl. on left back to WP. Turn Counter back to 116 (120) and complete the left half. Follow instructions from *.

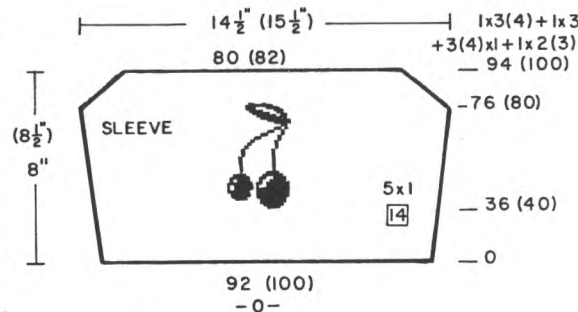
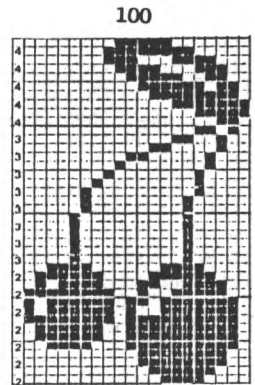

SLEEVES:

W.Y. cast on 92 (100) sts. same as you did before. Change to Col. 1 and continue in St. st. ON EACH SIDE, inc. 1 st. every 14th row 5x BUT AT THE SAME TIME, after R 36 (40) set Pat. 100. Knit in Single Motif using same color sequence as Front Bodice. After R 76 (80) ON EACH SIDE, bind off 3 (4) sts. 1x, 3 sts. 1x, 1 st. 3 (4)x, 2 (3) sts. 1x. After R 94 (100) bind off remaining sts.

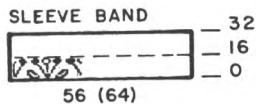

SLEEVE BANDS:

W.Y. Cast on 56(64) Sts. same as before. Change to Col.1 and Knit 1 Row. Set Pat. 53. Selector 1 for all over pattern. BUT KNIT UPSIDE DOWN.(on CompuKnit III Press variation key No. 5.) Set KC and with Col. 1 & 3 knit 5 Rows. Change to Col.1 & 4 Knit 3 Rows. Change to Col.1 & 2, Knit 4 rows. Cancel KC and continue in St. st. with Col.1 ONLY.

After Row 32 Pick up 1st row Col.1 to form Hem and knit 1 row across with T10.

With wrong side Facing Hang sleeve edge onto these Ndl. Decreasing evenly across. Bind off.

SKIRT TRIM: Tension 3.

W.Y. cast on 180 (190) sts. same as before. Change to Col. 1 and knit 14 rows St. st. Pick up first row to form hem. With wrong side facing, hang lower edge of skirt onto these Ndl. and with T 10 knit 1 row. Bind off.

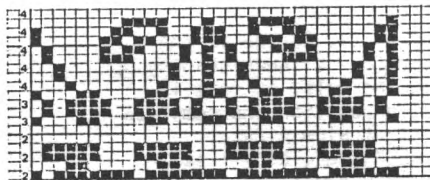
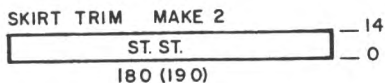

85

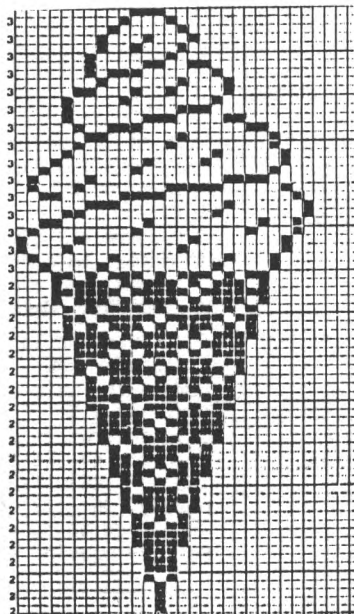

JOIN WAISTBAND TO SKIRT AS FOLLOWS:

Bring 88 (96) Ndl. to WP. With right side facing, hang lower edge of waistband onto these Ndl. With WRONG SIDE FACING, hang TOP edge of Skirt onto these same Ndl. decreasing evenly across. Knit 1 row T 10. Bind off.

JOIN WAIST BAND TO BODICE AS FOLLOWS:

With RIGHT SIDE FACING, hang top edge of Waistband onto 88 (96) Ndl. same as before. With WRONG SIDE FACING, hang lower edge of Bodice onto these Ndl. Knit 1 row T 10 then bind off.

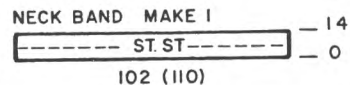

NECKBAND: - Col. 1, Tension 3.

CLOSE 1 SHOULDER:

'e' cast on 102 (110) sts. Knit 14 rows St. st. Pick up first row to form hem. Knit 1 row T 10. Bind off.

FINISHING:

See General Instructions. Join Side seams and shoulder. Set in sleeves. Press lightly.

625

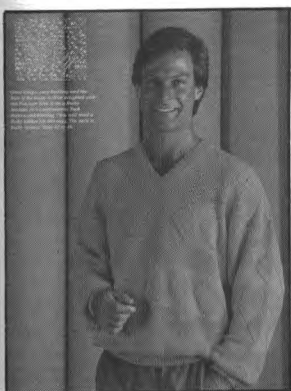

MENS PULLOVER

SIZES: 42/44 (46)
 YARN: Bulky Venetia
 AMOUNT: 32 oz. 36 oz.
 TENSION: 0.2/1 I Ribber
 0.2 Tuck Stitch
 GAUGE: 9.5 sts. 19 rows = 2"

Made on the KH 260 Bulky with Punch Card and Ribber Attachment.

PATTERN:

Attach Ribber to MB. With a marking Pen, mark the CENTER NEEDLE (1st Ndl. to the right of -0-.) Skip 6 Ndl. Mark next 2 Ndl. Skip 6 Ndl. mark the next single Ndl. etc. across to the right. LEFT SIDE: Using same marked center Ndl. Skip 6 Ndl. mark the next 2 Ndl., skip 6 Ndl. mark the next Ndl. etc. across the needle bed on the left.

NOTE: When pattern says to "bring to working position" Normally you would bring the ribber Ndl. to 'B' position but the sts. knit more easily if you bring the Ndl. to 'E' (holding) position. Sts. are less apt to drop.

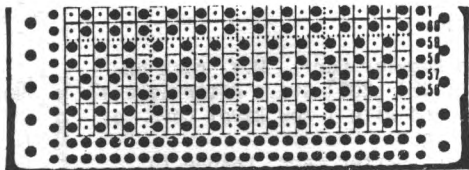

Punch thru Line 37 then 2 rows for connecting

DIAMOND PATTERN: (H Pitch) Main Bed, ALL NDLS. in work. Ribber Bed, see Pattern set-up. ROW 1 - Bring to working position the center st. on Ribber, then the single sts. marked on each side of center.

Knit 2 rows. ROW 3 - Bring to working position, 1 st. ON EACH SIDE of every previously knit stitch. Knit 2 rows.

ROW 5 to 15 are knitted in the same way by bringing to WP the stitches ON EACH SIDE of previously knit sts.

When all Ribber sts. are in working position, knit 2 rows and begin dec. in the same order as increases by doubling sts. on RIBBER ONLY.

After R 30, transfer rib sts. to MB. Knit 1 row to the Left. Set TUCK

PATTERN and knit to the right to select Ndl. then knit in Tuck Pattern (Count the 2 rows knitted before actually starting Tuck Pattern for a total of 32 rows) NOTE: You do not need to replace Ribber Feeder with Standard Feeder but tension will be looser if you do not replace it.

CONTINUED

BACK:

W.Y. cast on 106 (112) sts.
 After several rows end with 1 row Ravel Cord to the right. Change to garment yarn.
 Knit 2 rows. Counter 0.
 Bring Ribber to WP. Pitch on H. Begin Rib then Tuck Pattern.
 After R 86 (92) mark each side for armhole. Continue in Pattern.
 After R 228 (238) with W.Y. mark for Neck opening then bind off or remove on W.Y.

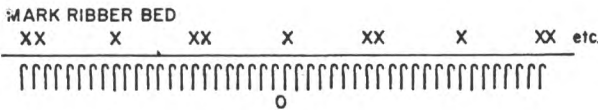
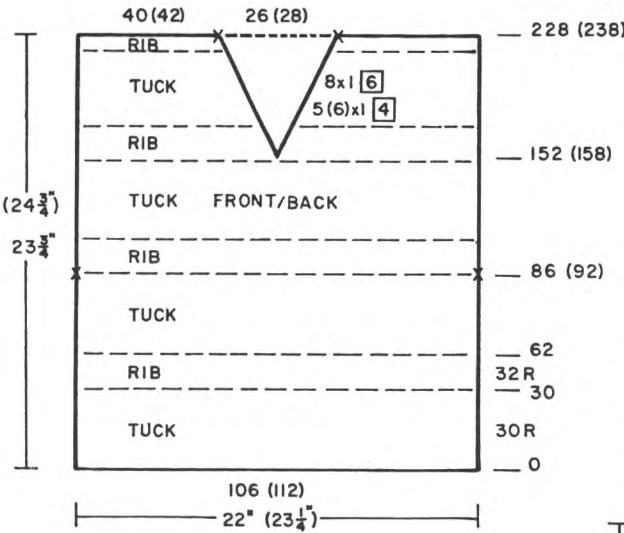

FRONT:

Work the same as back to R 152 (158). Divide in the center for 'V' neck shaping. Place the Ndl's. on left in holding position and complete the right side first.
 *ON NECK EDGE, dec. 1 st. every 4th row 5 (6)x, 1 st. every 6th row 8x. After R228 (238) bind off or remove on W.Y. Bring the ndls. on left to WP. Turn Row Counter back to 152 (158) and complete the left half. Follow instructions from *.

SLEEVES:

Cast on 62 (68) sts. same as for front and back and knit in Pattern to R 60 (66). ON EACH SIDE, inc. 1 st. every 6th row 20x. After R 180 (186), bind off or remove on W.Y.

WAISTBANDS: Make 2 T2/1 II

FNR: Cast on 53 (56) sts. Work 5 circular rows. Knit 28 rows. Remove the main bed sts. on contrast W.Y. Remove the Ribber sts. separately on W.Y.
 By removing the sts. on separate W.Y. the 53 (56) sts. cast on now become 106 (112) sts.
 Join band to open sts. of Front/Back by weaving together.

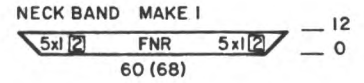
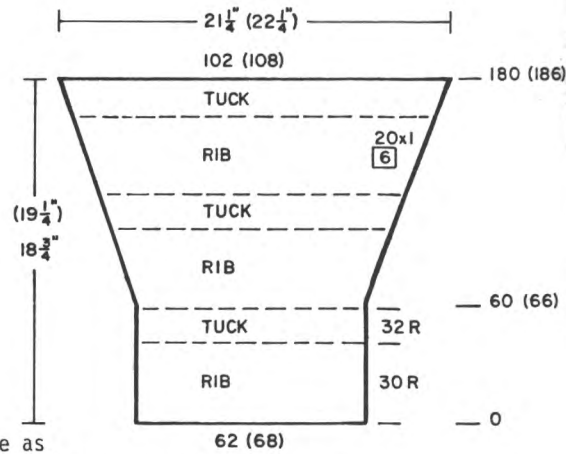
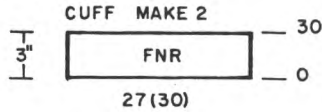
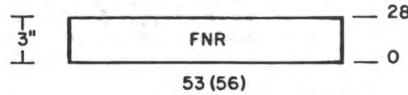

NECKBAND: Make 1 T 2/1 II

FNR: Cast on 60 (68) sts. After regular selvedge, ON EACH SIDE increase 1 st. EOR 5x. After R 12, remove main bed and ribber bed sts. separately on W.Y. as you did for the waistbands.

CLOSE BOTH SHOULDERS. WEAVE NECKBAND to Neck opening same as waistband. T 2/1 II

SLEEVE CUFFS: T 2/1 II
 FNR: Cast on 27 (30) sts. After regular selvedge, knit 30 rows. Remove main bed sts. and ribber sts. separately on contrast waste yarn same as before. Weave to open sts. of sleeve edge same as waistband.

FINISHING:

See General Instructions.

626

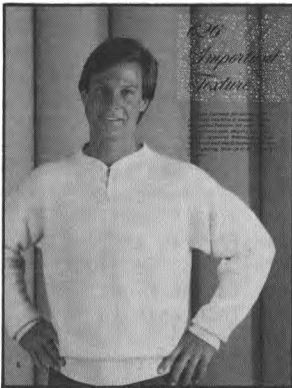

MENS PULLOVER

SIZES: 38/40 (42/44) [46]
 YARN: Regia
 AMOUNT: 11 12 13 Balls
 TENSION: Garter Carr. T 4
 Ribbing: See Instructions.
 GAUGE: Pat. 17.5 sts. 31 rows = 2"

Make on standard Punch Card or Electronic Machine.

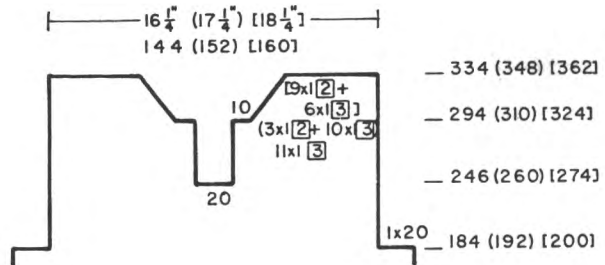

FRONT:

With Regular Carr., W.Y. cast on 184 (192) [200] sts. After several rows end with 1 row Ravel Cord to the right.
 Connect Garter Carr. Change to garment yarn. Machine counter 0. Set Pattern. T 4.
 Knit to R 184 (192) [200]. ON EACH SIDE, bind off 20 sts. After R 246 (260) [274] bind off the center 20 sts. MARK CARD. Place the sts. on the left to 'A' (OUT OF WORK) position by knitting them back with a Ravel Cord. Complete the right side first.

*Knit to Row 294 (310) [324]. ON NECK EDGE, bind off 10 sts. then 1 st. every 3rd row 11x (1 st. EOR 3x, 1 st. every 3rd row 10x) [1 st. EOR 9x, 1 st. every 3rd row 6x].
 After R 334 (348) [362] bind off or remove on W.Y. Bring the Ndl's. on the left back to WP. Turn Counter back to 246 (260) [274], SET PATTERN TO CORRECT ROW and complete the left half. Follow instructions from *.

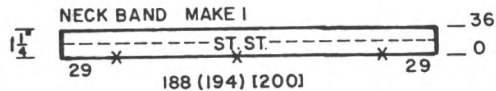
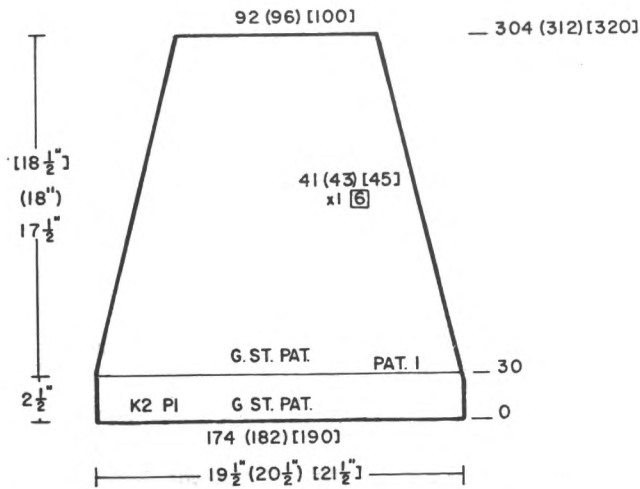
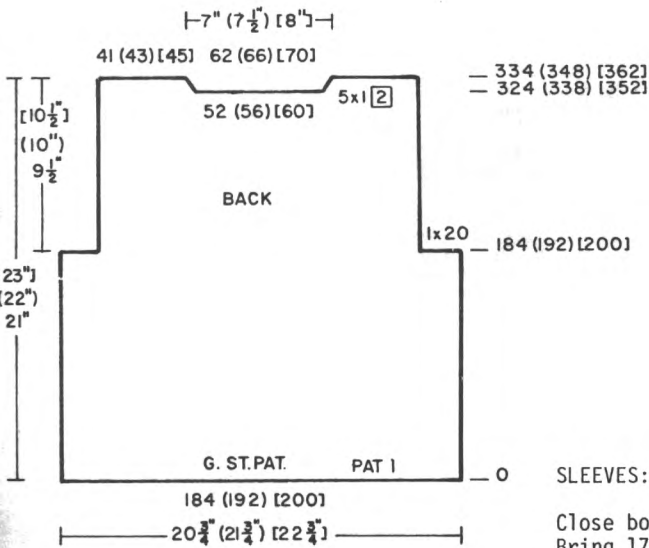

BACK:
Work the back the same as front to R 184 (192) [200].
ON EACH SIDE, bind off 20 sts.
After R 324 (338) [352], BO the center 52 (56) [60] sts.
Place the sts. on the left to the OUT OF WORK POSITION as you did before and complete the right side first.
*ON NECK EDGE, dec. 1 st. EOR 5x.
After R 334 (348) [362] BO or remove remaining sts. on W.Y.
Bring the Ndl. on the left back to WP. Turn Counter back to 324 (338) [352], Set Pattern on the Correct row and complete the left half. Follow instructions from *.

Close both shoulders first. Bring 174 (182) [190] Ndl. to WP. With wrong side facing, hang armhole edge onto these Ndl. With Regular Carr and garment yarn, knit 1 row TENSION 5 from LEFT TO RIGHT. Remove regular Carr. and attach Garter Carr. Set Pattern for K2, P1 ribbing. (CARD NO. 1 B from original set or program your own. TENSION 5, K2, P1 Rib 30 rows. Change to TENSION 4. Set Pat. and continue in Pattern. ON EACH SIDE, dec. 1 st. every 6th row 41 (43) [45]x. After R 304 (312) [320], remove on W.Y.

NECKBAND: Make 1, - REGULAR CARR.
W.Y. cast on 188 (194) [200] sts. After several rows end with 1 row Ravel Cord to the right. Change to Garment yarn and with Ten. 4, knit 36 rows St. st. Pick up first row to form hem. Knit 1 row over the doubled sts. Mark the 29th st. ON EACH SIDE and the center st. with bit of W.Y. then remove the sts. onto contrast waste yarn. WEAVE THE NECKBAND to the Neck edge using the marked sts. as a guide. The 29 sts. on each side go along the lower section of neck opening and at corner, weave 3 sts. together 3x.

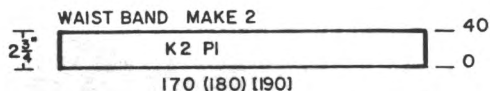

WAISTBANDS: Make 2 - GARTER CARR.
K2, P1 Rib: TEN. 3. Cast on 170 (180) [190] sts. Knit 40 rows. With wrong side facing, hang open sts. of waist onto these Ndl., decreasing evenly across. Bind off.

SLEEVE CUFFS: GARTER CARR. TEN. 3
K2, P1 Rib. Cast on 76 (80) [84] sts. and work same as for Waistbands. Knit 40 rows. With wrong side facing, hang open sts. of sleeve onto these Ndl., decreasing evenly across. Bind off.

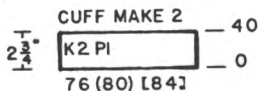

FINISHING:
See General Instructions. Crochet Button loops and sew on Buttons. See Picture.

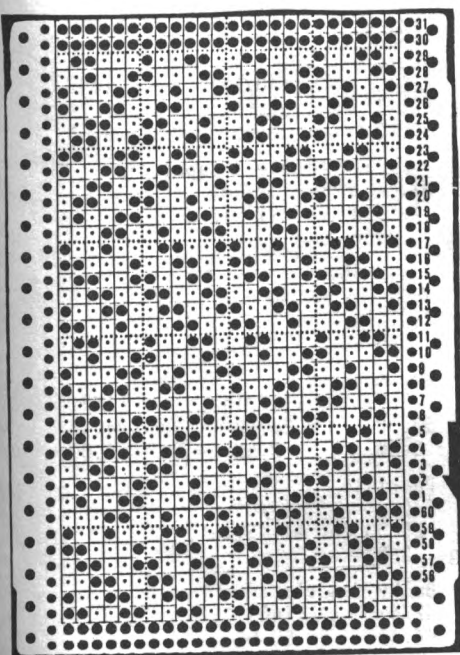

Knitting News

PRACTICAL KNITTING HINTS

VOLUME 21, No. 3

STANDARD METHOD OF KNITTING FAIR ISLE DESIGNS WITH NO FLOATS ON THE BACK. See Pattern 612 this issue.

In Volume 21, No. 1 we listed a special method, but this one is just a bit easier.

1. Set up the Ribber and KRC Color Changer
2. Thread Yarns into the Color Changer.
3. Attach the fine Knitting Bar to Main Bed.
4. Arrange the needles on Main Bed and Ribber for Full Needle Rib. Pitch at H. (Ribber Needles must be EVEN NUMBER) See Vol.21 No.1 for complete Explanation.)
5. Knit several rows or as many as Pattern specifies. End with the Carriage on Far Left.
6. Set or Program your pattern and set the Change Knob to KC II for Electronic Machines & KC for regular Punch Card Machines.
7. With Main Color in Feeder A move the Carriage to the Right to select the Needles.
8. Set the Ribber Carriage and Main Bed Carriage as shown below.

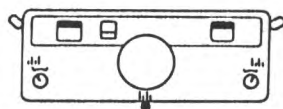
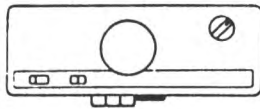

9. Move the Carriage to the left, until you hear a 'Click'. Push the Color Changer Button for desired Color.
10. Knit 2 Rows.
11. Continue in Pattern changing Color every 2 Rows.

NOTE: on the Electronic Machines be sure to Press KRC BUTTON. This will automatically change any Fair Isle Pattern to Double Knit. For 24 St. punch card machines, use KRC 830 pre-punched cards. To convert from regular Fair Isle cards to Multi-color Rib see Manual, pages 21, 22 and 23.

SHAPING THE NECKLINE

When shaping the neckline, and you are using the Garter Carriage, it is important when you are knitting the Right side that the left side be manually knitted back to A Position. This can be done by knitting the Ndl. with Ravel Cord manually back to A position. Take Masking tape or regular Scotch Tape and place a strip in front of the Needles in A position and also place a strip over the hooks of the needles at the front of the needles bed. The Garter Carriage will pass over them easily and there is no worry about them accidentally moving into Working Position.

RIBBER TENSIONS:

Please remember that the tensions we give for Ribbing (at the beginning of a section) is ALWAYS the Tension you use after the regular ribber cast on (Selvedge).

- | | | | |
|-----------------|-------------------------|------|--|
| No. 605 - Yarn: | Pearlite & Venetia | | |
| SIZES: | 8/10 (12/14) | [16] | |
| Price: | \$66.12 68.62 71.12 | | |
| Shipping: | 5.00 5.00 5.00 | | |
| No. 606 - Yarn: | Fiorina Egyptian Cotton | | |
| SIZES: | 8/10 (12/14) | [16] | |
| Price: | 87.75 90.00 92.25 | | |
| Shipping: | 4.50 4.50 4.50 | | |
| No. 607 - Yarn: | Glace & Sewing Thread | | |
| SIZES: | 8/10 (12/14) | [16] | |
| Price: | 59.10 FOR ALL SIZES | | |
| Shipping: | 4.50 | | |

- | | | | |
|-----------------|----------------------------------|---------|--|
| No. 608 - Yarn: | Pearlite | | |
| SIZES: | 8/10 (12/14) | | |
| Price: | 95.00 97.50 | | |
| Shipping: | 5.00 5.00 | | |
| No. 609 - Yarn: | Pearlite and Monofil | | |
| SIZES: | 8/10 (12/14) | [16] | |
| Price: | 86.45 88.95 91.45 | | |
| Shipping: | 5.00 5.00 5.50 | | |
| No. 610 - Yarn: | Venetia & Sewing Thread | | |
| SIZES: | 8/10 (12/14) | [16] | |
| Price: | 37.06 39.84 42.62 | | |
| Shipping: | 3.50 3.50 4.00 | | |
| No. 611 - Yarn: | Papillon & Glace | | |
| SIZES: | 8/10 (12/14) | [16] | |
| Price: | 108.00 All Sizes | | |
| Shipping: | 5.00 | | |
| No. 612 - Yarn: | Fine Venetia | | |
| SIZES: | 8/10 (12/14) | | |
| Price: | 41.70 43.09 | | |
| Shipping: | 4.50 4.50 | | |
| No. 613 - Yarn: | Pebble and Glace | | |
| SIZES: | 6 (8/10) | [12/14] | |
| Price: | 155.50 161.50 167.50 | | |
| Shipping: | 5.50 5.50 6.00 | | |
| No. 614 - Yarn: | Pearlite and Glace | | |
| SIZES: | 8/10 (12/14) | [16/18] | |
| Price: | 88.00 for All Sizes | | |
| Shipping: | 5.00 | | |
| No. 615 - Yarn: | Venetia | | |
| SIZES: | 6/8 (10/12) | [14] | |
| Price: | 47.26 50.04 52.82 | | |
| Shipping: | 4.50 4.50 5.00 | | |
| No. 614 - Yarn: | Venetia | | |
| SIZES: | 8/10 (12/14) | | |
| Price: | 58.38 61.16 | | |
| Shipping: | 4.50 4.50 | | |
| No. 617 - Yarn: | Venetia | | |
| SIZES: | 8/10 (12/14) | | |
| Price: | 51.43 55.60 | | |
| Shipping: | 4.50 | | |
| No. 618 - Yarn: | Pearlite | | |
| SIZES: | 8/10 (12/14) | [16] | |
| Price: | 52.50 55.00 57.50 | | |
| Shipping: | 4.50 4.50 4.50 | | |
| No. 619 - Yarn: | Glace, Angora, Mami Rex & Mirage | | |
| SIZES: | 8/10 (12/14) | [16] | |
| Price: | 75.20 for All Sizes | | |
| Shipping: | 4.50 | | |
| No. 620 - Yarn: | Amore | | |
| SIZES: | 6/8 (10/12) | [14] | |
| Price: | 56.81 59.80 62.79 | | |
| Shipping: | 3.50 3.50 3.50 | | |
| No. 621 - Yarn: | Venetia, Mirage & Capriccio | | |
| SIZES: | 8/10 (12/14) | | |
| Price: | 39.44 for all sizes | | |
| Shipping: | 4.50 | | |
| No. 622 - Yarn: | Baby Baby | | |
| SIZES: | 6 to 18 Months | | |
| Price: | 36.64 | | |
| Shipping: | 4.50 | | |
| No. 623 - Yarn: | Venetia | | |
| SIZES: | 8/10 (12/14) | [16] | |
| Price: | 33.36 38.92 44.48 | | |
| Shipping: | 3.50 3.50 4.00 | | |
| No. 624 - Yarn: | Pearlite | | |
| SIZES: | 5/6 (7/8) | | |
| Price: | 25.00 for All Sizes | | |
| Shipping: | 3.00 | | |
| No. 625 - Yarn: | Bulky Venetia | | |
| SIZES: | 42/44 (46) | | |
| Price: | 44.48 50.04 | | |
| Shipping: | 4.50 4.50 | | |
| No. 626 - Yarn: | Regia | | |
| SIZES: | 38/40 (42/44) | [46] | |
| Price: | 32.89 35.88 38.87 | | |
| Shipping: | 3.00 3.00 3.00 | | |



617 *High Style*

Fitted garments are creeping back to the fashion world of today. Knit a Skirt in Stockinette stitch, a Jacket in a Fair Isle Houndstooth Design. The pockets are simulated and the bands are crochet. Sizes 8 to 14. Venetia is the yarn.



610
Vibrant
Color

enhances a slim two-piece Dress. Knit the Skirt in Stockinette stitch, the long over blouse in Thread Lace. It's very easy to knit in simple straight pieces. Use Venetia and sewing thread.



615

Geometrics

are an excellent choice for a Fair Isle Jacket to wear over the plain Stockinette stitch Skirt. Knit the Jacket on any Electronic machine. The Skirt is Stockinette stitch. Bands are ribbed. Sizes 6 to 14. Venetia is the yarn.

612 *Terrific*

*color blends together for a flowered
Fair Isle Jacket. No floats are on the
back when you use a KR 900 Ribber
where a special technique omits floats.
Knitted with fine Venetia in sizes
8 to 14.*



611

Luminous

Try weaving a sparkling Jacket. The colors change as you move and you can wear it over almost any color dress. It is very easy to knit on a standard machine with weaving ability. Knit it with Glace and weave with Papillon. Sizes 8 to 16.



621

Elegant

A dressy Sweater with a diamond design is accented with beads and will surely bring admiring glances. Knit it with a mixture of yarns - Venetia, Mirage, Capriccio. Sizes 8 to 14.

622

Darling

in her ruffled dress knitted in a Tuck Stitch Pattern with Lace trim. The Bib is separate and the Security Blanket keeps her happy. Sizes 6 to 18 months. Baby/Baby and Glacé for the yarns.



Introducing Lectrolink

*New Rotary type Linker with electric drive.
U.L. approved.*

*Seam a complete garment, perfectly, with
the yarn you used to knit the garment.
Average time 30 minutes.*

*Accommodates up to 220 stitches.
Adjusts to various yarn thickness.*

*Matches neck and front bands,
trims and braids. Does shirring
and gathering, etc., etc.*

*Light in weight and easy to
use. Takes the tedium and
time out of seaming.*



**Order from your local KNITKING dealer, or direct from
KNITKING at 1128 Crenshaw Blvd., Los Angeles, California 90019.
Telephone: (213)-938-2077.**

626

*Important
Texture*

A Garter Carriage for standard or electronic machine is needed to knit this special Pullover for your man. The different neck shaping will meet with his approval. Ribbing is used for the bands and small buttons close the neck opening. Sizes 38 to 46. Rodia is the yarn.



625

Sporty

Great design, easy knitting and the Man of the house will be delighted with this Pullover. Knit it on a Bulky Machine in a combination Tuck Pattern and Ribbing. (You will need a Bulky Ribber for this one). The yarn is Bulky Venetia. Sizes 42 to 46.

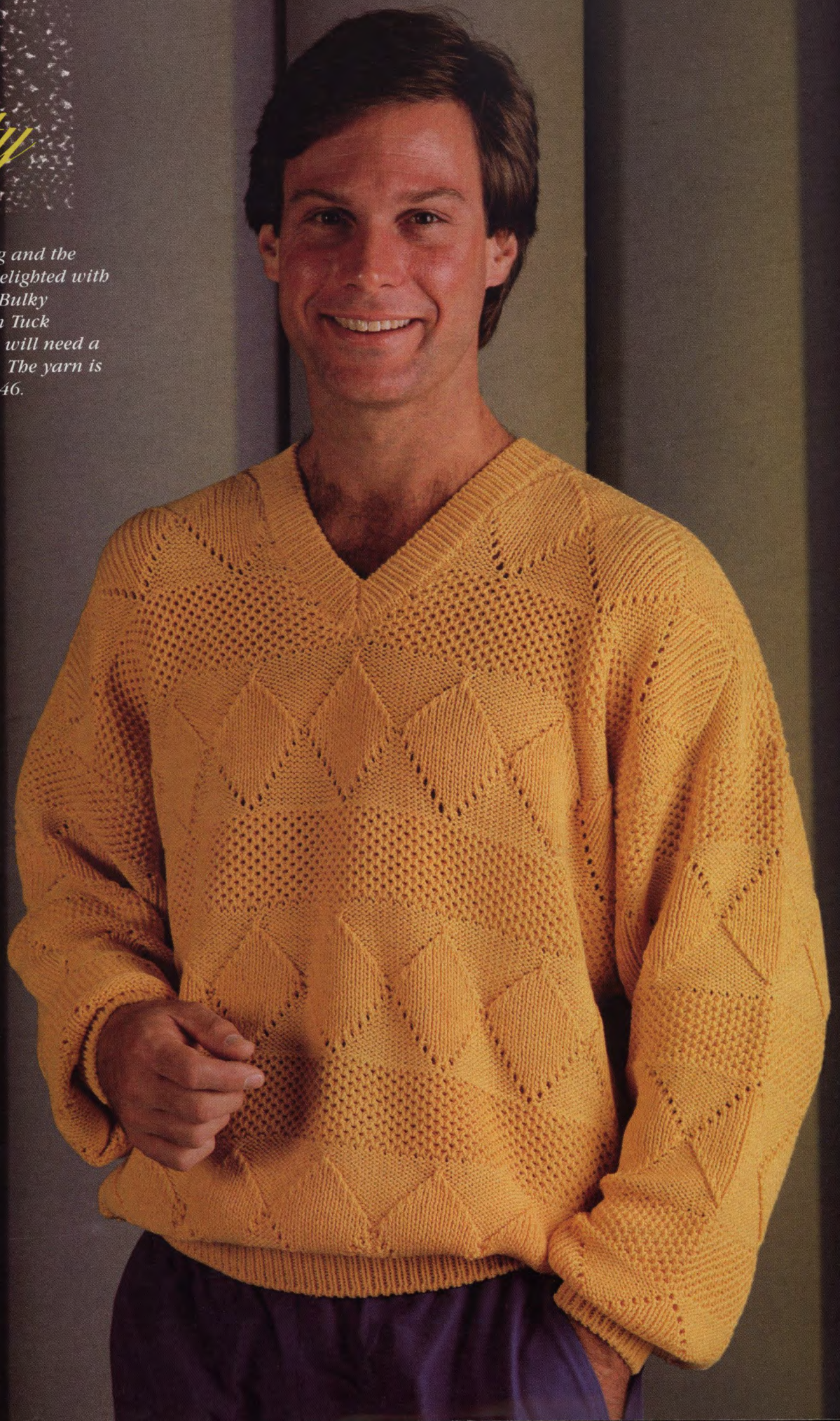

KNITKING Punch Card Programmed Bulky with KR 260 Ribbing Attachment

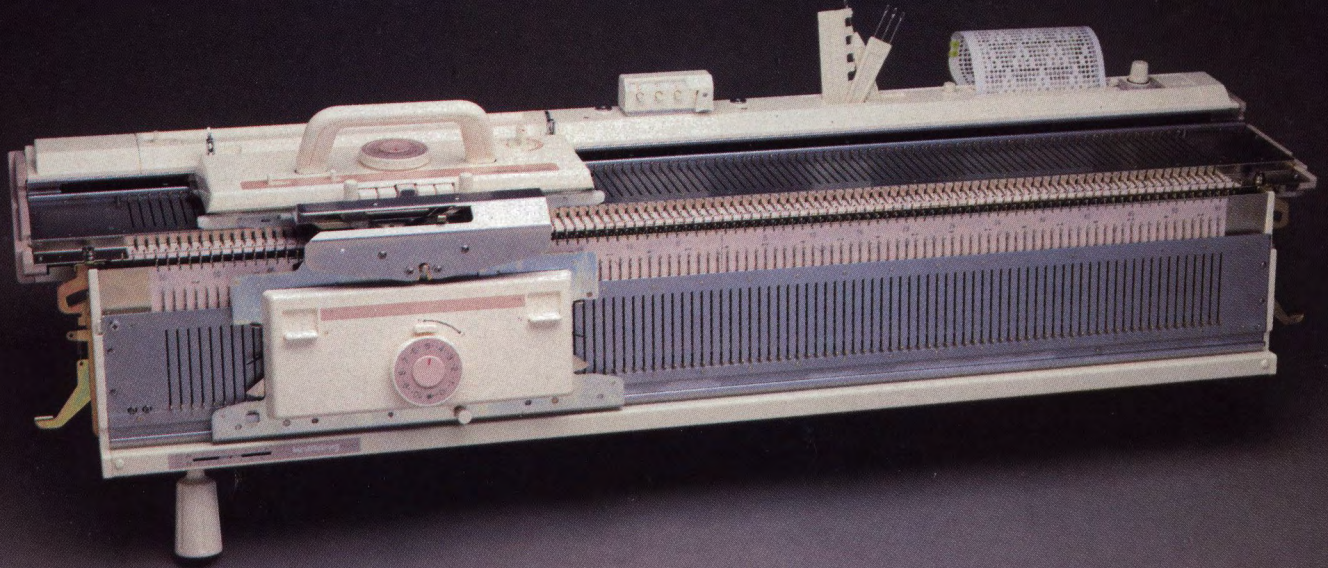

Add a Ribbing Attachment to your KH 260 KNITKING Bulky Knitter and substantially increase its versatility. The KR 260 Ribber allows you to knit all of the standard ribs 1x1, 2x2, 3x1, or any other combination of knit and purl you desire, plus tubular knitting. With 110 needles on the Ribber and 114 needles on the KH 260 Knitter, you have a total of 224 needles. You can knit fully ribbed dresses and sweaters with weights of yarn from fingering up to heavy bulky. You can knit Zig-Zag racking designs, Cable Stitch designs...Herringbone designs, Tuck Stitch Rib designs, Fishermans Rib, etc., etc...

A KR 260 Ribber comes complete with tools, cast on combs, weights, manual and one year limited warranty on parts, detailed instruction and service.

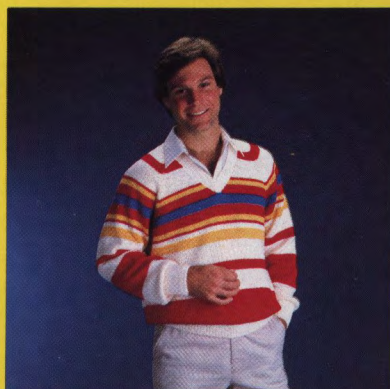



619
Love...

Tennis anyone? Head for the Court and enjoy your game wearing a stunning two piece Tennis Dress. It's easy to knit in Stockinette stitch and sizes are from 8 to 16. The yarn is Glacé with a bit of Angora peeking through the skirt pleats.

FOR UNLIMITED VERSATILITY

MRS J ZEREBECKY
217 EASTERN PKWY
NEWARK NJ 07106

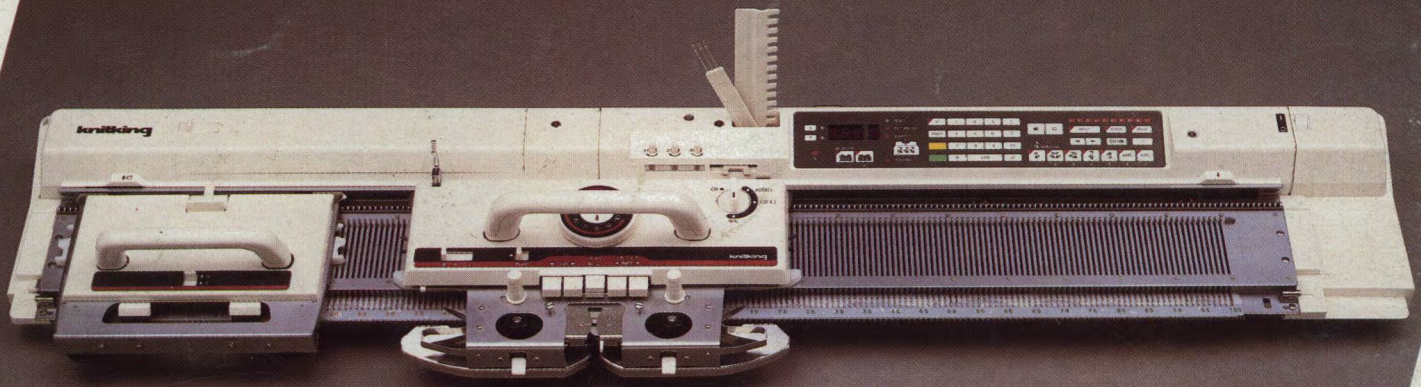

COMPUKNIT III with Lace Carriage and regular Knitting Carriage. Both carriages are standard with the purchase of a COMPUKNIT III. The Lace Carriage knits true Transfer Lace. It automatically knits beautiful yarn-over designs in any combination up to the full 200 needle width of the knitter. It also knits Fine Lace. The Computer permits isolation of Lace designs anywhere you wish in a garment.

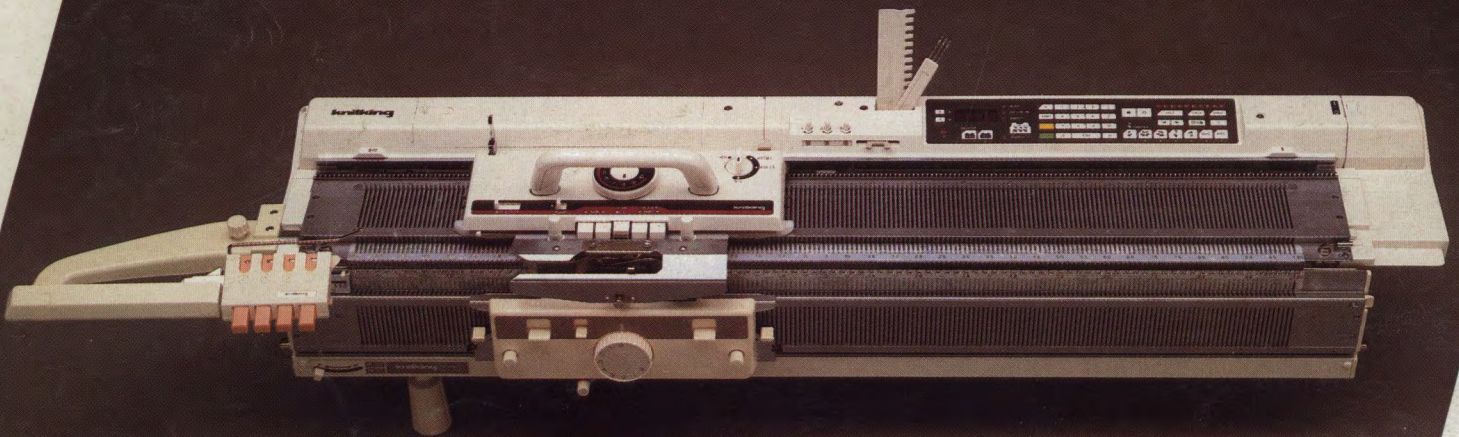

The COMPUKNIT III is illustrated with the KR 900 Ribbing Attachment and the KRC 830 Color Changer (both optional accessories). The Ribbing Attachment knits any combination of knit and purl ribs, racking designs, cable stitches, tubular knitting, etc. Add the KRC 830 Automatic Color Changer and you can knit up to four colors in one row in double knit jacquard. You can also introduce yarns of various textures into a garment. The KHC 820 Color Changer (not shown) operates on the basic machine for the knitting of multi-color designs in Stockinette Stitch.

Order from your local Dealer or direct from **KNITTING CORPORATION**, 1128 Crenshaw Blvd., Los Angeles, California 90019. Tel: 213-938-2077.