

knitking

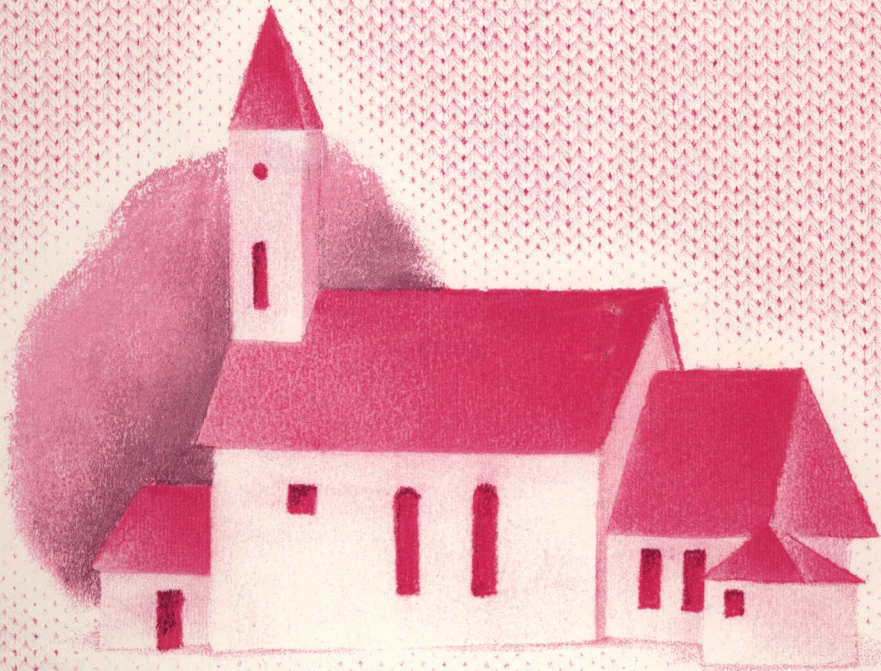

**HOW TO USE
YOUR KNIT-LEADER**

*** THIS SUPPLEMENT COVERS ONLY HOW TO USE THE KNIT-LEADER WHICH IS BUILT INTO THE MACHINE BODY, THEREFORE PLEASE REFER TO THE ORDINARY INSTRUCTION MANUAL FOR THE BASIC OPERATION.**

*** THERE ARE SOME ALTERATIONS REGARDING ACCESSORIES SHOWING IN THE ORDINARY INSTRUCTION MANUAL.**

1. The Row counter is built into the machine body.
2. The Card holder pin is not necessary.
3. Replace the Claw weights, Tools and small accessories into the separate Accessory box.

INDEX

1. Names of parts	K Carriage	1
2. Names of parts	Needle bed	2
3. How to take Tension gauge		3
3-1 Tension gauge		3
3-2 How to knit a tension swatch		3
3-3 How to take a tension gauge		5
4. How to use Knit-Leader		6
4-1 How to set the regulators		6
4-2 How to trace the pattern		8
4-3 How to insert the sheet		9
4-4 How to read the stitch measure scale		10
5. How to make a garment		11
5-1 Directions for knitting		11
5-2 Important points for finishing		13
5-3 Sewing procedure		15

1. Names of parts..K Carriage

CARRIAGE

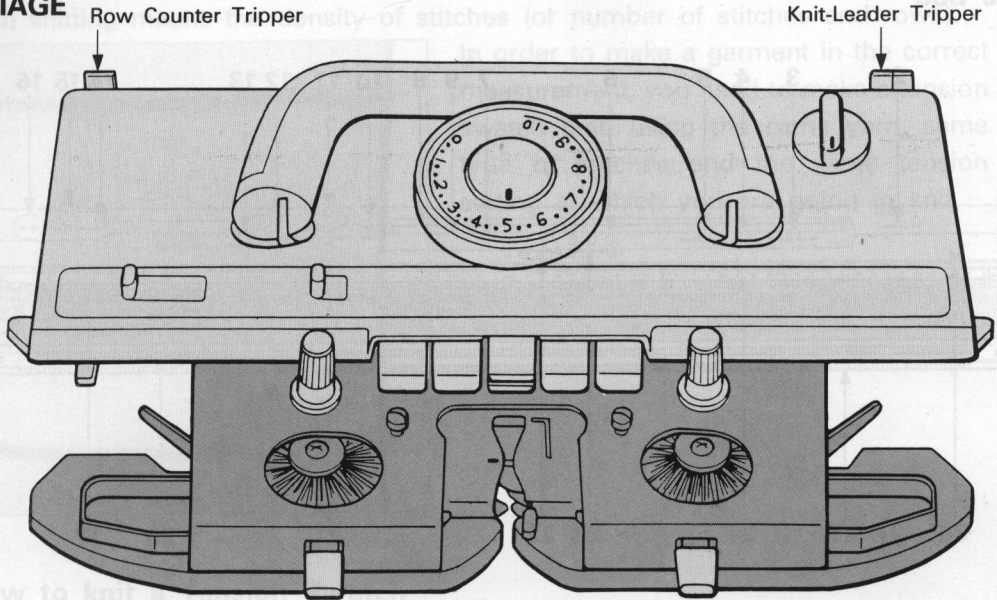

Exclusive accessories for

Translation of sentences on the Sheet

1. Make the drawing so as to set the center of the drawing to the center dotted line of the sheet, which an attached Pen.
2. Make the drawing in the actual size on the right side (mat side) of this sheet.
3. To erase the drawing, please wipe the sheet with damp cloth.
4. Do not fold the sheet.

Sheet Case

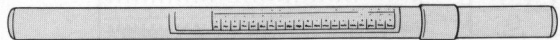

Sheet

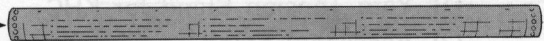

Stitch Measure Scale

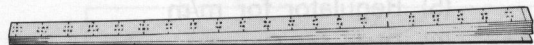

Binding Wire



Sheet Guide

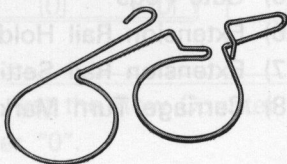

Felt Pen



Accessory Box

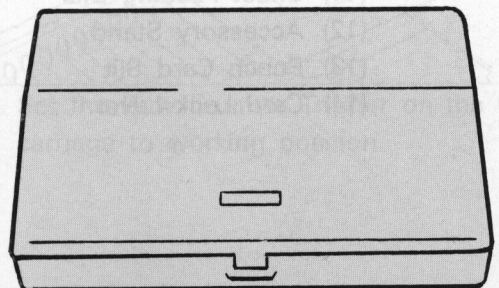

2. Names of parts Needle bed

Needle bed

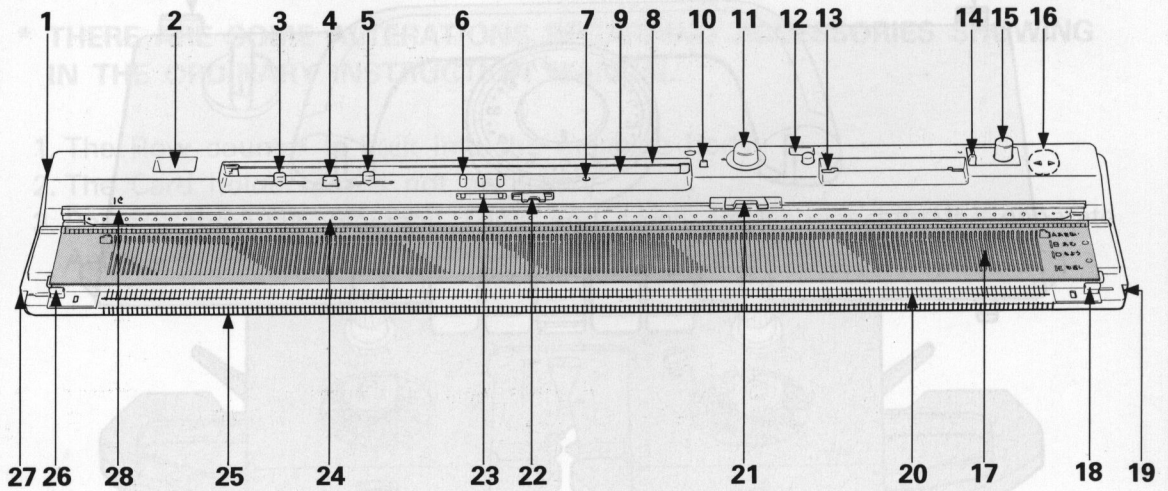

- | | |
|-----------------------------------|----------------------------------|
| (1) Yarn Tension Stand for KHC | (15) Card Feeding Dial |
| (2) Accessory Stand | (16) Direction Indicator |
| (3) Regulator for c/m | (17) Needle Bed |
| (4) Clutch Button | (18) Sponge Bar |
| (5) Regulator for m/m | (19) Yarn Rest |
| (6) Dials for Counter | (20) Needles |
| (7) Yarn Tension Stand Hole | (21) Knit-Leader Feeding Lever |
| (8) Slit for Knit-Leader Sheet | (22) Row Counter Feeding Lever |
| (9) Slit for Stitch Measure Scale | (23) Row Counter |
| (10) Sheet Button | (24) Rear Rail |
| (11) Sheet Feeding Dial | (25) Gate Pegs |
| (12) Accessory Stand | (26) Extension Rail Holder |
| (13) Punch Card Slit | (27) Extension Rail Setting Hole |
| (14) Card Lock Lever | (28) Carriage Turn Mark |

3. How to take Tension gauge

3-1. Tension gauge

Gauge in knitting means the density of stitches (or number of stitches and rows).

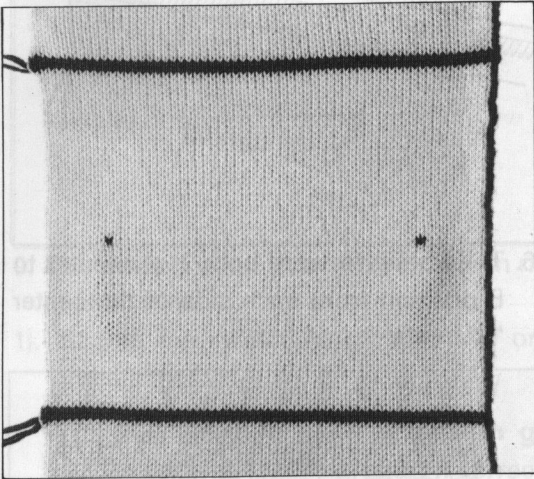

In order to make a garment in the correct measurement, you need to make a tension swatch first, using the same yarn, same type of stitches and the same tension setting at which you are going to knit.

3-2. How to knit a Tension Swatch

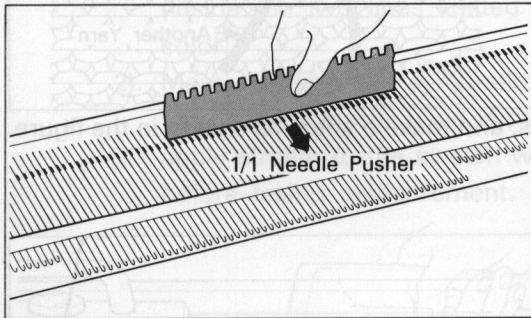

1. Using the 1/1 Needle Pusher, bring forward 60 needles to B position, 30 needles on either side of the center mark "0".

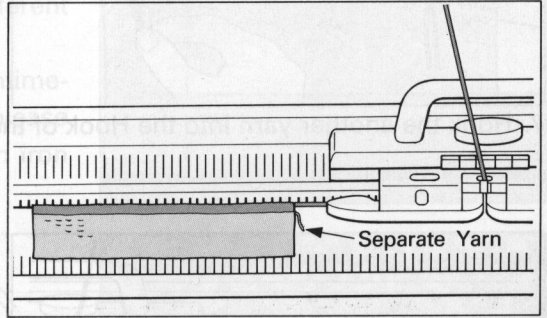

2. Using the Cast-on Comb, knit 60 stitches a cross and about 10 rows. Then knit two rows using a different color of yarn.

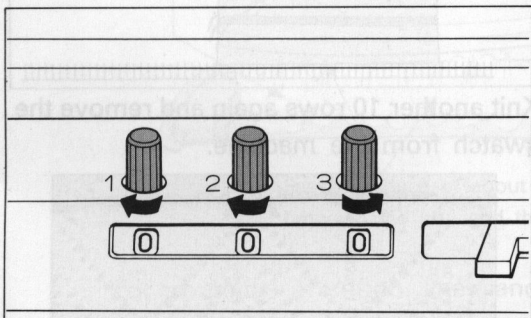

3. After knitting, set the Row Counter Dial to the number "0".

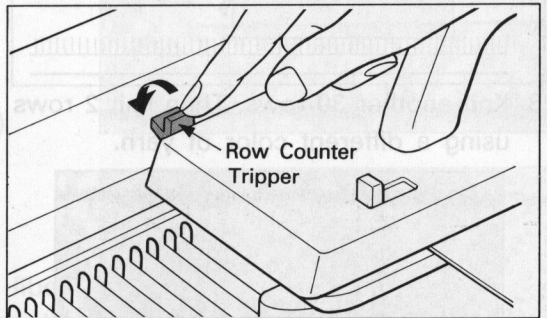

4. Set the Row Counter Tripper on the K carriage to working position.

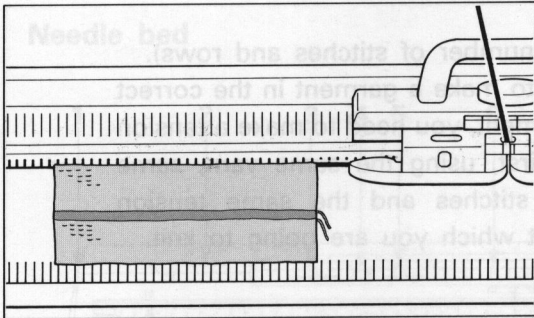

5. Knit 30 rows with the original yarn.

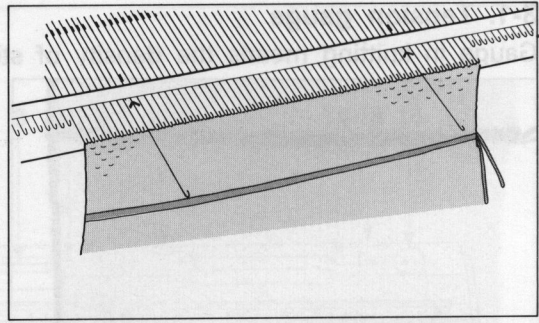

6. Then bring forward both 21st needles to E position from each side of the center "0" mark.

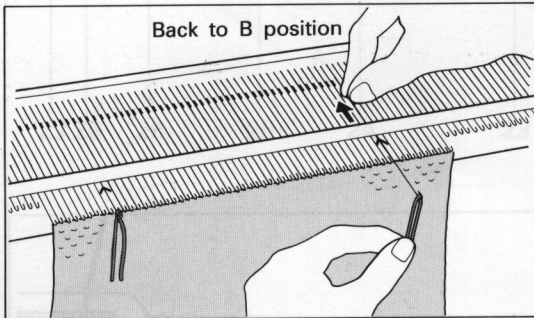

7. Hook the another yarn into the Hook of these needles, and make a stitch as shown in the figure.

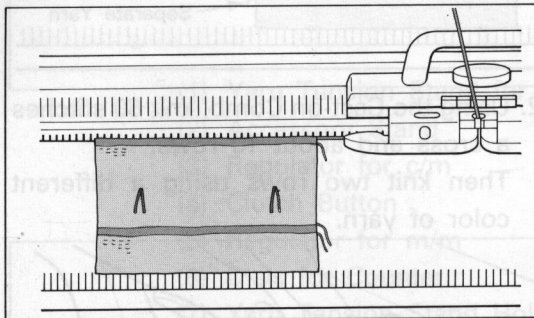
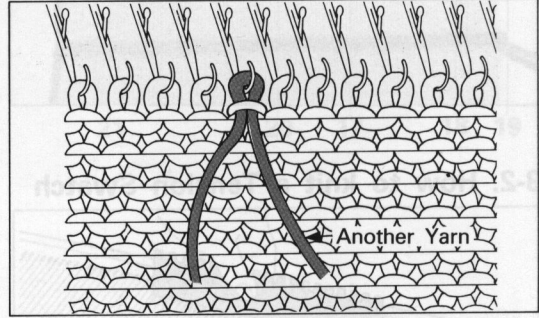

8 Knit another 30 rows. Then knit 2 rows using a different color of yarn.

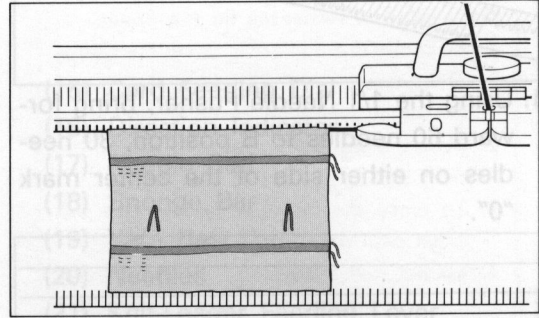

Knit another 10 rows again and remove the swatch from the machine.

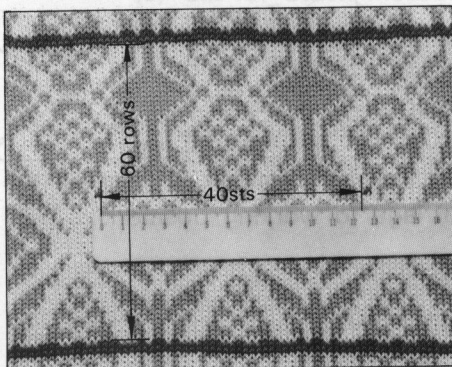

If you want to knit a garment with pattern stitches, make the tension swatch in the same pattern as the garment.

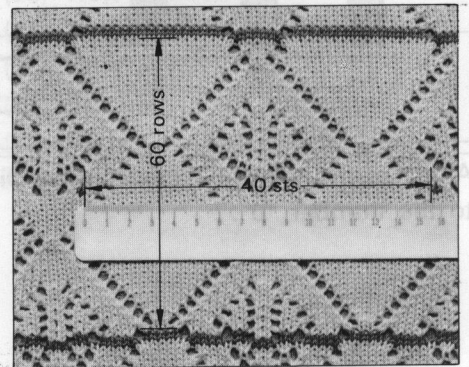

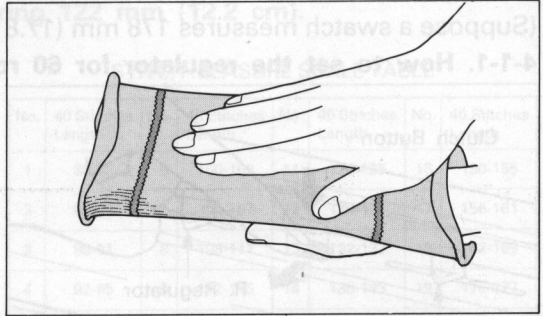
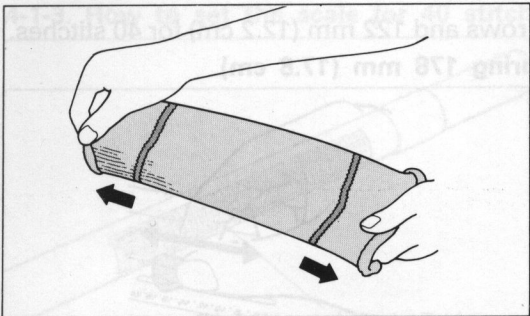

9. This swatch is in a stretched condition right after it has been knitted and must be restored to its natural state.

1). Stretch the swatch lengthwise two or three times.

2). Pat lightly with your hands to restore the stretched stitches.

3-3. How to take a tension gauge

In order to knit your pattern correctly, measure the tension swatch accurately.

- 1). Measure the length of 60 rows in centimeters, (inside the two lines knitted with a different color).
- 2). Measure the width of 40 stitches in centimeters. If the material used is pure wool, please apply steam to the swatch with a steam iron before taking measurement.

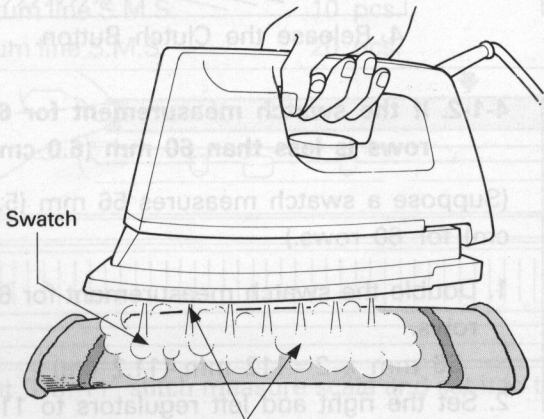
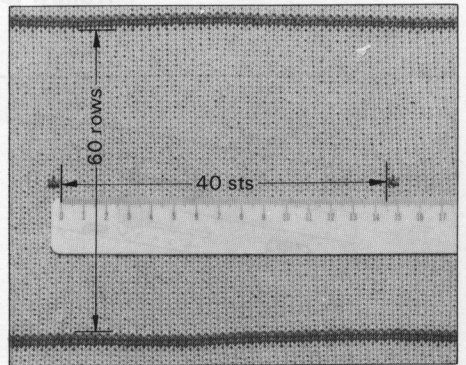

Leave a space of about 1 cm. between the iron and the swatch.

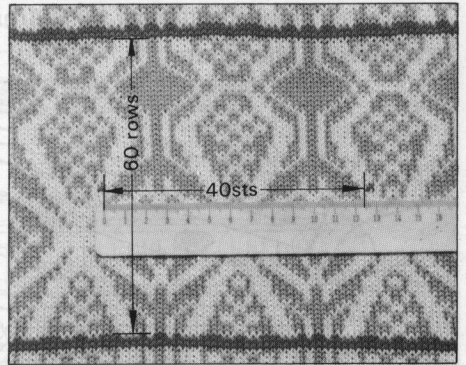

For swatches of cotton, linen and synthetic fiber yarn, more accurate measurements will be obtained if the swatch is washed and dried as the garment will be before taking measurements. For better accuracy, it is preferable to take the above-mentioned measurements at 3 different places on the swatch and use the average figure.

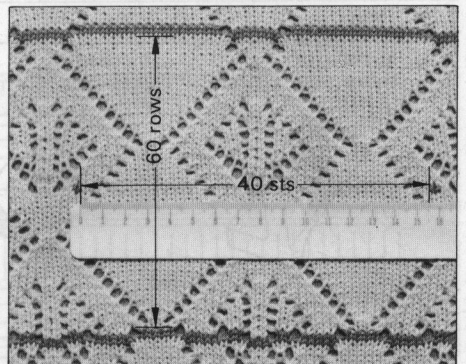

4. How to use Knit-Leader

4-1. How to set the regulator

(Suppose a swatch measures 178 mm (17.8 cm) for 60 rows and 122 mm (12.2 cm) for 40 stitches.)

4-1-1. How to set the regulator for 60 rows measuring 178 mm (17.8 cm).

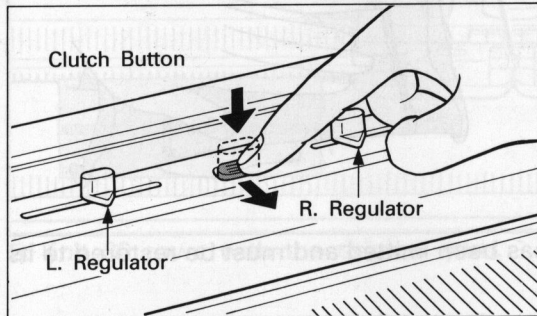

1. Pressing and pulling the Clutch Button, it will be locked.

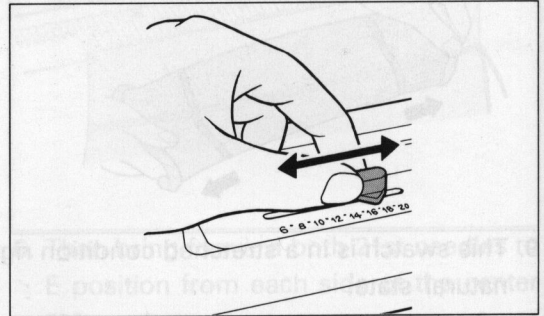

2. Depress the Clutch Button with your hand and hold it down. Set the left regulator to 17 (cm) shown in the figure.

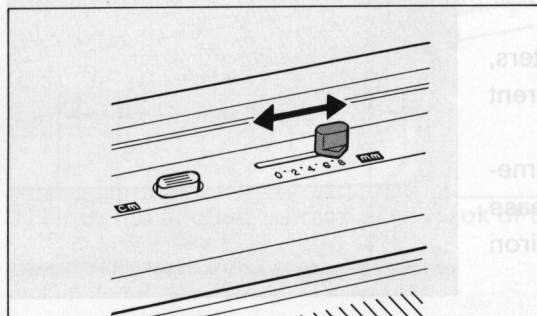

3. Set the right regulator to 8 (mm) as shown in the figure.

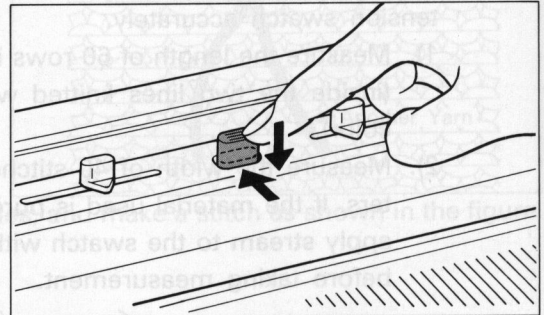

4. Release the Clutch Button.

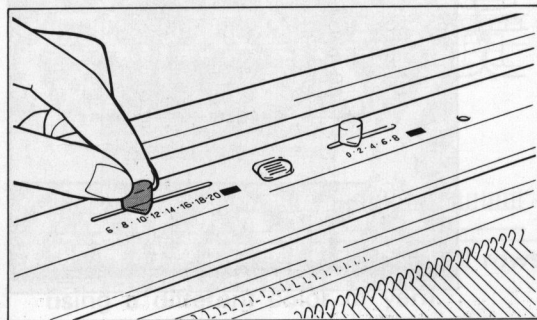

4-1-2. If the swatch measurement for 60 rows is less than 60 mm (6.0 cm).

(Suppose a swatch measures 56 mm (5.6 cm) for 60 rows.)

1. Double the swatch measurement for 60 rows.

$$56 \text{ mm} \times 2 = 112 \text{ mm (11.2 cm)}$$

2. Set the right and left regulators to 112 mm.

3. Set the left KL Tripper (pink) on K carriage only to working position as shown in the figure.

At this time, sheet is fed only when the K carriage moves from left to right.

If the swatch measurement for 60 rows is more than 60 mm (6.0 cm).....

Set the both KL Trippers to working position as shown in the figure.

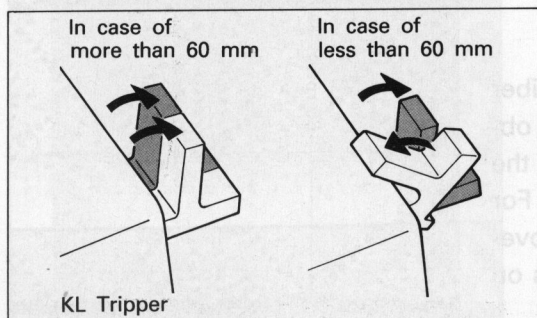

4-1-3. How to set the scale for 40 stitches measuring 122 mm (12.2 cm).

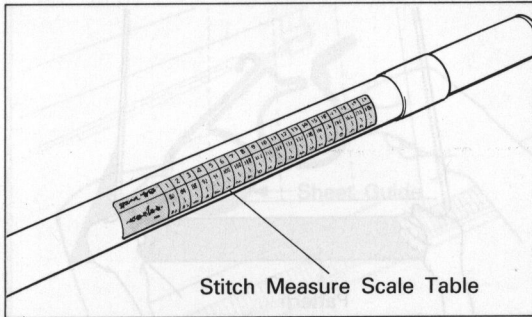

Stitch Measure Scale Table

1. Refer to the stitch measure scale table on the sheet case.

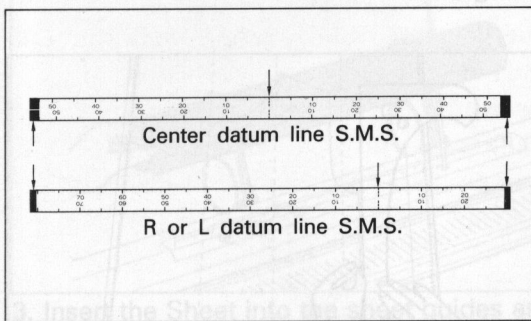

There are 30 pcs. of different stitch measure scales in the sheet case.

Center datum line S.M.S. 10 pcs.
R or L datum line S.M.S. 20 pcs.

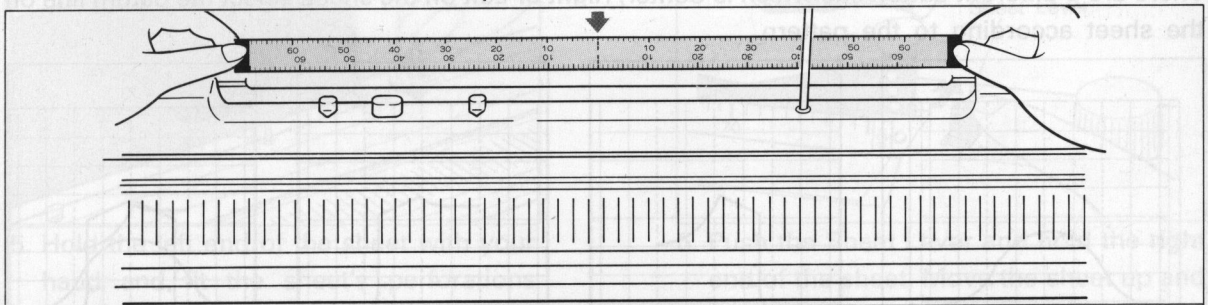

3. Take out "No. 11" stitch measure scale and set it to the Knit-Leader. (In case using Center datum line.)

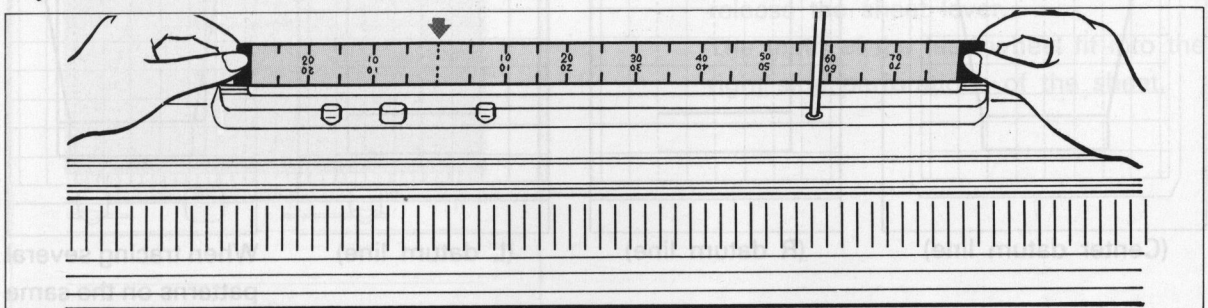

(In case using Left datum line.)

For example, when you use the S.M.S. (Stitch Measure Scale) for right or left datum line, turn it upside down and set to the Knit-Leader.

STITCH MEASURE SCALE TABLE

No.	40 Stitches Length	No.	40 Stitches Length	No.	40 Stitches Length	No.	40 Stitches Length
1	80-83	6	100-103	11	120-125	16	150-155
2	84-87	7	104-107	12	126-131	17	156-161
3	88-91	8	108-111	13	132-137	18	162-169
4	92-95	9	112-115	14	138-143	19	170-177
5	96-99	10	116-119	15	144-149	20	178-185

2. For 122 mm (12.2 cm), see the column which shows the figure 122. You can see that 122 mm (12.2 cm) belongs to "No. 11 of yellow".

4. How to use Knit-Leader

4-2. HOW TO TRACE THE PATTERN



1. Select a pattern from Home Knitting Pattern Vol. 1, 2 and 3 (that are available separately) or any suitable sewing pattern, and place it on the table.

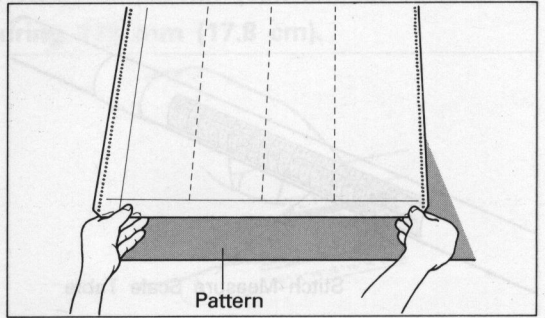

2. Take a sheet out of the sheet case and place it over the pattern as shown in the figure.

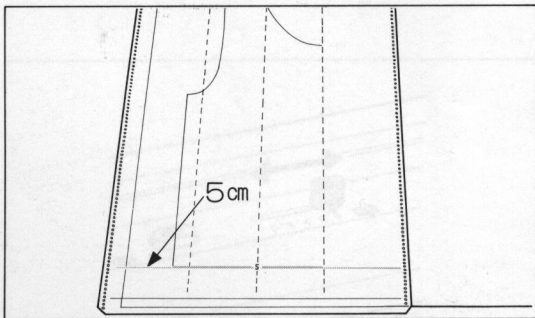

3. The drawing should start with a reference line 5 cm above the bottom.

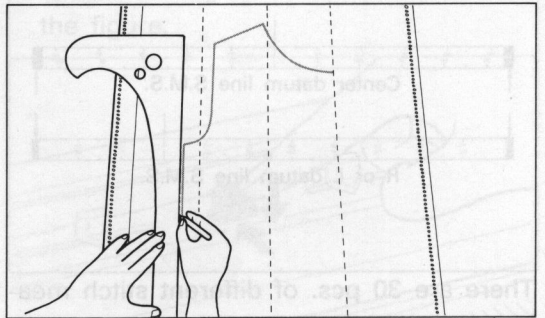

Trace the pattern with the felt pen which is included in the sheet case.

There are 3 different datum line which is Center, Right or Left on the sheet, select the datum line on the sheet according to the pattern.

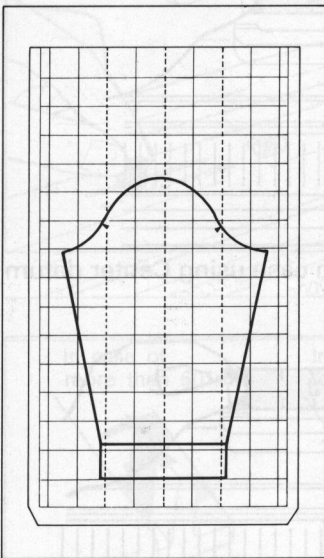

(Center datum line)

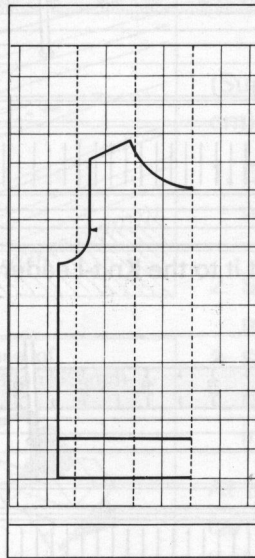

(R datum line)

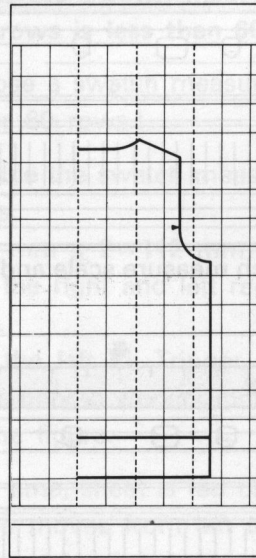

(L datum line)

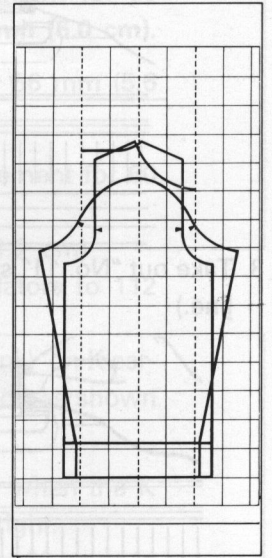

When tracing several patterns on the same sheet, it is advisable to use felt pens of different color.

If you make mistake in tracing, you can wipe the sheet with damp cloth. Wait until the Sheet is dry before redrawing lines.

...Directions for knitting...

4-3. HOW TO INSERT THE SHEET

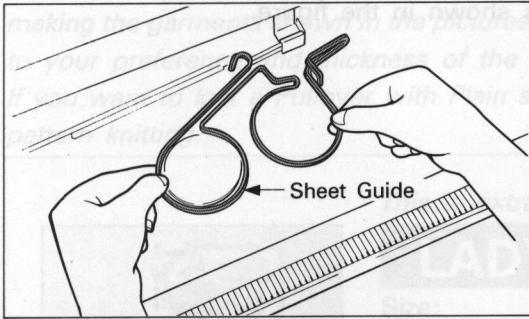

1. Take the two Sheet Guides out of carrying case.

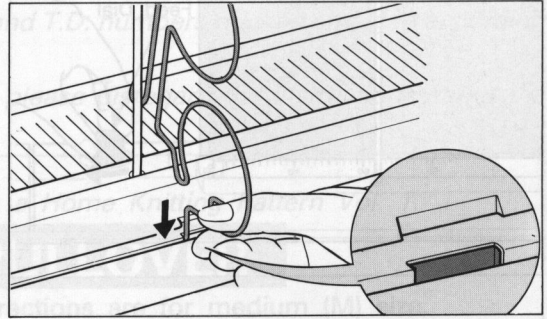

2. Insert the Sheet Guides into the slots at the back of the machine.

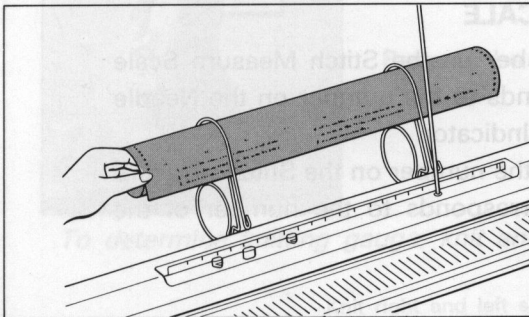

3. Insert the Sheet into the sheet guides as shown in the figure.

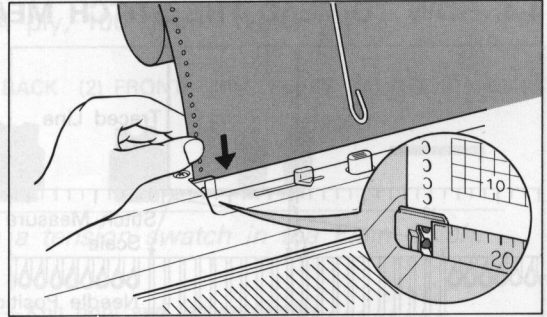

4. Insert the left end of the sheet into the slit as shown in the figure.

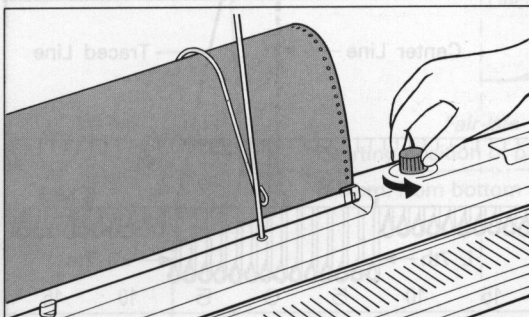

5. Hold the left end of the sheet with your hand and fit the sheet's perforations over the teeth of the left feed wheel. Turn the feed dial a few pitches.

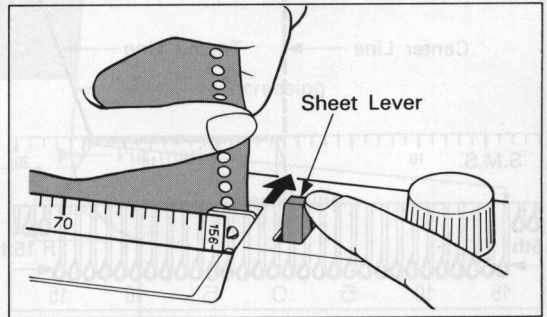

6. Push the Sheet Lever and hold the right end of the sheet. Move the sheet up and down until sheet's reference line is parallel with the Stitch Measure Scale. Then release the sheet lever. The teeth of the feed wheel fit into the right side perforations of the sheet.

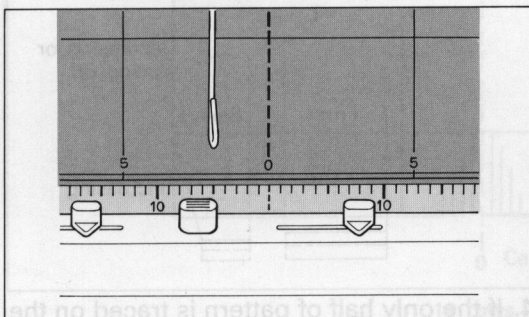

7. Align the datum line of the sheet with the Stitch Measure Scale as shown in the figure.

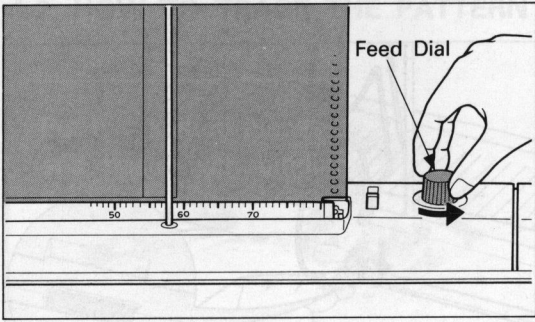

8. Turn the feed dial and set to the starting line as shown in the figure.

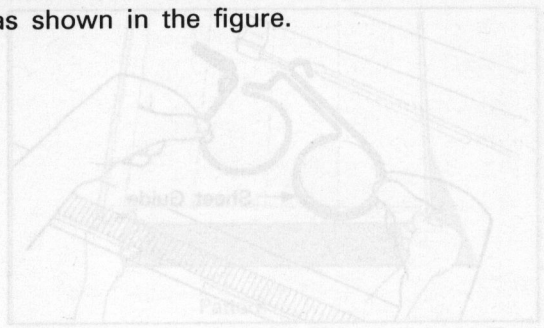

4-4. HOW TO READ THE STITCH MEASURE SCALE

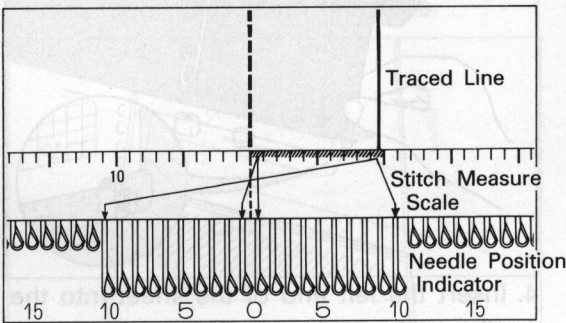

The number on the Stitch Measure Scale corresponds to the number on the Needle Position Indicator. Namely, the number on the Stitch Measure Scale corresponds to the number of the needles.

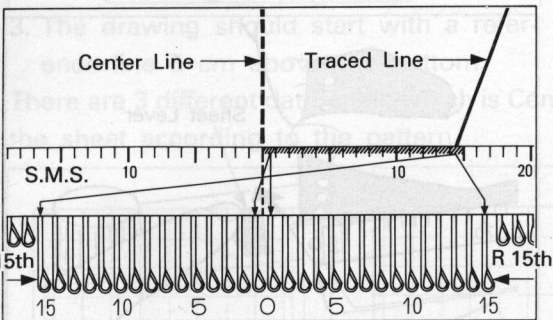

1. Increasing the stitch when the line traced on the sheet goes over to higher graduation.

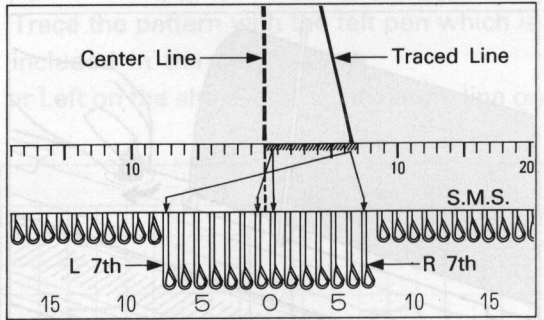

2. Decreasing the stitch when the line traced on the sheet goes over to lower graduation.

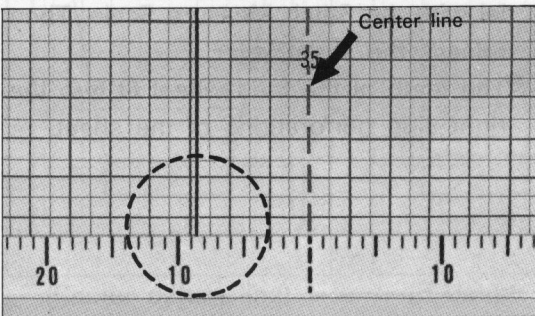

3. If the line traced on the sheet falls somewhere between graduations on the Stitch Measure Scale take the higher graduation.

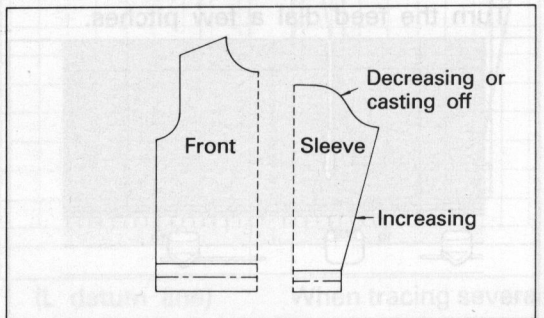

4. If the only half of pattern is traced on the sheet, do not forget to increase or decrease the stitches on the other side.

4-3. HOW TO INSERT THE SHEET

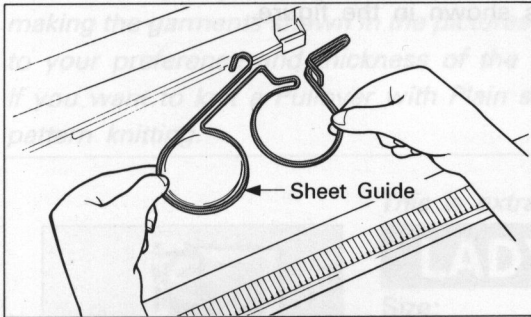

1. Take the two Sheet Guides out of carrying case.

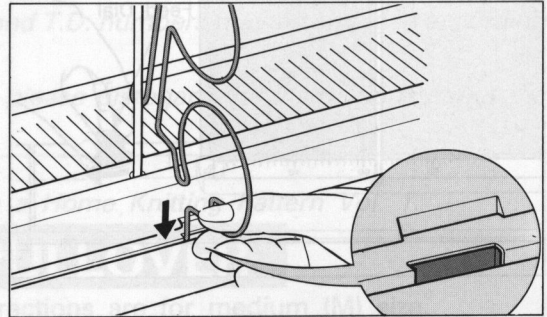

2. Insert the Sheet Guides into the slots at the back of the machine.

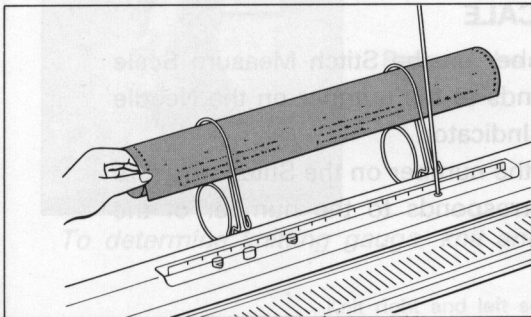

3. Insert the Sheet into the sheet guides as shown in the figure.

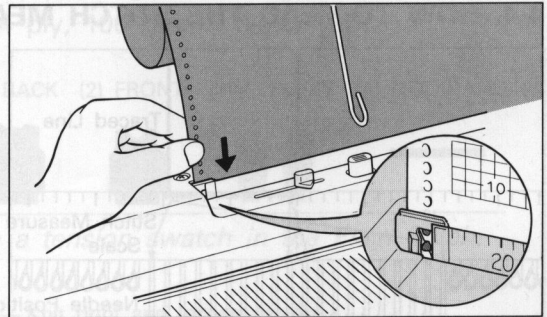

4. Insert the left end of the sheet into the slit as shown in the figure.

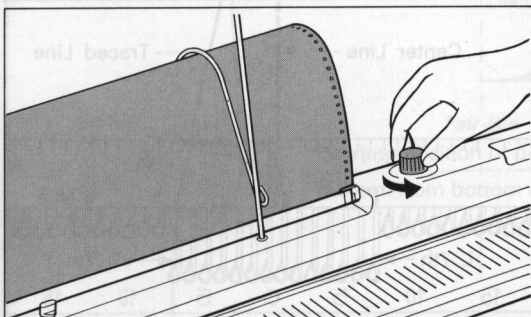

5. Hold the left end of the sheet with your hand and fit the sheet's perforations over the teeth of the left feed wheel. Turn the feed dial a few pitches.

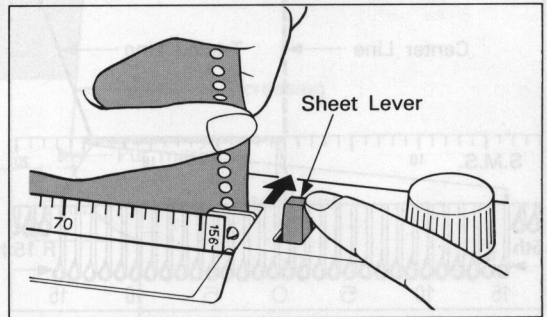

6. Push the Sheet Lever and hold the right end of the sheet. Move the sheet up and down until sheet's reference line is parallel with the Stitch Measure Scale. Then release the sheet lever. The teeth of the feed wheel fit into the right side perforations of the sheet.

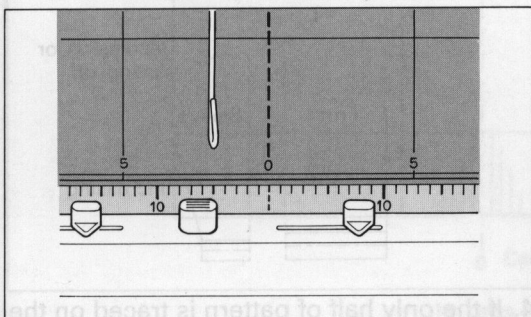

7. Align the datum line of the sheet with the Stitch Measure Scale as shown in the figure.

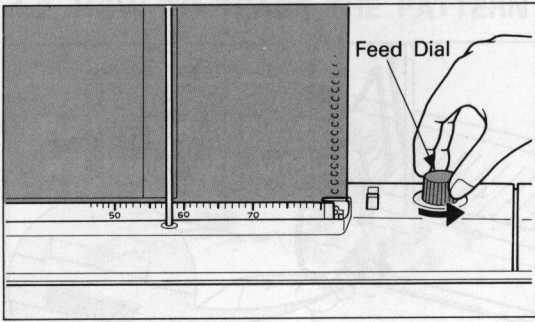

8. Turn the feed dial and set to the starting line as shown in the figure.

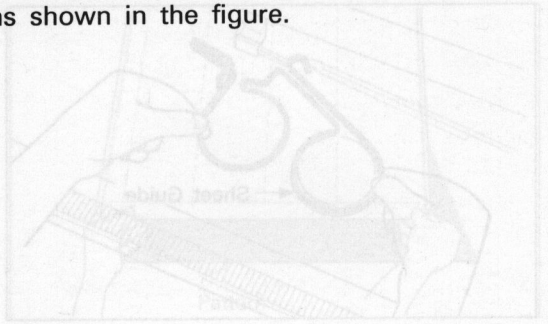

4-4. HOW TO READ THE STITCH MEASURE SCALE

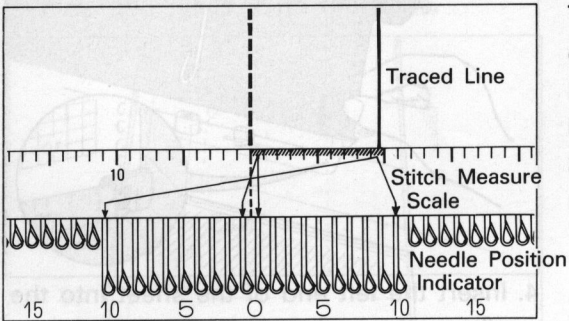

The number on the Stitch Measure Scale corresponds to the number on the Needle Position Indicator. Namely, the number on the Stitch Measure Scale corresponds to the number of the needles.

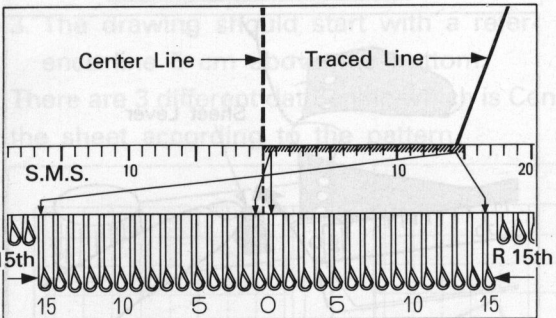

1. Increasing the stitch when the line traced on the sheet goes over to higher graduation.

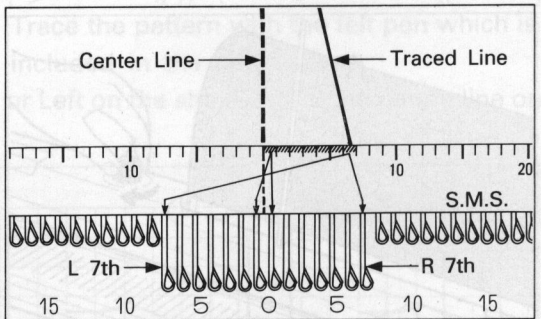

2. Decreasing the stitch when the line traced on the sheet goes over to lower graduation.

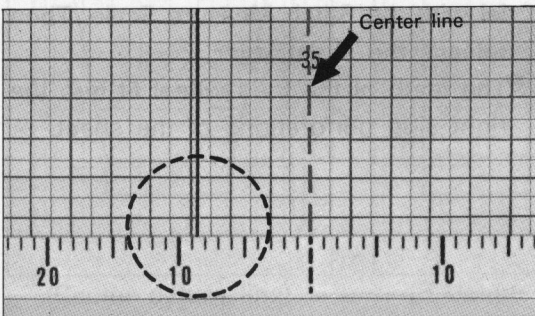

3. If the line traced on the sheet falls somewhere between graduations on the Stitch Measure Scale take the higher graduation.

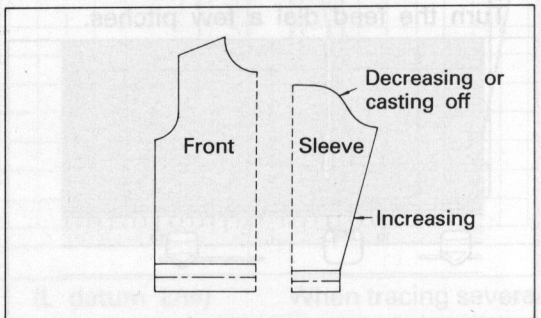

4. If the only half of pattern is traced on the sheet, do not forget to increase or decrease the stitches on the other side.

...Directions for knitting...

The following materials, sizes, and tension dial (T.D.) numbers given for each pattern are for making the garments shown in the pictures. Material and T.D. numbers may be changed according to your preference and thickness of the yarn.

If you want to knit a Pullover with Plain stitch, then please disregard the instructions about the pattern knitting.

This is extracted from a Home Knitting Pattern Vol. 1.

LADY'S PULLOVER

Size: Directions are for medium (M) size.

Materials: Yarn—Pure wool.

* 4 ply, 400 grams Orange yarn.

* 4 ply, 100 grams White yarn.

Parts to be knitted:

(1) BACK (2) FRONT (3) SLEEVES (4) NECKBAND

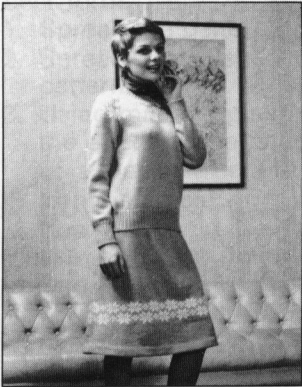

To determine knitting gauge, knit and measure a tension swatch in the Plain Stitch.

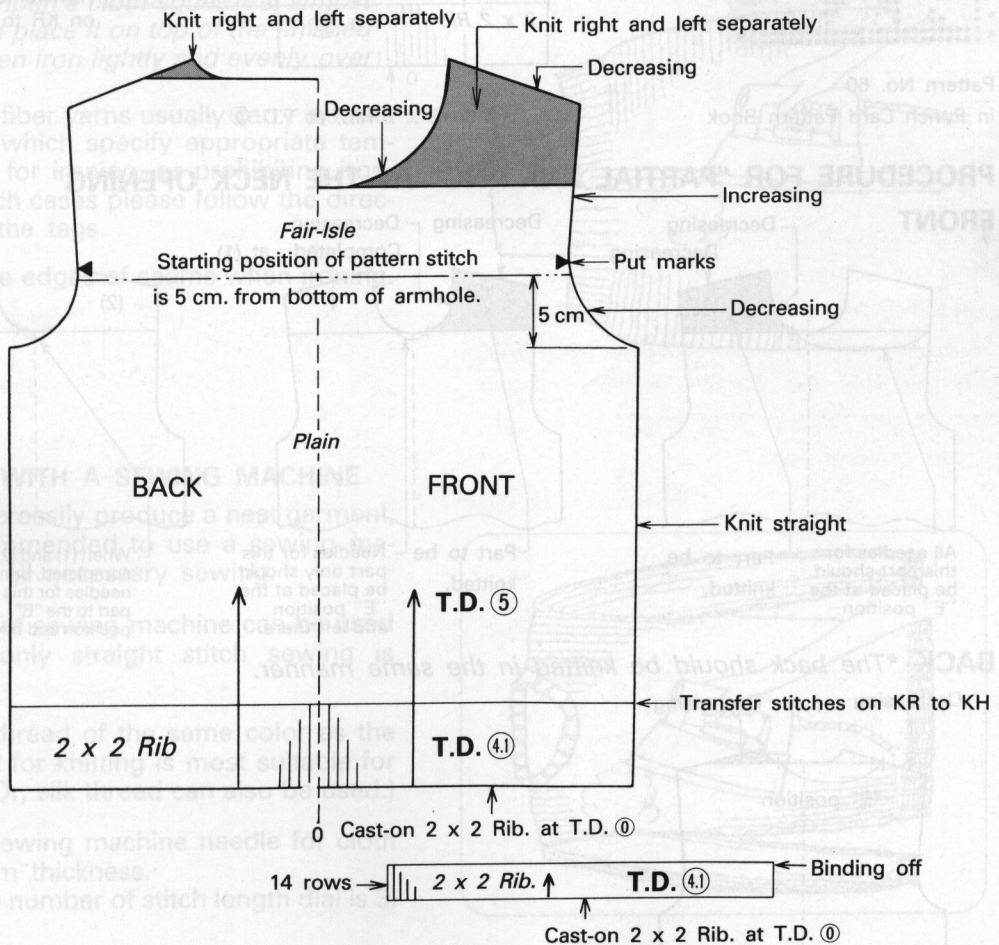

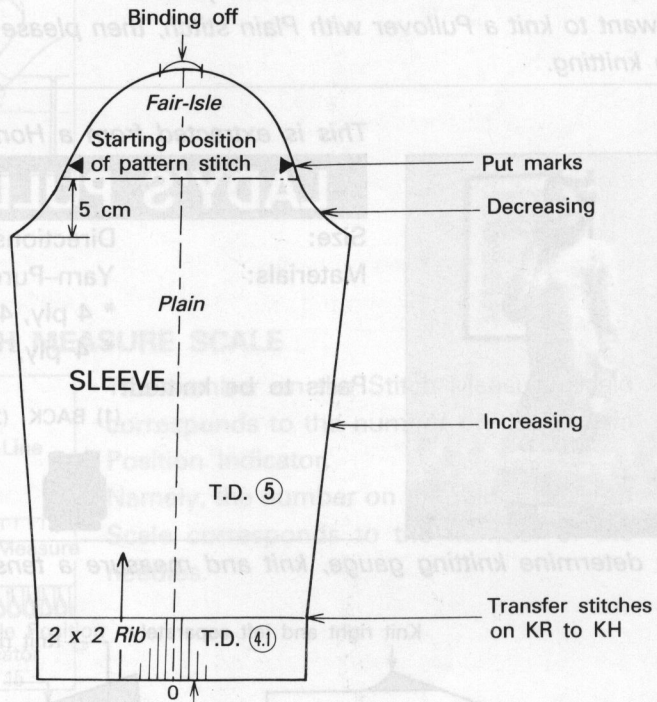
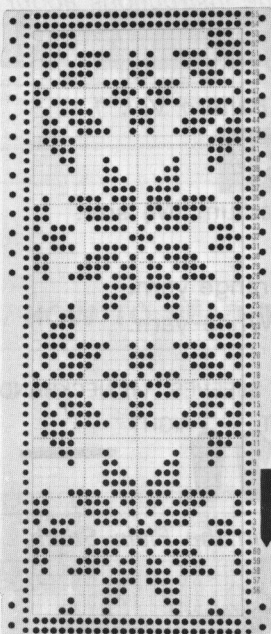

Pattern No. 60
in Punch Card Pattern Book

Cast-on 2 x 2 Rib. at T.D. ①

PROCEDURE FOR "PARTIAL KNITTING" AT THE NECK OPENING

FRONT

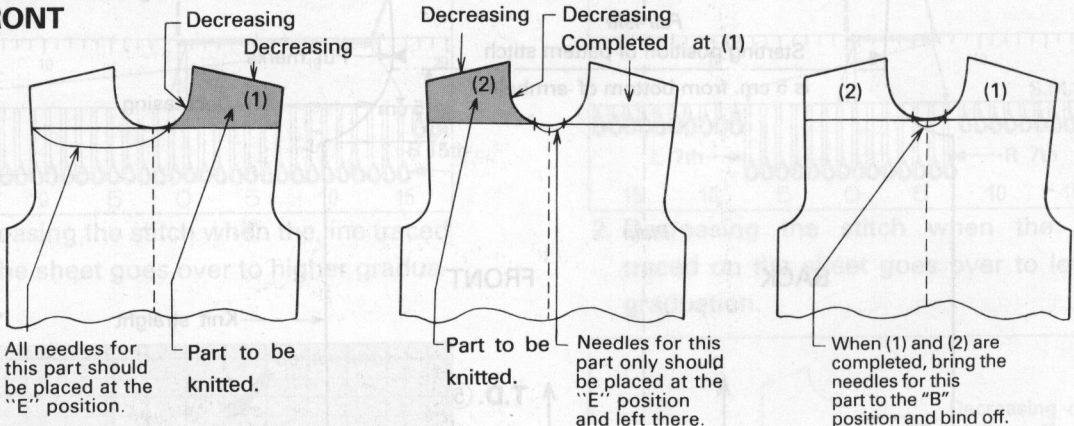

All needles for this part should be placed at the "E" position.

Part to be knitted.

Part to be knitted.

Needles for this part only should be placed at the "E" position and left there.

When (1) and (2) are completed, bring the needles for this part to the "B" position and bind off.

BACK *The back should be knitted in the same manner.

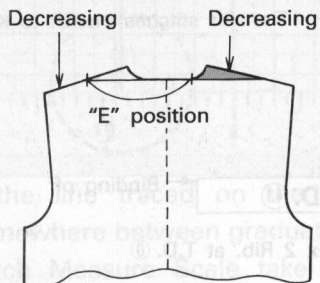

Important points for finishing

HOW TO IRON PROPERLY

Because knitted material is very elastic it is necessary to iron the finished work in the correct way in order to shape it into its best form.

1. Spread the pattern on an ironing board.
2. Spread the finished work on top of the pattern.
3. Using marking pins, pin the work along the edges of the pattern line in intervals of about 3-4 centimeters.
4. Iron the whole work lightly with a steam iron.

Please note the following points when ironing.

* *Do not place the finished work on the transparent sheet for knit-leader when ironing.*

* *A steam iron is best for a beautiful finish, however if you use an ordinary dry iron, first dampen a cloth-squeeze it almost dry-and place it on top of the finished work then iron lightly and evenly over it.*

Synthetic fiber yarns usually carry instruction tags which specify appropriate temperatures for ironing, or prohibiting ironing. In such cases please follow the directions on the tags.

Spread the edges of seams when ironing.

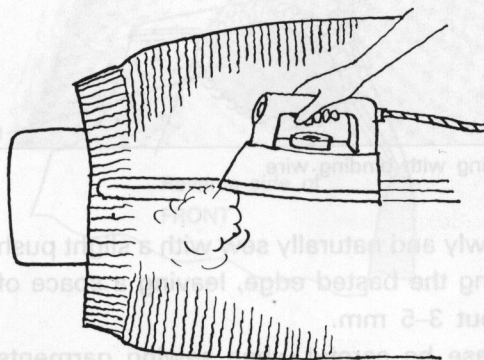
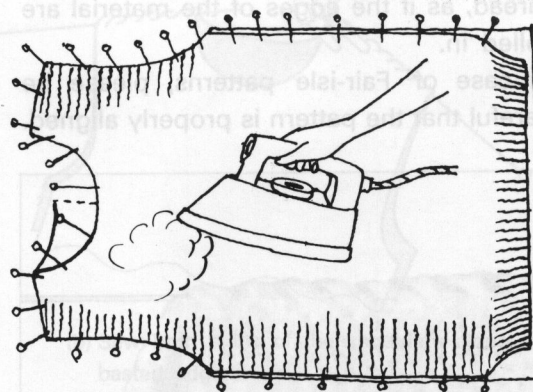

SEWING WITH A SEWING MACHINE

In order to easily produce a neat garment, it is recommended to use a sewing machine for all necessary sewing.

Any type of sewing machine can be used because only straight stitch sewing is necessary.

Stretchy thread of the same color as the yarn used for knitting is most suitable for sewing. (Or, silk thread can also be used.)

Use the sewing machine needle for cloth of medium thickness.

A suitable number of stitch length dial is 3.

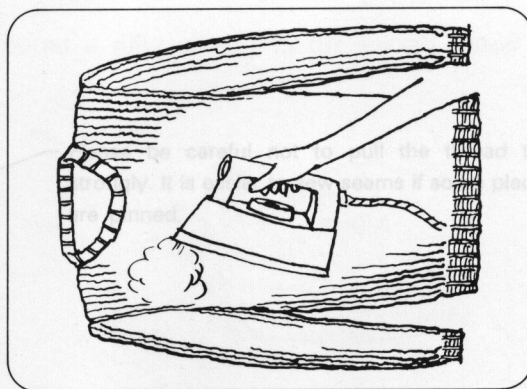

Put two knitted pieces together inside out and baste with binding wire or basting thread, as if the edges of the material are rolled in.

In case of Fair-isle patterns, please be careful that the pattern is properly aligned.

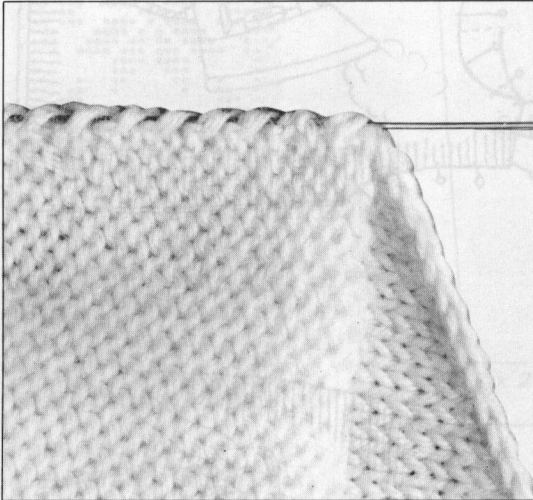

Basting with binding wire

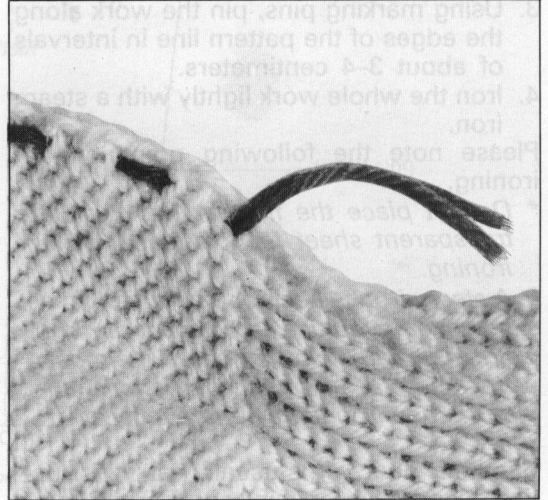

Basting with thread

Slowly and naturally sew with a slight push along the basted edge, leaving a space of about 3-5 mm.

Please be careful when sewing garments with the Fair-isle pattern because loose yarn on the reverse side might be caught by the presser foot.

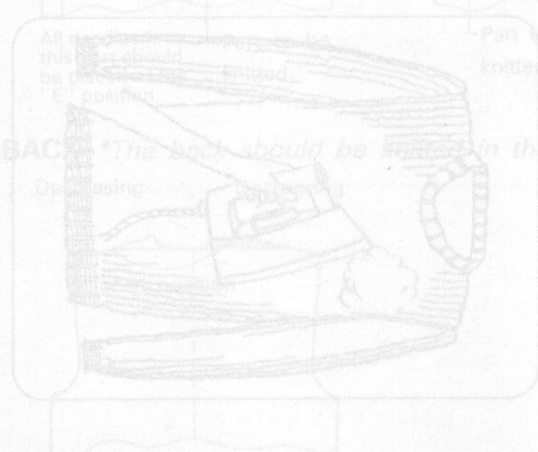
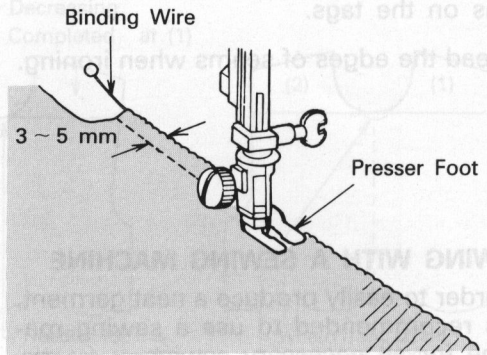

Stretchy thread of the same color as the yarn used for knitting is most suitable for sewing. (Or, silk thread can also be used.) Use the sewing machine needle for cloth of medium thickness. A suitable number of stitch length dial is 3.

Sewing procedure

1. Shoulders (right and left)

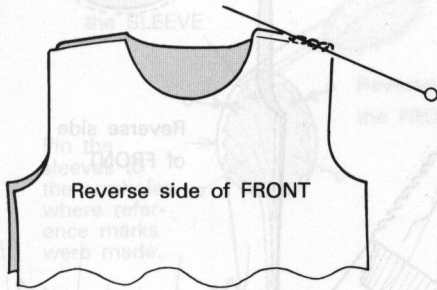

(a) Put front and back together inside out and baste shoulder with binding wire.

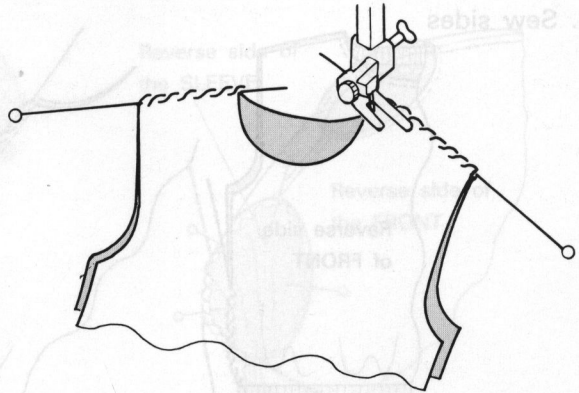

(b) Sew both sides of the shoulders along the basted edge.

2. Sew neckband

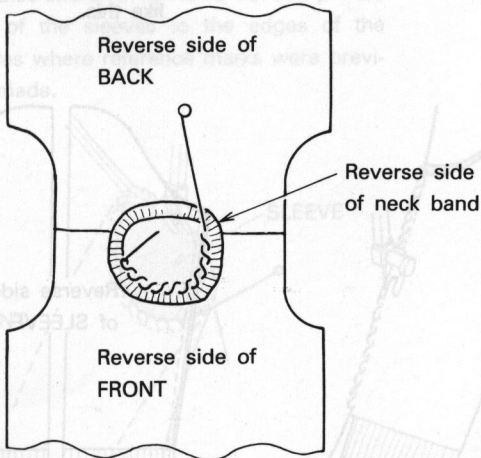

(a) Seam the neckband in a loop and baste the neckband onto the bodice.

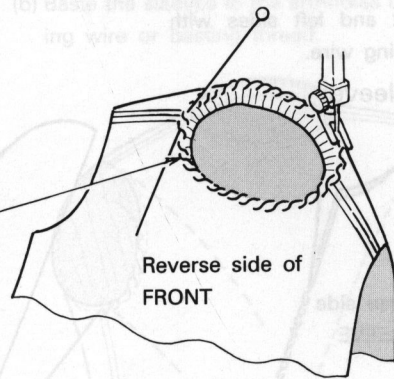

(b) Sew with a Sewing machine.

HOW TO SEAM BY HAND USING A TAPESTRY NEEDLE

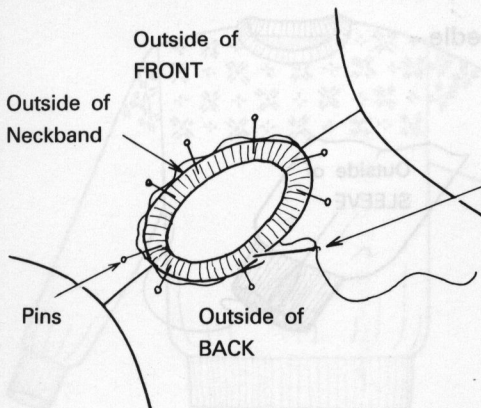

Please be careful not to pull the thread too strongly. It is easier to sew seams if some places are pinned.

3. Sew sides

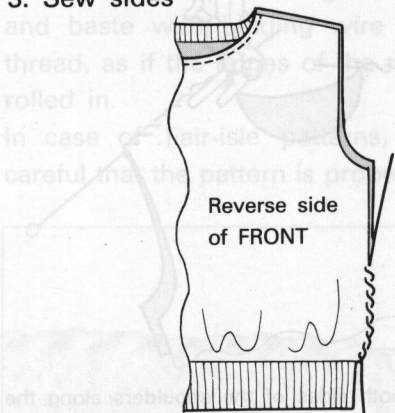

(a) Put front and back together inside out and baste both right and left sides with binding wire.

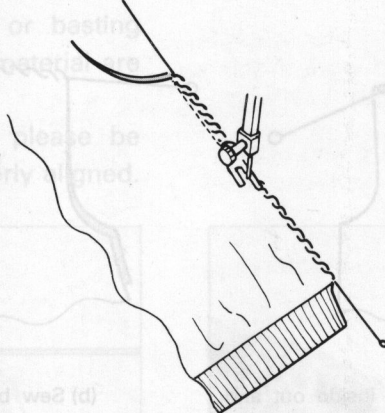

(b) Sew right and left sides with a Sewing machine.

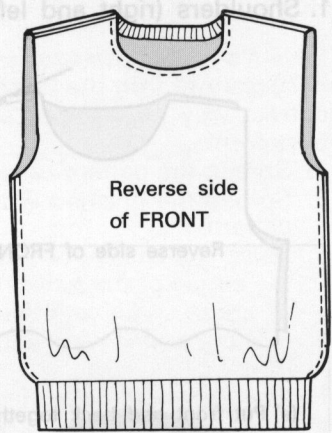

(c) When both sides are completely sewn it should look like this.

4. Sew sleeves

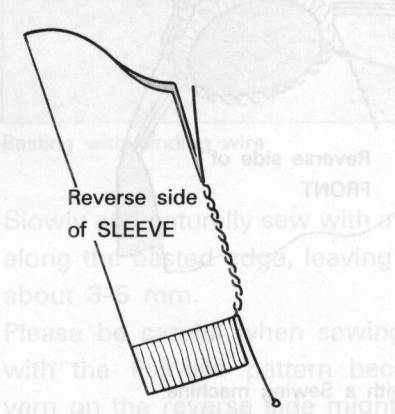

(a) Fold sleeves inside out as shown below and baste with binding wire.

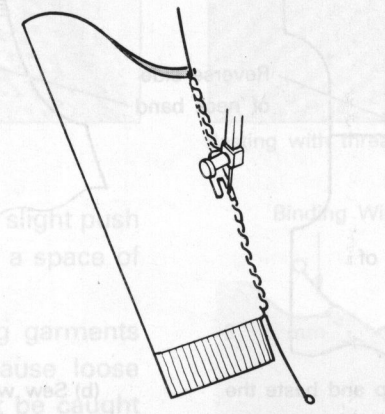

(b) Sew along the wired edges with a Sewing machine.

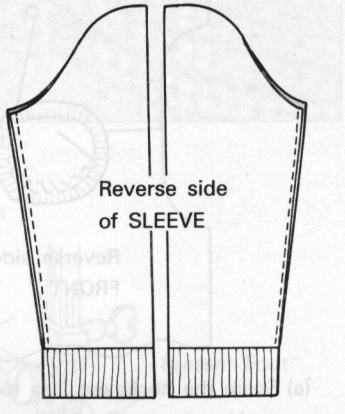

(c) When completely sewn the sleeves should look like this.

5. Seam bodice rib and cuffs with a tapestry needle

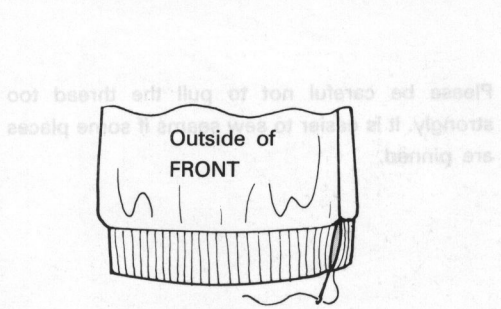

(a) Seam ribbing of both sides of the bodice.

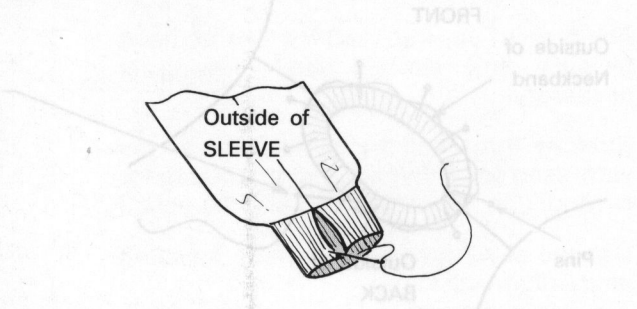

(b) Seam cuffs.

6. Attach sleeves to armholes

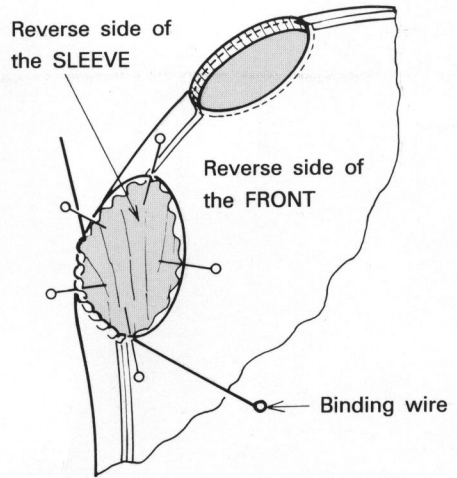
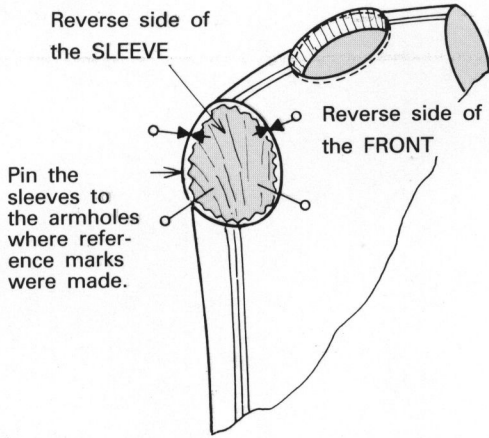

(a) Put bodice and sleeves inside out and pin the edges of the sleeves to the edges of the armholes where reference marks were previously made.

(b) Baste the sleeves to the armholes using binding wire or basting thread.

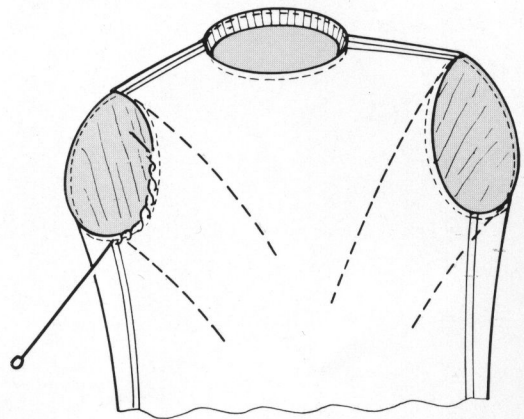
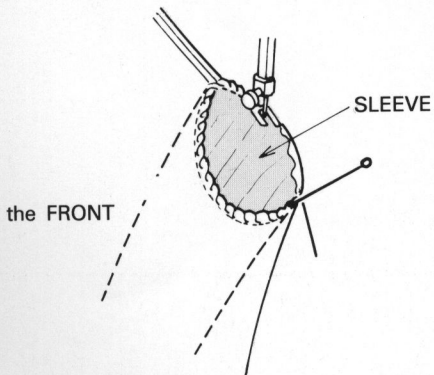

(c) Sew basted parts with a Sewing machine.

(d) Take out the basting thread or binding wire.

7. Finished garment

