

HOW TO UTILIZE THIS GARTER BAR

1. Speedy knitting by a row of stitches is possible with this garter bar, as compared with the use of a transfer tool for transfer stitch by stitch.
2. You can make the transfer of many stitches very easily at one time. So, when you wish to gather some stitches to one direction or to decrease many stitches at one time or to fold up the knitted pattern in the center for picot hem, this tool is very convenient for you. Also, by these application, you can enjoy making the patterns like a rope or the lace pattern.
3. If you want to check a work on the halfway of your knitting, you can easily do it by removing that work from the machine with this tool.
4. Also, you can bring that removed work to any place where you wish.

*SPECIAL FEATURES OF THIS TOOL

1. This tool consists of two connection plates, each of which is equipped with 100 pcs. needles. So, when you knit a small size of work, you can disconnect this to be useful for you.
2. This tool has a needle stopper as an accessory which is the equipment for fixing knitting needles at "E" position of needle plate in order to prevent the movement of needles under the usage of the garter bar. So, with this accessory, you can use the garter bar more effectively. You can also use this accessory for adjusting each stitch when you start knitting or make a ribbing pattern.

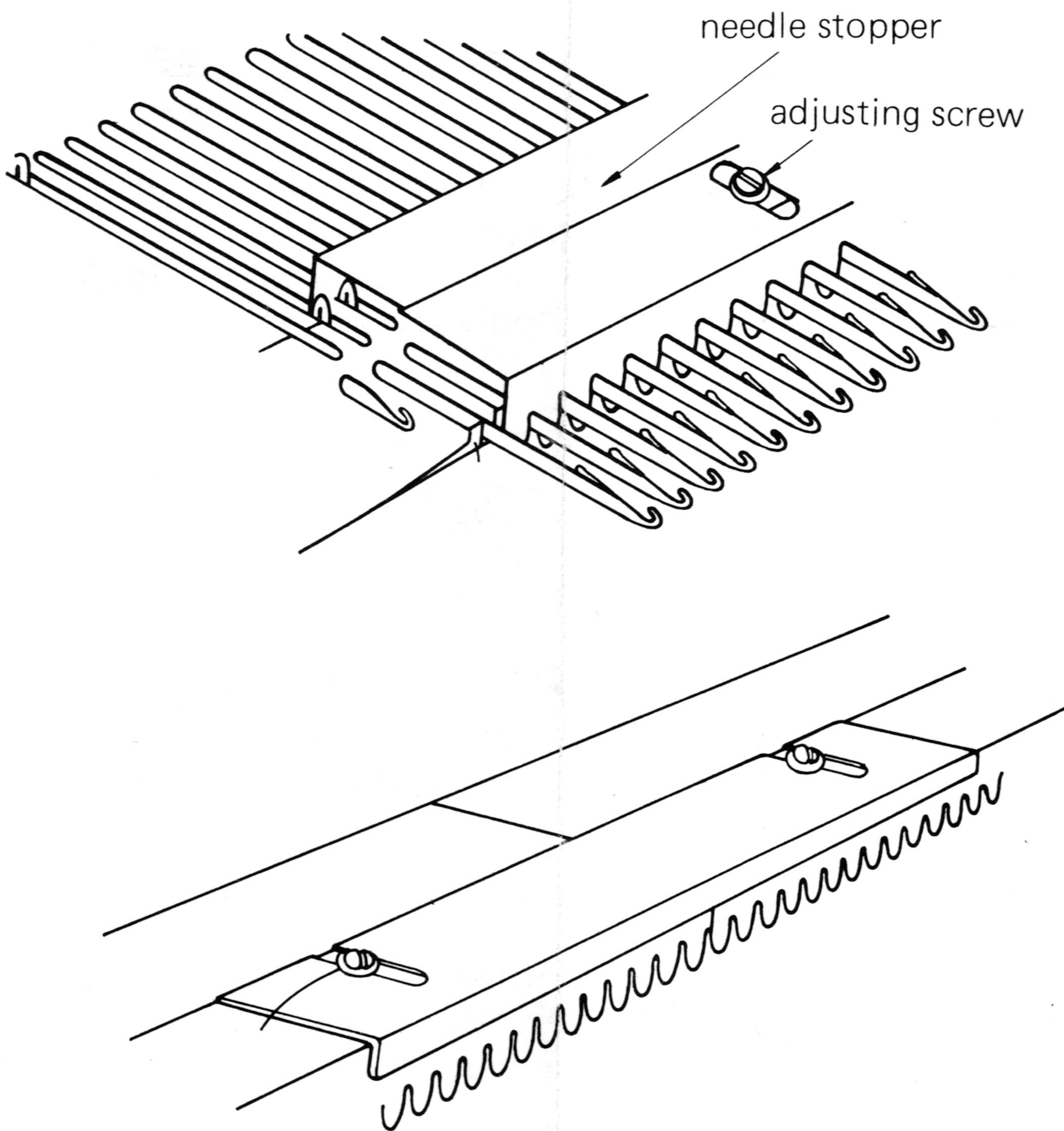

But, you must be careful about the following points before using this accessory:

1. In order to fix knitting needles at "E" position, this needle stopper should be set to fix butts of knitting needles and sinker needles.
2. So, if this accessory cannot be set as above, adjust a width between butts of needles and sinker needles by loosening screws of this needle stopper.
3. After this adjustment, drive above screws once again. Then, you can use this needle stopper effectively without any problem.

*HOW TO USE GARTER BAR FOR VARIOUS KNITTING PATTERN

1. Garter stitch pattern

- a) Position the needle groove of garter bar upward and hook the needle eyelets of garter bar onto the knitting needles as per fig.1.

Fig. 1

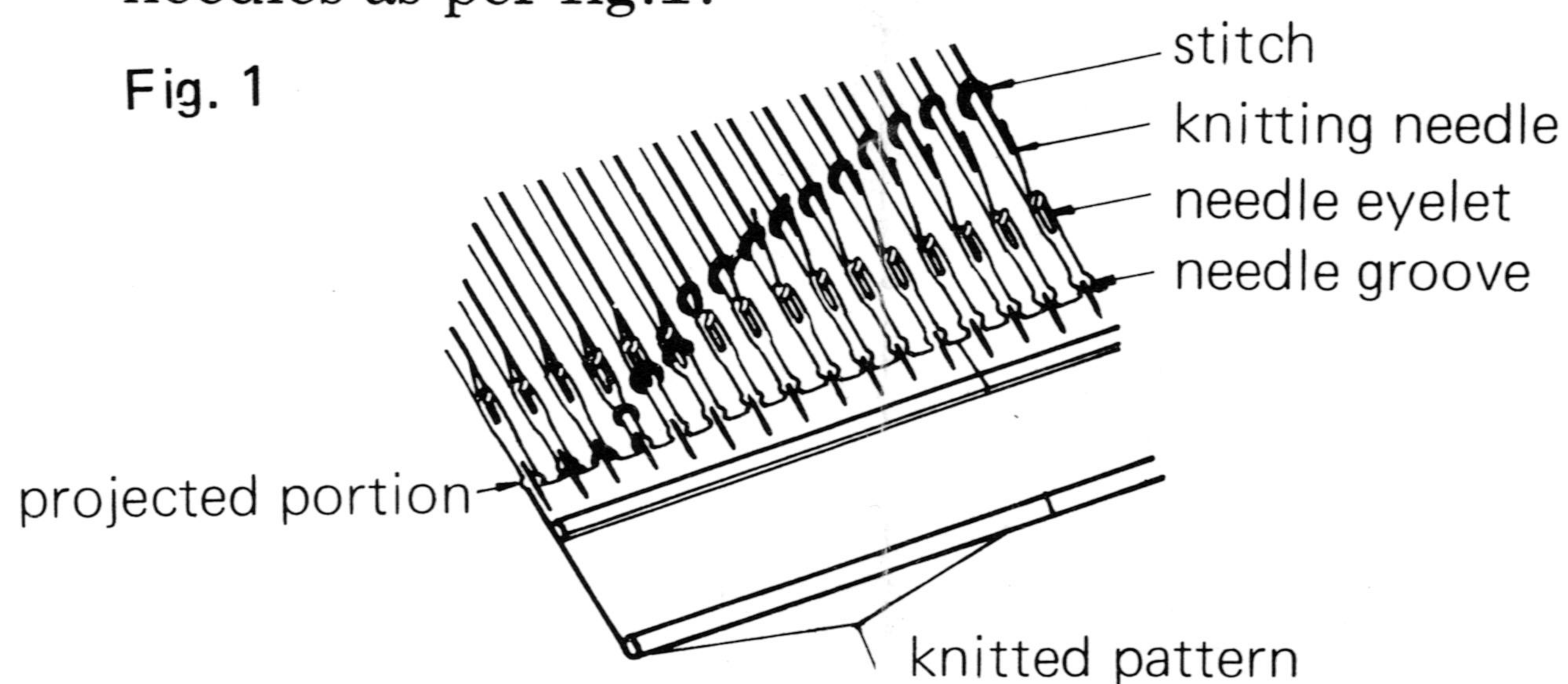

- b) Pull garter bar toward you until butts of knitting needles will come to "E" position of needle bed. Then, set a needle stopper.
 c) Shift each stitch on the knitting needles to garter bar until each stitch will go beyond the projected portion on the needles of garter bar (This can be done by pulling the work toward you).
 d) Remove garter bar from the knitting needles.
 e) Turn the garter bar over.
 f) Then, put each needle groove of garter bar on each knitting needle as per fig. 2 & 3.

Fig. 2

Fig. 3

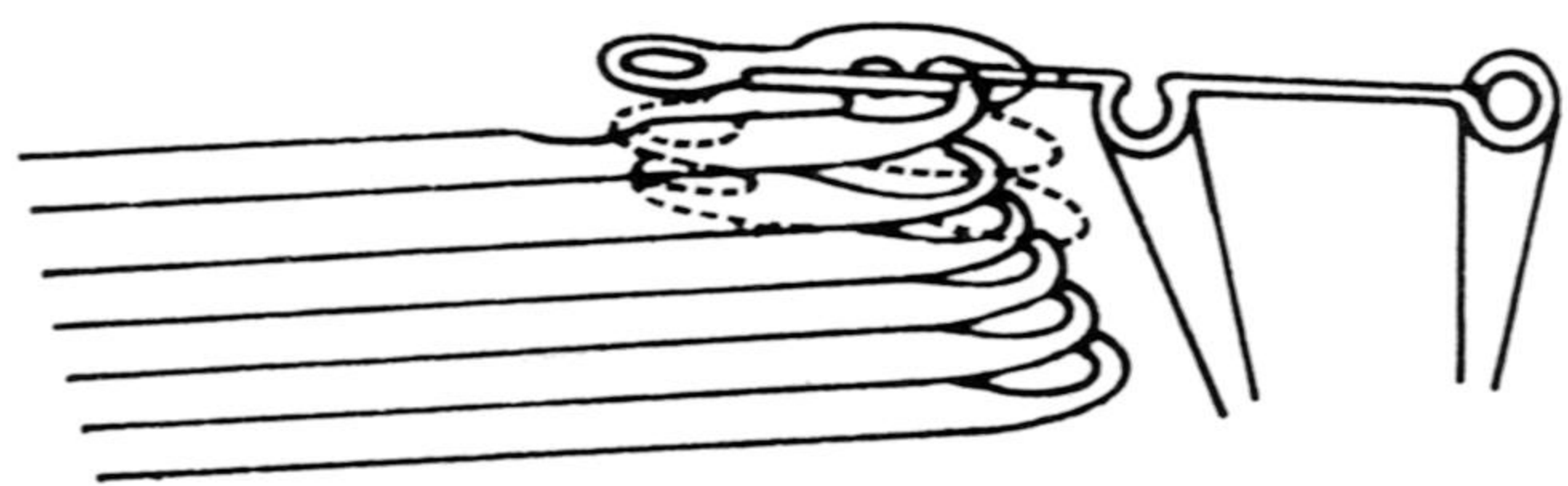

And after that, pull garter bar toward you a little (By this work, each stitch on garter bar will be transferred.)

- g) After each stitch on garter bar is completely transferred to knitting needles, pull garter bar downward as per fig. 4.

Fig. 4

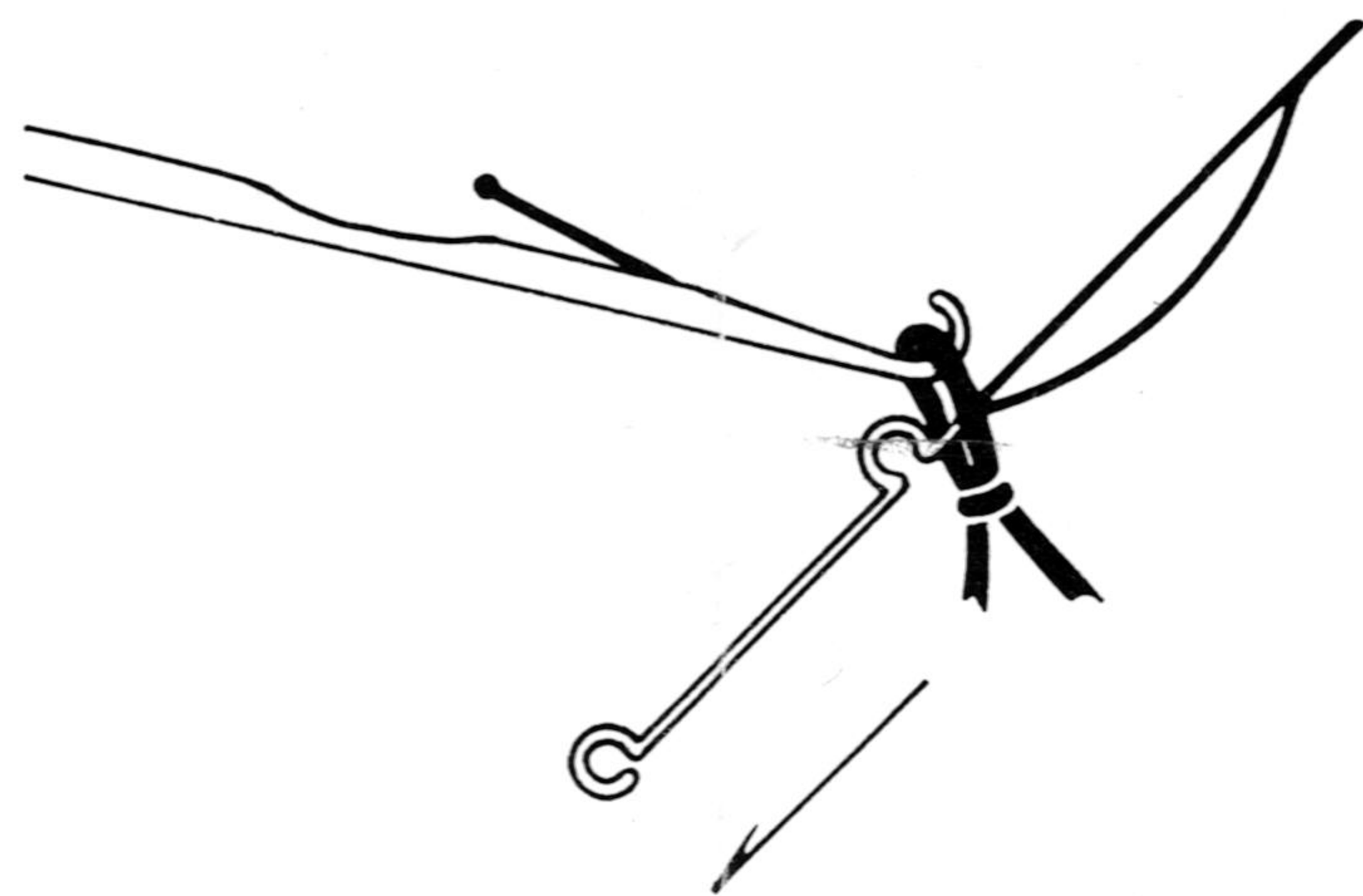

- h) Knitting each row, please repeat above steps of (a) through (g). Then, you can make out a complete garter stitch pattern.

2. Partial knitting

In this case, yarn is not completely finished off and if you transfer onto garter bar, the yarn would go into between next row and garter bar. Therefore, please take care of followings:

- a) Pulling up the yarn by your right hand finger like fig. 5, put the garter bar on the knitting needles and transfer all stitches to garter bar.

Fig. 5

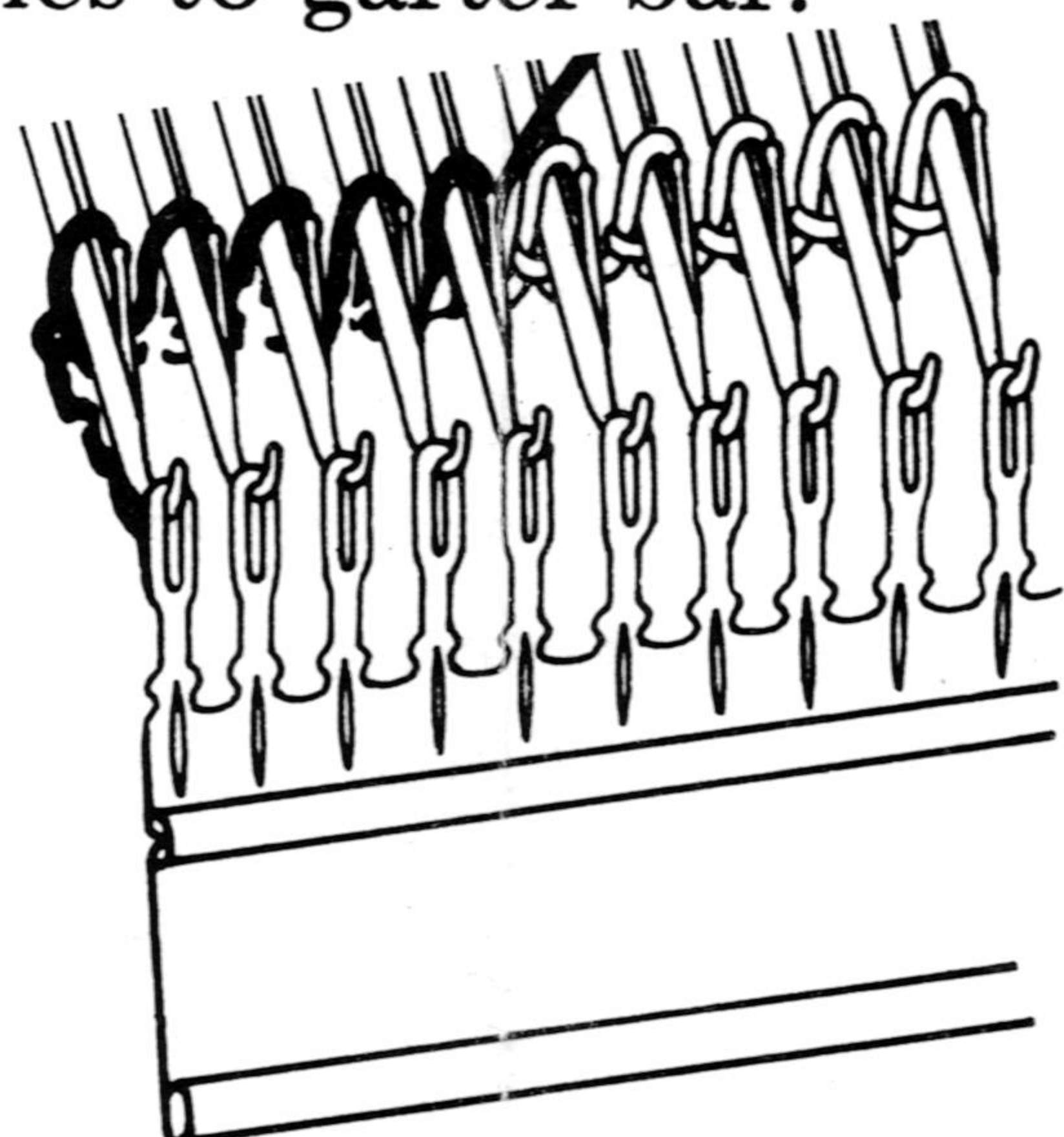

b) Turn the garter bar over and also pull the yarn toward you.

3. Cable stitch pattern

a) As per fig. 6, pull each four needles out toward you and transfer all stitches on those needles to garter bar.

Fig. 6

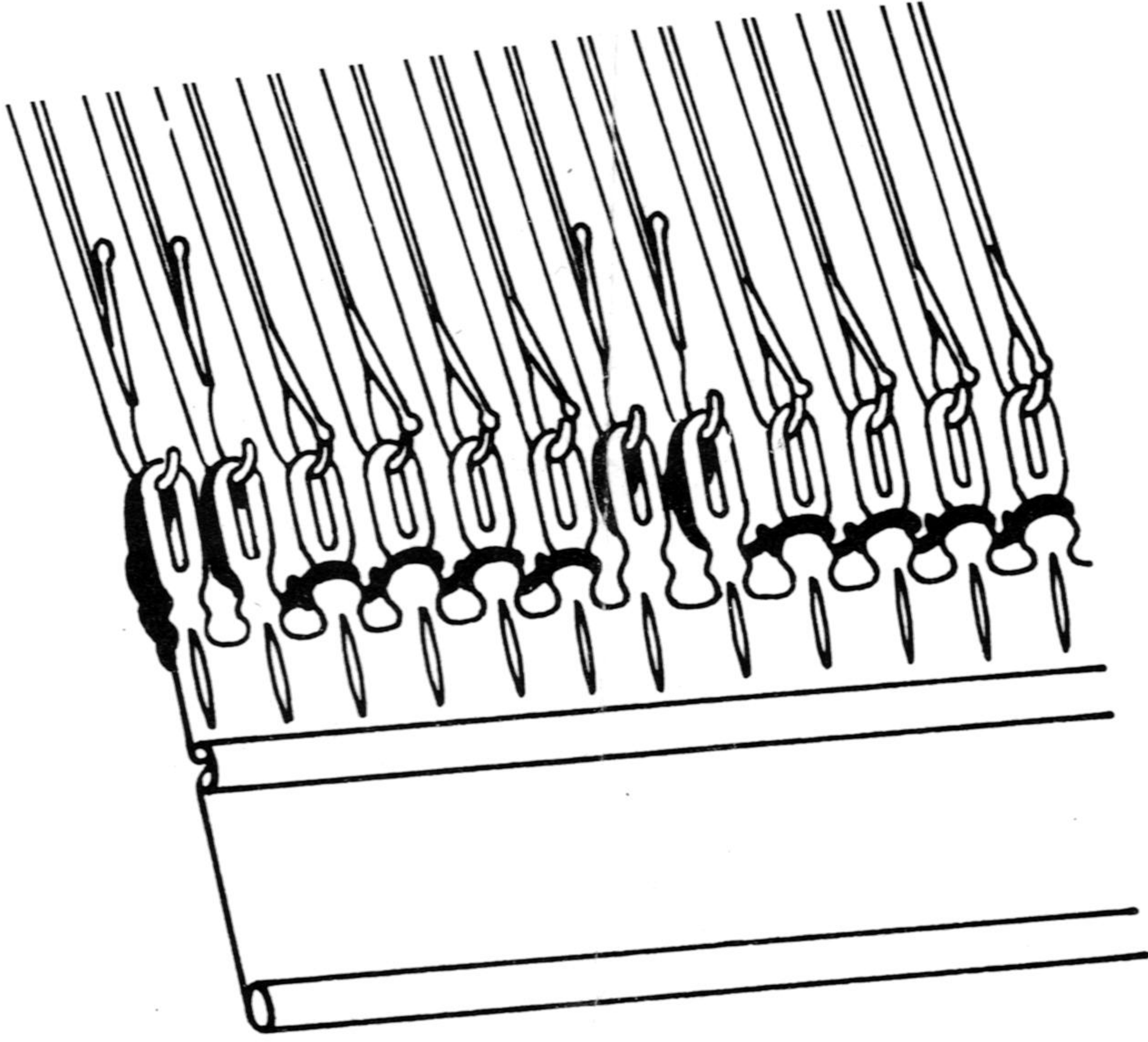

b) Removing the garter bar from the needle, slide the garter bar to the left by two stitches (needles) as per fig. 7 and transfer two stitches on the right to the needles by your finger again as per fig. 8.

Fig. 7

Fig. 8

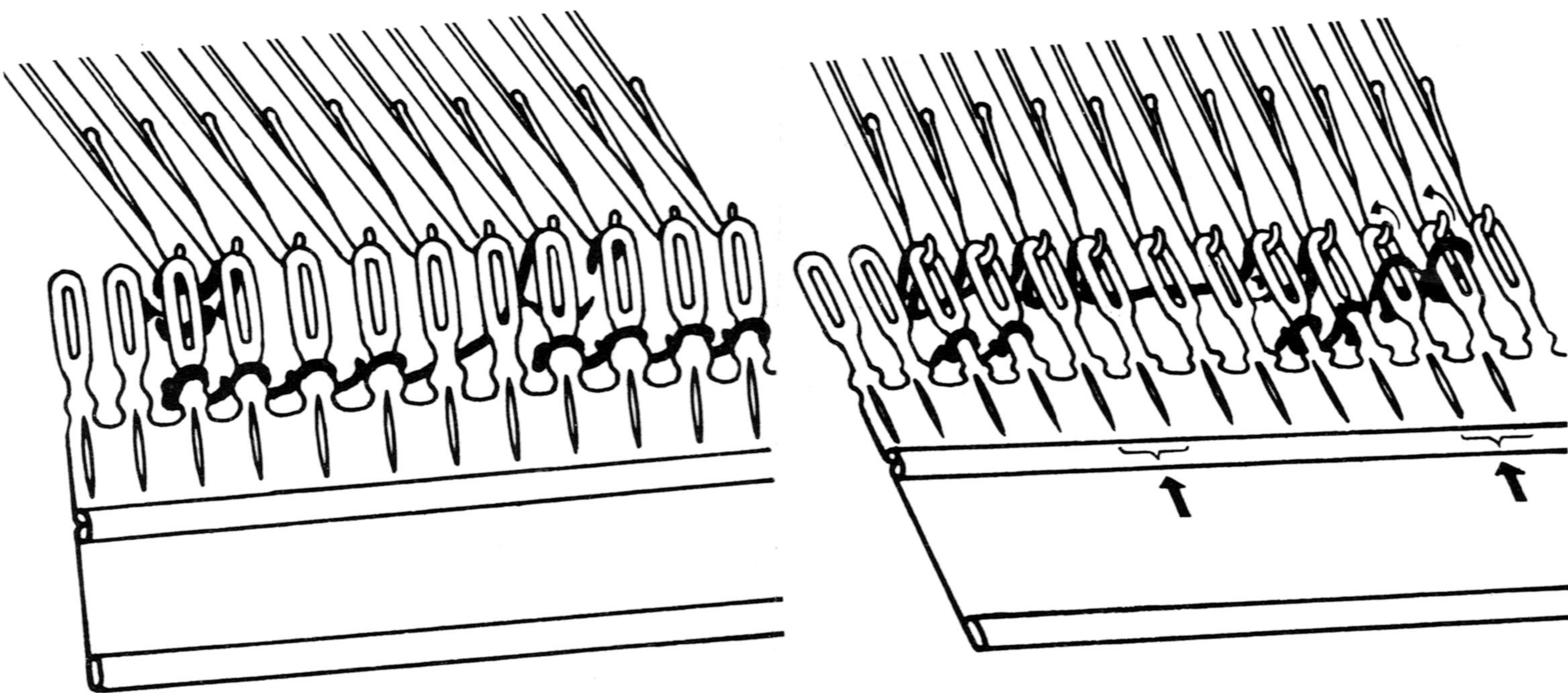

c) Slide garter bar to the right by four stitches (needles) and transfer remaining two stitches to each empty two needles as per fig. 9.

Fig. 9

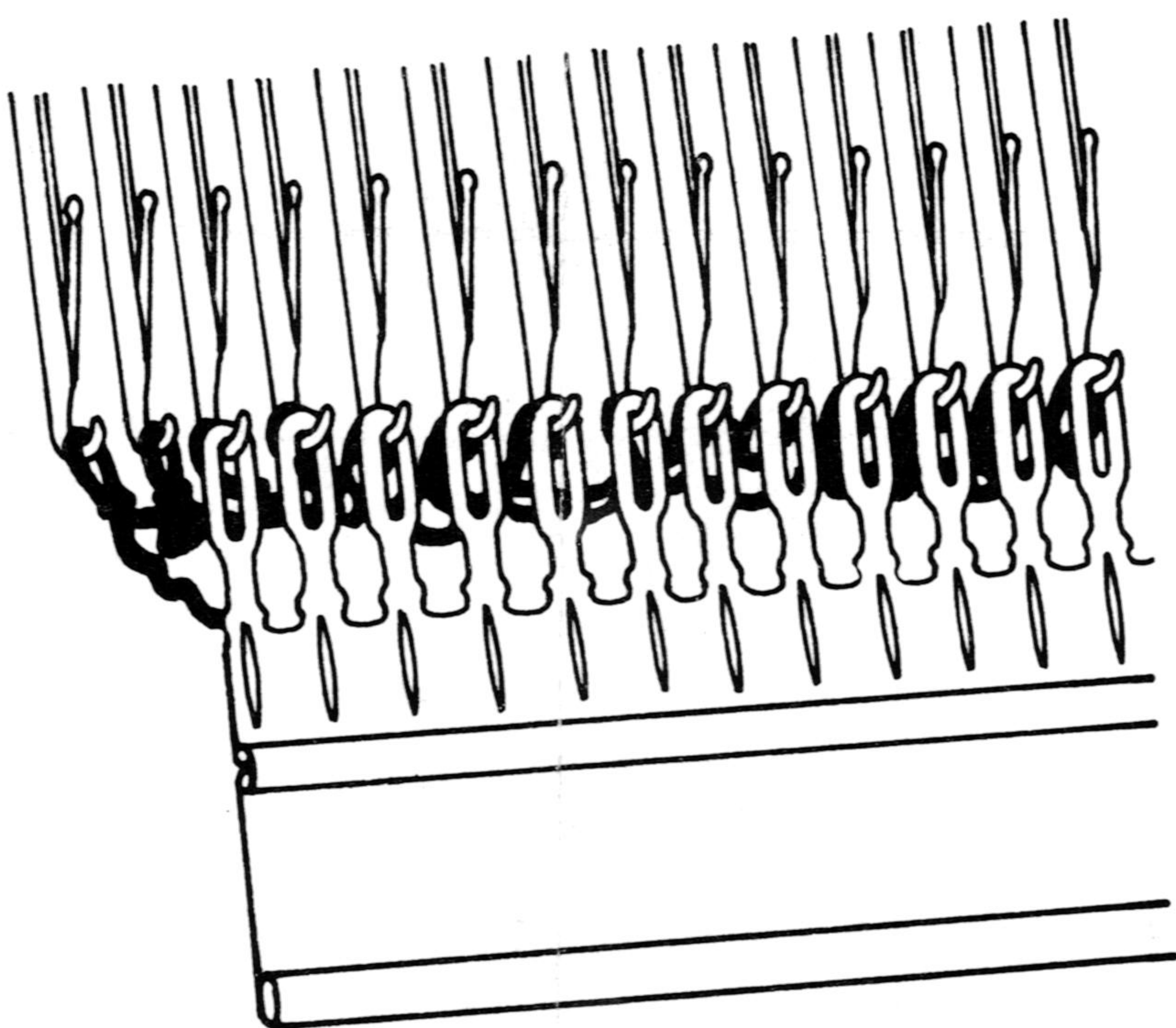

d) Knitting each row, please repeat above steps. Then, you can make out a beautiful cable stitch pattern.

4. How to gather stitches to one direction

- a) Select three stitches on the needles and transfer two stitches (middle and right) of these stitches to the left side stitch of above three needles by using a transfer tool as per fig. 10 so that a middle stitch of them may be put in the inner part. Then, two needles on the right will be empty.

Fig. 10

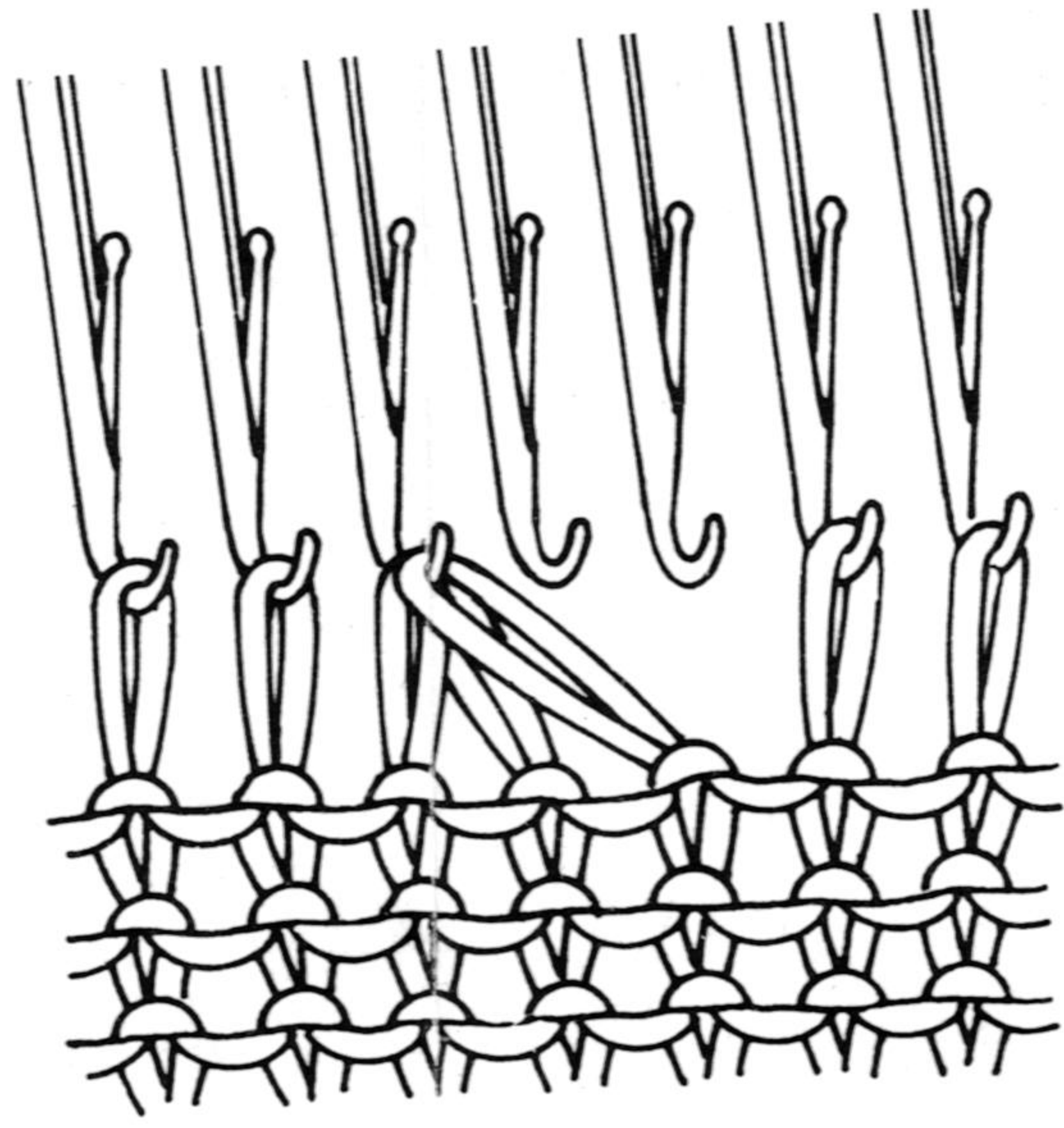

- b) Pull all needles on the right of above empty needles toward you until each stitch on those needles will go beyond the needle latch as per fig. 11.

Fig. 11

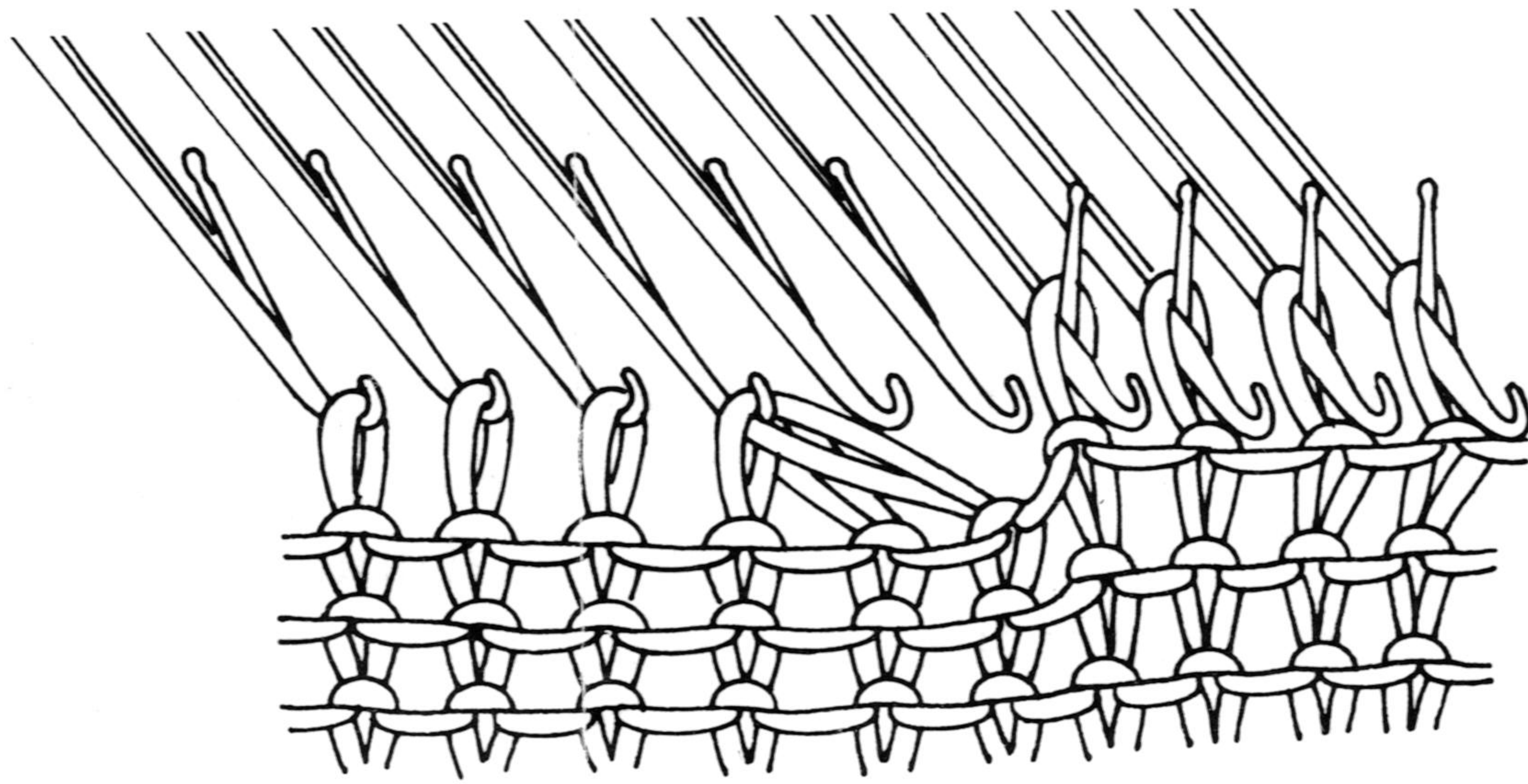

- c) If you are sure that above work is completely finished, hook garter bar onto the knitting needles and shift each stitch on needles to garter bar by your finger as per fig. 12.

Fig. 12

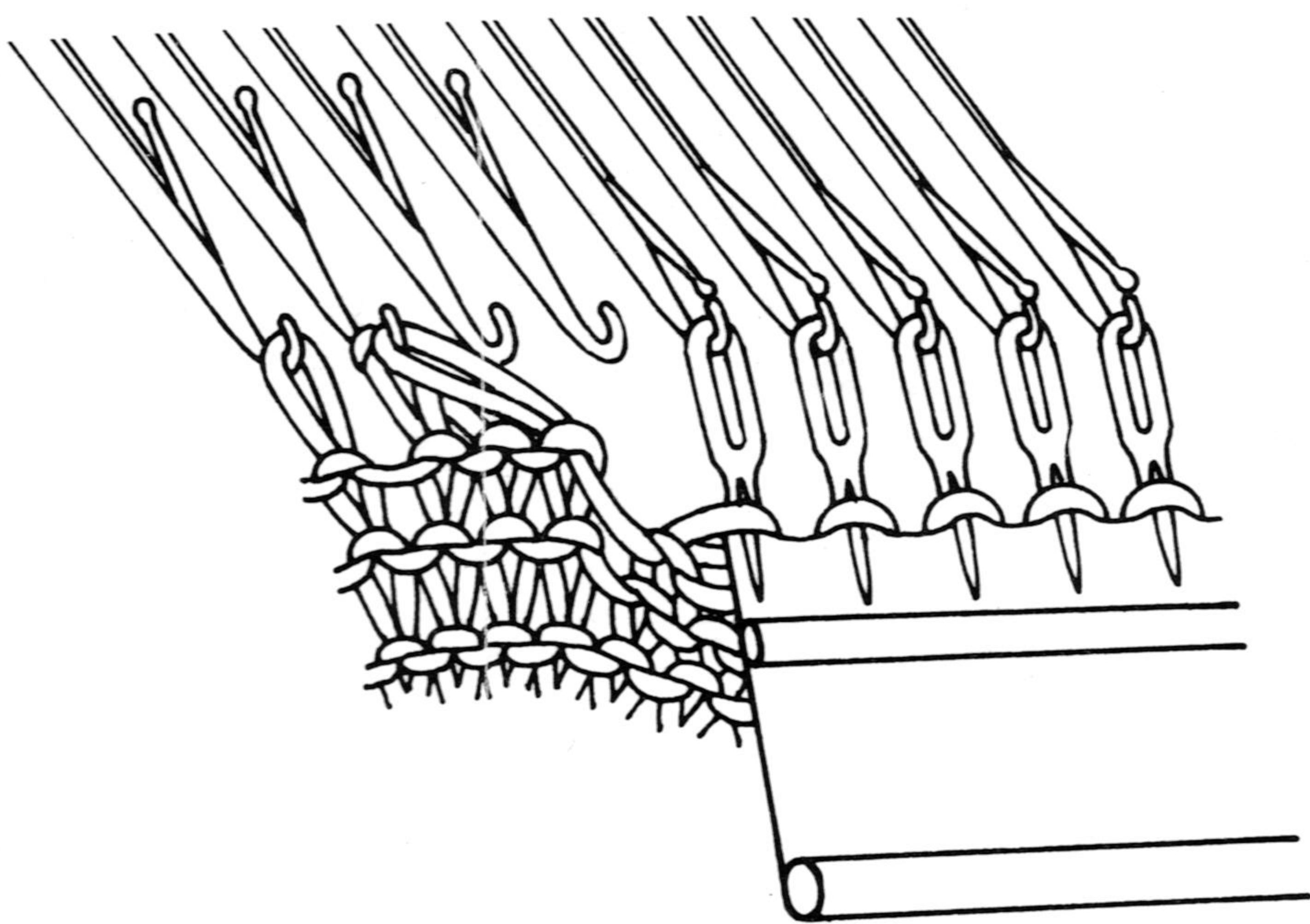

- d) After that, slide garter bar to the left by two stitches (needles) and transfer each stitch on garter bar to the needles again as per fig. 13.

Fig. 13

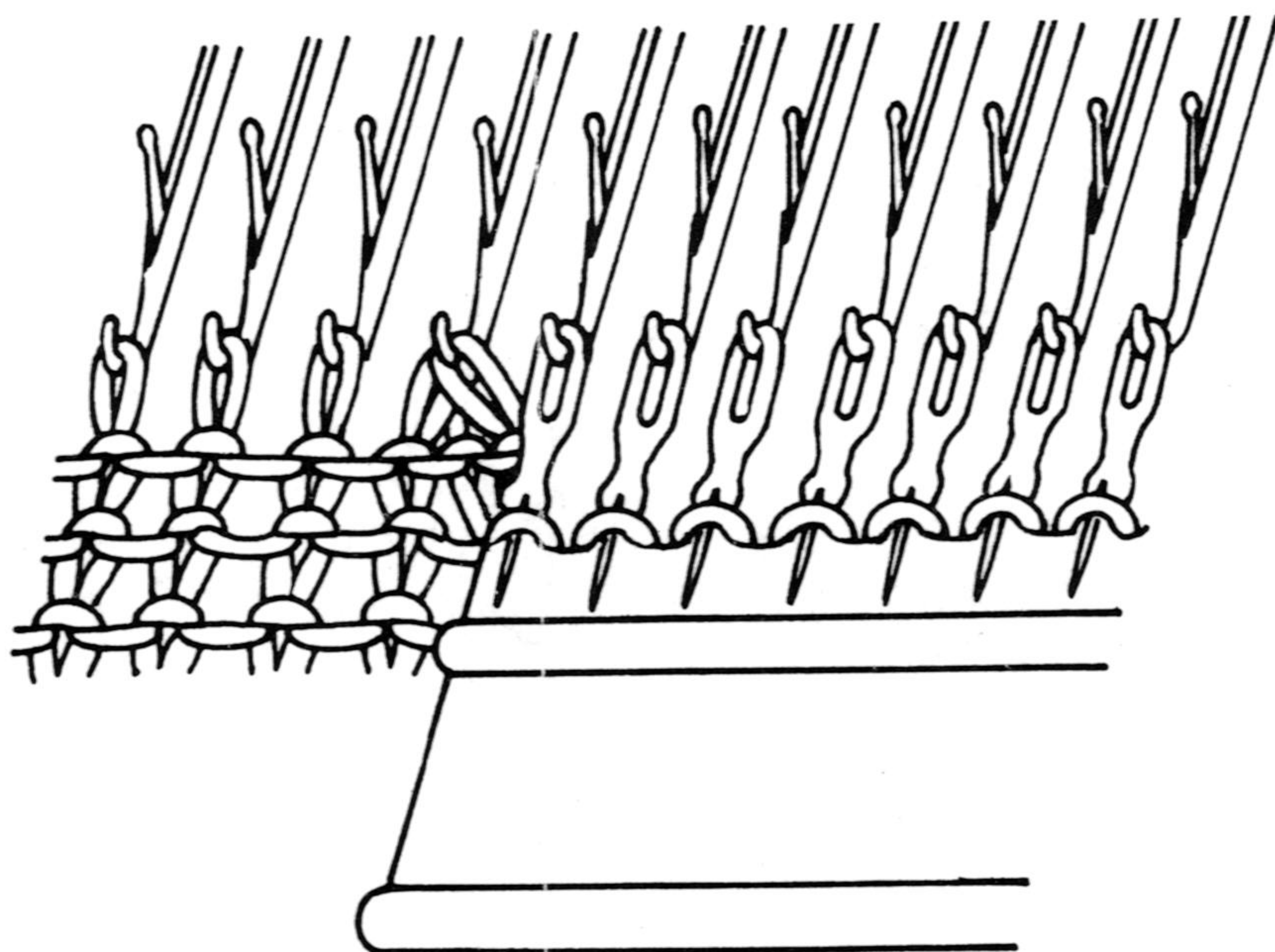

- e) Then, you can gather stitches to the left beautifully.