

Plain, fancy, striped or spotted

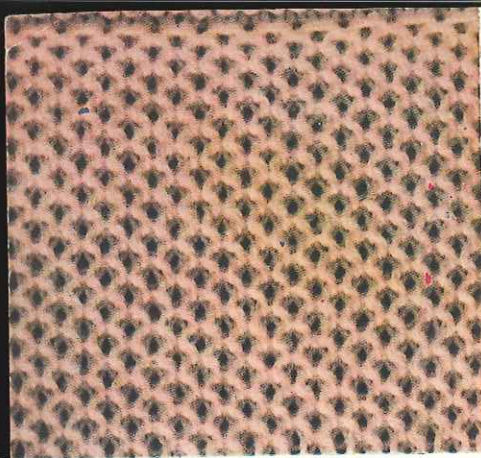

be a *Record* knitter !

The illustrations in this Brochure have been faithfully photographed and show just a few of the wide variety of stitches, patterns and garments produced on the "RECORD" Hand Knitter



"Honeycomb", exclusive to the "Record"

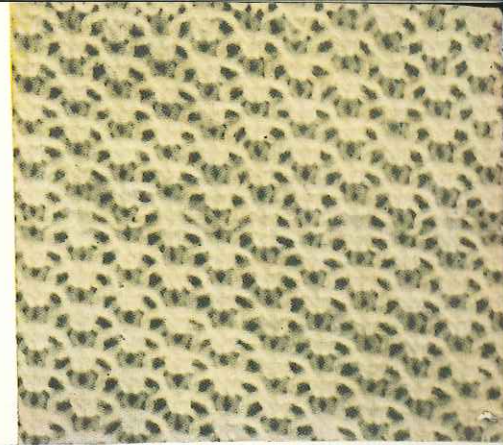

Open-work Shell Stitch, exclusive to the "Record"



"Cable"

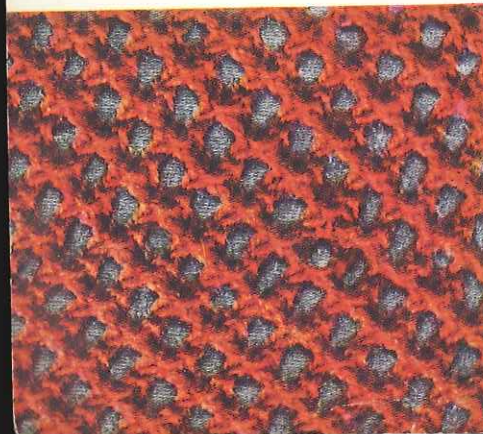

"Trellis"

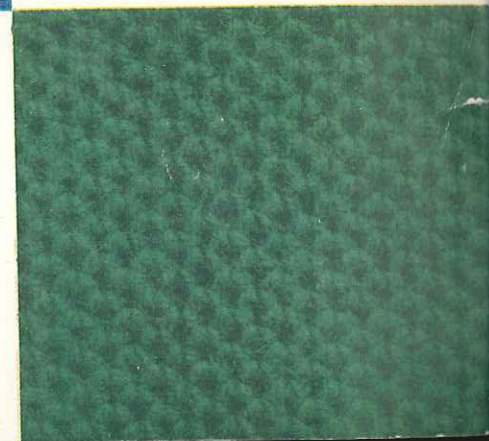

"Mulberry"

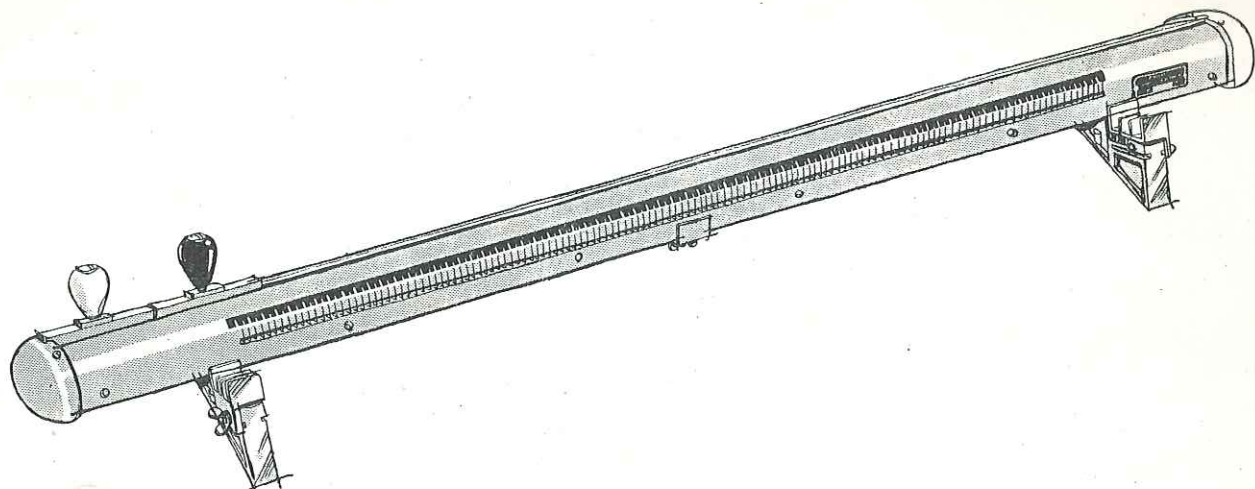

The *Record* Knitting Machine

THE FAMILY KNITTER FOR THE FAMILY WHO KNIT

The only home knitter of its class—it produces both stocking and garter stitch, thus permitting the greatest variation of pattern design. It is easy to learn to operate the “Record”; just move the sliders from one side to the other and 140 stitches are made—in fact a child can do it—and operation is very many times faster than hand knitting, whilst pattern work, casting on and off are equally speedy and simple. All users confirm that the “Record” effects a considerable saving of wool, in many instances up to 30%. Perfection of work is assured by the absolute uniformity of the knitting tension, which is variable to suit individual requirements and the type of garment to be knitted. Due to its unique needle bed construction garments can be made up to a chest measurement of 55 inches.

“Record” users record knitting Perfection in record time.

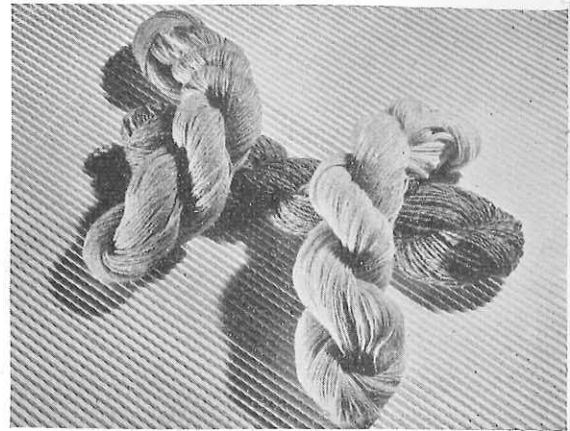
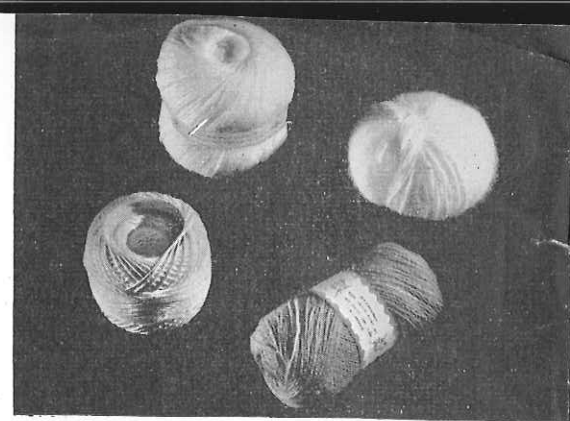

*Our Knitting Advisory Service
is always at your disposal.*

140 stitches.....in a moment

When knitting garments for yourself or for the family, speed is necessarily important, but it should never take the place of perfection. The beauty of the "Record" Hand Knitting Machine is that it does "hand-knitting"—in other words, it knits **all** garments, etc., exactly as the most highly skilled hand knitter would produce them. As proof of this, it is possible, at any time, to take the work off the "Record" on to your needles, knit by hand, and then replace the knitting on the "Record."

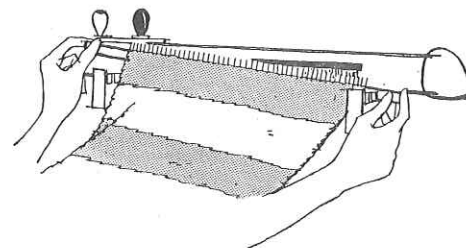

Knitting can easily be taken off the "Record" and transferred to needles and vice versa.

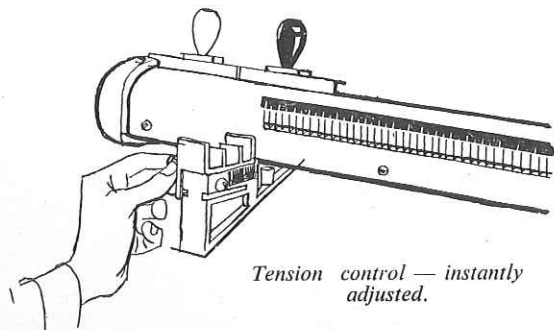

Tension control — instantly adjusted.

The "Record" needle bed is designed to knit garments of all sizes, so that in many cases several parts of a garment, such as front and sleeves, can be knitted in one operation.

As the "Record" Hand Knitting Machine does both stocking stitch and garter

RIBBED YOKE

EXCLUSIVE "RECORD"
LATTICE STITCH
PANELS

GARTER STITCH

RIBBED WAIST BAND



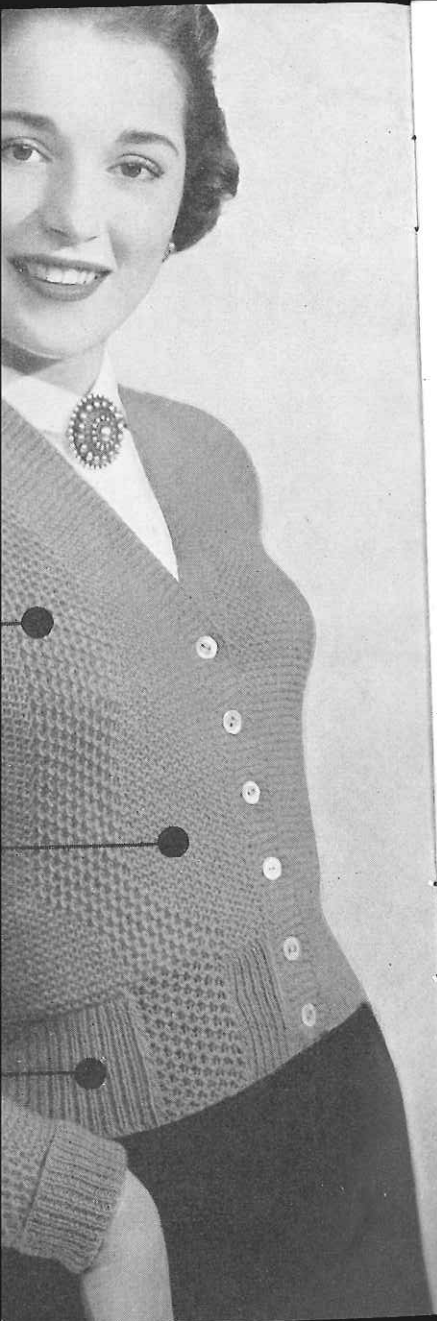

stitch, it is possible to produce almost any type or pattern of knitwear (as illustrated opposite page), including ribs, horizontal and diagonal stripes, cable, plaited or tucked effects, Fair Isle, and many other fascinating stitches exclusive to this machine, in the widest range of textures and with any type of yarn—2, 3 or 4-ply hand knitting wool, Baby Wool, Shetland or Angora Wool, Crochet Yarns, Double Knitting Wools, etc. Finished “Record” knitting looks exactly like hand knitting expertly done, because there is not the slightest variation of tension; therefore socks, jumpers, kiddies’ wear, underwear or any other garments fit perfectly and wear far longer than those factory-made. The “Record” Hand

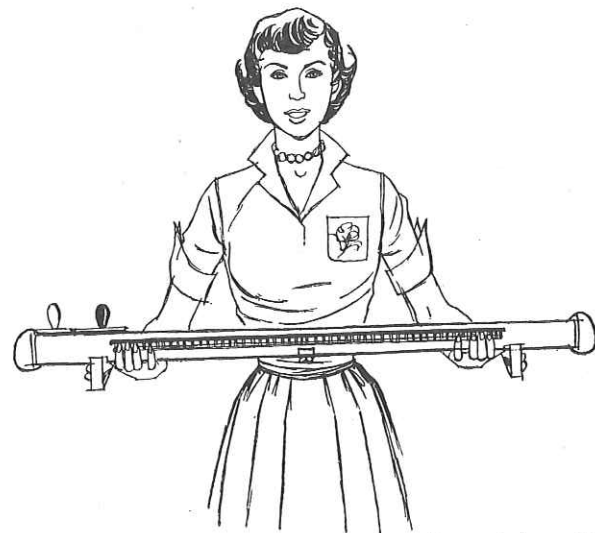

The “Record” weighs only 9½ lbs.—easily carried—easily stored away.

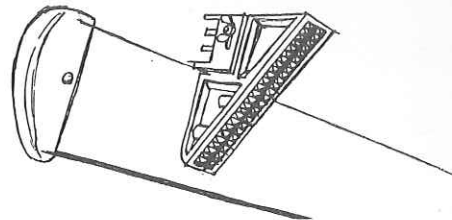

Fitted with rubber feet which cannot slip, or damage the most highly polished table top.

Knitting Machine will, therefore, in any family, save its cost over and over again, for anything that can be done by the hand-knitting expert in the way of knitwear can be done equally well by the novice with a little practice on the “Record” Hand Knitting Machine.

The “Record” Hand Knitting Machine is light, portable and needs **no clamps or weights** to secure it to the table, and it is fitted with rubber feet so as not to damage the most highly polished table top.

Knitting for E



The "Record" Hand Knitting Machine is not only the simplest machine to use, it is also extremely light in operation, with finger-tip control, and easy manipulation for the most intricate stitches and patterns. The "Record" produces perfect and absolutely clean work, and therefore the garment does not necessarily need washing before use.

The fascinating evening jumper shown here in an open-work shell stitch is an example of one of the "Record's" exclusive designs and can easily be made in an evening.

Knitting for Everywear

Record" Hand Knitting
is not only the simplest
to use, it is also extremely
operation, with finger-tip
and easy manipulation
most intricate stitches and
. The "Record"
is perfect and absolutely
work, and therefore the
does not necessarily
shing before use.

*minating evening jumper
ere in an open-work shell
an example of one of the
's" exclusive designs and
ly be made in an evening.*

With the "Record" any knitting
can be unpicked in precisely the
same manner as with hand-
knitting, and the yarn re-knitted
to make any other garment.
The stitch tension of the
"Record" is always under the
control of the operator, and
shaping, reducing and increasing
are simplicity itself, as also is the
change of stitch, colour or pattern.

*In the classical style jumper
shown here, you can see how even
stocking stitch becomes
distinctive when knitted on the
"Record" Machine.*



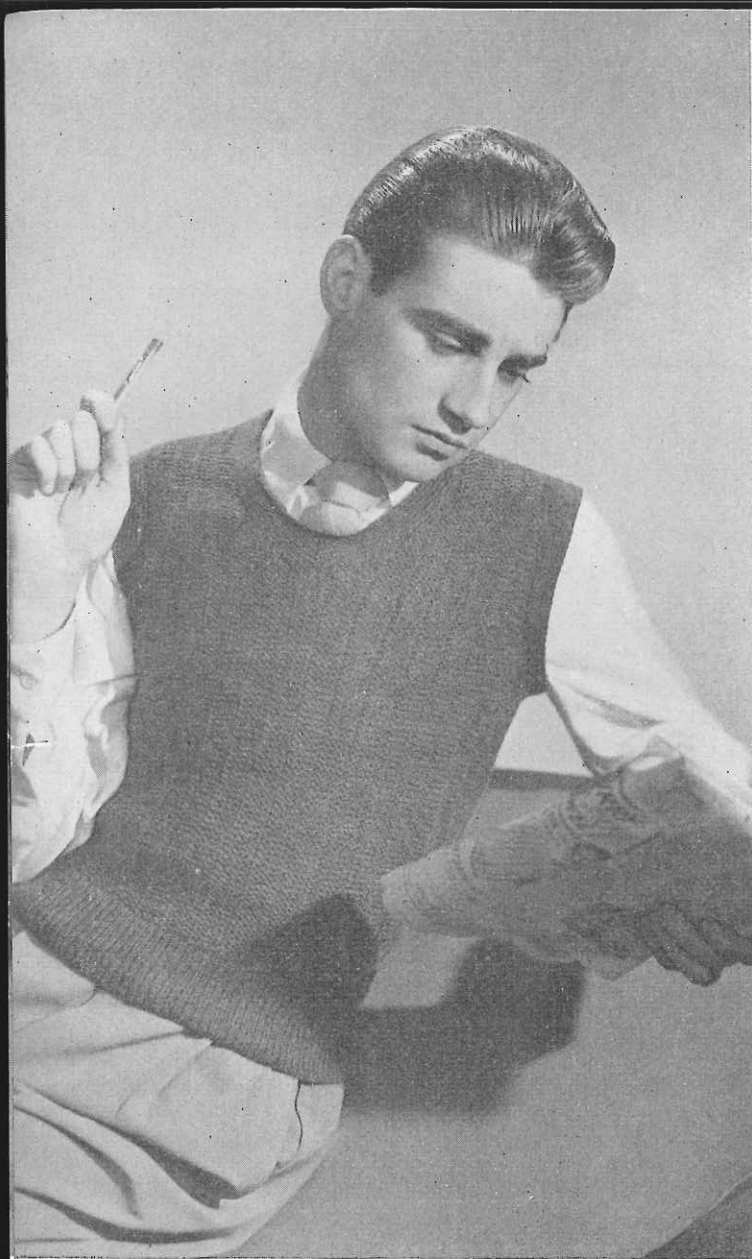

For the man who stays at Home

The Victorian father loved, when the day's work was done, to don his smoking jacket and relax serenely by the family fireside—formal perhaps, but it was his idea of ease. To-day, the Elizabethan husband—who naturally would spurn the smoking jacket of his grandfather—simply adores the care-free comfort of the light-weight pullover. Perhaps at this very moment he is waiting for you to knit him one, but you haven't the heart to start—it takes too long—stitch by stitch—by hand.

But the "Record" Hand Knitting Machine would enable you to knit such a pullover—as illustrated here—in a few quiet evenings, or hubby could do it himself instead of having to interpret for example, "P.2 tog., p. 1, k. 3." etc.

the man stays Home

erian father loved, when the day's
done, to don his smoking jacket
serenely by the family fireside—
perhaps, but it was his idea of ease.
he Elizabethan husband—
rally would spurn the smoking
his grandfather—simply adores
ree comfort of the light-
llover. Perhaps at this very
he is waiting for you to knit him
you haven't the heart to start—
so long—stitch by stitch—by hand.
“Record” Hand Knitting
would enable you to knit such
—as illustrated here—in a
evenings, or hubby could do
instead of having to interpret
le, “P.2 tog., p. 1, k. 3.” etc.

A *Record* round

Ah! now here's the pullover for the
outdoors man—masculine in every
sense of the term—gay, warm, snug
and comfortable—a lovely pattern—
a double-texture rib—just what he
would like for the Links. “But it
would take me months to knit,” you
may say. Not a bit of it—a day or
two perhaps if you get the help of
the new hand knitting machine, the
“Record.” And to knit such a
beautiful pullover on the “Record” would
not tire you in any way, and it would be
perfect, for the “Record” knits exactly
like the most expert hand-knitting.





For children

This is where the knit-happy fortunate sisters—she is able warmly and save herself more is always in need of innumerable set, perhaps a dress or romper set, or even a dress. Your cardigan or long school scarf. You too can knit and save your compared with shillings, with colours or mixtures of colours—any garments—for those who most certainly manipulate the finger-tip operation—a delightful home-occupation, not for a

For children of all ages

This is where the knit-happy mother has a great advantage over her less fortunate sisters—she is able to knit for her family—dress them well and warmly and save herself money at the same time. Baby, for instance, is always in need of innumerable woollies—vests, matinee jackets, a pram set, perhaps a dress or romper suit. Your little girl a jumper or twin set, or even a dress. Your schoolboy son such knitwear as a pullover, cardigan or long school scarf.

You too can knit and save very much more money—real money, pounds compared with shillings, with the “Record” Hand Knitting Machine—any colours or mixtures of colours—any designs or patterns, even Fair Isle—any garments—for those who can read simple knitting instructions can most certainly manipulate the “Record” with its easy-running, finger-tip operation—a delight to own—a source of profitable home-occupation, not for a day or a year, but for a lifetime.

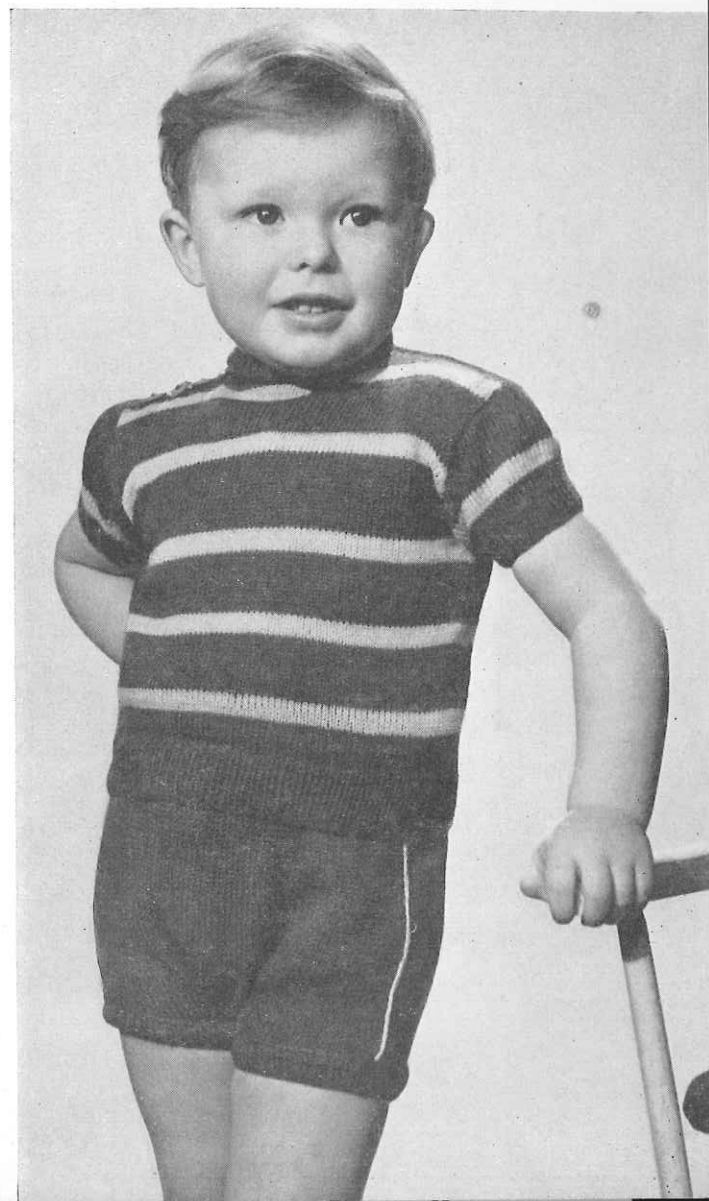



Those odds + ends

If you have for years been dissatisfied with shop-purchased underwear, etc., here then is your opportunity to knit your own in either wool, cotton or silk—soft—body-clinging—perfect fitting—just your length and size—fully-fashioned if you like—and of far better quality than anything you can buy to-day ready-made. Then there are winter socks for hubby, school stockings for the kiddies, bathing costumes, and a hundred-and-one odds and ends that will keep the “Record” busy most weeks throughout the year and make its purchase a most profitable investment.

Those odds & ends

If you have for years been dissatisfied with shop-purchased underwear, etc., here then is your opportunity to knit your own in either wool, cotton or silk—soft—body-clinging—perfect fitting—just your length and size—fully-fashioned if you like—and of far better quality than anything you can buy to-day ready-made. Then there are winter socks for hubby, school stockings for the kiddies, bathing costumes, and a hundred-and-one odds and ends that will keep the "Record" busy most weeks throughout the year and make its purchase a most profitable investment.

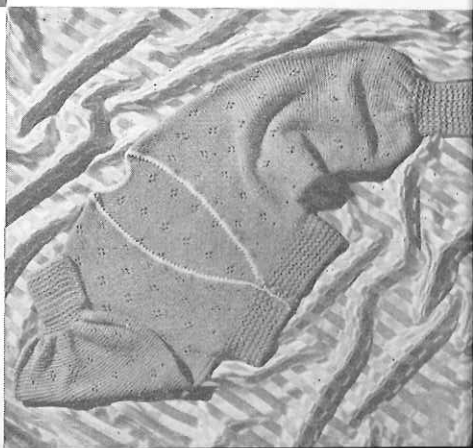
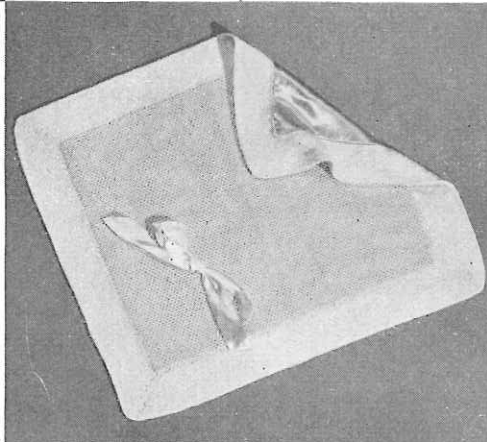
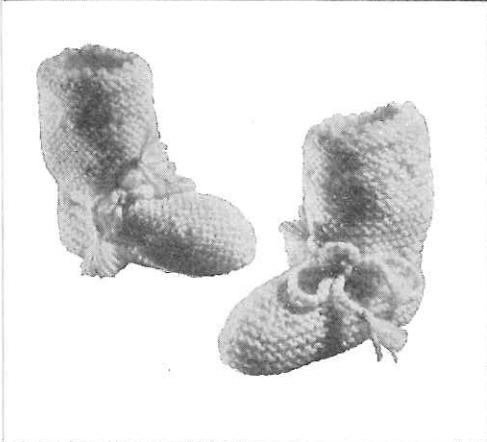
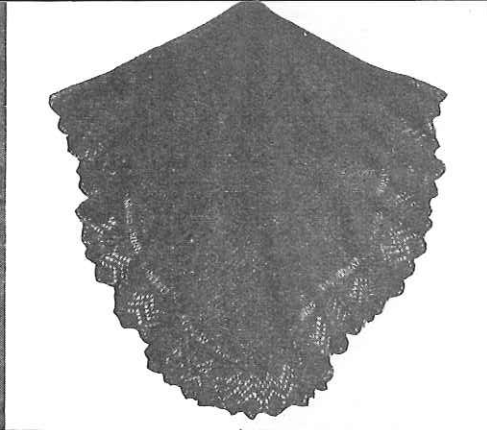
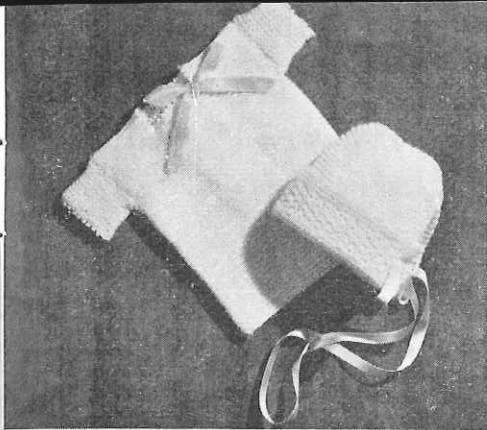



Who use the *Record*

THE HOUSEWIFE, her husband and family for knitting everything they need in the way of knit wear. THE DISABLED, the invalid and those recovering from illness, for knitting on the "Record" soothes and occupies the mind, and brings into play certain finger and arm muscles; therefore, the "Record" Hand Knitting Machine is often to be found in hospitals and occupational therapy centres.



no
e
e
Record



The use of knitting needle pins throughout the "Record" is one of its unique features, as it is the best method of producing perfect **hand** knitting, as distinct from latch needles used in other machines. Furthermore, latch needles will only function with either the use of heavy weights, (which apart from being cumbersome, distort and stretch the work considerably), or complicated mechanism—either way, latch needles do not knit garter stitch.

Because the "Record" Hand Knitting Machine always produces such perfect work so speedily, many people find that the home-knitting of Cardigans, Jumpers, Pullovers, Scarves, Underwear, Socks, etc., can become a most profitable pastime. Many enterprising ladies—by arrangement with departmental stores or their local woolshop—display a "Record" knitted garment in the window or on the counter, and this causes such interest and comment that a great many orders are taken. In this way, and in many others, a profitable knitting connection can be built up which opens up an avenue to considerable extra income, for home-knitted garments which look in every way hand-knitted will always be in demand.





Patterns for the *Record*

The "Record" Pattern Book is the most comprehensive of its kind ever produced, and is available to everyone who owns a "Record" Hand Knitting Machine. The instructions contained in it are very easy to follow, and anyone with a little knowledge of knitting can work from ordinary Hand-knitting Leaflets, or create original designs of their very own.

Patterns for the *Record*

"Record" Pattern Book is the most comprehensive of its kind ever produced, and is available to anyone who owns a "Record" Knitting Machine. The instructions contained in it are easy to follow, and anyone with a little knowledge of knitting can work from ordinary Handing Leaflets, or create original patterns of their very own.

How to use the *Record*

It would be unfair to send out such a beautiful, streamlined machine as the "Record" without giving full instructions regarding its use and maintenance. These are simplicity itself, and there is nothing to go wrong with the machine and no attention is needed except an occasional drop of oil. If, however, any mechanical fault develops or any repairs are necessary, these are executed free during the period of the guarantee, and at nominal charges afterwards, service being at all times speedy and efficient.

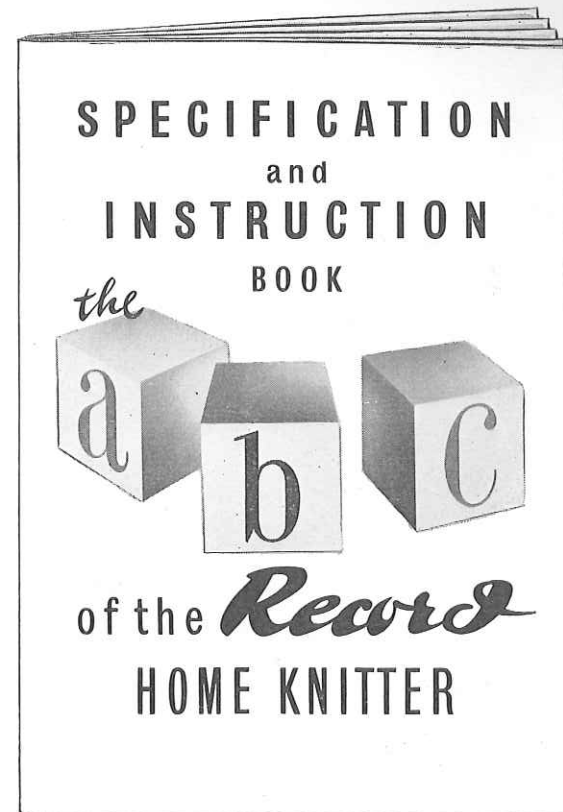

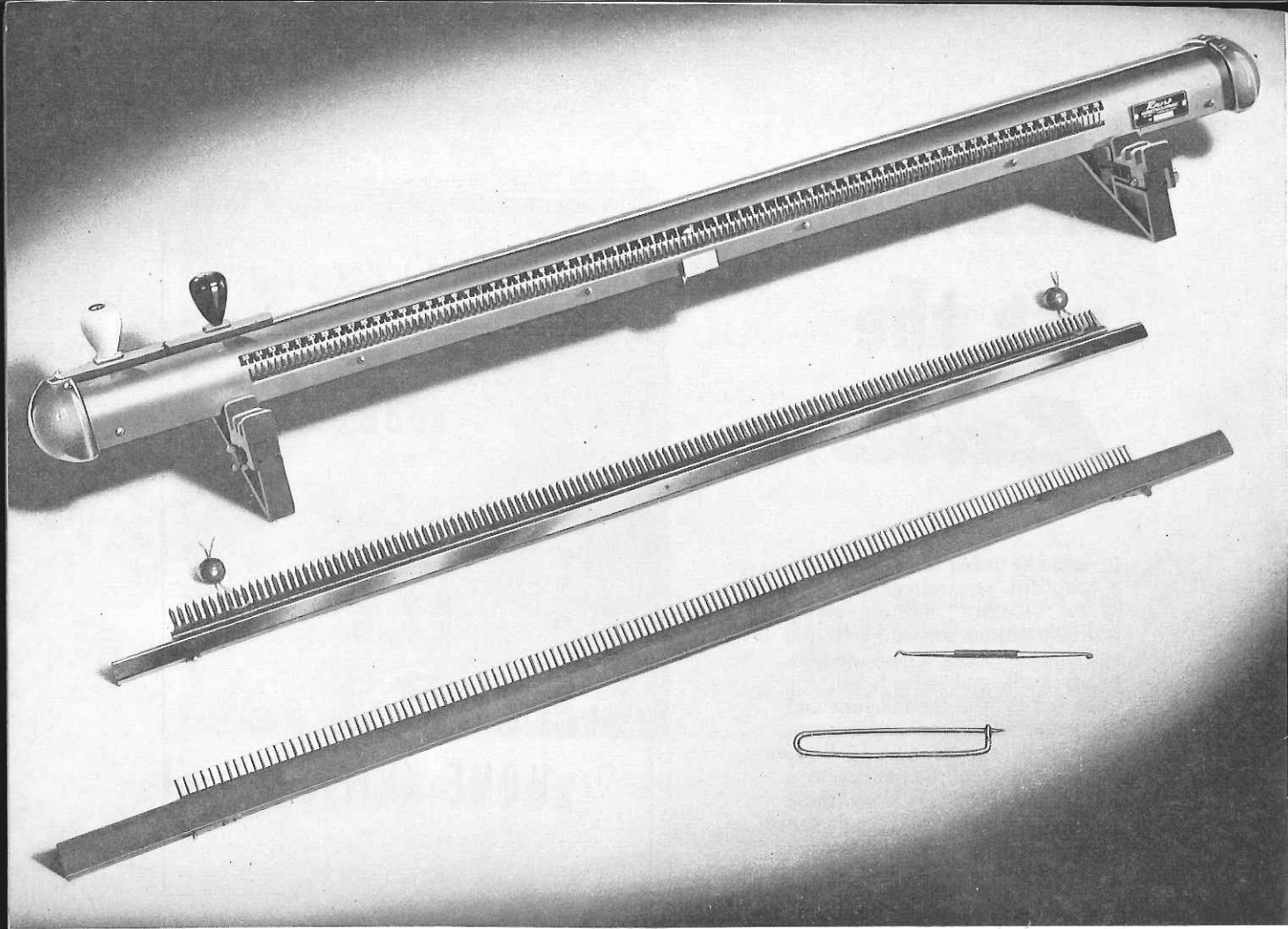

Record

HAND KNITTING MACHINE
AND ACCESSORIES

- Guarantee -

We, the sole distributors of the "Record" Hand Knitting Machine, hereby guarantee our machines to be precision-built from the finest possible materials, made and assembled by experienced craftsmen. Each machine, before leaving our factory, is thoroughly examined and tested, and should give a life-time's knitting service.

During the 12 months following the date of purchase, should any part of the machine fail through defective materials or workmanship, we guarantee to replace said faulty part absolutely free of charge, providing the seal affixed to the machine is not tampered with or broken. Parts requiring replacement due to mis-use or accident can be obtained and fitted from our Service Department at nominal charges.

"RECORD" HAND KNITTING MACHINES

172, Dartmouth Road, London, S.E.26

'Phone: Forest Hill 1128

SHOWROOMS:

6-7, Russell Gardens, Holland Road, Kensington, W.14

'Phone: Park 5501

Specification

Precision made, all metal, streamlined appearance, neat and compact. Totally enclosed mechanism, weight 9½ lbs. Easily carried—easily stored away.

ACCESSORIES:

Every "Record" Hand Knitting Machine is supplied with Garter Stitch Comb, Stocking Stitch Comb, Double-ended Hand Hook, Stitch Holder, Comprehensive Instruction Book and beautifully illustrated Pattern Book.

PRICE

£24 nett, inclusive of packing and carriage. "RECORD" TERMS TO SUIT EVERY POCKET. If you prefer to "knit as you pay," you may take advantage of our helpful terms—£9 deposit, or **PAY WHAT YOU LIKE** and a machine will be reserved for you and sent as soon as £9 has been paid, and then 12 monthly payments of 30/- (only 7/6 per week) commencing one month after delivery.

"Record" policy is one of continuous improvement and the right to change specifications and equipment at any time without notice is reserved.

"RECORD" HAND KNITTING MACHINES

Prop.: M. CALLAWAY (H.R.) LTD. Directors: L. Kaye, H. H. Harrison

172 Dartmouth Road, London, S.E.26.

'Phone: Forest Hill 1128.

Continuous daily demonstrations at our

SHOWROOMS: 6-7, Russell Gardens, Holland Road, Kensington, W.14

'Phone: Park 5501

**Please note that after October 9th, our Showrooms
are being removed to:- 9, Melcombe Street, N.W.1
(20 yards from Baker Street Station)**

Increasing or decreasing is simple on the "Record"; so is change of stitch, colour or pattern



"Dew-drops"

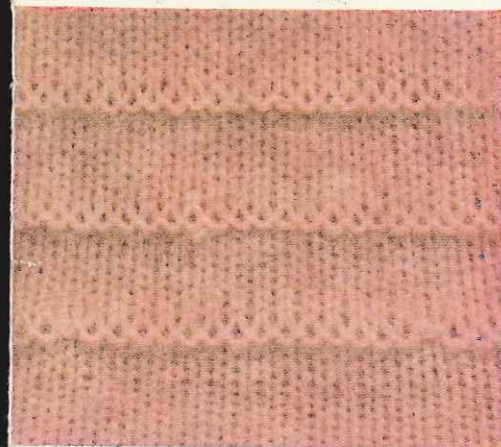

Horizontal Rib

Double texture rib

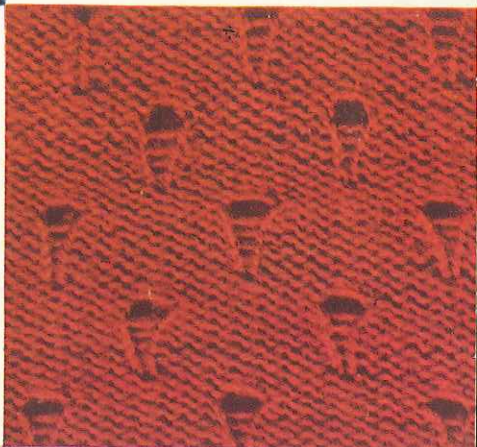

Basket stitch in two colours



They all come
easy on a



The *Record* creates

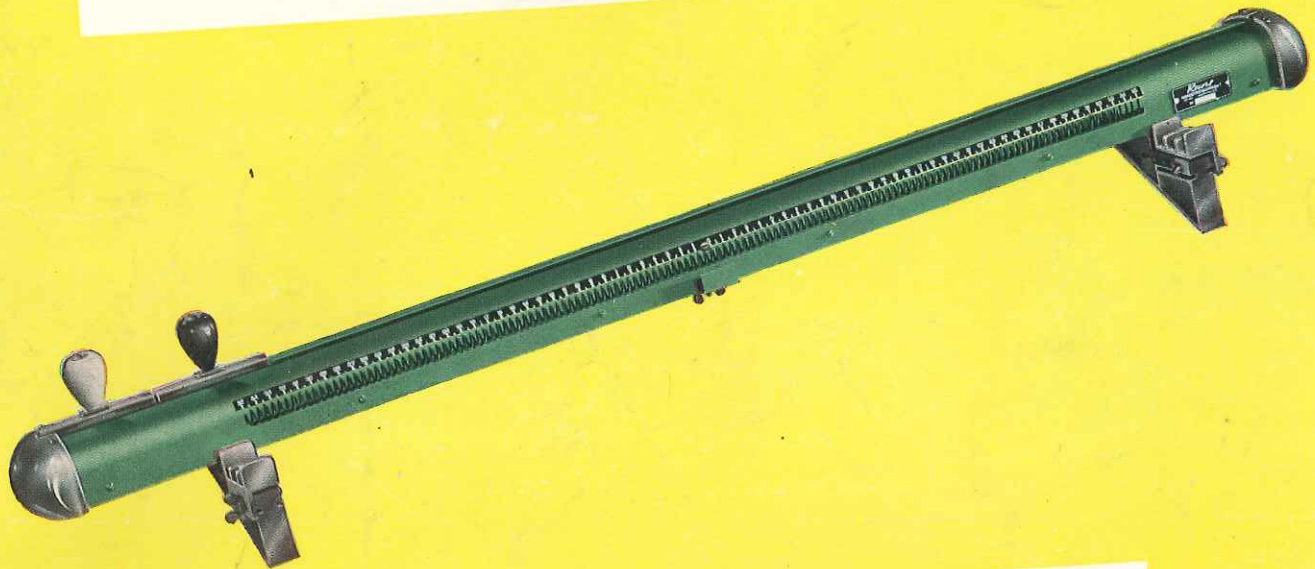

knitting **RECORDS**